



wwPDB X-ray Structure Validation Summary Report ⓘ

May 16, 2020 – 10:45 pm BST

PDB ID : 4A0L
Title : Structure of DDB1-DDB2-CUL4B-RBX1 bound to a 12 bp abasic site containing DNA-duplex
Authors : Fischer, E.S.; Scrima, A.; Gut, H.; Thoma, N.H.
Deposited on : 2011-09-09
Resolution : 7.40 Å(reported)

This is a wwPDB X-ray Structure Validation Summary Report for a publicly released PDB entry.

We welcome your comments at validation@mail.wwpdb.org

A user guide is available at

<https://www.wwpdb.org/validation/2017/XrayValidationReportHelp>

with specific help available everywhere you see the ⓘ symbol.

The following versions of software and data (see [references ⓘ](#)) were used in the production of this report:

MolProbity : 4.02b-467
Mogul : 1.8.5 (274361), CSD as541be (2020)
Xtriage (Phenix) : 1.13
EDS : 2.11
Percentile statistics : 20191225.v01 (using entries in the PDB archive December 25th 2019)
Refmac : 5.8.0158
CCP4 : 7.0.044 (Gargrove)
Ideal geometry (proteins) : Engh & Huber (2001)
Ideal geometry (DNA, RNA) : Parkinson et al. (1996)
Validation Pipeline (wwPDB-VP) : 2.11

1 Overall quality at a glance

The following experimental techniques were used to determine the structure:

X-RAY DIFFRACTION

The reported resolution of this entry is 7.40 Å.

Percentile scores (ranging between 0-100) for global validation metrics of the entry are shown in the following graphic. The table shows the number of entries on which the scores are based.

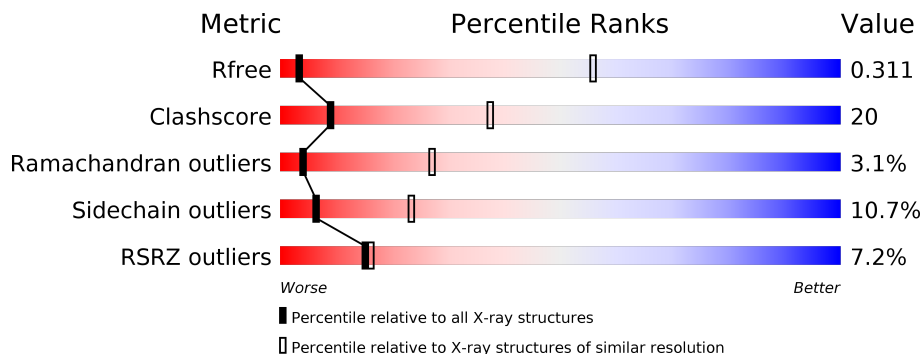

Metric	Whole archive (#Entries)	Similar resolution (#Entries, resolution range(Å))
R_{free}	130704	1004 (10.00-3.90)
Clashscore	141614	1069 (10.00-3.90)
Ramachandran outliers	138981	1002 (10.00-3.90)
Sidechain outliers	138945	1002 (10.00-3.86)
RSRZ outliers	127900	1004 (9.50-3.80)

The table below summarises the geometric issues observed across the polymeric chains and their fit to the electron density. The red, orange, yellow and green segments on the lower bar indicate the fraction of residues that contain outliers for ≥ 3 , 2, 1 and 0 types of geometric quality criteria respectively. A grey segment represents the fraction of residues that are not modelled. The numeric value for each fraction is indicated below the corresponding segment, with a dot representing fractions $\leq 5\%$. The upper red bar (where present) indicates the fraction of residues that have poor fit to the electron density. The numeric value is given above the bar.

Mol	Chain	Length	Quality of chain
1	A	1144	
1	C	1144	
2	B	382	
2	D	382	
3	E	726	
3	H	726	

Continued on next page...

Continued from previous page...

Mol	Chain	Length	Quality of chain
4	F	98	
4	I	98	
5	R	12	
5	T	12	
6	S	12	
6	U	12	

The following table lists non-polymeric compounds, carbohydrate monomers and non-standard residues in protein, DNA, RNA chains that are outliers for geometric or electron-density-fit criteria:

Mol	Type	Chain	Res	Chirality	Geometry	Clashes	Electron density
5	3DR	T	9	-	-	-	X

2 Entry composition i

There are 6 unique types of molecules in this entry. The entry contains 35553 atoms, of which 0 are hydrogens and 0 are deuteriums.

In the tables below, the ZeroOcc column contains the number of atoms modelled with zero occupancy, the AltConf column contains the number of residues with at least one atom in alternate conformation and the Trace column contains the number of residues modelled with at most 2 atoms.

- Molecule 1 is a protein called DNA DAMAGE-BINDING PROTEIN 1.

Mol	Chain	Residues	Atoms					ZeroOcc	AltConf	Trace
			Total	C	N	O	S			
1	A	1105	Total	C	N	O	S	0	0	0
			8517	5403	1417	1652	45			
1	C	1105	Total	C	N	O	S	0	0	0
			8537	5409	1428	1655	45			

There are 8 discrepancies between the modelled and reference sequences:

Chain	Residue	Modelled	Actual	Comment	Reference
A	-3	GLY	-	expression tag	UNP Q16531
A	-2	GLY	-	expression tag	UNP Q16531
A	-1	GLY	-	expression tag	UNP Q16531
A	0	ARG	-	expression tag	UNP Q16531
C	-3	GLY	-	expression tag	UNP Q16531
C	-2	GLY	-	expression tag	UNP Q16531
C	-1	GLY	-	expression tag	UNP Q16531
C	0	ARG	-	expression tag	UNP Q16531

- Molecule 2 is a protein called DNA DAMAGE-BINDING PROTEIN 2.

Mol	Chain	Residues	Atoms					ZeroOcc	AltConf	Trace
			Total	C	N	O	S			
2	B	355	Total	C	N	O	S	0	0	0
			2819	1792	492	524	11			
2	D	355	Total	C	N	O	S	0	0	0
			2843	1806	499	527	11			

There are 40 discrepancies between the modelled and reference sequences:

Chain	Residue	Modelled	Actual	Comment	Reference
B	76	MET	-	expression tag	UNP Q2YDS1
B	77	HIS	-	expression tag	UNP Q2YDS1
B	78	HIS	-	expression tag	UNP Q2YDS1
B	79	HIS	-	expression tag	UNP Q2YDS1

Continued on next page...

Continued from previous page...

Chain	Residue	Modelled	Actual	Comment	Reference
B	80	HIS	-	expression tag	UNP Q2YDS1
B	81	HIS	-	expression tag	UNP Q2YDS1
B	82	HIS	-	expression tag	UNP Q2YDS1
B	83	ARG	-	expression tag	UNP Q2YDS1
B	84	ARG	-	expression tag	UNP Q2YDS1
B	85	LEU	-	expression tag	UNP Q2YDS1
B	86	VAL	-	expression tag	UNP Q2YDS1
B	87	PRO	-	expression tag	UNP Q2YDS1
B	88	ARG	-	expression tag	UNP Q2YDS1
B	89	GLY	-	expression tag	UNP Q2YDS1
B	90	SER	-	expression tag	UNP Q2YDS1
B	91	GLY	-	expression tag	UNP Q2YDS1
B	92	GLY	-	expression tag	UNP Q2YDS1
B	93	ARG	-	expression tag	UNP Q2YDS1
B	180	GLN	LEU	variant	UNP Q2YDS1
B	214	ARG	TRP	variant	UNP Q2YDS1
D	76	MET	-	expression tag	UNP Q2YDS1
D	77	HIS	-	expression tag	UNP Q2YDS1
D	78	HIS	-	expression tag	UNP Q2YDS1
D	79	HIS	-	expression tag	UNP Q2YDS1
D	80	HIS	-	expression tag	UNP Q2YDS1
D	81	HIS	-	expression tag	UNP Q2YDS1
D	82	HIS	-	expression tag	UNP Q2YDS1
D	83	ARG	-	expression tag	UNP Q2YDS1
D	84	ARG	-	expression tag	UNP Q2YDS1
D	85	LEU	-	expression tag	UNP Q2YDS1
D	86	VAL	-	expression tag	UNP Q2YDS1
D	87	PRO	-	expression tag	UNP Q2YDS1
D	88	ARG	-	expression tag	UNP Q2YDS1
D	89	GLY	-	expression tag	UNP Q2YDS1
D	90	SER	-	expression tag	UNP Q2YDS1
D	91	GLY	-	expression tag	UNP Q2YDS1
D	92	GLY	-	expression tag	UNP Q2YDS1
D	93	ARG	-	expression tag	UNP Q2YDS1
D	180	GLN	LEU	variant	UNP Q2YDS1
D	214	ARG	TRP	variant	UNP Q2YDS1

- Molecule 3 is a protein called CULLIN-4B.

Mol	Chain	Residues	Atoms					ZeroOcc	AltConf	Trace
			Total	C	N	O	S			
3	E	709	5743	3659	979	1074	31	0	0	0

Continued on next page...

Continued from previous page...

Mol	Chain	Residues	Atoms					ZeroOcc	AltConf	Trace
			Total	C	N	O	S			
3	H	709	5773	3681	978	1082	32	0	0	0

There are 8 discrepancies between the modelled and reference sequences:

Chain	Residue	Modelled	Actual	Comment	Reference
E	189	GLY	-	expression tag	UNP Q13620
E	190	GLY	-	expression tag	UNP Q13620
E	191	GLY	-	expression tag	UNP Q13620
E	192	ARG	-	expression tag	UNP Q13620
H	189	GLY	-	expression tag	UNP Q13620
H	190	GLY	-	expression tag	UNP Q13620
H	191	GLY	-	expression tag	UNP Q13620
H	192	ARG	-	expression tag	UNP Q13620

- Molecule 4 is a protein called E3 UBIQUITIN-PROTEIN LIGASE RBX1.

Mol	Chain	Residues	Atoms				ZeroOcc	AltConf	Trace
			Total	C	N	O			
4	F	21	175	118	31	26	0	0	0
4	I	21	180	122	32	26	0	0	0

There are 2 discrepancies between the modelled and reference sequences:

Chain	Residue	Modelled	Actual	Comment	Reference
F	11	MET	-	expression tag	UNP P62878
I	11	MET	-	expression tag	UNP P62878

- Molecule 5 is a DNA chain called 12 BP THF CONTAINING DNA DUPLEX.

Mol	Chain	Residues	Atoms					ZeroOcc	AltConf	Trace
			Total	C	N	O	P			
5	R	12	234	111	41	70	12	0	0	0
5	T	12	234	111	41	70	12	0	0	0

- Molecule 6 is a DNA chain called 12 BP DNA DUPLEX.

Mol	Chain	Residues	Atoms					ZeroOcc	AltConf	Trace
			Total	C	N	O	P			
6	S	12	249	118	47	72	12	0	0	0

Continued on next page...

Continued from previous page...

Mol	Chain	Residues	Atoms				ZeroOcc	AltConf	Trace	
			Total	C	N	O				P
6	U	12	249	118	47	72	12	0	0	0

3 Residue-property plots

These plots are drawn for all protein, RNA and DNA chains in the entry. The first graphic for a chain summarises the proportions of the various outlier classes displayed in the second graphic. The second graphic shows the sequence view annotated by issues in geometry and electron density. Residues are color-coded according to the number of geometric quality criteria for which they contain at least one outlier: green = 0, yellow = 1, orange = 2 and red = 3 or more. A red dot above a residue indicates a poor fit to the electron density ($RSRZ > 2$). Stretches of 2 or more consecutive residues without any outlier are shown as a green connector. Residues present in the sample, but not in the model, are shown in grey.

• Molecule 1: DNA DAMAGE-BINDING PROTEIN 1

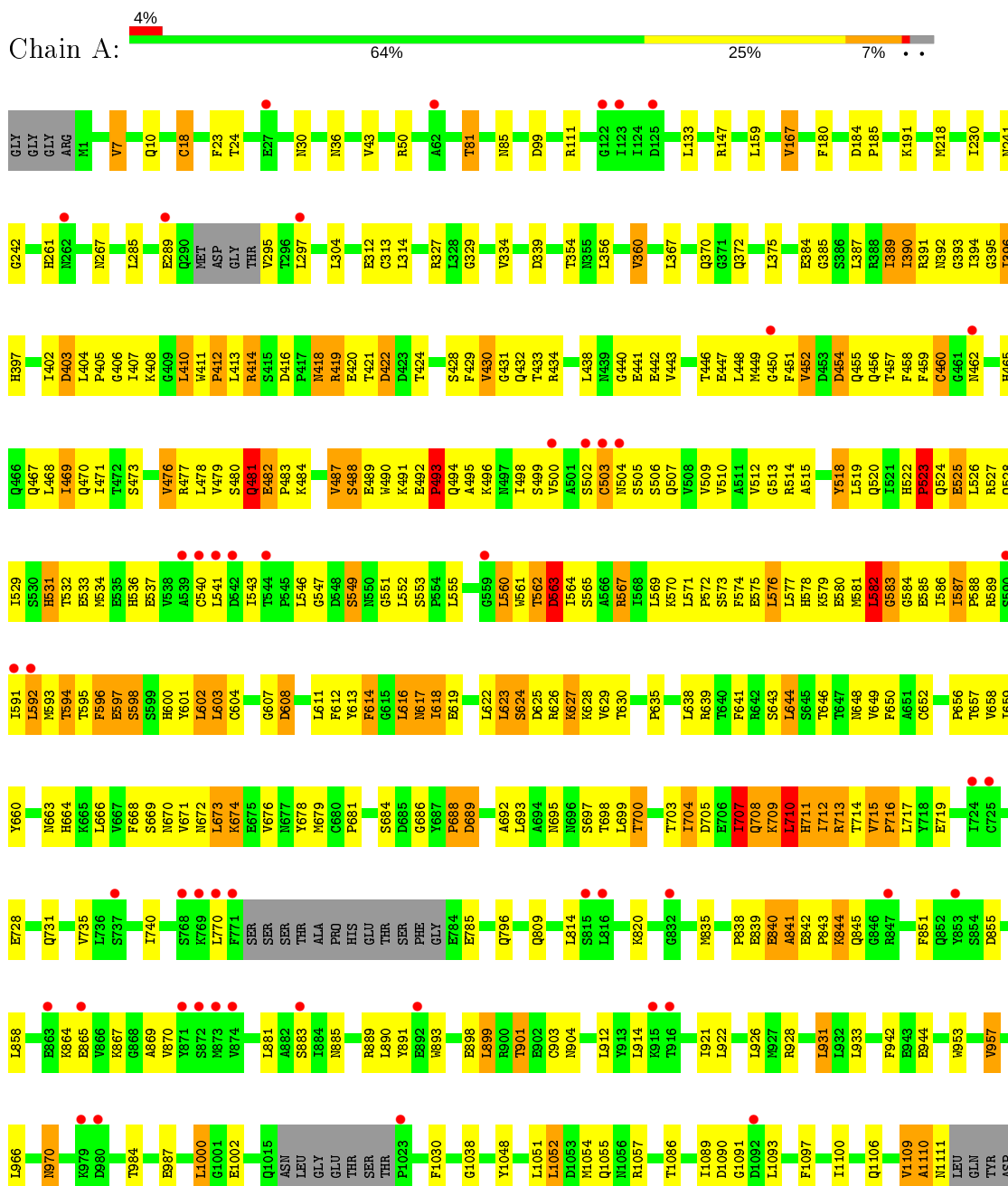

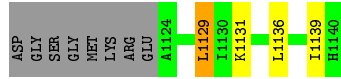

• Molecule 1: DNA DAMAGE-BINDING PROTEIN 1

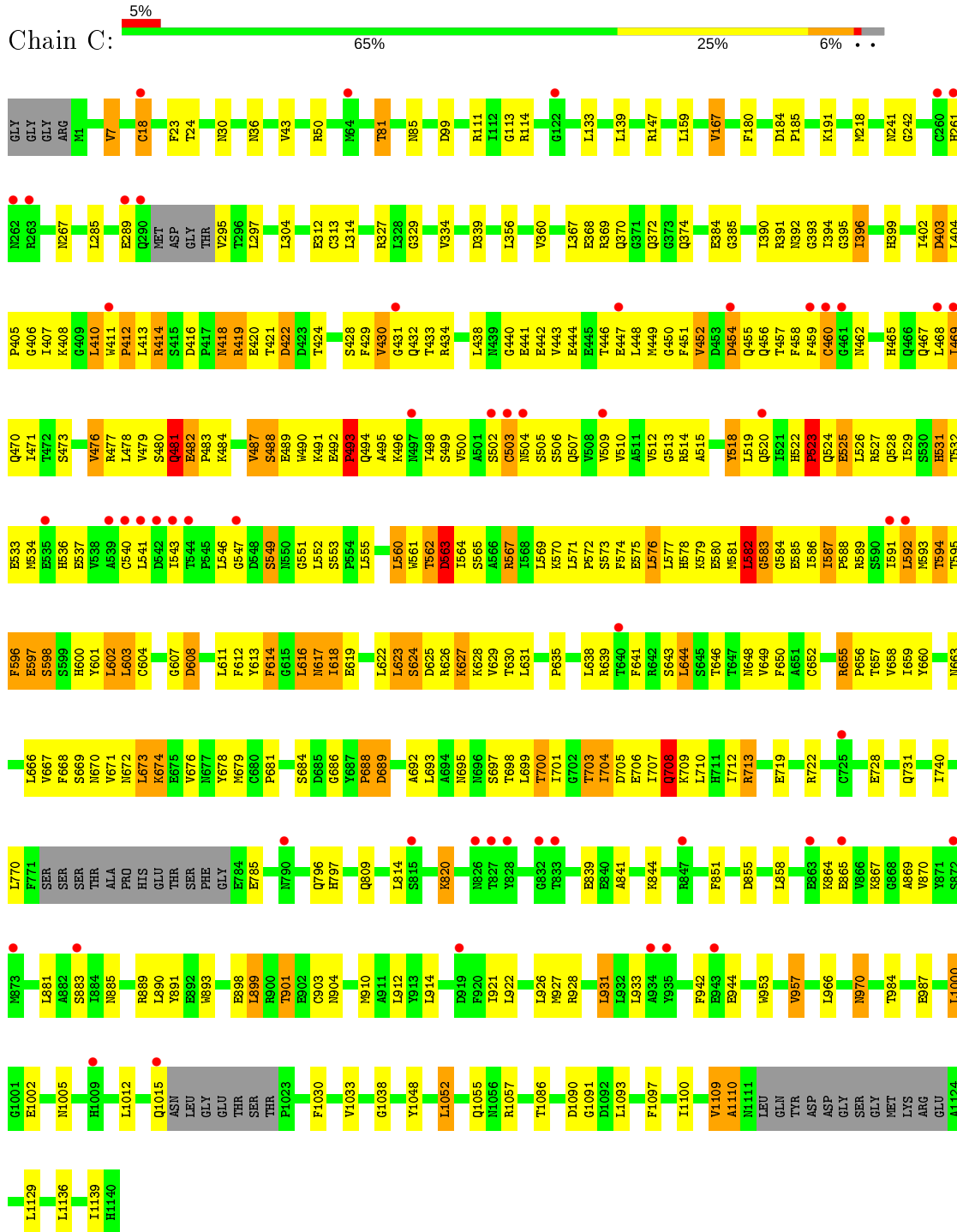

• Molecule 2: DNA DAMAGE-BINDING PROTEIN 2

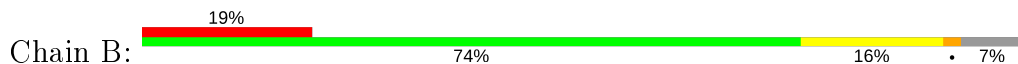

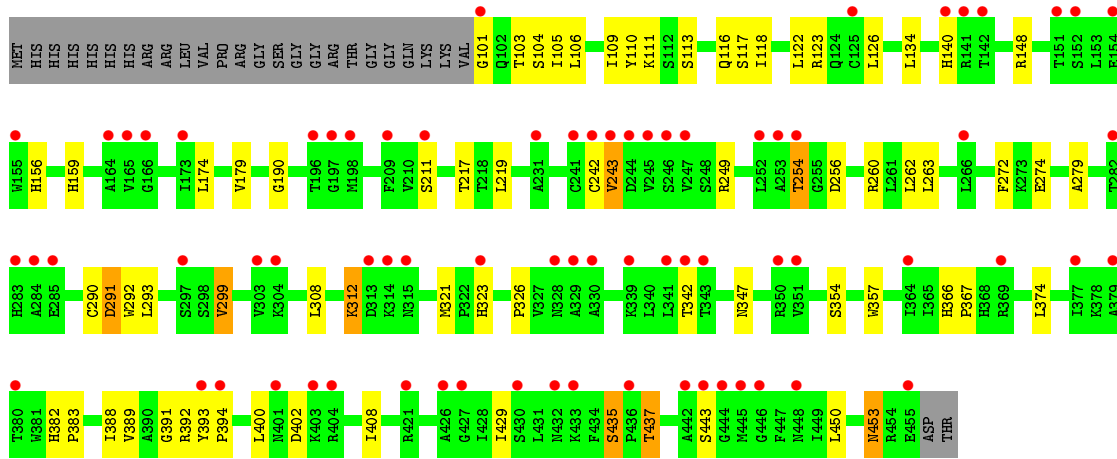

● Molecule 2: DNA DAMAGE-BINDING PROTEIN 2

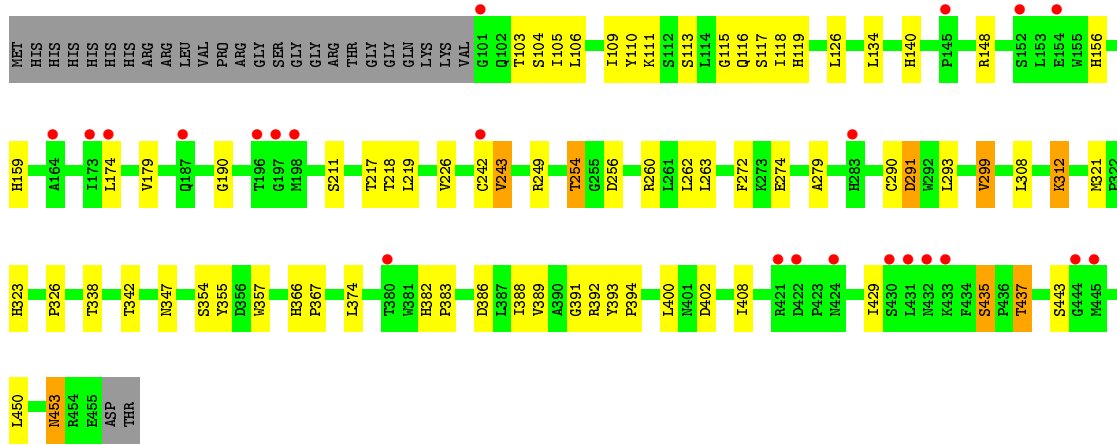
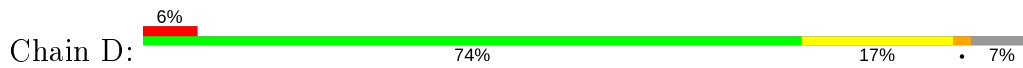

● Molecule 3: CULLIN-4B

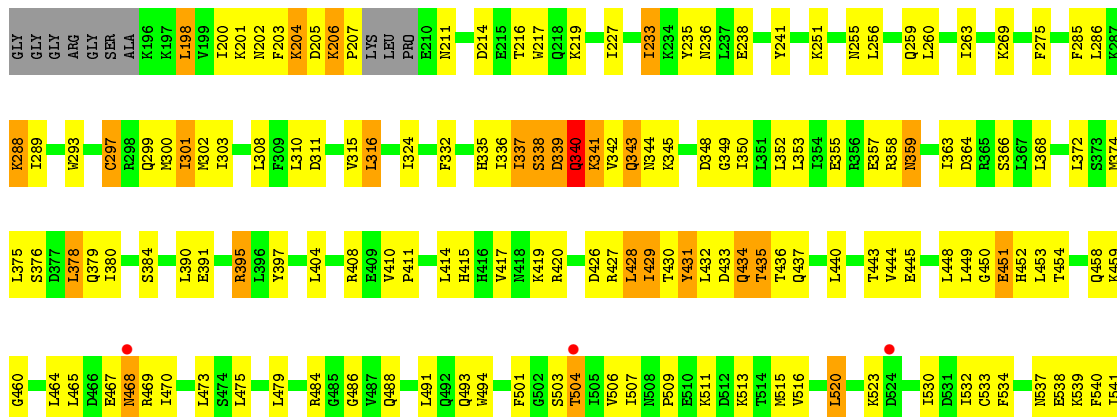

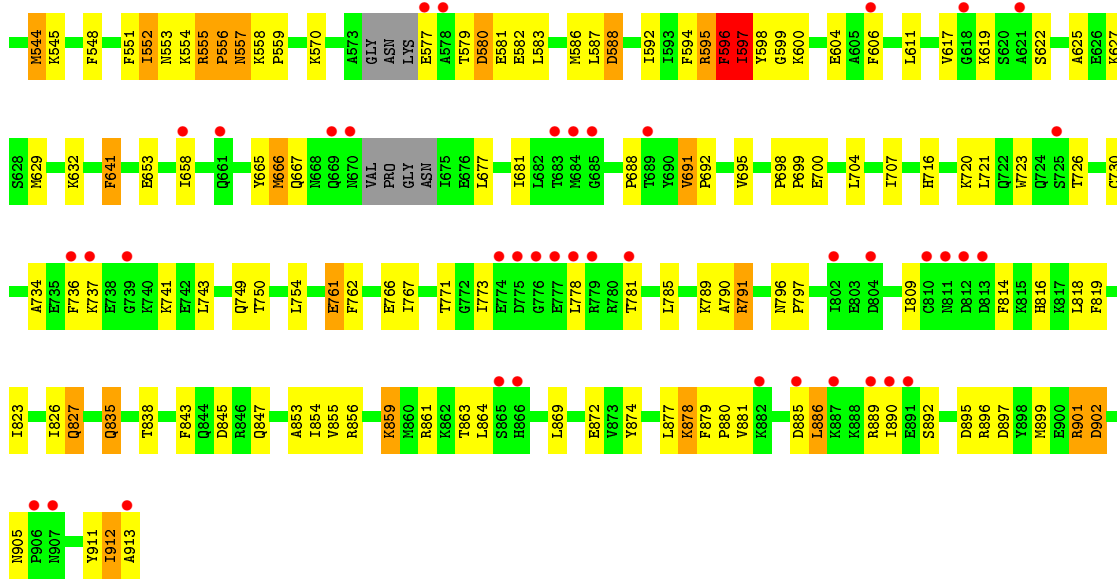

• Molecule 3: CULLIN-4B



Chain H:

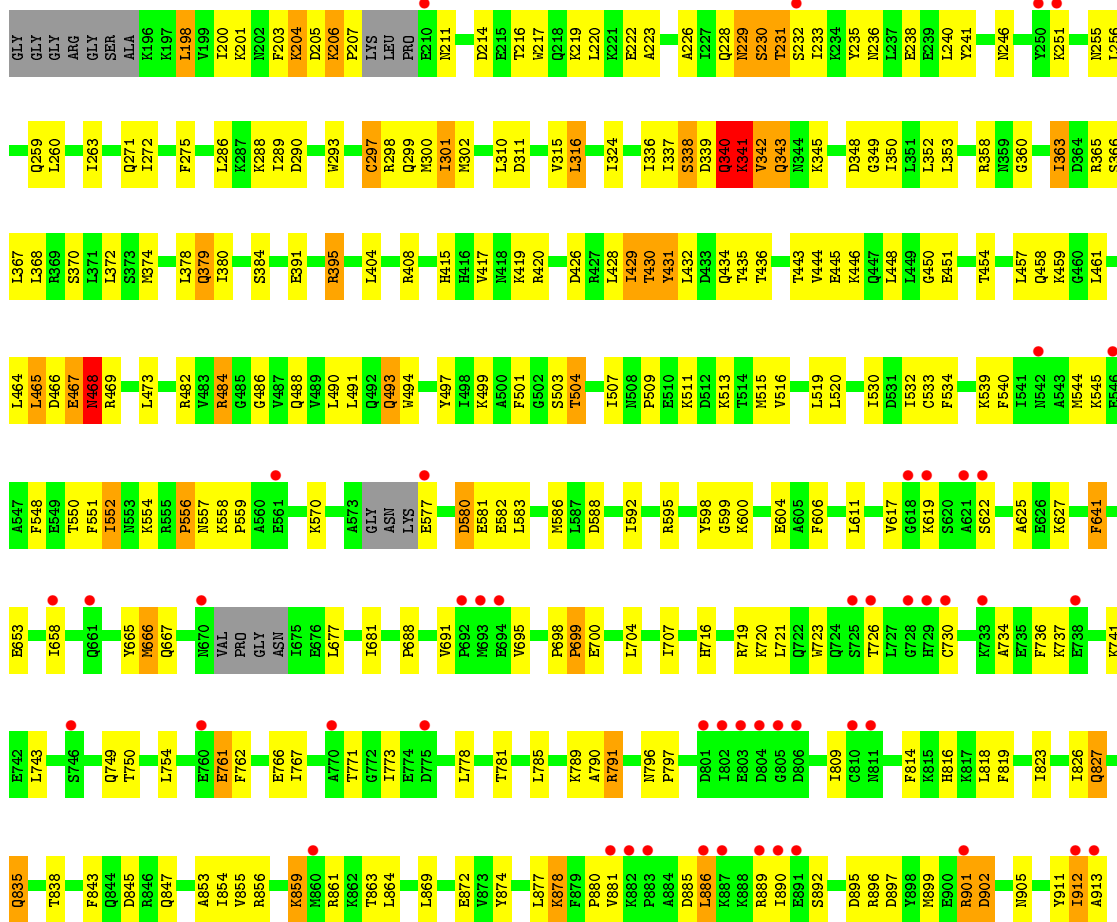

• Molecule 4: E3 UBIQUITIN-PROTEIN LIGASE RBX1

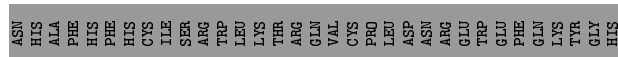
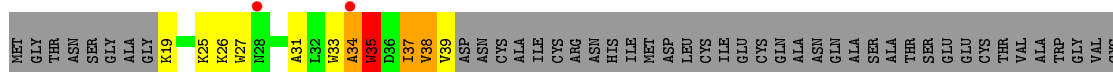

- Molecule 4: E3 UBIQUITIN-PROTEIN LIGASE RBX1

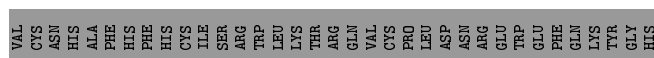
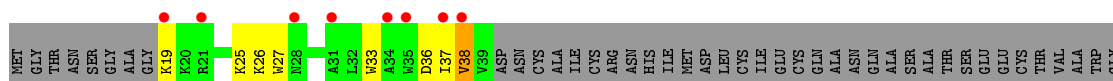

- Molecule 5: 12 BP THF CONTAINING DNA DUPLEX

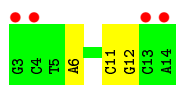
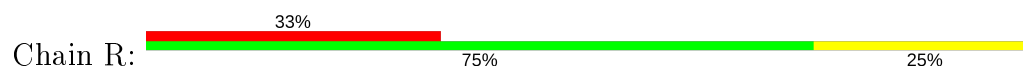

- Molecule 5: 12 BP THF CONTAINING DNA DUPLEX

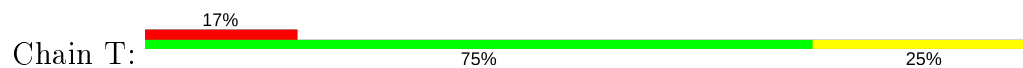

- Molecule 6: 12 BP DNA DUPLEX

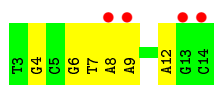

- Molecule 6: 12 BP DNA DUPLEX



4 Data and refinement statistics

Property	Value	Source
Space group	P 1 21 1	Depositor
Cell constants a, b, c, α , β , γ	130.80Å 155.84Å 255.39Å 90.00° 94.17° 90.00°	Depositor
Resolution (Å)	29.86 – 7.40 29.86 – 7.40	Depositor EDS
% Data completeness (in resolution range)	99.0 (29.86-7.40) 99.2 (29.86-7.40)	Depositor EDS
R_{merge}	0.09	Depositor
R_{sym}	(Not available)	Depositor
$\langle I/\sigma(I) \rangle$ ¹	2.74 (at 7.23Å)	Xtrriage
Refinement program	PHENIX (PHENIX.REFINE)	Depositor
R, R_{free}	0.318 , 0.320 0.313 , 0.311	Depositor DCC
R_{free} test set	1355 reflections (10.00%)	wwPDB-VP
Wilson B-factor (Å ²)	444.7	Xtrriage
Anisotropy	0.287	Xtrriage
Bulk solvent k_{sol} (e/Å ³), B_{sol} (Å ²)	0.26 , 213.2	EDS
L-test for twinning ²	$\langle L \rangle = 0.45$, $\langle L^2 \rangle = 0.28$	Xtrriage
Estimated twinning fraction	No twinning to report.	Xtrriage
F_o, F_c correlation	0.76	EDS
Total number of atoms	35553	wwPDB-VP
Average B, all atoms (Å ²)	253.0	wwPDB-VP

Xtrriage's analysis on translational NCS is as follows: *The largest off-origin peak in the Patterson function is 5.82% of the height of the origin peak. No significant pseudotranslation is detected.*

¹Intensities estimated from amplitudes.

²Theoretical values of $\langle |L| \rangle$, $\langle L^2 \rangle$ for acentric reflections are 0.5, 0.333 respectively for untwinned datasets, and 0.375, 0.2 for perfectly twinned datasets.

5 Model quality i

5.1 Standard geometry i

Bond lengths and bond angles in the following residue types are not validated in this section:
3DR

The Z score for a bond length (or angle) is the number of standard deviations the observed value is removed from the expected value. A bond length (or angle) with $|Z| > 5$ is considered an outlier worth inspection. RMSZ is the root-mean-square of all Z scores of the bond lengths (or angles).

Mol	Chain	Bond lengths		Bond angles	
		RMSZ	# Z >5	RMSZ	# Z >5
1	A	0.43	2/8668 (0.0%)	0.66	7/11756 (0.1%)
1	C	0.43	2/8688 (0.0%)	0.66	8/11783 (0.1%)
2	B	0.38	0/2891	0.60	0/3928
2	D	0.38	0/2917	0.60	0/3962
3	E	0.40	3/5831 (0.1%)	0.55	1/7832 (0.0%)
3	H	0.38	0/5865	0.54	0/7878
4	F	0.35	0/179	0.39	0/241
4	I	0.42	0/186	0.43	0/251
5	R	0.92	1/248 (0.4%)	1.13	0/377
5	T	0.92	1/248 (0.4%)	1.12	0/377
6	S	0.89	0/279	1.36	1/429 (0.2%)
6	U	0.88	0/279	1.36	1/429 (0.2%)
All	All	0.43	9/36279 (0.0%)	0.64	18/49243 (0.0%)

The worst 5 of 9 bond length outliers are listed below:

Mol	Chain	Res	Type	Atoms	Z	Observed(Å)	Ideal(Å)
1	C	582	LEU	C-N	6.82	1.45	1.33
1	A	582	LEU	C-N	6.78	1.45	1.33
3	E	579	THR	C-N	-5.89	1.20	1.34
3	E	376	SER	C-N	5.80	1.47	1.34
5	R	11	DC	C1'-N1	5.47	1.56	1.49

The worst 5 of 18 bond angle outliers are listed below:

Mol	Chain	Res	Type	Atoms	Z	Observed(°)	Ideal(°)
1	A	624	SER	N-CA-C	7.04	130.01	111.00
1	C	624	SER	N-CA-C	7.02	129.95	111.00
1	A	688	PRO	N-CA-C	6.63	129.34	112.10
1	C	688	PRO	N-CA-C	6.56	129.16	112.10
1	A	689	ASP	N-CA-C	-6.55	93.32	111.00

There are no chirality outliers.

There are no planarity outliers.

5.2 Too-close contacts

In the following table, the Non-H and H(model) columns list the number of non-hydrogen atoms and hydrogen atoms in the chain respectively. The H(added) column lists the number of hydrogen atoms added and optimized by MolProbity. The Clashes column lists the number of clashes within the asymmetric unit, whereas Symm-Clashes lists symmetry related clashes.

Mol	Chain	Non-H	H(model)	H(added)	Clashes	Symm-Clashes
1	A	8517	0	8394	471	0
1	C	8537	0	8432	389	0
2	B	2819	0	2745	88	0
2	D	2843	0	2788	74	0
3	E	5743	0	5773	296	0
3	H	5773	0	5798	241	0
4	F	175	0	184	22	0
4	I	180	0	178	6	0
5	R	234	0	132	3	0
5	T	234	0	132	3	0
6	S	249	0	136	7	0
6	U	249	0	136	7	0
All	All	35553	0	34828	1424	0

The all-atom clashscore is defined as the number of clashes found per 1000 atoms (including hydrogen atoms). The all-atom clashscore for this structure is 20.

The worst 5 of 1424 close contacts within the same asymmetric unit are listed below, sorted by their clash magnitude.

Atom-1	Atom-2	Interatomic distance (Å)	Clash overlap (Å)
3:E:555:ARG:CG	3:E:559:PRO:HD3	1.32	1.56
1:A:354:THR:CG2	1:A:712:ILE:HG21	1.37	1.53
3:E:552:ILE:CG2	3:E:597:ILE:HG12	1.42	1.48
3:H:365:ARG:CB	3:H:430:THR:HG22	1.44	1.45
3:E:555:ARG:HB3	3:E:559:PRO:CG	1.52	1.37

There are no symmetry-related clashes.

5.3 Torsion angles [i](#)

5.3.1 Protein backbone [i](#)

In the following table, the Percentiles column shows the percent Ramachandran outliers of the chain as a percentile score with respect to all X-ray entries followed by that with respect to entries of similar resolution.

The Analysed column shows the number of residues for which the backbone conformation was analysed, and the total number of residues.

Mol	Chain	Analysed	Favoured	Allowed	Outliers	Percentiles	
1	A	1095/1144 (96%)	948 (87%)	105 (10%)	42 (4%)	3	24
1	C	1095/1144 (96%)	967 (88%)	97 (9%)	31 (3%)	5	30
2	B	353/382 (92%)	333 (94%)	16 (4%)	4 (1%)	14	52
2	D	353/382 (92%)	333 (94%)	16 (4%)	4 (1%)	14	52
3	E	701/726 (97%)	603 (86%)	73 (10%)	25 (4%)	3	25
3	H	701/726 (97%)	604 (86%)	72 (10%)	25 (4%)	3	25
4	F	19/98 (19%)	14 (74%)	2 (10%)	3 (16%)	0	3
4	I	19/98 (19%)	16 (84%)	2 (10%)	1 (5%)	2	19
All	All	4336/4700 (92%)	3818 (88%)	383 (9%)	135 (3%)	4	27

5 of 135 Ramachandran outliers are listed below:

Mol	Chain	Res	Type
1	A	367	LEU
1	A	390	ILE
1	A	430	VAL
1	A	583	GLY
1	A	598	SER

5.3.2 Protein sidechains [i](#)

In the following table, the Percentiles column shows the percent sidechain outliers of the chain as a percentile score with respect to all X-ray entries followed by that with respect to entries of similar resolution.

The Analysed column shows the number of residues for which the sidechain conformation was analysed, and the total number of residues.

Mol	Chain	Analysed	Rotameric	Outliers	Percentiles	
1	A	938/1000 (94%)	847 (90%)	91 (10%)	8	27

Continued on next page...

Continued from previous page...

Mol	Chain	Analysed	Rotameric	Outliers	Percentiles	
1	C	944/1000 (94%)	854 (90%)	90 (10%)	8	27
2	B	306/335 (91%)	283 (92%)	23 (8%)	13	38
2	D	313/335 (93%)	290 (93%)	23 (7%)	14	39
3	E	625/660 (95%)	535 (86%)	90 (14%)	3	16
3	H	631/660 (96%)	548 (87%)	83 (13%)	4	18
4	F	17/83 (20%)	13 (76%)	4 (24%)	1	4
4	I	16/83 (19%)	14 (88%)	2 (12%)	4	19
All	All	3790/4156 (91%)	3384 (89%)	406 (11%)	6	23

5 of 406 residues with a non-rotameric sidechain are listed below:

Mol	Chain	Res	Type
1	C	728	GLU
3	E	198	LEU
3	H	595	ARG
1	C	881	LEU
2	D	134	LEU

Some sidechains can be flipped to improve hydrogen bonding and reduce clashes. 5 of 99 such sidechains are listed below:

Mol	Chain	Res	Type
1	C	494	GLN
1	C	885	ASN
3	H	557	ASN
1	C	524	GLN
1	C	648	ASN

5.3.3 RNA [i](#)

There are no RNA molecules in this entry.

5.4 Non-standard residues in protein, DNA, RNA chains [i](#)

2 non-standard protein/DNA/RNA residues are modelled in this entry.

In the following table, the Counts columns list the number of bonds (or angles) for which Mogul statistics could be retrieved, the number of bonds (or angles) that are observed in the model and the number of bonds (or angles) that are defined in the Chemical Component Dictionary. The

Link column lists molecule types, if any, to which the group is linked. The Z score for a bond length (or angle) is the number of standard deviations the observed value is removed from the expected value. A bond length (or angle) with $|Z| > 2$ is considered an outlier worth inspection. RMSZ is the root-mean-square of all Z scores of the bond lengths (or angles).

Mol	Type	Chain	Res	Link	Bond lengths			Bond angles		
					Counts	RMSZ	# Z > 2	Counts	RMSZ	# Z > 2
5	3DR	R	9	5	8,11,12	0.40	0	9,14,17	1.10	0
5	3DR	T	9	5	8,11,12	0.41	0	9,14,17	1.09	0

In the following table, the Chirals column lists the number of chiral outliers, the number of chiral centers analysed, the number of these observed in the model and the number defined in the Chemical Component Dictionary. Similar counts are reported in the Torsion and Rings columns. '-' means no outliers of that kind were identified.

Mol	Type	Chain	Res	Link	Chirals	Torsions	Rings
5	3DR	R	9	5	-	1/3/15/16	0/1/1/1
5	3DR	T	9	5	-	1/3/15/16	0/1/1/1

There are no bond length outliers.

There are no bond angle outliers.

There are no chirality outliers.

All (2) torsion outliers are listed below:

Mol	Chain	Res	Type	Atoms
5	R	9	3DR	C3'-C4'-C5'-O5'
5	T	9	3DR	C3'-C4'-C5'-O5'

There are no ring outliers.

No monomer is involved in short contacts.

5.5 Carbohydrates [i](#)

There are no carbohydrates in this entry.

5.6 Ligand geometry [i](#)

There are no ligands in this entry.

5.7 Other polymers [i](#)

There are no such residues in this entry.

5.8 Polymer linkage issues [i](#)

There are no chain breaks in this entry.

6 Fit of model and data [i](#)

6.1 Protein, DNA and RNA chains [i](#)

In the following table, the column labelled '#RSRZ > 2' contains the number (and percentage) of RSRZ outliers, followed by percent RSRZ outliers for the chain as percentile scores relative to all X-ray entries and entries of similar resolution. The OWAB column contains the minimum, median, 95th percentile and maximum values of the occupancy-weighted average B-factor per residue. The column labelled 'Q < 0.9' lists the number of (and percentage) of residues with an average occupancy less than 0.9.

Mol	Chain	Analysed	<RSRZ>	#RSRZ>2	OWAB(Å ²)	Q<0.9
1	A	1105/1144 (96%)	0.42	49 (4%) 34 32	98, 183, 251, 326	0
1	C	1105/1144 (96%)	0.49	55 (4%) 28 28	130, 197, 349, 378	0
2	B	355/382 (92%)	1.05	74 (20%) 1 3	275, 328, 394, 423	0
2	D	355/382 (92%)	0.66	23 (6%) 18 18	193, 275, 343, 370	0
3	E	709/726 (97%)	0.44	44 (6%) 20 20	131, 321, 394, 414	0
3	H	709/726 (97%)	0.49	49 (6%) 16 17	226, 289, 381, 399	0
4	F	21/98 (21%)	0.78	2 (9%) 8 11	368, 383, 396, 398	0
4	I	21/98 (21%)	1.53	8 (38%) 0 1	340, 358, 380, 389	0
5	R	11/12 (91%)	1.86	4 (36%) 0 1	301, 317, 376, 403	0
5	T	11/12 (91%)	1.32	2 (18%) 1 4	257, 344, 355, 356	0
6	S	12/12 (100%)	1.74	4 (33%) 0 2	317, 326, 386, 386	0
6	U	12/12 (100%)	1.69	4 (33%) 0 2	286, 320, 350, 363	0
All	All	4426/4748 (93%)	0.54	318 (7%) 15 16	98, 240, 379, 423	0

The worst 5 of 318 RSRZ outliers are listed below:

Mol	Chain	Res	Type	RSRZ
3	E	775	ASP	10.5
1	C	542	ASP	7.1
3	E	810	CYS	6.3
1	C	503	CYS	5.8
2	D	430	SER	5.8

6.2 Non-standard residues in protein, DNA, RNA chains [i](#)

In the following table, the Atoms column lists the number of modelled atoms in the group and the number defined in the chemical component dictionary. The B-factors column lists the minimum,

median, 95th percentile and maximum values of B factors of atoms in the group. The column labelled 'Q< 0.9' lists the number of atoms with occupancy less than 0.9.

Mol	Type	Chain	Res	Atoms	RSCC	RSR	B-factors(Å ²)	Q<0.9
5	3DR	T	9	11/12	0.69	0.68	347,358,362,362	0
5	3DR	R	9	11/12	0.78	0.38	318,324,336,339	0

6.3 Carbohydrates [i](#)

There are no carbohydrates in this entry.

6.4 Ligands [i](#)

There are no ligands in this entry.

6.5 Other polymers [i](#)

There are no such residues in this entry.