



# Full wwPDB X-ray Structure Validation Report ⓘ

Oct 30, 2023 – 10:57 AM JST

PDB ID : 5AW9  
Title : Kinetics by X-ray crystallography: native E2.MgF42-.2K+ crystal for Rb+ bound crystals  
Authors : Ogawa, H.; Cornelius, F.; Hirata, A.; Toyoshima, C.  
Deposited on : 2015-07-01  
Resolution : 2.80 Å(reported)

This is a Full wwPDB X-ray Structure Validation Report for a publicly released PDB entry.

We welcome your comments at [validation@mail.wwpdb.org](mailto:validation@mail.wwpdb.org)

A user guide is available at

<https://www.wwpdb.org/validation/2017/XrayValidationReportHelp>

with specific help available everywhere you see the ⓘ symbol.

The types of validation reports are described at

<http://www.wwpdb.org/validation/2017/FAQs#types>.

---

The following versions of software and data (see [references ⓘ](#)) were used in the production of this report:

MolProbity : 4.02b-467  
Mogul : 1.8.5 (274361), CSD as541be (2020)  
Xtrriage (Phenix) : 1.13  
EDS : 2.36  
buster-report : 1.1.7 (2018)  
Percentile statistics : 20191225.v01 (using entries in the PDB archive December 25th 2019)  
Refmac : 5.8.0158  
CCP4 : 7.0.044 (Gargrove)  
Ideal geometry (proteins) : Engh & Huber (2001)  
Ideal geometry (DNA, RNA) : Parkinson et al. (1996)  
Validation Pipeline (wwPDB-VP) : 2.36

# 1 Overall quality at a glance

The following experimental techniques were used to determine the structure:

*X-RAY DIFFRACTION*

The reported resolution of this entry is 2.80 Å.

Percentile scores (ranging between 0-100) for global validation metrics of the entry are shown in the following graphic. The table shows the number of entries on which the scores are based.

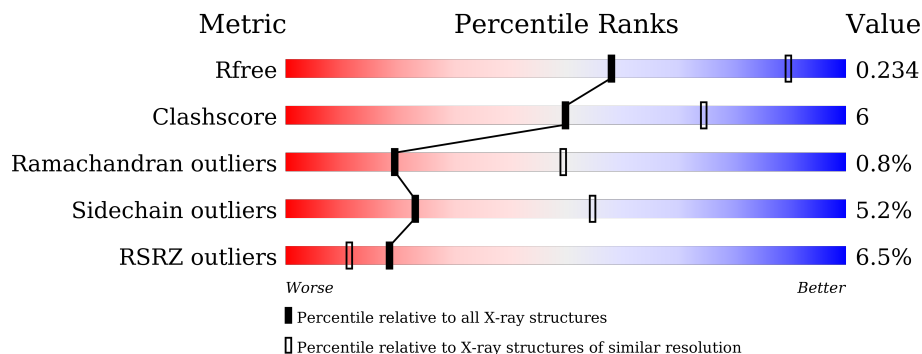

Metric	Whole archive (#Entries)	Similar resolution (#Entries, resolution range(Å))
$R_{free}$	130704	3140 (2.80-2.80)
Clashscore	141614	3569 (2.80-2.80)
Ramachandran outliers	138981	3498 (2.80-2.80)
Sidechain outliers	138945	3500 (2.80-2.80)
RSRZ outliers	127900	3078 (2.80-2.80)

The table below summarises the geometric issues observed across the polymeric chains and their fit to the electron density. The red, orange, yellow and green segments of the lower bar indicate the fraction of residues that contain outliers for  $\geq 3$ , 2, 1 and 0 types of geometric quality criteria respectively. A grey segment represents the fraction of residues that are not modelled. The numeric value for each fraction is indicated below the corresponding segment, with a dot representing fractions  $\leq 5\%$ . The upper red bar (where present) indicates the fraction of residues that have poor fit to the electron density. The numeric value is given above the bar.

Mol	Chain	Length	Quality of chain
1	A	1028	
2	B	305	
3	G	74	
4	C	2	

The following table lists non-polymeric compounds, carbohydrate monomers and non-standard residues in protein, DNA, RNA chains that are outliers for geometric or electron-density-fit crite-

ria:

Mol	Type	Chain	Res	Chirality	Geometry	Clashes	Electron density
4	NAG	C	2	-	-	-	X

## 2 Entry composition [i](#)

There are 10 unique types of molecules in this entry. The entry contains 10362 atoms, of which 0 are hydrogens and 0 are deuteriums.

In the tables below, the ZeroOcc column contains the number of atoms modelled with zero occupancy, the AltConf column contains the number of residues with at least one atom in alternate conformation and the Trace column contains the number of residues modelled with at most 2 atoms.

- Molecule 1 is a protein called Na, K-ATPase alpha subunit.

Mol	Chain	Residues	Atoms					ZeroOcc	AltConf	Trace
			Total	C	N	O	S			
1	A	992	7675	4886	1290	1453	46	0	0	0

- Molecule 2 is a protein called Na<sup>+</sup>,K<sup>+</sup>-ATPase beta subunit.

Mol	Chain	Residues	Atoms					ZeroOcc	AltConf	Trace
			Total	C	N	O	S			
2	B	268	2174	1409	358	396	11	0	0	0

- Molecule 3 is a protein called Phospholemman-like protein.

Mol	Chain	Residues	Atoms					ZeroOcc	AltConf	Trace
			Total	C	N	O	S			
3	G	39	305	200	50	54	1	0	0	0

- Molecule 4 is an oligosaccharide called 2-acetamido-2-deoxy-beta-D-glucopyranose-(1-4)-2-acetamido-2-deoxy-beta-D-glucopyranose.

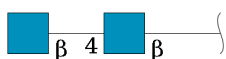

Mol	Chain	Residues	Atoms				ZeroOcc	AltConf	Trace
			Total	C	N	O			
4	C	2	28	16	2	10	0	0	0

- Molecule 5 is TETRAFLUOROMAGNESATE(2-) (three-letter code: MF4) (formula: F<sub>4</sub>Mg).

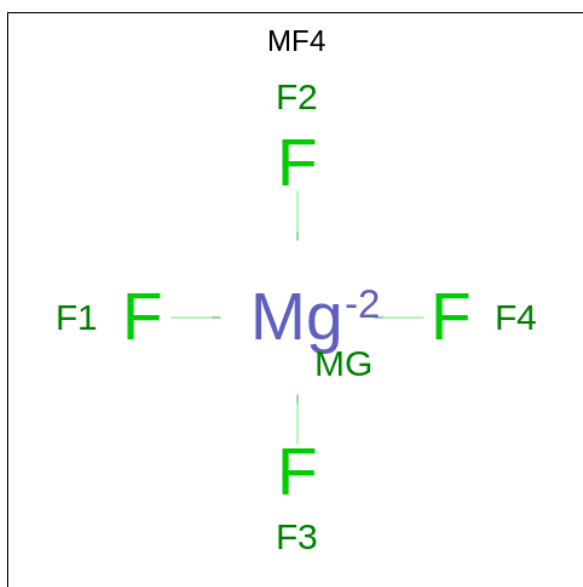

Mol	Chain	Residues	Atoms		ZeroOcc	AltConf
5	A	1	Total	F Mg	0	0
			5	4 1		

- Molecule 6 is MAGNESIUM ION (three-letter code: MG) (formula: Mg).

Mol	Chain	Residues	Atoms		ZeroOcc	AltConf
6	A	1	Total	Mg	0	0
			1	1		

- Molecule 7 is POTASSIUM ION (three-letter code: K) (formula: K).

Mol	Chain	Residues	Atoms		ZeroOcc	AltConf
7	A	3	Total	K	0	0
			3	3		

- Molecule 8 is CHOLESTEROL (three-letter code: CLR) (formula: C<sub>27</sub>H<sub>46</sub>O).



Mol	Chain	Residues	Atoms			ZeroOcc	AltConf
8	B	1	Total	C	O	0	0
			28	27	1		

- Molecule 9 is 2-acetamido-2-deoxy-beta-D-glucopyranose (three-letter code: NAG) (formula:  $C_8H_{15}NO_6$ ).

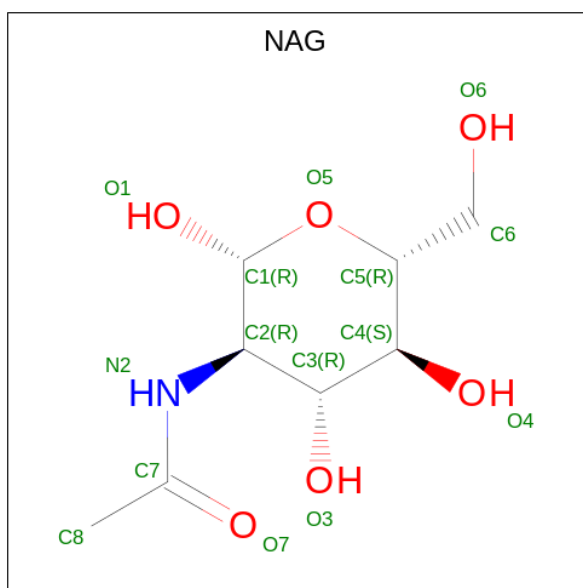

Mol	Chain	Residues	Atoms				ZeroOcc	AltConf
9	B	1	Total	C	N	O	0	0
			14	8	1	5		

- Molecule 10 is water.

Mol	Chain	Residues	Atoms		ZeroOcc	AltConf
10	A	129	Total 129	O 129	0	0

### 3 Residue-property plots i

These plots are drawn for all protein, RNA, DNA and oligosaccharide chains in the entry. The first graphic for a chain summarises the proportions of the various outlier classes displayed in the second graphic. The second graphic shows the sequence view annotated by issues in geometry and electron density. Residues are color-coded according to the number of geometric quality criteria for which they contain at least one outlier: green = 0, yellow = 1, orange = 2 and red = 3 or more. A red dot above a residue indicates a poor fit to the electron density ( $RSRZ > 2$ ). Stretches of 2 or more consecutive residues without any outlier are shown as a green connector. Residues present in the sample, but not in the model, are shown in grey.

- Molecule 1: Na, K-ATPase alpha subunit

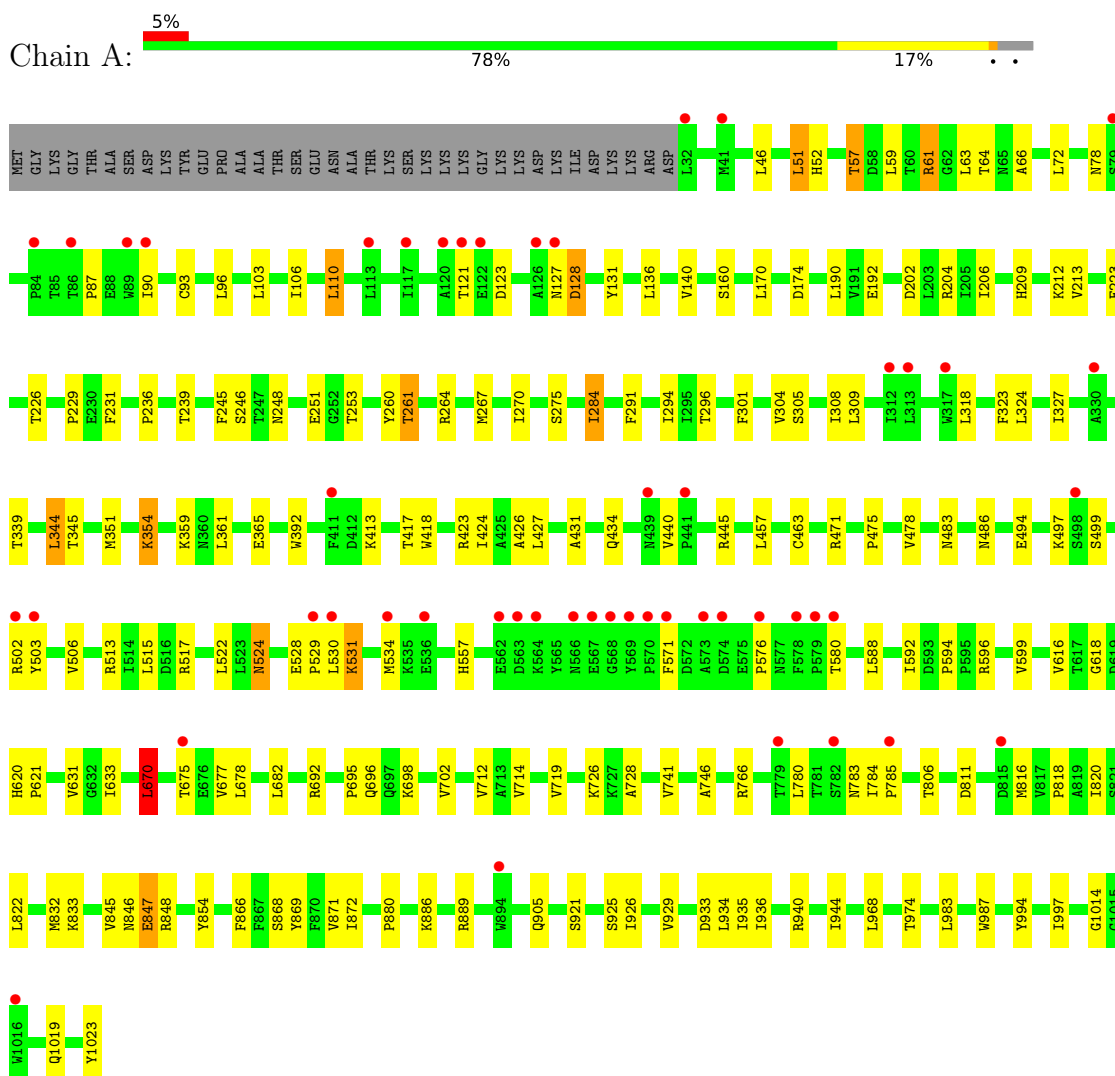

- Molecule 2: Na<sup>+</sup>,K<sup>+</sup>-ATPase beta subunit

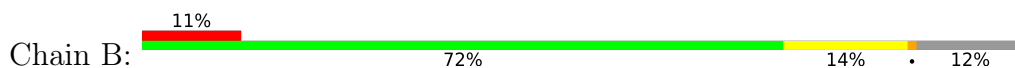



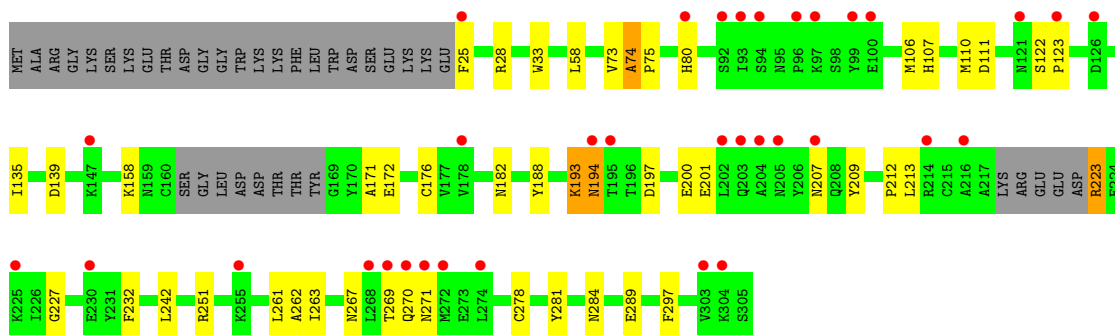

● Molecule 3: Phospholemman-like protein

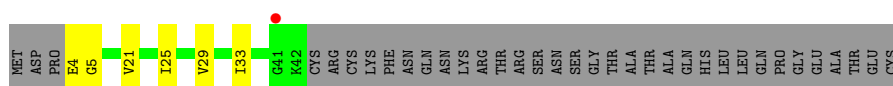

● Molecule 4: 2-acetamido-2-deoxy-beta-D-glucopyranose-(1-4)-2-acetamido-2-deoxy-beta-D-glucopyranose



## 4 Data and refinement statistics

Property	Value	Source
Space group	C 1 2 1	Depositor
Cell constants a, b, c, $\alpha$ , $\beta$ , $\gamma$	219.97Å 50.67Å 163.07Å 90.00° 104.50° 90.00°	Depositor
Resolution (Å)	15.00 – 2.80 35.49 – 2.80	Depositor EDS
% Data completeness (in resolution range)	92.9 (15.00-2.80) 93.6 (35.49-2.80)	Depositor EDS
$R_{merge}$	(Not available)	Depositor
$R_{sym}$	(Not available)	Depositor
$\langle I/\sigma(I) \rangle$ <sup>1</sup>	1.90 (at 2.81Å)	Xtrriage
Refinement program	REFMAC 5.8.0103	Depositor
R, $R_{free}$	0.217 , 0.265 0.221 , 0.234	Depositor DCC
$R_{free}$ test set	2063 reflections (5.05%)	wwPDB-VP
Wilson B-factor (Å <sup>2</sup> )	76.9	Xtrriage
Anisotropy	0.490	Xtrriage
Bulk solvent $k_{sol}$ (e/Å <sup>3</sup> ), $B_{sol}$ (Å <sup>2</sup> )	0.33 , 60.3	EDS
L-test for twinning <sup>2</sup>	$\langle  L  \rangle = 0.49$ , $\langle L^2 \rangle = 0.32$	Xtrriage
Estimated twinning fraction	No twinning to report.	Xtrriage
$F_o, F_c$ correlation	0.94	EDS
Total number of atoms	10362	wwPDB-VP
Average B, all atoms (Å <sup>2</sup> )	92.0	wwPDB-VP

Xtrriage's analysis on translational NCS is as follows: *The largest off-origin peak in the Patterson function is 4.04% of the height of the origin peak. No significant pseudotranslation is detected.*

<sup>1</sup>Intensities estimated from amplitudes.

<sup>2</sup>Theoretical values of  $\langle |L| \rangle$ ,  $\langle L^2 \rangle$  for acentric reflections are 0.5, 0.333 respectively for untwinned datasets, and 0.375, 0.2 for perfectly twinned datasets.

## 5 Model quality [i](#)

### 5.1 Standard geometry [i](#)

Bond lengths and bond angles in the following residue types are not validated in this section: NAG, CLR, MG, MF4, K

The Z score for a bond length (or angle) is the number of standard deviations the observed value is removed from the expected value. A bond length (or angle) with  $|Z| > 5$  is considered an outlier worth inspection. RMSZ is the root-mean-square of all Z scores of the bond lengths (or angles).

Mol	Chain	Bond lengths		Bond angles	
		RMSZ	# Z  >5	RMSZ	# Z  >5
1	A	0.47	0/7825	0.68	1/10616 (0.0%)
2	B	0.51	0/2229	0.65	0/3002
3	G	0.52	0/309	0.66	0/419
All	All	0.48	0/10363	0.67	1/14037 (0.0%)

There are no bond length outliers.

All (1) bond angle outliers are listed below:

Mol	Chain	Res	Type	Atoms	Z	Observed( $^{\circ}$ )	Ideal( $^{\circ}$ )
1	A	670	LEU	CA-CB-CG	5.26	127.41	115.30

There are no chirality outliers.

There are no planarity outliers.

### 5.2 Too-close contacts [i](#)

In the following table, the Non-H and H(model) columns list the number of non-hydrogen atoms and hydrogen atoms in the chain respectively. The H(added) column lists the number of hydrogen atoms added and optimized by MolProbity. The Clashes column lists the number of clashes within the asymmetric unit, whereas Symm-Clashes lists symmetry-related clashes.

Mol	Chain	Non-H	H(model)	H(added)	Clashes	Symm-Clashes
1	A	7675	0	7699	92	0
2	B	2174	0	2146	27	0
3	G	305	0	318	2	0
4	C	28	0	25	0	0
5	A	5	0	0	0	0
6	A	1	0	0	0	0
7	A	3	0	0	0	0

*Continued on next page...*

*Continued from previous page...*

Mol	Chain	Non-H	H(model)	H(added)	Clashes	Symm-Clashes
8	B	28	0	46	0	0
9	B	14	0	13	0	0
10	A	129	0	0	3	0
All	All	10362	0	10247	118	0

The all-atom clashscore is defined as the number of clashes found per 1000 atoms (including hydrogen atoms). The all-atom clashscore for this structure is 6.

All (118) close contacts within the same asymmetric unit are listed below, sorted by their clash magnitude.

Atom-1	Atom-2	Interatomic distance (Å)	Clash overlap (Å)
2:B:74:ALA:HB3	2:B:75:PRO:HD3	1.69	0.75
1:A:677:VAL:HG21	10:A:2222:HOH:O	1.89	0.73
1:A:935:ILE:HG23	1:A:944:ILE:HD12	1.72	0.71
1:A:61:ARG:HH11	1:A:61:ARG:HB3	1.55	0.70
1:A:52:HIS:HA	1:A:57:THR:HG23	1.73	0.70
1:A:78:ASN:HA	1:A:261:THR:HG23	1.74	0.70
1:A:766:ARG:HD2	1:A:832:MET:CE	2.28	0.64
1:A:64:THR:HG22	1:A:66:ALA:H	1.61	0.64
1:A:261:THR:HG21	10:A:2134:HOH:O	1.98	0.63
1:A:261:THR:HG22	1:A:264:ARG:HH21	1.62	0.62
2:B:74:ALA:CB	2:B:75:PRO:HD3	2.29	0.62
1:A:261:THR:HG22	1:A:264:ARG:NH2	2.15	0.62
1:A:994:TYR:HA	1:A:997:ILE:HG22	1.84	0.59
2:B:213:LEU:HD11	2:B:278:CYS:HB3	1.85	0.59
1:A:816:MET:O	1:A:820:ILE:HG12	2.02	0.59
1:A:670:LEU:HD23	1:A:678:LEU:HD21	1.85	0.58
1:A:246:SER:OG	1:A:267:MET:HG3	2.04	0.57
2:B:227:GLY:HA2	2:B:267:ASN:HB3	1.86	0.57
1:A:344:LEU:HB3	1:A:361:LEU:HG	1.86	0.57
1:A:359:LYS:HE2	1:A:746:ALA:O	2.06	0.56
1:A:868:SER:O	1:A:872:ILE:HG12	2.05	0.56
1:A:345:THR:HA	1:A:361:LEU:HD11	1.88	0.56
2:B:270:GLN:HG2	2:B:271:ASN:HD22	1.71	0.55
1:A:483:ASN:HB2	1:A:486:ASN:HB2	1.89	0.55
2:B:80:HIS:HB3	2:B:297:PHE:CZ	2.42	0.55
2:B:25:PHE:HB3	2:B:33:TRP:HE1	1.72	0.54
3:G:29:VAL:O	3:G:33:ILE:HG12	2.07	0.54
1:A:418:TRP:HZ2	1:A:463:CYS:HG	1.56	0.53
1:A:190:LEU:HD11	1:A:206:ILE:HD11	1.90	0.53
1:A:424:ILE:HG23	1:A:506:VAL:HB	1.91	0.53

*Continued on next page...*

*Continued from previous page...*

Atom-1	Atom-2	Interatomic distance (Å)	Clash overlap (Å)
1:A:417:THR:HA	1:A:522:LEU:HD22	1.91	0.53
1:A:52:HIS:CE1	1:A:59:LEU:HA	2.44	0.53
2:B:193:LYS:HA	2:B:207:ASN:HD21	1.73	0.52
1:A:631:VAL:HG23	1:A:633:ILE:HG12	1.92	0.52
1:A:351:MET:HA	1:A:354:LYS:HG2	1.91	0.52
1:A:87:PRO:HD2	1:A:90:ILE:HD12	1.92	0.52
1:A:106:ILE:O	1:A:110:LEU:HB2	2.10	0.51
1:A:392:TRP:HB3	1:A:588:LEU:HB2	1.92	0.51
1:A:921:SER:HA	1:A:983:LEU:HD11	1.93	0.51
2:B:158:LYS:HB2	2:B:232:PHE:CD1	2.46	0.51
2:B:107:HIS:O	2:B:111:ASP:HB2	2.11	0.51
1:A:818:PRO:HB3	1:A:934:LEU:HD22	1.92	0.50
2:B:106:MET:O	2:B:110:MET:HG2	2.11	0.50
1:A:339:THR:HG23	1:A:820:ILE:HD13	1.93	0.50
1:A:160:SER:HB3	1:A:741:VAL:HG22	1.93	0.50
1:A:766:ARG:HD2	1:A:832:MET:HE2	1.94	0.50
1:A:323:PHE:O	1:A:327:ILE:HG12	2.12	0.49
2:B:209:TYR:HA	2:B:242:LEU:HD22	1.93	0.49
1:A:475:PRO:HD2	1:A:494:GLU:HB2	1.94	0.49
1:A:714:VAL:HG23	1:A:728:ALA:HB2	1.95	0.49
1:A:596:ARG:HB2	1:A:599:VAL:HG23	1.94	0.48
1:A:871:VAL:HG22	2:B:58:LEU:HD13	1.94	0.48
1:A:110:LEU:HD22	1:A:324:LEU:HD12	1.95	0.48
1:A:847:GLU:CD	1:A:847:GLU:H	2.17	0.48
1:A:940:ARG:HE	1:A:1023:TYR:HB2	1.79	0.48
1:A:423:ARG:HG2	1:A:427:LEU:HD22	1.96	0.47
2:B:194:ASN:HD22	2:B:194:ASN:N	2.12	0.47
1:A:478:VAL:HG21	1:A:571:PHE:HB2	1.96	0.47
1:A:846:ASN:ND2	1:A:848:ARG:HB2	2.29	0.47
2:B:194:ASN:HD22	2:B:194:ASN:H	1.61	0.47
1:A:502:ARG:HD2	1:A:503:TYR:H	1.79	0.47
2:B:188:TYR:O	2:B:284:ASN:ND2	2.48	0.47
2:B:267:ASN:HB2	2:B:269:THR:HG22	1.96	0.47
1:A:93:CYS:HA	1:A:96:LEU:HD12	1.96	0.46
1:A:497:LYS:HE2	1:A:499:SER:HB2	1.98	0.46
1:A:304:VAL:O	1:A:308:ILE:HG12	2.15	0.46
1:A:905:GLN:NE2	2:B:182:ASN:HA	2.30	0.46
1:A:127:ASN:HB3	1:A:131:TYR:CD1	2.51	0.46
1:A:301:PHE:O	1:A:305:SER:HB2	2.15	0.46
2:B:122:SER:HA	2:B:123:PRO:HA	1.76	0.46
1:A:528:GLU:HB2	1:A:529:PRO:HD2	1.98	0.45

*Continued on next page...*

*Continued from previous page...*

Atom-1	Atom-2	Interatomic distance (Å)	Clash overlap (Å)
1:A:202:ASP:HB2	1:A:260:TYR:HB2	1.97	0.45
2:B:213:LEU:HD21	2:B:263:ILE:HD11	1.99	0.45
1:A:209:HIS:HB3	1:A:253:THR:HG22	1.99	0.45
2:B:223:ARG:HB2	2:B:223:ARG:HH11	1.82	0.45
1:A:675:THR:HA	1:A:678:LEU:HD12	1.98	0.44
1:A:866:PHE:O	1:A:869:TYR:HB3	2.17	0.44
3:G:21:VAL:O	3:G:25:ILE:HG12	2.18	0.44
1:A:170:LEU:HD23	1:A:192:GLU:HB3	1.99	0.44
1:A:933:ASP:HA	1:A:936:ILE:HG12	1.99	0.44
2:B:74:ALA:CB	2:B:75:PRO:CD	2.96	0.44
1:A:236:PRO:HA	1:A:239:THR:HG22	1.99	0.44
1:A:284:ILE:HG12	1:A:365:GLU:HG3	1.98	0.44
1:A:110:LEU:CD2	1:A:324:LEU:HD12	2.48	0.43
1:A:616:VAL:HG12	1:A:698:LYS:HG2	2.00	0.43
1:A:714:VAL:CG2	1:A:728:ALA:HB2	2.47	0.43
1:A:103:LEU:HD11	1:A:296:THR:HG23	2.01	0.43
1:A:46:LEU:HD12	1:A:51:LEU:HD12	2.00	0.43
1:A:204:ARG:NH1	1:A:229:PRO:O	2.45	0.43
1:A:270:ILE:HD12	1:A:695:PRO:HB2	2.00	0.43
2:B:212:PRO:HG2	2:B:281:TYR:HB2	2.00	0.43
1:A:426:ALA:O	1:A:471:ARG:HD2	2.18	0.43
2:B:232:PHE:HB2	2:B:262:ALA:HB3	2.01	0.42
1:A:418:TRP:HZ2	1:A:463:CYS:SG	2.42	0.42
1:A:889:ARG:HA	1:A:889:ARG:HD3	1.83	0.42
2:B:213:LEU:HD23	2:B:261:LEU:HD13	2.01	0.42
1:A:780:LEU:O	1:A:783:ASN:HB2	2.20	0.42
1:A:925:SER:O	1:A:929:VAL:HG22	2.20	0.42
2:B:213:LEU:HD23	2:B:261:LEU:HD22	2.01	0.42
1:A:592:ILE:O	1:A:594:PRO:HD3	2.20	0.42
1:A:212:LYS:HB2	1:A:251:GLU:HG2	2.02	0.41
1:A:784:ILE:HD11	1:A:854:TYR:CG	2.55	0.41
1:A:223:GLU:HB2	10:A:2191:HOH:O	2.21	0.41
1:A:291:PHE:HA	1:A:294:ILE:HD12	2.02	0.41
1:A:531:LYS:HE3	1:A:534:MET:HG2	2.01	0.41
1:A:785:PRO:HB2	1:A:926:ILE:HD12	2.02	0.41
1:A:431:ALA:O	1:A:471:ARG:NH2	2.40	0.41
1:A:702:VAL:HG13	1:A:712:VAL:HG21	2.01	0.41
1:A:502:ARG:HD2	1:A:503:TYR:N	2.36	0.41
1:A:517:ARG:HD3	1:A:580:THR:O	2.20	0.41
1:A:620:HIS:HA	1:A:621:PRO:HD3	1.93	0.41
1:A:64:THR:HA	1:A:174:ASP:OD1	2.21	0.41

*Continued on next page...*

Continued from previous page...

Atom-1	Atom-2	Interatomic distance (Å)	Clash overlap (Å)
1:A:631:VAL:CG2	1:A:633:ILE:HG12	2.50	0.41
1:A:291:PHE:HB3	1:A:845:VAL:HB	2.03	0.40
1:A:618:GLY:O	1:A:692:ARG:HD2	2.21	0.40
1:A:136:LEU:O	1:A:140:VAL:HG23	2.22	0.40
1:A:440:VAL:HG23	1:A:445:ARG:HB3	2.03	0.40
1:A:905:GLN:HE21	2:B:182:ASN:HA	1.87	0.40

There are no symmetry-related clashes.

## 5.3 Torsion angles [i](#)

### 5.3.1 Protein backbone [i](#)

In the following table, the Percentiles column shows the percent Ramachandran outliers of the chain as a percentile score with respect to all X-ray entries followed by that with respect to entries of similar resolution.

The Analysed column shows the number of residues for which the backbone conformation was analysed, and the total number of residues.

Mol	Chain	Analysed	Favoured	Allowed	Outliers	Percentiles
1	A	990/1028 (96%)	942 (95%)	42 (4%)	6 (1%)	25 56
2	B	262/305 (86%)	227 (87%)	32 (12%)	3 (1%)	14 41
3	G	37/74 (50%)	32 (86%)	4 (11%)	1 (3%)	5 17
All	All	1289/1407 (92%)	1201 (93%)	78 (6%)	10 (1%)	19 49

All (10) Ramachandran outliers are listed below:

Mol	Chain	Res	Type
2	B	74	ALA
1	A	524	ASN
2	B	201	GLU
1	A	121	THR
1	A	128	ASP
2	B	171	ALA
1	A	123	ASP
1	A	576	PRO
1	A	1014	GLY
3	G	5	GLY

### 5.3.2 Protein sidechains [i](#)

In the following table, the Percentiles column shows the percent sidechain outliers of the chain as a percentile score with respect to all X-ray entries followed by that with respect to entries of similar resolution.

The Analysed column shows the number of residues for which the sidechain conformation was analysed, and the total number of residues.

Mol	Chain	Analysed	Rotameric	Outliers	Percentiles	
1	A	840/869 (97%)	796 (95%)	44 (5%)	23	55
2	B	234/266 (88%)	221 (94%)	13 (6%)	21	51
3	G	32/62 (52%)	31 (97%)	1 (3%)	40	74
All	All	1106/1197 (92%)	1048 (95%)	58 (5%)	23	55

All (58) residues with a non-rotameric sidechain are listed below:

Mol	Chain	Res	Type
1	A	51	LEU
1	A	57	THR
1	A	61	ARG
1	A	63	LEU
1	A	72	LEU
1	A	110	LEU
1	A	128	ASP
1	A	213	VAL
1	A	226	THR
1	A	231	PHE
1	A	245	PHE
1	A	248	ASN
1	A	261	THR
1	A	275	SER
1	A	284	ILE
1	A	309	LEU
1	A	318	LEU
1	A	344	LEU
1	A	354	LYS
1	A	413	LYS
1	A	434	GLN
1	A	457	LEU
1	A	513	ARG
1	A	515	LEU
1	A	524	ASN
1	A	530	LEU

*Continued on next page...*



*Continued from previous page...*

Mol	Chain	Res	Type
1	A	531	LYS
1	A	557	HIS
1	A	670	LEU
1	A	682	LEU
1	A	696	GLN
1	A	719	VAL
1	A	726	LYS
1	A	806	THR
1	A	811	ASP
1	A	822	LEU
1	A	833	LYS
1	A	847	GLU
1	A	880	PRO
1	A	886	LYS
1	A	968	LEU
1	A	974	THR
1	A	987	TRP
1	A	1019	GLN
2	B	28	ARG
2	B	73	VAL
2	B	135	ILE
2	B	139	ASP
2	B	172	GLU
2	B	176	CYS
2	B	193	LYS
2	B	194	ASN
2	B	197	ASP
2	B	200	GLU
2	B	223	ARG
2	B	251	ARG
2	B	289	GLU
3	G	4	GLU

Sometimes sidechains can be flipped to improve hydrogen bonding and reduce clashes. All (15) such sidechains are listed below:

Mol	Chain	Res	Type
1	A	118	GLN
1	A	129	ASN
1	A	225	GLN
1	A	524	ASN
1	A	540	ASN
1	A	577	ASN

*Continued on next page...*

Continued from previous page...

Mol	Chain	Res	Type
1	A	754	ASN
1	A	797	ASN
1	A	1019	GLN
2	B	194	ASN
2	B	207	ASN
2	B	258	GLN
2	B	264	GLN
2	B	271	ASN
2	B	284	ASN

### 5.3.3 RNA [i](#)

There are no RNA molecules in this entry.

## 5.4 Non-standard residues in protein, DNA, RNA chains [i](#)

There are no non-standard protein/DNA/RNA residues in this entry.

## 5.5 Carbohydrates [i](#)

2 monosaccharides are modelled in this entry.

In the following table, the Counts columns list the number of bonds (or angles) for which Mogul statistics could be retrieved, the number of bonds (or angles) that are observed in the model and the number of bonds (or angles) that are defined in the Chemical Component Dictionary. The Link column lists molecule types, if any, to which the group is linked. The Z score for a bond length (or angle) is the number of standard deviations the observed value is removed from the expected value. A bond length (or angle) with  $|Z| > 2$  is considered an outlier worth inspection. RMSZ is the root-mean-square of all Z scores of the bond lengths (or angles).

Mol	Type	Chain	Res	Link	Bond lengths			Bond angles		
					Counts	RMSZ	$\# Z  > 2$	Counts	RMSZ	$\# Z  > 2$
4	NAG	C	1	2,4	14,14,15	0.58	0	17,19,21	1.60	1 (5%)
4	NAG	C	2	4	14,14,15	0.85	1 (7%)	17,19,21	1.98	3 (17%)

In the following table, the Chirals column lists the number of chiral outliers, the number of chiral centers analysed, the number of these observed in the model and the number defined in the Chemical Component Dictionary. Similar counts are reported in the Torsion and Rings columns. '-' means no outliers of that kind were identified.

Mol	Type	Chain	Res	Link	Chirals	Torsions	Rings
4	NAG	C	1	2,4	-	1/6/23/26	0/1/1/1
4	NAG	C	2	4	-	1/6/23/26	0/1/1/1

All (1) bond length outliers are listed below:

Mol	Chain	Res	Type	Atoms	Z	Observed(Å)	Ideal(Å)
4	C	2	NAG	C1-C2	2.21	1.55	1.52

All (4) bond angle outliers are listed below:

Mol	Chain	Res	Type	Atoms	Z	Observed(°)	Ideal(°)
4	C	1	NAG	C1-O5-C5	5.75	119.98	112.19
4	C	2	NAG	C2-N2-C7	5.30	130.45	122.90
4	C	2	NAG	C1-O5-C5	4.23	117.93	112.19
4	C	2	NAG	C1-C2-N2	2.30	114.42	110.49

There are no chirality outliers.

All (2) torsion outliers are listed below:

Mol	Chain	Res	Type	Atoms
4	C	1	NAG	O5-C5-C6-O6
4	C	2	NAG	C3-C2-N2-C7

There are no ring outliers.

No monomer is involved in short contacts.

The following is a two-dimensional graphical depiction of Mogul quality analysis of bond lengths, bond angles, torsion angles, and ring geometry for oligosaccharide.

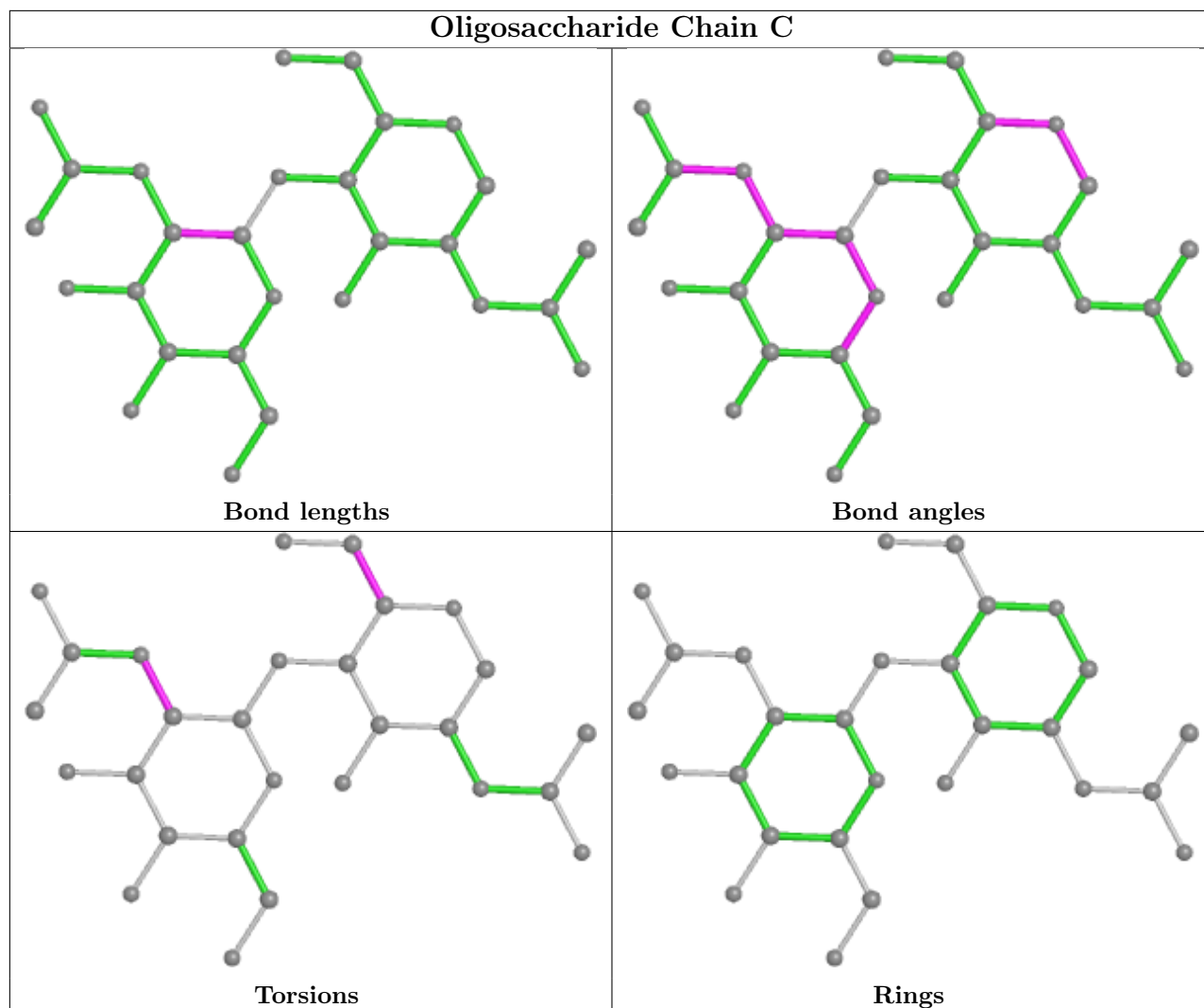

## 5.6 Ligand geometry [i](#)

Of 7 ligands modelled in this entry, 4 are monoatomic - leaving 3 for Mogul analysis.

In the following table, the Counts columns list the number of bonds (or angles) for which Mogul statistics could be retrieved, the number of bonds (or angles) that are observed in the model and the number of bonds (or angles) that are defined in the Chemical Component Dictionary. The Link column lists molecule types, if any, to which the group is linked. The Z score for a bond length (or angle) is the number of standard deviations the observed value is removed from the expected value. A bond length (or angle) with  $|Z| > 2$  is considered an outlier worth inspection. RMSZ is the root-mean-square of all Z scores of the bond lengths (or angles).

Mol	Type	Chain	Res	Link	Bond lengths			Bond angles		
					Counts	RMSZ	$\# Z  > 2$	Counts	RMSZ	$\# Z  > 2$
5	MF4	A	2001	1	0,4,4	-	-	-		
9	NAG	B	4021	2	14,14,15	0.77	0	17,19,21	1.14	1 (5%)
8	CLR	B	3001	-	31,31,31	0.80	0	48,48,48	1.46	9 (18%)

In the following table, the Chirals column lists the number of chiral outliers, the number of chiral centers analysed, the number of these observed in the model and the number defined in the Chemical Component Dictionary. Similar counts are reported in the Torsion and Rings columns. '-' means no outliers of that kind were identified.

Mol	Type	Chain	Res	Link	Chirals	Torsions	Rings
9	NAG	B	4021	2	-	0/6/23/26	0/1/1/1
8	CLR	B	3001	-	-	2/10/68/68	0/4/4/4

There are no bond length outliers.

All (10) bond angle outliers are listed below:

Mol	Chain	Res	Type	Atoms	Z	Observed(°)	Ideal(°)
8	B	3001	CLR	C1-C2-C3	4.29	115.98	110.47
8	B	3001	CLR	C4-C5-C10	3.81	121.48	116.42
8	B	3001	CLR	C4-C5-C6	-3.11	116.13	120.61
8	B	3001	CLR	C16-C17-C13	2.69	107.08	103.84
9	B	4021	NAG	C1-O5-C5	2.57	115.68	112.19
8	B	3001	CLR	C2-C1-C10	2.46	118.08	112.74
8	B	3001	CLR	C21-C20-C22	-2.25	106.84	110.36
8	B	3001	CLR	C15-C14-C13	2.16	106.44	103.84
8	B	3001	CLR	C10-C9-C8	2.13	115.94	112.73
8	B	3001	CLR	C22-C20-C17	2.10	114.62	110.28

There are no chirality outliers.

All (2) torsion outliers are listed below:

Mol	Chain	Res	Type	Atoms
8	B	3001	CLR	C23-C24-C25-C26
8	B	3001	CLR	C23-C24-C25-C27

There are no ring outliers.

No monomer is involved in short contacts.

The following is a two-dimensional graphical depiction of Mogul quality analysis of bond lengths, bond angles, torsion angles, and ring geometry for all instances of the Ligand of Interest. In addition, ligands with molecular weight > 250 and outliers as shown on the validation Tables will also be included. For torsion angles, if less than 5% of the Mogul distribution of torsion angles is within 10 degrees of the torsion angle in question, then that torsion angle is considered an outlier. Any bond that is central to one or more torsion angles identified as an outlier by Mogul will be highlighted in the graph. For rings, the root-mean-square deviation (RMSD) between the ring in question and similar rings identified by Mogul is calculated over all ring torsion angles. If the average RMSD is greater than 60 degrees and the minimal RMSD between the ring in question and any Mogul-identified rings is also greater than 60 degrees, then that ring is considered an outlier.

The outliers are highlighted in purple. The color gray indicates Mogul did not find sufficient equivalents in the CSD to analyse the geometry.

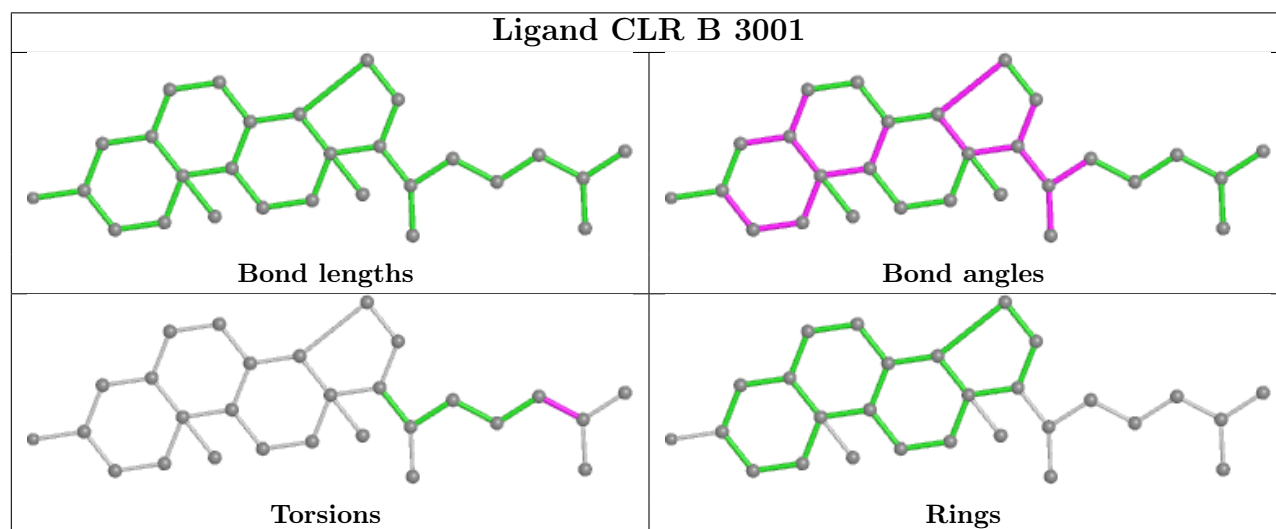

## 5.7 Other polymers [i](#)

There are no such residues in this entry.

## 5.8 Polymer linkage issues [i](#)

There are no chain breaks in this entry.

## 6 Fit of model and data

### 6.1 Protein, DNA and RNA chains

In the following table, the column labelled ‘#RSRZ > 2’ contains the number (and percentage) of RSRZ outliers, followed by percent RSRZ outliers for the chain as percentile scores relative to all X-ray entries and entries of similar resolution. The OWAB column contains the minimum, median, 95<sup>th</sup> percentile and maximum values of the occupancy-weighted average B-factor per residue. The column labelled ‘Q < 0.9’ lists the number of (and percentage) of residues with an average occupancy less than 0.9.

Mol	Chain	Analysed	<RSRZ>	#RSRZ>2	OWAB(Å <sup>2</sup> )	Q<0.9
1	A	992/1028 (96%)	0.14	50 (5%) 28 19	46, 77, 133, 193	0
2	B	268/305 (87%)	0.66	34 (12%) 3 2	63, 123, 159, 173	0
3	G	39/74 (52%)	-0.20	1 (2%) 56 46	63, 75, 136, 153	0
All	All	1299/1407 (92%)	0.23	85 (6%) 18 11	46, 84, 149, 193	0

All (85) RSRZ outliers are listed below:

Mol	Chain	Res	Type	RSRZ
2	B	93	ILE	6.5
1	A	562	GLU	5.9
1	A	567	GLU	4.9
2	B	99	TYR	4.7
1	A	568	GLY	4.6
2	B	304	LYS	4.6
1	A	563	ASP	4.6
2	B	214	ARG	4.5
2	B	268	LEU	4.4
1	A	579	PRO	4.4
2	B	96	PRO	4.3
1	A	84	PRO	4.1
1	A	90	ILE	4.0
1	A	317	TRP	3.9
1	A	32	LEU	3.9
1	A	498	SER	3.8
1	A	503	TYR	3.8
1	A	566	ASN	3.8
1	A	313	LEU	3.8
1	A	534	MET	3.7
2	B	121	ASN	3.7
1	A	570	PRO	3.7
1	A	573	ALA	3.7

*Continued on next page...*

*Continued from previous page...*

<b>Mol</b>	<b>Chain</b>	<b>Res</b>	<b>Type</b>	<b>RSRZ</b>
2	B	195	THR	3.7
2	B	202	LEU	3.7
2	B	25	PHE	3.6
1	A	574	ASP	3.6
1	A	578	PHE	3.5
1	A	571	PHE	3.4
2	B	194	ASN	3.4
2	B	123	PRO	3.3
1	A	126	ALA	3.2
2	B	271	ASN	3.2
2	B	216	ALA	3.1
1	A	89	TRP	3.1
1	A	779	THR	3.0
1	A	312	ILE	2.9
2	B	272	MET	2.9
2	B	204	ALA	2.8
1	A	127	ASN	2.8
2	B	100	GLU	2.8
2	B	230	GLU	2.8
1	A	675	THR	2.8
2	B	92	SER	2.7
1	A	120	ALA	2.7
1	A	815	ASP	2.7
1	A	530	LEU	2.6
2	B	97	LYS	2.6
1	A	502	ARG	2.6
2	B	225	LYS	2.6
2	B	203	GLN	2.6
1	A	782	SER	2.6
2	B	269	THR	2.6
2	B	270	GLN	2.5
1	A	41	MET	2.5
1	A	122	GLU	2.4
1	A	576	PRO	2.4
2	B	147	LYS	2.4
1	A	894	TRP	2.4
2	B	274	LEU	2.4
3	G	41	GLY	2.3
2	B	207	ASN	2.3
2	B	303	VAL	2.3
1	A	117	ILE	2.3
1	A	1016	TRP	2.3

*Continued on next page...*



*Continued from previous page...*

Mol	Chain	Res	Type	RSRZ
1	A	330	ALA	2.3
1	A	79	SER	2.3
1	A	529	PRO	2.3
1	A	564	LYS	2.3
2	B	255	LYS	2.3
1	A	121	THR	2.3
2	B	94	SER	2.3
1	A	569	TYR	2.3
1	A	580	THR	2.2
1	A	113	LEU	2.2
1	A	439	ASN	2.2
2	B	205	ASN	2.2
2	B	80	HIS	2.1
2	B	126	ASP	2.1
1	A	86	THR	2.1
1	A	536	GLU	2.1
1	A	411	PHE	2.1
1	A	785	PRO	2.0
2	B	178	VAL	2.0
1	A	441	PRO	2.0

## 6.2 Non-standard residues in protein, DNA, RNA chains [i](#)

There are no non-standard protein/DNA/RNA residues in this entry.

## 6.3 Carbohydrates [i](#)

In the following table, the Atoms column lists the number of modelled atoms in the group and the number defined in the chemical component dictionary. The B-factors column lists the minimum, median, 95<sup>th</sup> percentile and maximum values of B factors of atoms in the group. The column labelled 'Q< 0.9' lists the number of atoms with occupancy less than 0.9.

Mol	Type	Chain	Res	Atoms	RSCC	RSR	B-factors(Å <sup>2</sup> )	Q<0.9
4	NAG	C	2	14/15	0.62	0.46	121,153,160,161	0
4	NAG	C	1	14/15	0.91	0.26	122,139,146,150	0

The following is a graphical depiction of the model fit to experimental electron density for oligosaccharide. Each fit is shown from different orientation to approximate a three-dimensional view.

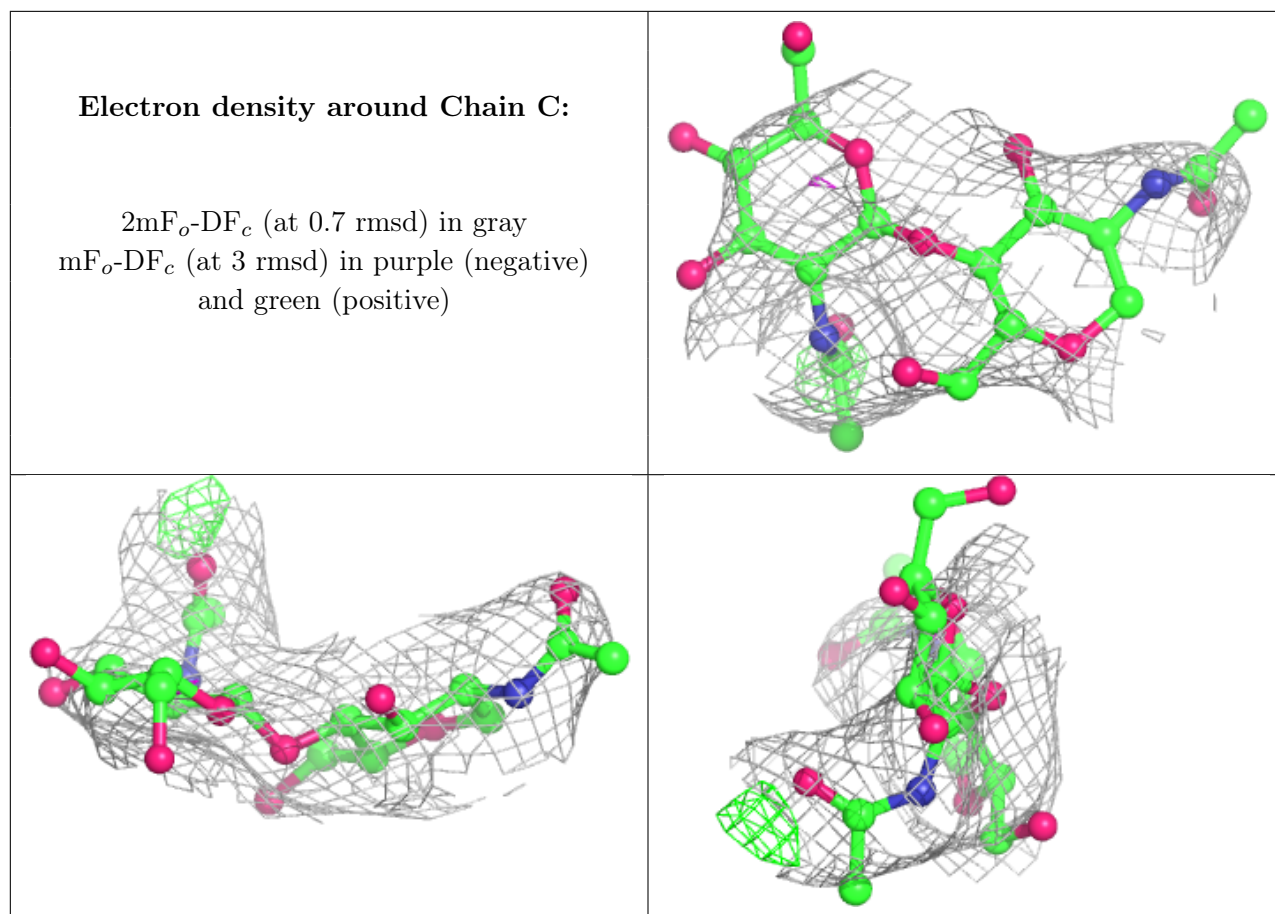

## 6.4 Ligands [i](#)

In the following table, the Atoms column lists the number of modelled atoms in the group and the number defined in the chemical component dictionary. The B-factors column lists the minimum, median, 95<sup>th</sup> percentile and maximum values of B factors of atoms in the group. The column labelled 'Q<0.9' lists the number of atoms with occupancy less than 0.9.

Mol	Type	Chain	Res	Atoms	RSCC	RSR	B-factors(Å <sup>2</sup> )	Q<0.9
9	NAG	B	4021	14/15	0.79	0.34	133,144,149,157	0
8	CLR	B	3001	28/28	0.89	0.20	105,113,128,129	0
7	K	A	2004	1/1	0.97	0.36	76,76,76,76	0
5	MF4	A	2001	5/5	0.97	0.30	48,48,50,55	0
7	K	A	2003	1/1	0.97	0.32	70,70,70,70	0
6	MG	A	2002	1/1	0.98	0.24	53,53,53,53	0
7	K	A	2005	1/1	0.98	0.16	69,69,69,69	0

The following is a graphical depiction of the model fit to experimental electron density of all instances of the Ligand of Interest. In addition, ligands with molecular weight > 250 and outliers as shown on the geometry validation Tables will also be included. Each fit is shown from different orientation to approximate a three-dimensional view.

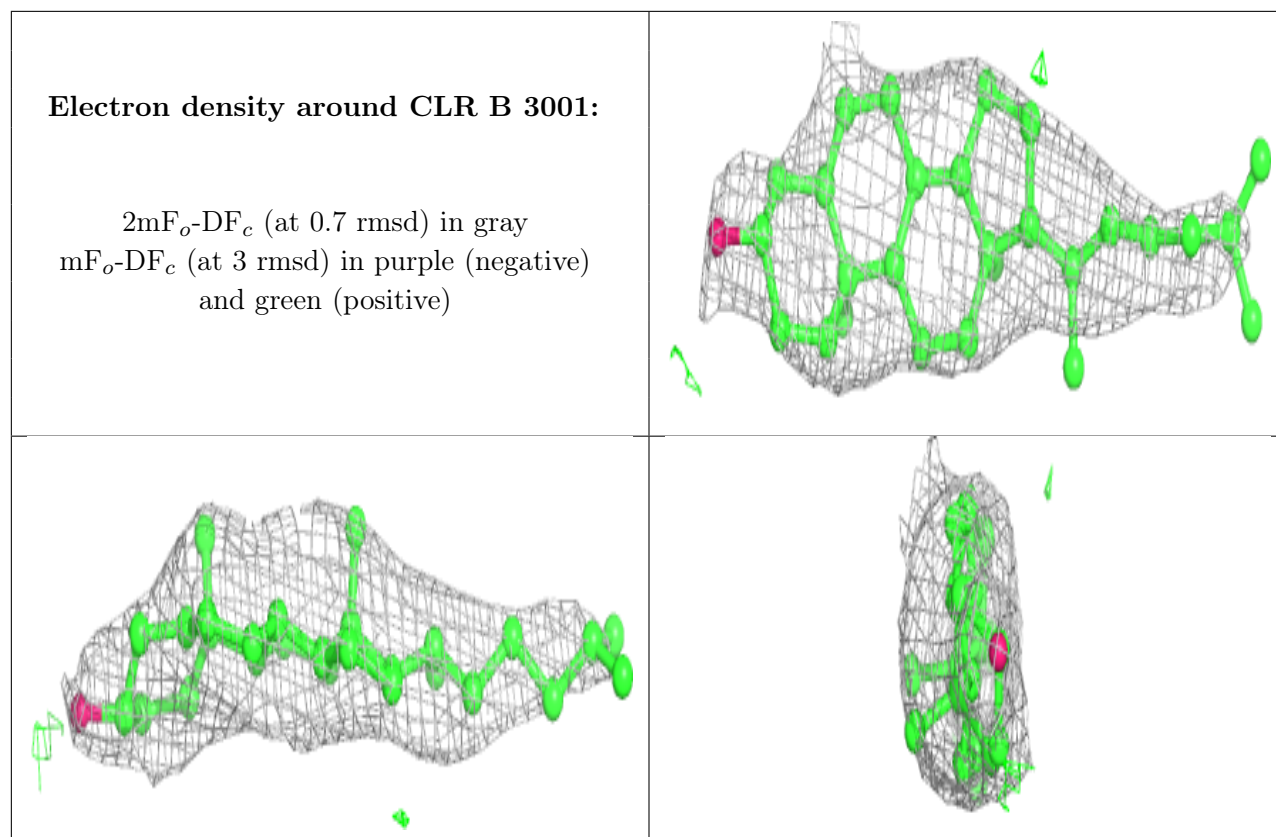

## 6.5 Other polymers [i](#)

There are no such residues in this entry.