



wwPDB X-ray Structure Validation Summary Report ⓘ

Dec 12, 2023 – 08:56 pm GMT

PDB ID : 4B4X
Title : Crystal structure of a complex between Actinomadura R39 DD-peptidase and a sulfonamide boronate inhibitor
Authors : Cannella, S.E.; Sauvage, E.; Herman, R.; Kerff, F.; Rocaboy, M.; Charlier, P.
Deposited on : 2012-08-01
Resolution : 2.65 Å(reported)

This is a wwPDB X-ray Structure Validation Summary Report for a publicly released PDB entry.

We welcome your comments at validation@mail.wwpdb.org

A user guide is available at

<https://www.wwpdb.org/validation/2017/XrayValidationReportHelp>

with specific help available everywhere you see the ⓘ symbol.

The types of validation reports are described at

<http://www.wwpdb.org/validation/2017/FAQs#types>.

The following versions of software and data (see [references ⓘ](#)) were used in the production of this report:

MolProbity : 4.02b-467
Mogul : 1.8.4, CSD as541be (2020)
Xtriage (Phenix) : 1.13
EDS : 2.36
Percentile statistics : 20191225.v01 (using entries in the PDB archive December 25th 2019)
Refmac : 5.8.0158
CCP4 : 7.0.044 (Gargrove)
Ideal geometry (proteins) : Engh & Huber (2001)
Ideal geometry (DNA, RNA) : Parkinson et al. (1996)
Validation Pipeline (wwPDB-VP) : 2.36

1 Overall quality at a glance

The following experimental techniques were used to determine the structure:

X-RAY DIFFRACTION

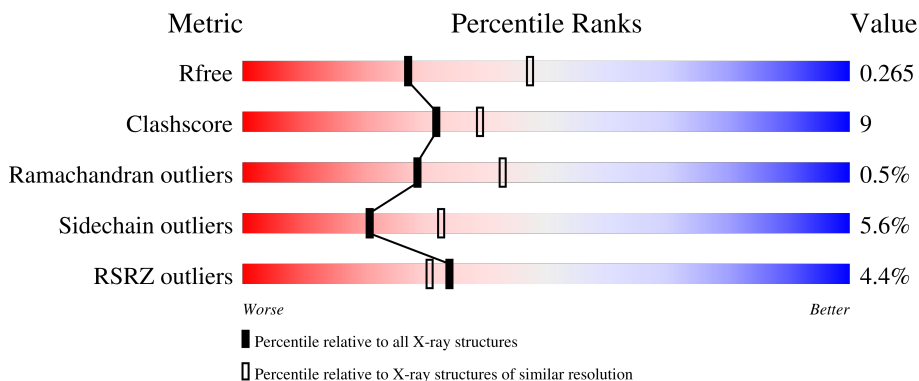

The reported resolution of this entry is 2.65 Å.

Percentile scores (ranging between 0-100) for global validation metrics of the entry are shown in the following graphic. The table shows the number of entries on which the scores are based.

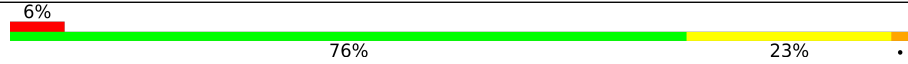
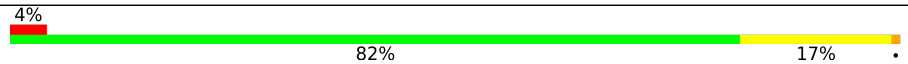

Metric	Whole archive (#Entries)	Similar resolution (#Entries, resolution range(Å))
R_{free}	130704	1332 (2.68-2.64)
Clashscore	141614	1374 (2.68-2.64)
Ramachandran outliers	138981	1349 (2.68-2.64)
Sidechain outliers	138945	1349 (2.68-2.64)
RSRZ outliers	127900	1318 (2.68-2.64)

The table below summarises the geometric issues observed across the polymeric chains and their fit to the electron density. The red, orange, yellow and green segments of the lower bar indicate the fraction of residues that contain outliers for ≥ 3 , 2, 1 and 0 types of geometric quality criteria respectively. A grey segment represents the fraction of residues that are not modelled. The numeric value for each fraction is indicated below the corresponding segment, with a dot representing fractions $\leq 5\%$. The upper red bar (where present) indicates the fraction of residues that have poor fit to the electron density. The numeric value is given above the bar.

Mol	Chain	Length	Quality of chain
1	A	466	
1	B	466	
1	C	466	
1	D	466	

The following table lists non-polymeric compounds, carbohydrate monomers and non-standard

residues in protein, DNA, RNA chains that are outliers for geometric or electron-density-fit criteria:

Mol	Type	Chain	Res	Chirality	Geometry	Clashes	Electron density
3	SO4	A	1470	-	-	X	-
3	SO4	B	1470	-	-	X	-
3	SO4	C	1466	-	-	X	-
3	SO4	D	1470	-	-	X	-
3	SO4	D	1474	-	-	X	-

2 Entry composition [i](#)

There are 5 unique types of molecules in this entry. The entry contains 13905 atoms, of which 0 are hydrogens and 0 are deuteriums.

In the tables below, the ZeroOcc column contains the number of atoms modelled with zero occupancy, the AltConf column contains the number of residues with at least one atom in alternate conformation and the Trace column contains the number of residues modelled with at most 2 atoms.

- Molecule 1 is a protein called D-ALANYL-D-ALANINE CARBOXYPEPTIDASE.

Mol	Chain	Residues	Atoms					ZeroOcc	AltConf	Trace
			Total	C	N	O	S			
1	A	466	Total 3353	C 2076	N 564	O 707	S 6	0	0	0
1	B	466	Total 3344	C 2071	N 564	O 703	S 6	0	0	1
1	C	466	Total 3344	C 2071	N 564	O 703	S 6	0	0	1
1	D	466	Total 3353	C 2076	N 564	O 707	S 6	0	0	0

- Molecule 2 is trihydroxy{(1S)-1-[(methylsulfonyl)amino]ethyl}borate(1-) (three-letter code: HQZ) (formula: C₃H₁₁BNO₅S).

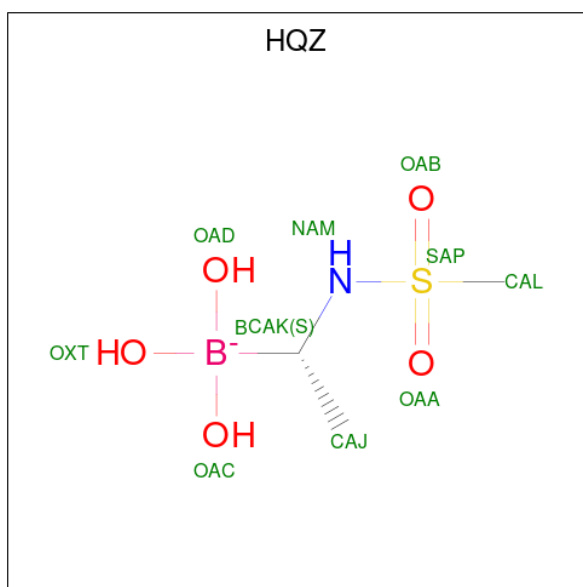

Mol	Chain	Residues	Atoms					ZeroOcc	AltConf	
			Total	B	C	N	O			S
2	A	1	Total 10	B 1	C 3	N 1	O 4	S 1	0	0
2	B	1	Total 10	B 1	C 3	N 1	O 4	S 1	0	0

Continued on next page...

Continued from previous page...

Mol	Chain	Residues	Atoms					ZeroOcc	AltConf	
2	C	1	Total	B	C	N	O	S	0	0
			10	1	3	1	4	1		
2	D	1	Total	B	C	N	O	S	0	0
			10	1	3	1	4	1		

- Molecule 3 is SULFATE ION (three-letter code: SO4) (formula: O₄S).

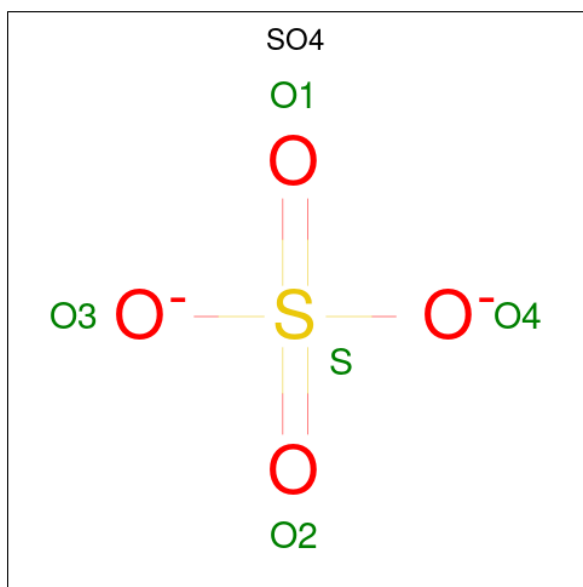

Mol	Chain	Residues	Atoms		ZeroOcc	AltConf
3	A	1	Total	O S	0	0
			5	4 1		
3	A	1	Total	O S	0	0
			5	4 1		
3	A	1	Total	O S	0	0
			5	4 1		
3	A	1	Total	O S	0	0
			5	4 1		
3	A	1	Total	O S	0	0
			5	4 1		
3	A	1	Total	O S	0	0
			5	4 1		
3	B	1	Total	O S	0	0
			5	4 1		
3	B	1	Total	O S	0	0
			5	4 1		
3	B	1	Total	O S	0	0
			5	4 1		

Continued on next page...

Continued from previous page...

Mol	Chain	Residues	Atoms			ZeroOcc	AltConf
3	B	1	Total	O	S	0	0
			5	4	1		
3	B	1	Total	O	S	0	0
			5	4	1		
3	B	1	Total	O	S	0	0
			5	4	1		
3	C	1	Total	O	S	0	0
			5	4	1		
3	C	1	Total	O	S	0	0
			5	4	1		
3	C	1	Total	O	S	0	0
			5	4	1		
3	C	1	Total	O	S	0	0
			5	4	1		
3	C	1	Total	O	S	0	0
			5	4	1		
3	D	1	Total	O	S	0	0
			5	4	1		
3	D	1	Total	O	S	0	0
			5	4	1		
3	D	1	Total	O	S	0	0
			5	4	1		
3	D	1	Total	O	S	0	0
			5	4	1		
3	D	1	Total	O	S	0	0
			5	4	1		

- Molecule 4 is MAGNESIUM ION (three-letter code: MG) (formula: Mg).

Mol	Chain	Residues	Atoms		ZeroOcc	AltConf
4	A	2	Total	Mg	0	0
			2	2		
4	D	2	Total	Mg	0	0
			2	2		

- Molecule 5 is water.

Mol	Chain	Residues	Atoms		ZeroOcc	AltConf
5	A	92	Total 92	O 92	0	0
5	B	68	Total 68	O 68	0	0
5	C	76	Total 76	O 76	0	0
5	D	111	Total 111	O 111	0	0

3 Residue-property plots [i](#)

These plots are drawn for all protein, RNA, DNA and oligosaccharide chains in the entry. The first graphic for a chain summarises the proportions of the various outlier classes displayed in the second graphic. The second graphic shows the sequence view annotated by issues in geometry and electron density. Residues are color-coded according to the number of geometric quality criteria for which they contain at least one outlier: green = 0, yellow = 1, orange = 2 and red = 3 or more. A red dot above a residue indicates a poor fit to the electron density ($RSRZ > 2$). Stretches of 2 or more consecutive residues without any outlier are shown as a green connector. Residues present in the sample, but not in the model, are shown in grey.

• Molecule 1: D-ALANYL-D-ALANINE CARBOXYPEPTIDASE

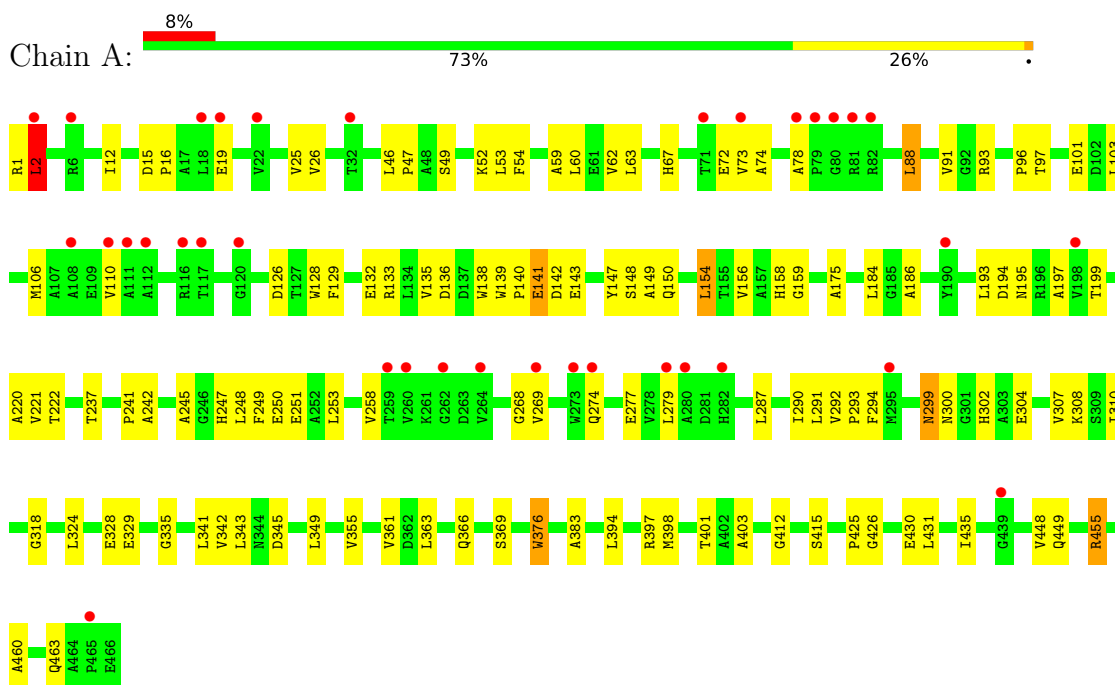

• Molecule 1: D-ALANYL-D-ALANINE CARBOXYPEPTIDASE

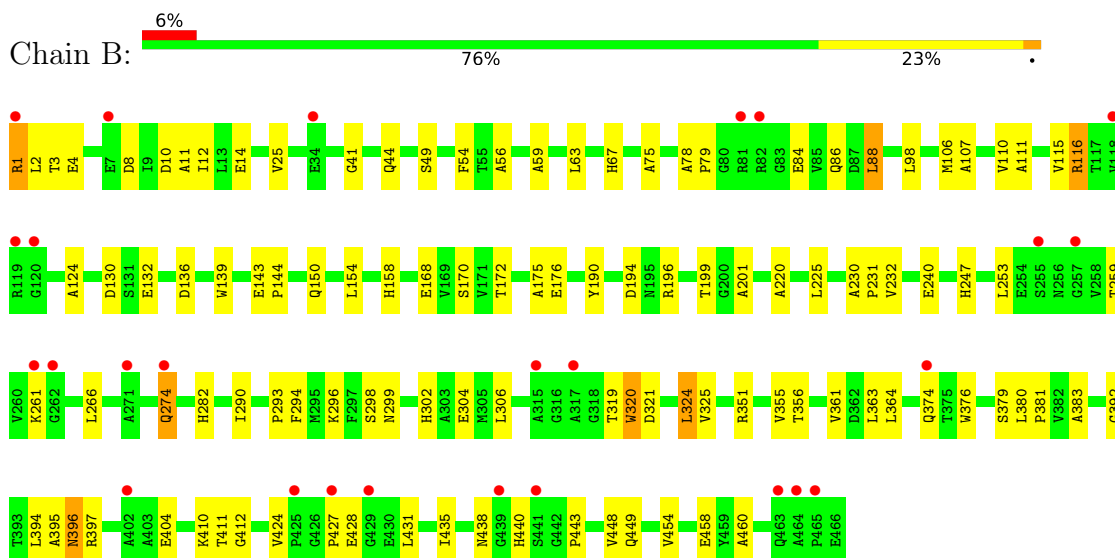

- Molecule 1: D-ALANYL-D-ALANINE CARBOXYPEPTIDASE

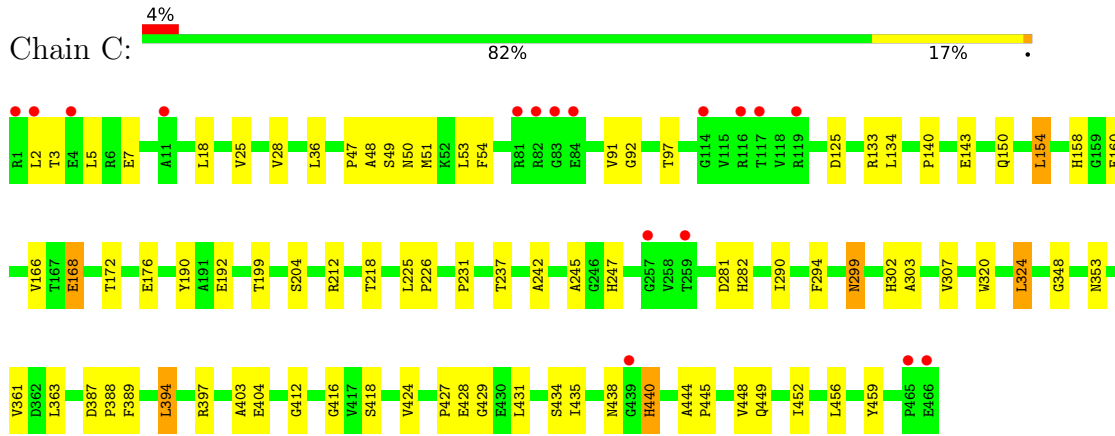

- Molecule 1: D-ALANYL-D-ALANINE CARBOXYPEPTIDASE

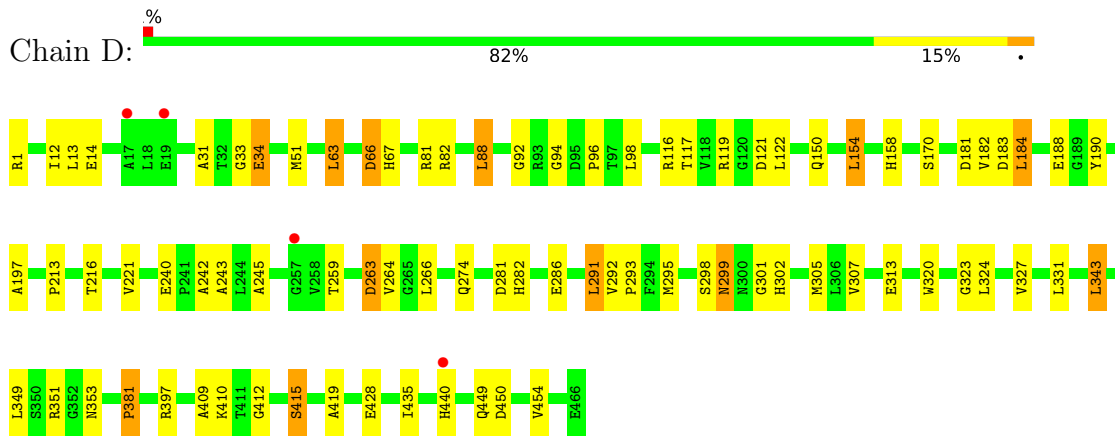

4 Data and refinement statistics i

Property	Value	Source
Space group	P 1 21 1	Depositor
Cell constants a, b, c, α , β , γ	102.33Å 92.11Å 105.96Å 90.00° 95.90° 90.00°	Depositor
Resolution (Å)	35.13 – 2.65 35.13 – 2.65	Depositor EDS
% Data completeness (in resolution range)	98.0 (35.13-2.65) 98.0 (35.13-2.65)	Depositor EDS
R_{merge}	0.11	Depositor
R_{sym}	(Not available)	Depositor
$\langle I/\sigma(I) \rangle$ ¹	2.33 (at 2.65Å)	Xtrriage
Refinement program	REFMAC 5.5.0109	Depositor
R, R_{free}	0.217 , 0.268 0.216 , 0.265	Depositor DCC
R_{free} test set	2825 reflections (5.05%)	wwPDB-VP
Wilson B-factor (Å ²)	47.1	Xtrriage
Anisotropy	0.160	Xtrriage
Bulk solvent k_{sol} (e/Å ³), B_{sol} (Å ²)	0.35 , 53.3	EDS
L-test for twinning ²	$\langle L \rangle = 0.48$, $\langle L^2 \rangle = 0.31$	Xtrriage
Estimated twinning fraction	0.014 for l,-k,h	Xtrriage
F_o, F_c correlation	0.93	EDS
Total number of atoms	13905	wwPDB-VP
Average B, all atoms (Å ²)	49.0	wwPDB-VP

Xtrriage's analysis on translational NCS is as follows: *The largest off-origin peak in the Patterson function is 8.62% of the height of the origin peak. No significant pseudotranslation is detected.*

¹Intensities estimated from amplitudes.

²Theoretical values of $\langle |L| \rangle$, $\langle L^2 \rangle$ for acentric reflections are 0.5, 0.333 respectively for untwinned datasets, and 0.375, 0.2 for perfectly twinned datasets.

5 Model quality [i](#)

5.1 Standard geometry [i](#)

Bond lengths and bond angles in the following residue types are not validated in this section: HQZ, SO4, MG

The Z score for a bond length (or angle) is the number of standard deviations the observed value is removed from the expected value. A bond length (or angle) with $|Z| > 5$ is considered an outlier worth inspection. RMSZ is the root-mean-square of all Z scores of the bond lengths (or angles).

Mol	Chain	Bond lengths		Bond angles	
		RMSZ	# Z >5	RMSZ	# Z >5
1	A	0.66	0/3412	0.73	1/4666 (0.0%)
1	B	0.60	0/3403	0.69	1/4656 (0.0%)
1	C	0.65	2/3403 (0.1%)	0.68	0/4656
1	D	0.76	0/3412	0.77	1/4666 (0.0%)
All	All	0.67	2/13630 (0.0%)	0.72	3/18644 (0.0%)

All (2) bond length outliers are listed below:

Mol	Chain	Res	Type	Atoms	Z	Observed(Å)	Ideal(Å)
1	C	168	GLU	CD-OE2	6.33	1.32	1.25
1	C	168	GLU	CG-CD	6.11	1.61	1.51

All (3) bond angle outliers are listed below:

Mol	Chain	Res	Type	Atoms	Z	Observed(°)	Ideal(°)
1	D	343	LEU	CA-CB-CG	5.83	128.71	115.30
1	A	46	LEU	CA-CB-CG	5.82	128.68	115.30
1	B	98	LEU	CA-CB-CG	5.16	127.16	115.30

There are no chirality outliers.

There are no planarity outliers.

5.2 Too-close contacts [i](#)

In the following table, the Non-H and H(model) columns list the number of non-hydrogen atoms and hydrogen atoms in the chain respectively. The H(added) column lists the number of hydrogen atoms added and optimized by MolProbity. The Clashes column lists the number of clashes within the asymmetric unit, whereas Symm-Clashes lists symmetry-related clashes.

Mol	Chain	Non-H	H(model)	H(added)	Clashes	Symm-Clashes
1	A	3353	0	3200	79	0
1	B	3344	0	3194	63	0
1	C	3344	0	3194	50	0
1	D	3353	0	3200	44	1
2	A	10	0	10	0	0
2	B	10	0	10	2	0
2	C	10	0	10	0	0
2	D	10	0	10	0	0
3	A	30	0	0	3	0
3	B	30	0	0	5	0
3	C	30	0	0	2	0
3	D	30	0	0	6	0
4	A	2	0	0	0	0
4	D	2	0	0	0	1
5	A	92	0	0	2	0
5	B	68	0	0	3	0
5	C	76	0	0	0	0
5	D	111	0	0	0	0
All	All	13905	0	12828	235	1

The all-atom clashscore is defined as the number of clashes found per 1000 atoms (including hydrogen atoms). The all-atom clashscore for this structure is 9.

The worst 5 of 235 close contacts within the same asymmetric unit are listed below, sorted by their clash magnitude.

Atom-1	Atom-2	Interatomic distance (Å)	Clash overlap (Å)
1:A:426:GLY:HA3	1:A:460:ALA:HB1	1.45	0.96
1:A:341:LEU:HD13	1:A:343:LEU:HD21	1.47	0.96
1:B:130:ASP:OD2	1:B:319:THR:HG22	1.79	0.83
1:B:168:GLU:OE2	3:B:1470:SO4:S	2.37	0.82
1:B:63:LEU:O	1:B:67:HIS:HB2	1.84	0.78

All (1) symmetry-related close contacts are listed below. The label for Atom-2 includes the symmetry operator and encoded unit-cell translations to be applied.

Atom-1	Atom-2	Interatomic distance (Å)	Clash overlap (Å)
1:D:181:ASP:OD2	4:D:1472:MG:MG[2_655]	1.67	0.53

5.3 Torsion angles [i](#)

5.3.1 Protein backbone [i](#)

In the following table, the Percentiles column shows the percent Ramachandran outliers of the chain as a percentile score with respect to all X-ray entries followed by that with respect to entries of similar resolution.

The Analysed column shows the number of residues for which the backbone conformation was analysed, and the total number of residues.

Mol	Chain	Analysed	Favoured	Allowed	Outliers	Percentiles	
1	A	464/466 (100%)	421 (91%)	41 (9%)	2 (0%)	34	48
1	B	464/466 (100%)	426 (92%)	35 (8%)	3 (1%)	25	37
1	C	464/466 (100%)	436 (94%)	27 (6%)	1 (0%)	47	64
1	D	464/466 (100%)	432 (93%)	29 (6%)	3 (1%)	25	37
All	All	1856/1864 (100%)	1715 (92%)	132 (7%)	9 (0%)	29	43

5 of 9 Ramachandran outliers are listed below:

Mol	Chain	Res	Type
1	B	298	SER
1	C	428	GLU
1	D	13	LEU
1	D	31	ALA
1	A	2	LEU

5.3.2 Protein sidechains [i](#)

In the following table, the Percentiles column shows the percent sidechain outliers of the chain as a percentile score with respect to all X-ray entries followed by that with respect to entries of similar resolution.

The Analysed column shows the number of residues for which the sidechain conformation was analysed, and the total number of residues.

Mol	Chain	Analysed	Rotameric	Outliers	Percentiles	
1	A	339/339 (100%)	322 (95%)	17 (5%)	24	38
1	B	338/339 (100%)	317 (94%)	21 (6%)	18	29
1	C	338/339 (100%)	327 (97%)	11 (3%)	38	54
1	D	339/339 (100%)	312 (92%)	27 (8%)	12	18
All	All	1354/1356 (100%)	1278 (94%)	76 (6%)	21	33

5 of 76 residues with a non-rotameric sidechain are listed below:

Mol	Chain	Res	Type
1	D	117	THR
1	D	343	LEU
1	D	154	LEU
1	D	291	LEU
1	D	440	HIS

Sometimes sidechains can be flipped to improve hydrogen bonding and reduce clashes. 5 of 31 such sidechains are listed below:

Mol	Chain	Res	Type
1	B	449	GLN
1	D	302	HIS
1	C	302	HIS
1	D	437	ASN
1	D	86	GLN

5.3.3 RNA [i](#)

There are no RNA molecules in this entry.

5.4 Non-standard residues in protein, DNA, RNA chains [i](#)

There are no non-standard protein/DNA/RNA residues in this entry.

5.5 Carbohydrates [i](#)

There are no monosaccharides in this entry.

5.6 Ligand geometry [i](#)

Of 32 ligands modelled in this entry, 4 are monoatomic - leaving 28 for Mogul analysis.

In the following table, the Counts columns list the number of bonds (or angles) for which Mogul statistics could be retrieved, the number of bonds (or angles) that are observed in the model and the number of bonds (or angles) that are defined in the Chemical Component Dictionary. The Link column lists molecule types, if any, to which the group is linked. The Z score for a bond length (or angle) is the number of standard deviations the observed value is removed from the expected value. A bond length (or angle) with $|Z| > 2$ is considered an outlier worth inspection. RMSZ is the root-mean-square of all Z scores of the bond lengths (or angles).

Mol	Type	Chain	Res	Link	Bond lengths			Bond angles		
					Counts	RMSZ	# Z > 2	Counts	RMSZ	# Z > 2
3	SO4	B	1467	-	4,4,4	0.16	0	6,6,6	0.35	0
3	SO4	D	1467	-	4,4,4	0.10	0	6,6,6	0.37	0
3	SO4	B	1466	-	4,4,4	0.10	0	6,6,6	0.34	0
2	HQZ	C	500	1	6,9,10	2.98	4 (66%)	7,13,16	3.96	4 (57%)
3	SO4	B	1471	-	4,4,4	0.15	0	6,6,6	0.21	0
3	SO4	A	1470	-	4,4,4	0.19	0	6,6,6	0.39	0
3	SO4	A	1474	-	4,4,4	0.16	0	6,6,6	0.30	0
3	SO4	A	1469	-	4,4,4	0.13	0	6,6,6	0.21	0
3	SO4	B	1469	-	4,4,4	0.18	0	6,6,6	0.20	0
2	HQZ	A	500	1	6,9,10	3.06	4 (66%)	7,13,16	3.44	2 (28%)
3	SO4	D	1468	-	4,4,4	0.26	0	6,6,6	0.12	0
3	SO4	B	1470	-	4,4,4	0.15	0	6,6,6	0.37	0
3	SO4	D	1470	-	4,4,4	0.17	0	6,6,6	0.37	0
3	SO4	C	1467	-	4,4,4	0.17	0	6,6,6	0.41	0
3	SO4	C	1470	-	4,4,4	0.18	0	6,6,6	0.14	0
3	SO4	D	1473	-	4,4,4	0.12	0	6,6,6	0.25	0
3	SO4	D	1474	-	4,4,4	0.19	0	6,6,6	0.42	0
3	SO4	A	1473	-	4,4,4	0.21	0	6,6,6	0.29	0
2	HQZ	D	500	1	6,9,10	2.60	4 (66%)	7,13,16	4.49	4 (57%)
3	SO4	C	1468	-	4,4,4	0.25	0	6,6,6	0.65	0
3	SO4	B	1468	-	4,4,4	0.18	0	6,6,6	0.41	0
3	SO4	A	1467	-	4,4,4	0.19	0	6,6,6	0.45	0
3	SO4	C	1466	-	4,4,4	0.25	0	6,6,6	0.27	0
2	HQZ	B	500	1	6,9,10	2.80	4 (66%)	7,13,16	4.12	3 (42%)
3	SO4	C	1469	-	4,4,4	0.18	0	6,6,6	0.19	0
3	SO4	C	1471	-	4,4,4	0.17	0	6,6,6	0.18	0
3	SO4	A	1468	-	4,4,4	0.16	0	6,6,6	0.09	0
3	SO4	D	1469	-	4,4,4	0.18	0	6,6,6	0.40	0

In the following table, the Chirals column lists the number of chiral outliers, the number of chiral centers analysed, the number of these observed in the model and the number defined in the Chemical Component Dictionary. Similar counts are reported in the Torsion and Rings columns. '-' means no outliers of that kind were identified.

Mol	Type	Chain	Res	Link	Chirals	Torsions	Rings
2	HQZ	D	500	1	-	3/4/9/11	-
2	HQZ	C	500	1	-	2/4/9/11	-
2	HQZ	A	500	1	-	3/4/9/11	-
2	HQZ	B	500	1	-	4/4/9/11	-

The worst 5 of 16 bond length outliers are listed below:

Mol	Chain	Res	Type	Atoms	Z	Observed(Å)	Ideal(Å)
2	C	500	HQZ	SAP-NAM	-4.59	1.53	1.62
2	B	500	HQZ	SAP-NAM	-4.12	1.54	1.62
2	C	500	HQZ	OAB-SAP	3.92	1.50	1.43
2	A	500	HQZ	CAL-SAP	-3.87	1.66	1.75
2	A	500	HQZ	SAP-NAM	-3.85	1.54	1.62

The worst 5 of 13 bond angle outliers are listed below:

Mol	Chain	Res	Type	Atoms	Z	Observed(°)	Ideal(°)
2	B	500	HQZ	OAB-SAP-OAA	-9.75	104.83	118.85
2	D	500	HQZ	OAB-SAP-OAA	-9.51	105.17	118.85
2	C	500	HQZ	OAB-SAP-OAA	-9.28	105.51	118.85
2	A	500	HQZ	OAB-SAP-OAA	-7.56	107.98	118.85
2	D	500	HQZ	OAB-SAP-NAM	4.88	114.69	107.23

There are no chirality outliers.

5 of 12 torsion outliers are listed below:

Mol	Chain	Res	Type	Atoms
2	B	500	HQZ	CAK-NAM-SAP-OAA
2	C	500	HQZ	CAK-NAM-SAP-OAA
2	C	500	HQZ	CAK-NAM-SAP-CAL
2	D	500	HQZ	CAK-NAM-SAP-OAA
2	A	500	HQZ	CAK-NAM-SAP-OAA

There are no ring outliers.

8 monomers are involved in 18 short contacts:

Mol	Chain	Res	Type	Clashes	Symm-Clashes
3	B	1471	SO4	1	0
3	A	1470	SO4	2	0
3	A	1469	SO4	1	0
3	B	1470	SO4	4	0
3	D	1470	SO4	3	0
3	D	1474	SO4	3	0
3	C	1466	SO4	2	0
2	B	500	HQZ	2	0

5.7 Other polymers

There are no such residues in this entry.

5.8 Polymer linkage issues

There are no chain breaks in this entry.

6 Fit of model and data [i](#)

6.1 Protein, DNA and RNA chains [i](#)

In the following table, the column labelled ‘#RSRZ > 2’ contains the number (and percentage) of RSRZ outliers, followed by percent RSRZ outliers for the chain as percentile scores relative to all X-ray entries and entries of similar resolution. The OWAB column contains the minimum, median, 95th percentile and maximum values of the occupancy-weighted average B-factor per residue. The column labelled ‘Q < 0.9’ lists the number of (and percentage) of residues with an average occupancy less than 0.9.

Mol	Chain	Analysed	<RSRZ>	#RSRZ>2	OWAB(Å ²)	Q<0.9
1	A	466/466 (100%)	0.52	35 (7%) 14 11	38, 55, 73, 87	0
1	B	466/466 (100%)	0.30	26 (5%) 24 21	38, 56, 78, 91	0
1	C	466/466 (100%)	0.06	17 (3%) 42 39	26, 48, 72, 90	0
1	D	466/466 (100%)	-0.16	4 (0%) 84 83	18, 34, 55, 78	0
All	All	1864/1864 (100%)	0.18	82 (4%) 34 31	18, 51, 73, 91	0

The worst 5 of 82 RSRZ outliers are listed below:

Mol	Chain	Res	Type	RSRZ
1	A	108	ALA	6.5
1	A	279	LEU	5.8
1	B	317	ALA	5.1
1	A	282	HIS	4.6
1	B	464	ALA	4.5

6.2 Non-standard residues in protein, DNA, RNA chains [i](#)

There are no non-standard protein/DNA/RNA residues in this entry.

6.3 Carbohydrates [i](#)

There are no monosaccharides in this entry.

6.4 Ligands [i](#)

In the following table, the Atoms column lists the number of modelled atoms in the group and the number defined in the chemical component dictionary. The B-factors column lists the minimum, median, 95th percentile and maximum values of B factors of atoms in the group. The column labelled ‘Q < 0.9’ lists the number of atoms with occupancy less than 0.9.

Mol	Type	Chain	Res	Atoms	RSCC	RSR	B-factors(\AA^2)	Q<0.9
3	SO4	A	1468	5/5	0.78	0.20	114,114,114,115	0
3	SO4	A	1473	5/5	0.80	0.24	100,101,101,102	0
3	SO4	B	1469	5/5	0.81	0.22	99,99,100,100	0
3	SO4	A	1470	5/5	0.84	0.18	109,109,110,111	0
3	SO4	D	1470	5/5	0.87	0.17	77,78,79,79	0
3	SO4	A	1469	5/5	0.89	0.28	121,122,122,122	0
3	SO4	B	1466	5/5	0.92	0.26	74,76,77,77	0
3	SO4	A	1467	5/5	0.92	0.30	61,62,62,62	0
3	SO4	B	1470	5/5	0.92	0.18	79,79,80,81	0
3	SO4	A	1474	5/5	0.92	0.14	88,88,89,89	0
3	SO4	D	1473	5/5	0.93	0.16	78,78,78,79	0
3	SO4	C	1471	5/5	0.94	0.21	84,85,86,86	0
4	MG	D	1471	1/1	0.94	0.19	10,10,10,10	0
3	SO4	D	1469	5/5	0.95	0.16	63,63,64,65	0
3	SO4	B	1467	5/5	0.95	0.09	70,71,72,72	0
2	HQZ	B	500	10/11	0.96	0.16	42,46,49,50	0
3	SO4	B	1471	5/5	0.96	0.13	108,108,108,108	0
3	SO4	C	1469	5/5	0.96	0.11	73,74,75,75	0
2	HQZ	A	500	10/11	0.96	0.19	39,41,43,47	0
3	SO4	D	1468	5/5	0.97	0.07	61,61,61,62	0
3	SO4	C	1466	5/5	0.97	0.10	65,66,67,68	0
3	SO4	B	1468	5/5	0.97	0.20	59,59,62,63	0
3	SO4	C	1470	5/5	0.97	0.09	61,61,62,63	0
3	SO4	D	1474	5/5	0.97	0.12	61,63,64,65	0
2	HQZ	C	500	10/11	0.97	0.13	34,37,38,39	0
3	SO4	C	1468	5/5	0.98	0.13	51,52,53,54	0
3	SO4	C	1467	5/5	0.98	0.07	59,61,63,64	0
4	MG	A	1471	1/1	0.98	0.19	33,33,33,33	0
4	MG	A	1472	1/1	0.98	0.22	36,36,36,36	0
3	SO4	D	1467	5/5	0.98	0.09	48,48,51,51	0
2	HQZ	D	500	10/11	0.99	0.17	21,25,25,29	0
4	MG	D	1472	1/1	0.99	0.27	2,2,2,2	0

6.5 Other polymers [\(i\)](#)

There are no such residues in this entry.