



Full wwPDB X-ray Structure Validation Report ⓘ

Sep 19, 2023 – 03:45 AM EDT

PDB ID : 5BKN
Title : Crystallographic structure of a cubic crystal form of STMV (84.5 degree rotation) grown from chloride
Authors : McPherson, A.
Deposited on : 2021-03-20
Resolution : 3.00 Å(reported)

This is a Full wwPDB X-ray Structure Validation Report for a publicly released PDB entry.

We welcome your comments at validation@mail.wwpdb.org

A user guide is available at

<https://www.wwpdb.org/validation/2017/XrayValidationReportHelp>

with specific help available everywhere you see the ⓘ symbol.

The types of validation reports are described at

<http://www.wwpdb.org/validation/2017/FAQs#types>.

The following versions of software and data (see [references ⓘ](#)) were used in the production of this report:

MolProbity : 4.02b-467
Xtriage (Phenix) : 1.13
EDS : 2.35.1
buster-report : 1.1.7 (2018)
Percentile statistics : 20191225.v01 (using entries in the PDB archive December 25th 2019)
Refmac : 5.8.0158
CCP4 : 7.0.044 (Gargrove)
Ideal geometry (proteins) : Engh & Huber (2001)
Ideal geometry (DNA, RNA) : Parkinson et al. (1996)
Validation Pipeline (wwPDB-VP) : 2.35.1

1 Overall quality at a glance

The following experimental techniques were used to determine the structure:

X-RAY DIFFRACTION



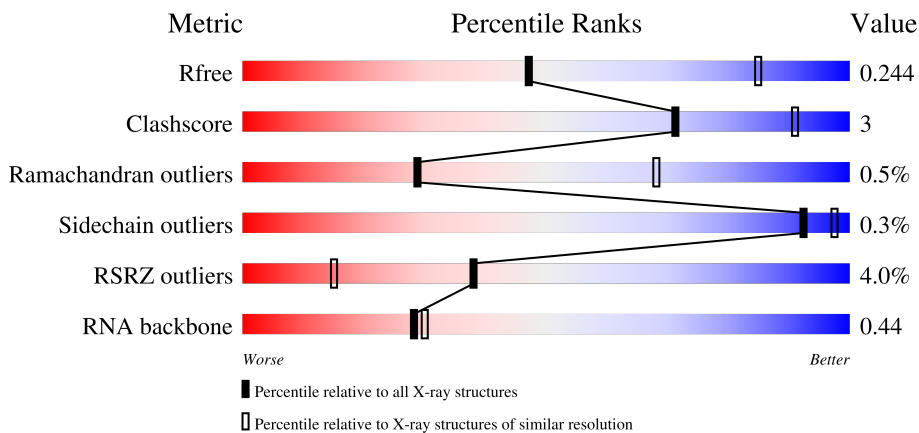

The reported resolution of this entry is 3.00 Å.

Percentile scores (ranging between 0-100) for global validation metrics of the entry are shown in the following graphic. The table shows the number of entries on which the scores are based.



Metric	Whole archive (#Entries)	Similar resolution (#Entries, resolution range(Å))
R_{free}	130704	2092 (3.00-3.00)
Clashscore	141614	2416 (3.00-3.00)
Ramachandran outliers	138981	2333 (3.00-3.00)
Sidechain outliers	138945	2336 (3.00-3.00)
RSRZ outliers	127900	1990 (3.00-3.00)
RNA backbone	3102	1173 (3.30-2.70)

The table below summarises the geometric issues observed across the polymeric chains and their fit to the electron density. The red, orange, yellow and green segments of the lower bar indicate the fraction of residues that contain outliers for ≥ 3 , 2, 1 and 0 types of geometric quality criteria respectively. A grey segment represents the fraction of residues that are not modelled. The numeric value for each fraction is indicated below the corresponding segment, with a dot representing fractions $\leq 5\%$. The upper red bar (where present) indicates the fraction of residues that have poor fit to the electron density. The numeric value is given above the bar.

Mol	Chain	Length	Quality of chain
1	A	159	 89% • 9%
1	B	159	 80% 10% • 9%
1	C	159	 87% • 10%
1	D	159	 89% • 9%

Continued on next page...

Continued from previous page...

Mol	Chain	Length	Quality of chain
1	E	159	86% 9%
1	F	159	87% 9%
1	G	159	87% 8%
1	GG	159	88% 9%
1	H	159	85% 6% 9%
1	HH	159	87% 9%
1	I	159	86% 9%
1	II	159	84% 6% 9%
1	J	159	85% 6% 9%
1	JJ	159	89% 9%
1	K	159	90% 9%
1	KK	159	89% 9%
1	L	159	89% 9% 6%
1	M	159	88% 9%
1	N	159	89% 9%
1	O	159	91% 6%
2	P	8	50% 38% 12%
2	S	8	62% 25% 25% 25%
2	a	8	38% 25% 25% 50%
3	T	6	33% 67% 17% 17%
4	V	9	67% 44% 33% 11% 11%
5	TT	10	90% 10% 30% 20% 10%
5	UU	10	50% 60% 30% 10%
5	X	10	70% 50% 20% 10%
5	Y	10	40% 60% 10% 20% 10%

Continued on next page...

Continued from previous page...

Mol	Chain	Length	Quality of chain
6	e	12	
6	qq	12	
7	h	7	
8	i	6	
8	ll	6	
9	WW	9	
9	kk	9	
9	m	9	
10	n	8	
11	bb	12	

The following table lists non-polymeric compounds, carbohydrate monomers and non-standard residues in protein, DNA, RNA chains that are outliers for geometric or electron-density-fit criteria:

Mol	Type	Chain	Res	Chirality	Geometry	Clashes	Electron density
12	CL	A	201	-	-	-	X
12	CL	E	202	-	-	-	X
12	CL	I	502	-	-	X	-

2 Entry composition

There are 14 unique types of molecules in this entry. The entry contains 50179 atoms, of which 23685 are hydrogens and 0 are deuteriums.

In the tables below, the ZeroOcc column contains the number of atoms modelled with zero occupancy, the AltConf column contains the number of residues with at least one atom in alternate conformation and the Trace column contains the number of residues modelled with at most 2 atoms.

- Molecule 1 is a protein called Coat protein.

Mol	Chain	Residues	Atoms					ZeroOcc	AltConf	Trace	
			Total	C	H	N	O				S
1	A	144	2278	716	1145	200	210	7	0	13	0
1	B	144	2218	707	1095	199	210	7	0	11	0
1	C	143	2239	708	1115	199	210	7	0	20	0
1	D	144	2258	712	1128	200	211	7	0	18	0
1	E	144	2242	712	1112	200	211	7	0	19	0
1	F	144	2298	723	1152	202	214	7	0	17	0
1	G	146	2264	720	1120	202	215	7	0	13	0
1	H	145	2311	729	1157	203	215	7	0	19	0
1	I	144	2259	711	1130	200	211	7	0	13	0
1	J	144	2265	717	1127	201	213	7	0	13	0
1	K	145	2320	729	1160	207	218	6	1	12	0
1	L	156	2429	786	1181	223	232	7	2	13	0
1	M	144	2339	733	1178	204	217	7	1	11	0
1	N	144	2276	717	1138	200	214	7	0	6	0
1	O	149	2297	733	1129	206	222	7	0	24	0
1	GG	145	2254	711	1123	200	213	7	0	19	0

Continued on next page...

Continued from previous page...

Mol	Chain	Residues	Atoms					ZeroOcc	AltConf	Trace	
1	HH	144	Total	C	H	N	O	S	0	14	0
			2262	713	1132	199	211	7			
1	II	144	Total	C	H	N	O	S	0	12	0
			2200	707	1077	199	210	7			
1	JJ	144	Total	C	H	N	O	S	0	16	0
			2230	703	1112	199	210	6			
1	KK	144	Total	C	H	N	O	S	0	14	0
			2247	707	1124	199	210	7			

- Molecule 2 is a RNA chain called RNA (5'-R(P*AP*AP*AP*AP*AP*AP*AP*A)-3').

Mol	Chain	Residues	Atoms					ZeroOcc	AltConf	Trace	
2	P	7	Total	C	H	N	O	P	0	7	0
			220	70	66	35	42	7			
2	S	6	Total	C	H	N	O	P	0	6	0
			187	60	55	30	36	6			
2	a	4	Total	C	H	N	O	P	0	4	0
			132	40	44	20	24	4			

- Molecule 3 is a RNA chain called RNA (5'-R(P*AP*AP*AP*AP*AP*A)-3').

Mol	Chain	Residues	Atoms					ZeroOcc	AltConf	Trace	
3	T	5	Total	C	H	N	O	P	0	5	0
			156	50	46	25	30	5			

- Molecule 4 is a RNA chain called RNA (5'-R(P*AP*AP*AP*AP*AP*AP*AP*A)-3').

Mol	Chain	Residues	Atoms					ZeroOcc	AltConf	Trace	
4	V	8	Total	C	H	N	O	P	0	6	0
			233	80	57	40	48	8			

- Molecule 5 is a RNA chain called RNA (5'-R(P*AP*AP*AP*AP*AP*AP*AP*AP*A)-3').

Mol	Chain	Residues	Atoms					ZeroOcc	AltConf	Trace	
5	X	9	Total	C	H	N	O	P	0	8	0
			286	90	88	45	54	9			
5	Y	9	Total	C	H	N	O	P	0	6	0
			258	90	60	45	54	9			
5	TT	9	Total	C	H	N	O	P	0	6	0
			258	90	60	45	54	9			

Continued on next page...

Continued from previous page...

Mol	Chain	Residues	Atoms					ZeroOcc	AltConf	Trace	
5	UU	9	Total	C	H	N	O	P	0	7	0
			261	90	63	45	54	9			

- Molecule 6 is a RNA chain called RNA (5'-R(P*UP*UP*UP*UP*UP*UP*UP*UP*UP*UP*U)-3').

Mol	Chain	Residues	Atoms					ZeroOcc	AltConf	Trace	
6	e	11	Total	C	H	N	O	P	0	10	0
			300	99	80	22	88	11			
6	qq	6	Total	C	H	N	O	P	0	4	0
			152	54	32	12	48	6			

- Molecule 7 is a RNA chain called RNA (5'-R(P*UP*UP*UP*UP*UP*UP*U)-3').

Mol	Chain	Residues	Atoms					ZeroOcc	AltConf	Trace	
7	h	6	Total	C	H	N	O	P	0	6	0
			169	54	49	12	48	6			

- Molecule 8 is a RNA chain called RNA (5'-R(P*UP*UP*UP*UP*UP*U)-3').

Mol	Chain	Residues	Atoms					ZeroOcc	AltConf	Trace	
8	i	5	Total	C	H	N	O	P	0	5	0
			140	45	40	10	40	5			
8	ll	5	Total	C	H	N	O	P	0	5	0
			140	45	40	10	40	5			

- Molecule 9 is a RNA chain called RNA (5'-R(P*UP*UP*UP*UP*UP*UP*UP*U)-3').

Mol	Chain	Residues	Atoms					ZeroOcc	AltConf	Trace	
9	m	8	Total	C	H	N	O	P	0	8	0
			240	72	80	16	64	8			
9	WW	8	Total	C	H	N	O	P	0	2	0
			171	72	11	16	64	8			
9	kk	8	Total	C	H	N	O	P	0	6	0
			209	72	49	16	64	8			

- Molecule 10 is a RNA chain called RNA (5'-R(P*UP*UP*UP*UP*UP*UP*U)-3').

Mol	Chain	Residues	Atoms					ZeroOcc	AltConf	Trace	
10	n	7	Total	C	H	N	O	P	0	7	0
			198	63	58	14	56	7			

- Molecule 11 is a RNA chain called RNA (5'-R(P*AP*AP*AP*AP*AP*AP*AP*AP*A P*AP*A)-3').

Mol	Chain	Residues	Atoms						ZeroOcc	AltConf	Trace
			Total	C	H	N	O	P			
11	bb	11	314	110	72	55	66	11	0	8	0

- Molecule 12 is CHLORIDE ION (three-letter code: CL) (formula: Cl) (labeled as "Ligand of Interest" by depositor).

Mol	Chain	Residues	Atoms		ZeroOcc	AltConf
12	A	2	Total	Cl	0	0
			2	2		
12	B	2	Total	Cl	0	0
			2	2		
12	E	2	Total	Cl	0	0
			2	2		
12	F	2	Total	Cl	0	0
			2	2		
12	H	3	Total	Cl	0	0
			3	3		
12	I	2	Total	Cl	0	0
			2	2		
12	J	1	Total	Cl	0	0
			1	1		
12	K	1	Total	Cl	0	0
			1	1		
12	M	5	Total	Cl	0	0
			5	5		
12	O	1	Total	Cl	0	0
			1	1		
12	S	1	Total	Cl	0	0
			1	1		
12	n	1	Total	Cl	0	0
			1	1		
12	GG	2	Total	Cl	0	0
			2	2		
12	KK	1	Total	Cl	0	0
			1	1		

- Molecule 13 is MAGNESIUM ION (three-letter code: MG) (formula: Mg).

Mol	Chain	Residues	Atoms		ZeroOcc	AltConf
13	A	1	Total	Mg	0	0
			1	1		

Continued on next page...

Continued from previous page...

Mol	Chain	Residues	Atoms		ZeroOcc	AltConf
13	B	1	Total 1	Mg 1	0	0
13	F	1	Total 1	Mg 1	0	0
13	G	1	Total 1	Mg 1	0	0
13	H	1	Total 1	Mg 1	0	0
13	J	1	Total 1	Mg 1	0	0
13	K	3	Total 3	Mg 3	0	0
13	L	1	Total 1	Mg 1	0	0
13	M	1	Total 1	Mg 1	0	0
13	O	1	Total 1	Mg 1	0	0
13	II	1	Total 1	Mg 1	0	0
13	JJ	1	Total 1	Mg 1	0	0

- Molecule 14 is water.

Mol	Chain	Residues	Atoms		ZeroOcc	AltConf
14	A	51	Total 51	O 51	0	0
14	B	33	Total 33	O 33	0	0
14	C	17	Total 17	O 17	0	0
14	D	30	Total 30	O 30	0	0
14	E	30	Total 30	O 30	0	0
14	F	25	Total 25	O 25	0	0
14	G	24	Total 24	O 24	0	0
14	H	24	Total 24	O 24	0	0

Continued on next page...

Continued from previous page...

Mol	Chain	Residues	Atoms	ZeroOcc	AltConf
14	I	14	Total O 14 14	0	0
14	J	36	Total O 36 36	0	0
14	K	32	Total O 32 32	0	0
14	L	35	Total O 35 35	0	0
14	M	28	Total O 28 28	0	0
14	N	22	Total O 22 22	0	0
14	O	56	Total O 56 56	0	0
14	P	6	Total O 6 6	0	0
14	S	2	Total O 2 2	0	0
14	T	3	Total O 3 3	0	0
14	V	1	Total O 1 1	0	0
14	X	2	Total O 2 2	0	0
14	Y	4	Total O 4 4	0	0
14	a	5	Total O 5 5	0	0
14	e	3	Total O 3 3	0	0
14	h	1	Total O 1 1	0	0
14	i	1	Total O 1 1	0	0
14	m	5	Total O 5 5	0	0
14	n	3	Total O 3 3	0	0
14	GG	22	Total O 22 22	0	0
14	HH	29	Total O 29 29	0	0

Continued on next page...

Continued from previous page...

Mol	Chain	Residues	Atoms	ZeroOcc	AltConf
14	II	20	Total O 20 20	0	0
14	JJ	11	Total O 11 11	0	0
14	KK	2	Total O 2 2	0	0
14	TT	2	Total O 2 2	0	0
14	UU	18	Total O 18 18	0	0
14	WW	4	Total O 4 4	0	0
14	bb	27	Total O 27 27	0	0
14	kk	1	Total O 1 1	0	0

3 Residue-property plots [i](#)

These plots are drawn for all protein, RNA, DNA and oligosaccharide chains in the entry. The first graphic for a chain summarises the proportions of the various outlier classes displayed in the second graphic. The second graphic shows the sequence view annotated by issues in geometry and electron density. Residues are color-coded according to the number of geometric quality criteria for which they contain at least one outlier: green = 0, yellow = 1, orange = 2 and red = 3 or more. A red dot above a residue indicates a poor fit to the electron density ($RSRZ > 2$). Stretches of 2 or more consecutive residues without any outlier are shown as a green connector. Residues present in the sample, but not in the model, are shown in grey.

- Molecule 1: Coat protein

Chain A:  89% 9%

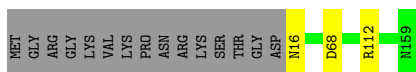

- Molecule 1: Coat protein

Chain B:  80% 10% 9%



- Molecule 1: Coat protein

Chain C:  87% 10%

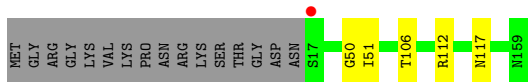

- Molecule 1: Coat protein

Chain D:  89% 9%

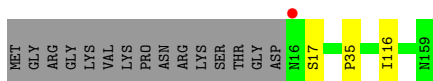

- Molecule 1: Coat protein

Chain E:  86% 9%

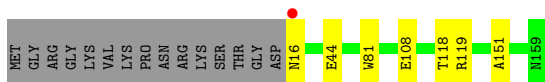

- Molecule 1: Coat protein

Chain F:  87% 9%



• Molecule 1: Coat protein

Chain G:  2% 87% 8%

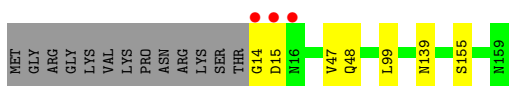

• Molecule 1: Coat protein

Chain H:  1% 85% 6% 9%



• Molecule 1: Coat protein

Chain I:  86% 9%

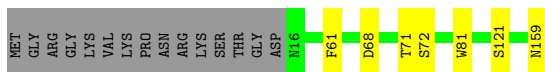

• Molecule 1: Coat protein

Chain J:  85% 6% 9%

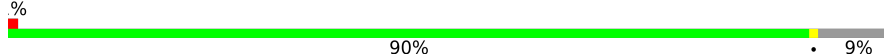

• Molecule 1: Coat protein

Chain K:  90% 9%

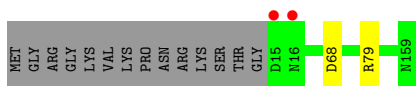

• Molecule 1: Coat protein

Chain L:  6% 89% 9%

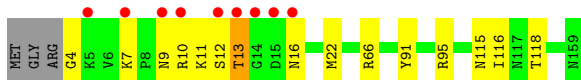

• Molecule 1: Coat protein

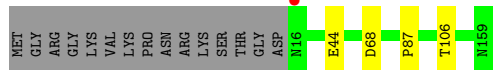
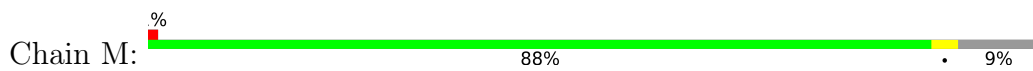

• Molecule 1: Coat protein

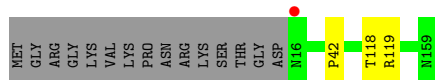
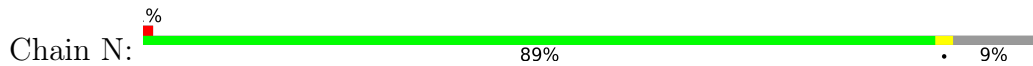

• Molecule 1: Coat protein

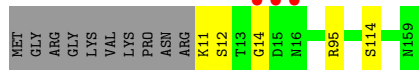
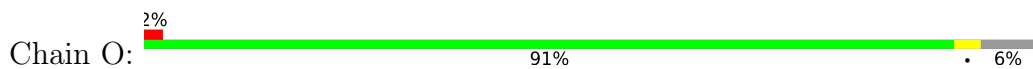

• Molecule 1: Coat protein

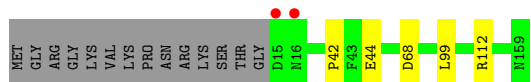
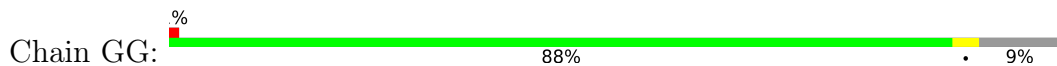

• Molecule 1: Coat protein

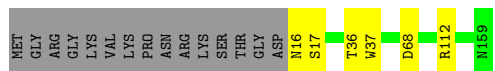
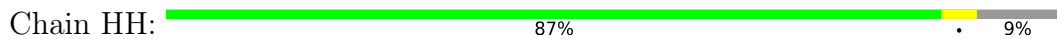

• Molecule 1: Coat protein

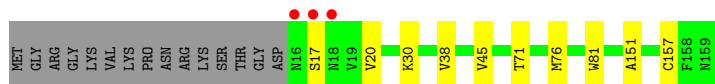
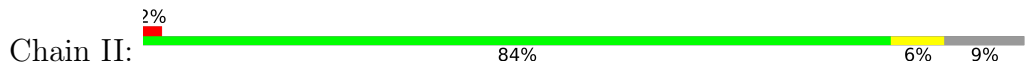

• Molecule 1: Coat protein

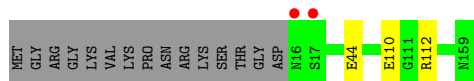
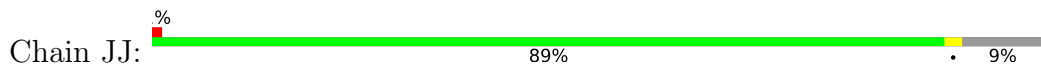

- Molecule 1: Coat protein

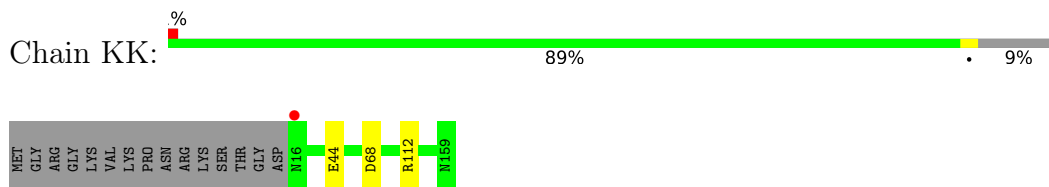

- Molecule 2: RNA (5'-R(P*AP*AP*AP*AP*AP*AP*AP*A)-3')



- Molecule 2: RNA (5'-R(P*AP*AP*AP*AP*AP*AP*AP*A)-3')

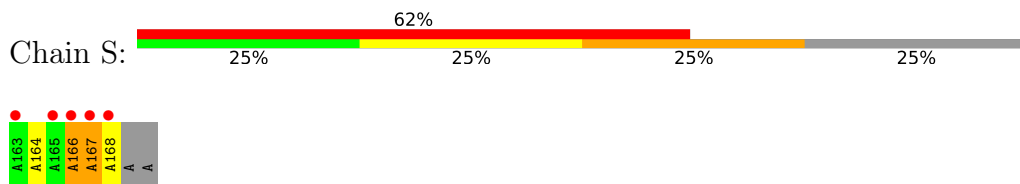

- Molecule 2: RNA (5'-R(P*AP*AP*AP*AP*AP*AP*AP*A)-3')

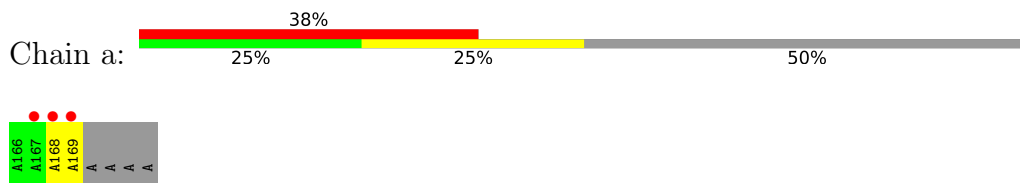

- Molecule 3: RNA (5'-R(P*AP*AP*AP*AP*AP*A)-3')

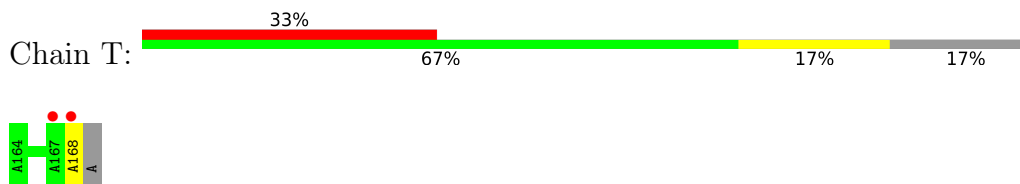

- Molecule 4: RNA (5'-R(P*AP*AP*AP*AP*AP*AP*AP*AP*A)-3')

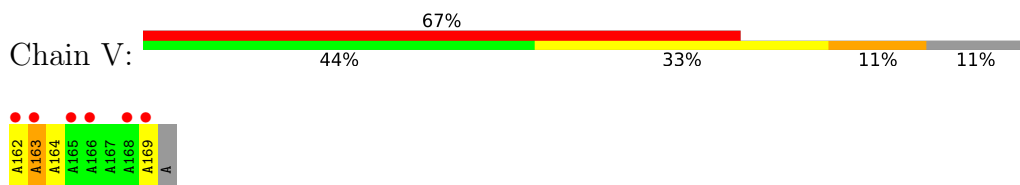

- Molecule 5: RNA (5'-R(P*AP*AP*AP*AP*AP*AP*AP*AP*AP*A)-3')



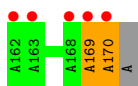

- Molecule 5: RNA (5'-R(P*AP*AP*AP*AP*AP*AP*AP*AP*AP*A)-3')

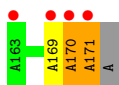
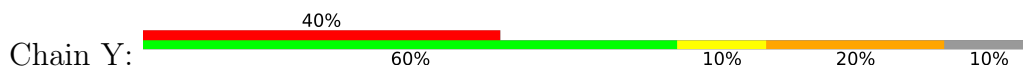

- Molecule 5: RNA (5'-R(P*AP*AP*AP*AP*AP*AP*AP*AP*AP*A)-3')

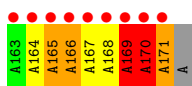
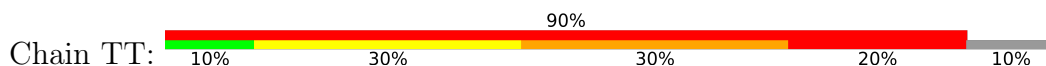

- Molecule 5: RNA (5'-R(P*AP*AP*AP*AP*AP*AP*AP*AP*AP*A)-3')

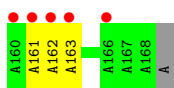

- Molecule 6: RNA (5'-R(P*UP*UP*UP*UP*UP*UP*UP*UP*UP*UP*UP*U)-3')

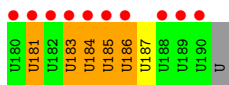
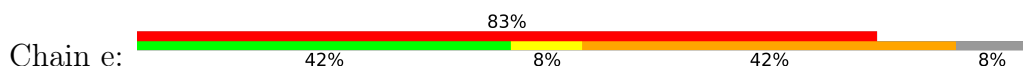

- Molecule 6: RNA (5'-R(P*UP*UP*UP*UP*UP*UP*UP*UP*UP*UP*UP*U)-3')

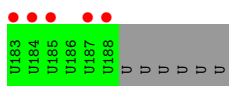
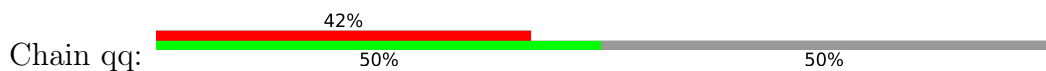

- Molecule 7: RNA (5'-R(P*UP*UP*UP*UP*UP*UP*U)-3')

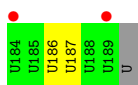

- Molecule 8: RNA (5'-R(P*UP*UP*UP*UP*UP*U)-3')



- Molecule 8: RNA (5'-R(P*UP*UP*UP*UP*UP*U)-3')



- Molecule 9: RNA (5'-R(P*UP*UP*UP*UP*UP*UP*UP*UP*U)-3')

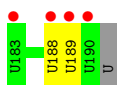
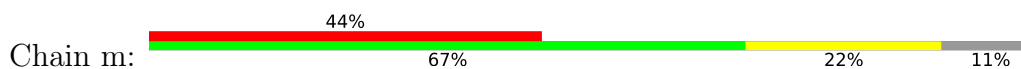

- Molecule 9: RNA (5'-R(P*UP*UP*UP*UP*UP*UP*UP*UP*U)-3')



- Molecule 9: RNA (5'-R(P*UP*UP*UP*UP*UP*UP*UP*UP*U)-3')

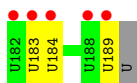

- Molecule 10: RNA (5'-R(P*UP*UP*UP*UP*UP*UP*UP*U)-3')

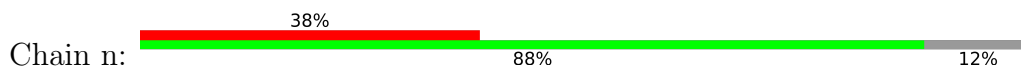

- Molecule 11: RNA (5'-R(P*AP*AP*AP*AP*AP*AP*AP*AP*AP*AP*AP*A)-3')

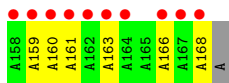
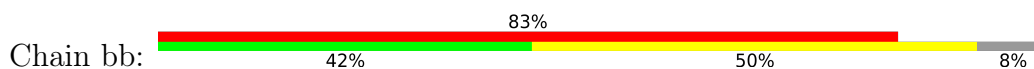

4 Data and refinement statistics

Property	Value	Source
Space group	P 2 3	Depositor
Cell constants a, b, c, α , β , γ	234.65Å 234.65Å 234.65Å 90.00° 90.00° 90.00°	Depositor
Resolution (Å)	65.08 – 3.00 104.94 – 3.00	Depositor EDS
% Data completeness (in resolution range)	99.5 (65.08-3.00) 92.0 (104.94-3.00)	Depositor EDS
R_{merge}	0.13	Depositor
R_{sym}	0.13	Depositor
$\langle I/\sigma(I) \rangle$ ¹	2.42 (at 3.01Å)	Xtrriage
Refinement program	PHENIX 1.19_4092	Depositor
R, R_{free}	0.208 , 0.255 0.199 , 0.244	Depositor DCC
R_{free} test set	4529 reflections (5.27%)	wwPDB-VP
Wilson B-factor (Å ²)	39.1	Xtrriage
Anisotropy	0.000	Xtrriage
Bulk solvent k_{sol} (e/Å ³), B_{sol} (Å ²)	0.35 , 36.1	EDS
L-test for twinning ²	$\langle L \rangle = 0.49$, $\langle L^2 \rangle = 0.32$	Xtrriage
Estimated twinning fraction	0.024 for l,-k,h	Xtrriage
F_o, F_c correlation	0.90	EDS
Total number of atoms	50179	wwPDB-VP
Average B, all atoms (Å ²)	48.0	wwPDB-VP

Xtrriage's analysis on translational NCS is as follows: *The largest off-origin peak in the Patterson function is 1.95% of the height of the origin peak. No significant pseudotranslation is detected.*

¹Intensities estimated from amplitudes.

²Theoretical values of $\langle |L| \rangle$, $\langle L^2 \rangle$ for acentric reflections are 0.5, 0.333 respectively for untwinned datasets, and 0.375, 0.2 for perfectly twinned datasets.

5 Model quality i

5.1 Standard geometry i

Bond lengths and bond angles in the following residue types are not validated in this section: MG, CL

The Z score for a bond length (or angle) is the number of standard deviations the observed value is removed from the expected value. A bond length (or angle) with $|Z| > 5$ is considered an outlier worth inspection. RMSZ is the root-mean-square of all Z scores of the bond lengths (or angles).

Mol	Chain	Bond lengths		Bond angles	
		RMSZ	# $ Z > 5$	RMSZ	# $ Z > 5$
1	A	0.34	0/1181	0.55	0/1608
1	B	0.35	0/1150	0.56	0/1566
1	C	0.32	0/1151	0.54	0/1567
1	D	0.33	0/1166	0.53	0/1588
1	E	0.33	0/1184	0.54	0/1612
1	F	0.33	0/1222	0.54	0/1665
1	G	0.32	0/1189	0.54	0/1619
1	GG	0.31	0/1174	0.54	0/1599
1	H	0.35	0/1218	0.56	0/1660
1	HH	0.32	0/1187	0.53	0/1617
1	I	0.34	0/1167	0.55	0/1589
1	II	0.32	0/1171	0.53	0/1595
1	J	0.36	0/1189	0.54	0/1617
1	JJ	0.31	0/1142	0.55	0/1556
1	K	0.32	0/1230	0.53	0/1675
1	KK	0.30	0/1177	0.52	0/1602
1	L	0.35	0/1332	0.56	0/1809
1	M	0.34	0/1231	0.54	0/1675
1	N	0.34	0/1186	0.55	0/1614
1	O	0.35	0/1201	0.55	0/1634
2	P	0.32	0/174	0.74	0/269
2	S	0.43	0/149	0.87	0/230
2	a	0.43	0/99	0.95	0/152
3	T	0.43	0/124	0.71	0/191
4	V	0.34	0/199	0.75	0/308
5	TT	1.02	2/224 (0.9%)	2.85	11/347 (3.2%)
5	UU	0.29	0/224	0.75	0/347
5	X	0.35	0/224	0.72	0/347
5	Y	0.34	0/224	0.71	0/347
6	e	0.91	0/241	3.56	25/370 (6.8%)
6	qq	0.31	0/131	1.06	0/200
7	h	0.27	0/131	0.78	0/200

Mol	Chain	Bond lengths		Bond angles	
		RMSZ	# Z >5	RMSZ	# Z >5
8	i	0.37	0/109	1.02	0/166
8	ll	0.34	0/109	0.76	0/166
9	WW	0.29	0/175	1.02	2/268 (0.7%)
9	kk	0.27	0/175	0.74	0/268
9	m	0.24	0/175	0.79	0/268
10	n	0.26	0/153	0.73	0/234
11	bb	0.25	0/274	0.67	0/425
All	All	0.35	2/27162 (0.0%)	0.73	38/37570 (0.1%)

Chiral center outliers are detected by calculating the chiral volume of a chiral center and verifying if the center is modelled as a planar moiety or with the opposite hand. A planarity outlier is detected by checking planarity of atoms in a peptide group, atoms in a mainchain group or atoms of a sidechain that are expected to be planar.

Mol	Chain	#Chirality outliers	#Planarity outliers
1	B	0	1

All (2) bond length outliers are listed below:

Mol	Chain	Res	Type	Atoms	Z	Observed(Å)	Ideal(Å)
5	TT	166[A]	A	C5'-C4'	8.04	1.61	1.51
5	TT	166[A]	A	N9-C4	6.26	1.41	1.37

All (38) bond angle outliers are listed below:

Mol	Chain	Res	Type	Atoms	Z	Observed(°)	Ideal(°)
5	TT	166[A]	A	O5'-P-OP2	-38.53	64.46	110.70
6	e	184[A]	U	O5'-P-OP1	-31.59	72.79	110.70
6	e	184[A]	U	O5'-P-OP2	-23.84	82.09	110.70
6	e	185[A]	U	O4'-C1'-N1	20.01	124.21	108.20
6	e	185[A]	U	C2-N1-C1'	17.27	138.43	117.70
6	e	185[A]	U	C6-N1-C2	-16.54	111.08	121.00
5	TT	165	A	OP2-P-O3'	-16.14	69.69	105.20
6	e	185[A]	U	C5-C6-N1	15.35	130.38	122.70
6	e	183[A]	U	OP1-P-O3'	-13.33	75.87	105.20
6	e	184[A]	U	OP1-P-OP2	12.62	138.53	119.60
5	TT	166[A]	A	O4'-C1'-N9	11.96	117.76	108.20
5	TT	169[A]	A	OP1-P-O3'	-10.78	81.49	105.20
5	TT	169[A]	A	OP2-P-O3'	-9.33	84.67	105.20
6	e	185[A]	U	N3-C4-C5	-8.58	109.45	114.60
6	e	186[A]	U	O5'-P-OP1	-8.50	98.05	105.70
5	TT	170[A]	A	OP1-P-OP2	8.32	132.08	119.60

Continued on next page...

Continued from previous page...

Mol	Chain	Res	Type	Atoms	Z	Observed(°)	Ideal(°)
6	e	185[A]	U	C5-C4-O4	8.31	130.89	125.90
6	e	183[A]	U	OP2-P-O3'	-8.23	87.10	105.20
6	e	185[A]	U	N1-C2-N3	8.13	119.78	114.90
6	e	184[A]	U	N3-C2-O2	8.08	127.86	122.20
5	TT	165	A	O3'-P-O5'	7.85	118.92	104.00
6	e	185[A]	U	C6-N1-C1'	-7.73	110.38	121.20
6	e	181[A]	U	OP1-P-OP2	-7.54	108.30	119.60
6	e	185[A]	U	O5'-C5'-C4'	7.11	125.21	111.70
6	e	185[A]	U	C5'-C4'-O4'	7.01	117.51	109.10
5	TT	166[A]	A	O4'-C4'-C3'	-6.73	97.27	104.00
6	e	183[A]	U	O3'-P-O5'	6.59	116.52	104.00
5	TT	166[A]	A	OP1-P-OP2	-6.24	110.24	119.60
9	WW	166[A]	U	N3-C2-O2	-5.71	118.20	122.20
6	e	185[A]	U	C1'-O4'-C4'	-5.66	105.37	109.90
6	e	185[A]	U	C2-N3-C4	5.63	130.38	127.00
6	e	185[A]	U	O5'-P-OP2	5.55	117.36	110.70
9	WW	166[A]	U	C2-N1-C1'	5.37	124.15	117.70
6	e	186[A]	U	O4'-C1'-N1	-5.27	103.98	108.20
5	TT	166[A]	A	O5'-P-OP1	5.25	116.99	110.70
6	e	185[A]	U	O4'-C1'-C2'	-5.24	100.56	105.80
5	TT	166[A]	A	P-O5'-C5'	-5.12	112.71	120.90
6	e	186[A]	U	P-O3'-C3'	5.03	125.74	119.70

There are no chirality outliers.

All (1) planarity outliers are listed below:

Mol	Chain	Res	Type	Group
1	B	24	ARG	Sidechain

5.2 Too-close contacts [\(i\)](#)

In the following table, the Non-H and H(model) columns list the number of non-hydrogen atoms and hydrogen atoms in the chain respectively. The H(added) column lists the number of hydrogen atoms added and optimized by MolProbity. The Clashes column lists the number of clashes within the asymmetric unit, whereas Symm-Clashes lists symmetry-related clashes.

Mol	Chain	Non-H	H(model)	H(added)	Clashes	Symm-Clashes
1	A	1133	1145	1105	2	0
1	B	1123	1095	1108	9	0
1	C	1124	1115	1079	5	0
1	D	1130	1128	1091	3	0

Continued on next page...

Continued from previous page...

Mol	Chain	Non-H	H(model)	H(added)	Clashes	Symm-Clashes
1	E	1130	1112	1075	5	0
1	F	1146	1152	1086	5	0
1	G	1144	1120	1112	7	0
1	GG	1131	1123	1057	4	0
1	H	1154	1157	1106	6	0
1	HH	1130	1132	1096	5	0
1	I	1129	1130	1096	6	0
1	II	1123	1077	1095	6	0
1	J	1138	1127	1118	9	0
1	JJ	1118	1112	1079	2	0
1	K	1160	1160	1120	2	0
1	KK	1123	1124	1075	3	0
1	L	1248	1181	1236	13	0
1	M	1161	1178	1159	4	0
1	N	1138	1138	1136	2	0
1	O	1168	1129	1113	5	0
2	P	154	66	78	5	0
2	S	132	55	67	4	0
2	a	88	44	45	0	0
3	T	110	46	56	0	0
4	V	176	57	89	4	0
5	TT	198	60	100	5	0
5	UU	198	63	100	2	0
5	X	198	88	100	1	0
5	Y	198	60	100	4	0
6	e	220	80	111	0	0
6	qq	120	32	61	0	0
7	h	120	49	61	0	0
8	i	100	40	51	0	0
8	ll	100	40	51	0	0
9	WW	160	11	75	7	0
9	kk	160	49	81	0	2
9	m	160	80	81	0	0
10	n	140	58	71	0	0
11	bb	242	72	122	0	0
12	A	2	0	0	1	0
12	B	2	0	0	0	0
12	E	2	0	0	0	0
12	F	2	0	0	0	0
12	GG	2	0	0	0	0
12	H	3	0	0	1	0
12	I	2	0	0	3	0

Continued on next page...

Continued from previous page...

Mol	Chain	Non-H	H(model)	H(added)	Clashes	Symm-Clashes
12	J	1	0	0	0	0
12	K	1	0	0	0	0
12	KK	1	0	0	0	0
12	M	5	0	0	1	0
12	O	1	0	0	1	0
12	S	1	0	0	1	0
12	n	1	0	0	0	0
13	A	1	0	0	0	0
13	B	1	0	0	0	0
13	F	1	0	0	0	0
13	G	1	0	0	0	0
13	H	1	0	0	0	0
13	II	1	0	0	0	0
13	J	1	0	0	0	0
13	JJ	1	0	0	0	0
13	K	3	0	0	0	0
13	L	1	0	0	0	0
13	M	1	0	0	0	0
13	O	1	0	0	0	0
14	A	51	0	0	1	1
14	B	33	0	0	1	2
14	C	17	0	0	0	0
14	D	30	0	0	0	0
14	E	30	0	0	2	0
14	F	25	0	0	0	0
14	G	24	0	0	2	0
14	GG	22	0	0	2	0
14	H	24	0	0	2	0
14	HH	29	0	0	1	1
14	I	14	0	0	2	0
14	II	20	0	0	1	0
14	J	36	0	0	1	0
14	JJ	11	0	0	0	0
14	K	32	0	0	1	0
14	KK	2	0	0	0	0
14	L	35	0	0	4	1
14	M	28	0	0	1	1
14	N	22	0	0	0	0
14	O	56	0	0	1	0
14	P	6	0	0	2	0
14	S	2	0	0	1	0
14	T	3	0	0	0	0

Continued on next page...

Continued from previous page...

Mol	Chain	Non-H	H(model)	H(added)	Clashes	Symm-Clashes
14	TT	2	0	0	0	0
14	UU	18	0	0	0	0
14	V	1	0	0	0	0
14	WW	4	0	0	1	0
14	X	2	0	0	0	0
14	Y	4	0	0	2	0
14	a	5	0	0	0	0
14	bb	27	0	0	0	0
14	e	3	0	0	0	0
14	h	1	0	0	0	0
14	i	1	0	0	0	0
14	kk	1	0	0	0	0
14	m	5	0	0	0	0
14	n	3	0	0	0	0
All	All	26494	23685	23642	117	4

The all-atom clashscore is defined as the number of clashes found per 1000 atoms (including hydrogen atoms). The all-atom clashscore for this structure is 3.

All (117) close contacts within the same asymmetric unit are listed below, sorted by their clash magnitude.

Atom-1	Atom-2	Interatomic distance (Å)	Clash overlap (Å)
1:L:4:GLY:N	14:L:301:HOH:O	1.95	0.96
2:S:164[A]:A:O2'	12:S:201:CL:CL	2.21	0.95
9:WW:167[A]:U:H2'	9:WW:168:U:H5''	1.47	0.95
1:M:68[B]:ASP:OD1	14:M:601:HOH:O	1.88	0.90
1:J:148:ARG:NH1	14:J:1401:HOH:O	2.05	0.88
1:J:57:VAL:HG21	1:J:134:THR:HG21	1.60	0.83
9:WW:165:U:O2	14:WW:201:HOH:O	1.95	0.83
1:GG:99:LEU:O	14:GG:301:HOH:O	1.98	0.81
2:S:166[A]:A:O2'	1:II:38:VAL:O	1.97	0.81
1:L:66:ARG:NH2	1:M:106:THR:OG1	2.14	0.80
1:H:138:ASP:O	14:H:301:HOH:O	2.01	0.79
1:G:139[B]:ASN:ND2	14:G:302:HOH:O	2.15	0.78
1:O:11:LYS:HA	1:O:12:SER:HB2	1.68	0.75
2:S:167[A]:A:OP2	14:S:301:HOH:O	2.05	0.75
1:B:90:GLU:O	14:B:301:HOH:O	2.05	0.74
1:G:155[A]:SER:OG	9:WW:169:U:OP1	2.06	0.73
1:H:61:PHE:O	14:H:302:HOH:O	2.04	0.73
1:J:57:VAL:HG21	1:J:134:THR:CG2	2.17	0.73
5:TT:170[A]:A:O2'	5:TT:171:A:O5'	2.07	0.73

Continued on next page...

Continued from previous page...

Atom-1	Atom-2	Interatomic distance (Å)	Clash overlap (Å)
1:I:68:ASP:OD1	14:I:601:HOH:O	2.08	0.72
1:E:108:GLU:OE2	14:E:301:HOH:O	2.09	0.70
1:GG:68[A]:ASP:OD1	14:GG:302:HOH:O	2.09	0.69
5:TT:165:A:H2'	5:TT:165:A:N3	2.07	0.69
1:I:61:PHE:O	14:I:602:HOH:O	2.11	0.69
1:HH:68:ASP:OD2	14:HH:201:HOH:O	2.11	0.67
1:G:139[B]:ASN:OD1	14:G:301:HOH:O	2.13	0.65
2:P:164[A]:A:O2'	14:P:201:HOH:O	2.14	0.64
5:TT:170[A]:A:HO2'	5:TT:171:A:C5'	2.10	0.64
1:A:68:ASP:OD1	14:A:301:HOH:O	2.15	0.63
1:H:121:SER:O	1:H:122:VAL:HG12	1.98	0.63
1:L:10:ARG:HA	14:L:316:HOH:O	1.96	0.63
1:L:10:ARG:O	1:L:10:ARG:HG3	2.00	0.62
1:L:10:ARG:HD2	14:L:316:HOH:O	2.00	0.61
1:I:71:THR:N	12:I:502:CL:CL	2.65	0.60
1:E:16:ASN:ND2	14:E:302:HOH:O	2.34	0.60
9:WW:167[A]:U:H2'	9:WW:168:U:C5'	2.25	0.60
1:L:7:LYS:HE2	1:L:22[A]:MET:HE3	1.85	0.58
1:K:68[A]:ASP:OD1	14:K:401:HOH:O	2.17	0.57
4:V:162:A:H2'	4:V:163:A:C8	2.38	0.57
1:O:95:ARG:NH1	14:O:302:HOH:O	2.38	0.56
5:Y:170:A:N7	14:Y:201:HOH:O	2.33	0.56
1:G:14:GLY:N	5:UU:163[A]:A:HO2'	2.05	0.55
1:J:99:LEU:HG	1:J:141:CYS:HA	1.87	0.55
1:O:95:ARG:HD3	12:O:201:CL:CL	2.45	0.54
1:B:66:ARG:HH22	1:C:106:THR:HB	1.73	0.54
1:F:16:ASN:N	1:F:16:ASN:HD22	2.06	0.54
1:H:57:VAL:HG22	1:H:140[A]:VAL:HG22	1.90	0.53
1:L:10:ARG:HH12	1:L:12:SER:CB	2.22	0.53
4:V:162:A:O2'	4:V:163:A:O5'	2.22	0.52
1:L:10:ARG:NH1	1:L:12:SER:HB2	2.24	0.52
1:I:72:SER:N	12:I:502:CL:CL	2.80	0.51
1:G:99:LEU:HD13	1:G:139[B]:ASN:ND2	2.25	0.51
1:HH:16:ASN:OD1	1:HH:17:SER:N	2.41	0.51
1:F:25:ALA:O	1:II:30:LYS:NZ	2.44	0.51
1:C:106:THR:O	1:C:106:THR:HG22	2.10	0.50
1:B:19:VAL:HG22	1:B:20:VAL:H	1.77	0.50
1:J:17:SER:HA	2:P:164[A]:A:H4'	1.93	0.50
1:L:7:LYS:HE2	1:L:22[A]:MET:CE	2.42	0.50
5:UU:161:A:H2'	5:UU:161:A:N3	2.27	0.49
2:P:166[A]:A:OP1	14:P:202:HOH:O	2.20	0.49

Continued on next page...

Continued from previous page...

Atom-1	Atom-2	Interatomic distance (Å)	Clash overlap (Å)
1:K:79[B]:ARG:NH2	5:Y:169:A:OP1	2.44	0.49
1:B:73:VAL:HG22	1:B:156:CYS:HB2	1.95	0.49
1:B:81:TRP:O	1:B:151:ALA:N	2.44	0.48
1:H:105[A]:SER:HB3	1:H:107:GLU:OE1	2.13	0.48
1:G:14:GLY:HA2	1:G:15:ASP:HA	1.57	0.48
5:TT:169[A]:A:C2'	5:TT:170[A]:A:OP2	2.62	0.47
1:N:118:THR:HG22	1:N:119:ARG:N	2.29	0.47
1:II:71:THR:HG21	14:II:310:HOH:O	2.14	0.47
1:HH:36:THR:HG22	1:HH:37:TRP:N	2.29	0.47
1:L:115:ASN:O	1:L:118:THR:HG22	2.15	0.46
1:L:10:ARG:NH1	1:L:12:SER:CB	2.78	0.46
1:D:35:PRO:HB2	2:S:166[A]:A:H5'	1.97	0.46
1:H:25:ALA:HB1	12:H:201:CL:CL	2.53	0.46
1:C:50:GLY:O	1:C:51:ILE:HD13	2.15	0.46
1:D:17:SER:HA	4:V:164[A]:A:H4'	1.98	0.45
1:E:81:TRP:O	1:E:151:ALA:N	2.50	0.45
1:B:44:GLU:OE2	1:C:112:ARG:NH2	2.43	0.45
1:F:47[B]:VAL:HG23	1:F:147:CYS:O	2.16	0.45
1:B:19:VAL:HG22	1:B:20:VAL:N	2.32	0.45
1:HH:36:THR:HG22	1:HH:37:TRP:H	1.81	0.45
1:L:95:ARG:NH2	14:L:303:HOH:O	2.32	0.44
1:GG:44:GLU:OE2	1:HH:112:ARG:NH2	2.43	0.44
1:O:11:LYS:HA	1:O:12:SER:CB	2.37	0.44
5:Y:171:A:H5'	14:Y:203:HOH:O	2.18	0.43
5:X:169[A]:A:H5''	5:X:170:A:OP2	2.18	0.43
2:P:164[A]:A:H2'	2:P:165[A]:A:C8	2.53	0.43
1:II:81:TRP:O	1:II:151:ALA:N	2.47	0.43
9:WW:167[A]:U:C2'	9:WW:168:U:H5''	2.35	0.43
1:II:76[B]:MET:SD	1:II:157:CYS:SG	3.14	0.43
1:I:81:TRP:CD1	1:I:121:SER:HB3	2.53	0.43
1:B:115:ASN:OD1	1:B:117:ASN:N	2.46	0.43
1:G:47:VAL:HG12	1:G:48:GLN:N	2.34	0.43
1:I:159:ASN:OXT	12:I:502:CL:CL	2.74	0.43
1:N:118:THR:HG23	1:O:114:SER:O	2.19	0.43
1:GG:112:ARG:NH2	1:KK:44:GLU:OE2	2.41	0.43
1:C:117:ASN:OD1	1:D:116:ILE:HD11	2.20	0.42
1:A:112:ARG:NH2	1:E:44:GLU:OE2	2.50	0.42
1:L:91:TYR:CE1	1:L:116:ILE:HG23	2.55	0.41
1:M:44:GLU:OE2	12:M:501:CL:CL	2.75	0.41
12:A:201:CL:CL	1:F:33:PRO:CD	3.06	0.41
1:JJ:44:GLU:OE2	1:KK:112:ARG:NH2	2.45	0.41

Continued on next page...

Continued from previous page...

Atom-1	Atom-2	Interatomic distance (Å)	Clash overlap (Å)
1:JJ:110:GLU:OE2	1:JJ:112:ARG:NE	2.47	0.41
1:B:57:VAL:HG22	1:B:140:VAL:HG22	2.02	0.41
1:J:57:VAL:HG21	1:J:134:THR:HG22	2.00	0.41
5:TT:170[A]:A:O2'	5:TT:171:A:P	2.79	0.41
5:Y:169:A:O5'	5:Y:169:A:H8	2.04	0.41
1:J:148:ARG:HA	1:J:148:ARG:HD3	2.00	0.40
4:V:163:A:O5'	4:V:163:A:H8	2.04	0.40
1:E:118:THR:HG22	1:E:119:ARG:N	2.36	0.40
1:J:21:THR:HG22	2:P:165[A]:A:H5''	2.02	0.40
1:J:134:THR:CG2	1:J:138:ASP:HB2	2.52	0.40

All (4) symmetry-related close contacts are listed below. The label for Atom-2 includes the symmetry operator and encoded unit-cell translations to be applied.

Atom-1	Atom-2	Interatomic distance (Å)	Clash overlap (Å)
14:L:335:HOH:O	14:M:622:HOH:O[8_656]	1.98	0.22
9:kk:189:U:O3'	14:B:325:HOH:O[6_566]	2.06	0.14
9:kk:189:U:O2'	14:B:325:HOH:O[6_566]	2.07	0.13
14:A:342:HOH:O	14:HH:228:HOH:O[9_565]	2.15	0.05

5.3 Torsion angles [i](#)

5.3.1 Protein backbone [i](#)

In the following table, the Percentiles column shows the percent Ramachandran outliers of the chain as a percentile score with respect to all X-ray entries followed by that with respect to entries of similar resolution.

The Analysed column shows the number of residues for which the backbone conformation was analysed, and the total number of residues.

Mol	Chain	Analysed	Favoured	Allowed	Outliers	Percentiles	
1	A	147/159 (92%)	140 (95%)	7 (5%)	0	100	100
1	B	143/159 (90%)	131 (92%)	9 (6%)	3 (2%)	7	33
1	C	143/159 (90%)	134 (94%)	9 (6%)	0	100	100
1	D	145/159 (91%)	135 (93%)	10 (7%)	0	100	100
1	E	147/159 (92%)	140 (95%)	7 (5%)	0	100	100
1	F	152/159 (96%)	140 (92%)	12 (8%)	0	100	100

Continued on next page...

Continued from previous page...

Mol	Chain	Analysed	Favoured	Allowed	Outliers	Percentiles	
1	G	148/159 (93%)	139 (94%)	9 (6%)	0	100	100
1	GG	146/159 (92%)	135 (92%)	10 (7%)	1 (1%)	22	60
1	H	152/159 (96%)	143 (94%)	7 (5%)	2 (1%)	12	45
1	HH	148/159 (93%)	138 (93%)	10 (7%)	0	100	100
1	I	145/159 (91%)	139 (96%)	6 (4%)	0	100	100
1	II	146/159 (92%)	134 (92%)	11 (8%)	1 (1%)	22	60
1	J	147/159 (92%)	139 (95%)	7 (5%)	1 (1%)	22	60
1	JJ	142/159 (89%)	135 (95%)	7 (5%)	0	100	100
1	K	152/159 (96%)	146 (96%)	6 (4%)	0	100	100
1	KK	146/159 (92%)	136 (93%)	10 (7%)	0	100	100
1	L	167/159 (105%)	152 (91%)	13 (8%)	2 (1%)	13	48
1	M	153/159 (96%)	145 (95%)	7 (5%)	1 (1%)	22	60
1	N	148/159 (93%)	139 (94%)	8 (5%)	1 (1%)	22	60
1	O	150/159 (94%)	139 (93%)	10 (7%)	1 (1%)	22	60
All	All	2967/3180 (93%)	2779 (94%)	175 (6%)	13 (0%)	29	72

All (13) Ramachandran outliers are listed below:

Mol	Chain	Res	Type
1	H	122	VAL
1	L	16	ASN
1	B	37	TRP
1	L	13	THR
1	N	42	PRO
1	B	35	PRO
1	O	14	GLY
1	II	17	SER
1	H	42	PRO
1	B	87	PRO
1	M	87	PRO
1	GG	42	PRO
1	J	42	PRO

5.3.2 Protein sidechains [i](#)

In the following table, the Percentiles column shows the percent sidechain outliers of the chain as a percentile score with respect to all X-ray entries followed by that with respect to entries of similar

resolution.

The Analysed column shows the number of residues for which the sidechain conformation was analysed, and the total number of residues.

Mol	Chain	Analysed	Rotameric	Outliers	Percentiles	
1	A	133/140 (95%)	132 (99%)	1 (1%)	81	93
1	B	129/140 (92%)	128 (99%)	1 (1%)	81	93
1	C	129/140 (92%)	129 (100%)	0	100	100
1	D	131/140 (94%)	131 (100%)	0	100	100
1	E	133/140 (95%)	133 (100%)	0	100	100
1	F	138/140 (99%)	137 (99%)	1 (1%)	84	94
1	G	133/140 (95%)	133 (100%)	0	100	100
1	GG	132/140 (94%)	132 (100%)	0	100	100
1	H	138/140 (99%)	137 (99%)	1 (1%)	84	94
1	HH	134/140 (96%)	134 (100%)	0	100	100
1	I	131/140 (94%)	131 (100%)	0	100	100
1	II	132/140 (94%)	131 (99%)	1 (1%)	81	93
1	J	133/140 (95%)	133 (100%)	0	100	100
1	JJ	128/140 (91%)	128 (100%)	0	100	100
1	K	138/140 (99%)	138 (100%)	0	100	100
1	KK	132/140 (94%)	132 (100%)	0	100	100
1	L	150/140 (107%)	147 (98%)	3 (2%)	55	83
1	M	139/140 (99%)	139 (100%)	0	100	100
1	N	134/140 (96%)	134 (100%)	0	100	100
1	O	135/140 (96%)	135 (100%)	0	100	100
All	All	2682/2800 (96%)	2674 (100%)	8 (0%)	92	97

All (8) residues with a non-rotameric sidechain are listed below:

Mol	Chain	Res	Type
1	A	16	ASN
1	B	37	TRP
1	F	16	ASN
1	H	122	VAL
1	L	9	ASN
1	L	11	LYS
1	L	13	THR

Continued on next page...

Continued from previous page...

Mol	Chain	Res	Type
1	II	45	VAL

Sometimes sidechains can be flipped to improve hydrogen bonding and reduce clashes. All (1) such sidechains are listed below:

Mol	Chain	Res	Type
1	JJ	117	ASN

5.3.3 RNA [i](#)

Mol	Chain	Analysed	Backbone Outliers	Pucker Outliers
10	n	6/8 (75%)	0	0
11	bb	10/12 (83%)	6 (60%)	0
2	P	6/8 (75%)	0	0
2	S	5/8 (62%)	3 (60%)	0
2	a	3/8 (37%)	2 (66%)	0
3	T	4/6 (66%)	1 (25%)	0
4	V	7/9 (77%)	2 (28%)	0
5	TT	8/10 (80%)	7 (87%)	0
5	UU	8/10 (80%)	1 (12%)	0
5	X	8/10 (80%)	1 (12%)	1 (12%)
5	Y	8/10 (80%)	2 (25%)	0
6	e	10/12 (83%)	6 (60%)	0
6	qq	5/12 (41%)	0	0
7	h	5/7 (71%)	2 (40%)	0
8	i	4/6 (66%)	1 (25%)	0
8	ll	4/6 (66%)	1 (25%)	0
9	WW	8/9 (88%)	6 (75%)	1 (12%)
9	kk	7/9 (77%)	2 (28%)	0
9	m	7/9 (77%)	2 (28%)	0
All	All	123/169 (72%)	45 (36%)	2 (1%)

All (45) RNA backbone outliers are listed below:

Mol	Chain	Res	Type
2	S	166[A]	A
2	S	167[A]	A
2	S	168[A]	A
3	T	168[A]	A
4	V	163	A
4	V	169[A]	A

Continued on next page...

Continued from previous page...

Mol	Chain	Res	Type
5	X	170	A
5	Y	170	A
5	Y	171	A
2	a	168[A]	A
2	a	169[A]	A
6	e	181[A]	U
6	e	183[A]	U
6	e	184[A]	U
6	e	185[A]	U
6	e	186[A]	U
6	e	187[A]	U
7	h	186[A]	U
7	h	187[A]	U
8	i	185[A]	U
9	m	188[A]	U
9	m	189[A]	U
5	TT	164[A]	A
5	TT	166[A]	A
5	TT	167[A]	A
5	TT	168[A]	A
5	TT	169[A]	A
5	TT	170[A]	A
5	TT	171	A
5	UU	162[A]	A
9	WW	166[A]	U
9	WW	167[A]	U
9	WW	168	U
9	WW	169	U
9	WW	171	U
9	WW	172	U
11	bb	159	A
11	bb	160	A
11	bb	161[A]	A
11	bb	163[A]	A
11	bb	166[A]	A
11	bb	168[A]	A
9	kk	183[A]	U
9	kk	184[A]	U
8	ll	188[A]	U

All (2) RNA pucker outliers are listed below:

Mol	Chain	Res	Type
5	X	169[A]	A
9	WW	165	U

5.4 Non-standard residues in protein, DNA, RNA chains [i](#)

There are no non-standard protein/DNA/RNA residues in this entry.

5.5 Carbohydrates [i](#)

There are no monosaccharides in this entry.

5.6 Ligand geometry [i](#)

Of 40 ligands modelled in this entry, 40 are monoatomic - leaving 0 for Mogul analysis.

There are no bond length outliers.

There are no bond angle outliers.

There are no chirality outliers.

There are no torsion outliers.

There are no ring outliers.

No monomer is involved in short contacts.

5.7 Other polymers [i](#)

There are no such residues in this entry.

5.8 Polymer linkage issues [i](#)

There are no chain breaks in this entry.

6 Fit of model and data i

6.1 Protein, DNA and RNA chains i

In the following table, the column labelled ‘#RSRZ> 2’ contains the number (and percentage) of RSRZ outliers, followed by percent RSRZ outliers for the chain as percentile scores relative to all X-ray entries and entries of similar resolution. The OWAB column contains the minimum, median, 95th percentile and maximum values of the occupancy-weighted average B-factor per residue. The column labelled ‘Q< 0.9’ lists the number of (and percentage) of residues with an average occupancy less than 0.9.

Mol	Chain	Analysed	<RSRZ>	#RSRZ>2	OWAB(Å ²)	Q<0.9
1	A	144/159 (90%)	-0.21	0 100 100	24, 34, 46, 71	1 (0%)
1	B	144/159 (90%)	-0.14	0 100 100	26, 36, 49, 80	2 (1%)
1	C	143/159 (89%)	-0.10	1 (0%) 87 69	32, 43, 55, 84	0
1	D	144/159 (90%)	-0.00	1 (0%) 87 69	35, 47, 58, 81	0
1	E	144/159 (90%)	-0.20	1 (0%) 87 69	29, 39, 49, 74	0
1	F	144/159 (90%)	-0.20	0 100 100	25, 33, 42, 83	0
1	G	146/159 (91%)	0.02	3 (2%) 63 34	29, 42, 61, 104	2 (1%)
1	GG	145/159 (91%)	0.13	2 (1%) 75 49	33, 55, 76, 110	0
1	H	145/159 (91%)	-0.09	2 (1%) 75 49	29, 39, 50, 109	2 (1%)
1	HH	144/159 (90%)	0.28	0 100 100	30, 50, 66, 82	2 (1%)
1	I	144/159 (90%)	-0.25	0 100 100	17, 32, 48, 73	0
1	II	144/159 (90%)	0.24	3 (2%) 63 34	36, 49, 65, 87	0
1	J	144/159 (90%)	-0.23	0 100 100	20, 29, 42, 72	1 (0%)
1	JJ	144/159 (90%)	0.12	2 (1%) 75 49	45, 56, 69, 96	1 (0%)
1	K	145/159 (91%)	-0.08	2 (1%) 75 49	23, 30, 43, 97	0
1	KK	144/159 (90%)	0.19	1 (0%) 87 69	47, 61, 75, 95	0
1	L	156/159 (98%)	-0.03	9 (5%) 23 7	20, 28, 68, 102	1 (0%)
1	M	144/159 (90%)	-0.27	1 (0%) 87 69	19, 26, 36, 84	0
1	N	144/159 (90%)	-0.28	1 (0%) 87 69	20, 27, 41, 76	0
1	O	149/159 (93%)	-0.08	3 (2%) 65 36	22, 30, 52, 99	2 (1%)
2	P	7/8 (87%)	2.88	4 (57%) 0 0	61, 66, 95, 108	7 (100%)
2	S	6/8 (75%)	3.41	5 (83%) 0 0	63, 74, 91, 98	6 (100%)
2	a	4/8 (50%)	3.19	3 (75%) 0 0	41, 43, 77, 97	4 (100%)
3	T	5/6 (83%)	2.15	2 (40%) 0 0	56, 58, 61, 70	5 (100%)

Continued on next page...

Continued from previous page...

Mol	Chain	Analysed	<RSRZ>	#RSRZ>2	OWAB(Å ²)	Q<0.9
4	V	8/9 (88%)	3.34	6 (75%) 0 0	69, 97, 149, 152	6 (75%)
5	TT	9/10 (90%)	5.35	9 (100%) 0 0	78, 101, 133, 150	5 (55%)
5	UU	9/10 (90%)	3.12	5 (55%) 0 0	65, 76, 101, 119	9 (100%)
5	X	9/10 (90%)	2.66	5 (55%) 0 0	50, 61, 94, 117	9 (100%)
5	Y	9/10 (90%)	3.03	4 (44%) 0 0	45, 53, 95, 104	9 (100%)
6	e	11/12 (91%)	5.85	10 (90%) 0 0	80, 95, 112, 114	11 (100%)
6	qq	6/12 (50%)	4.03	5 (83%) 0 0	83, 92, 121, 141	4 (66%)
7	h	6/7 (85%)	2.32	2 (33%) 0 0	62, 66, 82, 93	6 (100%)
8	i	5/6 (83%)	2.80	2 (40%) 0 0	50, 60, 82, 98	5 (100%)
8	ll	5/6 (83%)	1.62	1 (20%) 1 0	72, 72, 81, 90	5 (100%)
9	WW	8/9 (88%)	3.12	4 (50%) 0 0	77, 106, 116, 143	4 (50%)
9	kk	8/9 (88%)	3.02	5 (62%) 0 0	63, 77, 109, 118	8 (100%)
9	m	8/9 (88%)	3.06	4 (50%) 0 0	50, 65, 98, 102	8 (100%)
10	n	7/8 (87%)	1.60	3 (42%) 0 0	46, 55, 91, 91	7 (100%)
11	bb	11/12 (91%)	5.31	10 (90%) 0 0	76, 89, 103, 105	11 (100%)
All	All	3042/3349 (90%)	0.10	121 (3%) 38 15	17, 39, 75, 152	143 (4%)

All (121) RSRZ outliers are listed below:

Mol	Chain	Res	Type	RSRZ
6	e	180	U	10.3
11	bb	161[A]	A	9.6
6	e	182[A]	U	9.5
11	bb	162[A]	A	8.7
6	e	181[A]	U	8.7
5	TT	168[A]	A	8.3
11	bb	159	A	8.0
11	bb	158	A	7.9
11	bb	160	A	7.6
9	m	189[A]	U	7.5
6	qq	188	U	7.2
5	X	162[A]	A	7.1
5	Y	171	A	7.1
6	e	188[A]	U	7.1
4	V	162	A	6.8
1	G	14	GLY	6.8
5	TT	169[A]	A	6.6

Continued on next page...

Continued from previous page...

Mol	Chain	Res	Type	RSRZ
5	TT	171	A	6.3
5	TT	170[A]	A	6.3
5	TT	165	A	6.3
6	e	189[A]	U	6.0
2	a	168[A]	A	5.7
6	e	185[A]	U	5.6
1	M	16	ASN	5.6
2	P	163[A]	A	5.6
9	kk	183[A]	U	5.4
5	Y	170	A	5.4
1	GG	15	ASP	5.3
6	qq	185[A]	U	5.3
5	UU	161	A	5.2
9	WW	170	U	5.1
5	TT	166[A]	A	5.0
1	G	15	ASP	5.0
8	i	188[A]	U	4.9
9	m	190[A]	U	4.8
5	Y	169	A	4.8
9	WW	171	U	4.8
5	UU	162[A]	A	4.7
1	II	16	ASN	4.7
6	e	190[A]	U	4.7
9	WW	172	U	4.6
7	h	184[A]	U	4.4
2	S	168[A]	A	4.4
4	V	169[A]	A	4.4
6	e	184[A]	U	4.3
1	H	15	ASP	4.2
9	kk	182	U	4.2
8	i	184[A]	U	4.2
1	H	16	ASN	4.1
5	TT	163	A	4.1
10	n	188[A]	U	4.1
9	m	188[A]	U	4.1
6	qq	184[A]	U	4.0
5	UU	163[A]	A	4.0
5	Y	163[A]	A	4.0
1	L	9	ASN	3.9
2	S	163[A]	A	3.9
5	UU	160	A	3.8
5	X	163[A]	A	3.8

Continued on next page...

Continued from previous page...

Mol	Chain	Res	Type	RSRZ
1	KK	16	ASN	3.8
11	bb	168[A]	A	3.8
1	L	13	THR	3.7
2	S	167[A]	A	3.7
2	P	168[A]	A	3.7
1	L	14	GLY	3.6
4	V	163	A	3.5
9	WW	165	U	3.5
11	bb	163[A]	A	3.5
9	kk	184[A]	U	3.4
2	S	166[A]	A	3.4
9	kk	189	U	3.3
6	qq	183	U	3.3
6	e	186[A]	U	3.3
1	O	16	ASN	3.3
2	a	169[A]	A	3.2
4	V	168[A]	A	3.2
2	S	165[A]	A	3.2
3	T	168[A]	A	3.2
6	e	183[A]	U	3.2
1	D	16	ASN	3.2
5	X	169[A]	A	3.1
1	O	15	ASP	3.1
8	ll	188[A]	U	3.1
9	m	183[A]	U	3.1
1	II	18	ASN	3.0
11	bb	166[A]	A	3.0
2	P	169[A]	A	2.9
5	TT	164[A]	A	2.9
7	h	189[A]	U	2.8
5	X	170	A	2.8
5	UU	166[A]	A	2.8
1	L	5	LYS	2.8
5	X	168[A]	A	2.7
1	L	12	SER	2.7
4	V	166[A]	A	2.6
2	P	165[A]	A	2.6
1	K	15	ASP	2.6
11	bb	167[A]	A	2.6
6	qq	187[A]	U	2.6
1	N	16	ASN	2.5
4	V	165[A]	A	2.5

Continued on next page...

Continued from previous page...

Mol	Chain	Res	Type	RSRZ
10	n	182[A]	U	2.5
10	n	187[A]	U	2.5
3	T	167[A]	A	2.5
1	O	14	GLY	2.4
1	L	15	ASP	2.3
1	GG	16	ASN	2.3
5	TT	167[A]	A	2.3
1	L	16	ASN	2.3
1	K	16	ASN	2.3
1	L	7	LYS	2.2
1	JJ	17	SER	2.2
2	a	167[A]	A	2.2
1	II	17	SER	2.2
9	kk	188[A]	U	2.2
1	G	16	ASN	2.2
1	E	16	ASN	2.1
11	bb	164[A]	A	2.1
1	L	10	ARG	2.1
1	C	17	SER	2.1
1	JJ	16	ASN	2.0

6.2 Non-standard residues in protein, DNA, RNA chains [i](#)

There are no non-standard protein/DNA/RNA residues in this entry.

6.3 Carbohydrates [i](#)

There are no monosaccharides in this entry.

6.4 Ligands [i](#)

In the following table, the Atoms column lists the number of modelled atoms in the group and the number defined in the chemical component dictionary. The B-factors column lists the minimum, median, 95th percentile and maximum values of B factors of atoms in the group. The column labelled 'Q<0.9' lists the number of atoms with occupancy less than 0.9.

Mol	Type	Chain	Res	Atoms	RSCC	RSR	B-factors(\AA^2)	Q<0.9
12	CL	A	201	1/1	0.62	1.08	84,84,84,84	0
12	CL	H	203	1/1	0.75	0.34	72,72,72,72	0
12	CL	E	202	1/1	0.79	0.93	64,64,64,64	0

Continued on next page...

Continued from previous page...

Mol	Type	Chain	Res	Atoms	RSCC	RSR	B-factors(\AA^2)	Q<0.9
12	CL	M	501	1/1	0.82	0.57	51,51,51,51	0
12	CL	O	201	1/1	0.83	0.61	67,67,67,67	0
12	CL	S	201	1/1	0.84	0.43	68,68,68,68	0
12	CL	I	502	1/1	0.85	0.54	58,58,58,58	0
12	CL	E	201	1/1	0.85	0.30	59,59,59,59	0
12	CL	H	202	1/1	0.88	0.27	74,74,74,74	0
12	CL	GG	201	1/1	0.91	0.13	59,59,59,59	0
13	MG	JJ	201	1/1	0.92	0.22	60,60,60,60	0
13	MG	A	203	1/1	0.93	0.30	42,42,42,42	0
12	CL	F	302	1/1	0.94	0.49	67,67,67,67	0
12	CL	H	201	1/1	0.94	0.37	62,62,62,62	0
12	CL	J	1301	1/1	0.94	0.14	52,52,52,52	0
12	CL	B	202	1/1	0.94	0.14	42,42,42,42	0
12	CL	M	504	1/1	0.94	0.28	59,59,59,59	0
12	CL	GG	202	1/1	0.95	0.12	52,52,52,52	0
12	CL	B	201	1/1	0.95	0.15	34,34,34,34	0
13	MG	J	1302	1/1	0.95	0.48	37,37,37,37	0
13	MG	K	303	1/1	0.95	0.53	35,35,35,35	0
12	CL	M	503	1/1	0.95	0.14	46,46,46,46	0
12	CL	I	501	1/1	0.96	0.33	67,67,67,67	0
13	MG	B	203	1/1	0.96	0.33	43,43,43,43	0
13	MG	H	204	1/1	0.96	0.15	35,35,35,35	0
12	CL	A	202	1/1	0.96	0.11	46,46,46,46	0
12	CL	M	502	1/1	0.96	0.67	58,58,58,58	0
13	MG	K	304	1/1	0.96	0.45	37,37,37,37	0
13	MG	O	202	1/1	0.96	0.60	31,31,31,31	0
13	MG	II	201	1/1	0.96	0.43	52,52,52,52	0
12	CL	KK	201	1/1	0.96	0.18	62,62,62,62	1
12	CL	n	401	1/1	0.97	0.17	45,45,45,45	0
12	CL	F	301	1/1	0.97	0.18	34,34,34,34	0
13	MG	K	302	1/1	0.97	0.33	25,25,25,25	0
13	MG	G	201	1/1	0.97	0.17	39,39,39,39	0
12	CL	M	505	1/1	0.98	0.31	45,45,45,45	0
13	MG	L	201	1/1	0.98	0.45	36,36,36,36	0
13	MG	M	506	1/1	0.98	0.26	32,32,32,32	0
13	MG	F	303	1/1	0.99	0.28	36,36,36,36	0
12	CL	K	301	1/1	0.99	0.15	25,25,25,25	0

The following is a graphical depiction of the model fit to experimental electron density of all instances of the Ligand of Interest. In addition, ligands with molecular weight > 250 and outliers as shown on the geometry validation Tables will also be included. Each fit is shown from different orientation to approximate a three-dimensional view.

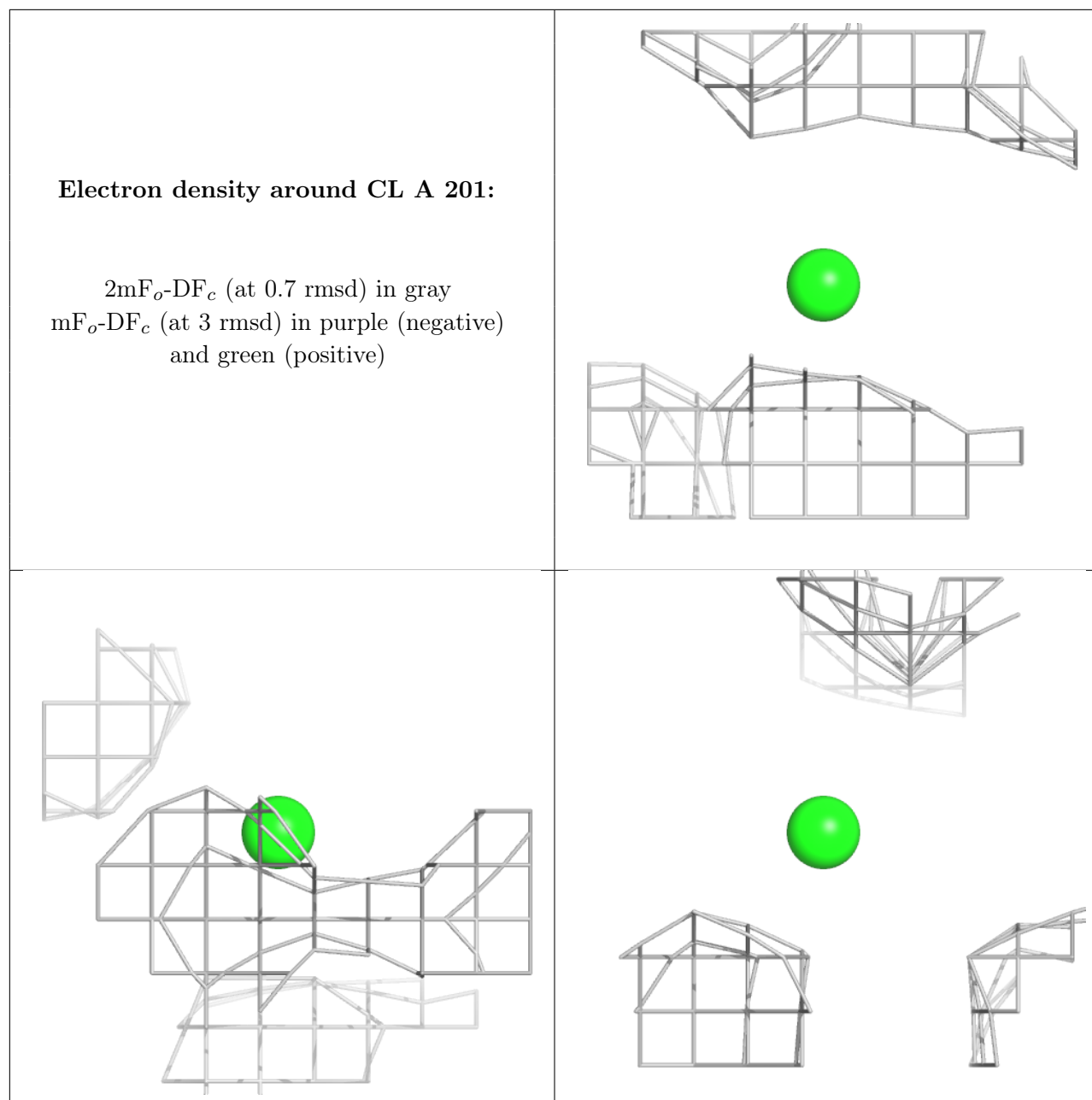

Electron density around CL H 203:

$2mF_o-DF_c$ (at 0.7 rmsd) in gray
 mF_o-DF_c (at 3 rmsd) in purple (negative)
and green (positive)

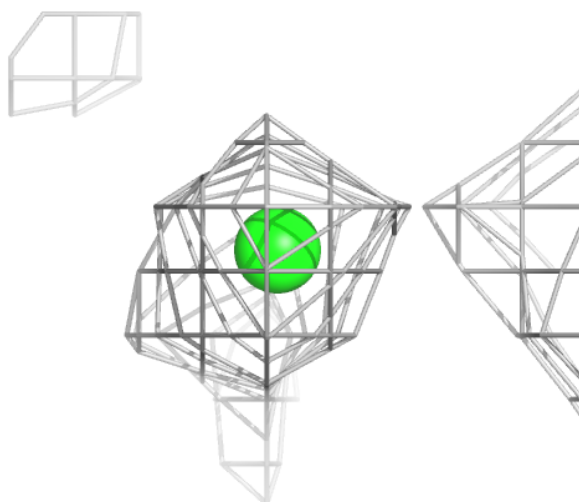
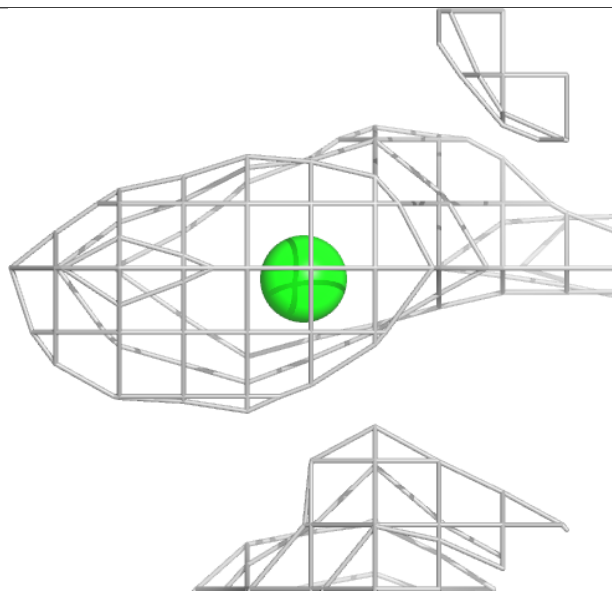
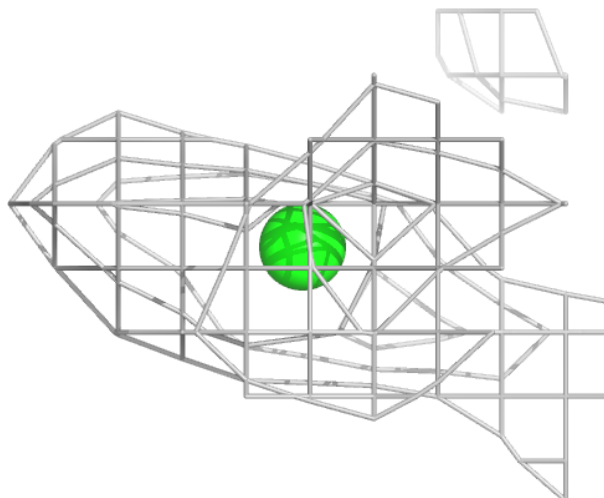

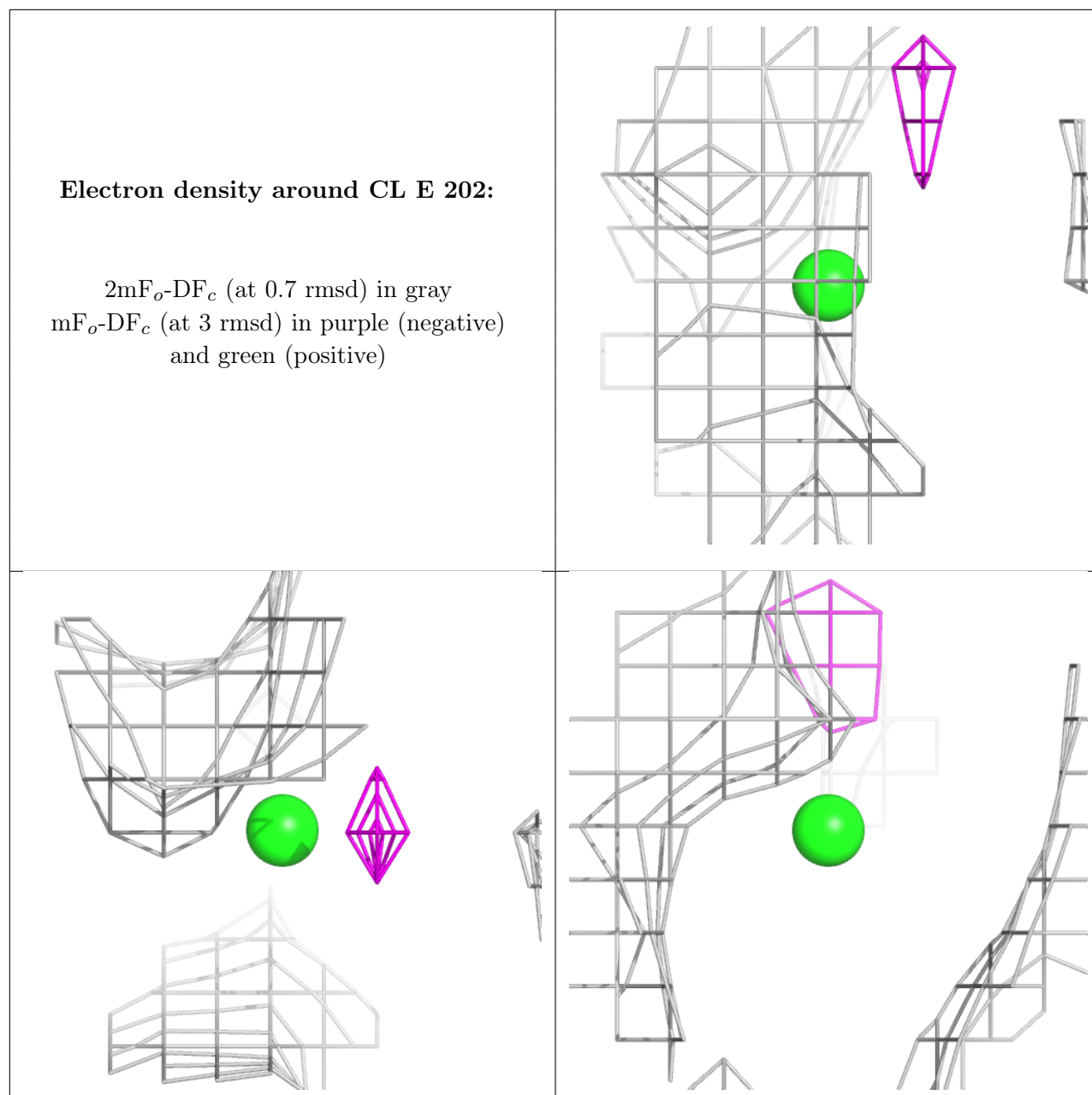

Electron density around CL M 501:

$2mF_o-DF_c$ (at 0.7 rmsd) in gray
 mF_o-DF_c (at 3 rmsd) in purple (negative)
and green (positive)

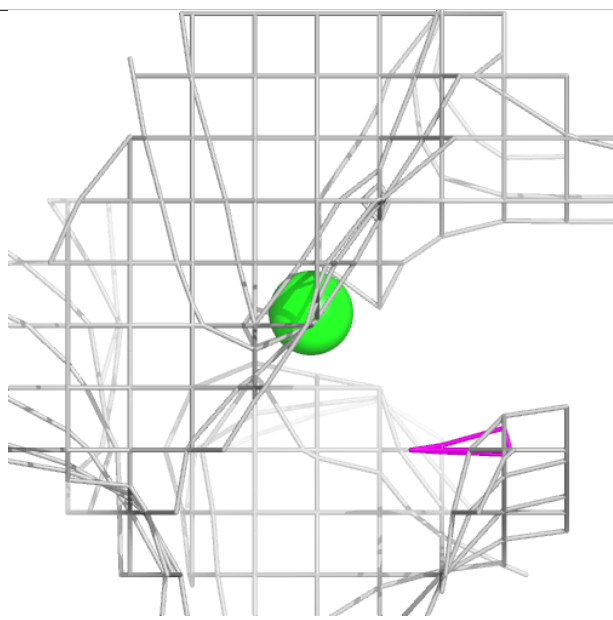
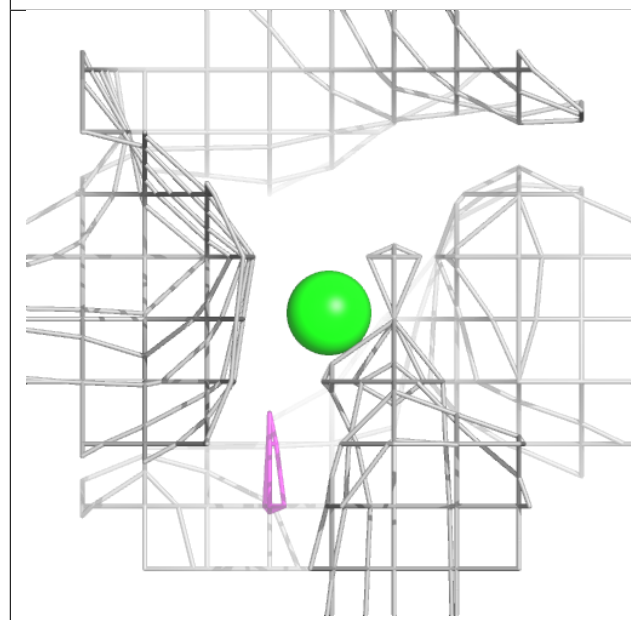
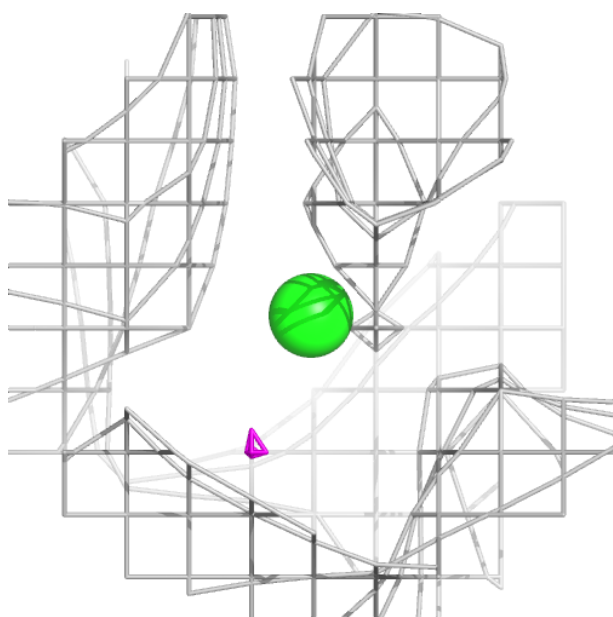

Electron density around CL O 201:

$2mF_o-DF_c$ (at 0.7 rmsd) in gray
 mF_o-DF_c (at 3 rmsd) in purple (negative)
and green (positive)

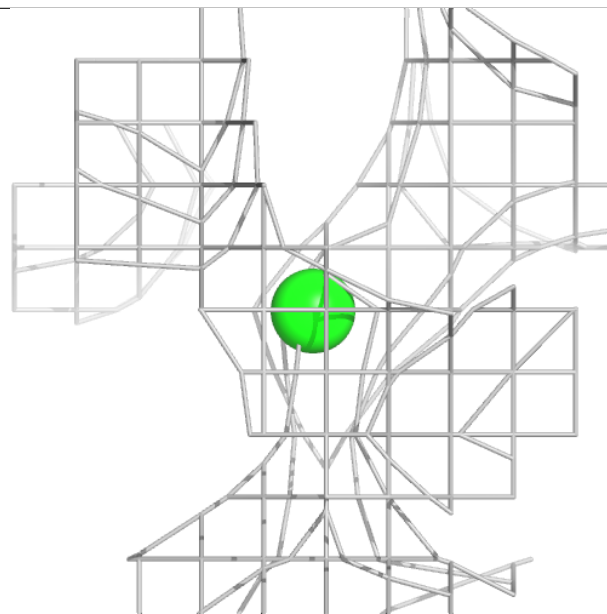
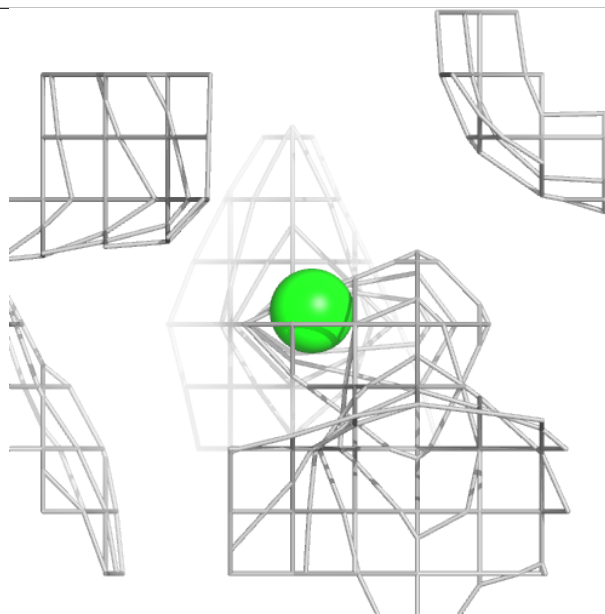
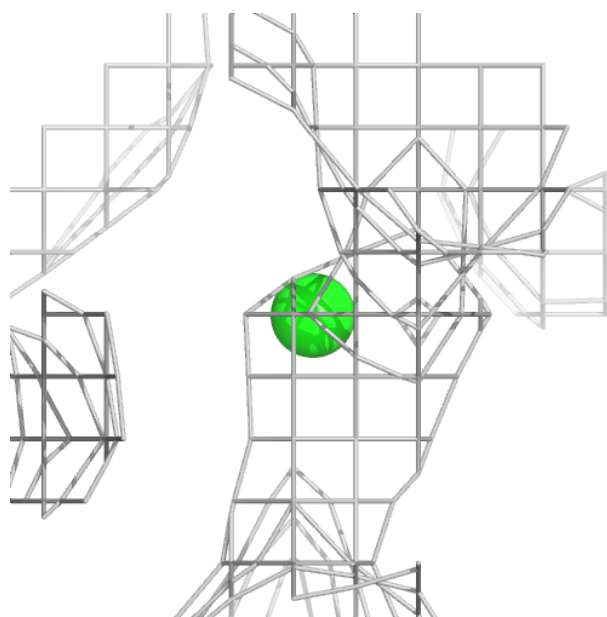

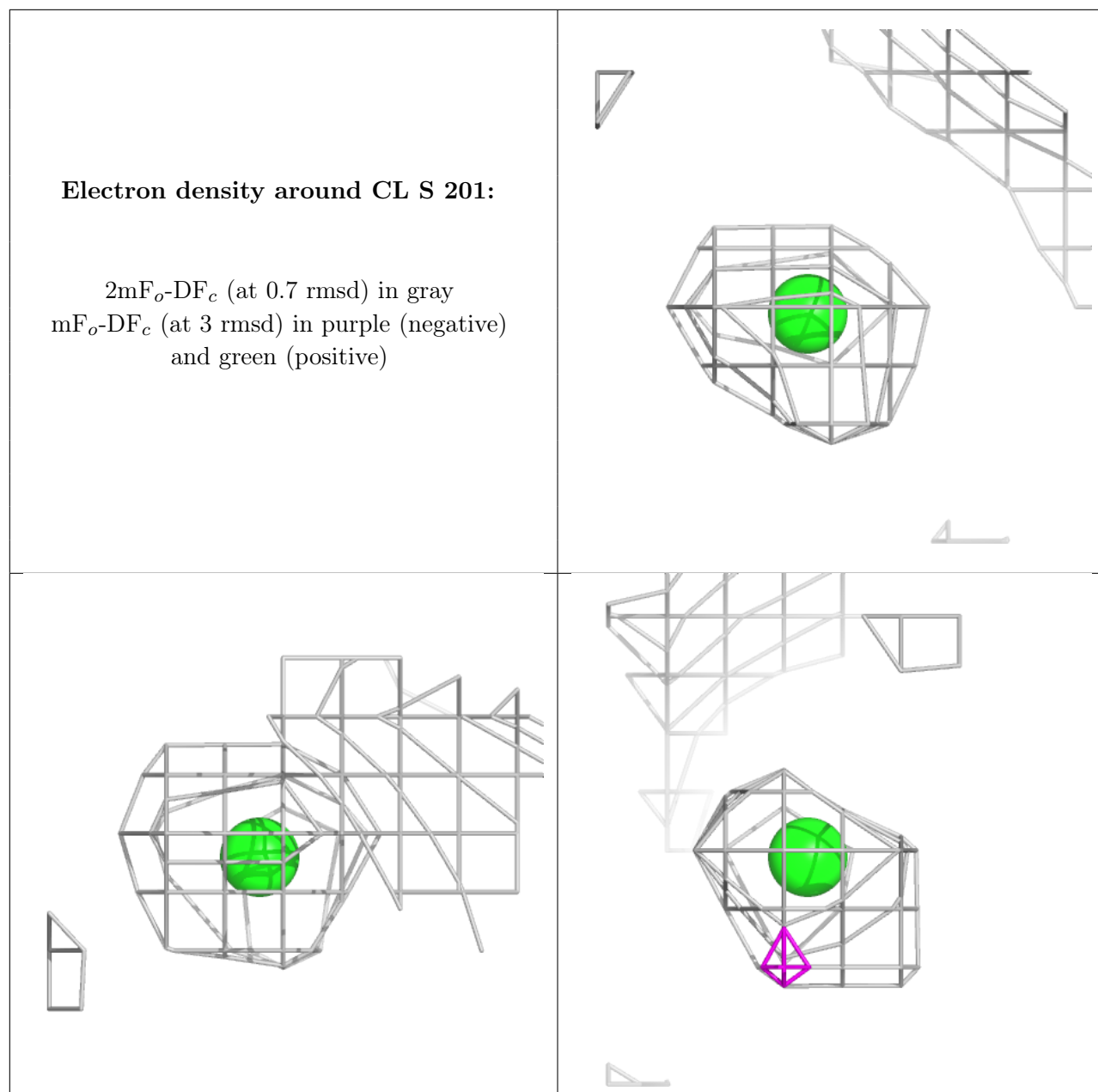

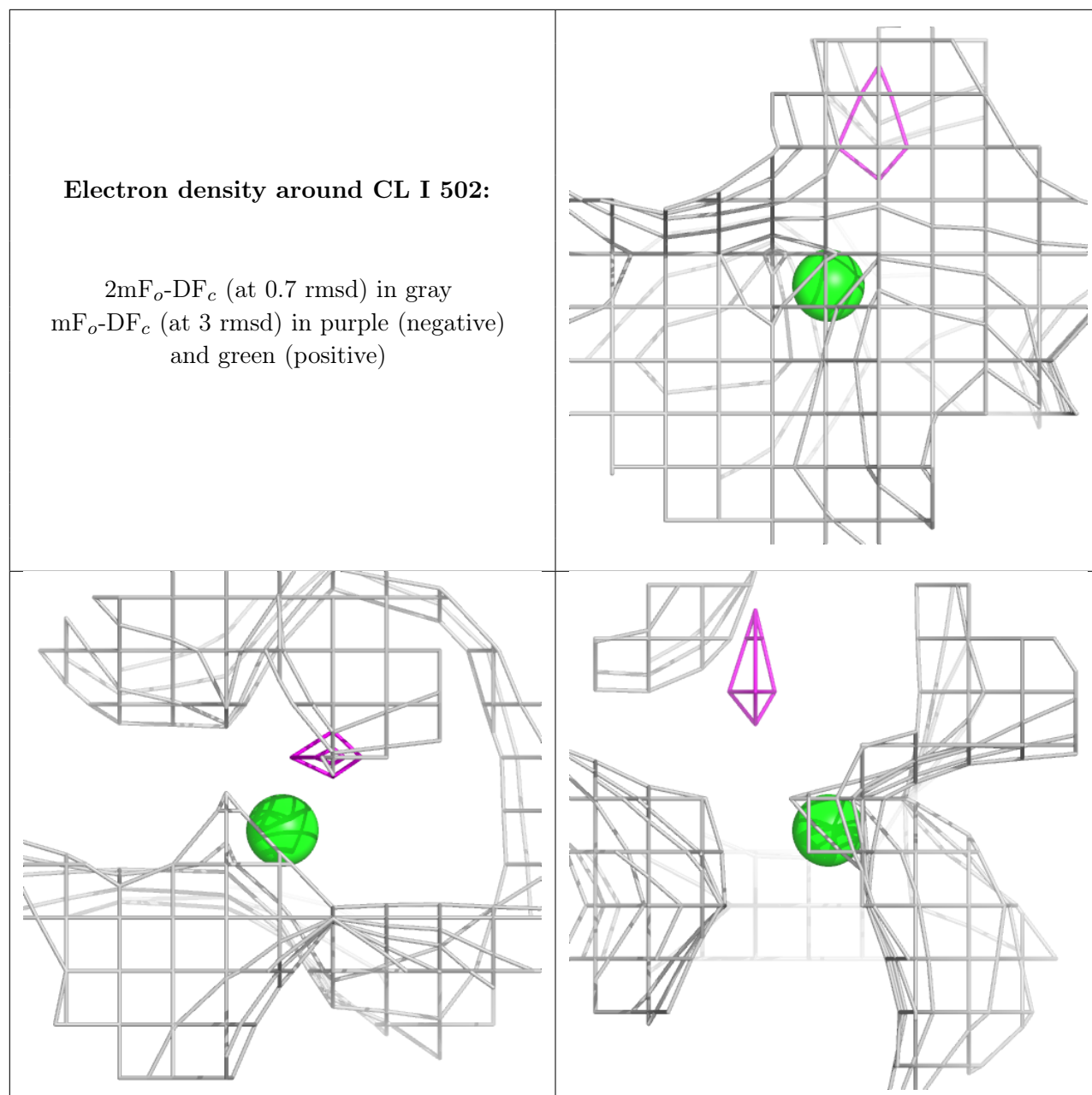

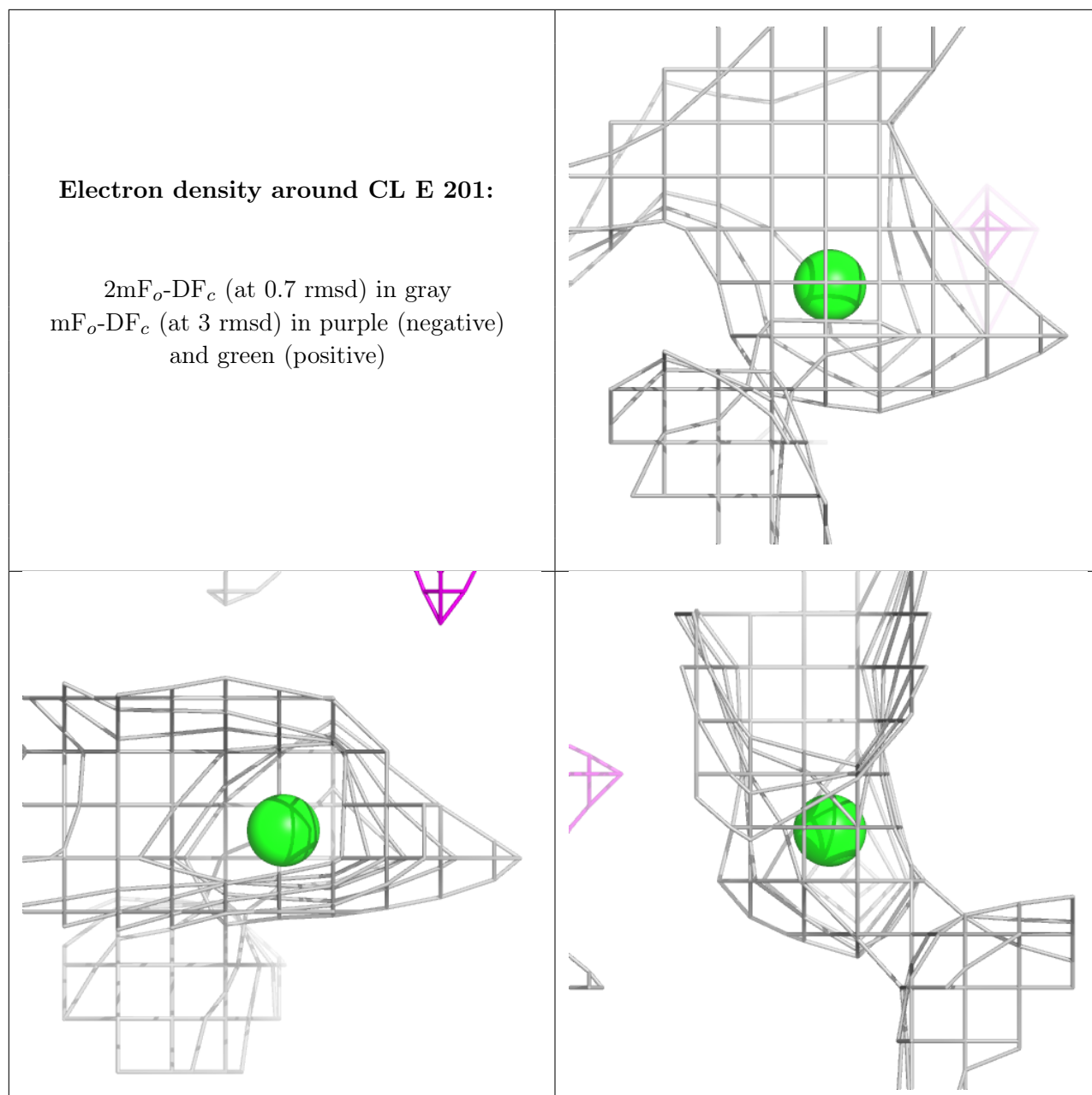

Electron density around CL H 202:

$2mF_o-DF_c$ (at 0.7 rmsd) in gray
 mF_o-DF_c (at 3 rmsd) in purple (negative)
and green (positive)

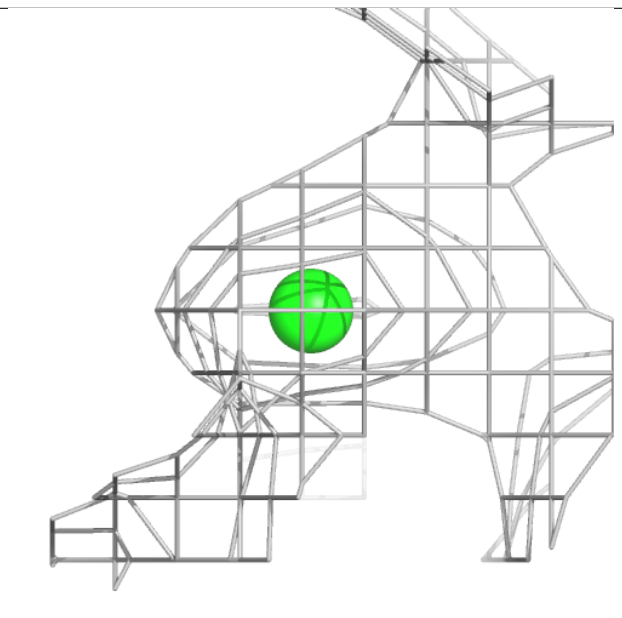
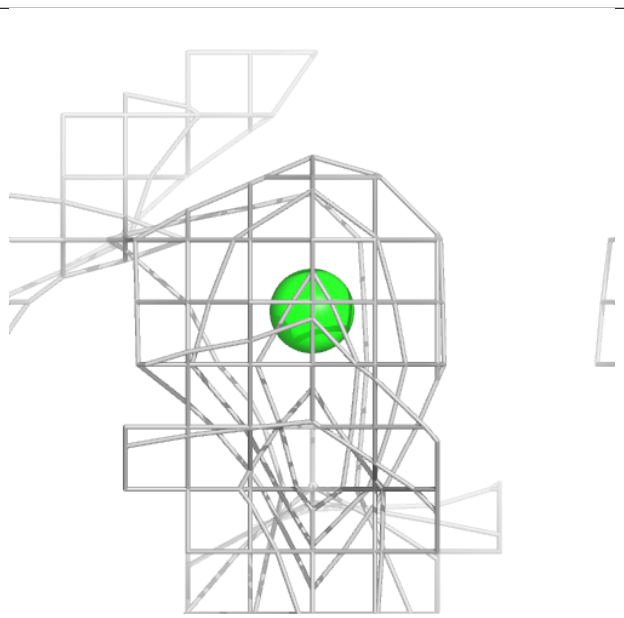
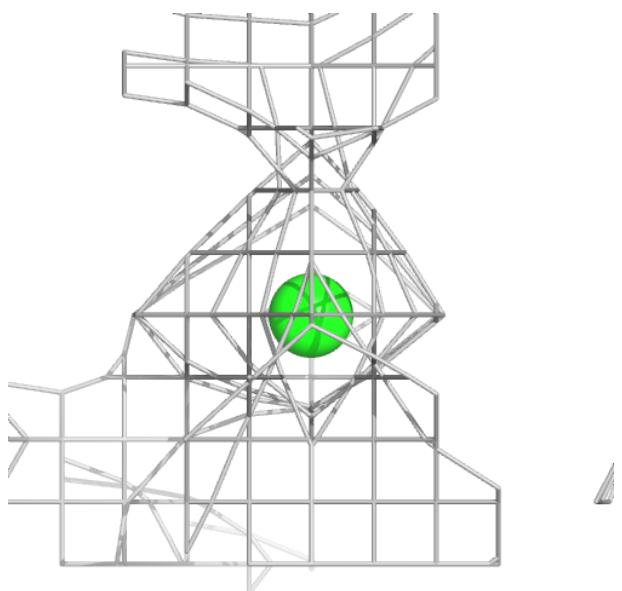

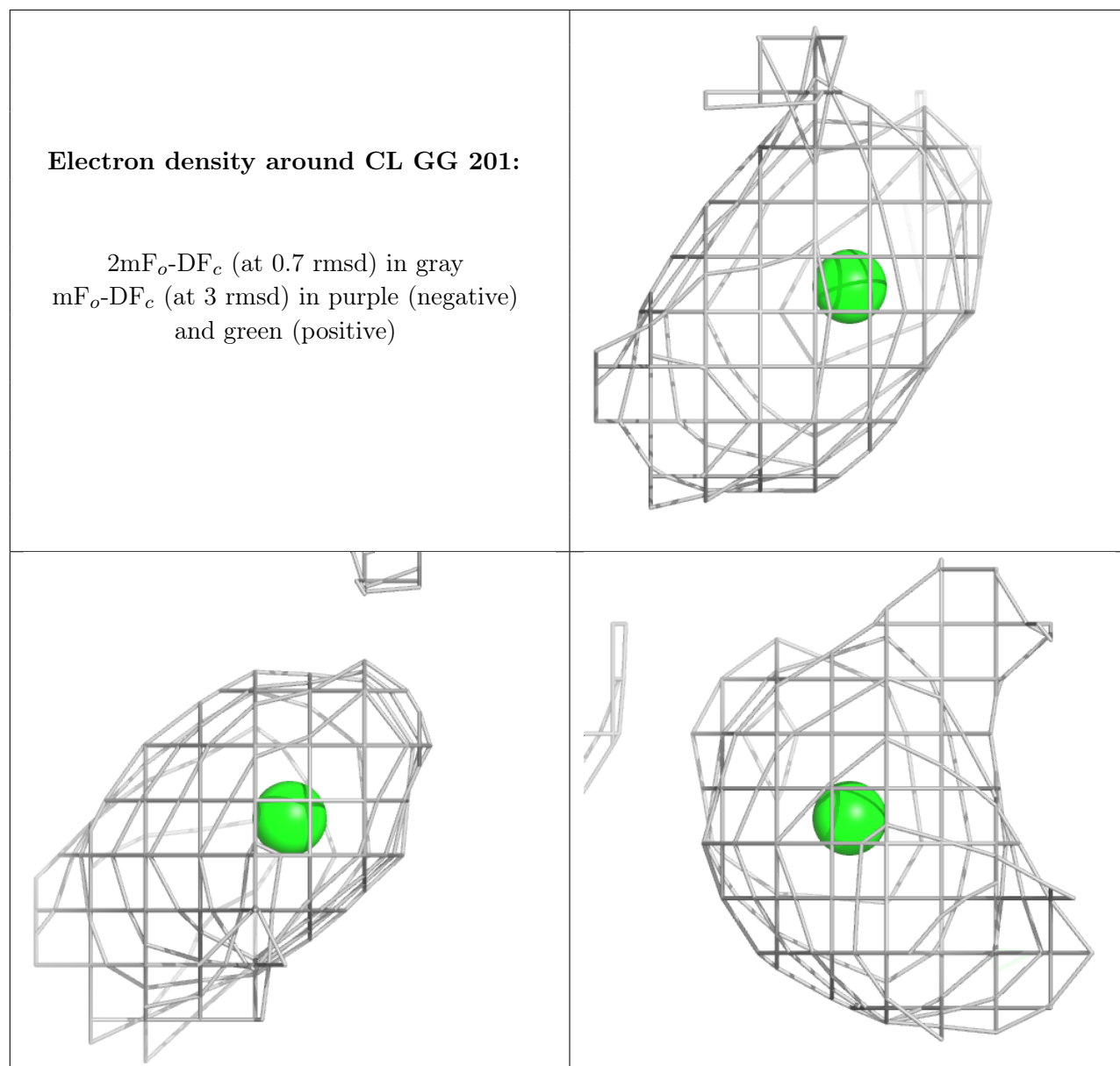

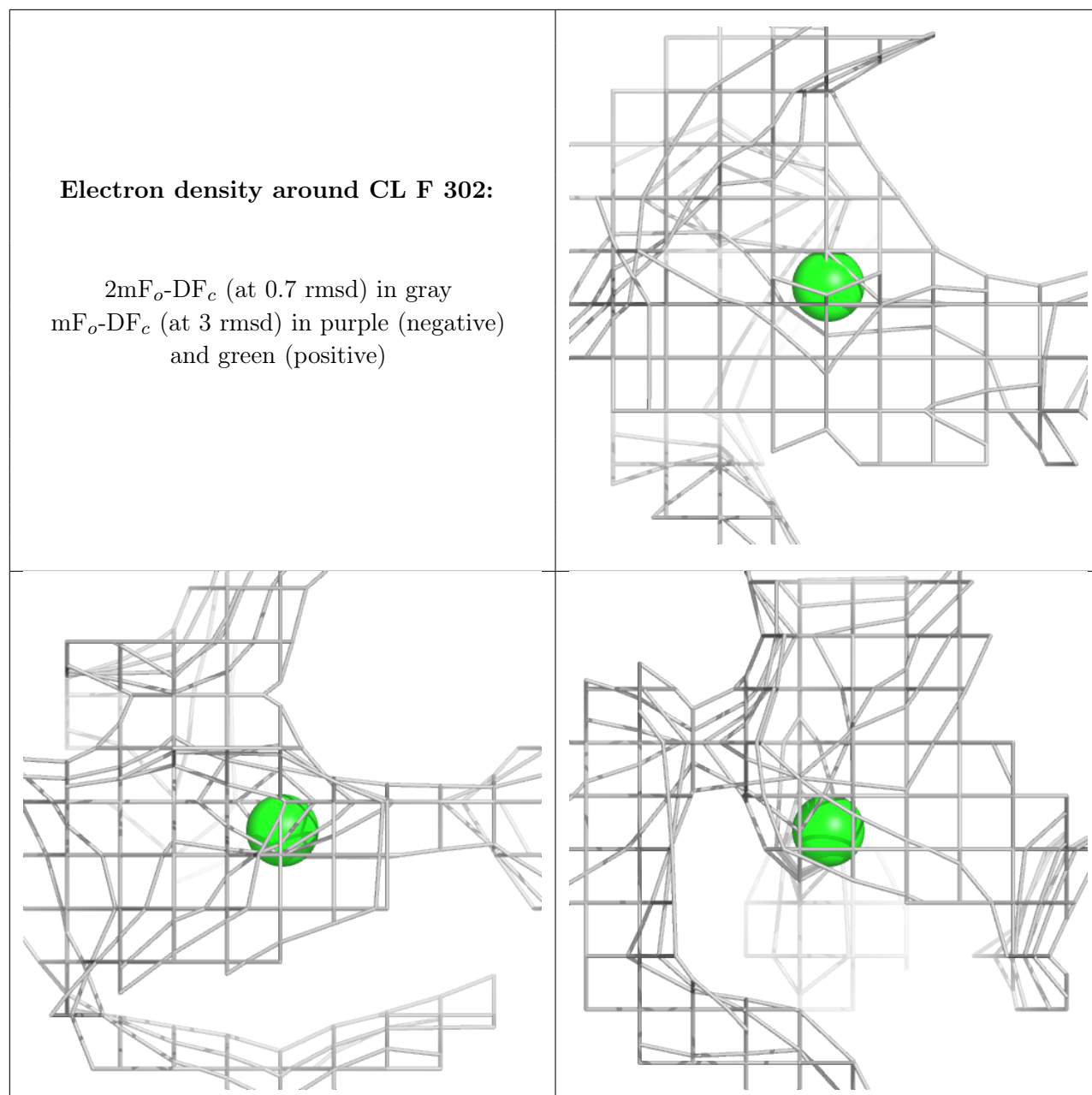

Electron density around CL H 201:

$2mF_o-DF_c$ (at 0.7 rmsd) in gray
 mF_o-DF_c (at 3 rmsd) in purple (negative)
and green (positive)

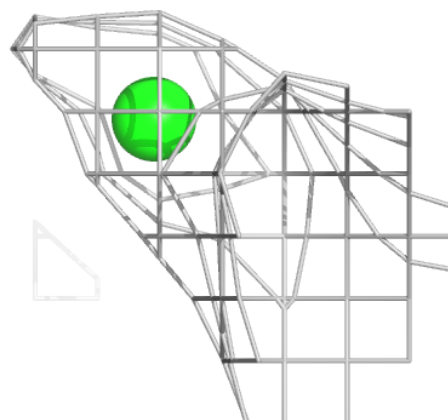
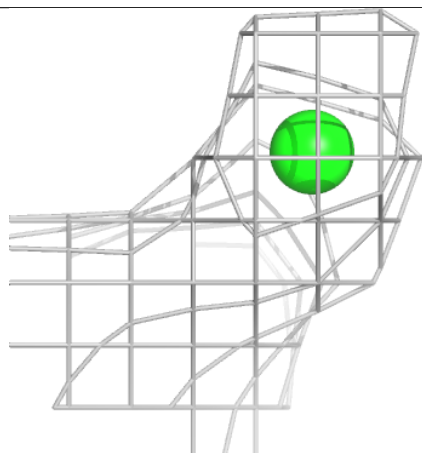
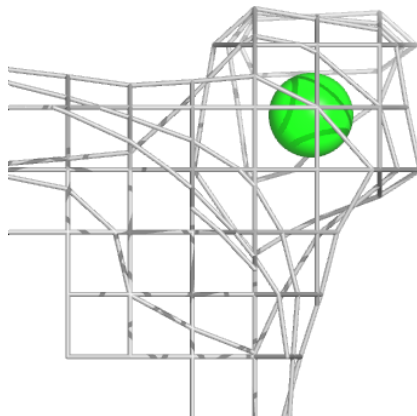

Electron density around CL J 1301:

$2mF_o-DF_c$ (at 0.7 rmsd) in gray
 mF_o-DF_c (at 3 rmsd) in purple (negative)
and green (positive)

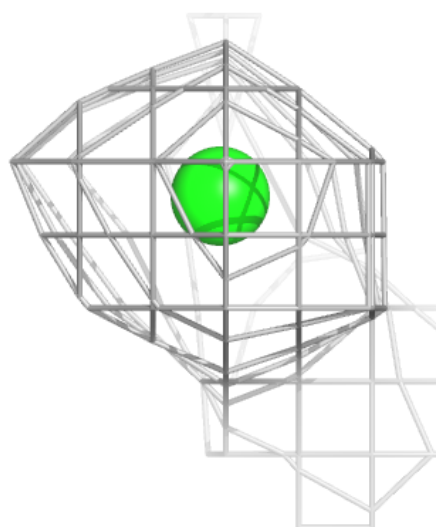
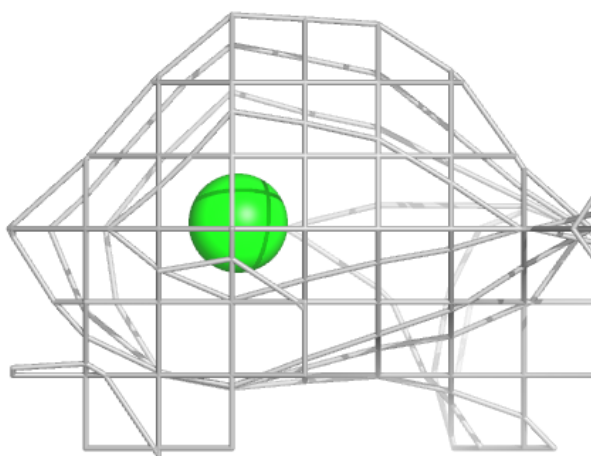
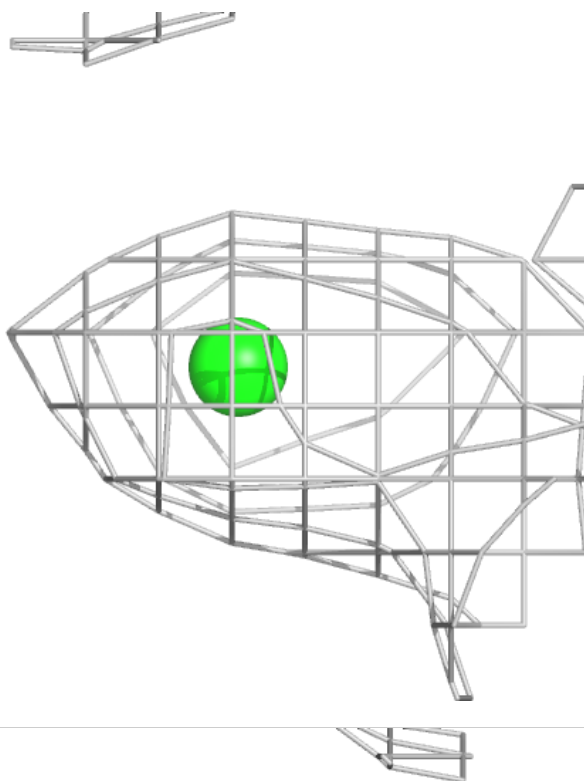

Electron density around CL B 202:

$2mF_o-DF_c$ (at 0.7 rmsd) in gray
 mF_o-DF_c (at 3 rmsd) in purple (negative)
and green (positive)

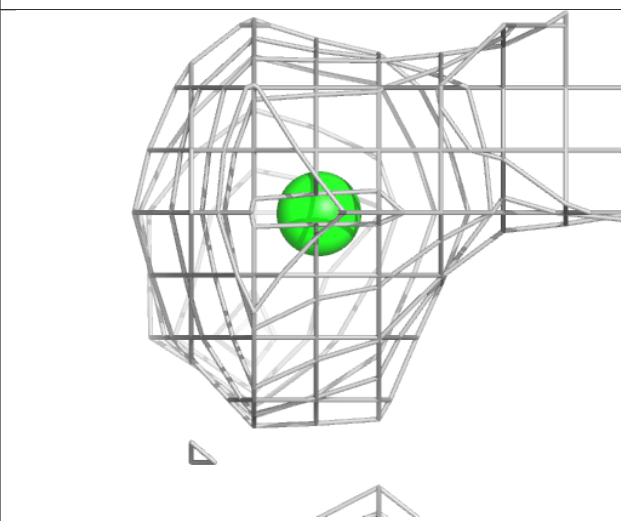
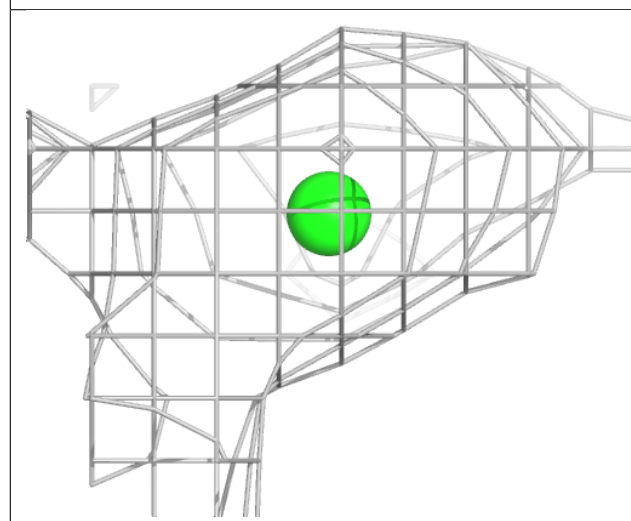
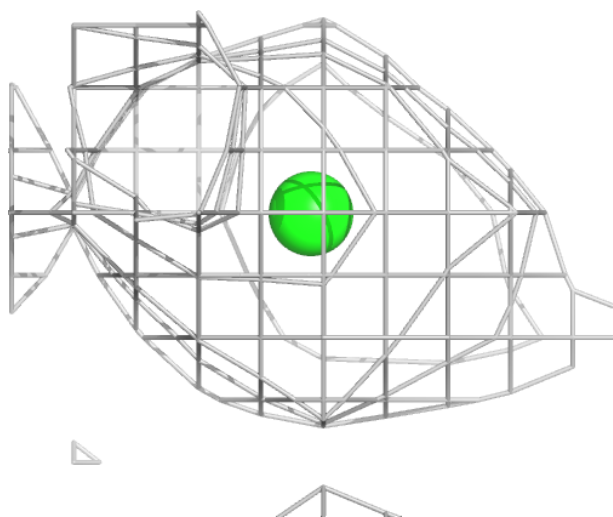

Electron density around CL M 504:

$2mF_o-DF_c$ (at 0.7 rmsd) in gray
 mF_o-DF_c (at 3 rmsd) in purple (negative)
and green (positive)

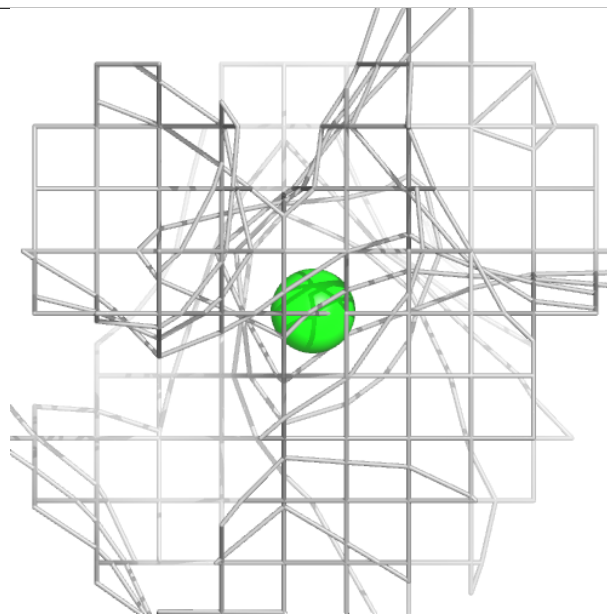
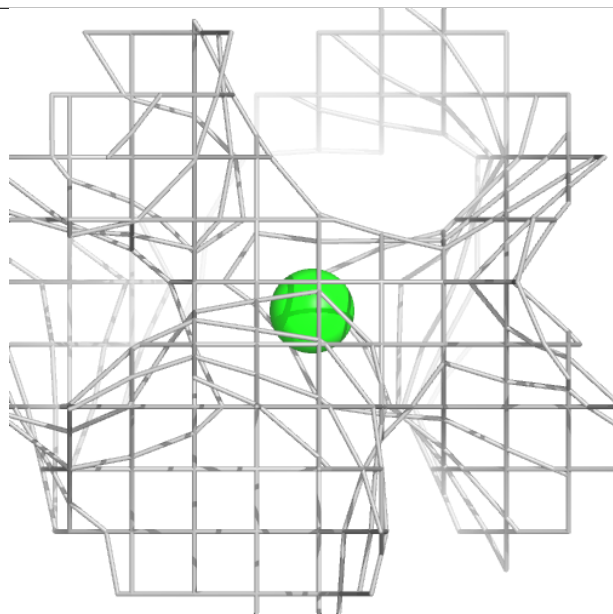
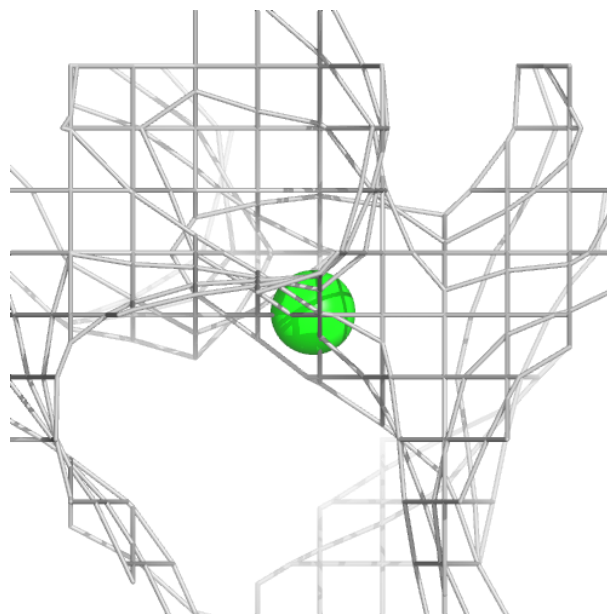

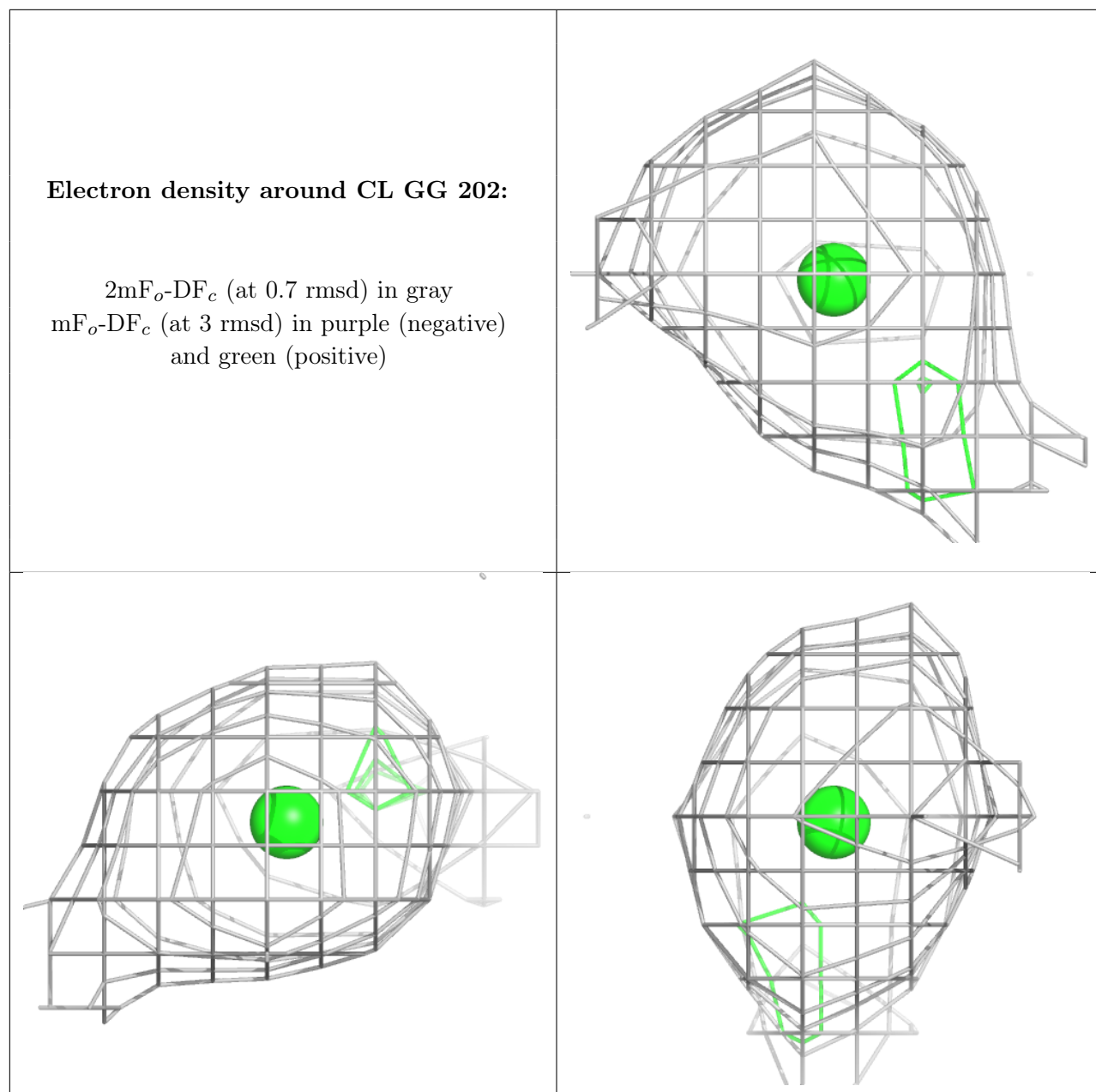

Electron density around CL B 201:

$2mF_o-DF_c$ (at 0.7 rmsd) in gray
 mF_o-DF_c (at 3 rmsd) in purple (negative)
and green (positive)

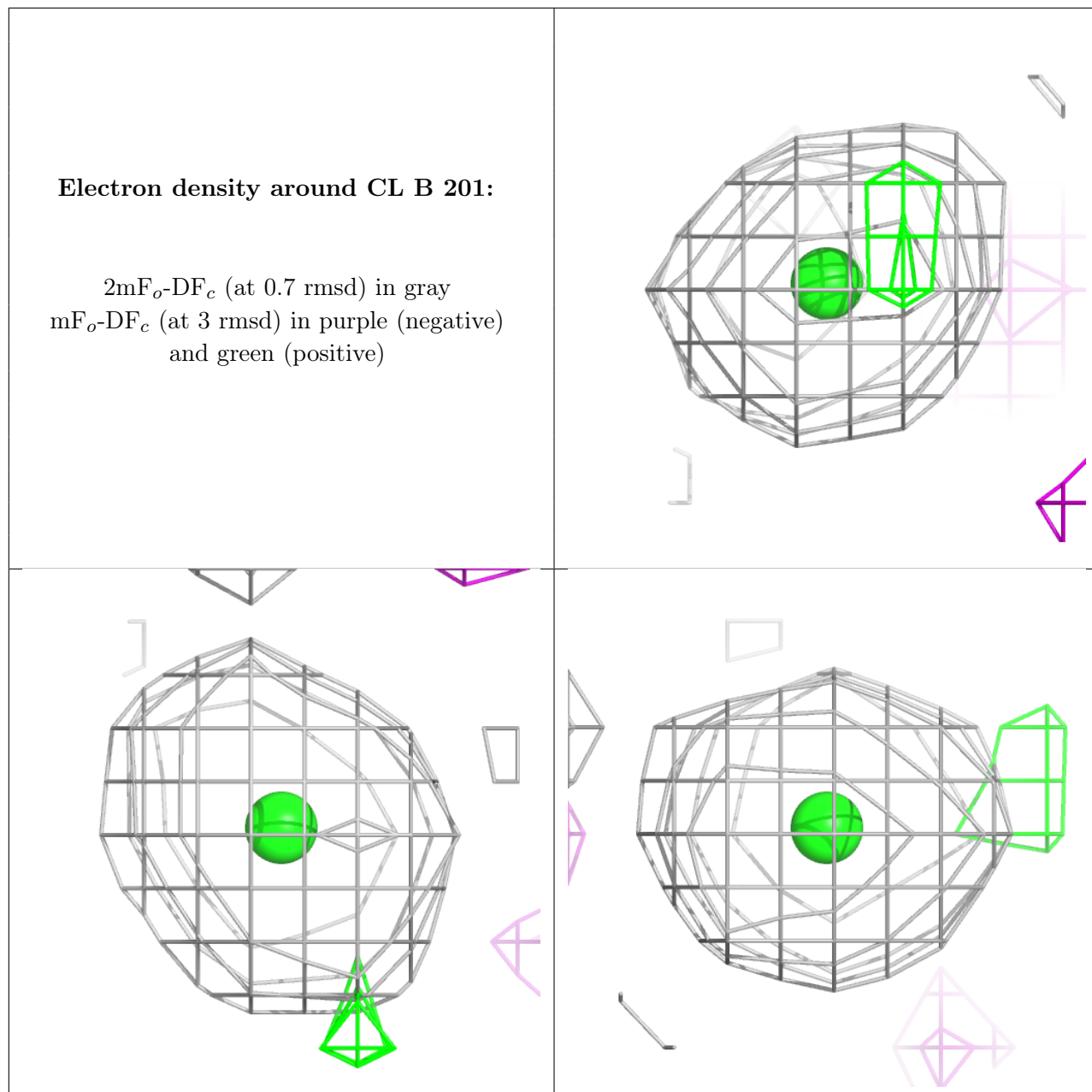

Electron density around CL M 503:

$2mF_o-DF_c$ (at 0.7 rmsd) in gray
 mF_o-DF_c (at 3 rmsd) in purple (negative)
and green (positive)

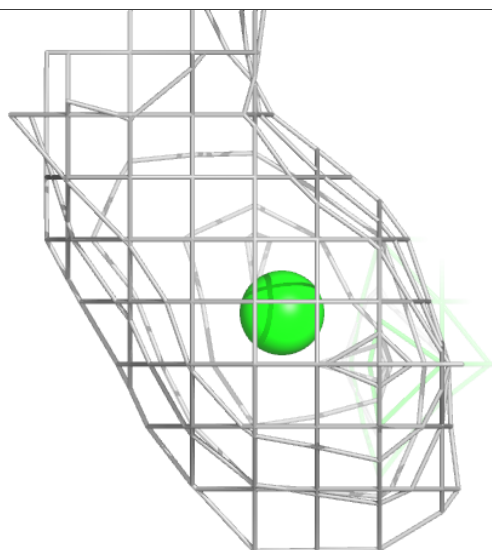
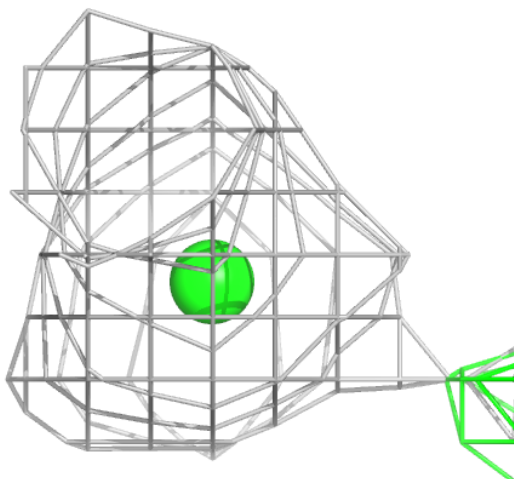
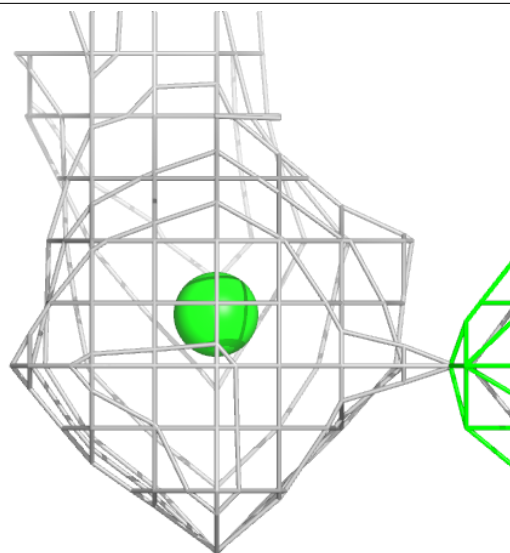



Electron density around CL A 202:

$2mF_o-DF_c$ (at 0.7 rmsd) in gray
 mF_o-DF_c (at 3 rmsd) in purple (negative)
and green (positive)

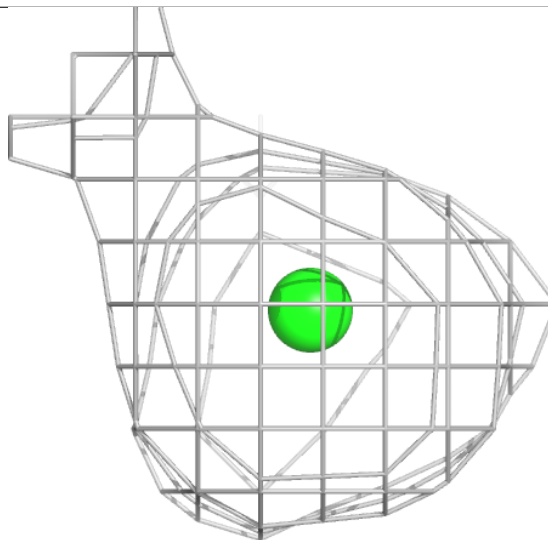
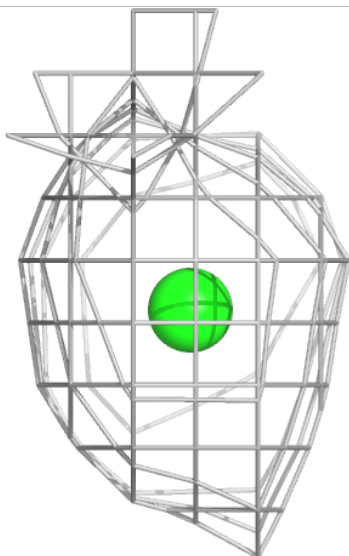
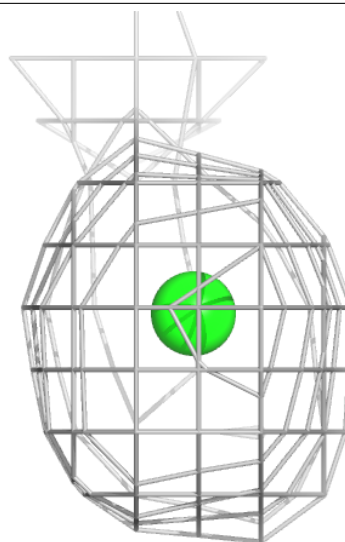

Electron density around CL M 502:

$2mF_o-DF_c$ (at 0.7 rmsd) in gray
 mF_o-DF_c (at 3 rmsd) in purple (negative)
and green (positive)

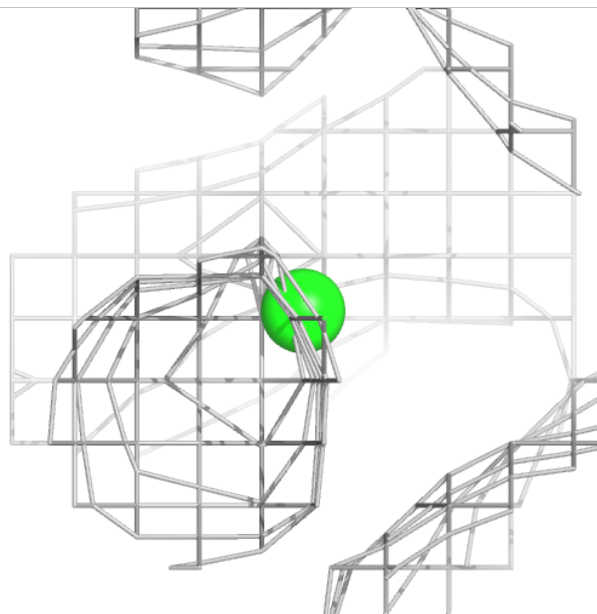
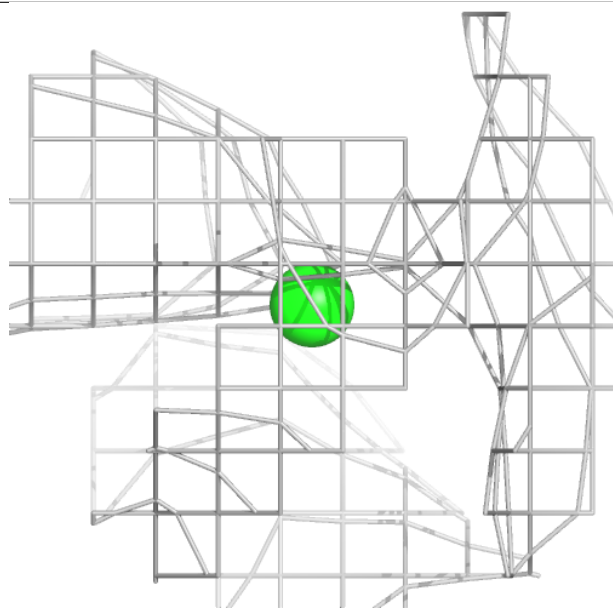
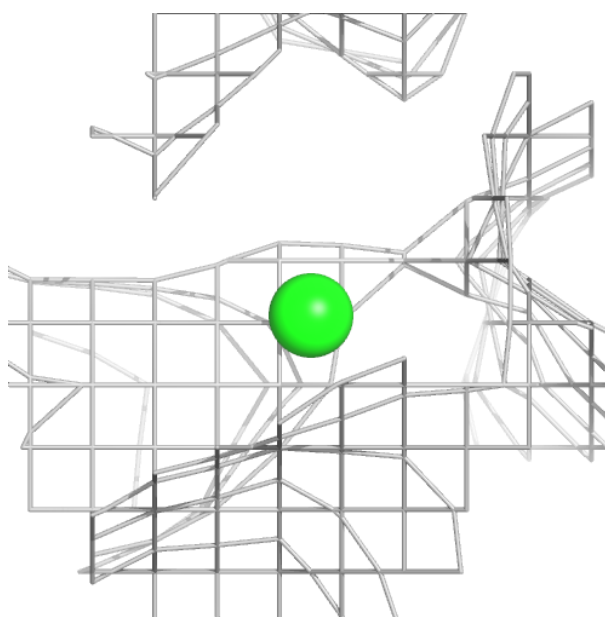

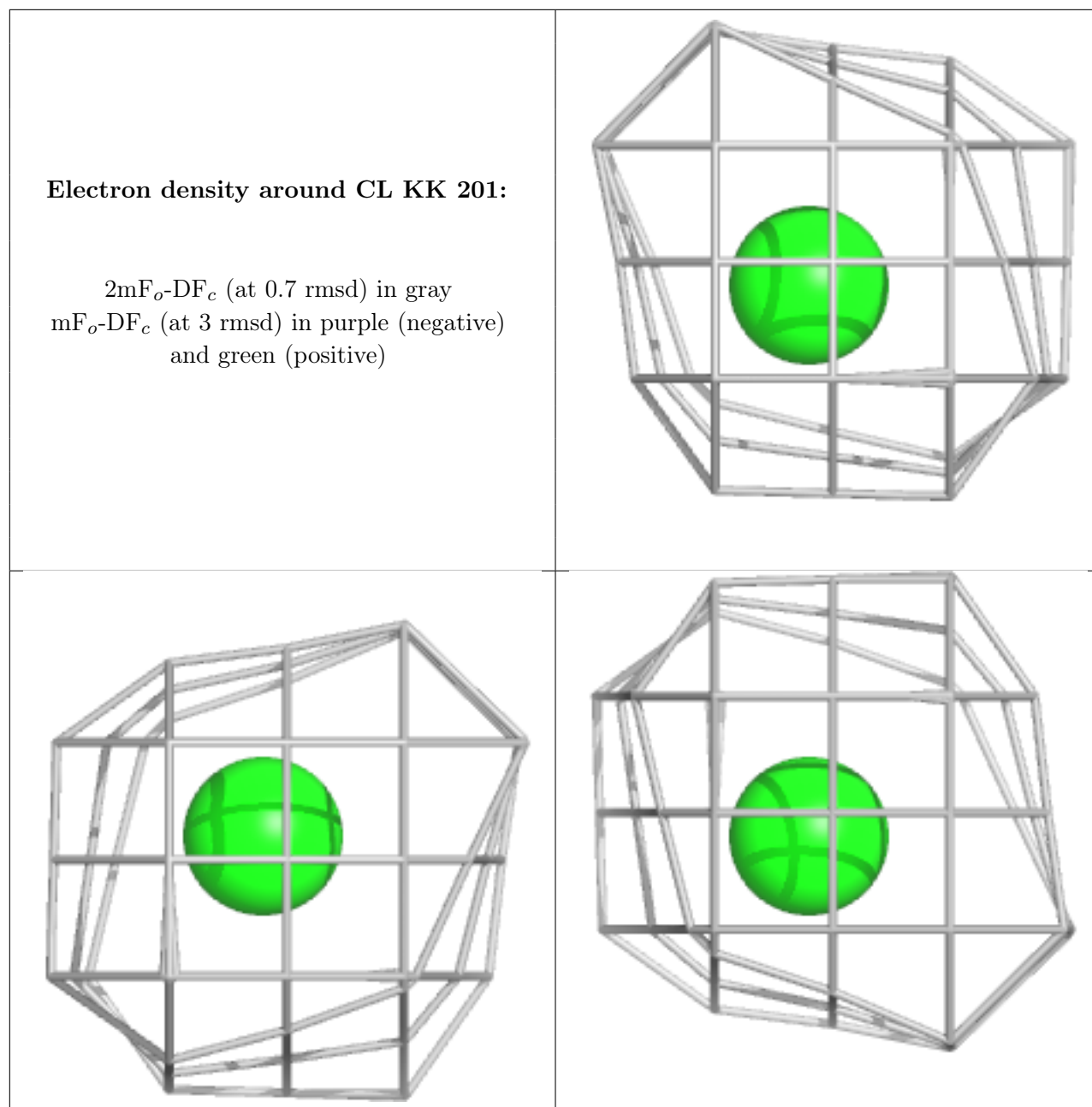

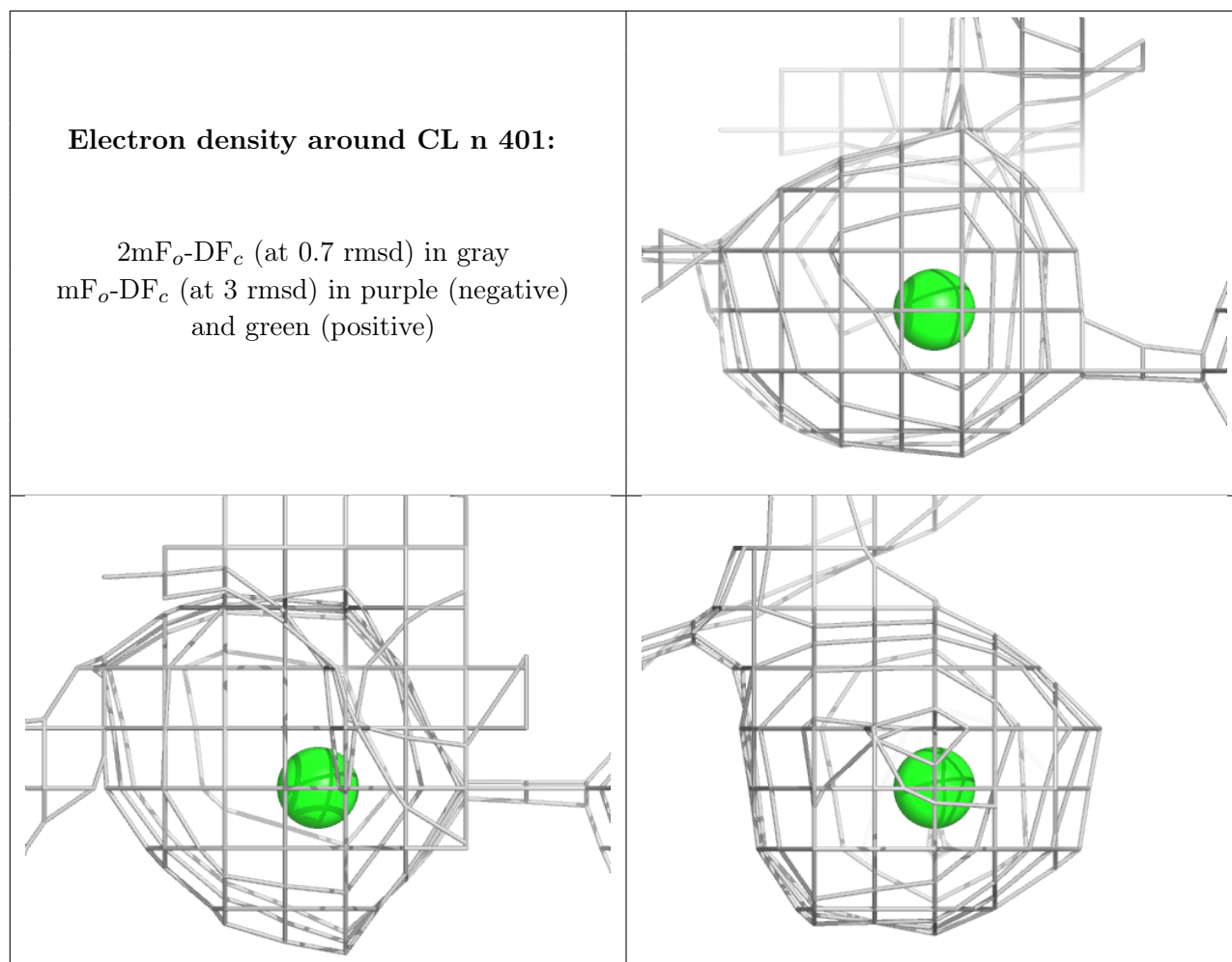

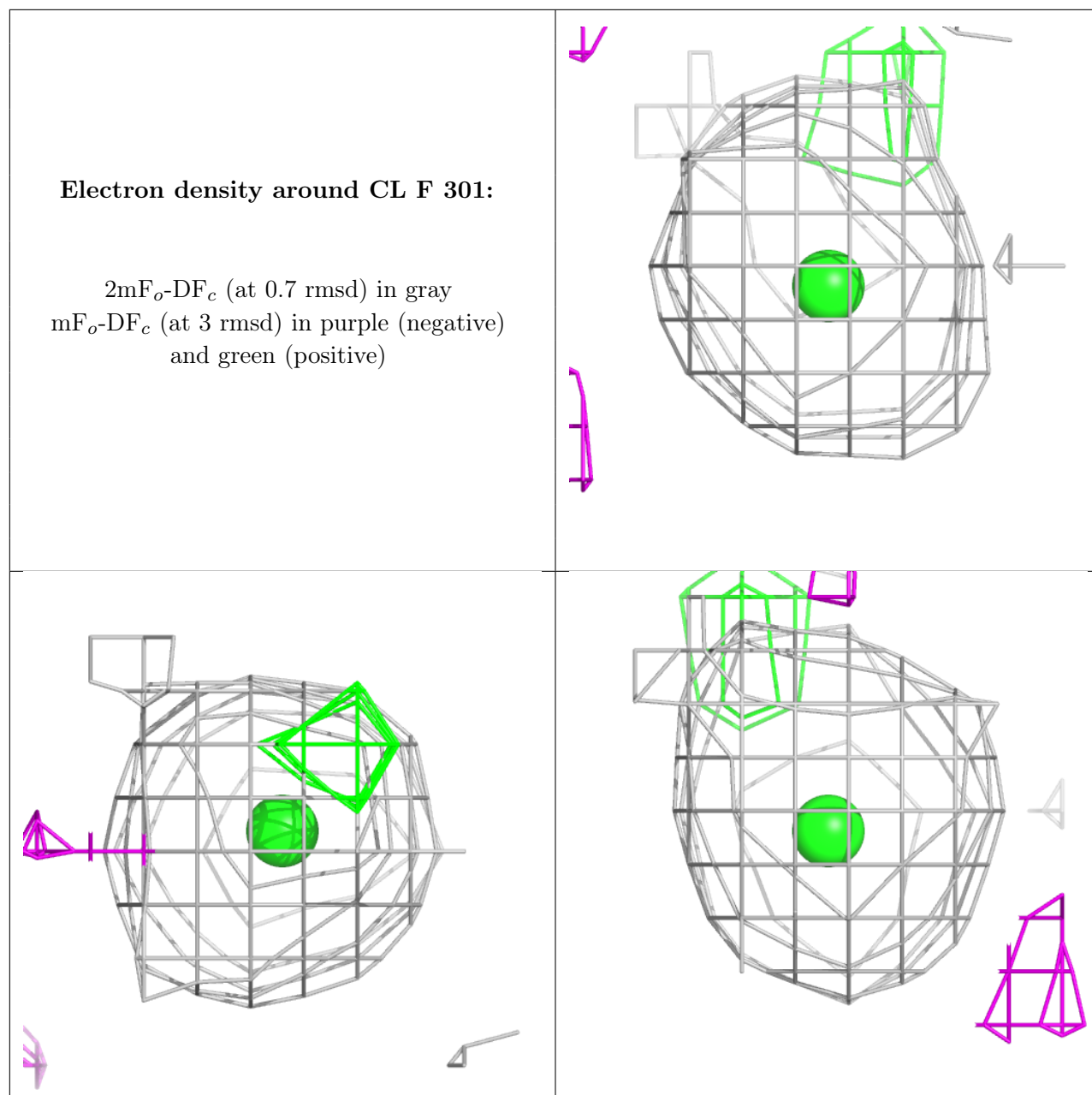

Electron density around CL M 505:

$2mF_o-DF_c$ (at 0.7 rmsd) in gray
 mF_o-DF_c (at 3 rmsd) in purple (negative)
and green (positive)

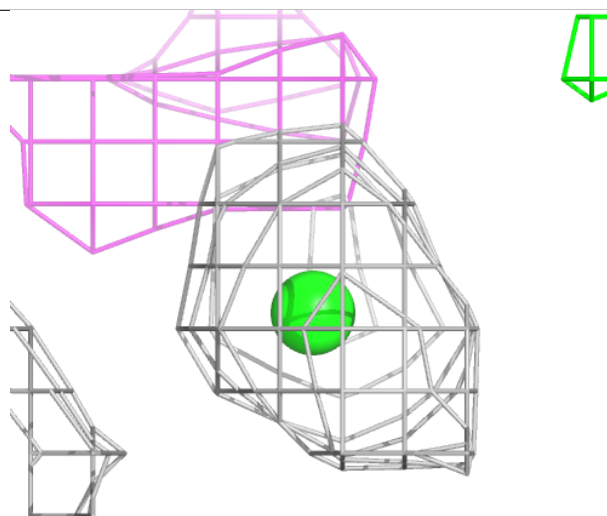
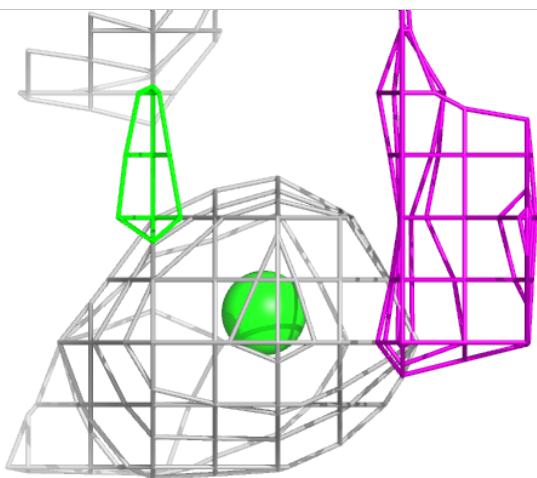
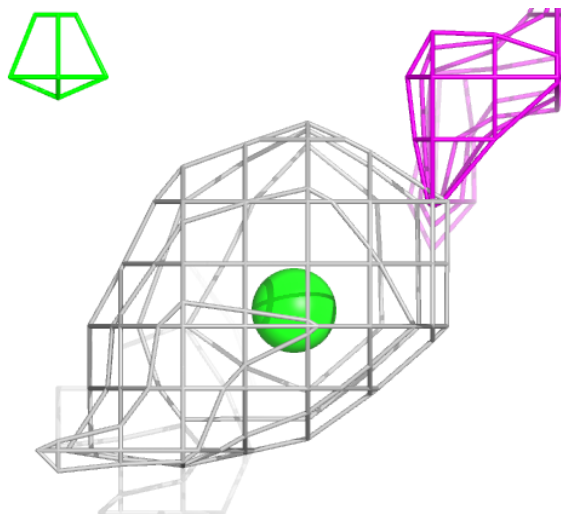

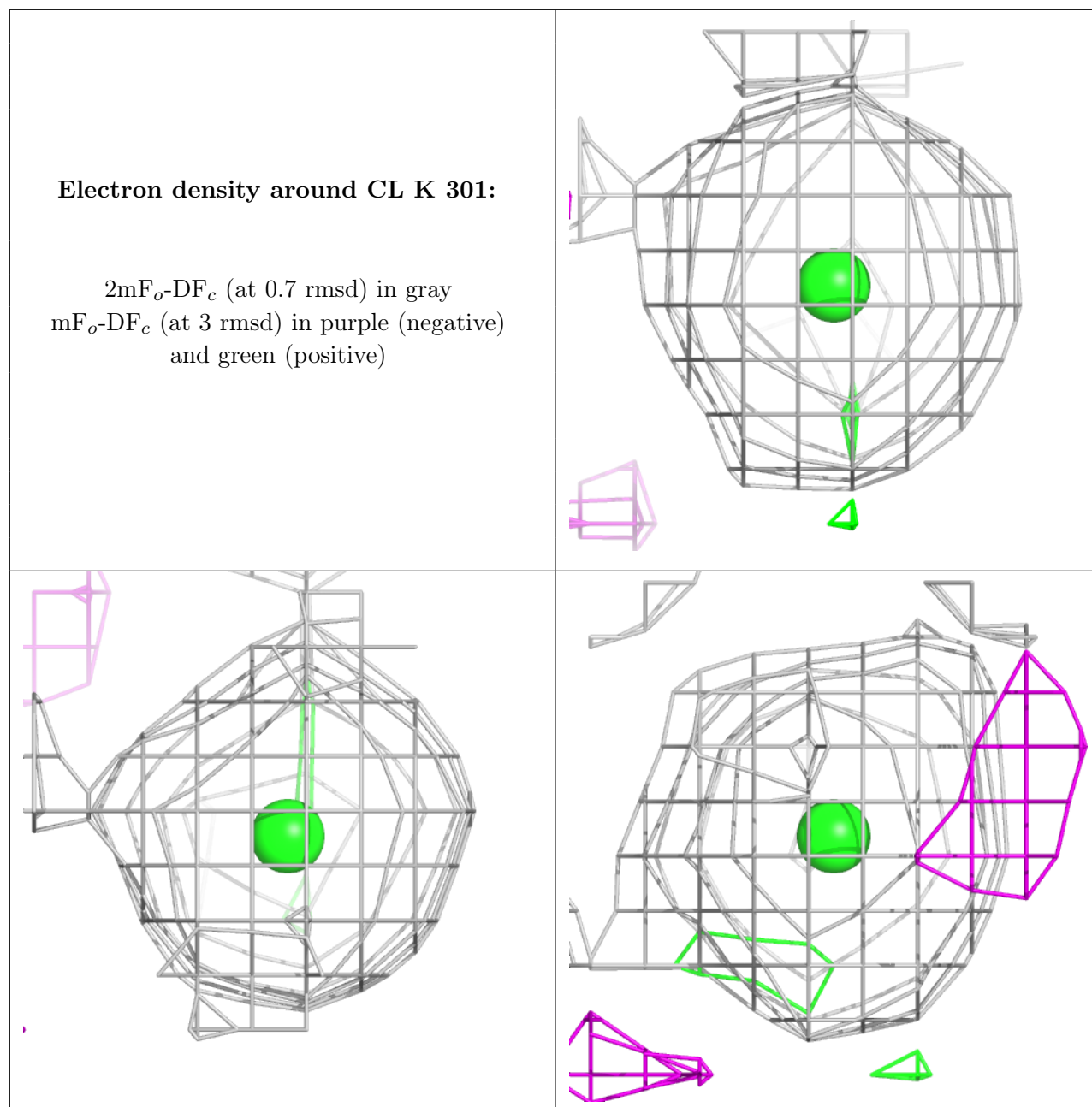

6.5 Other polymers [i](#)

There are no such residues in this entry.