



Full wwPDB X-ray Structure Validation Report ⓘ

Nov 22, 2023 – 10:38 AM JST

PDB ID : 7CDA
Title : Crystal structure of T2R-TTL-PAC complex
Authors : Chen, L.J.; Chen, Q.; Yu, Y.; Yang, J.H.
Deposited on : 2020-06-19
Resolution : 2.66 Å(reported)

This is a Full wwPDB X-ray Structure Validation Report for a publicly released PDB entry.

We welcome your comments at validation@mail.wwpdb.org

A user guide is available at

<https://www.wwpdb.org/validation/2017/XrayValidationReportHelp>

with specific help available everywhere you see the ⓘ symbol.

The types of validation reports are described at

<http://www.wwpdb.org/validation/2017/FAQs#types>.

The following versions of software and data (see [references ⓘ](#)) were used in the production of this report:

MolProbity : 4.02b-467
Mogul : 1.8.5 (274361), CSD as541be (2020)
Xtriage (Phenix) : 1.13
EDS : 2.36
buster-report : 1.1.7 (2018)
Percentile statistics : 20191225.v01 (using entries in the PDB archive December 25th 2019)
Refmac : 5.8.0158
CCP4 : 7.0.044 (Gargrove)
Ideal geometry (proteins) : Engh & Huber (2001)
Ideal geometry (DNA, RNA) : Parkinson et al. (1996)
Validation Pipeline (wwPDB-VP) : 2.36

1 Overall quality at a glance

The following experimental techniques were used to determine the structure:

X-RAY DIFFRACTION

The reported resolution of this entry is 2.66 Å.

Percentile scores (ranging between 0-100) for global validation metrics of the entry are shown in the following graphic. The table shows the number of entries on which the scores are based.

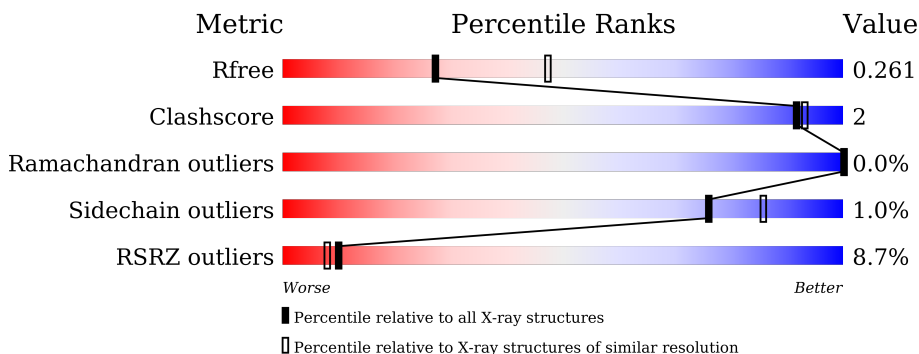

Metric	Whole archive (#Entries)	Similar resolution (#Entries, resolution range(Å))
R_{free}	130704	1332 (2.68-2.64)
Clashscore	141614	1374 (2.68-2.64)
Ramachandran outliers	138981	1349 (2.68-2.64)
Sidechain outliers	138945	1349 (2.68-2.64)
RSRZ outliers	127900	1318 (2.68-2.64)

The table below summarises the geometric issues observed across the polymeric chains and their fit to the electron density. The red, orange, yellow and green segments of the lower bar indicate the fraction of residues that contain outliers for ≥ 3 , 2, 1 and 0 types of geometric quality criteria respectively. A grey segment represents the fraction of residues that are not modelled. The numeric value for each fraction is indicated below the corresponding segment, with a dot representing fractions $\leq 5\%$. The upper red bar (where present) indicates the fraction of residues that have poor fit to the electron density. The numeric value is given above the bar.

Mol	Chain	Length	Quality of chain
1	A	450	
1	C	450	
2	B	445	
2	D	445	
3	E	143	
4	F	384	

2 Entry composition i

There are 13 unique types of molecules in this entry. The entry contains 34882 atoms, of which 16913 are hydrogens and 0 are deuteriums.

In the tables below, the ZeroOcc column contains the number of atoms modelled with zero occupancy, the AltConf column contains the number of residues with at least one atom in alternate conformation and the Trace column contains the number of residues modelled with at most 2 atoms.

- Molecule 1 is a protein called Tubulin alpha-1B chain.

Mol	Chain	Residues	Atoms					ZeroOcc	AltConf	Trace	
			Total	C	H	N	O				S
1	A	437	6772	2174	3335	585	654	24	0	3	0
1	C	440	6783	2178	3340	585	657	23	0	1	0

- Molecule 2 is a protein called Tubulin beta chain.

Mol	Chain	Residues	Atoms					ZeroOcc	AltConf	Trace	
			Total	C	H	N	O				S
2	B	427	6589	2110	3228	576	649	26	0	0	0
2	D	421	6486	2080	3177	562	640	27	0	0	0

- Molecule 3 is a protein called Stathmin-4.

Mol	Chain	Residues	Atoms					ZeroOcc	AltConf	Trace	
			Total	C	H	N	O				S
3	E	121	2043	627	1025	186	200	5	0	2	0

There are 2 discrepancies between the modelled and reference sequences:

Chain	Residue	Modelled	Actual	Comment	Reference
E	3	MET	-	expression tag	UNP P63043
E	4	ALA	-	expression tag	UNP P63043

- Molecule 4 is a protein called Tubulin tyrosine ligase.

Mol	Chain	Residues	Atoms					ZeroOcc	AltConf	Trace	
			Total	C	H	N	O				S
4	F	338	5494	1785	2709	482	504	14	0	0	0

There are 6 discrepancies between the modelled and reference sequences:

Chain	Residue	Modelled	Actual	Comment	Reference
F	379	HIS	-	expression tag	UNP E1BQ43
F	380	HIS	-	expression tag	UNP E1BQ43
F	381	HIS	-	expression tag	UNP E1BQ43
F	382	HIS	-	expression tag	UNP E1BQ43
F	383	HIS	-	expression tag	UNP E1BQ43
F	384	HIS	-	expression tag	UNP E1BQ43

- Molecule 5 is GUANOSINE-5'-TRIPHOSPHATE (three-letter code: GTP) (formula: $C_{10}H_{16}N_5O_{14}P_3$).

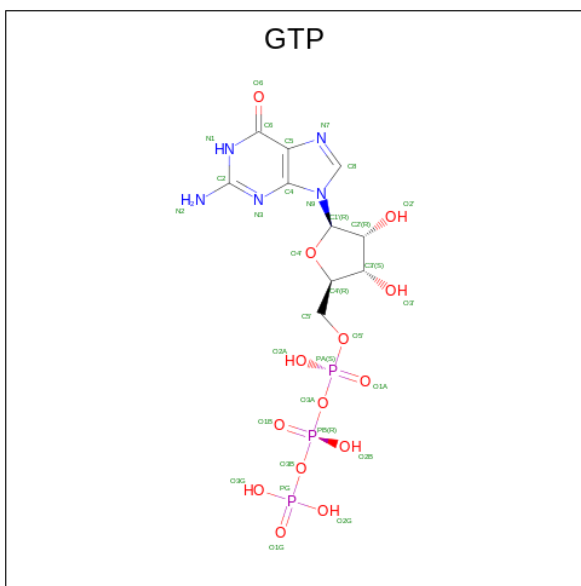

Mol	Chain	Residues	Atoms					ZeroOcc	AltConf	
			Total	C	H	N	O			P
5	A	1	Total	C	H	N	O	P	0	0
			42	10	10	5	14	3		
5	C	1	Total	C	H	N	O	P	0	0
			42	10	10	5	14	3		
5	D	1	Total	C	H	N	O	P	0	0
			42	10	10	5	14	3		

- Molecule 6 is MAGNESIUM ION (three-letter code: MG) (formula: Mg).

Mol	Chain	Residues	Atoms		ZeroOcc	AltConf
6	A	1	Total	Mg	0	0
			1	1		
6	B	1	Total	Mg	0	0
			1	1		
6	C	1	Total	Mg	0	0
			1	1		

Continued on next page...

Continued from previous page...

Mol	Chain	Residues	Atoms		ZeroOcc	AltConf
6	D	1	Total	Mg	0	0
			1	1		

- Molecule 7 is CALCIUM ION (three-letter code: CA) (formula: Ca).

Mol	Chain	Residues	Atoms		ZeroOcc	AltConf
7	A	1	Total	Ca	0	0
			1	1		
7	C	1	Total	Ca	0	0
			1	1		

- Molecule 8 is GLYCEROL (three-letter code: GOL) (formula: C₃H₈O₃).

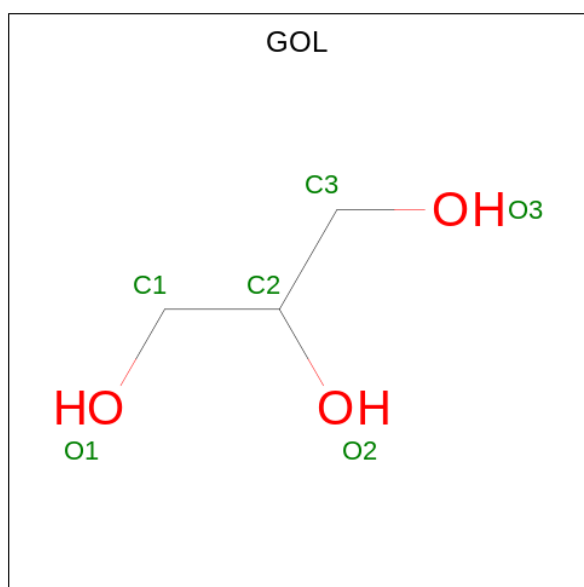

Mol	Chain	Residues	Atoms				ZeroOcc	AltConf
8	A	1	Total	C	H	O	0	0
			14	3	8	3		

- Molecule 9 is GUANOSINE-5'-DIPHOSPHATE (three-letter code: GDP) (formula: C₁₀H₁₅N₅O₁₁P₂).

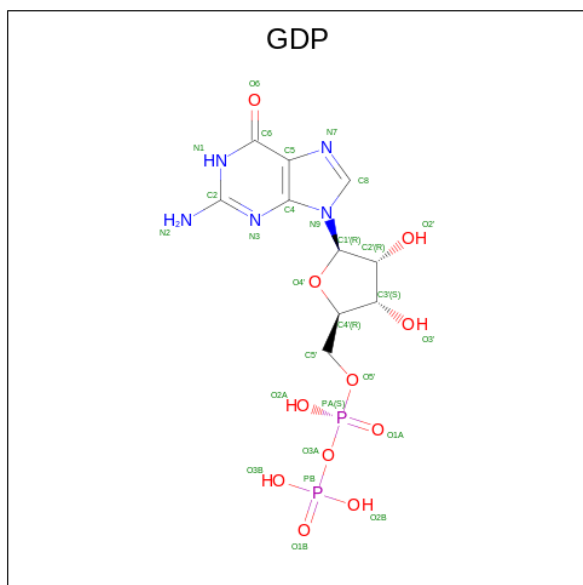

Mol	Chain	Residues	Atoms					ZeroOcc	AltConf	
			Total	C	H	N	O			P
9	B	1	38	10	10	5	11	2	0	0

- Molecule 10 is 2-(N-MORPHOLINO)-ETHANESULFONIC ACID (three-letter code: MES) (formula: $C_6H_{13}NO_4S$).

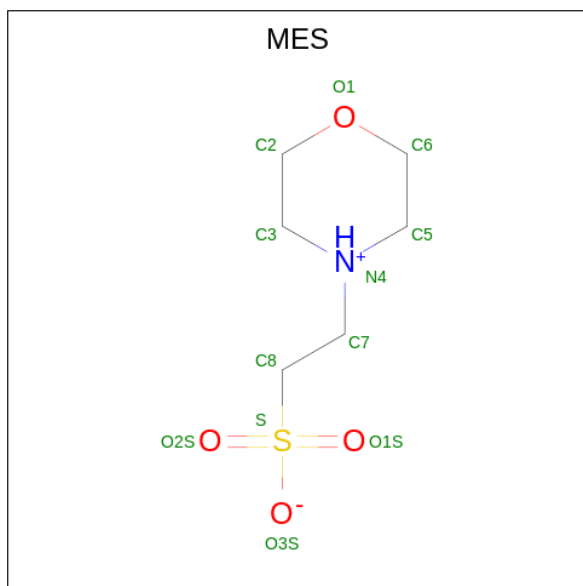

Mol	Chain	Residues	Atoms					ZeroOcc	AltConf	
			Total	C	H	N	O			S
10	B	1	25	6	13	1	4	1	0	0

- Molecule 11 is N-[(3-phenoxyphenyl)methyl]-9H-beta-carboline-3-amine (three-letter code: AEU) (formula: $C_{24}H_{19}N_3O$) (labeled as "Ligand of Interest" by depositor).

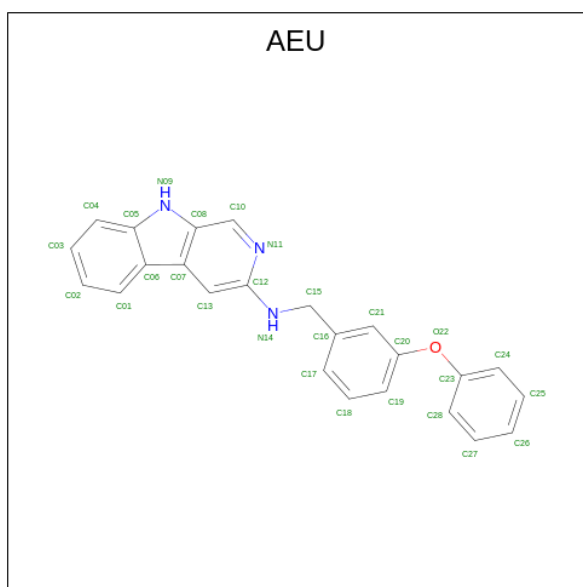

Mol	Chain	Residues	Atoms					ZeroOcc	AltConf
			Total	C	H	N	O		
11	B	1	47	24	19	3	1	0	0
11	D	1	47	24	19	3	1	0	0

- Molecule 12 is PHOSPHOMETHYLPHOSPHONIC ACID ADENYLATE ESTER (three-letter code: ACP) (formula: $C_{11}H_{18}N_5O_{12}P_3$).

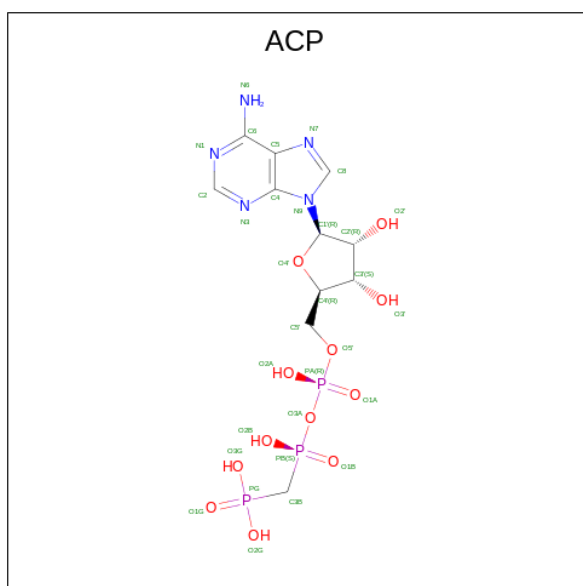

Mol	Chain	Residues	Atoms					ZeroOcc	AltConf
			Total	C	N	O	P		
12	F	1	31	11	5	12	3	0	0

- Molecule 13 is water.

Mol	Chain	Residues	Atoms		ZeroOcc	AltConf
13	A	104	Total 104	O 104	0	0
13	B	69	Total 69	O 69	0	0
13	C	120	Total 120	O 120	0	0
13	D	35	Total 35	O 35	0	0
13	E	13	Total 13	O 13	0	0
13	F	40	Total 40	O 40	0	0

3 Residue-property plots [i](#)

These plots are drawn for all protein, RNA, DNA and oligosaccharide chains in the entry. The first graphic for a chain summarises the proportions of the various outlier classes displayed in the second graphic. The second graphic shows the sequence view annotated by issues in geometry and electron density. Residues are color-coded according to the number of geometric quality criteria for which they contain at least one outlier: green = 0, yellow = 1, orange = 2 and red = 3 or more. A red dot above a residue indicates a poor fit to the electron density ($RSRZ > 2$). Stretches of 2 or more consecutive residues without any outlier are shown as a green connector. Residues present in the sample, but not in the model, are shown in grey.

- Molecule 1: Tubulin alpha-1B chain

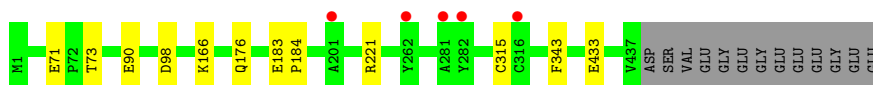

- Molecule 1: Tubulin alpha-1B chain

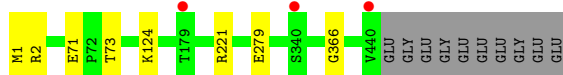

- Molecule 2: Tubulin beta chain

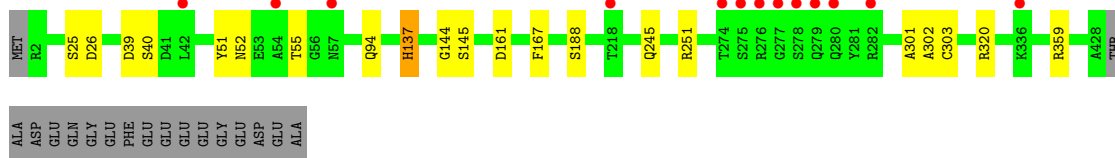
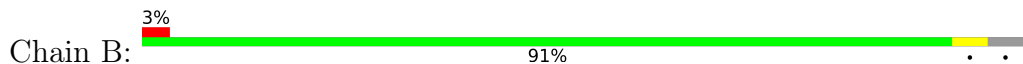

- Molecule 2: Tubulin beta chain

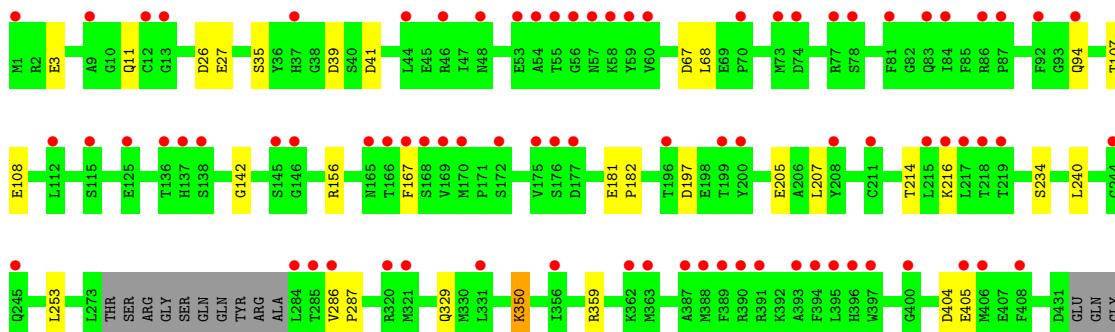
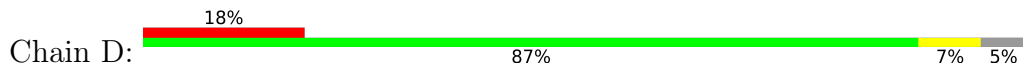

GLU
PHE
GLU
GLU
GLU
GLU
GLY
GLY
ASP
GLU
ALA

• Molecule 3: Stathmin-4

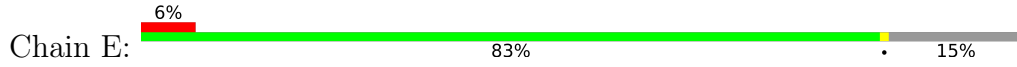

• Molecule 4: Tubulin tyrosine ligase

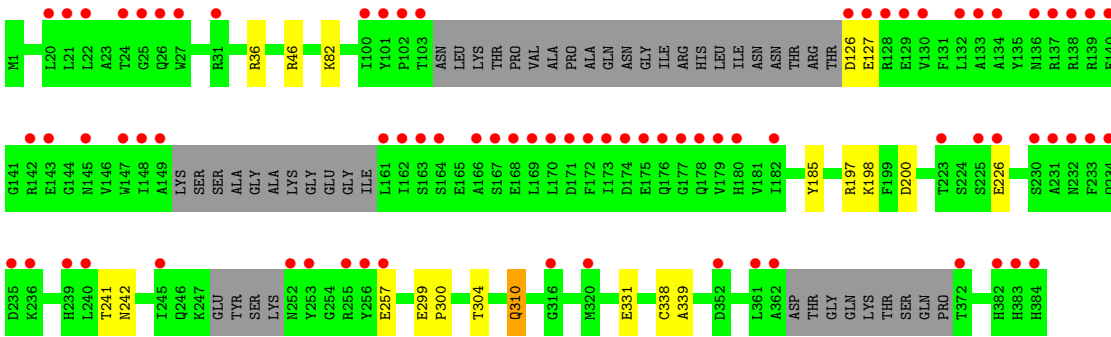
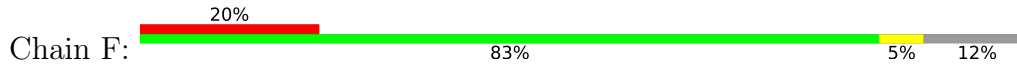

4 Data and refinement statistics

Property	Value	Source
Space group	P 21 21 21	Depositor
Cell constants a, b, c, α , β , γ	105.09Å 156.83Å 182.41Å 90.00° 90.00° 90.00°	Depositor
Resolution (Å)	39.76 – 2.66 39.76 – 2.66	Depositor EDS
% Data completeness (in resolution range)	98.2 (39.76-2.66) 98.2 (39.76-2.66)	Depositor EDS
R_{merge}	(Not available)	Depositor
R_{sym}	(Not available)	Depositor
$\langle I/\sigma(I) \rangle$ ¹	2.63 (at 2.65Å)	Xtrriage
Refinement program	PHENIX 1.8.4_1496	Depositor
R, R_{free}	0.222 , 0.257 0.225 , 0.261	Depositor DCC
R_{free} test set	4281 reflections (5.00%)	wwPDB-VP
Wilson B-factor (Å ²)	41.2	Xtrriage
Anisotropy	0.093	Xtrriage
Bulk solvent k_{sol} (e/Å ³), B_{sol} (Å ²)	0.35 , 43.5	EDS
L-test for twinning ²	$\langle L \rangle = 0.50$, $\langle L^2 \rangle = 0.34$	Xtrriage
Estimated twinning fraction	No twinning to report.	Xtrriage
F_o, F_c correlation	0.92	EDS
Total number of atoms	34882	wwPDB-VP
Average B, all atoms (Å ²)	57.0	wwPDB-VP

Xtrriage's analysis on translational NCS is as follows: *The largest off-origin peak in the Patterson function is 2.88% of the height of the origin peak. No significant pseudotranslation is detected.*

¹Intensities estimated from amplitudes.

²Theoretical values of $\langle |L| \rangle$, $\langle L^2 \rangle$ for acentric reflections are 0.5, 0.333 respectively for untwinned datasets, and 0.375, 0.2 for perfectly twinned datasets.

5 Model quality [i](#)

5.1 Standard geometry [i](#)

Bond lengths and bond angles in the following residue types are not validated in this section: AEU, MG, GDP, GTP, GOL, MES, ACP, CA

The Z score for a bond length (or angle) is the number of standard deviations the observed value is removed from the expected value. A bond length (or angle) with $|Z| > 5$ is considered an outlier worth inspection. RMSZ is the root-mean-square of all Z scores of the bond lengths (or angles).

Mol	Chain	Bond lengths		Bond angles	
		RMSZ	# Z >5	RMSZ	# Z >5
1	A	0.23	0/3515	0.39	0/4771
1	C	0.23	0/3521	0.38	0/4781
2	B	0.23	0/3436	0.39	0/4654
2	D	0.23	0/3382	0.38	0/4581
3	E	0.21	0/1027	0.32	0/1363
4	F	0.22	0/2851	0.37	0/3851
All	All	0.22	0/17732	0.38	0/24001

There are no bond length outliers.

There are no bond angle outliers.

There are no chirality outliers.

There are no planarity outliers.

5.2 Too-close contacts [i](#)

In the following table, the Non-H and H(model) columns list the number of non-hydrogen atoms and hydrogen atoms in the chain respectively. The H(added) column lists the number of hydrogen atoms added and optimized by MolProbity. The Clashes column lists the number of clashes within the asymmetric unit, whereas Symm-Clashes lists symmetry-related clashes.

Mol	Chain	Non-H	H(model)	H(added)	Clashes	Symm-Clashes
1	A	3437	3335	3346	7	0
1	C	3443	3340	3353	5	0
2	B	3361	3228	3238	9	0
2	D	3309	3177	3189	17	0
3	E	1018	1025	1029	1	0
4	F	2785	2709	2737	15	0
5	A	32	10	12	0	0

Continued on next page...

Continued from previous page...

Mol	Chain	Non-H	H(model)	H(added)	Clashes	Symm-Clashes
5	C	32	10	12	0	0
5	D	32	10	12	1	0
6	A	1	0	0	0	0
6	B	1	0	0	0	0
6	C	1	0	0	0	0
6	D	1	0	0	0	0
7	A	1	0	0	0	0
7	C	1	0	0	0	0
8	A	6	8	8	0	0
9	B	28	10	12	0	0
10	B	12	13	12	0	0
11	B	28	19	0	0	0
11	D	28	19	0	1	0
12	F	31	0	14	6	0
13	A	104	0	0	1	0
13	B	69	0	0	1	0
13	C	120	0	0	3	0
13	D	35	0	0	3	0
13	E	13	0	0	1	0
13	F	40	0	0	2	0
All	All	17969	16913	16974	55	0

The all-atom clashscore is defined as the number of clashes found per 1000 atoms (including hydrogen atoms). The all-atom clashscore for this structure is 2.

All (55) close contacts within the same asymmetric unit are listed below, sorted by their clash magnitude.

Atom-1	Atom-2	Interatomic distance (Å)	Clash overlap (Å)
4:F:242:ASN:OD1	12:F:401:ACP:H5'1	1.62	0.98
4:F:331:GLU:OE2	12:F:401:ACP:O2G	1.93	0.87
12:F:401:ACP:O2G	12:F:401:ACP:O1B	2.05	0.74
2:D:207:LEU:O	13:D:601:HOH:O	2.09	0.70
2:D:214:THR:N	13:D:604:HOH:O	2.28	0.66
1:A:433:GLU:OE2	4:F:46:ARG:NH1	2.29	0.66
4:F:241:THR:OG1	12:F:401:ACP:O3'	2.05	0.66
12:F:401:ACP:O1A	12:F:401:ACP:H3B2	1.99	0.63
4:F:82:LYS:NZ	13:F:503:HOH:O	2.32	0.62
2:D:26:ASP:OD1	2:D:359:ARG:NH2	2.33	0.61
4:F:304:THR:O	4:F:310:GLN:NE2	2.34	0.61
3:E:92:ASN:ND2	13:E:202:HOH:O	2.33	0.60
4:F:36:ARG:NH2	13:F:501:HOH:O	2.33	0.59

Continued on next page...

Continued from previous page...

Atom-1	Atom-2	Interatomic distance (Å)	Clash overlap (Å)
1:A:166:LYS:NZ	13:A:605:HOH:O	2.36	0.59
1:A:71:GLU:OE2	1:A:73:THR:OG1	2.21	0.58
4:F:200:ASP:OD1	4:F:241:THR:OG1	2.22	0.58
2:B:301:ALA:O	2:B:303:CYS:N	2.36	0.57
4:F:242:ASN:OD1	12:F:401:ACP:C5'	2.45	0.56
2:B:26:ASP:OD1	2:B:359:ARG:NH1	2.39	0.56
2:D:107:THR:OG1	2:D:108:GLU:N	2.38	0.56
4:F:338:CYS:SG	4:F:339:ALA:N	2.79	0.56
2:B:94:GLN:NE2	13:B:608:HOH:O	2.42	0.53
2:D:216:LYS:N	13:D:604:HOH:O	2.31	0.53
2:D:404:ASP:OD1	2:D:405:GLU:N	2.41	0.53
1:C:1:MET:N	13:C:612:HOH:O	2.39	0.52
2:B:137:HIS:ND1	2:B:144:GLY:O	2.32	0.52
4:F:126:ASP:OD1	4:F:127:GLU:N	2.44	0.51
4:F:197:ARG:NH1	4:F:257:GLU:OE2	2.44	0.49
2:D:94:GLN:OE1	2:D:94:GLN:N	2.46	0.49
2:D:27:GLU:OE1	2:D:234:SER:OG	2.29	0.49
2:B:145:SER:HG	2:B:188:SER:HG	1.61	0.48
2:B:161:ASP:O	2:B:251:ARG:NH2	2.47	0.48
1:C:279:GLU:N	1:C:279:GLU:OE1	2.47	0.48
1:C:366:GLY:N	13:C:619:HOH:O	2.48	0.47
2:D:156:ARG:NH1	2:D:197:ASP:OD2	2.48	0.47
1:A:90:GLU:OE1	1:A:90:GLU:N	2.48	0.46
4:F:185:TYR:OH	4:F:198:LYS:NZ	2.48	0.45
2:B:25:SER:OG	2:B:51:TYR:OH	2.33	0.44
2:B:39:ASP:OD1	2:B:40:SER:N	2.50	0.43
4:F:226:GLU:OE1	4:F:226:GLU:N	2.50	0.43
2:D:181:GLU:N	2:D:182:PRO:HD2	2.33	0.43
2:D:350:LYS:HE3	2:D:350:LYS:HA	2.00	0.43
1:A:183:GLU:N	1:A:184:PRO:CD	2.82	0.43
2:D:287:PRO:HA	2:D:329:GLN:HG2	2.01	0.42
2:D:142:GLY:N	5:D:501:GTP:O2B	2.49	0.42
1:C:124:LYS:NZ	13:C:621:HOH:O	2.51	0.42
2:D:3:GLU:N	2:D:3:GLU:OE2	2.53	0.42
2:D:67:ASP:OD1	2:D:68:LEU:N	2.53	0.41
2:B:55:THR:O	2:B:55:THR:OG1	2.34	0.41
1:C:71:GLU:OE2	1:C:73:THR:N	2.51	0.41
2:D:286:VAL:N	2:D:287:PRO:CD	2.83	0.41
1:A:315[B]:CYS:HG	1:A:343:PHE:HZ	1.66	0.41
1:A:71:GLU:HB2	1:A:98:ASP:HB3	2.02	0.40
2:D:253:LEU:HB3	11:D:502:AEU:C10	2.51	0.40

Continued on next page...

Continued from previous page...

Atom-1	Atom-2	Interatomic distance (Å)	Clash overlap (Å)
4:F:299:GLU:N	4:F:300:PRO:HD2	2.36	0.40

There are no symmetry-related clashes.

5.3 Torsion angles [i](#)

5.3.1 Protein backbone [i](#)

In the following table, the Percentiles column shows the percent Ramachandran outliers of the chain as a percentile score with respect to all X-ray entries followed by that with respect to entries of similar resolution.

The Analysed column shows the number of residues for which the backbone conformation was analysed, and the total number of residues.

Mol	Chain	Analysed	Favoured	Allowed	Outliers	Percentiles	
1	A	438/450 (97%)	424 (97%)	14 (3%)	0	100	100
1	C	439/450 (98%)	427 (97%)	12 (3%)	0	100	100
2	B	425/445 (96%)	411 (97%)	13 (3%)	1 (0%)	47	64
2	D	417/445 (94%)	403 (97%)	14 (3%)	0	100	100
3	E	119/143 (83%)	117 (98%)	2 (2%)	0	100	100
4	F	328/384 (85%)	309 (94%)	19 (6%)	0	100	100
All	All	2166/2317 (94%)	2091 (96%)	74 (3%)	1 (0%)	100	100

All (1) Ramachandran outliers are listed below:

Mol	Chain	Res	Type
2	B	302	ALA

5.3.2 Protein sidechains [i](#)

In the following table, the Percentiles column shows the percent sidechain outliers of the chain as a percentile score with respect to all X-ray entries followed by that with respect to entries of similar resolution.

The Analysed column shows the number of residues for which the sidechain conformation was analysed, and the total number of residues.

Mol	Chain	Analysed	Rotameric	Outliers	Percentiles	
1	A	371/378 (98%)	368 (99%)	3 (1%)	81	89
1	C	372/378 (98%)	370 (100%)	2 (0%)	88	94
2	B	369/383 (96%)	364 (99%)	5 (1%)	67	81
2	D	364/383 (95%)	356 (98%)	8 (2%)	52	70
3	E	111/127 (87%)	110 (99%)	1 (1%)	78	87
4	F	305/342 (89%)	304 (100%)	1 (0%)	92	96
All	All	1892/1991 (95%)	1872 (99%)	20 (1%)	76	85

All (20) residues with a non-rotameric sidechain are listed below:

Mol	Chain	Res	Type
1	A	176[A]	GLN
1	A	176[B]	GLN
1	A	221	ARG
2	B	52	ASN
2	B	137	HIS
2	B	167	PHE
2	B	245	GLN
2	B	320	ARG
1	C	2	ARG
1	C	221	ARG
2	D	11	GLN
2	D	35	SER
2	D	39	ASP
2	D	41	ASP
2	D	167	PHE
2	D	205	GLU
2	D	240	LEU
2	D	350	LYS
3	E	75	LYS
4	F	310	GLN

Sometimes sidechains can be flipped to improve hydrogen bonding and reduce clashes. All (2) such sidechains are listed below:

Mol	Chain	Res	Type
2	B	190	HIS
4	F	180	HIS

5.3.3 RNA [i](#)

There are no RNA molecules in this entry.

5.4 Non-standard residues in protein, DNA, RNA chains [i](#)

There are no non-standard protein/DNA/RNA residues in this entry.

5.5 Carbohydrates [i](#)

There are no monosaccharides in this entry.

5.6 Ligand geometry [i](#)

Of 15 ligands modelled in this entry, 6 are monoatomic - leaving 9 for Mogul analysis.

In the following table, the Counts columns list the number of bonds (or angles) for which Mogul statistics could be retrieved, the number of bonds (or angles) that are observed in the model and the number of bonds (or angles) that are defined in the Chemical Component Dictionary. The Link column lists molecule types, if any, to which the group is linked. The Z score for a bond length (or angle) is the number of standard deviations the observed value is removed from the expected value. A bond length (or angle) with $|Z| > 2$ is considered an outlier worth inspection. RMSZ is the root-mean-square of all Z scores of the bond lengths (or angles).

Mol	Type	Chain	Res	Link	Bond lengths			Bond angles		
					Counts	RMSZ	# Z > 2	Counts	RMSZ	# Z > 2
5	GTP	C	501	6	26,34,34	1.15	2 (7%)	32,54,54	1.45	6 (18%)
11	AEU	B	504	-	31,32,32	1.47	7 (22%)	42,44,44	1.05	3 (7%)
9	GDP	B	501	6	24,30,30	0.97	1 (4%)	30,47,47	1.12	3 (10%)
11	AEU	D	502	-	31,32,32	1.52	7 (22%)	42,44,44	1.07	5 (11%)
5	GTP	D	501	6	26,34,34	1.13	2 (7%)	32,54,54	1.44	6 (18%)
10	MES	B	503	-	12,12,12	2.21	1 (8%)	14,16,16	1.70	2 (14%)
12	ACP	F	401	-	27,33,33	1.37	3 (11%)	32,52,52	1.76	8 (25%)
8	GOL	A	504	-	5,5,5	0.37	0	5,5,5	0.25	0
5	GTP	A	501	6	26,34,34	1.16	2 (7%)	32,54,54	1.47	6 (18%)

In the following table, the Chirals column lists the number of chiral outliers, the number of chiral centers analysed, the number of these observed in the model and the number defined in the Chemical Component Dictionary. Similar counts are reported in the Torsion and Rings columns. '-' means no outliers of that kind were identified.

Mol	Type	Chain	Res	Link	Chirals	Torsions	Rings
5	GTP	C	501	6	-	6/18/38/38	0/3/3/3
11	AEU	B	504	-	-	0/9/9/9	0/5/5/5
9	GDP	B	501	6	-	5/12/32/32	0/3/3/3
11	AEU	D	502	-	-	0/9/9/9	0/5/5/5
5	GTP	D	501	6	-	3/18/38/38	0/3/3/3
10	MES	B	503	-	-	3/6/14/14	0/1/1/1
12	ACP	F	401	-	-	9/15/38/38	0/3/3/3
8	GOL	A	504	-	-	2/4/4/4	-
5	GTP	A	501	6	-	7/18/38/38	0/3/3/3

All (25) bond length outliers are listed below:

Mol	Chain	Res	Type	Atoms	Z	Observed(Å)	Ideal(Å)
10	B	503	MES	C8-S	-7.41	1.67	1.77
5	A	501	GTP	C5-C6	-4.19	1.38	1.47
5	C	501	GTP	C5-C6	-4.13	1.39	1.47
5	D	501	GTP	C5-C6	-4.02	1.39	1.47
12	F	401	ACP	C2'-C1'	-3.17	1.48	1.53
11	D	502	AEU	C02-C01	2.97	1.43	1.36
11	B	504	AEU	C02-C01	2.80	1.43	1.36
12	F	401	ACP	PG-O2G	2.79	1.61	1.54
9	B	501	GDP	C6-N1	-2.74	1.33	1.37
11	D	502	AEU	C12-N14	2.71	1.40	1.36
11	D	502	AEU	C21-C20	2.44	1.43	1.38
11	B	504	AEU	C12-N14	2.43	1.39	1.36
12	F	401	ACP	PG-O3G	2.42	1.60	1.54
11	B	504	AEU	C21-C20	2.40	1.43	1.38
11	D	502	AEU	C17-C16	2.36	1.43	1.38
5	D	501	GTP	C2-N3	2.33	1.38	1.33
11	B	504	AEU	C17-C16	2.31	1.43	1.38
11	D	502	AEU	C21-C16	-2.23	1.35	1.39
11	B	504	AEU	C21-C16	-2.15	1.35	1.39
5	A	501	GTP	C2-N3	2.12	1.38	1.33
11	B	504	AEU	C24-C23	2.09	1.42	1.38
5	C	501	GTP	C2-N3	2.07	1.38	1.33
11	B	504	AEU	C06-C05	-2.05	1.37	1.42
11	D	502	AEU	C04-C05	2.03	1.45	1.41
11	D	502	AEU	C24-C23	2.03	1.42	1.38

All (39) bond angle outliers are listed below:

Mol	Chain	Res	Type	Atoms	Z	Observed(°)	Ideal(°)
11	B	504	AEU	C10-N11-C12	4.10	121.95	117.81
12	F	401	ACP	N3-C2-N1	-4.06	122.33	128.68
11	D	502	AEU	C10-N11-C12	4.01	121.86	117.81
10	B	503	MES	C5-N4-C3	3.83	117.45	108.83
12	F	401	ACP	C4-C5-N7	-3.70	105.54	109.40
10	B	503	MES	O3S-S-C8	3.59	111.57	105.77
5	A	501	GTP	PB-O3B-PG	-3.34	121.35	132.83
12	F	401	ACP	C3'-C2'-C1'	3.33	106.00	100.98
12	F	401	ACP	PB-O3A-PA	-3.23	122.30	132.56
5	A	501	GTP	C5-C6-N1	3.22	119.63	113.95
5	D	501	GTP	C5-C6-N1	3.21	119.61	113.95
5	C	501	GTP	PB-O3B-PG	-3.18	121.92	132.83
5	C	501	GTP	C5-C6-N1	3.13	119.48	113.95
11	D	502	AEU	C23-O22-C20	-3.13	111.49	118.80
5	D	501	GTP	C8-N7-C5	3.07	108.84	102.99
5	C	501	GTP	C8-N7-C5	2.98	108.66	102.99
5	A	501	GTP	PA-O3A-PB	-2.91	122.84	132.83
5	A	501	GTP	C8-N7-C5	2.91	108.53	102.99
5	D	501	GTP	C2-N1-C6	-2.88	119.79	125.10
5	A	501	GTP	C2-N1-C6	-2.80	119.95	125.10
9	B	501	GDP	PA-O3A-PB	-2.79	123.26	132.83
5	D	501	GTP	PB-O3B-PG	-2.78	123.28	132.83
11	B	504	AEU	C23-O22-C20	-2.78	112.30	118.80
5	C	501	GTP	C2-N1-C6	-2.72	120.09	125.10
12	F	401	ACP	C2-N1-C6	2.72	123.40	118.75
5	C	501	GTP	PA-O3A-PB	-2.67	123.65	132.83
12	F	401	ACP	O2'-C2'-C1'	-2.48	101.69	110.85
5	A	501	GTP	O6-C6-C5	-2.41	119.67	124.37
9	B	501	GDP	C5-C6-N1	2.38	118.16	113.95
9	B	501	GDP	C8-N7-C5	2.35	107.47	102.99
5	C	501	GTP	O6-C6-C5	-2.20	120.08	124.37
11	D	502	AEU	C13-C07-C06	2.19	135.32	132.28
5	D	501	GTP	O6-C6-C5	-2.17	120.12	124.37
11	D	502	AEU	C16-C15-N14	-2.15	108.18	113.77
11	D	502	AEU	C13-C12-N11	-2.12	119.78	122.75
11	B	504	AEU	C16-C15-N14	-2.11	108.29	113.77
12	F	401	ACP	C5-C6-N6	2.06	123.47	120.35
5	D	501	GTP	C3'-C2'-C1'	2.03	104.04	100.98
12	F	401	ACP	O2G-PG-O1G	-2.02	107.03	112.39

There are no chirality outliers.

All (35) torsion outliers are listed below:

Mol	Chain	Res	Type	Atoms
5	A	501	GTP	PB-O3B-PG-O2G
5	A	501	GTP	C5'-O5'-PA-O1A
5	A	501	GTP	C5'-O5'-PA-O2A
5	C	501	GTP	PB-O3B-PG-O2G
5	C	501	GTP	C5'-O5'-PA-O1A
5	C	501	GTP	C5'-O5'-PA-O2A
8	A	504	GOL	O1-C1-C2-C3
9	B	501	GDP	C5'-O5'-PA-O1A
9	B	501	GDP	C5'-O5'-PA-O2A
10	B	503	MES	C7-C8-S-O1S
10	B	503	MES	C7-C8-S-O3S
12	F	401	ACP	PG-C3B-PB-O1B
12	F	401	ACP	PG-C3B-PB-O3A
12	F	401	ACP	C5'-O5'-PA-O1A
12	F	401	ACP	O4'-C4'-C5'-O5'
12	F	401	ACP	C3'-C4'-C5'-O5'
8	A	504	GOL	O1-C1-C2-O2
9	B	501	GDP	PA-O3A-PB-O1B
5	D	501	GTP	PA-O3A-PB-O3B
5	C	501	GTP	C4'-C5'-O5'-PA
5	D	501	GTP	C4'-C5'-O5'-PA
9	B	501	GDP	PA-O3A-PB-O3B
12	F	401	ACP	C5'-O5'-PA-O3A
5	C	501	GTP	PB-O3A-PA-O2A
5	D	501	GTP	PG-O3B-PB-O1B
12	F	401	ACP	C5'-O5'-PA-O2A
10	B	503	MES	C7-C8-S-O2S
5	A	501	GTP	C4'-C5'-O5'-PA
5	A	501	GTP	PB-O3B-PG-O1G
5	A	501	GTP	PB-O3A-PA-O2A
12	F	401	ACP	PB-O3A-PA-O1A
12	F	401	ACP	PB-C3B-PG-O1G
5	A	501	GTP	C5'-O5'-PA-O3A
5	C	501	GTP	C5'-O5'-PA-O3A
9	B	501	GDP	C5'-O5'-PA-O3A

There are no ring outliers.

3 monomers are involved in 8 short contacts:

Mol	Chain	Res	Type	Clashes	Symm-Clashes
11	D	502	AEU	1	0
5	D	501	GTP	1	0
12	F	401	ACP	6	0

The following is a two-dimensional graphical depiction of Mogul quality analysis of bond lengths, bond angles, torsion angles, and ring geometry for all instances of the Ligand of Interest. In addition, ligands with molecular weight > 250 and outliers as shown on the validation Tables will also be included. For torsion angles, if less than 5% of the Mogul distribution of torsion angles is within 10 degrees of the torsion angle in question, then that torsion angle is considered an outlier. Any bond that is central to one or more torsion angles identified as an outlier by Mogul will be highlighted in the graph. For rings, the root-mean-square deviation (RMSD) between the ring in question and similar rings identified by Mogul is calculated over all ring torsion angles. If the average RMSD is greater than 60 degrees and the minimal RMSD between the ring in question and any Mogul-identified rings is also greater than 60 degrees, then that ring is considered an outlier. The outliers are highlighted in purple. The color gray indicates Mogul did not find sufficient equivalents in the CSD to analyse the geometry.

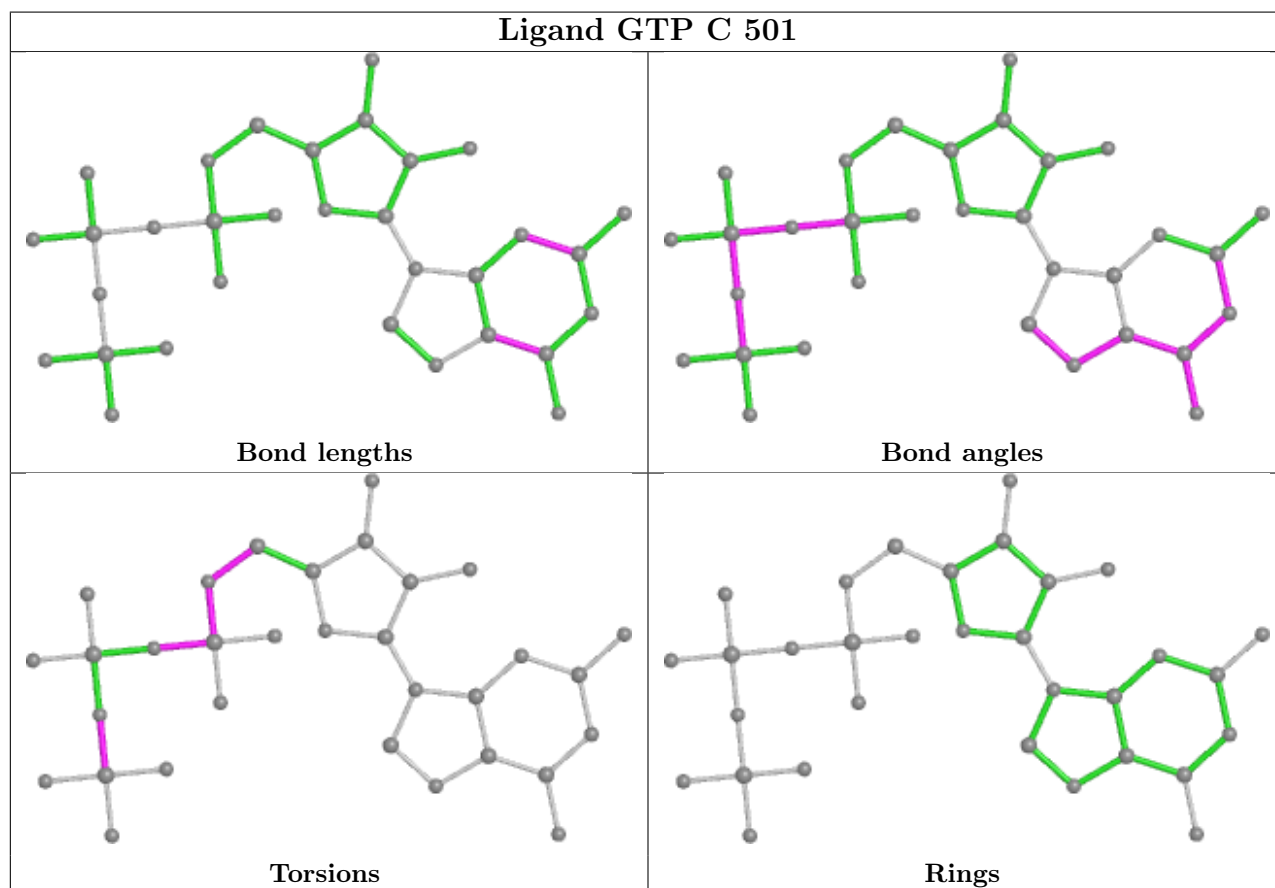

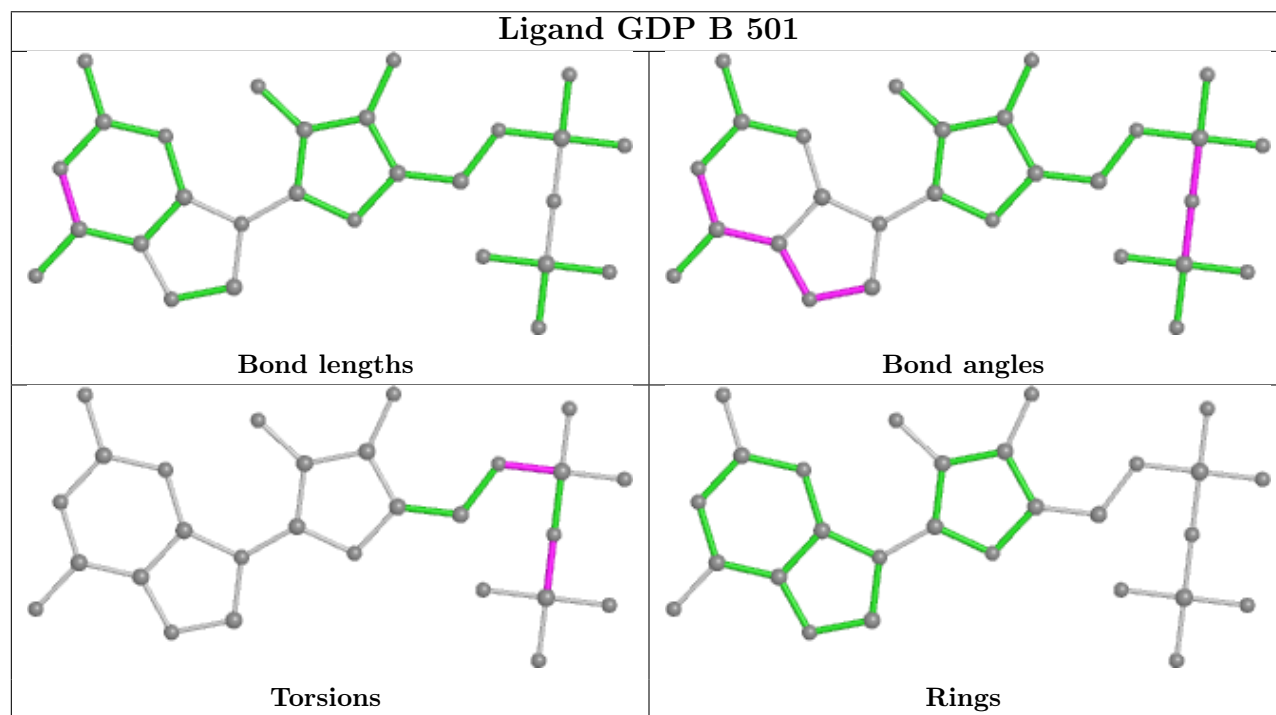
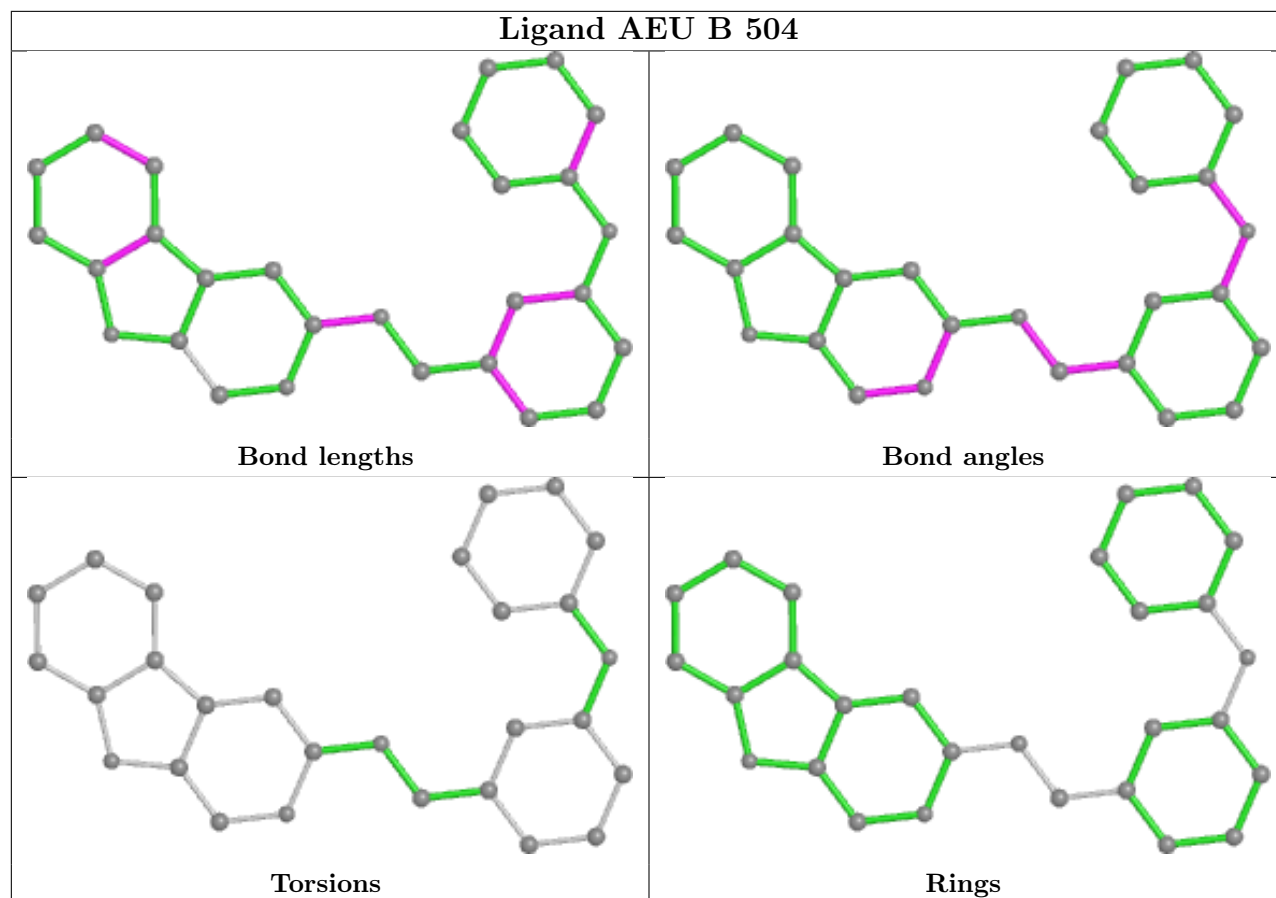

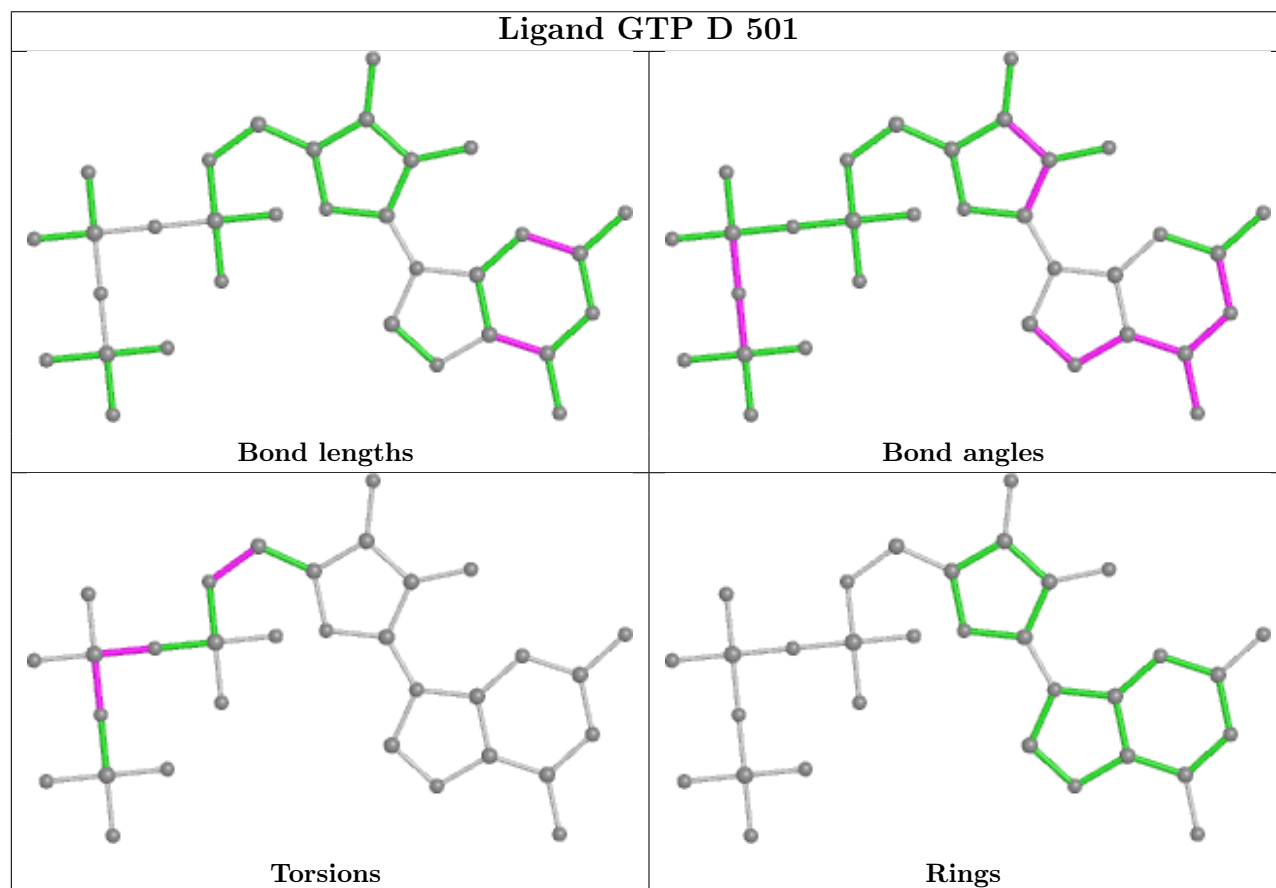
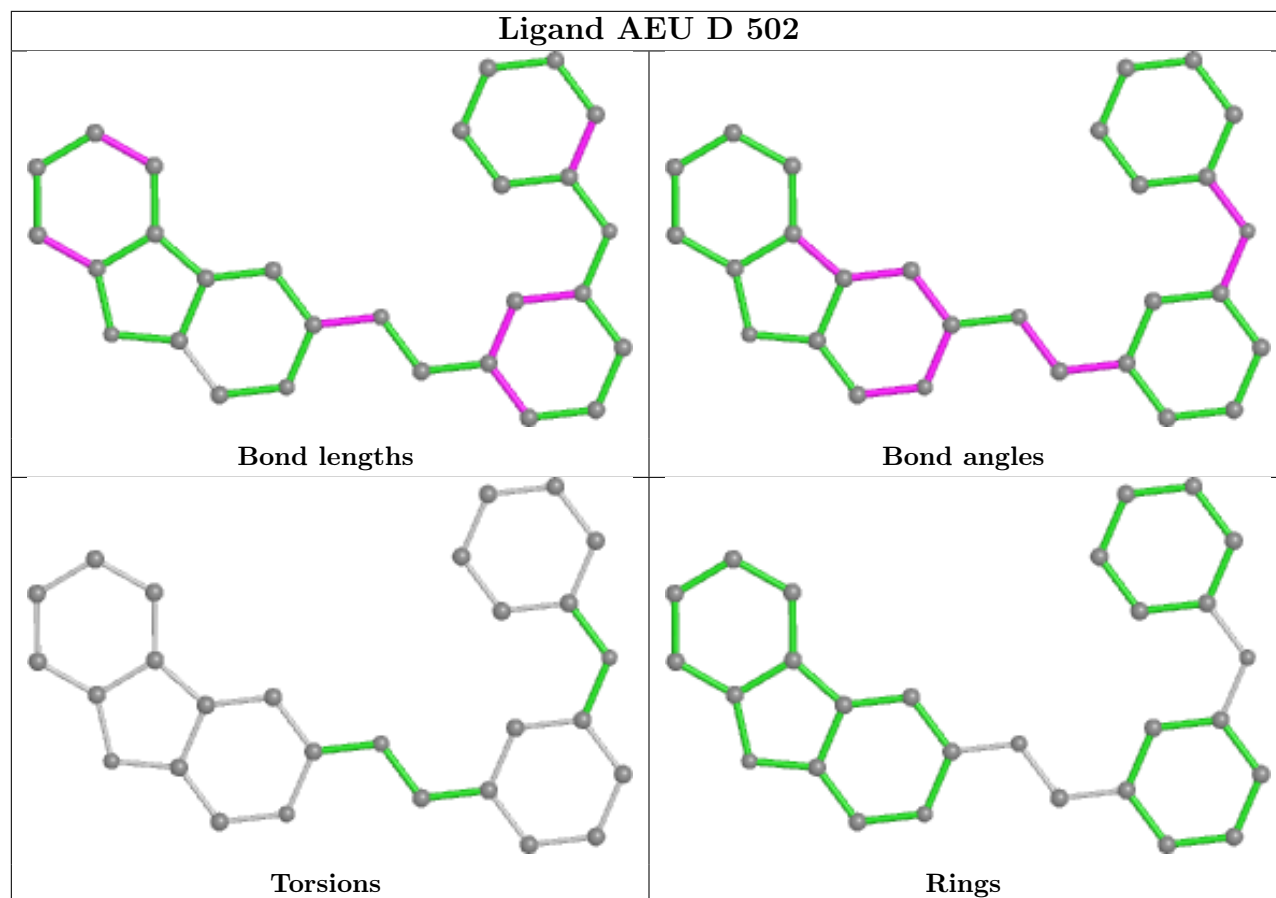

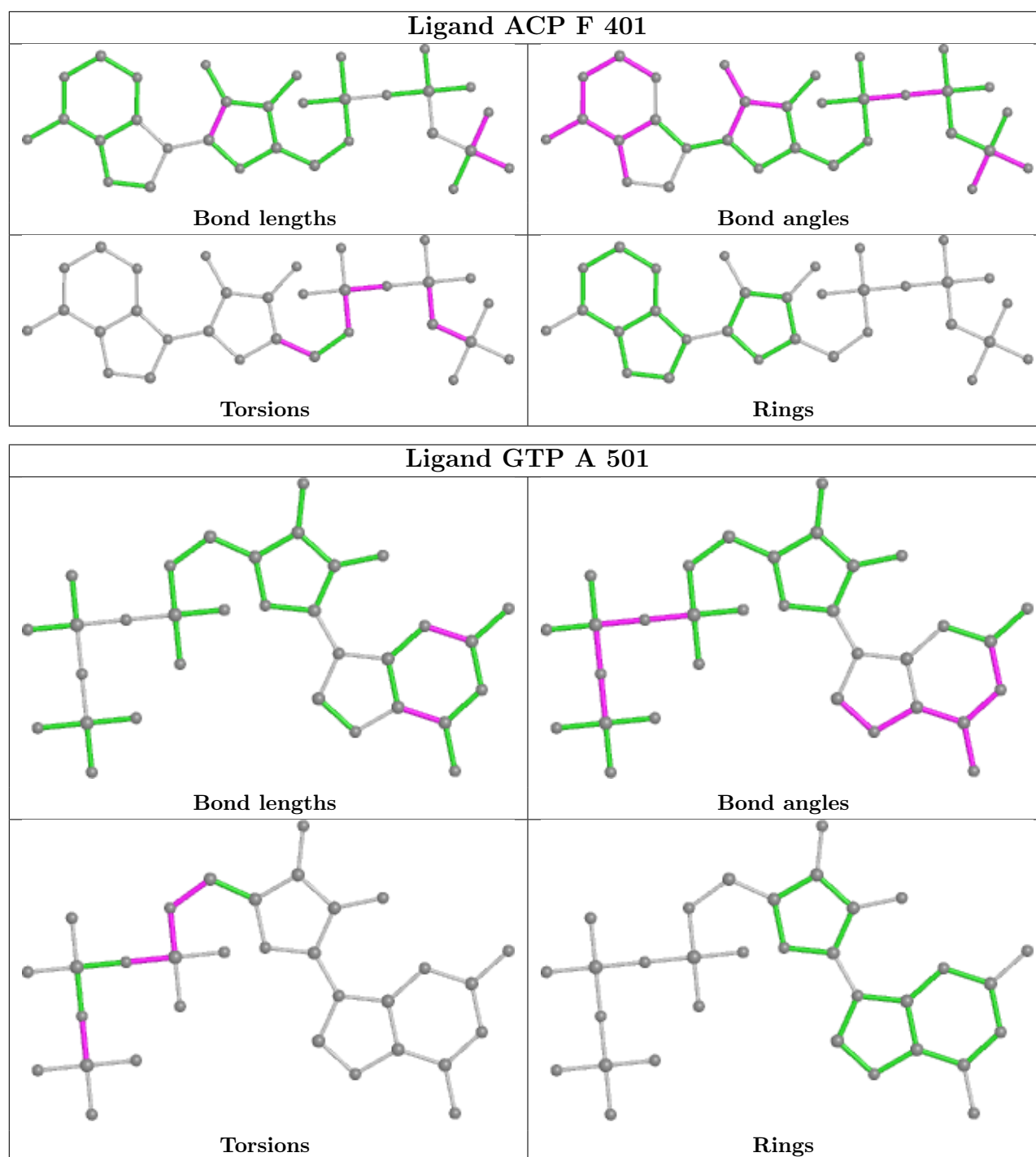

5.7 Other polymers [\(i\)](#)

There are no such residues in this entry.

5.8 Polymer linkage issues [\(i\)](#)

There are no chain breaks in this entry.

6 Fit of model and data [i](#)

6.1 Protein, DNA and RNA chains [i](#)

In the following table, the column labelled ‘#RSRZ> 2’ contains the number (and percentage) of RSRZ outliers, followed by percent RSRZ outliers for the chain as percentile scores relative to all X-ray entries and entries of similar resolution. The OWAB column contains the minimum, median, 95th percentile and maximum values of the occupancy-weighted average B-factor per residue. The column labelled ‘Q< 0.9’ lists the number of (and percentage) of residues with an average occupancy less than 0.9.

Mol	Chain	Analysed	<RSRZ>	#RSRZ>2	OWAB(Å ²)	Q<0.9
1	A	437/450 (97%)	0.07	5 (1%) 80 79	20, 37, 65, 91	0
1	C	440/450 (97%)	-0.22	3 (0%) 87 87	14, 29, 58, 108	0
2	B	427/445 (95%)	0.16	13 (3%) 50 47	17, 37, 80, 136	0
2	D	421/445 (94%)	1.11	81 (19%) 1 1	33, 67, 110, 139	0
3	E	121/143 (84%)	0.51	9 (7%) 14 12	25, 60, 97, 107	0
4	F	338/384 (88%)	1.19	78 (23%) 0 0	32, 72, 132, 153	0
All	All	2184/2317 (94%)	0.43	189 (8%) 10 8	14, 47, 107, 153	0

All (189) RSRZ outliers are listed below:

Mol	Chain	Res	Type	RSRZ
4	F	161	LEU	11.4
4	F	173	ILE	11.3
4	F	178	GLN	8.4
4	F	169	LEU	8.4
2	D	245	GLN	7.9
4	F	233	PHE	7.7
2	D	394	PHE	7.2
2	B	279	GLN	7.0
2	D	55	THR	7.0
4	F	177	GLY	6.4
4	F	170	LEU	6.4
2	D	391	ARG	6.3
4	F	101	TYR	6.1
4	F	176	GLN	6.0
4	F	236	LYS	5.9
2	D	92	PHE	5.9
4	F	137	ARG	5.8
2	B	276	ARG	5.7
4	F	179	VAL	5.7

Continued on next page...

Continued from previous page...

Mol	Chain	Res	Type	RSRZ
4	F	130	VAL	5.5
1	C	340	SER	5.5
2	B	280	GLN	5.5
4	F	103	THR	5.4
2	D	219	THR	5.3
4	F	166	ALA	5.3
2	D	215	LEU	5.3
4	F	182	ILE	5.3
2	D	217	LEU	5.2
2	D	1	MET	5.0
2	D	177	ASP	4.9
2	D	57	ASN	4.8
4	F	142	ARG	4.8
4	F	127	GLU	4.8
2	B	278	SER	4.7
4	F	100	ILE	4.7
4	F	384	HIS	4.6
4	F	231	ALA	4.6
2	D	84	ILE	4.5
2	D	74	ASP	4.5
4	F	320	MET	4.4
2	D	83	GLN	4.4
4	F	133	ALA	4.3
4	F	138	ARG	4.3
2	B	275	SER	4.3
1	C	179	THR	4.3
4	F	174	ASP	4.1
2	D	175	VAL	4.1
2	D	56	GLY	4.1
4	F	372	THR	4.0
2	D	87	PRO	4.0
2	D	81	PHE	4.0
2	D	320	ARG	4.0
2	D	137	HIS	3.9
2	D	405	GLU	3.9
2	D	70	PRO	3.9
2	D	216	LYS	3.9
4	F	257	GLU	3.9
4	F	20	LEU	3.9
4	F	136	ASN	3.8
2	D	172	SER	3.8
2	D	77	ARG	3.8

Continued on next page...

Continued from previous page...

Mol	Chain	Res	Type	RSRZ
2	B	282	ARG	3.8
4	F	232	ASN	3.8
2	D	211	CYS	3.8
2	D	168	SER	3.8
4	F	175	GLU	3.7
4	F	362	ALA	3.7
2	D	218	THR	3.7
4	F	361	LEU	3.6
4	F	134	ALA	3.6
4	F	167	SER	3.6
4	F	383	HIS	3.6
2	D	167	PHE	3.6
2	D	54	ALA	3.6
4	F	148	ILE	3.6
2	B	277	GLY	3.6
4	F	234	GLN	3.5
2	D	285	THR	3.5
1	A	262	TYR	3.4
4	F	240	LEU	3.4
4	F	252	ASN	3.4
3	E	139	LEU	3.4
4	F	255	ARG	3.4
4	F	139	ARG	3.4
4	F	129	GLU	3.3
4	F	25	GLY	3.3
4	F	171	ASP	3.3
2	D	73	MET	3.3
4	F	102	PRO	3.3
2	D	286	VAL	3.3
3	E	25	LYS	3.3
4	F	253	TYR	3.3
2	D	396	HIS	3.3
4	F	235	ASP	3.2
2	B	42	LEU	3.2
2	D	389	PHE	3.1
4	F	162	ILE	3.1
2	D	60	VAL	3.1
2	D	284	LEU	3.1
2	D	362	LYS	3.1
2	D	356	ILE	3.1
2	D	170	MET	3.0
4	F	24	THR	3.0

Continued on next page...

Continued from previous page...

Mol	Chain	Res	Type	RSRZ
2	D	53	GLU	3.0
2	D	94	GLN	3.0
4	F	143	GLU	3.0
4	F	230	SER	3.0
2	D	166	THR	3.0
3	E	140	LYS	3.0
2	D	58	LYS	2.9
4	F	145	ASN	2.9
3	E	7	GLU	2.9
4	F	164	SER	2.9
4	F	31	ARG	2.9
4	F	147	TRP	2.9
4	F	21	LEU	2.9
2	B	57	ASN	2.9
2	D	136	THR	2.9
2	B	336	LYS	2.9
4	F	128	ARG	2.9
2	D	165	ASN	2.9
3	E	124	GLN	2.8
2	D	44	LEU	2.8
4	F	256	TYR	2.8
2	D	390	ARG	2.8
4	F	132	LEU	2.8
4	F	245	ILE	2.8
4	F	26	GLN	2.7
2	D	199	THR	2.7
4	F	168	GLU	2.7
1	A	282	TYR	2.6
2	D	388	MET	2.6
2	D	86	ARG	2.6
4	F	27	TRP	2.6
4	F	223	THR	2.6
2	D	13	GLY	2.6
2	B	274	THR	2.5
1	A	316[A]	CYS	2.5
2	D	363	MET	2.5
2	D	115	SER	2.5
2	D	200	TYR	2.5
2	B	218	THR	2.5
2	D	37	HIS	2.5
2	D	138	SER	2.5
2	D	387	ALA	2.4

Continued on next page...

Continued from previous page...

Mol	Chain	Res	Type	RSRZ
4	F	180	HIS	2.4
3	E	131	GLU	2.4
2	D	112	LEU	2.4
4	F	149	ALA	2.4
3	E	135	LYS	2.4
2	D	395	LEU	2.3
4	F	22	LEU	2.3
4	F	225	SER	2.3
2	D	59	TYR	2.3
2	D	331	LEU	2.3
3	E	24	LEU	2.3
2	D	146	GLY	2.3
4	F	316	GLY	2.3
4	F	172	PHE	2.2
2	D	46	ARG	2.2
1	A	281	ALA	2.2
4	F	126	ASP	2.2
2	D	48	ASN	2.2
2	D	145	SER	2.2
2	D	397	TRP	2.2
2	B	54	ALA	2.2
2	D	321	MET	2.2
4	F	352	ASP	2.2
2	D	125	GLU	2.2
2	D	393	ALA	2.2
2	D	9	ALA	2.2
2	D	406	MET	2.2
2	D	408	PHE	2.2
1	C	440	VAL	2.1
4	F	163	SER	2.1
2	D	208	TYR	2.1
1	A	201	ALA	2.1
2	D	78	SER	2.1
2	D	196	THR	2.1
2	D	400	GLY	2.1
2	D	169	VAL	2.1
4	F	382	HIS	2.1
2	D	176	SER	2.1
2	D	244	GLY	2.1
2	D	12	CYS	2.0
3	E	138	GLU	2.0
4	F	140	GLU	2.0

Continued on next page...

Continued from previous page...

Mol	Chain	Res	Type	RSRZ
4	F	239	HIS	2.0
4	F	226	GLU	2.0

6.2 Non-standard residues in protein, DNA, RNA chains [i](#)

There are no non-standard protein/DNA/RNA residues in this entry.

6.3 Carbohydrates [i](#)

There are no monosaccharides in this entry.

6.4 Ligands [i](#)

In the following table, the Atoms column lists the number of modelled atoms in the group and the number defined in the chemical component dictionary. The B-factors column lists the minimum, median, 95th percentile and maximum values of B factors of atoms in the group. The column labelled 'Q < 0.9' lists the number of atoms with occupancy less than 0.9.

Mol	Type	Chain	Res	Atoms	RSCC	RSR	B-factors(Å ²)	Q<0.9
11	AEU	D	502	28/28	0.76	0.38	59,79,101,112	0
6	MG	D	503	1/1	0.77	0.22	107,107,107,107	0
12	ACP	F	401	31/31	0.80	0.25	82,103,128,130	0
5	GTP	D	501	32/32	0.90	0.25	56,68,95,136	0
8	GOL	A	504	6/6	0.91	0.28	33,50,63,75	0
10	MES	B	503	12/12	0.93	0.18	30,43,61,85	0
11	AEU	B	504	28/28	0.95	0.21	24,31,39,46	0
9	GDP	B	501	28/28	0.96	0.19	12,25,30,36	0
7	CA	A	503	1/1	0.97	0.10	53,53,53,53	0
7	CA	C	503	1/1	0.97	0.04	33,33,33,33	0
6	MG	C	502	1/1	0.97	0.06	23,23,23,23	0
5	GTP	A	501	32/32	0.97	0.18	16,24,30,32	0
5	GTP	C	501	32/32	0.98	0.15	13,21,28,33	0
6	MG	B	502	1/1	0.98	0.19	23,23,23,23	0
6	MG	A	502	1/1	0.99	0.16	21,21,21,21	0

The following is a graphical depiction of the model fit to experimental electron density of all instances of the Ligand of Interest. In addition, ligands with molecular weight > 250 and outliers as shown on the geometry validation Tables will also be included. Each fit is shown from different orientation to approximate a three-dimensional view.

Electron density around AEU D 502:

$2mF_o-DF_c$ (at 0.7 rmsd) in gray
 mF_o-DF_c (at 3 rmsd) in purple (negative)
and green (positive)

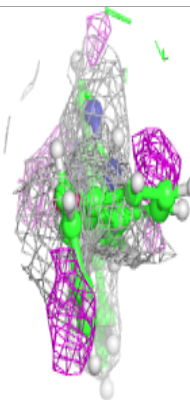
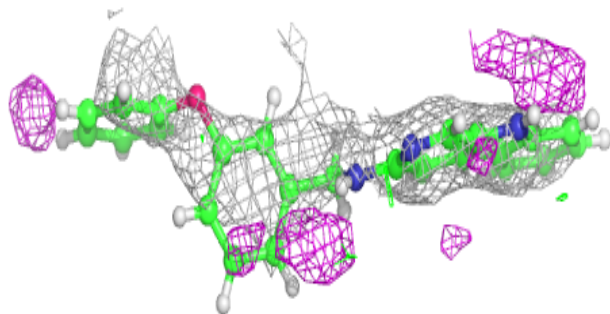
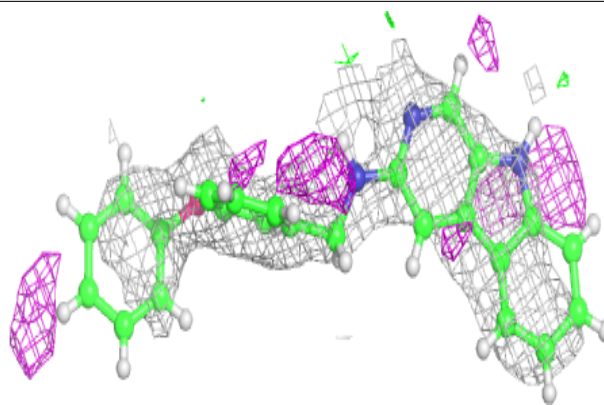
**Electron density around ACP F 401:**

$2mF_o-DF_c$ (at 0.7 rmsd) in gray
 mF_o-DF_c (at 3 rmsd) in purple (negative)
and green (positive)

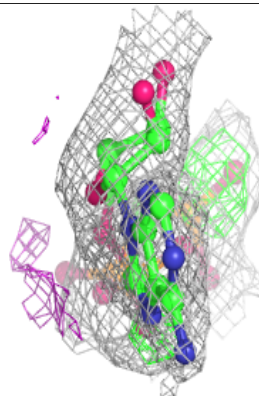
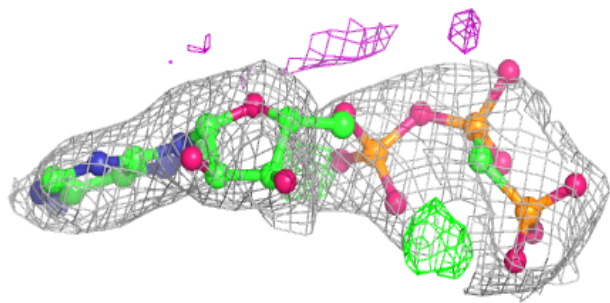
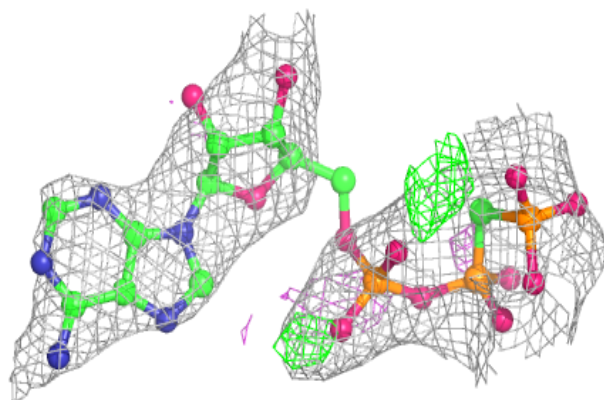

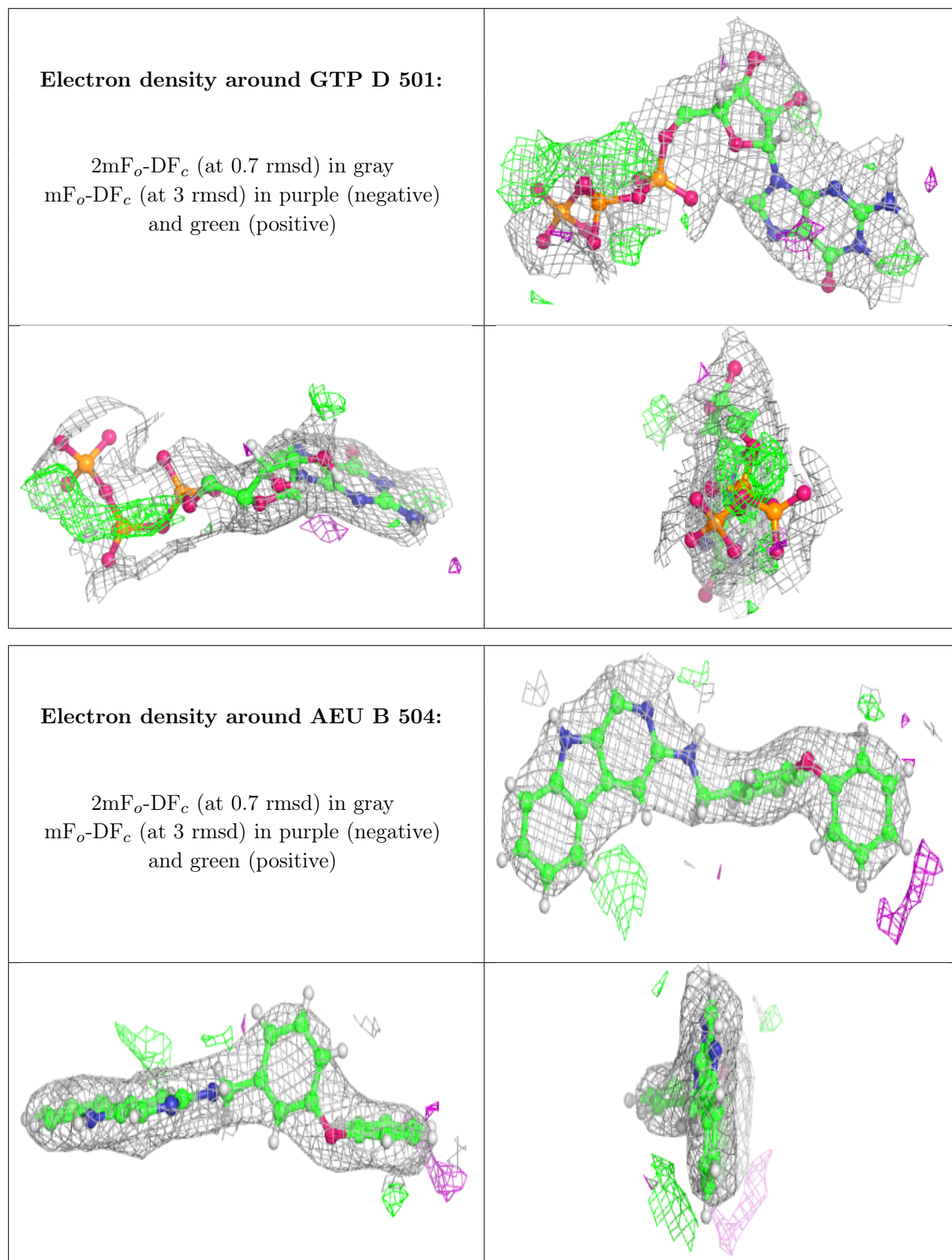

Electron density around GDP B 501:

$2mF_o-DF_c$ (at 0.7 rmsd) in gray
 mF_o-DF_c (at 3 rmsd) in purple (negative)
and green (positive)

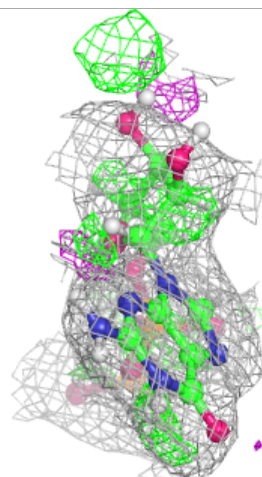
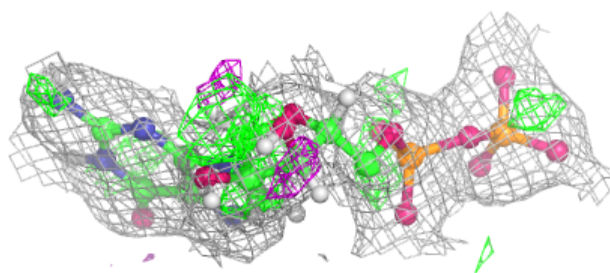
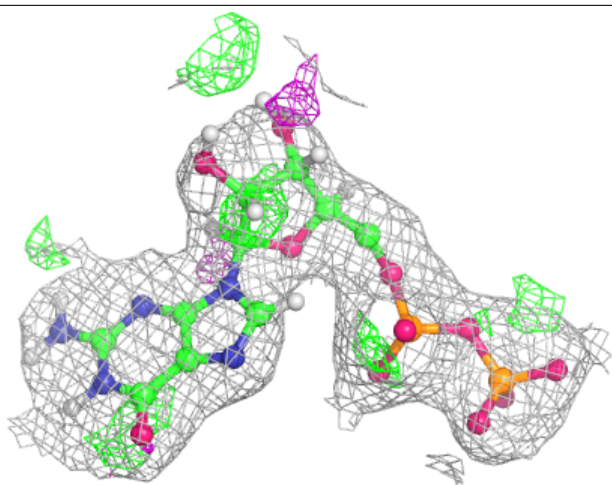

Electron density around GTP A 501:

$2mF_o-DF_c$ (at 0.7 rmsd) in gray
 mF_o-DF_c (at 3 rmsd) in purple (negative)
and green (positive)

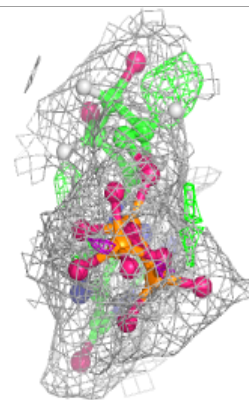
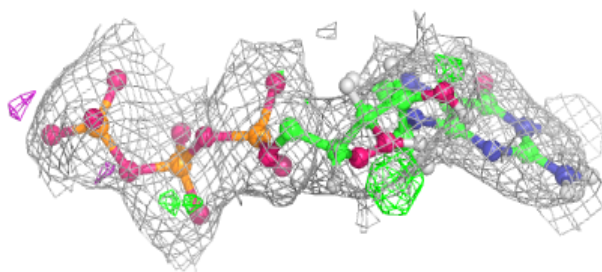
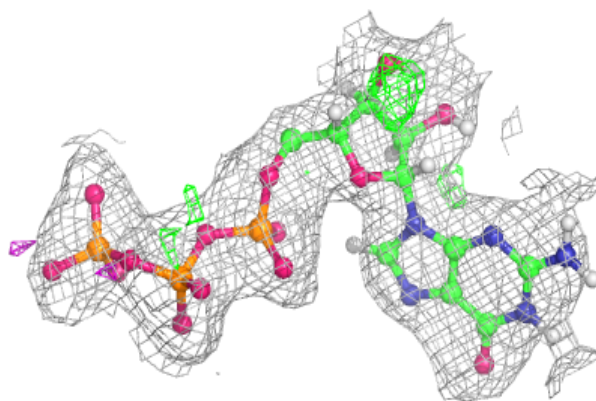
**Electron density around GTP C 501:**

$2mF_o-DF_c$ (at 0.7 rmsd) in gray
 mF_o-DF_c (at 3 rmsd) in purple (negative)
and green (positive)

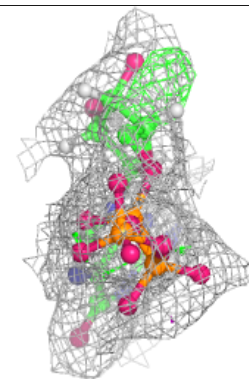
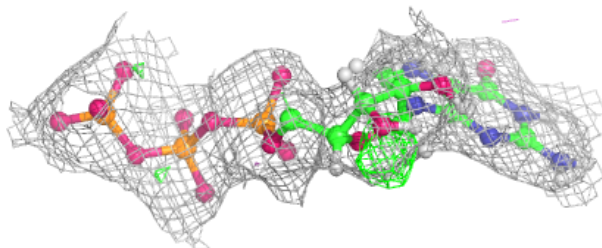
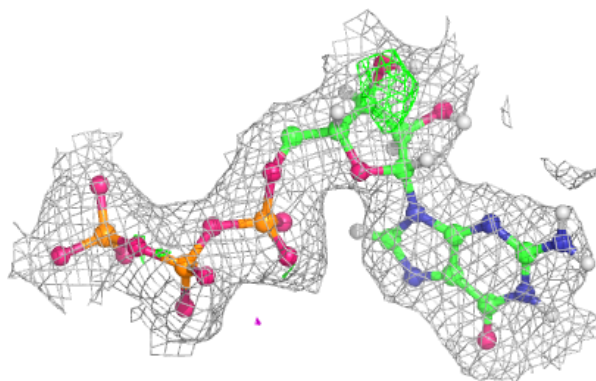

6.5 Other polymers [i](#)

There are no such residues in this entry.