



# Full wwPDB X-ray Structure Validation Report ⓘ

Oct 11, 2021 – 03:12 AM EDT

PDB ID : 3CER  
Title : Crystal structure of the exopolyphosphatase-like protein Q8G5J2. Northeast Structural Genomics Consortium target BIR13  
Authors : Kuzin, A.P.; Su, M.; Chen, Y.; Neely, H.; Seetharaman, J.; Shastry, R.; Fang, Y.; Cunningham, K.; Ma, L.-C.; Xiao, R.; Liu, J.; Baran, M.C.; Acton, T.B.; Rost, B.; Montelione, G.T.; Hunt, J.F.; Tong, L.; Northeast Structural Genomics Consortium (NESG)  
Deposited on : 2008-02-29  
Resolution : 2.40 Å(reported)

This is a Full wwPDB X-ray Structure Validation Report for a publicly released PDB entry.

We welcome your comments at [validation@mail.wwpdb.org](mailto:validation@mail.wwpdb.org)

A user guide is available at

<https://www.wwpdb.org/validation/2017/XrayValidationReportHelp>

with specific help available everywhere you see the ⓘ symbol.

---

The following versions of software and data (see [references ⓘ](#)) were used in the production of this report:

MolProbity : 4.02b-467  
Mogul : 1.8.5 (274361), CSD as541be (2020)  
Xtriage (Phenix) : 1.13  
EDS : 2.23.2  
Percentile statistics : 20191225.v01 (using entries in the PDB archive December 25th 2019)  
Refmac : 5.8.0158  
CCP4 : 7.0.044 (Gargrove)  
Ideal geometry (proteins) : Engh & Huber (2001)  
Ideal geometry (DNA, RNA) : Parkinson et al. (1996)  
Validation Pipeline (wwPDB-VP) : 2.23.2

# 1 Overall quality at a glance

The following experimental techniques were used to determine the structure:

*X-RAY DIFFRACTION*

The reported resolution of this entry is 2.40 Å.

Percentile scores (ranging between 0-100) for global validation metrics of the entry are shown in the following graphic. The table shows the number of entries on which the scores are based.

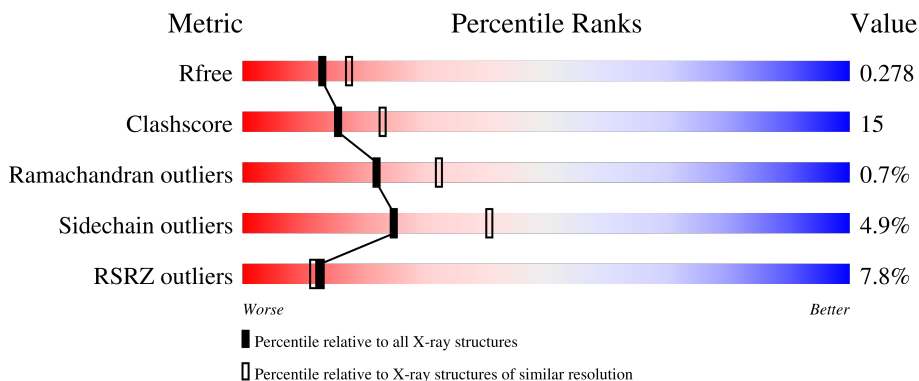

Metric	Whole archive (#Entries)	Similar resolution (#Entries, resolution range(Å))
$R_{free}$	130704	3907 (2.40-2.40)
Clashscore	141614	4398 (2.40-2.40)
Ramachandran outliers	138981	4318 (2.40-2.40)
Sidechain outliers	138945	4319 (2.40-2.40)
RSRZ outliers	127900	3811 (2.40-2.40)

The table below summarises the geometric issues observed across the polymeric chains and their fit to the electron density. The red, orange, yellow and green segments of the lower bar indicate the fraction of residues that contain outliers for  $\geq 3$ , 2, 1 and 0 types of geometric quality criteria respectively. A grey segment represents the fraction of residues that are not modelled. The numeric value for each fraction is indicated below the corresponding segment, with a dot representing fractions  $\leq 5\%$ . The upper red bar (where present) indicates the fraction of residues that have poor fit to the electron density. The numeric value is given above the bar.

Mol	Chain	Length	Quality of chain
1	A	343	 0% 73% 21% . .
1	B	343	 4% 71% 24% . .
1	C	343	 3% 71% 22% . .
1	D	343	 11% 66% 27% . .
1	E	343	 17% 62% 29% . 6%

The following table lists non-polymeric compounds, carbohydrate monomers and non-standard residues in protein, DNA, RNA chains that are outliers for geometric or electron-density-fit criteria:

<b>Mol</b>	<b>Type</b>	<b>Chain</b>	<b>Res</b>	<b>Chirality</b>	<b>Geometry</b>	<b>Clashes</b>	<b>Electron density</b>
2	SO4	E	345	-	-	-	X

## 2 Entry composition [i](#)

There are 3 unique types of molecules in this entry. The entry contains 12990 atoms, of which 0 are hydrogens and 0 are deuteriums.

In the tables below, the ZeroOcc column contains the number of atoms modelled with zero occupancy, the AltConf column contains the number of residues with at least one atom in alternate conformation and the Trace column contains the number of residues modelled with at most 2 atoms.

- Molecule 1 is a protein called Possible exopolyphosphatase-like protein.

Mol	Chain	Residues	Atoms						ZeroOcc	AltConf	Trace
			Total	C	N	O	S	Se			
1	A	330	2516	1556	453	500	1	6	0	0	0
1	B	330	2516	1556	453	500	1	6	0	0	0
1	C	333	2539	1570	457	504	1	7	0	0	0
1	D	330	2515	1557	453	498	1	6	0	0	0
1	E	322	2458	1524	444	483	1	6	0	0	0

There are 60 discrepancies between the modelled and reference sequences:

Chain	Residue	Modelled	Actual	Comment	Reference
A	1	MSE	-	expression tag	UNP Q8G5J2
A	2	GLY	-	expression tag	UNP Q8G5J2
A	3	HIS	-	expression tag	UNP Q8G5J2
A	4	HIS	-	expression tag	UNP Q8G5J2
A	5	HIS	-	expression tag	UNP Q8G5J2
A	6	HIS	-	expression tag	UNP Q8G5J2
A	7	HIS	-	expression tag	UNP Q8G5J2
A	8	HIS	-	expression tag	UNP Q8G5J2
A	9	SER	-	expression tag	UNP Q8G5J2
A	10	HIS	-	expression tag	UNP Q8G5J2
A	260	PHE	LEU	engineered mutation	UNP Q8G5J2
A	276	ALA	VAL	engineered mutation	UNP Q8G5J2
B	1	MSE	-	expression tag	UNP Q8G5J2
B	2	GLY	-	expression tag	UNP Q8G5J2
B	3	HIS	-	expression tag	UNP Q8G5J2
B	4	HIS	-	expression tag	UNP Q8G5J2
B	5	HIS	-	expression tag	UNP Q8G5J2
B	6	HIS	-	expression tag	UNP Q8G5J2
B	7	HIS	-	expression tag	UNP Q8G5J2

*Continued on next page...*

*Continued from previous page...*

Chain	Residue	Modelled	Actual	Comment	Reference
B	8	HIS	-	expression tag	UNP Q8G5J2
B	9	SER	-	expression tag	UNP Q8G5J2
B	10	HIS	-	expression tag	UNP Q8G5J2
B	260	PHE	LEU	engineered mutation	UNP Q8G5J2
B	276	ALA	VAL	engineered mutation	UNP Q8G5J2
C	1	MSE	-	expression tag	UNP Q8G5J2
C	2	GLY	-	expression tag	UNP Q8G5J2
C	3	HIS	-	expression tag	UNP Q8G5J2
C	4	HIS	-	expression tag	UNP Q8G5J2
C	5	HIS	-	expression tag	UNP Q8G5J2
C	6	HIS	-	expression tag	UNP Q8G5J2
C	7	HIS	-	expression tag	UNP Q8G5J2
C	8	HIS	-	expression tag	UNP Q8G5J2
C	9	SER	-	expression tag	UNP Q8G5J2
C	10	HIS	-	expression tag	UNP Q8G5J2
C	260	PHE	LEU	engineered mutation	UNP Q8G5J2
C	276	ALA	VAL	engineered mutation	UNP Q8G5J2
D	1	MSE	-	expression tag	UNP Q8G5J2
D	2	GLY	-	expression tag	UNP Q8G5J2
D	3	HIS	-	expression tag	UNP Q8G5J2
D	4	HIS	-	expression tag	UNP Q8G5J2
D	5	HIS	-	expression tag	UNP Q8G5J2
D	6	HIS	-	expression tag	UNP Q8G5J2
D	7	HIS	-	expression tag	UNP Q8G5J2
D	8	HIS	-	expression tag	UNP Q8G5J2
D	9	SER	-	expression tag	UNP Q8G5J2
D	10	HIS	-	expression tag	UNP Q8G5J2
D	260	PHE	LEU	engineered mutation	UNP Q8G5J2
D	276	ALA	VAL	engineered mutation	UNP Q8G5J2
E	1	MSE	-	expression tag	UNP Q8G5J2
E	2	GLY	-	expression tag	UNP Q8G5J2
E	3	HIS	-	expression tag	UNP Q8G5J2
E	4	HIS	-	expression tag	UNP Q8G5J2
E	5	HIS	-	expression tag	UNP Q8G5J2
E	6	HIS	-	expression tag	UNP Q8G5J2
E	7	HIS	-	expression tag	UNP Q8G5J2
E	8	HIS	-	expression tag	UNP Q8G5J2
E	9	SER	-	expression tag	UNP Q8G5J2
E	10	HIS	-	expression tag	UNP Q8G5J2
E	260	PHE	LEU	engineered mutation	UNP Q8G5J2
E	276	ALA	VAL	engineered mutation	UNP Q8G5J2

- Molecule 2 is SULFATE ION (three-letter code: SO4) (formula: O<sub>4</sub>S).



Mol	Chain	Residues	Atoms			ZeroOcc	AltConf
2	A	1	Total	O	S	0	0
			5	4	1		
2	A	1	Total	O	S	0	0
			5	4	1		
2	A	1	Total	O	S	0	0
			5	4	1		
2	B	1	Total	O	S	0	0
			5	4	1		
2	B	1	Total	O	S	0	0
			5	4	1		
2	B	1	Total	O	S	0	0
			5	4	1		
2	C	1	Total	O	S	0	0
			5	4	1		
2	C	1	Total	O	S	0	0
			5	4	1		
2	C	1	Total	O	S	0	0
			5	4	1		
2	D	1	Total	O	S	0	0
			5	4	1		
2	D	1	Total	O	S	0	0
			5	4	1		
2	D	1	Total	O	S	0	0
			5	4	1		
2	E	1	Total	O	S	0	0
			5	4	1		

*Continued on next page...*

*Continued from previous page...*

Mol	Chain	Residues	Atoms			ZeroOcc	AltConf
2	E	1	Total	O	S	0	0
			5	4	1		
2	E	1	Total	O	S	0	0
			5	4	1		

- Molecule 3 is water.

Mol	Chain	Residues	Atoms		ZeroOcc	AltConf
3	A	122	Total	O	0	0
			122	122		
3	B	36	Total	O	0	0
			36	36		
3	C	167	Total	O	0	0
			167	167		
3	D	29	Total	O	0	0
			29	29		
3	E	12	Total	O	0	0
			12	12		

### 3 Residue-property plots [i](#)

These plots are drawn for all protein, RNA, DNA and oligosaccharide chains in the entry. The first graphic for a chain summarises the proportions of the various outlier classes displayed in the second graphic. The second graphic shows the sequence view annotated by issues in geometry and electron density. Residues are color-coded according to the number of geometric quality criteria for which they contain at least one outlier: green = 0, yellow = 1, orange = 2 and red = 3 or more. A red dot above a residue indicates a poor fit to the electron density ( $RSRZ > 2$ ). Stretches of 2 or more consecutive residues without any outlier are shown as a green connector. Residues present in the sample, but not in the model, are shown in grey.

- Molecule 1: Possible exopolyphosphatase-like protein

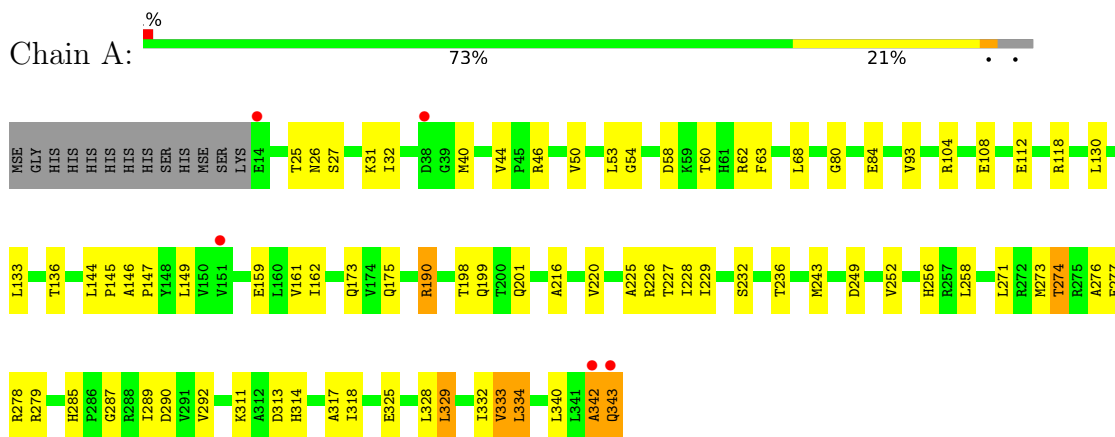

- Molecule 1: Possible exopolyphosphatase-like protein

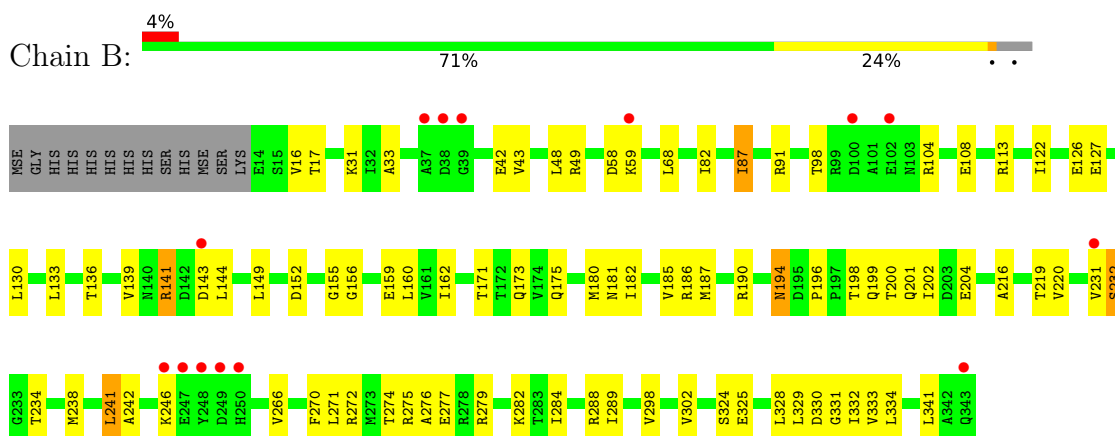

- Molecule 1: Possible exopolyphosphatase-like protein

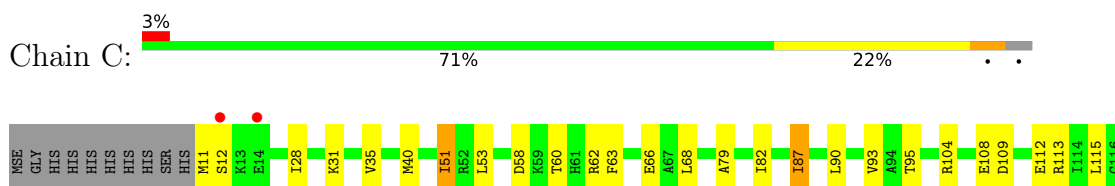



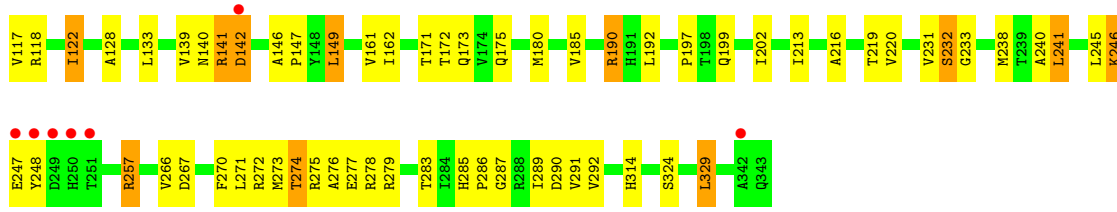

● Molecule 1: Possible exopolyphosphatase-like protein

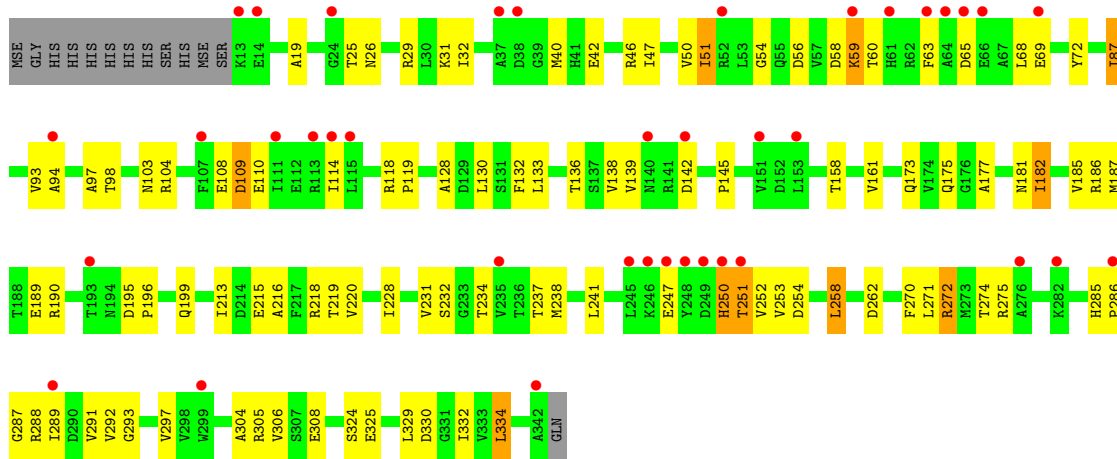

● Molecule 1: Possible exopolyphosphatase-like protein

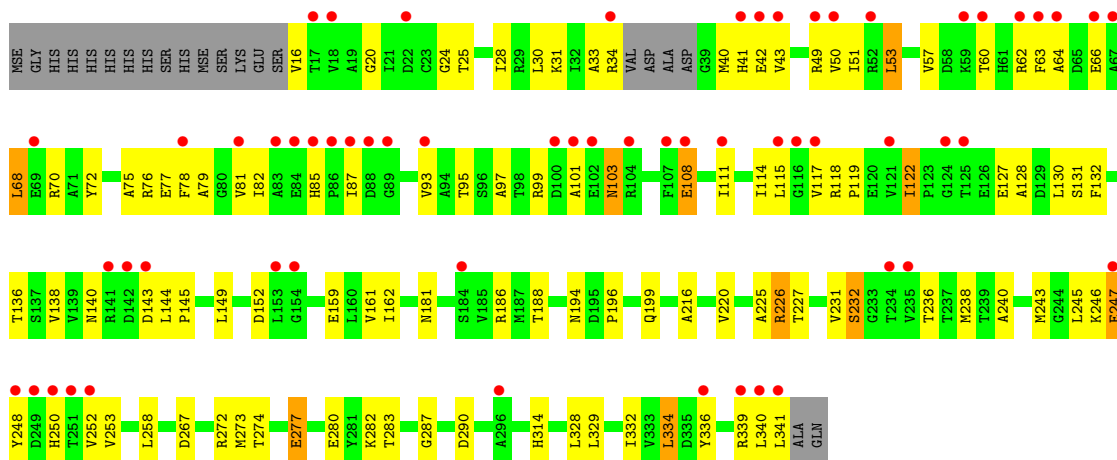

## 4 Data and refinement statistics

Property	Value	Source
Space group	C 2 2 21	Depositor
Cell constants a, b, c, $\alpha$ , $\beta$ , $\gamma$	83.64Å 307.36Å 179.07Å 90.00° 90.00° 90.00°	Depositor
Resolution (Å)	19.90 – 2.40 29.81 – 2.40	Depositor EDS
% Data completeness (in resolution range)	90.5 (19.90-2.40) 98.4 (29.81-2.40)	Depositor EDS
$R_{merge}$	0.07	Depositor
$R_{sym}$	(Not available)	Depositor
$\langle I/\sigma(I) \rangle$ <sup>1</sup>	4.09 (at 2.39Å)	Xtrriage
Refinement program	CNS 1.2	Depositor
R, $R_{free}$	0.221 , 0.267 0.236 , 0.278	Depositor DCC
$R_{free}$ test set	8653 reflections (4.98%)	wwPDB-VP
Wilson B-factor (Å <sup>2</sup> )	33.6	Xtrriage
Anisotropy	0.314	Xtrriage
Bulk solvent $k_{sol}$ (e/Å <sup>3</sup> ), $B_{sol}$ (Å <sup>2</sup> )	0.34 , 47.4	EDS
L-test for twinning <sup>2</sup>	$\langle  L  \rangle = 0.49$ , $\langle L^2 \rangle = 0.32$	Xtrriage
Estimated twinning fraction	No twinning to report.	Xtrriage
$F_o, F_c$ correlation	0.92	EDS
Total number of atoms	12990	wwPDB-VP
Average B, all atoms (Å <sup>2</sup> )	45.0	wwPDB-VP

Xtrriage's analysis on translational NCS is as follows: *The largest off-origin peak in the Patterson function is 2.47% of the height of the origin peak. No significant pseudotranslation is detected.*

<sup>1</sup>Intensities estimated from amplitudes.

<sup>2</sup>Theoretical values of  $\langle |L| \rangle$ ,  $\langle L^2 \rangle$  for acentric reflections are 0.5, 0.333 respectively for untwinned datasets, and 0.375, 0.2 for perfectly twinned datasets.

## 5 Model quality [i](#)

### 5.1 Standard geometry [i](#)

Bond lengths and bond angles in the following residue types are not validated in this section: SO4

The Z score for a bond length (or angle) is the number of standard deviations the observed value is removed from the expected value. A bond length (or angle) with  $|Z| > 5$  is considered an outlier worth inspection. RMSZ is the root-mean-square of all Z scores of the bond lengths (or angles).

Mol	Chain	Bond lengths		Bond angles	
		RMSZ	# Z  >5	RMSZ	# Z  >5
1	A	0.37	0/2547	0.63	0/3443
1	B	0.31	0/2547	0.57	0/3443
1	C	0.39	0/2570	0.65	0/3472
1	D	0.30	0/2546	0.57	0/3442
1	E	0.30	0/2488	0.55	0/3362
All	All	0.34	0/12698	0.59	0/17162

There are no bond length outliers.

There are no bond angle outliers.

There are no chirality outliers.

There are no planarity outliers.

### 5.2 Too-close contacts [i](#)

In the following table, the Non-H and H(model) columns list the number of non-hydrogen atoms and hydrogen atoms in the chain respectively. The H(added) column lists the number of hydrogen atoms added and optimized by MolProbity. The Clashes column lists the number of clashes within the asymmetric unit, whereas Symm-Clashes lists symmetry-related clashes.

Mol	Chain	Non-H	H(model)	H(added)	Clashes	Symm-Clashes
1	A	2516	0	2470	55	0
1	B	2516	0	2470	69	0
1	C	2539	0	2497	79	0
1	D	2515	0	2475	78	0
1	E	2458	0	2423	88	0
2	A	15	0	0	0	0
2	B	15	0	0	0	0
2	C	20	0	0	1	0

*Continued on next page...*

*Continued from previous page...*

Mol	Chain	Non-H	H(model)	H(added)	Clashes	Symm-Clashes
2	D	15	0	0	0	0
2	E	15	0	0	0	0
3	A	122	0	0	2	0
3	B	36	0	0	0	0
3	C	167	0	0	2	0
3	D	29	0	0	0	0
3	E	12	0	0	0	0
All	All	12990	0	12335	366	0

The all-atom clashscore is defined as the number of clashes found per 1000 atoms (including hydrogen atoms). The all-atom clashscore for this structure is 15.

All (366) close contacts within the same asymmetric unit are listed below, sorted by their clash magnitude.

Atom-1	Atom-2	Interatomic distance (Å)	Clash overlap (Å)
1:A:228:ILE:HD13	1:A:318:ILE:HG21	1.36	1.06
1:C:60:THR:HG22	1:C:62:ARG:HG2	1.38	1.02
1:C:279:ARG:HG2	1:C:289:ILE:HD13	1.40	1.00
1:D:173:GLN:HE21	1:D:175:GLN:HE22	1.05	0.98
1:B:173:GLN:HE21	1:B:175:GLN:HE22	1.09	0.98
1:B:196:PRO:HD3	1:B:274:THR:HG22	1.48	0.92
1:A:274:THR:HG22	1:A:277:GLU:H	1.35	0.90
1:A:285:HIS:HD2	1:A:287:GLY:H	1.23	0.86
1:C:285:HIS:HD2	1:C:287:GLY:H	1.22	0.84
1:E:152:ASP:HB3	1:E:159:GLU:HG2	1.60	0.83
1:D:63:PHE:HB2	1:D:103:ASN:HD21	1.43	0.83
1:E:199:GLN:HE22	1:E:272:ARG:HH22	1.28	0.81
1:C:31:LYS:HE2	1:C:40:MSE:HE1	1.63	0.80
1:C:173:GLN:HE21	1:C:175:GLN:HE22	1.31	0.79
1:C:274:THR:HG22	1:C:277:GLU:H	1.45	0.79
1:E:93:VAL:HG21	1:E:332:ILE:HD12	1.66	0.78
1:C:238:MSE:HE2	1:C:267:ASP:HA	1.65	0.78
1:B:274:THR:OG1	1:B:277:GLU:HG3	1.85	0.77
1:A:173:GLN:HE21	1:A:175:GLN:HE22	1.29	0.77
1:C:238:MSE:HE3	1:C:266:VAL:HG13	1.65	0.76
1:A:93:VAL:HG21	1:A:332:ILE:HD12	1.67	0.76
1:B:152:ASP:HB3	1:B:159:GLU:HG2	1.67	0.76
1:C:257:ARG:HH11	1:C:257:ARG:HB2	1.51	0.75
1:A:60:THR:HG22	1:A:62:ARG:HG2	1.67	0.75
1:B:231:VAL:O	1:B:232:SER:HB2	1.86	0.75
1:B:82:ILE:HG23	1:B:87:ILE:HD12	1.70	0.74

*Continued on next page...*

*Continued from previous page...*

Atom-1	Atom-2	Interatomic distance (Å)	Clash overlap (Å)
1:C:199:GLN:NE2	1:C:272:ARG:HH12	1.86	0.74
1:E:50:VAL:HG21	1:E:287:GLY:HA3	1.70	0.74
1:A:279:ARG:HG2	1:A:289:ILE:HD13	1.70	0.73
1:E:79:ALA:HB2	1:E:115:LEU:HD23	1.68	0.73
1:E:16:VAL:HG11	1:E:340:LEU:HD12	1.70	0.73
1:E:199:GLN:NE2	1:E:272:ARG:HH12	1.87	0.73
1:E:63:PHE:H	1:E:103:ASN:HD21	1.37	0.73
1:D:173:GLN:NE2	1:D:175:GLN:HE22	1.86	0.72
1:B:241:LEU:HG	1:B:270:PHE:CZ	2.24	0.72
1:A:328:LEU:O	1:A:332:ILE:HG12	1.90	0.71
1:D:51:ILE:HD13	1:D:51:ILE:H	1.56	0.71
1:D:173:GLN:HE21	1:D:175:GLN:NE2	1.85	0.71
1:B:194:ASN:HD22	1:B:194:ASN:N	1.86	0.70
1:E:25:THR:OG1	1:E:97:ALA:HB2	1.91	0.70
1:B:113:ARG:HH11	1:B:113:ARG:HG2	1.55	0.70
1:C:95:THR:HG22	1:C:122:ILE:HD11	1.72	0.70
1:C:141:ARG:HD3	1:C:141:ARG:H	1.56	0.69
1:E:60:THR:HG22	1:E:62:ARG:HG2	1.73	0.69
1:C:274:THR:HG22	1:C:277:GLU:HG3	1.75	0.69
1:E:250:HIS:HA	1:E:253:VAL:HG12	1.74	0.69
1:B:173:GLN:NE2	1:B:175:GLN:HE22	1.88	0.68
1:D:93:VAL:HG21	1:D:332:ILE:HD12	1.75	0.68
1:D:109:ASP:HA	1:D:118:ARG:NH1	2.08	0.68
1:D:87:ILE:HD13	1:D:87:ILE:H	1.58	0.68
1:C:51:ILE:HD13	1:C:51:ILE:H	1.59	0.68
1:C:11:MSE:HG2	1:C:12:SER:H	1.59	0.67
1:D:130:LEU:HD13	1:D:332:ILE:HD13	1.77	0.67
1:C:60:THR:CG2	1:C:62:ARG:HG2	2.18	0.66
1:C:128:ALA:HB1	1:C:161:VAL:HG22	1.77	0.66
1:B:98:THR:HG22	1:B:104:ARG:HG3	1.76	0.66
1:A:146:ALA:H	1:C:199:GLN:NE2	1.94	0.65
1:D:216:ALA:O	1:D:220:VAL:HG12	1.95	0.65
1:E:199:GLN:HE22	1:E:272:ARG:NH2	1.94	0.65
1:A:243:MSE:HE1	1:A:252:VAL:HG22	1.78	0.65
1:D:132:PHE:O	1:D:136:THR:HG22	1.97	0.65
1:B:279:ARG:HG2	1:B:289:ILE:HD13	1.78	0.64
1:B:160:LEU:HD11	1:B:180:MSE:HE2	1.80	0.64
1:B:202:ILE:HD12	1:B:271:LEU:HD11	1.80	0.63
1:B:241:LEU:HD11	1:B:284:ILE:HD11	1.79	0.63
1:B:198:THR:O	1:B:202:ILE:HG12	1.98	0.63
1:E:341:LEU:H	1:E:341:LEU:HD23	1.64	0.63

*Continued on next page...*

*Continued from previous page...*

Atom-1	Atom-2	Interatomic distance (Å)	Clash overlap (Å)
1:C:285:HIS:CD2	1:C:287:GLY:H	2.11	0.62
1:E:108:GLU:HA	1:E:119:PRO:HG2	1.80	0.62
1:B:173:GLN:HE21	1:B:175:GLN:NE2	1.91	0.62
1:C:140:ASN:HD21	1:C:142:ASP:HB3	1.65	0.62
1:C:274:THR:CG2	1:C:277:GLU:H	2.11	0.62
1:C:257:ARG:HB2	1:C:257:ARG:NH1	2.15	0.61
1:A:147:PRO:HD2	1:A:226:ARG:HG3	1.82	0.61
1:A:173:GLN:HE21	1:A:175:GLN:NE2	1.97	0.61
1:E:243:MSE:HE1	1:E:252:VAL:HG12	1.83	0.61
1:C:180:MSE:SE	1:C:213:ILE:HD13	2.51	0.61
1:E:87:ILE:HD12	1:E:87:ILE:O	2.00	0.60
1:C:241:LEU:HG	1:C:270:PHE:CZ	2.36	0.60
1:C:171:THR:HG23	1:C:172:THR:HG23	1.82	0.60
1:D:31:LYS:CB	1:D:329:LEU:HD11	2.32	0.60
1:E:247:GLU:O	1:E:283:THR:HA	2.02	0.60
1:E:238:MSE:HE2	1:E:267:ASP:HA	1.83	0.60
1:C:93:VAL:HG13	1:C:122:ILE:HD12	1.83	0.60
1:D:185:VAL:HA	1:D:291:VAL:HG11	1.84	0.59
1:E:33:ALA:HA	1:E:43:VAL:HG23	1.84	0.59
1:E:128:ALA:HB1	1:E:161:VAL:HG22	1.85	0.59
1:D:63:PHE:HB3	1:D:68:LEU:HD13	1.83	0.59
1:D:40:MSE:HE3	1:D:138:VAL:HG22	1.85	0.59
1:C:122:ILE:HD13	1:C:122:ILE:H	1.68	0.59
1:A:80:GLY:O	1:A:84:GLU:HG3	2.03	0.59
1:E:196:PRO:HD3	1:E:274:THR:HG22	1.84	0.59
1:B:152:ASP:HB3	1:B:159:GLU:CG	2.33	0.58
1:D:231:VAL:HG12	1:D:324:SER:HB3	1.85	0.58
1:D:231:VAL:O	1:D:232:SER:HB2	2.04	0.58
1:D:31:LYS:HB2	1:D:329:LEU:HD11	1.84	0.58
1:E:103:ASN:N	1:E:103:ASN:HD22	1.99	0.58
1:E:216:ALA:O	1:E:220:VAL:HG12	2.02	0.58
1:A:329:LEU:O	1:A:333:VAL:HG12	2.04	0.57
1:C:247:GLU:C	1:C:283:THR:HG22	2.24	0.57
1:A:130:LEU:HD13	1:A:332:ILE:HD13	1.86	0.57
1:C:248:TYR:N	1:C:283:THR:HG22	2.20	0.57
1:D:109:ASP:HA	1:D:118:ARG:HH12	1.69	0.56
1:A:228:ILE:CD1	1:A:318:ILE:HG21	2.22	0.56
1:B:216:ALA:O	1:B:220:VAL:HG12	2.06	0.56
1:B:133:LEU:HD12	1:B:331:GLY:HA2	1.87	0.56
1:C:139:VAL:HG22	3:C:466:HOH:O	2.06	0.56
1:C:141:ARG:H	1:C:141:ARG:CD	2.19	0.56

*Continued on next page...*

*Continued from previous page...*

Atom-1	Atom-2	Interatomic distance (Å)	Clash overlap (Å)
1:D:128:ALA:HB1	1:D:161:VAL:HG22	1.87	0.56
1:E:130:LEU:HD23	1:E:332:ILE:HD13	1.87	0.56
1:A:25:THR:HG23	1:A:54:GLY:HA3	1.87	0.56
1:E:240:ALA:HB1	1:E:245:LEU:HD12	1.88	0.55
1:E:328:LEU:O	1:E:332:ILE:HG12	2.07	0.55
1:E:132:PHE:O	1:E:136:THR:HG22	2.06	0.55
1:E:194:ASN:N	1:E:194:ASN:HD22	2.05	0.55
1:C:231:VAL:HG12	1:C:324:SER:HB3	1.89	0.55
1:E:31:LYS:HE3	1:E:42:GLU:HG2	1.90	0.54
1:B:276:ALA:HA	1:B:279:ARG:NH1	2.22	0.54
1:E:62:ARG:HA	1:E:101:ALA:HB1	1.89	0.54
1:B:198:THR:OG1	1:B:201:GLN:HG3	2.07	0.54
1:B:194:ASN:N	1:B:194:ASN:ND2	2.55	0.54
1:C:122:ILE:H	1:C:122:ILE:CD1	2.21	0.54
1:E:99:ARG:HH11	1:E:99:ARG:HB2	1.73	0.54
1:C:141:ARG:HD3	1:C:141:ARG:N	2.23	0.53
1:A:273:MSE:HG2	1:A:277:GLU:HB2	1.91	0.53
1:E:77:GLU:O	1:E:81:VAL:HG23	2.08	0.53
1:E:64:ALA:HB1	1:E:66:GLU:OE2	2.09	0.53
1:E:78:PHE:O	1:E:82:ILE:HG12	2.09	0.53
1:A:279:ARG:CG	1:A:289:ILE:HD13	2.37	0.52
1:A:285:HIS:CD2	1:A:287:GLY:H	2.14	0.52
1:B:16:VAL:HG13	1:B:341:LEU:HD21	1.90	0.52
1:B:113:ARG:HG2	1:B:113:ARG:NH1	2.23	0.52
1:D:196:PRO:HD3	1:D:274:THR:HG22	1.91	0.52
1:E:31:LYS:HB2	1:E:329:LEU:HD21	1.92	0.52
1:D:29:ARG:HD3	1:D:46:ARG:HD2	1.92	0.52
1:D:285:HIS:CD2	1:D:287:GLY:H	2.27	0.52
1:E:93:VAL:CG1	1:E:122:ILE:HD12	2.40	0.52
1:A:58:ASP:OD2	1:A:190:ARG:HD3	2.09	0.52
1:C:274:THR:HG23	1:C:276:ALA:N	2.25	0.52
1:C:238:MSE:HE2	1:C:267:ASP:OD1	2.10	0.52
1:E:226:ARG:HG3	1:E:226:ARG:HH11	1.74	0.52
1:E:231:VAL:O	1:E:232:SER:HB3	2.09	0.52
1:D:234:THR:O	1:D:238:MSE:HG2	2.09	0.51
1:E:51:ILE:O	1:E:70:ARG:HD2	2.11	0.51
1:C:274:THR:CG2	1:C:277:GLU:HG3	2.39	0.51
1:C:199:GLN:HE22	1:C:272:ARG:HH12	1.58	0.51
1:E:50:VAL:HG13	1:E:50:VAL:O	2.10	0.51
1:C:199:GLN:HE22	1:C:272:ARG:HH22	1.58	0.51
1:C:233:GLY:HA3	2:C:346:SO4:O3	2.10	0.51

*Continued on next page...*

*Continued from previous page...*

Atom-1	Atom-2	Interatomic distance (Å)	Clash overlap (Å)
1:B:234:THR:O	1:B:238:MSE:HG2	2.10	0.51
1:C:35:VAL:HG22	1:C:40:MSE:HB3	1.92	0.51
1:C:238:MSE:CE	1:C:267:ASP:HA	2.39	0.51
1:D:304:ALA:O	1:D:308:GLU:HG3	2.11	0.51
1:E:188:THR:HG21	1:E:290:ASP:O	2.10	0.51
1:C:113:ARG:HG3	1:C:113:ARG:HH11	1.76	0.51
1:C:278:ARG:HD3	1:C:292:VAL:HG21	1.92	0.51
1:D:108:GLU:HG2	1:D:119:PRO:HG2	1.92	0.51
1:C:275:ARG:HD2	1:C:290:ASP:HA	1.93	0.51
1:A:274:THR:HG23	1:A:276:ALA:H	1.77	0.50
1:E:127:GLU:O	1:E:131:SER:HB2	2.11	0.50
1:B:136:THR:O	1:B:139:VAL:HG22	2.11	0.50
1:E:132:PHE:HB2	1:E:161:VAL:HG11	1.93	0.50
1:B:58:ASP:HB2	1:B:59:LYS:NZ	2.26	0.50
1:A:173:GLN:NE2	1:A:175:GLN:HE22	2.04	0.50
1:B:242:ALA:HA	1:B:266:VAL:HG11	1.93	0.50
1:C:87:ILE:HD13	1:C:87:ILE:H	1.75	0.50
1:A:32:ILE:HD12	1:A:44:VAL:HG21	1.93	0.50
1:B:104:ARG:HD3	1:B:108:GLU:OE1	2.11	0.50
1:B:48:LEU:HD21	1:B:288:ARG:NH2	2.27	0.50
1:E:76:ARG:HA	1:E:114:ILE:HG21	1.94	0.50
1:D:31:LYS:C	1:D:32:ILE:HD12	2.32	0.49
1:D:56:ASP:HA	1:D:189:GLU:OE1	2.12	0.49
1:E:149:LEU:HD23	1:E:162:ILE:HB	1.93	0.49
1:E:232:SER:O	1:E:236:THR:HG22	2.12	0.49
1:D:110:GLU:O	1:D:114:ILE:HG12	2.11	0.49
1:E:34:ARG:HG2	1:E:41:HIS:HB2	1.94	0.49
1:B:87:ILE:HD13	1:B:87:ILE:H	1.77	0.49
1:D:94:ALA:HB1	1:D:98:THR:OG1	2.12	0.49
1:E:108:GLU:HG2	1:E:119:PRO:HB2	1.93	0.49
1:E:250:HIS:HA	1:E:253:VAL:CG1	2.42	0.49
1:D:19:ALA:HB2	1:D:32:ILE:HG13	1.93	0.49
1:D:181:ASN:HB3	1:D:186:ARG:NH1	2.27	0.49
1:D:288:ARG:O	1:D:292:VAL:HG23	2.13	0.49
1:B:200:THR:O	1:B:204:GLU:HG3	2.12	0.49
1:D:50:VAL:HG21	1:D:285:HIS:CD2	2.48	0.49
1:D:237:THR:O	1:D:241:LEU:HD13	2.12	0.49
1:E:103:ASN:ND2	1:E:103:ASN:H	2.11	0.49
1:C:113:ARG:HG3	1:C:113:ARG:NH1	2.28	0.48
1:B:202:ILE:CD1	1:B:271:LEU:HD11	2.44	0.48
1:A:311:LYS:HE3	1:A:317:ALA:HB2	1.94	0.48

*Continued on next page...*



*Continued from previous page...*

Atom-1	Atom-2	Interatomic distance (Å)	Clash overlap (Å)
1:B:246:LYS:O	1:B:282:LYS:HB2	2.13	0.48
1:D:51:ILE:H	1:D:51:ILE:CD1	2.23	0.48
1:E:181:ASN:HB3	1:E:186:ARG:HH11	1.77	0.48
1:B:325:GLU:OE1	1:B:325:GLU:HA	2.13	0.48
1:C:192:LEU:HD22	1:C:202:ILE:HD13	1.95	0.48
1:C:274:THR:HG23	1:C:276:ALA:H	1.76	0.48
1:B:333:VAL:HG23	1:B:334:LEU:N	2.29	0.48
1:C:146:ALA:HB1	1:C:147:PRO:HA	1.95	0.48
1:C:216:ALA:O	1:C:220:VAL:HG12	2.13	0.48
1:A:32:ILE:HB	1:A:44:VAL:HG23	1.95	0.47
1:B:98:THR:CG2	1:B:104:ARG:HG3	2.44	0.47
1:A:274:THR:HB	1:A:277:GLU:OE1	2.13	0.47
1:C:273:MSE:HG2	1:C:277:GLU:HB2	1.96	0.47
1:D:293:GLY:O	1:D:297:VAL:HG23	2.14	0.47
1:B:144:LEU:N	1:B:144:LEU:HD12	2.29	0.47
1:C:240:ALA:HB1	1:C:245:LEU:HD12	1.95	0.47
1:D:31:LYS:HE3	1:D:42:GLU:HG3	1.96	0.47
1:E:103:ASN:HD22	1:E:103:ASN:H	1.63	0.47
1:E:117:VAL:HG12	1:E:118:ARG:H	1.79	0.47
1:A:343:GLN:HE21	1:A:343:GLN:HB3	1.57	0.47
1:B:122:ILE:HD12	1:B:122:ILE:O	2.14	0.47
1:B:242:ALA:CA	1:B:266:VAL:HG11	2.44	0.47
1:E:103:ASN:N	1:E:103:ASN:ND2	2.62	0.47
1:A:313:ASP:OD2	1:A:314:HIS:HD2	1.96	0.47
1:B:231:VAL:HG12	1:B:324:SER:HB3	1.97	0.47
1:D:50:VAL:HG11	1:D:287:GLY:HA3	1.96	0.47
1:D:250:HIS:O	1:D:253:VAL:HG22	2.15	0.47
1:D:215:GLU:HG3	1:D:218:ARG:NH2	2.29	0.47
1:B:17:THR:O	1:B:87:ILE:HB	2.15	0.46
1:D:286:PRO:HA	1:D:289:ILE:HD13	1.97	0.46
1:E:99:ARG:HB2	1:E:99:ARG:NH1	2.30	0.46
1:E:108:GLU:HB3	1:E:119:PRO:HD2	1.97	0.46
1:C:58:ASP:OD2	1:C:190:ARG:HD3	2.15	0.46
1:A:216:ALA:O	1:A:220:VAL:HG12	2.15	0.46
1:A:249:ASP:O	1:A:252:VAL:HG12	2.16	0.46
1:E:63:PHE:HB3	1:E:68:LEU:HD13	1.98	0.46
1:E:277:GLU:O	1:E:280:GLU:HB2	2.15	0.46
1:B:186:ARG:O	1:B:190:ARG:HB2	2.15	0.46
1:D:258:LEU:HD22	1:D:262:ASP:HB2	1.97	0.46
1:D:195:ASP:CG	1:D:275:ARG:HG3	2.36	0.46
1:C:31:LYS:HB2	1:C:329:LEU:CD1	2.46	0.46

*Continued on next page...*

*Continued from previous page...*

Atom-1	Atom-2	Interatomic distance (Å)	Clash overlap (Å)
1:A:27:SER:HB3	1:A:50:VAL:HA	1.97	0.46
1:B:155:GLY:O	1:B:185:VAL:HB	2.15	0.46
1:A:60:THR:CG2	1:A:62:ARG:HG2	2.41	0.46
1:C:79:ALA:HB2	1:C:115:LEU:HD23	1.97	0.46
1:A:31:LYS:HD3	1:A:333:VAL:HG11	1.98	0.46
1:E:226:ARG:HH12	1:E:314:HIS:CE1	2.34	0.46
1:E:250:HIS:CA	1:E:253:VAL:HG12	2.44	0.46
1:C:149:LEU:HD23	1:C:162:ILE:HB	1.98	0.45
1:E:226:ARG:HG3	1:E:226:ARG:NH1	2.32	0.45
1:C:66:GLU:H	1:C:66:GLU:CD	2.19	0.45
1:C:82:ILE:HD13	1:C:90:LEU:HD22	1.99	0.45
1:D:275:ARG:HG2	1:D:275:ARG:HH11	1.81	0.45
1:D:158:THR:HB	1:D:182:ILE:HD11	1.98	0.45
1:D:251:THR:O	1:D:253:VAL:N	2.49	0.45
1:E:53:LEU:HD22	1:E:63:PHE:CE1	2.52	0.45
1:B:328:LEU:O	1:B:332:ILE:HG13	2.16	0.45
1:D:104:ARG:O	1:D:108:GLU:HG3	2.16	0.45
1:A:104:ARG:O	1:A:108:GLU:HG3	2.17	0.45
1:C:314:HIS:HE1	3:C:419:HOH:O	2.00	0.45
1:D:254:ASP:HB2	1:D:325:GLU:HG2	1.99	0.45
1:E:246:LYS:O	1:E:282:LYS:HB3	2.17	0.45
1:E:341:LEU:H	1:E:341:LEU:CD2	2.29	0.45
1:A:149:LEU:HD23	1:A:162:ILE:HB	1.99	0.45
1:E:226:ARG:HH12	1:E:314:HIS:CG	2.35	0.45
1:A:146:ALA:H	1:C:199:GLN:HE21	1.64	0.44
1:B:156:GLY:O	1:B:186:ARG:HD2	2.16	0.44
1:A:311:LYS:CE	1:A:317:ALA:HB2	2.48	0.44
1:C:274:THR:HG22	1:C:277:GLU:N	2.25	0.44
1:D:26:ASN:O	1:D:50:VAL:HG13	2.18	0.44
1:E:231:VAL:O	1:E:232:SER:CB	2.66	0.44
1:B:141:ARG:H	1:B:141:ARG:HD2	1.81	0.44
1:C:238:MSE:CE	1:C:266:VAL:HG13	2.42	0.44
1:A:279:ARG:NH2	3:A:395:HOH:O	2.49	0.44
1:E:117:VAL:HG12	1:E:118:ARG:N	2.33	0.44
1:C:241:LEU:HG	1:C:270:PHE:CE2	2.53	0.44
1:D:29:ARG:HA	1:D:47:ILE:O	2.18	0.44
1:E:72:TYR:HA	1:E:75:ALA:HB3	1.99	0.44
1:E:273:MSE:HG2	1:E:277:GLU:HB3	1.99	0.44
1:D:59:LYS:HG3	1:D:60:THR:N	2.32	0.43
1:D:182:ILE:HD13	1:D:182:ILE:H	1.83	0.43
1:E:24:GLY:HA2	1:E:95:THR:OG1	2.18	0.43

*Continued on next page...*

*Continued from previous page...*

Atom-1	Atom-2	Interatomic distance (Å)	Clash overlap (Å)
1:C:122:ILE:HD13	1:C:122:ILE:N	2.30	0.43
1:D:195:ASP:OD1	1:D:275:ARG:HG3	2.18	0.43
1:E:111:ILE:HD12	1:E:111:ILE:N	2.33	0.43
1:A:340:LEU:C	1:A:342:ALA:H	2.21	0.43
1:B:48:LEU:HD12	1:B:49:ARG:N	2.34	0.43
1:B:199:GLN:HE22	1:B:272:ARG:HH22	1.67	0.43
1:D:241:LEU:HD23	1:D:270:PHE:CE2	2.52	0.43
1:E:20:GLY:O	1:E:30:LEU:HD12	2.18	0.43
1:C:109:ASP:OD2	1:C:118:ARG:NH1	2.52	0.43
1:D:161:VAL:HG13	1:D:177:ALA:HB2	2.00	0.43
1:D:228:ILE:CD1	1:D:306:VAL:HG11	2.48	0.43
1:E:66:GLU:OE2	1:E:66:GLU:N	2.52	0.43
1:E:145:PRO:HG2	1:E:227:THR:HG23	2.00	0.43
1:D:63:PHE:HB2	1:D:103:ASN:ND2	2.23	0.43
1:E:40:MSE:HG3	1:E:334:LEU:HG	2.01	0.43
1:A:278:ARG:HD3	1:A:292:VAL:HG11	1.98	0.43
1:B:141:ARG:HD2	1:B:141:ARG:N	2.34	0.43
1:C:274:THR:HG22	1:C:277:GLU:CG	2.47	0.43
1:E:57:VAL:HG12	1:E:57:VAL:O	2.19	0.43
1:B:68:LEU:HD12	1:B:68:LEU:HA	1.92	0.43
1:C:53:LEU:HG	1:C:63:PHE:CE1	2.53	0.43
1:B:31:LYS:HE2	1:B:42:GLU:OE2	2.19	0.43
1:B:182:ILE:HD12	1:B:182:ILE:O	2.19	0.43
1:A:236:THR:HG21	1:A:325:GLU:OE1	2.19	0.43
1:A:274:THR:HG22	1:A:277:GLU:N	2.17	0.42
1:D:25:THR:HA	1:D:97:ALA:HB2	2.01	0.42
1:D:118:ARG:HG3	1:D:119:PRO:HD2	2.00	0.42
1:D:186:ARG:HG2	1:D:187:MSE:CE	2.49	0.42
1:E:53:LEU:HD22	1:E:63:PHE:CD1	2.54	0.42
1:E:143:ASP:O	1:E:144:LEU:HD22	2.19	0.42
1:C:31:LYS:HB2	1:C:329:LEU:HD13	2.02	0.42
1:C:173:GLN:NE2	1:C:175:GLN:HE22	2.07	0.42
1:D:186:ARG:HG2	1:D:187:MSE:HE2	2.01	0.42
1:A:144:LEU:HA	1:A:145:PRO:HD2	1.98	0.42
1:C:28:ILE:HG22	1:C:51:ILE:HD12	2.01	0.42
1:E:28:ILE:HG22	1:E:49:ARG:O	2.20	0.42
1:D:199:GLN:OE1	1:D:272:ARG:NH2	2.52	0.42
1:E:101:ALA:HB1	1:E:103:ASN:ND2	2.35	0.42
1:B:187:MSE:HE2	1:B:187:MSE:HA	2.02	0.42
1:D:213:ILE:HG21	1:D:305:ARG:HG3	2.02	0.42
1:A:199:GLN:HB2	1:D:145:PRO:HA	2.02	0.42

*Continued on next page...*

*Continued from previous page...*

Atom-1	Atom-2	Interatomic distance (Å)	Clash overlap (Å)
1:B:33:ALA:HA	1:B:43:VAL:HG23	2.02	0.42
1:C:285:HIS:CD2	1:C:286:PRO:HD2	2.55	0.41
1:A:40:MSE:HE2	1:A:334:LEU:HG	2.01	0.41
1:B:275:ARG:O	1:B:279:ARG:HG3	2.21	0.41
1:B:284:ILE:HD12	1:B:284:ILE:N	2.35	0.41
1:C:140:ASN:ND2	1:C:142:ASP:HB3	2.33	0.41
1:D:31:LYS:HB3	1:D:329:LEU:HD11	2.01	0.41
1:D:108:GLU:HA	1:D:119:PRO:HG3	2.02	0.41
1:D:258:LEU:HD23	1:D:258:LEU:HA	1.89	0.41
1:E:76:ARG:HA	1:E:114:ILE:CG2	2.51	0.41
1:C:185:VAL:HG22	1:C:291:VAL:HG11	2.03	0.41
1:D:40:MSE:HE2	1:D:334:LEU:HG	2.03	0.41
1:A:227:THR:HG22	1:A:229:ILE:CD1	2.51	0.41
1:D:58:ASP:OD2	1:D:190:ARG:HD2	2.20	0.41
1:E:149:LEU:HB2	1:E:225:ALA:HB2	2.03	0.41
1:A:53:LEU:HG	1:A:63:PHE:CE1	2.55	0.41
1:D:254:ASP:HB2	1:D:325:GLU:CG	2.50	0.41
1:C:197:PRO:CG	1:C:202:ILE:HD11	2.51	0.41
1:A:198:THR:OG1	1:A:201:GLN:HG3	2.20	0.41
1:B:91:ARG:NH2	1:B:122:ILE:HG21	2.35	0.41
1:B:122:ILE:CD1	1:B:127:GLU:HB2	2.51	0.41
1:B:143:ASP:HB2	1:B:144:LEU:HD12	2.02	0.41
1:D:138:VAL:HG21	1:D:330:ASP:HB3	2.01	0.41
1:D:215:GLU:HA	1:D:218:ARG:CZ	2.51	0.41
1:E:43:VAL:HG11	1:E:85:HIS:NE2	2.35	0.41
1:B:82:ILE:CG2	1:B:87:ILE:HD12	2.47	0.41
1:B:149:LEU:HD23	1:B:162:ILE:HB	2.02	0.41
1:D:25:THR:HG23	1:D:54:GLY:HA3	2.03	0.41
1:A:149:LEU:HB2	1:A:225:ALA:HB2	2.03	0.40
1:C:104:ARG:O	1:C:108:GLU:HG3	2.21	0.40
1:C:112:GLU:HA	1:C:117:VAL:O	2.21	0.40
1:C:246:LYS:HB2	1:C:246:LYS:NZ	2.36	0.40
1:C:257:ARG:HH11	1:C:257:ARG:CB	2.27	0.40
1:A:273:MSE:HG2	1:A:277:GLU:CB	2.51	0.40
1:B:182:ILE:HD12	1:B:182:ILE:C	2.42	0.40
1:B:284:ILE:HG22	1:B:289:ILE:HG13	2.04	0.40
1:E:31:LYS:HE3	1:E:42:GLU:OE2	2.21	0.40
1:E:247:GLU:HB2	1:E:248:TYR:H	1.49	0.40
1:B:298:VAL:O	1:B:302:VAL:HG23	2.21	0.40
1:D:72:TYR:CE1	1:D:110:GLU:HG2	2.56	0.40
1:D:87:ILE:H	1:D:87:ILE:CD1	2.31	0.40

*Continued on next page...*

Continued from previous page...

Atom-1	Atom-2	Interatomic distance (Å)	Clash overlap (Å)
1:E:62:ARG:HA	1:E:101:ALA:CB	2.50	0.40
1:E:199:GLN:HE22	1:E:272:ARG:NH1	2.19	0.40
1:E:336:TYR:HD1	1:E:339:ARG:NH2	2.19	0.40
1:A:146:ALA:HB1	1:A:147:PRO:HA	2.04	0.40
1:A:274:THR:CG2	1:A:277:GLU:HG3	2.51	0.40
1:B:126:GLU:O	1:B:130:LEU:HG	2.21	0.40
1:D:69:GLU:HA	1:D:72:TYR:CD2	2.57	0.40
1:A:112:GLU:CD	1:A:118:ARG:HD2	2.42	0.40
1:A:256:HIS:HE1	3:A:374:HOH:O	2.04	0.40
1:B:58:ASP:HB2	1:B:59:LYS:HZ3	1.86	0.40
1:B:133:LEU:HA	1:B:136:THR:HG22	2.03	0.40
1:D:186:ARG:O	1:D:190:ARG:HG2	2.22	0.40

There are no symmetry-related clashes.

## 5.3 Torsion angles [i](#)

### 5.3.1 Protein backbone [i](#)

In the following table, the Percentiles column shows the percent Ramachandran outliers of the chain as a percentile score with respect to all X-ray entries followed by that with respect to entries of similar resolution.

The Analysed column shows the number of residues for which the backbone conformation was analysed, and the total number of residues.

Mol	Chain	Analysed	Favoured	Allowed	Outliers	Percentiles	
1	A	328/343 (96%)	317 (97%)	8 (2%)	3 (1%)	17	25
1	B	328/343 (96%)	316 (96%)	10 (3%)	2 (1%)	25	36
1	C	331/343 (96%)	321 (97%)	9 (3%)	1 (0%)	41	55
1	D	328/343 (96%)	307 (94%)	18 (6%)	3 (1%)	17	25
1	E	318/343 (93%)	296 (93%)	19 (6%)	3 (1%)	17	25
All	All	1633/1715 (95%)	1557 (95%)	64 (4%)	12 (1%)	22	32

All (12) Ramachandran outliers are listed below:

Mol	Chain	Res	Type
1	D	247	GLU
1	D	252	VAL

Continued on next page...

*Continued from previous page...*

Mol	Chain	Res	Type
1	B	181	ASN
1	B	232	SER
1	C	232	SER
1	D	251	THR
1	E	108	GLU
1	E	232	SER
1	A	46	ARG
1	A	232	SER
1	A	342	ALA
1	E	138	VAL

### 5.3.2 Protein sidechains [i](#)

In the following table, the Percentiles column shows the percent sidechain outliers of the chain as a percentile score with respect to all X-ray entries followed by that with respect to entries of similar resolution.

The Analysed column shows the number of residues for which the sidechain conformation was analysed, and the total number of residues.

Mol	Chain	Analysed	Rotameric	Outliers	Percentiles	
1	A	264/268 (98%)	249 (94%)	15 (6%)	20	33
1	B	264/268 (98%)	256 (97%)	8 (3%)	41	61
1	C	267/268 (100%)	250 (94%)	17 (6%)	17	28
1	D	264/268 (98%)	249 (94%)	15 (6%)	20	33
1	E	258/268 (96%)	248 (96%)	10 (4%)	32	50
All	All	1317/1340 (98%)	1252 (95%)	65 (5%)	25	40

All (65) residues with a non-rotameric sidechain are listed below:

Mol	Chain	Res	Type
1	A	26	ASN
1	A	68	LEU
1	A	133	LEU
1	A	136	THR
1	A	159	GLU
1	A	161	VAL
1	A	190	ARG
1	A	258	LEU
1	A	271	LEU

*Continued on next page...*

*Continued from previous page...*

<b>Mol</b>	<b>Chain</b>	<b>Res</b>	<b>Type</b>
1	A	274	THR
1	A	290	ASP
1	A	329	LEU
1	A	333	VAL
1	A	334	LEU
1	A	343	GLN
1	B	87	ILE
1	B	141	ARG
1	B	171	THR
1	B	194	ASN
1	B	219	THR
1	B	241	LEU
1	B	329	LEU
1	B	330	ASP
1	C	51	ILE
1	C	68	LEU
1	C	87	ILE
1	C	122	ILE
1	C	133	LEU
1	C	141	ARG
1	C	142	ASP
1	C	149	LEU
1	C	190	ARG
1	C	219	THR
1	C	232	SER
1	C	241	LEU
1	C	246	LYS
1	C	257	ARG
1	C	271	LEU
1	C	274	THR
1	C	329	LEU
1	D	51	ILE
1	D	59	LYS
1	D	65	ASP
1	D	87	ILE
1	D	109	ASP
1	D	133	LEU
1	D	139	VAL
1	D	142	ASP
1	D	182	ILE
1	D	219	THR
1	D	250	HIS

*Continued on next page...*

*Continued from previous page...*

Mol	Chain	Res	Type
1	D	258	LEU
1	D	271	LEU
1	D	272	ARG
1	D	334	LEU
1	E	53	LEU
1	E	68	LEU
1	E	103	ASN
1	E	122	ILE
1	E	140	ASN
1	E	226	ARG
1	E	247	GLU
1	E	258	LEU
1	E	277	GLU
1	E	334	LEU

Sometimes sidechains can be flipped to improve hydrogen bonding and reduce clashes. All (26) such sidechains are listed below:

Mol	Chain	Res	Type
1	A	26	ASN
1	A	175	GLN
1	A	256	HIS
1	A	285	HIS
1	A	314	HIS
1	A	326	HIS
1	A	343	GLN
1	B	173	GLN
1	B	181	ASN
1	B	194	ASN
1	B	199	GLN
1	C	140	ASN
1	C	173	GLN
1	C	199	GLN
1	C	285	HIS
1	C	314	HIS
1	C	326	HIS
1	D	85	HIS
1	D	173	GLN
1	E	103	ASN
1	E	140	ASN
1	E	191	HIS
1	E	194	ASN
1	E	199	GLN

*Continued on next page...*



*Continued from previous page...*

Mol	Chain	Res	Type
1	E	212	HIS
1	E	314	HIS

### 5.3.3 RNA [i](#)

There are no RNA molecules in this entry.

### 5.4 Non-standard residues in protein, DNA, RNA chains [i](#)

There are no non-standard protein/DNA/RNA residues in this entry.

### 5.5 Carbohydrates [i](#)

There are no monosaccharides in this entry.

### 5.6 Ligand geometry [i](#)

16 ligands are modelled in this entry.

In the following table, the Counts columns list the number of bonds (or angles) for which Mogul statistics could be retrieved, the number of bonds (or angles) that are observed in the model and the number of bonds (or angles) that are defined in the Chemical Component Dictionary. The Link column lists molecule types, if any, to which the group is linked. The Z score for a bond length (or angle) is the number of standard deviations the observed value is removed from the expected value. A bond length (or angle) with  $|Z| > 2$  is considered an outlier worth inspection. RMSZ is the root-mean-square of all Z scores of the bond lengths (or angles).

Mol	Type	Chain	Res	Link	Bond lengths			Bond angles		
					Counts	RMSZ	$\# Z  > 2$	Counts	RMSZ	$\# Z  > 2$
2	SO4	D	345	-	4,4,4	0.25	0	6,6,6	0.08	0
2	SO4	D	344	-	4,4,4	0.25	0	6,6,6	0.07	0
2	SO4	B	345	-	4,4,4	0.27	0	6,6,6	0.23	0
2	SO4	E	345	-	4,4,4	0.24	0	6,6,6	0.06	0
2	SO4	D	346	-	4,4,4	0.27	0	6,6,6	0.06	0
2	SO4	A	345	-	4,4,4	0.24	0	6,6,6	0.16	0
2	SO4	E	346	-	4,4,4	0.28	0	6,6,6	0.07	0
2	SO4	E	344	-	4,4,4	0.27	0	6,6,6	0.08	0
2	SO4	A	346	-	4,4,4	0.33	0	6,6,6	0.18	0
2	SO4	C	344	-	4,4,4	0.35	0	6,6,6	0.09	0
2	SO4	A	344	-	4,4,4	0.22	0	6,6,6	0.17	0
2	SO4	C	346	-	4,4,4	0.26	0	6,6,6	0.12	0

Mol	Type	Chain	Res	Link	Bond lengths			Bond angles		
					Counts	RMSZ	# Z  > 2	Counts	RMSZ	# Z  > 2
2	SO4	B	346	-	4,4,4	0.28	0	6,6,6	0.05	0
2	SO4	B	344	-	4,4,4	0.26	0	6,6,6	0.11	0
2	SO4	C	347	-	4,4,4	0.30	0	6,6,6	0.14	0
2	SO4	C	345	-	4,4,4	0.31	0	6,6,6	0.11	0

There are no bond length outliers.

There are no bond angle outliers.

There are no chirality outliers.

There are no torsion outliers.

There are no ring outliers.

1 monomer is involved in 1 short contact:

Mol	Chain	Res	Type	Clashes	Symm-Clashes
2	C	346	SO4	1	0

## 5.7 Other polymers [i](#)

There are no such residues in this entry.

## 5.8 Polymer linkage issues [i](#)

There are no chain breaks in this entry.

## 6 Fit of model and data

### 6.1 Protein, DNA and RNA chains

In the following table, the column labelled ‘#RSRZ > 2’ contains the number (and percentage) of RSRZ outliers, followed by percent RSRZ outliers for the chain as percentile scores relative to all X-ray entries and entries of similar resolution. The OWAB column contains the minimum, median, 95<sup>th</sup> percentile and maximum values of the occupancy-weighted average B-factor per residue. The column labelled ‘Q < 0.9’ lists the number of (and percentage) of residues with an average occupancy less than 0.9.

Mol	Chain	Analysed	<RSRZ>	#RSRZ>2	OWAB(Å <sup>2</sup> )	Q<0.9
1	A	324/343 (94%)	-0.19	5 (1%) 73 72	14, 29, 56, 81	0
1	B	324/343 (94%)	0.19	14 (4%) 35 33	22, 43, 74, 85	0
1	C	326/343 (95%)	-0.23	9 (2%) 53 51	10, 24, 57, 87	0
1	D	324/343 (94%)	0.59	38 (11%) 4 4	19, 56, 79, 93	0
1	E	316/343 (92%)	0.99	60 (18%) 1 1	33, 61, 93, 100	0
All	All	1614/1715 (94%)	0.27	126 (7%) 13 11	10, 43, 82, 100	0

All (126) RSRZ outliers are listed below:

Mol	Chain	Res	Type	RSRZ
1	E	248	TYR	7.5
1	E	83	ALA	5.5
1	A	343	GLN	5.4
1	E	115	LEU	5.2
1	E	102	GLU	5.0
1	E	251	THR	4.9
1	E	63	PHE	4.7
1	E	252	VAL	4.6
1	D	247	GLU	4.6
1	E	87	ILE	4.5
1	E	64	ALA	4.4
1	E	60	THR	4.4
1	E	86	PRO	4.4
1	D	248	TYR	4.3
1	D	342	ALA	4.3
1	D	142	ASP	4.2
1	E	247	GLU	4.0
1	E	85	HIS	4.0
1	B	100	ASP	4.0
1	D	66	GLU	4.0

*Continued on next page...*

*Continued from previous page...*

<b>Mol</b>	<b>Chain</b>	<b>Res</b>	<b>Type</b>	<b>RSRZ</b>
1	E	66	GLU	3.9
1	E	101	ALA	3.9
1	D	246	LYS	3.9
1	E	89	GLY	3.8
1	D	251	THR	3.8
1	D	276	ALA	3.8
1	C	250	HIS	3.7
1	D	63	PHE	3.5
1	E	143	ASP	3.5
1	E	18	VAL	3.5
1	E	78	PHE	3.5
1	D	250	HIS	3.5
1	B	59	LYS	3.4
1	C	142	ASP	3.4
1	E	88	ASP	3.4
1	E	111	ILE	3.4
1	E	17	THR	3.3
1	E	100	ASP	3.3
1	B	249	ASP	3.2
1	E	62	ARG	3.2
1	E	43	VAL	3.2
1	D	249	ASP	3.2
1	E	41	HIS	3.2
1	E	153	LEU	3.1
1	A	342	ALA	3.1
1	E	69	GLU	3.1
1	D	37	ALA	3.0
1	E	341	LEU	3.0
1	B	38	ASP	3.0
1	E	339	ARG	3.0
1	C	12	SER	3.0
1	D	151	VAL	3.0
1	E	250	HIS	2.9
1	D	245	LEU	2.9
1	E	234	THR	2.9
1	D	193	THR	2.9
1	E	59	LYS	2.9
1	D	113	ARG	2.8
1	D	59	LYS	2.8
1	B	343	GLN	2.8
1	E	93	VAL	2.8
1	D	38	ASP	2.8

*Continued on next page...*

*Continued from previous page...*

<b>Mol</b>	<b>Chain</b>	<b>Res</b>	<b>Type</b>	<b>RSRZ</b>
1	C	251	THR	2.7
1	E	184	SER	2.7
1	E	249	ASP	2.7
1	E	117	VAL	2.7
1	B	143	ASP	2.7
1	E	235	VAL	2.7
1	E	107	PHE	2.7
1	D	289	ILE	2.6
1	D	111	ILE	2.6
1	E	104	ARG	2.6
1	E	142	ASP	2.6
1	E	336	TYR	2.6
1	D	13	LYS	2.5
1	D	64	ALA	2.5
1	E	67	ALA	2.5
1	B	246	LYS	2.5
1	B	248	TYR	2.5
1	D	107	PHE	2.4
1	B	37	ALA	2.4
1	E	124	GLY	2.4
1	E	34	ARG	2.4
1	E	125	THR	2.4
1	E	154	GLY	2.4
1	C	14	GLU	2.4
1	E	52	ARG	2.4
1	D	153	LEU	2.4
1	E	50	VAL	2.3
1	C	248	TYR	2.3
1	B	250	HIS	2.3
1	E	121	VAL	2.3
1	B	102	GLU	2.3
1	E	22	ASP	2.3
1	E	340	LEU	2.3
1	C	247	GLU	2.3
1	B	39	GLY	2.3
1	D	24	GLY	2.3
1	D	61	HIS	2.3
1	D	140	ASN	2.2
1	D	235	VAL	2.2
1	A	14	GLU	2.2
1	D	14	GLU	2.2
1	E	42	GLU	2.2

*Continued on next page...*

*Continued from previous page...*

Mol	Chain	Res	Type	RSRZ
1	D	299	TRP	2.2
1	B	247	GLU	2.2
1	E	49	ARG	2.2
1	A	151	VAL	2.2
1	E	116	GLY	2.2
1	C	249	ASP	2.1
1	D	65	ASP	2.1
1	A	38	ASP	2.1
1	D	282	LYS	2.1
1	B	231	VAL	2.1
1	E	296	ALA	2.1
1	D	52	ARG	2.1
1	E	108	GLU	2.1
1	D	115	LEU	2.1
1	D	94	ALA	2.1
1	E	141	ARG	2.1
1	D	286	PRO	2.0
1	D	69	GLU	2.0
1	E	84	GLU	2.0
1	C	342	ALA	2.0
1	E	81	VAL	2.0
1	D	114	ILE	2.0

## 6.2 Non-standard residues in protein, DNA, RNA chains [\(i\)](#)

There are no non-standard protein/DNA/RNA residues in this entry.

## 6.3 Carbohydrates [\(i\)](#)

There are no monosaccharides in this entry.

## 6.4 Ligands [\(i\)](#)

In the following table, the Atoms column lists the number of modelled atoms in the group and the number defined in the chemical component dictionary. The B-factors column lists the minimum, median, 95<sup>th</sup> percentile and maximum values of B factors of atoms in the group. The column labelled 'Q< 0.9' lists the number of atoms with occupancy less than 0.9.

Mol	Type	Chain	Res	Atoms	RSCC	RSR	B-factors( $\text{\AA}^2$ )	Q<0.9
2	SO4	E	345	5/5	0.66	0.46	117,117,118,118	0

*Continued on next page...*

*Continued from previous page...*

Mol	Type	Chain	Res	Atoms	RSCC	RSR	B-factors( $\text{\AA}^2$ )	Q<0.9
2	SO4	B	346	5/5	0.78	0.34	91,92,93,93	0
2	SO4	A	346	5/5	0.78	0.31	58,59,63,65	0
2	SO4	C	347	5/5	0.79	0.39	67,68,69,72	0
2	SO4	E	346	5/5	0.79	0.27	98,98,98,99	0
2	SO4	D	344	5/5	0.82	0.30	81,83,83,84	0
2	SO4	D	346	5/5	0.84	0.32	90,91,91,92	0
2	SO4	B	345	5/5	0.88	0.26	59,60,60,62	0
2	SO4	C	346	5/5	0.89	0.27	74,74,75,77	0
2	SO4	E	344	5/5	0.89	0.33	85,85,86,86	0
2	SO4	C	345	5/5	0.94	0.26	59,59,61,63	0
2	SO4	B	344	5/5	0.95	0.23	56,57,58,59	0
2	SO4	A	345	5/5	0.96	0.18	52,53,54,55	0
2	SO4	D	345	5/5	0.97	0.22	55,55,56,57	0
2	SO4	C	344	5/5	0.99	0.21	29,30,31,32	0
2	SO4	A	344	5/5	0.99	0.16	31,31,32,33	0

## 6.5 Other polymers [i](#)

There are no such residues in this entry.