



# wwPDB X-ray Structure Validation Summary Report ⓘ

Nov 20, 2023 – 11:58 AM JST

PDB ID : 7CJT  
Title : Crystal Structure of SETDB1 Tudor domain in complexed with (R,R)-59  
Authors : Guo, Y.P.; Liang, X.; Mao, X.; Wu, C.; Luyi, H.; Yang, S.  
Deposited on : 2020-07-13  
Resolution : 2.47 Å(reported)

This is a wwPDB X-ray Structure Validation Summary Report for a publicly released PDB entry.

We welcome your comments at [validation@mail.wwpdb.org](mailto:validation@mail.wwpdb.org)

A user guide is available at

<https://www.wwpdb.org/validation/2017/XrayValidationReportHelp>

with specific help available everywhere you see the ⓘ symbol.

The types of validation reports are described at

<https://www.wwpdb.org/validation/2017/FAQs#types>.

---

The following versions of software and data (see [references ⓘ](#)) were used in the production of this report:

MolProbity : 4.02b-467  
Mogul : 1.8.5 (274361), CSD as541be (2020)  
Xtriage (Phenix) : 1.13  
EDS : 2.36  
buster-report : 1.1.7 (2018)  
Percentile statistics : 20191225.v01 (using entries in the PDB archive December 25th 2019)  
Refmac : 5.8.0158  
CCP4 : 7.0.044 (Gargrove)  
Ideal geometry (proteins) : Engh & Huber (2001)  
Ideal geometry (DNA, RNA) : Parkinson et al. (1996)  
Validation Pipeline (wwPDB-VP) : 2.36

# 1 Overall quality at a glance

The following experimental techniques were used to determine the structure:

*X-RAY DIFFRACTION*

The reported resolution of this entry is 2.47 Å.

Percentile scores (ranging between 0-100) for global validation metrics of the entry are shown in the following graphic. The table shows the number of entries on which the scores are based.

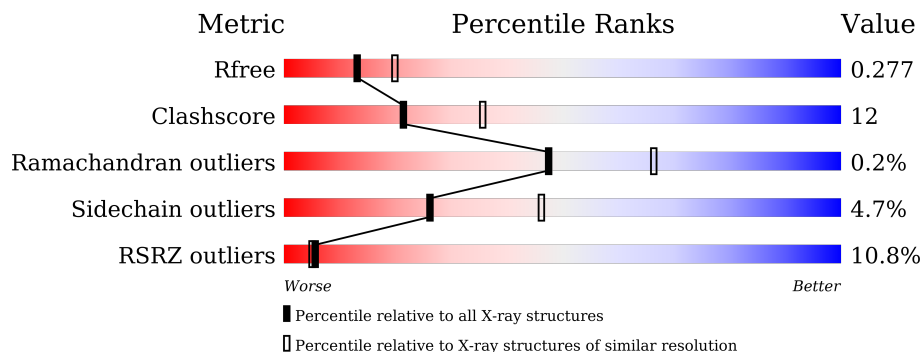

Metric	Whole archive (#Entries)	Similar resolution (#Entries, resolution range(Å))
$R_{free}$	130704	5857 (2.50-2.46)
Clashscore	141614	6594 (2.50-2.46)
Ramachandran outliers	138981	6469 (2.50-2.46)
Sidechain outliers	138945	6471 (2.50-2.46)
RSRZ outliers	127900	5738 (2.50-2.46)

The table below summarises the geometric issues observed across the polymeric chains and their fit to the electron density. The red, orange, yellow and green segments of the lower bar indicate the fraction of residues that contain outliers for  $\geq 3$ , 2, 1 and 0 types of geometric quality criteria respectively. A grey segment represents the fraction of residues that are not modelled. The numeric value for each fraction is indicated below the corresponding segment, with a dot representing fractions  $\leq 5\%$ . The upper red bar (where present) indicates the fraction of residues that have poor fit to the electron density. The numeric value is given above the bar.

Mol	Chain	Length	Quality of chain
1	A	240	
1	B	240	
1	C	240	
1	D	240	

## 2 Entry composition [i](#)

There are 3 unique types of molecules in this entry. The entry contains 13826 atoms, of which 6833 are hydrogens and 0 are deuteriums.

In the tables below, the ZeroOcc column contains the number of atoms modelled with zero occupancy, the AltConf column contains the number of residues with at least one atom in alternate conformation and the Trace column contains the number of residues modelled with at most 2 atoms.

- Molecule 1 is a protein called Histone-lysine N-methyltransferase SETDB1.

Mol	Chain	Residues	Atoms					ZeroOcc	AltConf	Trace	
			Total	C	H	N	O				S
1	D	212	3373	1108	1672	279	307	7	0	1	0
1	A	212	3373	1108	1672	279	307	7	0	1	0
1	B	215	3401	1117	1683	282	312	7	0	1	0
1	C	215	3400	1117	1682	282	312	7	0	1	0

There are 76 discrepancies between the modelled and reference sequences:

Chain	Residue	Modelled	Actual	Comment	Reference
D	171	GLY	-	expression tag	UNP Q15047
D	172	SER	-	expression tag	UNP Q15047
D	173	SER	-	expression tag	UNP Q15047
D	174	HIS	-	expression tag	UNP Q15047
D	175	HIS	-	expression tag	UNP Q15047
D	176	HIS	-	expression tag	UNP Q15047
D	177	HIS	-	expression tag	UNP Q15047
D	178	HIS	-	expression tag	UNP Q15047
D	179	HIS	-	expression tag	UNP Q15047
D	180	SER	-	expression tag	UNP Q15047
D	181	SER	-	expression tag	UNP Q15047
D	182	GLY	-	expression tag	UNP Q15047
D	183	GLU	-	expression tag	UNP Q15047
D	184	ASN	-	expression tag	UNP Q15047
D	185	LEU	-	expression tag	UNP Q15047
D	186	TYR	-	expression tag	UNP Q15047
D	187	PHE	-	expression tag	UNP Q15047
D	188	GLN	-	expression tag	UNP Q15047
D	189	GLY	-	expression tag	UNP Q15047
A	171	GLY	-	expression tag	UNP Q15047
A	172	SER	-	expression tag	UNP Q15047

*Continued on next page...*

*Continued from previous page...*

Chain	Residue	Modelled	Actual	Comment	Reference
A	173	SER	-	expression tag	UNP Q15047
A	174	HIS	-	expression tag	UNP Q15047
A	175	HIS	-	expression tag	UNP Q15047
A	176	HIS	-	expression tag	UNP Q15047
A	177	HIS	-	expression tag	UNP Q15047
A	178	HIS	-	expression tag	UNP Q15047
A	179	HIS	-	expression tag	UNP Q15047
A	180	SER	-	expression tag	UNP Q15047
A	181	SER	-	expression tag	UNP Q15047
A	182	GLY	-	expression tag	UNP Q15047
A	183	GLU	-	expression tag	UNP Q15047
A	184	ASN	-	expression tag	UNP Q15047
A	185	LEU	-	expression tag	UNP Q15047
A	186	TYR	-	expression tag	UNP Q15047
A	187	PHE	-	expression tag	UNP Q15047
A	188	GLN	-	expression tag	UNP Q15047
A	189	GLY	-	expression tag	UNP Q15047
B	171	GLY	-	expression tag	UNP Q15047
B	172	SER	-	expression tag	UNP Q15047
B	173	SER	-	expression tag	UNP Q15047
B	174	HIS	-	expression tag	UNP Q15047
B	175	HIS	-	expression tag	UNP Q15047
B	176	HIS	-	expression tag	UNP Q15047
B	177	HIS	-	expression tag	UNP Q15047
B	178	HIS	-	expression tag	UNP Q15047
B	179	HIS	-	expression tag	UNP Q15047
B	180	SER	-	expression tag	UNP Q15047
B	181	SER	-	expression tag	UNP Q15047
B	182	GLY	-	expression tag	UNP Q15047
B	183	GLU	-	expression tag	UNP Q15047
B	184	ASN	-	expression tag	UNP Q15047
B	185	LEU	-	expression tag	UNP Q15047
B	186	TYR	-	expression tag	UNP Q15047
B	187	PHE	-	expression tag	UNP Q15047
B	188	GLN	-	expression tag	UNP Q15047
B	189	GLY	-	expression tag	UNP Q15047
C	171	GLY	-	expression tag	UNP Q15047
C	172	SER	-	expression tag	UNP Q15047
C	173	SER	-	expression tag	UNP Q15047
C	174	HIS	-	expression tag	UNP Q15047
C	175	HIS	-	expression tag	UNP Q15047
C	176	HIS	-	expression tag	UNP Q15047

*Continued on next page...*

Continued from previous page...

Chain	Residue	Modelled	Actual	Comment	Reference
C	177	HIS	-	expression tag	UNP Q15047
C	178	HIS	-	expression tag	UNP Q15047
C	179	HIS	-	expression tag	UNP Q15047
C	180	SER	-	expression tag	UNP Q15047
C	181	SER	-	expression tag	UNP Q15047
C	182	GLY	-	expression tag	UNP Q15047
C	183	GLU	-	expression tag	UNP Q15047
C	184	ASN	-	expression tag	UNP Q15047
C	185	LEU	-	expression tag	UNP Q15047
C	186	TYR	-	expression tag	UNP Q15047
C	187	PHE	-	expression tag	UNP Q15047
C	188	GLN	-	expression tag	UNP Q15047
C	189	GLY	-	expression tag	UNP Q15047

- Molecule 2 is 2-[[[3 {R},5 {R}]-1-methyl-5-(4-phenylmethoxyphenyl)piperidin-3-yl]amino]-3-prop-2-enyl-5 {H}-pyrrolo[3,2-d]pyrimidin-4-one (three-letter code: G09) (formula: C<sub>28</sub>H<sub>31</sub>N<sub>5</sub>O<sub>2</sub>).

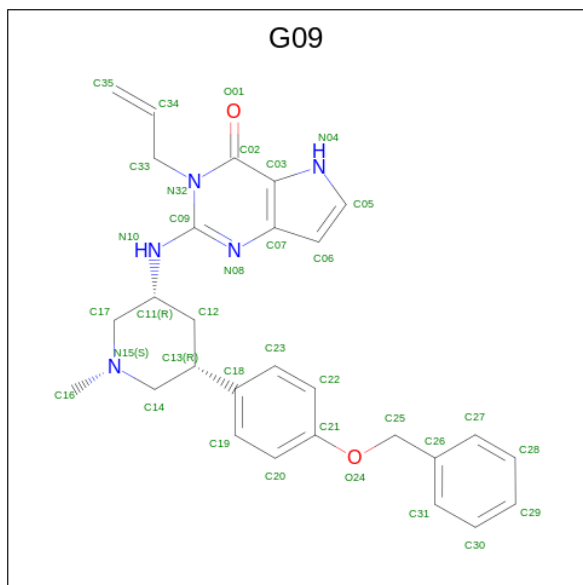

Mol	Chain	Residues	Atoms				ZeroOcc	AltConf	
			Total	C	H	N			O
2	D	1	Total	C	H	N	O	0	0
			66	28	31	5	2		
2	A	1	Total	C	H	N	O	0	0
			66	28	31	5	2		
2	B	1	Total	C	H	N	O	0	0
			66	28	31	5	2		
2	C	1	Total	C	H	N	O	0	0
			66	28	31	5	2		

- Molecule 3 is water.

<b>Mol</b>	<b>Chain</b>	<b>Residues</b>	<b>Atoms</b>		<b>ZeroOcc</b>	<b>AltConf</b>
3	D	11	Total 11	O 11	0	0
3	A	3	Total 3	O 3	0	0
3	C	1	Total 1	O 1	0	0

### 3 Residue-property plots [i](#)

These plots are drawn for all protein, RNA, DNA and oligosaccharide chains in the entry. The first graphic for a chain summarises the proportions of the various outlier classes displayed in the second graphic. The second graphic shows the sequence view annotated by issues in geometry and electron density. Residues are color-coded according to the number of geometric quality criteria for which they contain at least one outlier: green = 0, yellow = 1, orange = 2 and red = 3 or more. A red dot above a residue indicates a poor fit to the electron density ( $RSRZ > 2$ ). Stretches of 2 or more consecutive residues without any outlier are shown as a green connector. Residues present in the sample, but not in the model, are shown in grey.

- Molecule 1: Histone-lysine N-methyltransferase SETDB1

Chain D: 

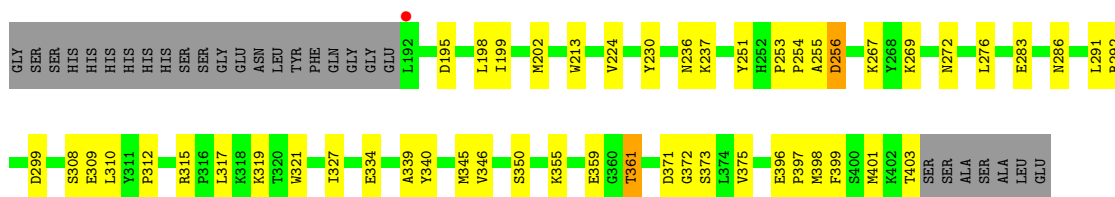

- Molecule 1: Histone-lysine N-methyltransferase SETDB1

Chain A: 

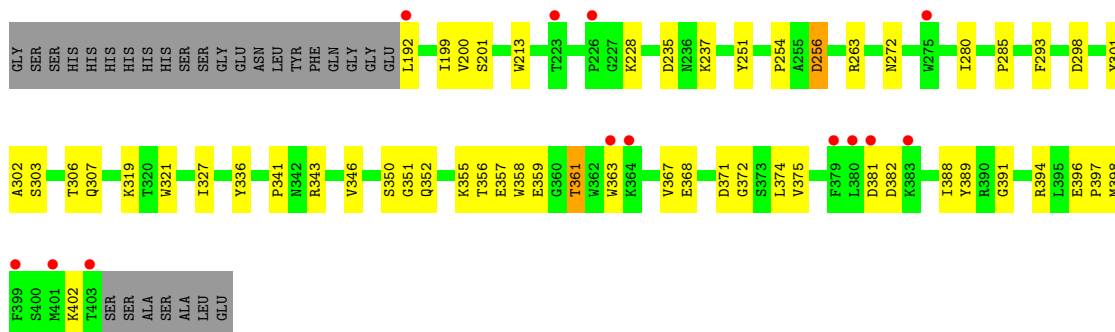

- Molecule 1: Histone-lysine N-methyltransferase SETDB1

Chain B: 

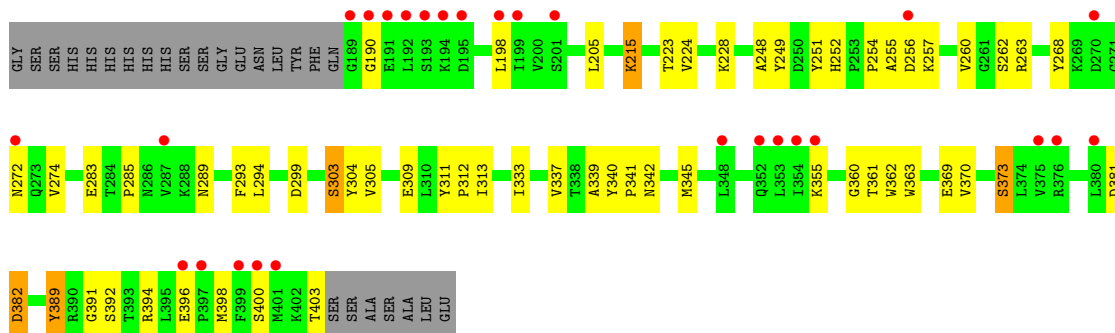

- Molecule 1: Histone-lysine N-methyltransferase SETDB1

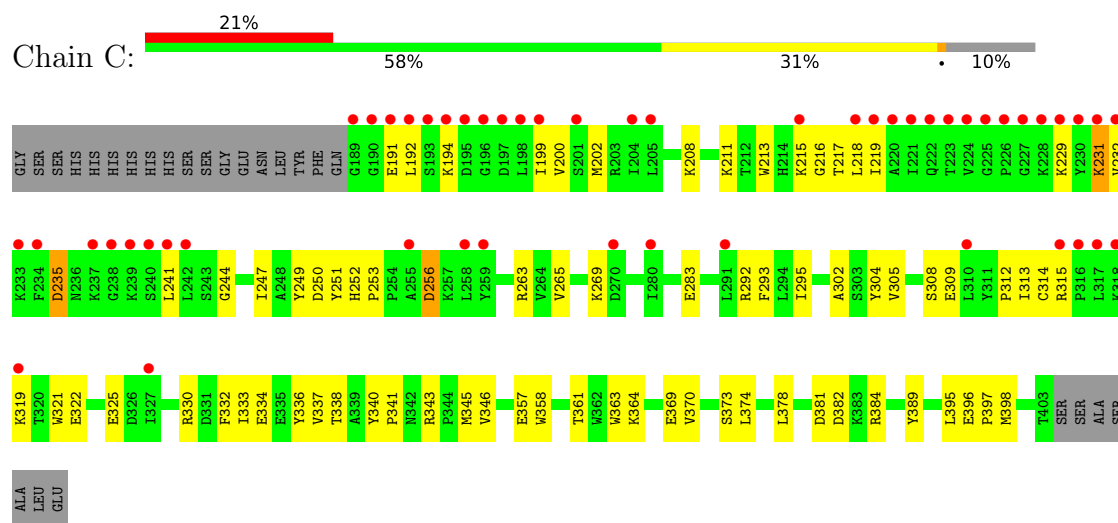



## 4 Data and refinement statistics

Property	Value	Source
Space group	P 1 21 1	Depositor
Cell constants a, b, c, $\alpha$ , $\beta$ , $\gamma$	83.33Å 69.21Å 110.12Å 90.00° 98.93° 90.00°	Depositor
Resolution (Å)	41.16 – 2.47 41.16 – 2.47	Depositor EDS
% Data completeness (in resolution range)	67.3 (41.16-2.47) 67.3 (41.16-2.47)	Depositor EDS
$R_{merge}$	(Not available)	Depositor
$R_{sym}$	(Not available)	Depositor
$\langle I/\sigma(I) \rangle$ <sup>1</sup>	1.31 (at 2.48Å)	Xtrriage
Refinement program	PHENIX 1.12_2829	Depositor
R, $R_{free}$	0.204 , 0.276 0.204 , 0.277	Depositor DCC
$R_{free}$ test set	1473 reflections (4.92%)	wwPDB-VP
Wilson B-factor (Å <sup>2</sup> )	60.4	Xtrriage
Anisotropy	0.048	Xtrriage
Bulk solvent $k_{sol}$ (e/Å <sup>3</sup> ), $B_{sol}$ (Å <sup>2</sup> )	0.39 , 59.4	EDS
L-test for twinning <sup>2</sup>	$\langle  L  \rangle = 0.49$ , $\langle L^2 \rangle = 0.32$	Xtrriage
Estimated twinning fraction	No twinning to report.	Xtrriage
$F_o, F_c$ correlation	0.93	EDS
Total number of atoms	13826	wwPDB-VP
Average B, all atoms (Å <sup>2</sup> )	73.0	wwPDB-VP

Xtrriage's analysis on translational NCS is as follows: *The largest off-origin peak in the Patterson function is 4.87% of the height of the origin peak. No significant pseudotranslation is detected.*

<sup>1</sup>Intensities estimated from amplitudes.

<sup>2</sup>Theoretical values of  $\langle |L| \rangle$ ,  $\langle L^2 \rangle$  for acentric reflections are 0.5, 0.333 respectively for untwinned datasets, and 0.375, 0.2 for perfectly twinned datasets.

## 5 Model quality

### 5.1 Standard geometry

Bond lengths and bond angles in the following residue types are not validated in this section: G09

The Z score for a bond length (or angle) is the number of standard deviations the observed value is removed from the expected value. A bond length (or angle) with  $|Z| > 5$  is considered an outlier worth inspection. RMSZ is the root-mean-square of all Z scores of the bond lengths (or angles).

Mol	Chain	Bond lengths		Bond angles	
		RMSZ	# $ Z  > 5$	RMSZ	# $ Z  > 5$
1	A	0.81	0/1748	0.88	1/2369 (0.0%)
1	B	0.64	0/1765	0.76	0/2391
1	C	0.67	0/1765	0.79	1/2391 (0.0%)
1	D	0.90	1/1748 (0.1%)	0.98	1/2369 (0.0%)
All	All	0.76	1/7026 (0.0%)	0.86	3/9520 (0.0%)

Chiral center outliers are detected by calculating the chiral volume of a chiral center and verifying if the center is modelled as a planar moiety or with the opposite hand. A planarity outlier is detected by checking planarity of atoms in a peptide group, atoms in a mainchain group or atoms of a sidechain that are expected to be planar.

Mol	Chain	#Chirality outliers	#Planarity outliers
1	C	0	1

All (1) bond length outliers are listed below:

Mol	Chain	Res	Type	Atoms	Z	Observed(Å)	Ideal(Å)
1	D	375	VAL	CB-CG1	-5.27	1.41	1.52

All (3) bond angle outliers are listed below:

Mol	Chain	Res	Type	Atoms	Z	Observed(°)	Ideal(°)
1	D	401	MET	CA-CB-CG	5.48	122.62	113.30
1	A	192	LEU	CA-CB-CG	5.29	127.46	115.30
1	C	192	LEU	CA-CB-CG	5.03	126.86	115.30

There are no chirality outliers.

All (1) planarity outliers are listed below:

Mol	Chain	Res	Type	Group
1	C	256	ASP	Peptide

## 5.2 Too-close contacts [i](#)

In the following table, the Non-H and H(model) columns list the number of non-hydrogen atoms and hydrogen atoms in the chain respectively. The H(added) column lists the number of hydrogen atoms added and optimized by MolProbity. The Clashes column lists the number of clashes within the asymmetric unit, whereas Symm-Clashes lists symmetry-related clashes.

Mol	Chain	Non-H	H(model)	H(added)	Clashes	Symm-Clashes
1	A	1701	1672	1671	38	0
1	B	1718	1683	1683	37	0
1	C	1718	1682	1683	55	0
1	D	1701	1672	1671	38	0
2	A	35	31	0	0	0
2	B	35	31	0	1	0
2	C	35	31	0	3	0
2	D	35	31	0	1	0
3	A	3	0	0	0	0
3	C	1	0	0	1	0
3	D	11	0	0	3	0
All	All	6993	6833	6708	164	0

The all-atom clashscore is defined as the number of clashes found per 1000 atoms (including hydrogen atoms). The all-atom clashscore for this structure is 12.

The worst 5 of 164 close contacts within the same asymmetric unit are listed below, sorted by their clash magnitude.

Atom-1	Atom-2	Interatomic distance (Å)	Clash overlap (Å)
1:C:247:ILE:HD12	1:C:314:CYS:SG	2.17	0.85
1:C:235:ASP:O	3:C:601:HOH:O	1.94	0.84
1:C:211:LYS:NZ	1:C:325:GLU:OE1	2.10	0.84
1:C:283:GLU:OE2	1:C:373:SER:OG	2.01	0.78
1:D:236:ASN:O	3:D:601:HOH:O	2.02	0.75

There are no symmetry-related clashes.

## 5.3 Torsion angles [i](#)

### 5.3.1 Protein backbone [i](#)

In the following table, the Percentiles column shows the percent Ramachandran outliers of the chain as a percentile score with respect to all X-ray entries followed by that with respect to entries of similar resolution.

The Analysed column shows the number of residues for which the backbone conformation was analysed, and the total number of residues.

Mol	Chain	Analysed	Favoured	Allowed	Outliers	Percentiles	
1	A	211/240 (88%)	188 (89%)	23 (11%)	0	100	100
1	B	214/240 (89%)	189 (88%)	25 (12%)	0	100	100
1	C	214/240 (89%)	185 (86%)	28 (13%)	1 (0%)	29	46
1	D	211/240 (88%)	193 (92%)	17 (8%)	1 (0%)	29	46
All	All	850/960 (88%)	755 (89%)	93 (11%)	2 (0%)	47	66

All (2) Ramachandran outliers are listed below:

Mol	Chain	Res	Type
1	D	237	LYS
1	C	381	ASP

### 5.3.2 Protein sidechains [i](#)

In the following table, the Percentiles column shows the percent sidechain outliers of the chain as a percentile score with respect to all X-ray entries followed by that with respect to entries of similar resolution.

The Analysed column shows the number of residues for which the sidechain conformation was analysed, and the total number of residues.

Mol	Chain	Analysed	Rotameric	Outliers	Percentiles	
1	A	176/211 (83%)	167 (95%)	9 (5%)	24	42
1	B	177/211 (84%)	166 (94%)	11 (6%)	18	33
1	C	177/211 (84%)	169 (96%)	8 (4%)	27	48
1	D	176/211 (83%)	171 (97%)	5 (3%)	43	67
All	All	706/844 (84%)	673 (95%)	33 (5%)	26	46

5 of 33 residues with a non-rotameric sidechain are listed below:

Mol	Chain	Res	Type
1	C	235	ASP
1	C	256	ASP
1	C	382	ASP
1	A	381	ASP
1	A	361	THR

Sometimes sidechains can be flipped to improve hydrogen bonding and reduce clashes. All (2) such sidechains are listed below:

Mol	Chain	Res	Type
1	A	252	HIS
1	B	222	GLN

### 5.3.3 RNA [i](#)

There are no RNA molecules in this entry.

## 5.4 Non-standard residues in protein, DNA, RNA chains [i](#)

There are no non-standard protein/DNA/RNA residues in this entry.

## 5.5 Carbohydrates [i](#)

There are no monosaccharides in this entry.

## 5.6 Ligand geometry [i](#)

4 ligands are modelled in this entry.

In the following table, the Counts columns list the number of bonds (or angles) for which Mogul statistics could be retrieved, the number of bonds (or angles) that are observed in the model and the number of bonds (or angles) that are defined in the Chemical Component Dictionary. The Link column lists molecule types, if any, to which the group is linked. The Z score for a bond length (or angle) is the number of standard deviations the observed value is removed from the expected value. A bond length (or angle) with  $|Z| > 2$  is considered an outlier worth inspection. RMSZ is the root-mean-square of all Z scores of the bond lengths (or angles).

Mol	Type	Chain	Res	Link	Bond lengths			Bond angles		
					Counts	RMSZ	# Z  > 2	Counts	RMSZ	# Z  > 2
2	G09	B	501	-	37,39,39	3.70	12 (32%)	43,54,54	2.01	11 (25%)
2	G09	C	501	-	37,39,39	3.61	13 (35%)	43,54,54	2.76	11 (25%)

Mol	Type	Chain	Res	Link	Bond lengths			Bond angles		
					Counts	RMSZ	# Z  > 2	Counts	RMSZ	# Z  > 2
2	G09	A	501	-	37,39,39	3.47	13 (35%)	43,54,54	2.12	10 (23%)
2	G09	D	501	-	37,39,39	3.40	9 (24%)	43,54,54	2.02	8 (18%)

In the following table, the Chirals column lists the number of chiral outliers, the number of chiral centers analysed, the number of these observed in the model and the number defined in the Chemical Component Dictionary. Similar counts are reported in the Torsion and Rings columns. '-' means no outliers of that kind were identified.

Mol	Type	Chain	Res	Link	Chirals	Torsions	Rings
2	G09	B	501	-	-	2/16/28/28	0/5/5/5
2	G09	C	501	-	-	3/16/28/28	0/5/5/5
2	G09	A	501	-	-	3/16/28/28	0/5/5/5
2	G09	D	501	-	-	3/16/28/28	0/5/5/5

The worst 5 of 47 bond length outliers are listed below:

Mol	Chain	Res	Type	Atoms	Z	Observed(Å)	Ideal(Å)
2	B	501	G09	C09-N08	12.97	1.46	1.30
2	C	501	G09	C09-N08	12.46	1.45	1.30
2	A	501	G09	C09-N08	11.00	1.44	1.30
2	D	501	G09	C09-N08	10.78	1.43	1.30
2	B	501	G09	C16-N15	-10.75	1.21	1.46

The worst 5 of 40 bond angle outliers are listed below:

Mol	Chain	Res	Type	Atoms	Z	Observed(°)	Ideal(°)
2	C	501	G09	C13-C14-N15	8.80	115.99	110.56
2	C	501	G09	N10-C09-N32	7.60	124.35	117.20
2	A	501	G09	N32-C09-N08	-6.60	120.68	124.17
2	A	501	G09	N10-C09-N32	6.09	122.93	117.20
2	C	501	G09	C09-N32-C02	-6.00	117.20	121.08

There are no chirality outliers.

5 of 11 torsion outliers are listed below:

Mol	Chain	Res	Type	Atoms
2	A	501	G09	C34-C33-N32-C02
2	B	501	G09	C34-C33-N32-C02
2	C	501	G09	C34-C33-N32-C02
2	C	501	G09	C34-C33-N32-C09

*Continued on next page...*

*Continued from previous page...*

Mol	Chain	Res	Type	Atoms
2	D	501	G09	C20-C21-O24-C25

There are no ring outliers.

3 monomers are involved in 5 short contacts:

Mol	Chain	Res	Type	Clashes	Symm-Clashes
2	B	501	G09	1	0
2	C	501	G09	3	0
2	D	501	G09	1	0

The following is a two-dimensional graphical depiction of Mogul quality analysis of bond lengths, bond angles, torsion angles, and ring geometry for all instances of the Ligand of Interest. In addition, ligands with molecular weight > 250 and outliers as shown on the validation Tables will also be included. For torsion angles, if less than 5% of the Mogul distribution of torsion angles is within 10 degrees of the torsion angle in question, then that torsion angle is considered an outlier. Any bond that is central to one or more torsion angles identified as an outlier by Mogul will be highlighted in the graph. For rings, the root-mean-square deviation (RMSD) between the ring in question and similar rings identified by Mogul is calculated over all ring torsion angles. If the average RMSD is greater than 60 degrees and the minimal RMSD between the ring in question and any Mogul-identified rings is also greater than 60 degrees, then that ring is considered an outlier. The outliers are highlighted in purple. The color gray indicates Mogul did not find sufficient equivalents in the CSD to analyse the geometry.

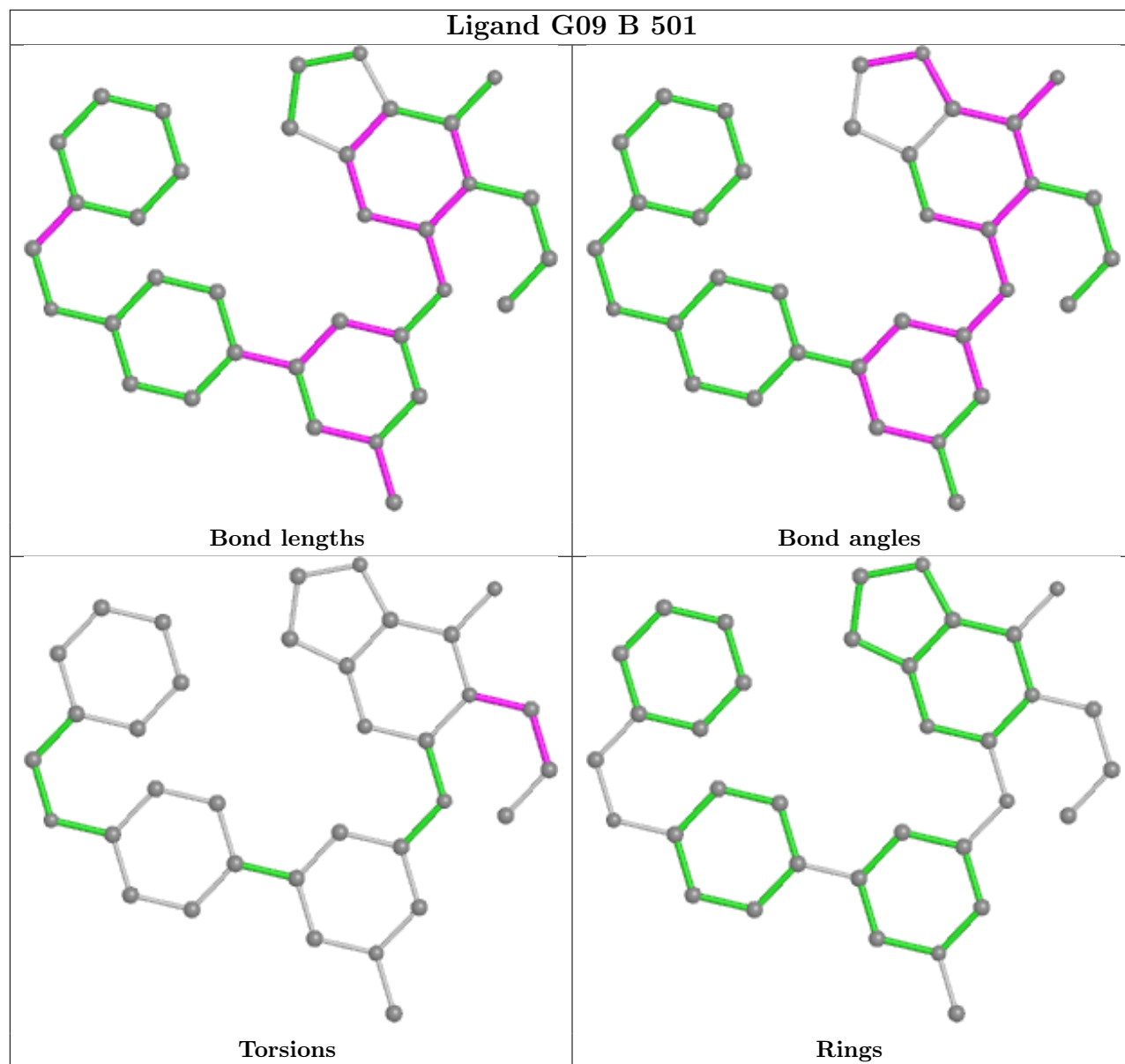



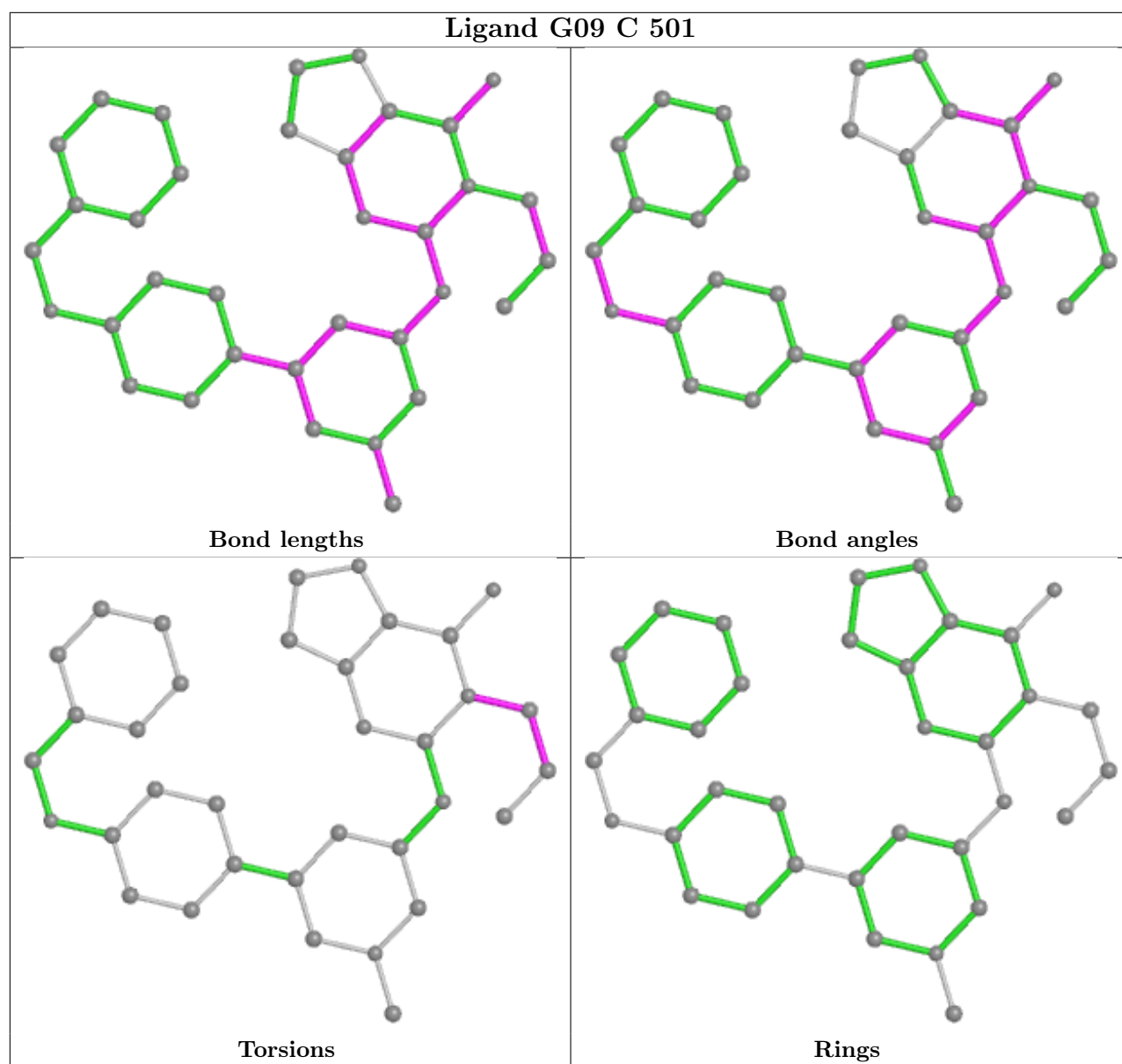

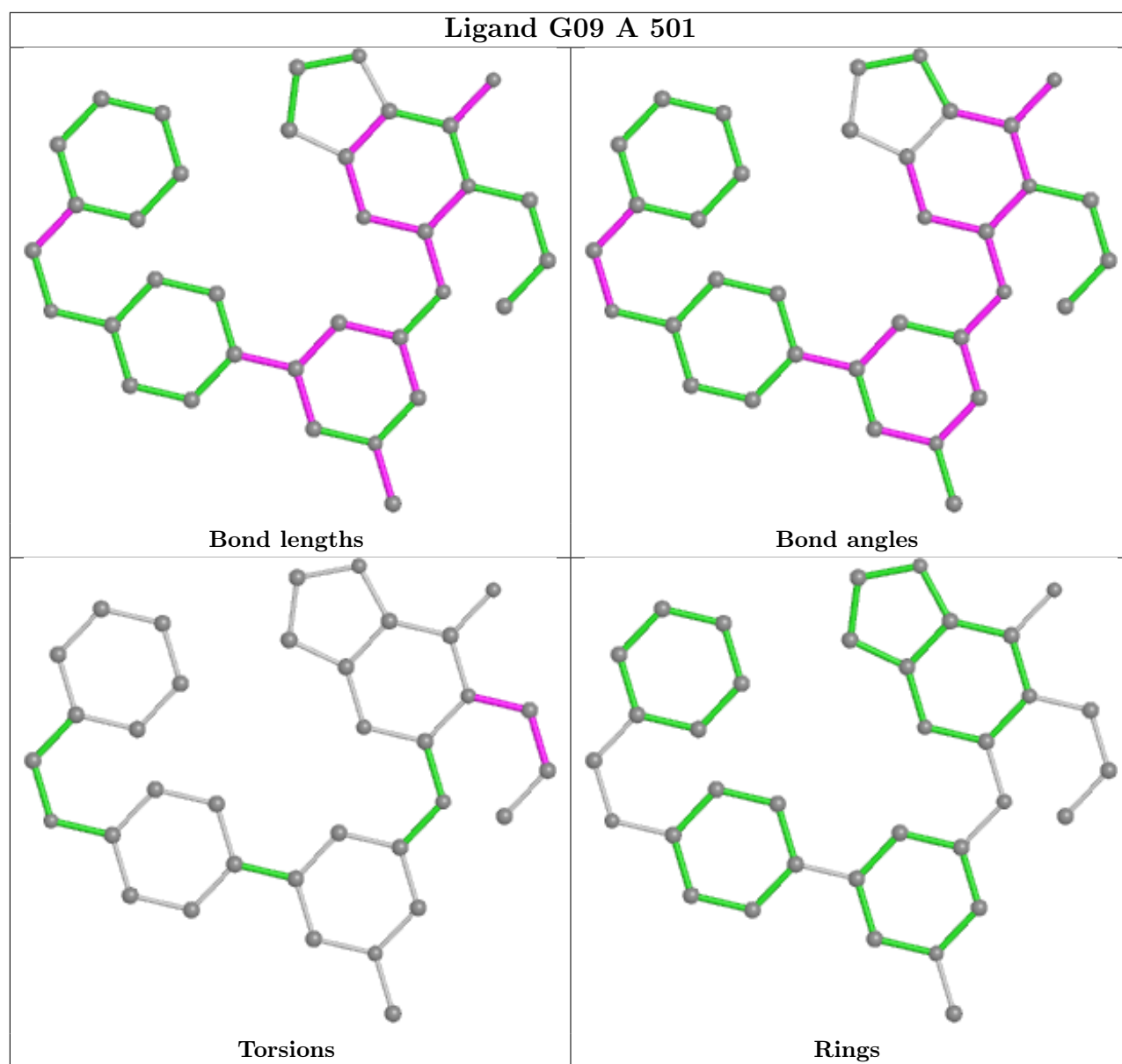

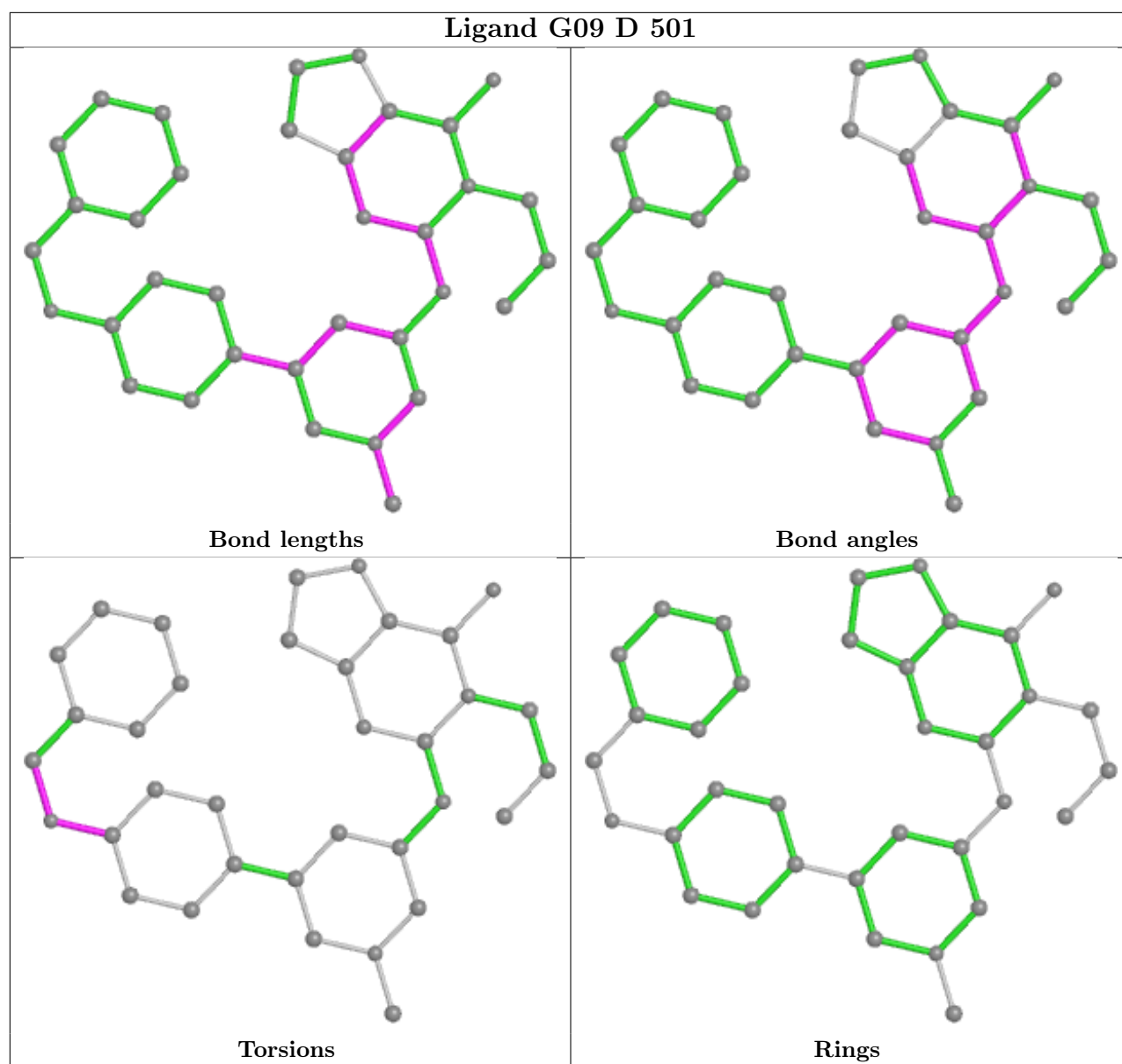

## 5.7 Other polymers [i](#)

There are no such residues in this entry.

## 5.8 Polymer linkage issues [i](#)

There are no chain breaks in this entry.

## 6 Fit of model and data [i](#)

### 6.1 Protein, DNA and RNA chains [i](#)

In the following table, the column labelled ‘#RSRZ > 2’ contains the number (and percentage) of RSRZ outliers, followed by percent RSRZ outliers for the chain as percentile scores relative to all X-ray entries and entries of similar resolution. The OWAB column contains the minimum, median, 95<sup>th</sup> percentile and maximum values of the occupancy-weighted average B-factor per residue. The column labelled ‘Q < 0.9’ lists the number of (and percentage) of residues with an average occupancy less than 0.9.

Mol	Chain	Analysed	<RSRZ>	#RSRZ>2	OWAB(Å <sup>2</sup> )	Q<0.9
1	A	212/240 (88%)	0.48	13 (6%) 21 21	32, 56, 89, 121	0
1	B	215/240 (89%)	0.65	27 (12%) 3 3	50, 72, 103, 123	1 (0%)
1	C	215/240 (89%)	1.41	51 (23%) 0 0	44, 83, 144, 162	0
1	D	212/240 (88%)	0.01	1 (0%) 91 91	24, 41, 64, 112	0
All	All	854/960 (88%)	0.64	92 (10%) 5 5	24, 64, 116, 162	1 (0%)

The worst 5 of 92 RSRZ outliers are listed below:

Mol	Chain	Res	Type	RSRZ
1	C	226	PRO	10.0
1	C	220	ALA	8.7
1	C	192	LEU	8.6
1	B	192	LEU	8.6
1	C	204	ILE	7.9

### 6.2 Non-standard residues in protein, DNA, RNA chains [i](#)

There are no non-standard protein/DNA/RNA residues in this entry.

### 6.3 Carbohydrates [i](#)

There are no monosaccharides in this entry.

### 6.4 Ligands [i](#)

In the following table, the Atoms column lists the number of modelled atoms in the group and the number defined in the chemical component dictionary. The B-factors column lists the minimum, median, 95<sup>th</sup> percentile and maximum values of B factors of atoms in the group. The column labelled ‘Q < 0.9’ lists the number of atoms with occupancy less than 0.9.

Mol	Type	Chain	Res	Atoms	RSCC	RSR	B-factors( $\text{\AA}^2$ )	Q<0.9
2	G09	B	501	35/35	0.93	0.22	41,66,103,123	0
2	G09	A	501	35/35	0.95	0.23	37,63,90,118	0
2	G09	D	501	35/35	0.95	0.23	31,51,97,105	0
2	G09	C	501	35/35	0.95	0.19	46,79,108,118	0

The following is a graphical depiction of the model fit to experimental electron density of all instances of the Ligand of Interest. In addition, ligands with molecular weight > 250 and outliers as shown on the geometry validation Tables will also be included. Each fit is shown from different orientation to approximate a three-dimensional view.

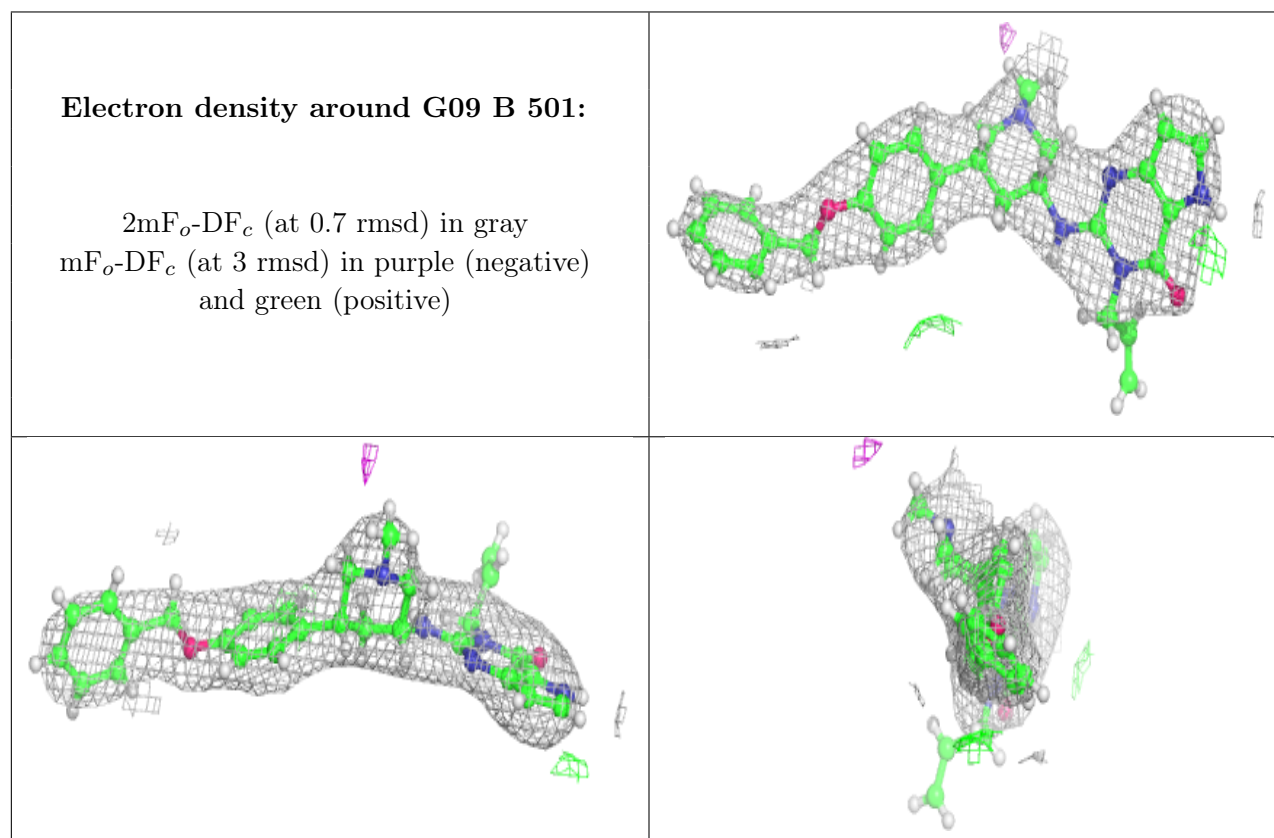

**Electron density around G09 A 501:**

$2mF_o-DF_c$  (at 0.7 rmsd) in gray  
 $mF_o-DF_c$  (at 3 rmsd) in purple (negative)  
and green (positive)

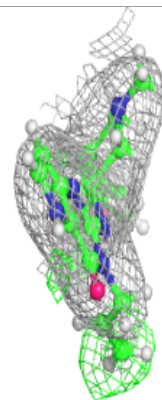
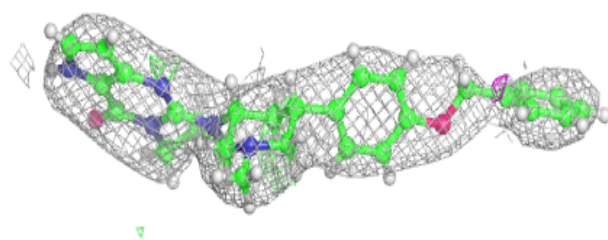
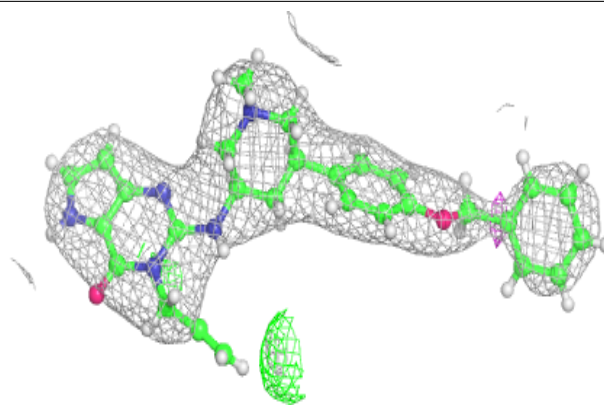
**Electron density around G09 D 501:**

$2mF_o-DF_c$  (at 0.7 rmsd) in gray  
 $mF_o-DF_c$  (at 3 rmsd) in purple (negative)  
and green (positive)

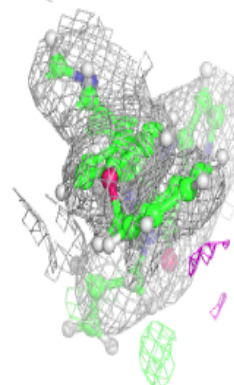
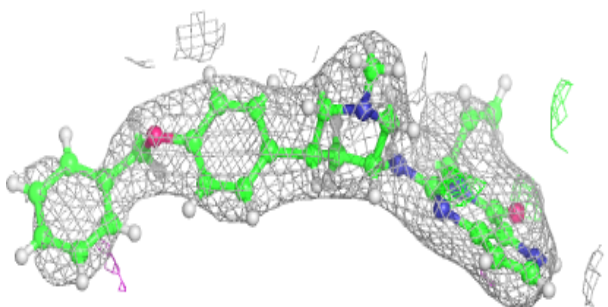
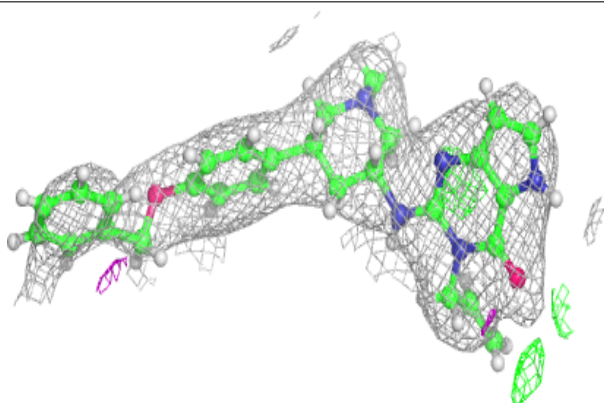

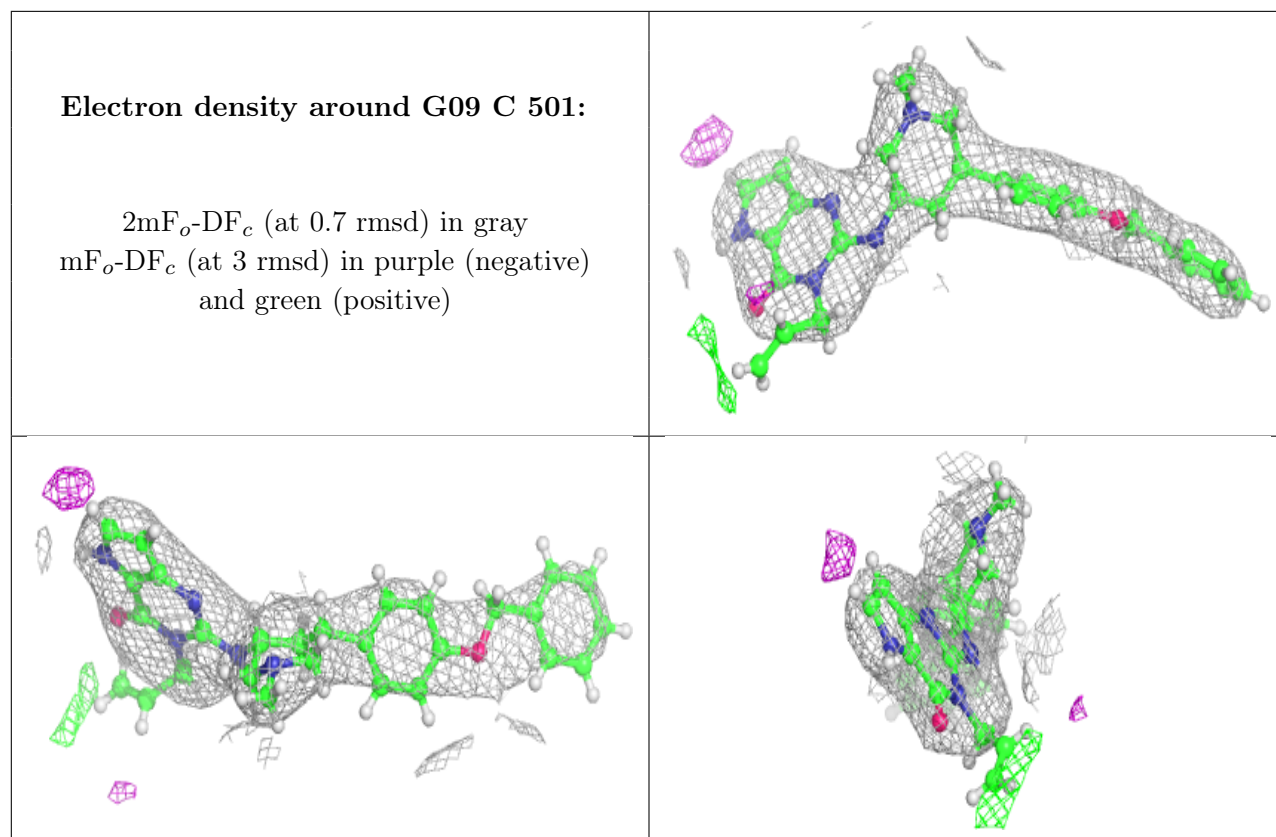

## 6.5 Other polymers [i](#)

There are no such residues in this entry.