



Full wwPDB X-ray Structure Validation Report ⓘ

Sep 18, 2023 – 08:20 PM EDT

PDB ID : 5D7L
Title : Structure of human MR1-5-OP-RU in complex with human MAV36 TCR
Authors : Keller, A.N.; Rossjohn, J.
Deposited on : 2015-08-14
Resolution : 3.40 Å(reported)

This is a Full wwPDB X-ray Structure Validation Report for a publicly released PDB entry.

We welcome your comments at validation@mail.wwpdb.org

A user guide is available at

<https://www.wwpdb.org/validation/2017/XrayValidationReportHelp>

with specific help available everywhere you see the ⓘ symbol.

The types of validation reports are described at

<http://www.wwpdb.org/validation/2017/FAQs#types>.

The following versions of software and data (see [references ⓘ](#)) were used in the production of this report:

MolProbity : 4.02b-467
Mogul : 1.8.5 (274361), CSD as541be (2020)
Xtriage (Phenix) : 1.13
EDS : 2.35.1
buster-report : 1.1.7 (2018)
Percentile statistics : 20191225.v01 (using entries in the PDB archive December 25th 2019)
Refmac : 5.8.0158
CCP4 : 7.0.044 (Gargrove)
Ideal geometry (proteins) : Engh & Huber (2001)
Ideal geometry (DNA, RNA) : Parkinson et al. (1996)
Validation Pipeline (wwPDB-VP) : 2.35.1

1 Overall quality at a glance

The following experimental techniques were used to determine the structure:

X-RAY DIFFRACTION

The reported resolution of this entry is 3.40 Å.

Percentile scores (ranging between 0-100) for global validation metrics of the entry are shown in the following graphic. The table shows the number of entries on which the scores are based.

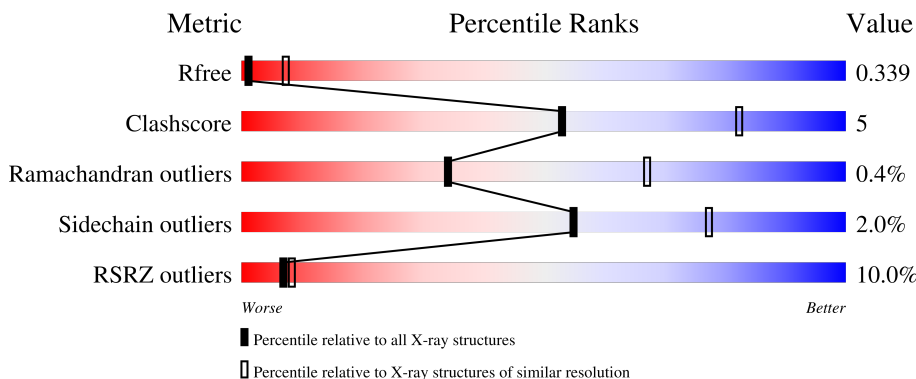



Metric	Whole archive (#Entries)	Similar resolution (#Entries, resolution range(Å))
R_{free}	130704	1026 (3.48-3.32)
Clashscore	141614	1055 (3.48-3.32)
Ramachandran outliers	138981	1038 (3.48-3.32)
Sidechain outliers	138945	1038 (3.48-3.32)
RSRZ outliers	127900	2173 (3.50-3.30)

The table below summarises the geometric issues observed across the polymeric chains and their fit to the electron density. The red, orange, yellow and green segments of the lower bar indicate the fraction of residues that contain outliers for ≥ 3 , 2, 1 and 0 types of geometric quality criteria respectively. A grey segment represents the fraction of residues that are not modelled. The numeric value for each fraction is indicated below the corresponding segment, with a dot representing fractions $\leq 5\%$. The upper red bar (where present) indicates the fraction of residues that have poor fit to the electron density. The numeric value is given above the bar.

Mol	Chain	Length	Quality of chain
1	A	271	
1	C	271	
2	B	100	
2	F	100	
3	D	203	

Continued on next page...

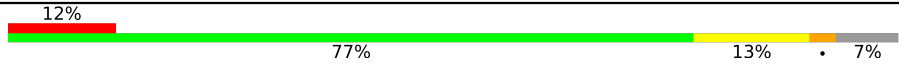
Continued from previous page...

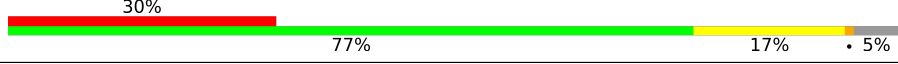
Mol	Chain	Length	Quality of chain
3	G	203	
4	E	243	
4	H	243	

2 Entry composition [i](#)

There are 5 unique types of molecules in this entry. The entry contains 12574 atoms, of which 0 are hydrogens and 0 are deuteriums.

In the tables below, the ZeroOcc column contains the number of atoms modelled with zero occupancy, the AltConf column contains the number of residues with at least one atom in alternate conformation and the Trace column contains the number of residues modelled with at most 2 atoms.

- Molecule 1 is a protein called Major histocompatibility complex class I-related gene protein.

Mol	Chain	Residues	Atoms					ZeroOcc	AltConf	Trace
			Total	C	N	O	S			
1	A	262	Total	C	N	O	S	0	0	0
			2164	1384	373	397	10			
1	C	242	Total	C	N	O	S	0	0	0
			2017	1293	345	369	10			

There are 4 discrepancies between the modelled and reference sequences:

Chain	Residue	Modelled	Actual	Comment	Reference
A	0	MET	-	initiating methionine	UNP Q95460
A	261	SER	CYS	conflict	UNP Q95460
C	0	MET	-	initiating methionine	UNP Q95460
C	261	SER	CYS	conflict	UNP Q95460

- Molecule 2 is a protein called Beta-2-microglobulin.

Mol	Chain	Residues	Atoms					ZeroOcc	AltConf	Trace
			Total	C	N	O	S			
2	B	98	Total	C	N	O	S	0	0	0
			814	521	136	154	3			
2	F	99	Total	C	N	O	S	0	0	0
			828	528	140	157	3			

There are 2 discrepancies between the modelled and reference sequences:

Chain	Residue	Modelled	Actual	Comment	Reference
B	0	MET	-	initiating methionine	UNP P61769
F	0	MET	-	initiating methionine	UNP P61769

- Molecule 3 is a protein called MAV36 TCR Alpha Chain.

Mol	Chain	Residues	Atoms					ZeroOcc	AltConf	Trace
			Total	C	N	O	S			
3	D	187	Total	C	N	O	S	0	0	0
			1456	920	235	293	8			

Continued on next page...

Continued from previous page...

Mol	Chain	Residues	Atoms					ZeroOcc	AltConf	Trace
			Total	C	N	O	S			
3	G	189	1472	934	236	294	8	0	0	0

- Molecule 4 is a protein called MAV36 TCR Beta Chain.

Mol	Chain	Residues	Atoms					ZeroOcc	AltConf	Trace
			Total	C	N	O	S			
4	E	241	1948	1234	334	371	9	0	0	0
4	H	232	1831	1164	301	357	9	0	0	0

- Molecule 5 is 1-deoxy-1-({2,6-dioxo-5-[(E)-propylideneamino]-1,2,3,6-tetrahydropyrimidin-4-yl}amino)-D-ribitol (three-letter code: 2LJ) (formula: C₁₂H₂₀N₄O₆).

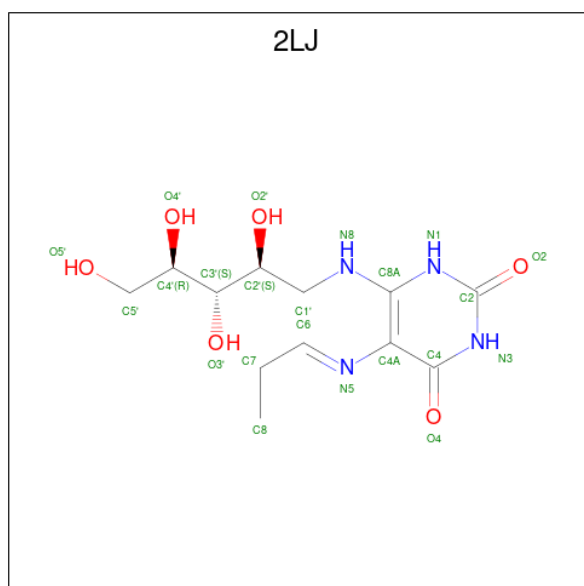

Mol	Chain	Residues	Atoms				ZeroOcc	AltConf
			Total	C	N	O		
5	A	1	22	12	4	6	0	0
5	C	1	22	12	4	6	0	0

3 Residue-property plots

These plots are drawn for all protein, RNA, DNA and oligosaccharide chains in the entry. The first graphic for a chain summarises the proportions of the various outlier classes displayed in the second graphic. The second graphic shows the sequence view annotated by issues in geometry and electron density. Residues are color-coded according to the number of geometric quality criteria for which they contain at least one outlier: green = 0, yellow = 1, orange = 2 and red = 3 or more. A red dot above a residue indicates a poor fit to the electron density ($RSRZ > 2$). Stretches of 2 or more consecutive residues without any outlier are shown as a green connector. Residues present in the sample, but not in the model, are shown in grey.

- Molecule 1: Major histocompatibility complex class I-related gene protein

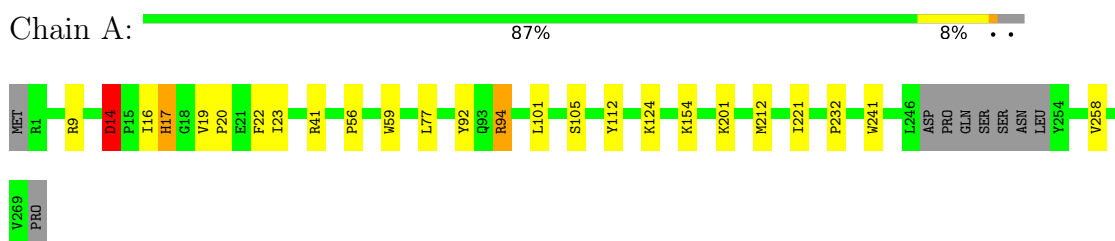

- Molecule 1: Major histocompatibility complex class I-related gene protein

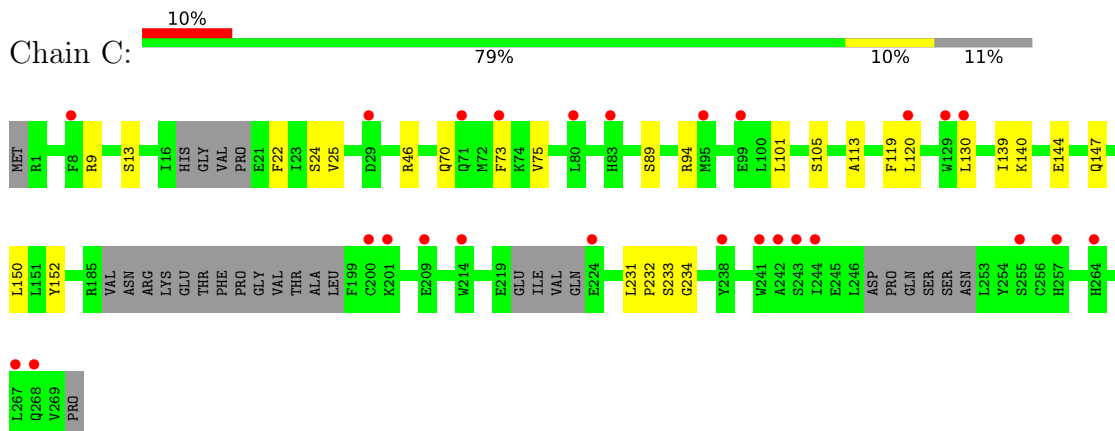

- Molecule 2: Beta-2-microglobulin

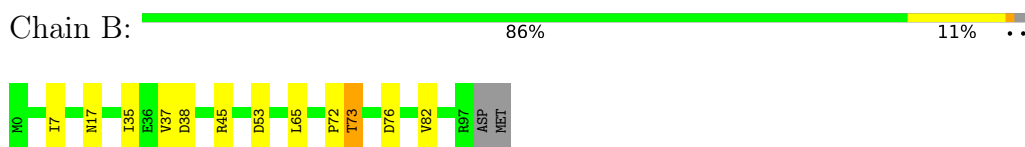

- Molecule 2: Beta-2-microglobulin

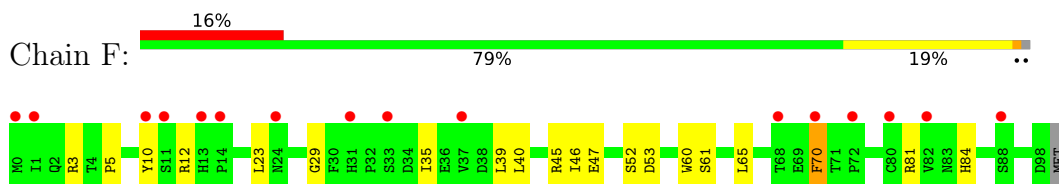

- Molecule 3: MAV36 TCR Alpha Chain

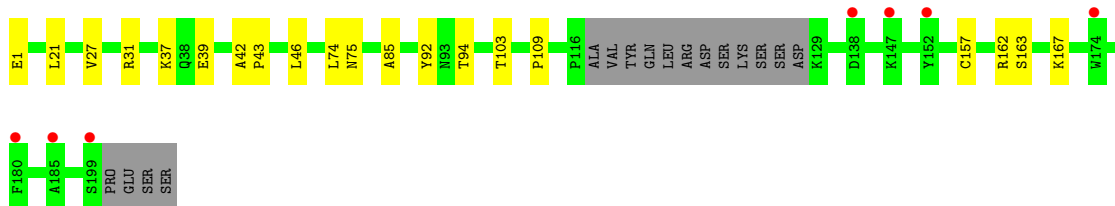
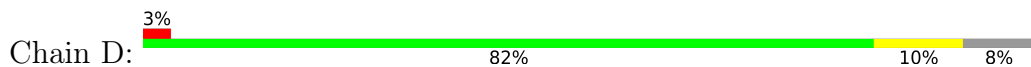

- Molecule 3: MAV36 TCR Alpha Chain

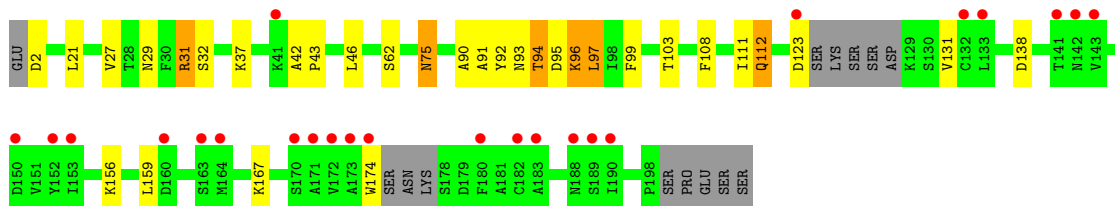
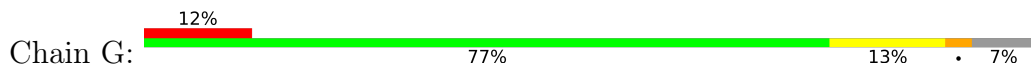

- Molecule 4: MAV36 TCR Beta Chain

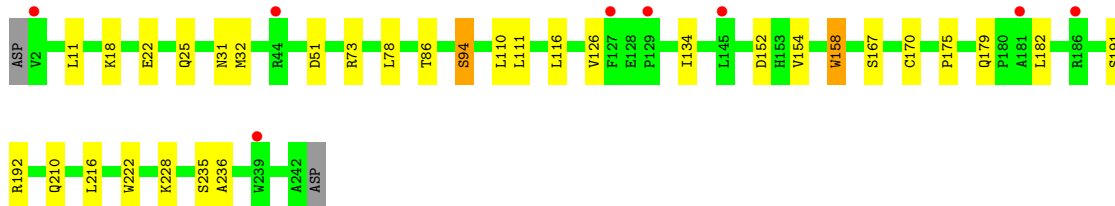
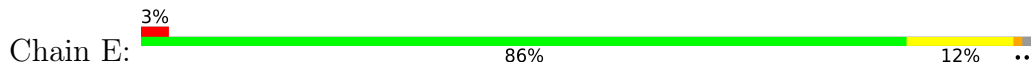

- Molecule 4: MAV36 TCR Beta Chain

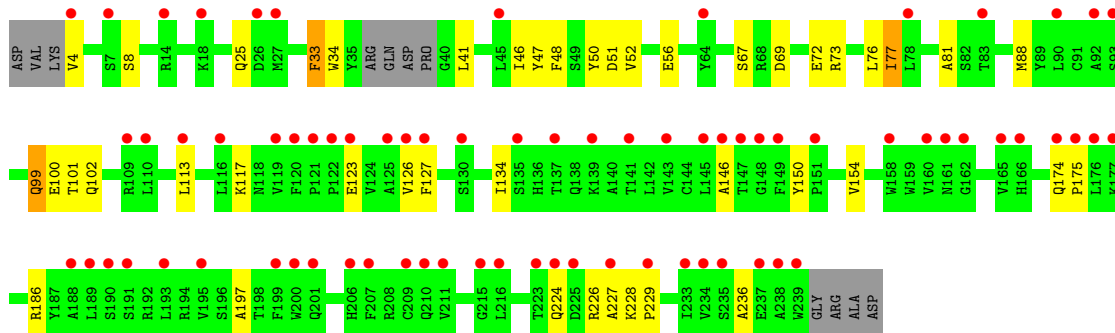
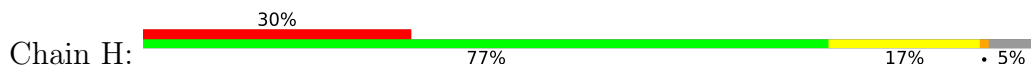

4 Data and refinement statistics

Property	Value	Source
Space group	I 1 2 1	Depositor
Cell constants a, b, c, α , β , γ	89.28Å 222.43Å 98.98Å 90.00° 100.15° 90.00°	Depositor
Resolution (Å)	48.72 – 3.40 89.24 – 3.40	Depositor EDS
% Data completeness (in resolution range)	97.2 (48.72-3.40) 97.3 (89.24-3.40)	Depositor EDS
R_{merge}	0.21	Depositor
R_{sym}	(Not available)	Depositor
$\langle I/\sigma(I) \rangle$ ¹	3.11 (at 3.41Å)	Xtrriage
Refinement program	PHENIX (phenix.refine: 1.9_1692)	Depositor
R, R_{free}	0.280 , 0.337 0.283 , 0.339	Depositor DCC
R_{free} test set	1275 reflections (5.02%)	wwPDB-VP
Wilson B-factor (Å ²)	71.4	Xtrriage
Anisotropy	0.933	Xtrriage
Bulk solvent k_{sol} (e/Å ³), B_{sol} (Å ²)	0.32 , 57.0	EDS
L-test for twinning ²	$\langle L \rangle = 0.47$, $\langle L^2 \rangle = 0.30$	Xtrriage
Estimated twinning fraction	No twinning to report.	Xtrriage
F_o, F_c correlation	0.86	EDS
Total number of atoms	12574	wwPDB-VP
Average B, all atoms (Å ²)	104.0	wwPDB-VP

Xtrriage's analysis on translational NCS is as follows: *The largest off-origin peak in the Patterson function is 3.61% of the height of the origin peak. No significant pseudotranslation is detected.*

¹Intensities estimated from amplitudes.

²Theoretical values of $\langle |L| \rangle$, $\langle L^2 \rangle$ for acentric reflections are 0.5, 0.333 respectively for untwinned datasets, and 0.375, 0.2 for perfectly twinned datasets.

5 Model quality [i](#)

5.1 Standard geometry [i](#)

Bond lengths and bond angles in the following residue types are not validated in this section:
2LJ

The Z score for a bond length (or angle) is the number of standard deviations the observed value is removed from the expected value. A bond length (or angle) with $|Z| > 5$ is considered an outlier worth inspection. RMSZ is the root-mean-square of all Z scores of the bond lengths (or angles).

Mol	Chain	Bond lengths		Bond angles	
		RMSZ	# $ Z > 5$	RMSZ	# $ Z > 5$
1	A	0.26	0/2229	0.46	0/3029
1	C	0.26	0/2076	0.44	0/2814
2	B	0.27	0/837	0.48	0/1134
2	F	0.26	0/851	0.49	0/1152
3	D	0.29	0/1483	0.46	0/2009
3	G	0.30	0/1499	0.47	0/2032
4	E	0.26	0/1999	0.46	0/2712
4	H	0.29	1/1880 (0.1%)	0.46	0/2562
All	All	0.27	1/12854 (0.0%)	0.46	0/17444

Chiral center outliers are detected by calculating the chiral volume of a chiral center and verifying if the center is modelled as a planar moiety or with the opposite hand. A planarity outlier is detected by checking planarity of atoms in a peptide group, atoms in a mainchain group or atoms of a sidechain that are expected to be planar.

Mol	Chain	#Chirality outliers	#Planarity outliers
4	H	0	1

All (1) bond length outliers are listed below:

Mol	Chain	Res	Type	Atoms	Z	Observed(Å)	Ideal(Å)
4	H	113	LEU	C-N	6.06	1.48	1.34

There are no bond angle outliers.

There are no chirality outliers.

All (1) planarity outliers are listed below:

Mol	Chain	Res	Type	Group
4	H	51	ASP	Peptide

5.2 Too-close contacts

In the following table, the Non-H and H(model) columns list the number of non-hydrogen atoms and hydrogen atoms in the chain respectively. The H(added) column lists the number of hydrogen atoms added and optimized by MolProbity. The Clashes column lists the number of clashes within the asymmetric unit, whereas Symm-Clashes lists symmetry-related clashes.

Mol	Chain	Non-H	H(model)	H(added)	Clashes	Symm-Clashes
1	A	2164	0	2057	16	0
1	C	2017	0	1910	17	0
2	B	814	0	781	6	0
2	F	828	0	796	15	0
3	D	1456	0	1427	12	1
3	G	1472	0	1433	42	0
4	E	1948	0	1877	18	0
4	H	1831	0	1700	31	0
5	A	22	0	18	1	0
5	C	22	0	18	1	0
All	All	12574	0	12017	133	1

The all-atom clashscore is defined as the number of clashes found per 1000 atoms (including hydrogen atoms). The all-atom clashscore for this structure is 5.

All (133) close contacts within the same asymmetric unit are listed below, sorted by their clash magnitude.

Atom-1	Atom-2	Interatomic distance (Å)	Clash overlap (Å)
1:A:41:ARG:NH1	4:H:56:GLU:OE2	2.11	0.82
3:G:111:ILE:HG21	3:G:138:ASP:HA	1.65	0.77
3:G:92:TYR:CE1	4:H:100:GLU:HB3	2.22	0.74
1:C:233:SER:HB2	2:F:12:ARG:HG3	1.70	0.73
3:G:91:ALA:O	3:G:97:LEU:HA	1.94	0.68
3:G:93:ASN:OD1	3:G:96:LYS:O	2.11	0.68
3:G:92:TYR:HE2	3:G:94:THR:CA	2.09	0.65
3:D:21:LEU:HD12	3:D:74:LEU:HD23	1.79	0.64
3:G:93:ASN:O	3:G:94:THR:OG1	2.11	0.64
3:G:62:SER:HB3	3:G:75:ASN:ND2	2.13	0.63
2:F:29:GLY:HA2	2:F:61:SER:HB2	1.81	0.62
3:G:92:TYR:OH	4:H:99:GLN:CD	2.39	0.61
3:G:92:TYR:CD1	4:H:100:GLU:HB3	2.36	0.61
3:G:92:TYR:CE1	4:H:100:GLU:HA	2.37	0.60
3:G:92:TYR:HE1	4:H:100:GLU:HA	1.65	0.60
3:G:92:TYR:HE2	3:G:94:THR:HA	1.66	0.60
1:C:119:PHE:HE2	1:C:139:ILE:HD11	1.65	0.59

Continued on next page...

Continued from previous page...

Atom-1	Atom-2	Interatomic distance (Å)	Clash overlap (Å)
3:G:92:TYR:CE2	3:G:94:THR:CA	2.85	0.59
1:A:17:HIS:HB3	1:A:19:VAL:HG22	1.83	0.59
3:G:21:LEU:HD22	3:G:103:THR:HG21	1.85	0.58
3:G:131:VAL:HG23	3:G:174:TRP:HB3	1.84	0.58
2:F:23:LEU:HB2	2:F:70:PHE:CE1	2.38	0.58
3:G:37:LYS:HB2	3:G:46:LEU:HD11	1.86	0.57
4:E:11:LEU:HB3	4:E:110:LEU:HD12	1.85	0.57
3:G:93:ASN:O	3:G:94:THR:HG23	2.05	0.56
3:G:31:ARG:HG3	3:G:32:SER:N	2.19	0.56
1:A:94:ARG:HD3	1:A:112:TYR:CZ	2.41	0.56
3:G:123:ASP:HB3	4:H:127:PHE:HA	1.88	0.56
4:E:126:VAL:HG23	4:E:236:ALA:HB3	1.88	0.55
3:D:157:CYS:SG	4:E:192:ARG:NH2	2.79	0.55
1:C:147:GLN:HA	1:C:150:LEU:HD12	1.86	0.55
4:H:117:LYS:HB3	4:H:224:GLN:HG3	1.87	0.55
4:E:116:LEU:HD22	4:E:216:LEU:HD21	1.88	0.55
1:C:234:GLY:H	2:F:12:ARG:HD2	1.71	0.55
1:C:231:LEU:HB3	2:F:10:TYR:CZ	2.42	0.54
1:A:9:ARG:HD2	1:A:22:PHE:HZ	1.73	0.53
2:B:35:ILE:HD13	2:B:37:VAL:HG23	1.89	0.53
1:C:22:PHE:CZ	1:C:24:SER:HB2	2.43	0.53
3:G:92:TYR:CE1	4:H:100:GLU:CB	2.92	0.52
1:C:70:GLN:HA	1:C:73:PHE:CZ	2.44	0.52
3:G:92:TYR:CE2	3:G:94:THR:HA	2.43	0.52
4:E:210:GLN:HA	4:E:235:SER:HB3	1.91	0.52
3:G:2:ASP:N	3:G:27:VAL:HA	2.25	0.52
3:G:92:TYR:HE2	3:G:94:THR:C	2.13	0.52
1:A:77:LEU:HD13	1:A:92:TYR:HB2	1.92	0.52
1:A:232:PRO:HG2	2:B:65:LEU:HD13	1.91	0.52
3:G:92:TYR:OH	4:H:99:GLN:NE2	2.43	0.52
4:H:34:TRP:CD1	4:H:76:LEU:HB2	2.45	0.51
1:A:9:ARG:NH1	1:A:94:ARG:HE	2.09	0.51
2:F:40:LEU:HD11	2:F:81:ARG:HB2	1.93	0.51
2:F:70:PHE:C	2:F:70:PHE:CD2	2.84	0.50
3:G:92:TYR:CE2	3:G:94:THR:C	2.85	0.50
1:C:113:ALA:HB2	2:F:60:TRP:CE2	2.46	0.50
4:H:100:GLU:HG2	4:H:101:THR:HG23	1.92	0.50
2:F:39:LEU:HB3	2:F:46:ILE:HD12	1.93	0.50
1:A:101:LEU:HD12	1:A:105:SER:HB3	1.94	0.50
3:G:92:TYR:CE1	4:H:100:GLU:CA	2.95	0.50
2:B:7:ILE:HG12	2:B:82:VAL:HG21	1.94	0.49

Continued on next page...

Continued from previous page...

Atom-1	Atom-2	Interatomic distance (Å)	Clash overlap (Å)
3:G:92:TYR:CD1	4:H:100:GLU:CB	2.96	0.49
1:A:9:ARG:HD2	1:A:22:PHE:CZ	2.47	0.49
4:E:158:TRP:HZ3	4:E:191:SER:OG	1.96	0.49
3:G:90:ALA:HB2	3:G:99:PHE:CE1	2.47	0.49
3:D:157:CYS:HB3	4:E:170:CYS:SG	2.53	0.48
2:B:38:ASP:OD1	2:B:45:ARG:HD2	2.13	0.48
1:C:75:VAL:HG22	4:E:51:ASP:HB2	1.95	0.48
3:G:108:PHE:CE2	3:G:156:LYS:HD2	2.49	0.48
3:D:37:LYS:HB2	3:D:46:LEU:HD11	1.96	0.47
4:E:22:GLU:OE1	4:E:73:ARG:HD2	2.13	0.47
3:D:39:GLU:HG2	3:D:85:ALA:HB2	1.97	0.47
3:G:62:SER:HB3	3:G:75:ASN:HD21	1.79	0.47
4:H:4:VAL:HG13	4:H:25:GLN:HG3	1.96	0.47
1:C:152:TYR:CG	3:D:31:ARG:HG3	2.50	0.47
3:D:21:LEU:HD22	3:D:103:THR:HG21	1.96	0.47
1:A:20:PRO:HB2	1:A:23:ILE:HG13	1.96	0.47
3:G:159:LEU:O	3:G:167:LYS:HA	2.15	0.46
4:H:134:ILE:HG23	4:H:197:ALA:HB1	1.97	0.46
1:C:234:GLY:N	2:F:12:ARG:HD2	2.30	0.46
3:D:31:ARG:HH11	3:D:92:TYR:HD2	1.64	0.46
3:G:112:GLN:NE2	3:G:112:GLN:O	2.49	0.46
4:H:99:GLN:HE21	4:H:99:GLN:HB3	1.60	0.46
1:C:9:ARG:HB2	1:C:94:ARG:HB3	1.98	0.46
4:E:25:GLN:NE2	4:E:32:MET:SD	2.89	0.45
2:F:45:ARG:NH1	2:F:47:GLU:OE2	2.48	0.45
3:G:112:GLN:H	3:G:112:GLN:CD	2.19	0.45
4:E:31:ASN:HB2	4:E:94:SER:HB3	1.98	0.45
2:B:17:ASN:HA	2:B:72:PRO:HB2	1.98	0.45
3:G:29:ASN:OD1	3:G:93:ASN:O	2.35	0.45
1:C:101:LEU:HD12	1:C:105:SER:HB3	1.99	0.44
1:C:140:LYS:O	1:C:144:GLU:HG3	2.17	0.44
2:B:73:THR:HG23	2:B:76:ASP:HB2	1.99	0.44
3:G:95:ASP:OD1	4:H:50:TYR:OH	2.36	0.44
4:E:222:TRP:HB2	4:E:228:LYS:HE2	1.98	0.44
5:C:600:2LJ:O4	5:C:600:2LJ:H1	2.17	0.44
3:D:1:GLU:HG2	3:D:27:VAL:HG13	1.99	0.44
1:A:17:HIS:C	1:A:19:VAL:H	2.21	0.43
4:E:86:THR:HG23	4:E:111:LEU:HA	2.00	0.43
3:G:93:ASN:OD1	3:G:93:ASN:N	2.35	0.43
3:G:91:ALA:O	3:G:97:LEU:CA	2.65	0.43
2:F:23:LEU:HB2	2:F:70:PHE:CD1	2.54	0.43

Continued on next page...

Continued from previous page...

Atom-1	Atom-2	Interatomic distance (Å)	Clash overlap (Å)
4:H:99:GLN:O	4:H:99:GLN:HG2	2.18	0.43
1:A:56:PRO:HA	1:A:59:TRP:CE3	2.54	0.43
5:A:600:2LJ:O4	5:A:600:2LJ:H1	2.18	0.43
4:E:152:ASP:HB2	4:E:175:PRO:HG2	2.01	0.43
3:G:97:LEU:HD11	4:H:102:GLN:OE1	2.19	0.42
3:G:42:ALA:HA	3:G:43:PRO:HD3	1.91	0.42
1:C:13:SER:HB3	1:C:89:SER:HA	2.01	0.42
1:A:124:LYS:HB2	1:A:154:LYS:HG3	2.02	0.42
4:H:69:ASP:HB3	4:H:73:ARG:O	2.19	0.42
1:C:120:LEU:HA	1:C:130:LEU:O	2.20	0.42
3:G:31:ARG:HH22	4:H:100:GLU:CD	2.19	0.42
3:G:90:ALA:HB2	3:G:99:PHE:CD1	2.55	0.42
4:H:33:PHE:HB3	4:H:48:PHE:HA	2.01	0.42
4:H:123:GLU:O	4:H:146:ALA:HA	2.19	0.42
4:H:46:ILE:HG22	4:H:47:TYR:CD2	2.55	0.42
1:A:212:MET:HG2	1:A:258:VAL:HG22	2.01	0.41
2:F:5:PRO:HD3	2:F:84:HIS:CD2	2.54	0.41
4:H:228:LYS:HA	4:H:229:PRO:HD3	1.96	0.41
4:E:18:LYS:HA	4:E:78:LEU:O	2.20	0.41
1:A:14:ASP:OD1	1:A:16:ILE:HD11	2.21	0.41
3:D:109:PRO:HB3	3:D:167:LYS:HD3	2.03	0.41
3:D:162:ARG:NH2	4:E:167:SER:HA	2.36	0.41
3:G:93:ASN:O	3:G:94:THR:CB	2.68	0.41
4:H:150:TYR:HB2	4:H:186:ARG:HA	2.02	0.41
4:E:134:ILE:H	4:E:134:ILE:HG13	1.68	0.41
4:H:174:GLN:HA	4:H:175:PRO:HD3	1.89	0.41
4:H:226:ARG:HG2	4:H:227:ALA:H	1.86	0.41
2:F:35:ILE:HG21	2:F:84:HIS:CD2	2.56	0.41
4:H:67:SER:HB2	4:H:77:ILE:HD11	2.02	0.41
1:A:201:LYS:HG2	1:A:241:TRP:HD1	1.86	0.40
3:D:42:ALA:HA	3:D:43:PRO:HD3	1.95	0.40
1:C:232:PRO:HG2	2:F:65:LEU:HD13	2.03	0.40
4:E:179:GLN:HB3	4:E:182:LEU:HD12	2.02	0.40
4:H:126:VAL:HG23	4:H:236:ALA:HB3	2.02	0.40

All (1) symmetry-related close contacts are listed below. The label for Atom-2 includes the symmetry operator and encoded unit-cell translations to be applied.

Atom-1	Atom-2	Interatomic distance (Å)	Clash overlap (Å)
3:D:163:SER:OG	3:D:163:SER:OG[2_755]	2.00	0.20

5.3 Torsion angles [i](#)

5.3.1 Protein backbone [i](#)

In the following table, the Percentiles column shows the percent Ramachandran outliers of the chain as a percentile score with respect to all X-ray entries followed by that with respect to entries of similar resolution.

The Analysed column shows the number of residues for which the backbone conformation was analysed, and the total number of residues.

Mol	Chain	Analysed	Favoured	Allowed	Outliers	Percentiles	
1	A	258/271 (95%)	244 (95%)	13 (5%)	1 (0%)	34	67
1	C	232/271 (86%)	223 (96%)	9 (4%)	0	100	100
2	B	96/100 (96%)	91 (95%)	5 (5%)	0	100	100
2	F	97/100 (97%)	91 (94%)	4 (4%)	2 (2%)	7	30
3	D	183/203 (90%)	172 (94%)	11 (6%)	0	100	100
3	G	183/203 (90%)	171 (93%)	11 (6%)	1 (0%)	29	61
4	E	239/243 (98%)	226 (95%)	13 (5%)	0	100	100
4	H	228/243 (94%)	215 (94%)	11 (5%)	2 (1%)	17	49
All	All	1516/1634 (93%)	1433 (94%)	77 (5%)	6 (0%)	34	67

All (6) Ramachandran outliers are listed below:

Mol	Chain	Res	Type
2	F	52	SER
3	G	94	THR
2	F	53	ASP
4	H	81	ALA
4	H	8	SER
1	A	14	ASP

5.3.2 Protein sidechains [i](#)

In the following table, the Percentiles column shows the percent sidechain outliers of the chain as a percentile score with respect to all X-ray entries followed by that with respect to entries of similar resolution.

The Analysed column shows the number of residues for which the sidechain conformation was analysed, and the total number of residues.

Mol	Chain	Analysed	Rotameric	Outliers	Percentiles	
1	A	231/241 (96%)	227 (98%)	4 (2%)	60	80
1	C	215/241 (89%)	213 (99%)	2 (1%)	78	90
2	B	92/95 (97%)	90 (98%)	2 (2%)	52	75
2	F	94/95 (99%)	92 (98%)	2 (2%)	53	76
3	D	170/186 (91%)	168 (99%)	2 (1%)	71	85
3	G	170/186 (91%)	165 (97%)	5 (3%)	42	69
4	E	215/217 (99%)	212 (99%)	3 (1%)	67	83
4	H	198/217 (91%)	190 (96%)	8 (4%)	31	60
All	All	1385/1478 (94%)	1357 (98%)	28 (2%)	55	77

All (28) residues with a non-rotameric sidechain are listed below:

Mol	Chain	Res	Type
1	A	14	ASP
1	A	17	HIS
1	A	94	ARG
1	A	221	ILE
2	B	53	ASP
2	B	73	THR
1	C	25	VAL
1	C	46	ARG
3	D	75	ASN
3	D	94	THR
4	E	94	SER
4	E	154	VAL
4	E	158	TRP
2	F	3	ARG
2	F	70	PHE
3	G	31	ARG
3	G	75	ASN
3	G	96	LYS
3	G	97	LEU
3	G	112	GLN
4	H	33	PHE
4	H	41	LEU
4	H	52	VAL
4	H	72	GLU
4	H	77	ILE
4	H	88	MET
4	H	99	GLN

Continued on next page...

Continued from previous page...

Mol	Chain	Res	Type
4	H	154	VAL

Sometimes sidechains can be flipped to improve hydrogen bonding and reduce clashes. All (3) such sidechains are listed below:

Mol	Chain	Res	Type
3	G	75	ASN
4	H	99	GLN
4	H	102	GLN

5.3.3 RNA [i](#)

There are no RNA molecules in this entry.

5.4 Non-standard residues in protein, DNA, RNA chains [i](#)

There are no non-standard protein/DNA/RNA residues in this entry.

5.5 Carbohydrates [i](#)

There are no monosaccharides in this entry.

5.6 Ligand geometry [i](#)

2 ligands are modelled in this entry.

In the following table, the Counts columns list the number of bonds (or angles) for which Mogul statistics could be retrieved, the number of bonds (or angles) that are observed in the model and the number of bonds (or angles) that are defined in the Chemical Component Dictionary. The Link column lists molecule types, if any, to which the group is linked. The Z score for a bond length (or angle) is the number of standard deviations the observed value is removed from the expected value. A bond length (or angle) with $|Z| > 2$ is considered an outlier worth inspection. RMSZ is the root-mean-square of all Z scores of the bond lengths (or angles).

Mol	Type	Chain	Res	Link	Bond lengths			Bond angles		
					Counts	RMSZ	$\# Z > 2$	Counts	RMSZ	$\# Z > 2$
5	2LJ	A	600	1	21,22,22	0.76	1 (4%)	21,29,29	0.78	2 (9%)
5	2LJ	C	600	1	21,22,22	0.74	1 (4%)	21,29,29	0.91	2 (9%)

In the following table, the Chirals column lists the number of chiral outliers, the number of chiral

centers analysed, the number of these observed in the model and the number defined in the Chemical Component Dictionary. Similar counts are reported in the Torsion and Rings columns. '-' means no outliers of that kind were identified.

Mol	Type	Chain	Res	Link	Chirals	Torsions	Rings
5	2LJ	A	600	1	-	1/18/19/19	0/1/1/1
5	2LJ	C	600	1	-	5/18/19/19	0/1/1/1

All (2) bond length outliers are listed below:

Mol	Chain	Res	Type	Atoms	Z	Observed(Å)	Ideal(Å)
5	A	600	2LJ	C7-C6	-3.27	1.45	1.49
5	C	600	2LJ	C7-C6	-2.94	1.46	1.49

All (4) bond angle outliers are listed below:

Mol	Chain	Res	Type	Atoms	Z	Observed(°)	Ideal(°)
5	A	600	2LJ	C8-C7-C6	2.33	117.87	113.75
5	C	600	2LJ	C8-C7-C6	2.26	117.75	113.75
5	C	600	2LJ	C2'-C1'-N8	2.08	117.49	111.52
5	A	600	2LJ	C4A-C8A-N1	2.06	120.51	116.14

There are no chirality outliers.

All (6) torsion outliers are listed below:

Mol	Chain	Res	Type	Atoms
5	C	600	2LJ	N8-C1'-C2'-C3'
5	C	600	2LJ	C2'-C3'-C4'-C5'
5	C	600	2LJ	O3'-C3'-C4'-O4'
5	C	600	2LJ	C2'-C3'-C4'-O4'
5	C	600	2LJ	O3'-C3'-C4'-C5'
5	A	600	2LJ	N8-C1'-C2'-C3'

There are no ring outliers.

2 monomers are involved in 2 short contacts:

Mol	Chain	Res	Type	Clashes	Symm-Clashes
5	A	600	2LJ	1	0
5	C	600	2LJ	1	0

The following is a two-dimensional graphical depiction of Mogul quality analysis of bond lengths, bond angles, torsion angles, and ring geometry for all instances of the Ligand of Interest. In addition, ligands with molecular weight > 250 and outliers as shown on the validation Tables will

also be included. For torsion angles, if less than 5% of the Mogul distribution of torsion angles is within 10 degrees of the torsion angle in question, then that torsion angle is considered an outlier. Any bond that is central to one or more torsion angles identified as an outlier by Mogul will be highlighted in the graph. For rings, the root-mean-square deviation (RMSD) between the ring in question and similar rings identified by Mogul is calculated over all ring torsion angles. If the average RMSD is greater than 60 degrees and the minimal RMSD between the ring in question and any Mogul-identified rings is also greater than 60 degrees, then that ring is considered an outlier. The outliers are highlighted in purple. The color gray indicates Mogul did not find sufficient equivalents in the CSD to analyse the geometry.

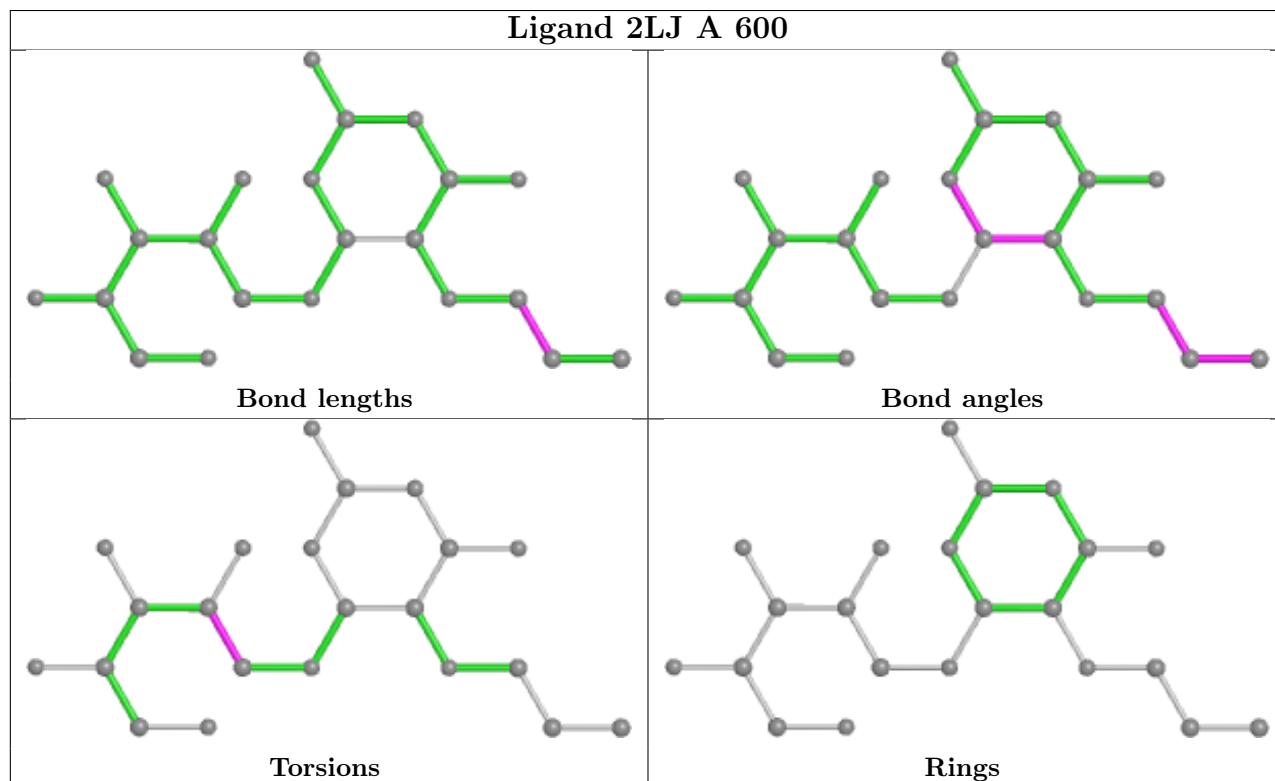

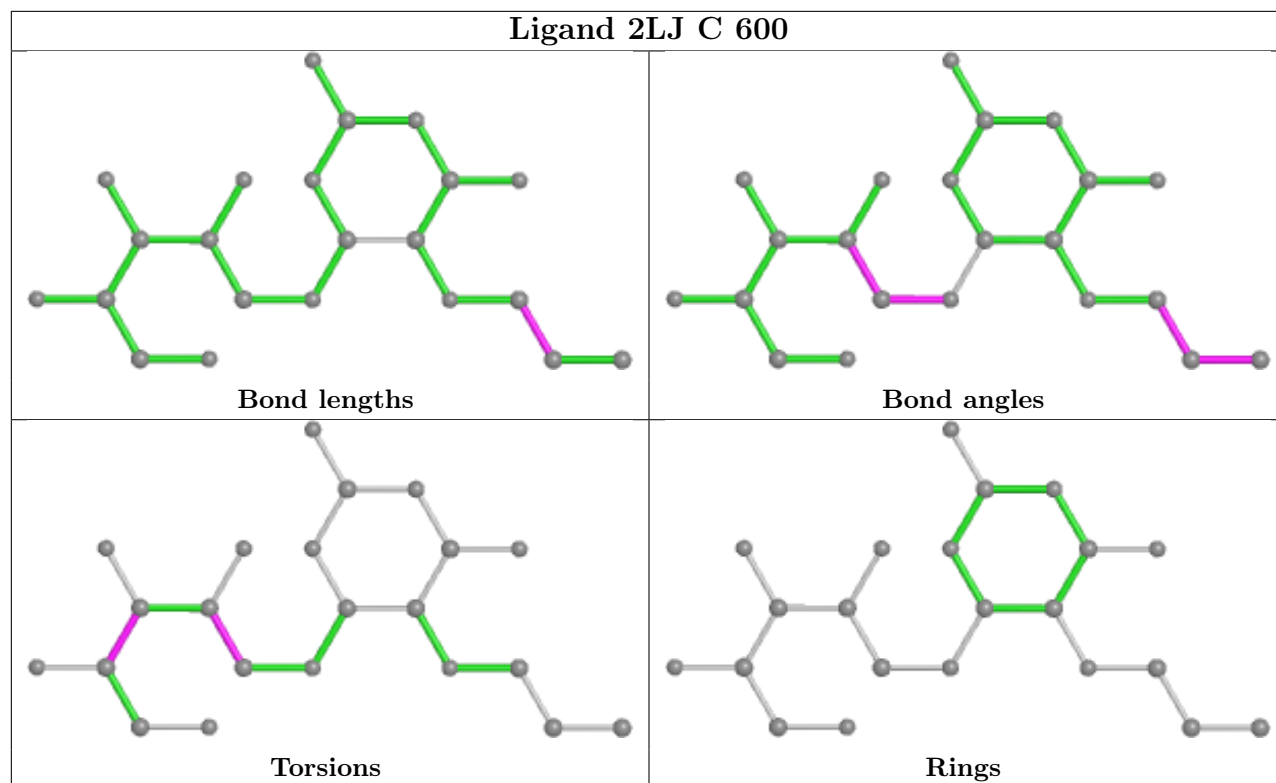

5.7 Other polymers [i](#)

There are no such residues in this entry.

5.8 Polymer linkage issues [i](#)

There are no chain breaks in this entry.

6 Fit of model and data [i](#)

6.1 Protein, DNA and RNA chains [i](#)

In the following table, the column labelled ‘#RSRZ > 2’ contains the number (and percentage) of RSRZ outliers, followed by percent RSRZ outliers for the chain as percentile scores relative to all X-ray entries and entries of similar resolution. The OWAB column contains the minimum, median, 95th percentile and maximum values of the occupancy-weighted average B-factor per residue. The column labelled ‘Q < 0.9’ lists the number of (and percentage) of residues with an average occupancy less than 0.9.

Mol	Chain	Analysed	<RSRZ>	#RSRZ>2	OWAB(Å ²)	Q<0.9
1	A	262/271 (96%)	0.36	0 100 100	57, 88, 116, 136	0
1	C	242/271 (89%)	0.79	26 (10%) 6 7	57, 104, 144, 172	0
2	B	98/100 (98%)	0.32	0 100 100	62, 83, 103, 115	0
2	F	99/100 (99%)	1.12	16 (16%) 1 2	103, 119, 138, 144	0
3	D	187/203 (92%)	0.52	7 (3%) 41 40	57, 79, 133, 152	0
3	G	189/203 (93%)	0.72	24 (12%) 3 4	62, 82, 154, 179	0
4	E	241/243 (99%)	0.55	8 (3%) 46 45	63, 97, 123, 146	0
4	H	232/243 (95%)	1.51	74 (31%) 0 0	83, 156, 192, 200	0
All	All	1550/1634 (94%)	0.74	155 (10%) 7 8	57, 99, 164, 200	0

All (155) RSRZ outliers are listed below:

Mol	Chain	Res	Type	RSRZ
4	H	189	LEU	10.0
1	C	242	ALA	7.3
4	H	121	PRO	6.2
4	H	151	PRO	5.6
3	G	173	ALA	5.5
4	H	211	VAL	5.2
4	H	207	PHE	5.1
3	G	188	ASN	5.1
1	C	244	ILE	5.0
2	F	80	CYS	4.8
3	G	189	SER	4.8
4	H	116	LEU	4.8
3	G	174	TRP	4.7
4	H	188	ALA	4.6
4	H	166	HIS	4.4
4	H	210	GLN	4.3

Continued on next page...

Continued from previous page...

Mol	Chain	Res	Type	RSRZ
4	H	234	VAL	4.3
4	H	83	THR	4.3
4	H	130	SER	4.2
1	C	73	PHE	4.2
4	H	135	SER	4.2
2	F	14	PRO	4.1
4	H	233	ILE	4.1
4	H	216	LEU	4.1
4	H	143	VAL	4.0
4	H	225	ASP	4.0
2	F	31	HIS	4.0
4	E	2	VAL	4.0
3	G	133	LEU	3.9
4	H	125	ALA	3.8
4	H	113	LEU	3.8
1	C	120	LEU	3.7
4	H	27	MET	3.6
4	H	123	GLU	3.6
1	C	200	CYS	3.6
3	G	150	ASP	3.6
1	C	130	LEU	3.6
4	H	122	PRO	3.6
3	G	171	ALA	3.6
3	D	147	LYS	3.5
2	F	82	VAL	3.5
2	F	33	SER	3.5
4	H	92	ALA	3.5
4	H	190	SER	3.4
4	H	227	ALA	3.4
4	H	127	PHE	3.4
4	H	119	VAL	3.4
4	H	174	GLN	3.4
2	F	1	ILE	3.3
4	H	18	LYS	3.3
3	G	153	ILE	3.3
1	C	83	HIS	3.2
1	C	268	GLN	3.2
4	H	206	HIS	3.2
4	H	139	LYS	3.2
3	G	183	ALA	3.2
4	H	78	LEU	3.2
4	H	141	THR	3.2

Continued on next page...

Continued from previous page...

Mol	Chain	Res	Type	RSRZ
1	C	255	SER	3.2
3	G	132	CYS	3.2
4	E	129	PRO	3.2
4	H	146	ALA	3.2
4	H	193	LEU	3.1
2	F	72	PRO	3.1
4	H	109	ARG	3.1
3	G	190	ILE	3.1
4	H	110	LEU	3.1
1	C	8	PHE	3.1
4	H	14	ARG	3.0
4	H	239	TRP	3.0
3	G	152	TYR	3.0
3	D	138	ASP	3.0
4	H	126	VAL	3.0
4	H	191	SER	2.9
4	H	177	LYS	2.9
3	G	123	ASP	2.9
2	F	11	SER	2.8
3	G	160	ASP	2.8
4	H	195	VAL	2.8
4	H	175	PRO	2.8
4	H	26	ASP	2.8
4	H	237	GLU	2.7
4	H	161	ASN	2.7
3	D	180	PHE	2.7
4	H	64	TYR	2.7
4	H	148	GLY	2.7
3	D	174	TRP	2.7
3	G	164	MET	2.7
3	G	170	SER	2.6
4	E	181	ALA	2.6
3	D	185	ALA	2.6
4	E	127	PHE	2.6
3	G	142	ASN	2.6
4	H	120	PHE	2.6
1	C	241	TRP	2.6
2	F	10	TYR	2.6
2	F	24	ASN	2.6
4	H	4	VAL	2.6
1	C	238	TYR	2.6
4	H	93	SER	2.5

Continued on next page...

Continued from previous page...

Mol	Chain	Res	Type	RSRZ
4	H	149	PHE	2.5
4	H	147	THR	2.5
4	H	235	SER	2.5
3	G	141	THR	2.5
4	H	90	LEU	2.5
4	H	176	LEU	2.5
4	H	223	THR	2.5
2	F	88	SER	2.5
3	D	152	TYR	2.4
4	H	238	ALA	2.4
1	C	209	GLU	2.4
4	H	45	LEU	2.4
4	H	160	VAL	2.4
4	H	229	PRO	2.4
1	C	99	GLU	2.3
4	H	137	THR	2.3
2	F	70	PHE	2.3
1	C	257	HIS	2.3
3	G	143	VAL	2.3
1	C	71	GLN	2.3
4	H	165	VAL	2.3
3	D	199	SER	2.2
3	G	163	SER	2.2
4	E	239	TRP	2.2
4	H	201	GLN	2.2
1	C	243	SER	2.2
1	C	264	HIS	2.2
4	E	145	LEU	2.2
4	H	209	CYS	2.2
3	G	180	PHE	2.2
4	H	145	LEU	2.2
4	H	199	PHE	2.2
4	H	7	SER	2.2
1	C	129	TRP	2.1
4	H	162	GLY	2.1
2	F	37	VAL	2.1
2	F	68	THR	2.1
1	C	201	LYS	2.1
4	E	186	ARG	2.1
1	C	267	LEU	2.1
3	G	41	LYS	2.1
1	C	29	ASP	2.1

Continued on next page...

Continued from previous page...

Mol	Chain	Res	Type	RSRZ
1	C	214	TRP	2.1
4	H	215	GLY	2.1
2	F	0	MET	2.1
1	C	95	MET	2.1
3	G	172	VAL	2.1
1	C	80	LEU	2.0
2	F	13	HIS	2.0
4	E	44	ARG	2.0
4	H	158	TRP	2.0
4	H	200	TRP	2.0
4	H	224	GLN	2.0
1	C	224	GLU	2.0
3	G	182	CYS	2.0

6.2 Non-standard residues in protein, DNA, RNA chains [i](#)

There are no non-standard protein/DNA/RNA residues in this entry.

6.3 Carbohydrates [i](#)

There are no monosaccharides in this entry.

6.4 Ligands [i](#)

In the following table, the Atoms column lists the number of modelled atoms in the group and the number defined in the chemical component dictionary. The B-factors column lists the minimum, median, 95th percentile and maximum values of B factors of atoms in the group. The column labelled 'Q< 0.9' lists the number of atoms with occupancy less than 0.9.

Mol	Type	Chain	Res	Atoms	RSCC	RSR	B-factors(Å ²)	Q<0.9
5	2LJ	C	600	22/22	0.90	0.25	57,77,80,82	0
5	2LJ	A	600	22/22	0.93	0.28	61,70,85,90	0

The following is a graphical depiction of the model fit to experimental electron density of all instances of the Ligand of Interest. In addition, ligands with molecular weight > 250 and outliers as shown on the geometry validation Tables will also be included. Each fit is shown from different orientation to approximate a three-dimensional view.

Electron density around 2LJ C 600:

$2mF_o-DF_c$ (at 0.7 rmsd) in gray
 mF_o-DF_c (at 3 rmsd) in purple (negative)
and green (positive)

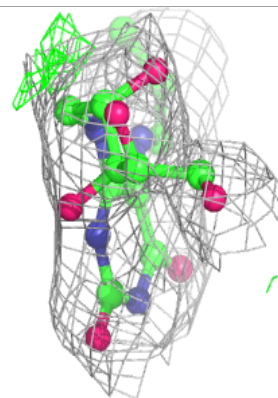
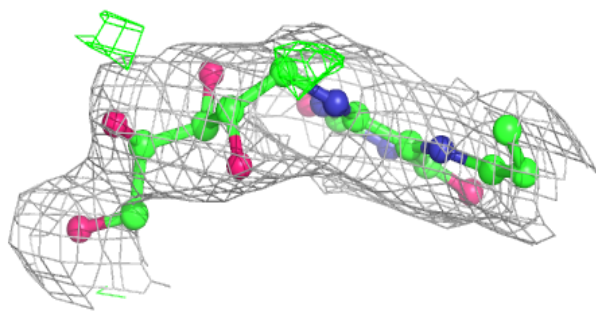
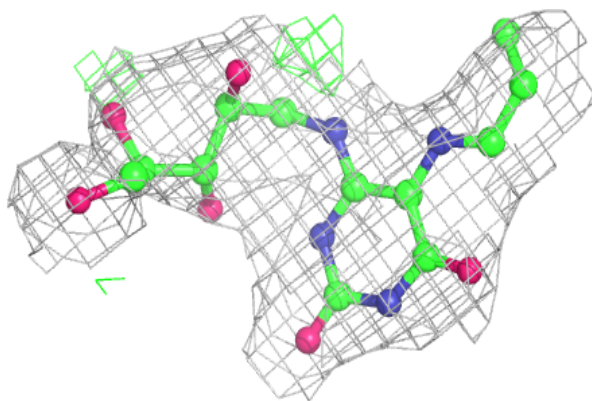

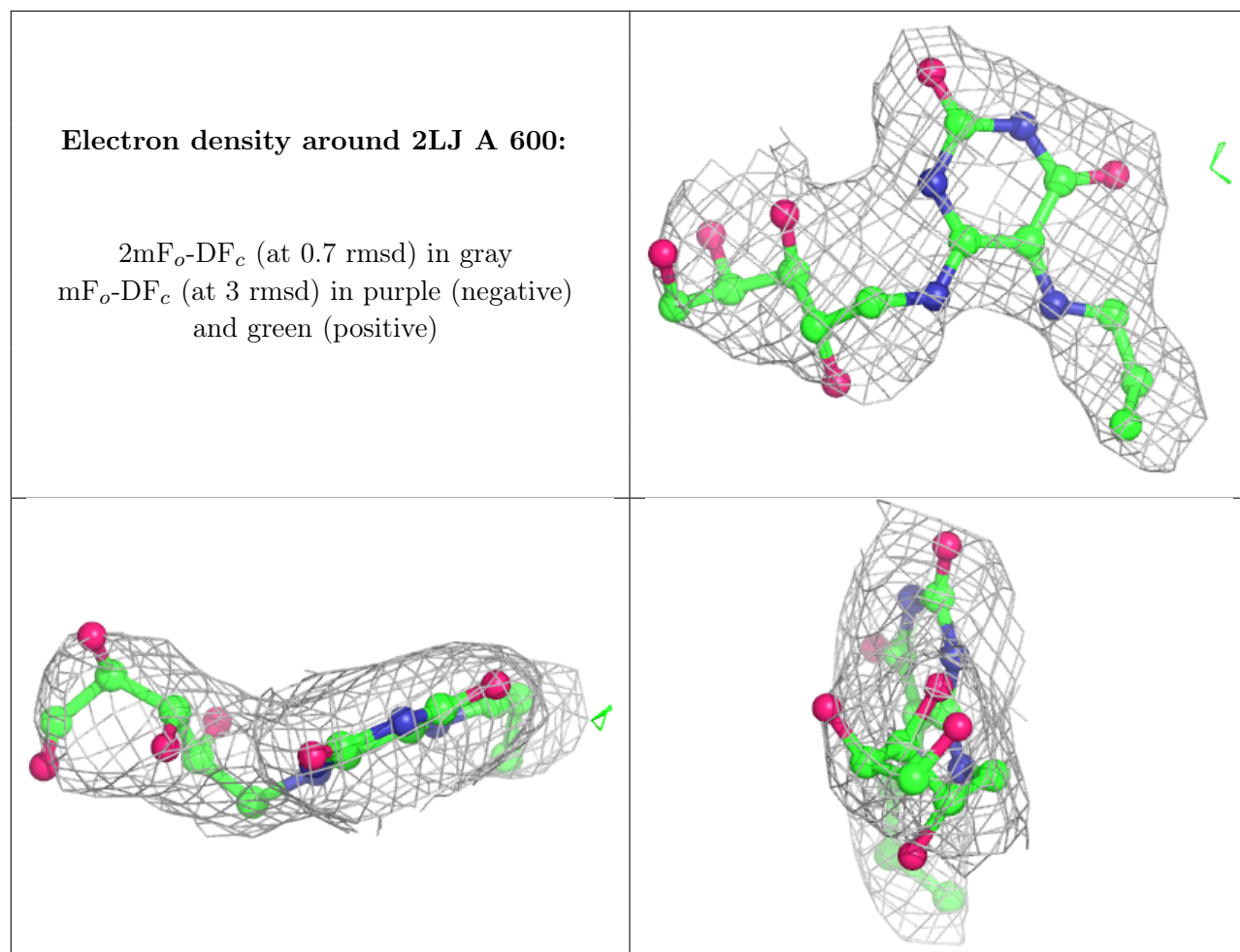

6.5 Other polymers [i](#)

There are no such residues in this entry.