



## Full wwPDB EM Validation Report ⓘ

Nov 21, 2022 – 08:54 PM JST

PDB ID : 7DK7  
EMDB ID : EMD-30705  
Title : S-2H2-F3b structure, three RBDs are up and each RBD binds with a 2H2 Fab.  
Authors : Cong, Y.; Wang, Y.F.  
Deposited on : 2020-11-23  
Resolution : 9.70 Å (reported)

This is a Full wwPDB EM Validation Report for a publicly released PDB entry.

We welcome your comments at [validation@mail.wwpdb.org](mailto:validation@mail.wwpdb.org)

A user guide is available at

<https://www.wwpdb.org/validation/2017/EMValidationReportHelp>

with specific help available everywhere you see the ⓘ symbol.

The types of validation reports are described at

<http://www.wwpdb.org/validation/2017/FAQs#types>.

---

The following versions of software and data (see [references ⓘ](#)) were used in the production of this report:

EMDB validation analysis : 0.0.1.dev43  
MolProbity : 4.02b-467  
Percentile statistics : 20191225.v01 (using entries in the PDB archive December 25th 2019)  
MapQ : 1.9.9  
Ideal geometry (proteins) : Engh & Huber (2001)  
Ideal geometry (DNA, RNA) : Parkinson et al. (1996)  
Validation Pipeline (wwPDB-VP) : 2.31.3

# 1 Overall quality at a glance i

The following experimental techniques were used to determine the structure:  
*ELECTRON MICROSCOPY*

The reported resolution of this entry is 9.70 Å.

Percentile scores (ranging between 0-100) for global validation metrics of the entry are shown in the following graphic. The table shows the number of entries on which the scores are based.

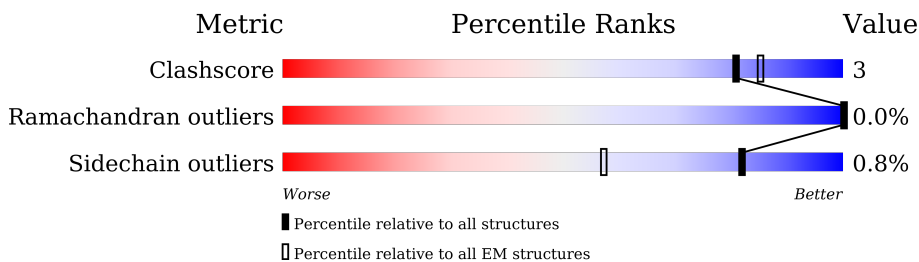

Metric	Whole archive (#Entries)	EM structures (#Entries)
Clashscore	158937	4297
Ramachandran outliers	154571	4023
Sidechain outliers	154315	3826

The table below summarises the geometric issues observed across the polymeric chains and their fit to the map. The red, orange, yellow and green segments of the bar indicate the fraction of residues that contain outliers for  $\geq 3$ , 2, 1 and 0 types of geometric quality criteria respectively. A grey segment represents the fraction of residues that are not modelled. The numeric value for each fraction is indicated below the corresponding segment, with a dot representing fractions  $\leq 5\%$ . The upper red bar (where present) indicates the fraction of residues that have poor fit to the EM map (all-atom inclusion  $< 40\%$ ). The numeric value is given above the bar.

Mol	Chain	Length	Quality of chain
1	a	214	
1	c	214	
1	e	214	
2	b	218	
2	d	218	
2	f	218	
3	A	1261	
3	B	1261	

*Continued on next page...*

*Continued from previous page...*

Mol	Chain	Length	Quality of chain
3	C	1261	 <p>A horizontal bar chart representing the quality of chain. The bar is divided into four segments: a small red segment at the beginning labeled '5%', a large green segment labeled '76%', a small yellow segment labeled '8%', and a grey segment at the end labeled '16%'.</p>

## 2 Entry composition [i](#)

There are 3 unique types of molecules in this entry. The entry contains 32504 atoms, of which 0 are hydrogens and 0 are deuteriums.

In the tables below, the AltConf column contains the number of residues with at least one atom in alternate conformation and the Trace column contains the number of residues modelled with at most 2 atoms.

- Molecule 1 is a protein called The heavy chain fragment of 2H2 Fab.

Mol	Chain	Residues	Atoms					AltConf	Trace
			Total	C	N	O	S		
1	e	18	138	90	23	23	2	0	0
1	a	214	1603	1011	267	316	9	0	0
1	c	214	1603	1011	267	316	9	0	0

- Molecule 2 is a protein called The light chain fragment of 2H2 Fab.

Mol	Chain	Residues	Atoms					AltConf	Trace
			Total	C	N	O	S		
2	f	119	903	565	153	183	2	0	0
2	b	218	1686	1047	285	348	6	0	0
2	d	218	1686	1047	285	348	6	0	0

- Molecule 3 is a protein called Spike glycoprotein.

Mol	Chain	Residues	Atoms					AltConf	Trace
			Total	C	N	O	S		
3	A	1060	8295	5290	1386	1581	38	0	0
3	B	1060	8295	5290	1386	1581	38	0	0
3	C	1060	8295	5290	1386	1581	38	0	0

There are 174 discrepancies between the modelled and reference sequences:

Chain	Residue	Modelled	Actual	Comment	Reference
A	682	GLY	ARG	conflict	UNP P0DTC2
A	683	SER	ARG	conflict	UNP P0DTC2
A	685	SER	ARG	conflict	UNP P0DTC2

*Continued on next page...*

*Continued from previous page...*

Chain	Residue	Modelled	Actual	Comment	Reference
A	986	PRO	LYS	conflict	UNP P0DTC2
A	987	PRO	VAL	conflict	UNP P0DTC2
A	1209	GLY	-	expression tag	UNP P0DTC2
A	1210	SER	-	expression tag	UNP P0DTC2
A	1211	GLY	-	expression tag	UNP P0DTC2
A	1212	TYR	-	expression tag	UNP P0DTC2
A	1213	ILE	-	expression tag	UNP P0DTC2
A	1214	PRO	-	expression tag	UNP P0DTC2
A	1215	GLU	-	expression tag	UNP P0DTC2
A	1216	ALA	-	expression tag	UNP P0DTC2
A	1217	PRO	-	expression tag	UNP P0DTC2
A	1218	ARG	-	expression tag	UNP P0DTC2
A	1219	ASP	-	expression tag	UNP P0DTC2
A	1220	GLY	-	expression tag	UNP P0DTC2
A	1221	GLN	-	expression tag	UNP P0DTC2
A	1222	ALA	-	expression tag	UNP P0DTC2
A	1223	TYR	-	expression tag	UNP P0DTC2
A	1224	VAL	-	expression tag	UNP P0DTC2
A	1225	ARG	-	expression tag	UNP P0DTC2
A	1226	LYS	-	expression tag	UNP P0DTC2
A	1227	ASP	-	expression tag	UNP P0DTC2
A	1228	GLY	-	expression tag	UNP P0DTC2
A	1229	GLU	-	expression tag	UNP P0DTC2
A	1230	TRP	-	expression tag	UNP P0DTC2
A	1231	VAL	-	expression tag	UNP P0DTC2
A	1232	LEU	-	expression tag	UNP P0DTC2
A	1233	LEU	-	expression tag	UNP P0DTC2
A	1234	SER	-	expression tag	UNP P0DTC2
A	1235	THR	-	expression tag	UNP P0DTC2
A	1236	PHE	-	expression tag	UNP P0DTC2
A	1237	LEU	-	expression tag	UNP P0DTC2
A	1238	GLU	-	expression tag	UNP P0DTC2
A	1239	ASN	-	expression tag	UNP P0DTC2
A	1240	LEU	-	expression tag	UNP P0DTC2
A	1241	TYR	-	expression tag	UNP P0DTC2
A	1242	PHE	-	expression tag	UNP P0DTC2
A	1243	GLN	-	expression tag	UNP P0DTC2
A	1244	GLY	-	expression tag	UNP P0DTC2
A	1245	ASP	-	expression tag	UNP P0DTC2
A	1246	TYR	-	expression tag	UNP P0DTC2
A	1247	LYS	-	expression tag	UNP P0DTC2
A	1248	ASP	-	expression tag	UNP P0DTC2

*Continued on next page...*

*Continued from previous page...*

Chain	Residue	Modelled	Actual	Comment	Reference
A	1249	ASP	-	expression tag	UNP P0DTC2
A	1250	ASP	-	expression tag	UNP P0DTC2
A	1251	ASP	-	expression tag	UNP P0DTC2
A	1252	LYS	-	expression tag	UNP P0DTC2
A	1253	HIS	-	expression tag	UNP P0DTC2
A	1254	HIS	-	expression tag	UNP P0DTC2
A	1255	HIS	-	expression tag	UNP P0DTC2
A	1256	HIS	-	expression tag	UNP P0DTC2
A	1257	HIS	-	expression tag	UNP P0DTC2
A	1258	HIS	-	expression tag	UNP P0DTC2
A	1259	HIS	-	expression tag	UNP P0DTC2
A	1260	HIS	-	expression tag	UNP P0DTC2
A	1261	HIS	-	expression tag	UNP P0DTC2
B	682	GLY	ARG	conflict	UNP P0DTC2
B	683	SER	ARG	conflict	UNP P0DTC2
B	685	SER	ARG	conflict	UNP P0DTC2
B	986	PRO	LYS	conflict	UNP P0DTC2
B	987	PRO	VAL	conflict	UNP P0DTC2
B	1209	GLY	-	expression tag	UNP P0DTC2
B	1210	SER	-	expression tag	UNP P0DTC2
B	1211	GLY	-	expression tag	UNP P0DTC2
B	1212	TYR	-	expression tag	UNP P0DTC2
B	1213	ILE	-	expression tag	UNP P0DTC2
B	1214	PRO	-	expression tag	UNP P0DTC2
B	1215	GLU	-	expression tag	UNP P0DTC2
B	1216	ALA	-	expression tag	UNP P0DTC2
B	1217	PRO	-	expression tag	UNP P0DTC2
B	1218	ARG	-	expression tag	UNP P0DTC2
B	1219	ASP	-	expression tag	UNP P0DTC2
B	1220	GLY	-	expression tag	UNP P0DTC2
B	1221	GLN	-	expression tag	UNP P0DTC2
B	1222	ALA	-	expression tag	UNP P0DTC2
B	1223	TYR	-	expression tag	UNP P0DTC2
B	1224	VAL	-	expression tag	UNP P0DTC2
B	1225	ARG	-	expression tag	UNP P0DTC2
B	1226	LYS	-	expression tag	UNP P0DTC2
B	1227	ASP	-	expression tag	UNP P0DTC2
B	1228	GLY	-	expression tag	UNP P0DTC2
B	1229	GLU	-	expression tag	UNP P0DTC2
B	1230	TRP	-	expression tag	UNP P0DTC2
B	1231	VAL	-	expression tag	UNP P0DTC2
B	1232	LEU	-	expression tag	UNP P0DTC2

*Continued on next page...*

*Continued from previous page...*

Chain	Residue	Modelled	Actual	Comment	Reference
B	1233	LEU	-	expression tag	UNP P0DTC2
B	1234	SER	-	expression tag	UNP P0DTC2
B	1235	THR	-	expression tag	UNP P0DTC2
B	1236	PHE	-	expression tag	UNP P0DTC2
B	1237	LEU	-	expression tag	UNP P0DTC2
B	1238	GLU	-	expression tag	UNP P0DTC2
B	1239	ASN	-	expression tag	UNP P0DTC2
B	1240	LEU	-	expression tag	UNP P0DTC2
B	1241	TYR	-	expression tag	UNP P0DTC2
B	1242	PHE	-	expression tag	UNP P0DTC2
B	1243	GLN	-	expression tag	UNP P0DTC2
B	1244	GLY	-	expression tag	UNP P0DTC2
B	1245	ASP	-	expression tag	UNP P0DTC2
B	1246	TYR	-	expression tag	UNP P0DTC2
B	1247	LYS	-	expression tag	UNP P0DTC2
B	1248	ASP	-	expression tag	UNP P0DTC2
B	1249	ASP	-	expression tag	UNP P0DTC2
B	1250	ASP	-	expression tag	UNP P0DTC2
B	1251	ASP	-	expression tag	UNP P0DTC2
B	1252	LYS	-	expression tag	UNP P0DTC2
B	1253	HIS	-	expression tag	UNP P0DTC2
B	1254	HIS	-	expression tag	UNP P0DTC2
B	1255	HIS	-	expression tag	UNP P0DTC2
B	1256	HIS	-	expression tag	UNP P0DTC2
B	1257	HIS	-	expression tag	UNP P0DTC2
B	1258	HIS	-	expression tag	UNP P0DTC2
B	1259	HIS	-	expression tag	UNP P0DTC2
B	1260	HIS	-	expression tag	UNP P0DTC2
B	1261	HIS	-	expression tag	UNP P0DTC2
C	682	GLY	ARG	conflict	UNP P0DTC2
C	683	SER	ARG	conflict	UNP P0DTC2
C	685	SER	ARG	conflict	UNP P0DTC2
C	986	PRO	LYS	conflict	UNP P0DTC2
C	987	PRO	VAL	conflict	UNP P0DTC2
C	1209	GLY	-	expression tag	UNP P0DTC2
C	1210	SER	-	expression tag	UNP P0DTC2
C	1211	GLY	-	expression tag	UNP P0DTC2
C	1212	TYR	-	expression tag	UNP P0DTC2
C	1213	ILE	-	expression tag	UNP P0DTC2
C	1214	PRO	-	expression tag	UNP P0DTC2
C	1215	GLU	-	expression tag	UNP P0DTC2
C	1216	ALA	-	expression tag	UNP P0DTC2

*Continued on next page...*

*Continued from previous page...*

Chain	Residue	Modelled	Actual	Comment	Reference
C	1217	PRO	-	expression tag	UNP P0DTC2
C	1218	ARG	-	expression tag	UNP P0DTC2
C	1219	ASP	-	expression tag	UNP P0DTC2
C	1220	GLY	-	expression tag	UNP P0DTC2
C	1221	GLN	-	expression tag	UNP P0DTC2
C	1222	ALA	-	expression tag	UNP P0DTC2
C	1223	TYR	-	expression tag	UNP P0DTC2
C	1224	VAL	-	expression tag	UNP P0DTC2
C	1225	ARG	-	expression tag	UNP P0DTC2
C	1226	LYS	-	expression tag	UNP P0DTC2
C	1227	ASP	-	expression tag	UNP P0DTC2
C	1228	GLY	-	expression tag	UNP P0DTC2
C	1229	GLU	-	expression tag	UNP P0DTC2
C	1230	TRP	-	expression tag	UNP P0DTC2
C	1231	VAL	-	expression tag	UNP P0DTC2
C	1232	LEU	-	expression tag	UNP P0DTC2
C	1233	LEU	-	expression tag	UNP P0DTC2
C	1234	SER	-	expression tag	UNP P0DTC2
C	1235	THR	-	expression tag	UNP P0DTC2
C	1236	PHE	-	expression tag	UNP P0DTC2
C	1237	LEU	-	expression tag	UNP P0DTC2
C	1238	GLU	-	expression tag	UNP P0DTC2
C	1239	ASN	-	expression tag	UNP P0DTC2
C	1240	LEU	-	expression tag	UNP P0DTC2
C	1241	TYR	-	expression tag	UNP P0DTC2
C	1242	PHE	-	expression tag	UNP P0DTC2
C	1243	GLN	-	expression tag	UNP P0DTC2
C	1244	GLY	-	expression tag	UNP P0DTC2
C	1245	ASP	-	expression tag	UNP P0DTC2
C	1246	TYR	-	expression tag	UNP P0DTC2
C	1247	LYS	-	expression tag	UNP P0DTC2
C	1248	ASP	-	expression tag	UNP P0DTC2
C	1249	ASP	-	expression tag	UNP P0DTC2
C	1250	ASP	-	expression tag	UNP P0DTC2
C	1251	ASP	-	expression tag	UNP P0DTC2
C	1252	LYS	-	expression tag	UNP P0DTC2
C	1253	HIS	-	expression tag	UNP P0DTC2
C	1254	HIS	-	expression tag	UNP P0DTC2
C	1255	HIS	-	expression tag	UNP P0DTC2
C	1256	HIS	-	expression tag	UNP P0DTC2
C	1257	HIS	-	expression tag	UNP P0DTC2
C	1258	HIS	-	expression tag	UNP P0DTC2

*Continued on next page...*



*Continued from previous page...*

<b>Chain</b>	<b>Residue</b>	<b>Modelled</b>	<b>Actual</b>	<b>Comment</b>	<b>Reference</b>
C	1259	HIS	-	expression tag	UNP P0DTC2
C	1260	HIS	-	expression tag	UNP P0DTC2
C	1261	HIS	-	expression tag	UNP P0DTC2



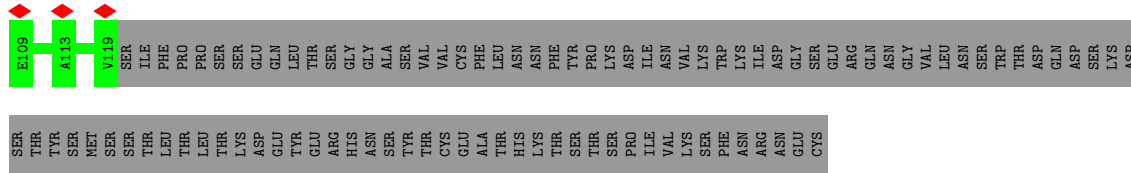

• Molecule 2: The light chain fragment of 2H2 Fab

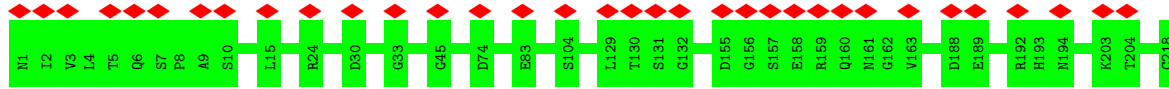

• Molecule 2: The light chain fragment of 2H2 Fab

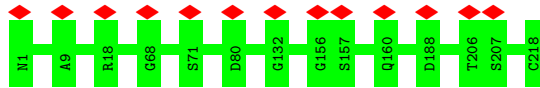

• Molecule 3: Spike glycoprotein

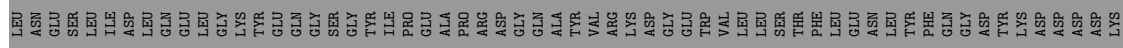
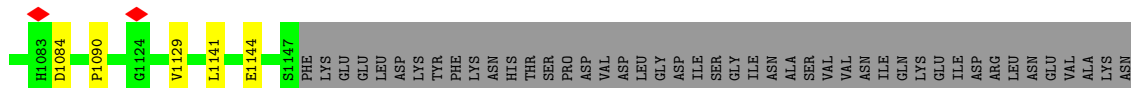
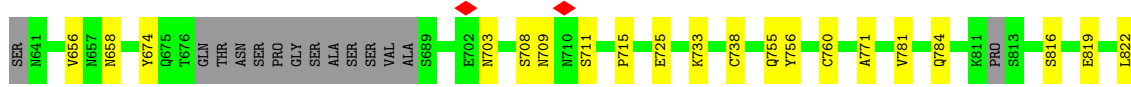
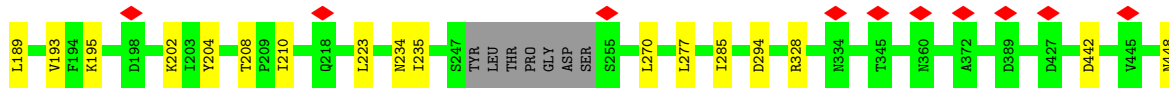
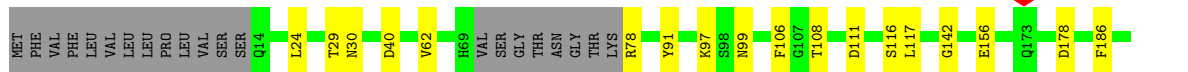
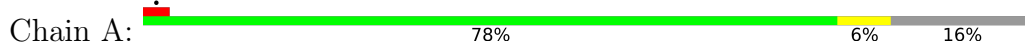

HIS  
HIS  
HIS  
HIS  
HIS  
HIS  
HIS  
HIS

• Molecule 3: Spike glycoprotein

Chain B:

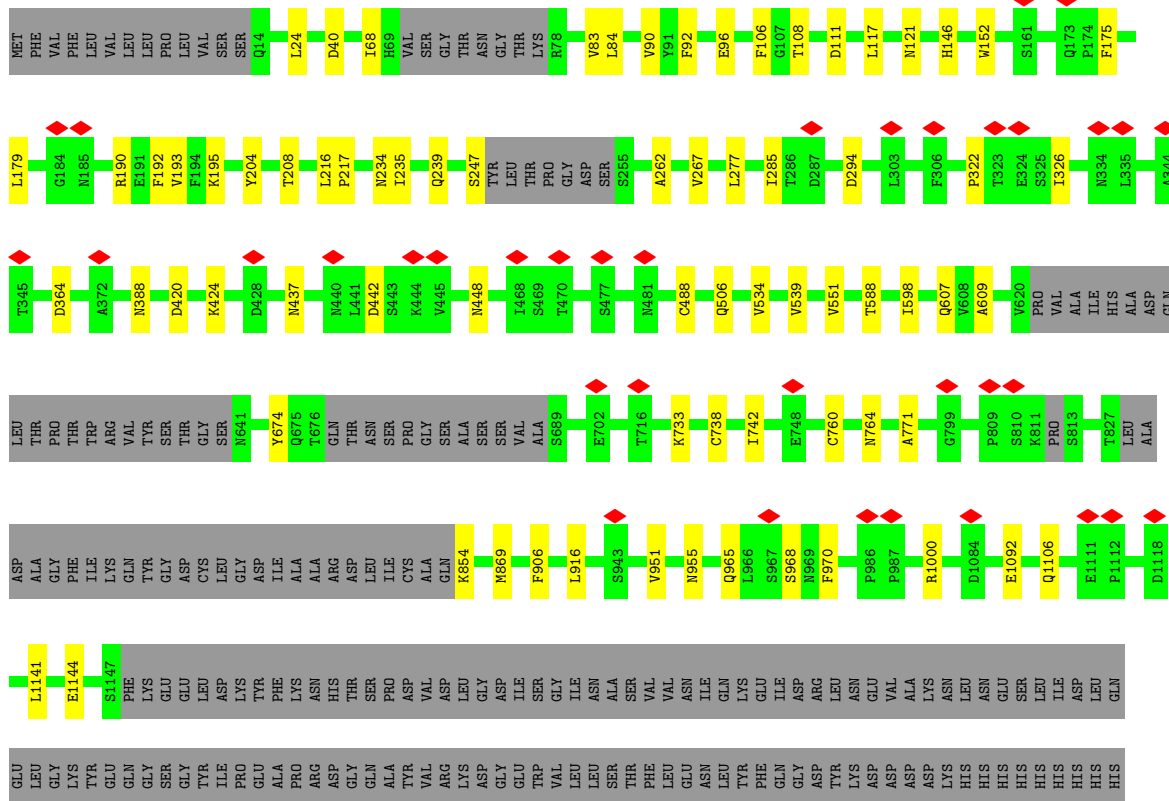

• Molecule 3: Spike glycoprotein

Chain C:

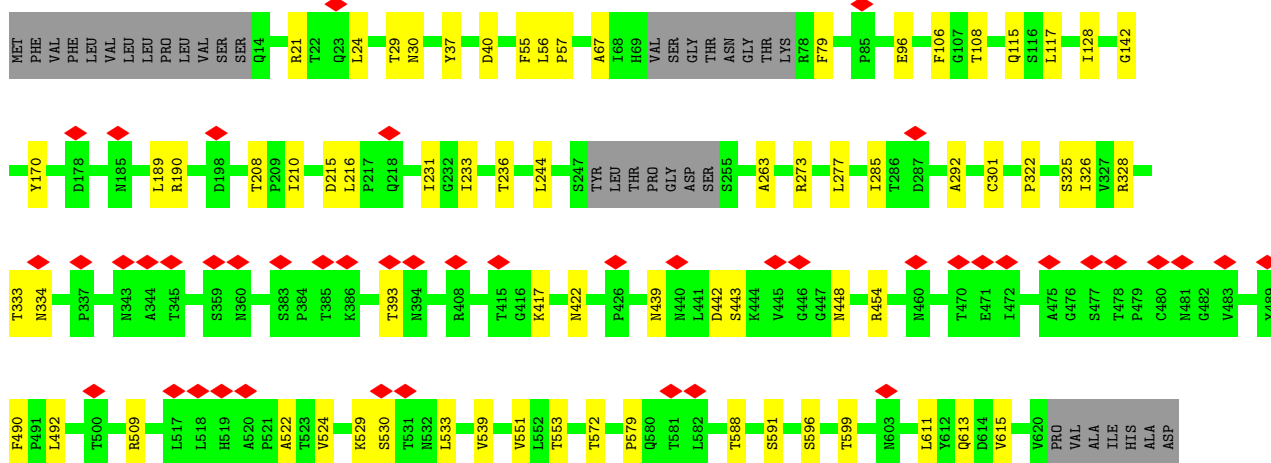



## 4 Experimental information

Property	Value	Source
EM reconstruction method	SINGLE PARTICLE	Depositor
Imposed symmetry	POINT, Not provided	
Number of particles used	8083	Depositor
Resolution determination method	FSC 0.143 CUT-OFF	Depositor
CTF correction method	PHASE FLIPPING AND AMPLITUDE CORRECTION	Depositor
Microscope	FEI TITAN KRIOS	Depositor
Voltage (kV)	300	Depositor
Electron dose ( $e^-/\text{\AA}^2$ )	49.6	Depositor
Minimum defocus (nm)	Not provided	
Maximum defocus (nm)	Not provided	
Magnification	Not provided	
Image detector	GATAN K2 SUMMIT (4k x 4k)	Depositor
Maximum map value	2.086	Depositor
Minimum map value	-0.723	Depositor
Average map value	0.015	Depositor
Map value standard deviation	0.121	Depositor
Recommended contour level	0.75	Depositor
Map size (Å)	408.0, 408.0, 408.0	wwPDB
Map dimensions	400, 400, 400	wwPDB
Map angles (°)	90.0, 90.0, 90.0	wwPDB
Pixel spacing (Å)	1.02, 1.02, 1.02	Depositor

## 5 Model quality [i](#)

### 5.1 Standard geometry [i](#)

The Z score for a bond length (or angle) is the number of standard deviations the observed value is removed from the expected value. A bond length (or angle) with  $|Z| > 5$  is considered an outlier worth inspection. RMSZ is the root-mean-square of all Z scores of the bond lengths (or angles).

Mol	Chain	Bond lengths		Bond angles	
		RMSZ	# Z  >5	RMSZ	# Z  >5
1	a	0.25	0/1645	0.46	0/2246
1	c	0.25	0/1645	0.46	0/2246
1	e	0.27	0/143	0.43	0/192
2	b	0.25	0/1724	0.44	0/2344
2	d	0.24	0/1724	0.44	0/2344
2	f	0.25	0/923	0.45	0/1258
3	A	0.25	0/8485	0.42	0/11543
3	B	0.25	0/8485	0.43	0/11543
3	C	0.25	0/8485	0.43	0/11543
All	All	0.25	0/33259	0.43	0/45259

There are no bond length outliers.

There are no bond angle outliers.

There are no chirality outliers.

There are no planarity outliers.

### 5.2 Too-close contacts [i](#)

In the following table, the Non-H and H(model) columns list the number of non-hydrogen atoms and hydrogen atoms in the chain respectively. The H(added) column lists the number of hydrogen atoms added and optimized by MolProbity. The Clashes column lists the number of clashes within the asymmetric unit, whereas Symm-Clashes lists symmetry-related clashes.

Mol	Chain	Non-H	H(model)	H(added)	Clashes	Symm-Clashes
1	a	1603	0	1565	0	0
1	c	1603	0	1565	0	0
1	e	138	0	120	0	0
2	b	1686	0	1604	0	0
2	d	1686	0	1604	0	0
2	f	903	0	870	0	0
3	A	8295	0	8088	47	0

*Continued on next page...*

*Continued from previous page...*

Mol	Chain	Non-H	H(model)	H(added)	Clashes	Symm-Clashes
3	B	8295	0	8086	40	0
3	C	8295	0	8090	57	0
All	All	32504	0	31592	129	0

The all-atom clashscore is defined as the number of clashes found per 1000 atoms (including hydrogen atoms). The all-atom clashscore for this structure is 3.

All (129) close contacts within the same asymmetric unit are listed below, sorted by their clash magnitude.

Atom-1	Atom-2	Interatomic distance (Å)	Clash overlap (Å)
3:A:572:THR:HG22	3:C:855:PHE:HE1	1.58	0.68
3:B:607:GLN:OE1	3:B:674:TYR:HE1	1.78	0.66
3:A:607:GLN:OE1	3:A:674:TYR:HE1	1.82	0.62
3:A:189:LEU:HB2	3:A:210:ILE:HG12	1.82	0.61
3:B:322:PRO:HB3	3:B:539:VAL:HA	1.87	0.56
3:C:328:ARG:HG2	3:C:579:PRO:HD2	1.87	0.56
3:B:598:ILE:HB	3:B:609:ALA:HB3	1.88	0.54
3:B:146:HIS:H	3:B:247:SER:HA	1.72	0.54
3:C:1076:THR:HB	3:C:1097:SER:HB3	1.89	0.54
3:C:189:LEU:HD22	3:C:210:ILE:HD12	1.88	0.54
3:A:756:TYR:O	3:B:965:GLN:NE2	2.41	0.53
3:C:106:PHE:HB2	3:C:117:LEU:HB3	1.91	0.53
3:C:909:ILE:O	3:C:1108:ASN:ND2	2.42	0.53
3:B:83:VAL:HG22	3:B:239:GLN:HE21	1.74	0.52
3:A:551:VAL:HB	3:A:588:THR:HB	1.91	0.52
3:B:106:PHE:HB2	3:B:117:LEU:HB3	1.92	0.51
3:A:715:PRO:HA	3:A:1072:GLU:HA	1.93	0.51
3:A:572:THR:HG22	3:C:855:PHE:CE1	2.42	0.51
3:B:738:CYS:SG	3:B:764:ASN:ND2	2.82	0.51
3:A:703:ASN:ND2	3:C:787:GLN:OE1	2.44	0.50
3:A:725:GLU:OE2	3:A:1028:LYS:NZ	2.45	0.50
3:C:128:ILE:HB	3:C:170:TYR:HB3	1.92	0.50
3:B:442:ASP:O	3:B:448:ASN:ND2	2.44	0.50
3:C:325:SER:HA	3:C:539:VAL:HG11	1.93	0.50
3:A:1090:PRO:O	3:C:913:GLN:NE2	2.45	0.49
3:A:277:LEU:HD22	3:A:285:ILE:HD13	1.95	0.49
3:A:572:THR:CG2	3:C:855:PHE:CE1	2.96	0.49
3:B:733:LYS:HE3	3:B:771:ALA:HB1	1.94	0.49
3:A:816:SER:H	3:A:819:GLU:HB2	1.78	0.49
3:C:96:GLU:OE2	3:C:190:ARG:NH2	2.46	0.49
3:B:420:ASP:OD1	3:B:424:LYS:NZ	2.44	0.48

*Continued on next page...*



*Continued from previous page...*

Atom-1	Atom-2	Interatomic distance (Å)	Clash overlap (Å)
3:A:328:ARG:NH2	3:A:580:GLN:OE1	2.47	0.48
3:C:551:VAL:HB	3:C:588:THR:HB	1.95	0.48
3:C:442:ASP:O	3:C:448:ASN:ND2	2.45	0.48
3:A:97:LYS:HB3	3:A:186:PHE:HA	1.96	0.48
3:B:96:GLU:OE2	3:B:190:ARG:NH2	2.46	0.48
3:C:596:SER:OG	3:C:613:GLN:NE2	2.47	0.48
3:C:1104:VAL:HG23	3:C:1115:ILE:HG12	1.94	0.48
3:B:1092:GLU:O	3:B:1106:GLN:NE2	2.47	0.47
3:C:442:ASP:OD1	3:C:509:ARG:NH2	2.43	0.47
3:A:980:ILE:HG23	3:A:984:LEU:HD12	1.95	0.47
3:C:333:THR:OG1	3:C:334:ASN:N	2.46	0.47
3:C:21:ARG:HG2	3:C:79:PHE:HB3	1.97	0.47
3:B:437:ASN:ND2	3:B:506:GLN:OE1	2.48	0.46
3:B:551:VAL:HB	3:B:588:THR:HB	1.98	0.46
3:A:709:ASN:ND2	3:C:796:ASP:OD2	2.47	0.46
3:C:322:PRO:HA	3:C:539:VAL:HG22	1.97	0.46
3:C:591:SER:HB3	3:C:615:VAL:HG12	1.96	0.46
3:C:742:ILE:O	3:C:1000:ARG:NH1	2.48	0.46
3:A:1144:GLU:HG3	3:B:1141:LEU:HD13	1.97	0.46
3:C:439:ASN:O	3:C:443:SER:OG	2.33	0.46
3:A:442:ASP:O	3:A:448:ASN:ND2	2.44	0.46
3:B:92:PHE:HB3	3:B:192:PHE:HB2	1.98	0.46
3:B:152:TRP:HD1	3:B:179:LEU:HB2	1.81	0.46
3:A:784:GLN:HB2	3:A:877:LEU:HD21	1.97	0.46
3:B:193:VAL:HB	3:B:204:TYR:HB2	1.97	0.46
3:C:454:ARG:HA	3:C:492:LEU:HD22	1.98	0.46
3:A:142:GLY:HA3	3:A:156:GLU:HB2	1.98	0.46
3:C:273:ARG:HD3	3:C:292:ALA:HB3	1.97	0.45
3:C:417:LYS:O	3:C:422:ASN:ND2	2.49	0.45
3:A:755:GLN:O	3:B:968:SER:OG	2.33	0.45
3:B:951:VAL:O	3:B:955:ASN:ND2	2.44	0.45
3:B:277:LEU:HD22	3:B:285:ILE:HD13	1.98	0.45
3:C:919:ASN:HB3	3:C:922:LEU:HB3	1.97	0.45
3:A:99:ASN:ND2	3:A:178:ASP:O	2.44	0.45
3:C:37:TYR:H	3:C:55:PHE:HE1	1.64	0.45
3:A:193:VAL:HB	3:A:204:TYR:HB2	1.99	0.45
3:C:553:THR:HG1	3:C:588:THR:HG1	1.63	0.45
3:B:106:PHE:HB3	3:B:235:ILE:HD13	1.99	0.45
3:B:294:ASP:N	3:B:294:ASP:OD1	2.51	0.44
3:C:1090:PRO:HA	3:C:1120:THR:HA	1.99	0.44
3:A:781:VAL:HG22	3:A:1026:ALA:HB2	2.00	0.44

*Continued on next page...*

*Continued from previous page...*

Atom-1	Atom-2	Interatomic distance (Å)	Clash overlap (Å)
3:A:733:LYS:HE3	3:A:771:ALA:HB1	1.99	0.44
3:C:277:LEU:HD22	3:C:285:ILE:HD13	2.00	0.44
3:A:29:THR:OG1	3:A:30:ASN:N	2.51	0.44
3:B:84:LEU:HG	3:B:267:VAL:HG11	2.00	0.43
3:A:24:LEU:HD22	3:A:78:ARG:HD2	2.00	0.43
3:B:216:LEU:HD12	3:B:217:PRO:HD2	2.00	0.43
3:B:742:ILE:O	3:B:1000:ARG:NH1	2.51	0.43
3:A:106:PHE:HB2	3:A:117:LEU:HB3	2.00	0.43
3:B:195:LYS:HE2	3:B:204:TYR:HE1	1.83	0.43
3:A:919:ASN:HB3	3:A:922:LEU:HB2	2.00	0.43
3:C:529:LYS:HA	3:C:530:SER:HA	1.55	0.43
3:C:29:THR:OG1	3:C:30:ASN:N	2.52	0.43
3:C:108:THR:O	3:C:236:THR:OG1	2.36	0.43
3:A:656:VAL:HG12	3:A:658:ASN:H	1.84	0.43
3:C:553:THR:OG1	3:C:588:THR:OG1	2.33	0.43
3:A:106:PHE:O	3:A:116:SER:OG	2.34	0.42
3:C:67:ALA:O	3:C:263:ALA:N	2.47	0.42
3:C:393:THR:HA	3:C:522:ALA:HA	2.01	0.42
3:A:1141:LEU:HD13	3:C:1144:GLU:HG3	2.01	0.42
3:B:869:MET:HB3	3:C:699:LEU:HD11	2.01	0.42
3:A:294:ASP:N	3:A:294:ASP:OD1	2.52	0.42
3:B:40:ASP:N	3:B:40:ASP:OD1	2.51	0.42
3:A:1129:VAL:HG13	3:C:917:TYR:HB3	2.00	0.42
3:C:823:PHE:HA	3:C:1057:PRO:HG3	2.00	0.42
3:C:896:ILE:HB	3:C:901:GLN:HE21	1.84	0.42
3:A:1084:ASP:OD1	3:A:1084:ASP:N	2.53	0.42
3:B:965:GLN:HG3	3:B:970:PHE:HZ	1.83	0.42
3:C:56:LEU:HD12	3:C:57:PRO:HD2	2.01	0.42
3:C:106:PHE:O	3:C:117:LEU:N	2.53	0.42
3:C:905:ARG:O	3:C:1036:GLN:NE2	2.52	0.42
3:B:854:LYS:HG3	3:C:572:THR:HG21	2.01	0.41
3:B:68:ILE:HG22	3:B:262:ALA:HA	2.02	0.41
3:B:111:ASP:OD1	3:B:111:ASP:N	2.53	0.41
3:B:906:PHE:HE2	3:B:916:LEU:HD13	1.85	0.41
3:C:1084:ASP:OD1	3:C:1084:ASP:N	2.53	0.41
3:A:193:VAL:HG23	3:A:223:LEU:HD12	2.02	0.41
3:A:969:ASN:ND2	3:C:755:GLN:OE1	2.51	0.41
3:C:231:ILE:HB	3:C:233:ILE:HG12	2.03	0.41
3:A:819:GLU:HA	3:A:822:LEU:HD12	2.03	0.41
3:A:442:ASP:OD1	3:A:509:ARG:NH2	2.43	0.41
3:B:108:THR:OG1	3:B:234:ASN:O	2.34	0.41

*Continued on next page...*

Continued from previous page...

Atom-1	Atom-2	Interatomic distance (Å)	Clash overlap (Å)
3:B:364:ASP:OD1	3:B:388:ASN:ND2	2.54	0.41
3:C:215:ASP:OD1	3:C:215:ASP:N	2.54	0.41
3:A:195:LYS:HE3	3:A:202:LYS:HD2	2.03	0.41
3:A:599:THR:HB	3:A:608:VAL:HG12	2.03	0.41
3:A:91:TYR:HB2	3:A:270:LEU:HD21	2.02	0.40
3:B:121:ASN:HD21	3:B:175:PHE:HZ	1.69	0.40
3:B:1144:GLU:HG3	3:C:1141:LEU:HD23	2.04	0.40
3:C:115:GLN:HB2	3:C:233:ILE:HG21	2.03	0.40
3:C:980:ILE:HG23	3:C:984:LEU:HD12	2.02	0.40
3:B:326:ILE:HG22	3:B:534:VAL:H	1.87	0.40
3:A:106:PHE:HB3	3:A:235:ILE:HD13	2.03	0.40
3:A:108:THR:OG1	3:A:234:ASN:O	2.37	0.40
3:A:708:SER:HG	3:A:711:SER:HG	1.65	0.40
3:C:985:ASP:O	3:C:989:ALA:N	2.52	0.40
3:A:40:ASP:N	3:A:40:ASP:OD1	2.55	0.40
3:C:142:GLY:HA2	3:C:244:LEU:HB2	2.03	0.40

There are no symmetry-related clashes.

## 5.3 Torsion angles [i](#)

### 5.3.1 Protein backbone [i](#)

In the following table, the Percentiles column shows the percent Ramachandran outliers of the chain as a percentile score with respect to all PDB entries followed by that with respect to all EM entries.

The Analysed column shows the number of residues for which the backbone conformation was analysed, and the total number of residues.

Mol	Chain	Analysed	Favoured	Allowed	Outliers	Percentiles	
1	a	212/214 (99%)	205 (97%)	7 (3%)	0	100	100
1	c	212/214 (99%)	204 (96%)	8 (4%)	0	100	100
1	e	16/214 (8%)	16 (100%)	0	0	100	100
2	b	216/218 (99%)	209 (97%)	7 (3%)	0	100	100
2	d	216/218 (99%)	206 (95%)	10 (5%)	0	100	100
2	f	117/218 (54%)	109 (93%)	8 (7%)	0	100	100
3	A	1046/1261 (83%)	1016 (97%)	29 (3%)	1 (0%)	51	86

Continued on next page...

Continued from previous page...

Mol	Chain	Analysed	Favoured	Allowed	Outliers	Percentiles	
3	B	1046/1261 (83%)	1012 (97%)	34 (3%)	0	100	100
3	C	1046/1261 (83%)	1007 (96%)	39 (4%)	0	100	100
All	All	4127/5079 (81%)	3984 (96%)	142 (3%)	1 (0%)	100	100

All (1) Ramachandran outliers are listed below:

Mol	Chain	Res	Type
3	A	573	THR

### 5.3.2 Protein sidechains [i](#)

In the following table, the Percentiles column shows the percent sidechain outliers of the chain as a percentile score with respect to all PDB entries followed by that with respect to all EM entries.

The Analysed column shows the number of residues for which the sidechain conformation was analysed, and the total number of residues.

Mol	Chain	Analysed	Rotameric	Outliers	Percentiles	
1	a	184/184 (100%)	182 (99%)	2 (1%)	73	84
1	c	184/184 (100%)	182 (99%)	2 (1%)	73	84
1	e	11/184 (6%)	11 (100%)	0	100	100
2	b	192/192 (100%)	192 (100%)	0	100	100
2	d	192/192 (100%)	192 (100%)	0	100	100
2	f	99/192 (52%)	99 (100%)	0	100	100
3	A	927/1099 (84%)	921 (99%)	6 (1%)	86	92
3	B	927/1099 (84%)	922 (100%)	5 (0%)	88	93
3	C	927/1099 (84%)	914 (99%)	13 (1%)	67	80
All	All	3643/4425 (82%)	3615 (99%)	28 (1%)	82	89

All (28) residues with a non-rotameric sidechain are listed below:

Mol	Chain	Res	Type
3	A	62	VAL
3	A	111	ASP
3	A	208	THR
3	A	488	CYS
3	A	738	CYS

Continued on next page...

*Continued from previous page...*

<b>Mol</b>	<b>Chain</b>	<b>Res</b>	<b>Type</b>
3	A	760	CYS
3	B	24	LEU
3	B	90	VAL
3	B	208	THR
3	B	488	CYS
3	B	760	CYS
1	a	95	CYS
1	a	144	CYS
1	c	95	CYS
1	c	144	CYS
3	C	24	LEU
3	C	40	ASP
3	C	208	THR
3	C	216	LEU
3	C	301	CYS
3	C	326	ILE
3	C	490	PHE
3	C	524	VAL
3	C	533	LEU
3	C	599	THR
3	C	611	LEU
3	C	815	ARG
3	C	1122	VAL

Sometimes sidechains can be flipped to improve hydrogen bonding and reduce clashes. All (16) such sidechains are listed below:

<b>Mol</b>	<b>Chain</b>	<b>Res</b>	<b>Type</b>
3	A	564	GLN
3	A	755	GLN
3	A	914	ASN
3	A	1011	GLN
3	B	121	ASN
3	B	239	GLN
3	B	675	GLN
3	B	913	GLN
3	B	965	GLN
3	B	1011	GLN
1	a	102	HIS
1	c	98	ASN
3	C	414	GLN
3	C	613	GLN
3	C	901	GLN

*Continued on next page...*

*Continued from previous page...*

Mol	Chain	Res	Type
3	C	1002	GLN

### 5.3.3 RNA [i](#)

There are no RNA molecules in this entry.

### 5.4 Non-standard residues in protein, DNA, RNA chains [i](#)

There are no non-standard protein/DNA/RNA residues in this entry.

### 5.5 Carbohydrates [i](#)

There are no monosaccharides in this entry.

### 5.6 Ligand geometry [i](#)

There are no ligands in this entry.

### 5.7 Other polymers [i](#)

There are no such residues in this entry.

### 5.8 Polymer linkage issues [i](#)

There are no chain breaks in this entry.

## 6 Map visualisation [i](#)

This section contains visualisations of the EMDB entry EMD-30705. These allow visual inspection of the internal detail of the map and identification of artifacts.

No raw map or half-maps were deposited for this entry and therefore no images, graphs, etc. pertaining to the raw map can be shown.

### 6.1 Orthogonal projections [i](#)

#### 6.1.1 Primary map

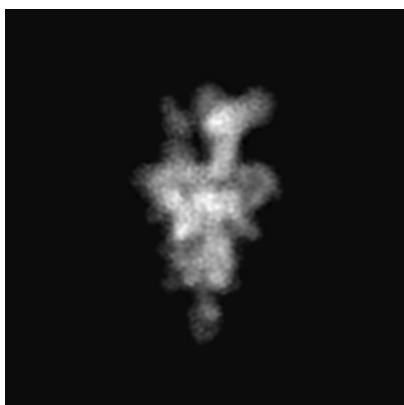

X

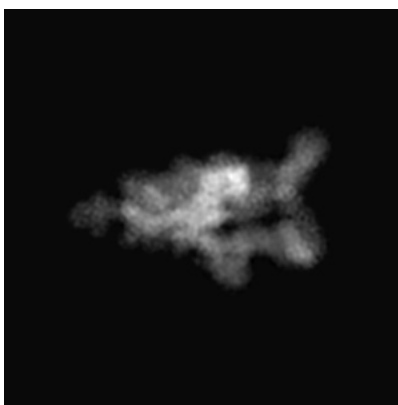

Y

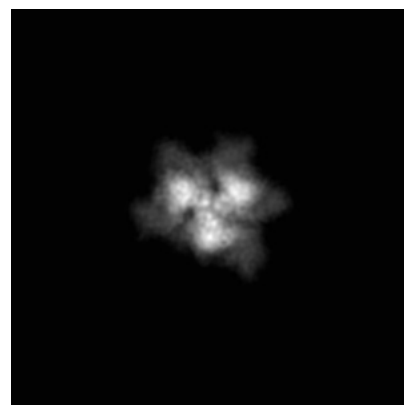

Z

The images above show the map projected in three orthogonal directions.

### 6.2 Central slices [i](#)

#### 6.2.1 Primary map

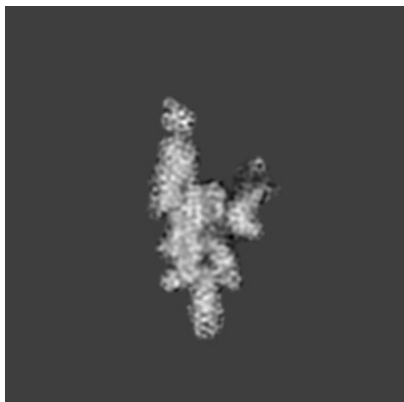

X Index: 200

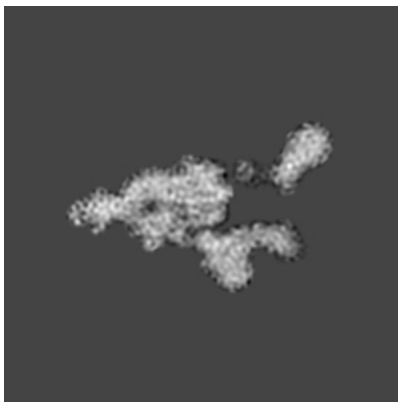

Y Index: 200

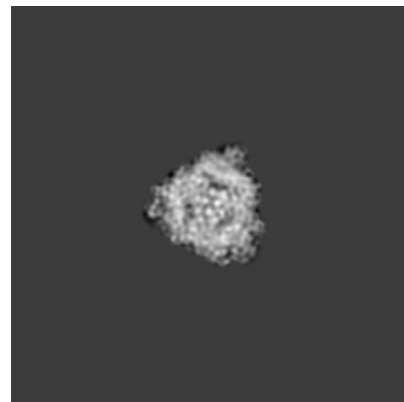

Z Index: 200

The images above show central slices of the map in three orthogonal directions.

## 6.3 Largest variance slices [i](#)

### 6.3.1 Primary map

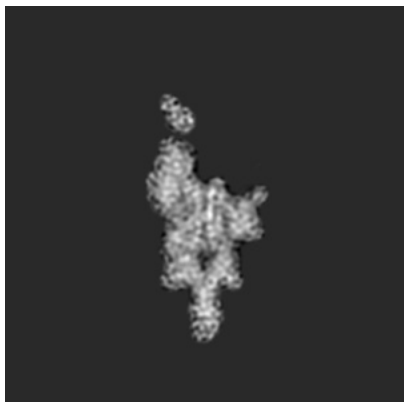

X Index: 195

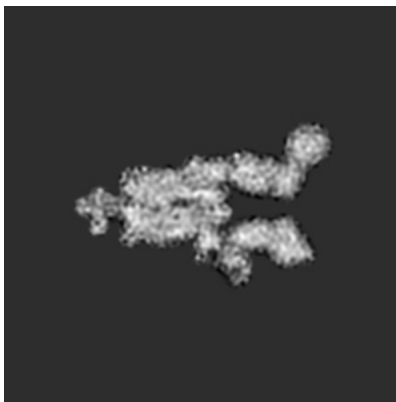

Y Index: 210

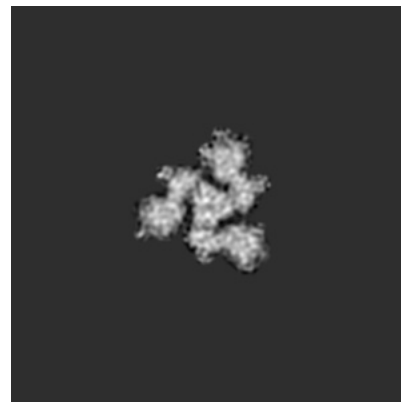

Z Index: 211

The images above show the largest variance slices of the map in three orthogonal directions.

## 6.4 Orthogonal surface views [i](#)

### 6.4.1 Primary map

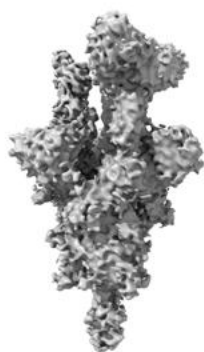

X

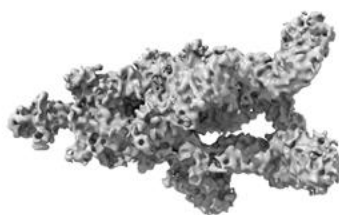

Y

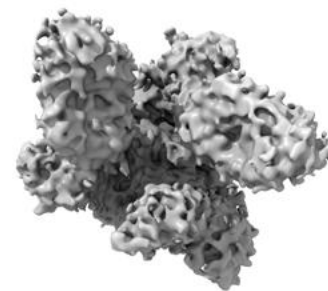

Z

The images above show the 3D surface view of the map at the recommended contour level 0.75. These images, in conjunction with the slice images, may facilitate assessment of whether an appropriate contour level has been provided.



## 6.5 Mask visualisation

This section was not generated. No masks/segmentation were deposited.

## 7 Map analysis [i](#)

This section contains the results of statistical analysis of the map.

### 7.1 Map-value distribution [i](#)

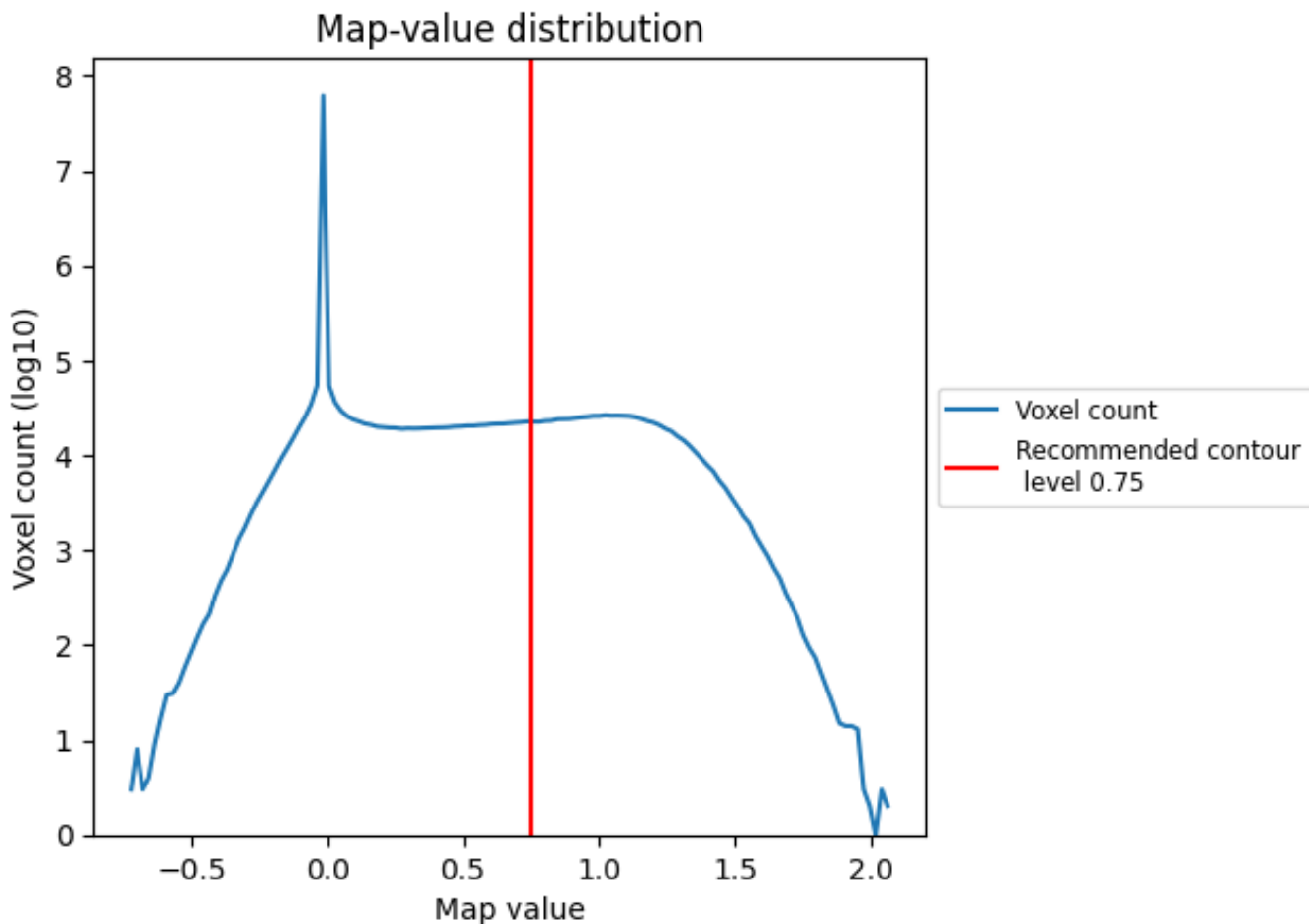

The map-value distribution is plotted in 128 intervals along the x-axis. The y-axis is logarithmic. A spike in this graph at zero usually indicates that the volume has been masked.

## 7.2 Volume estimate [i](#)

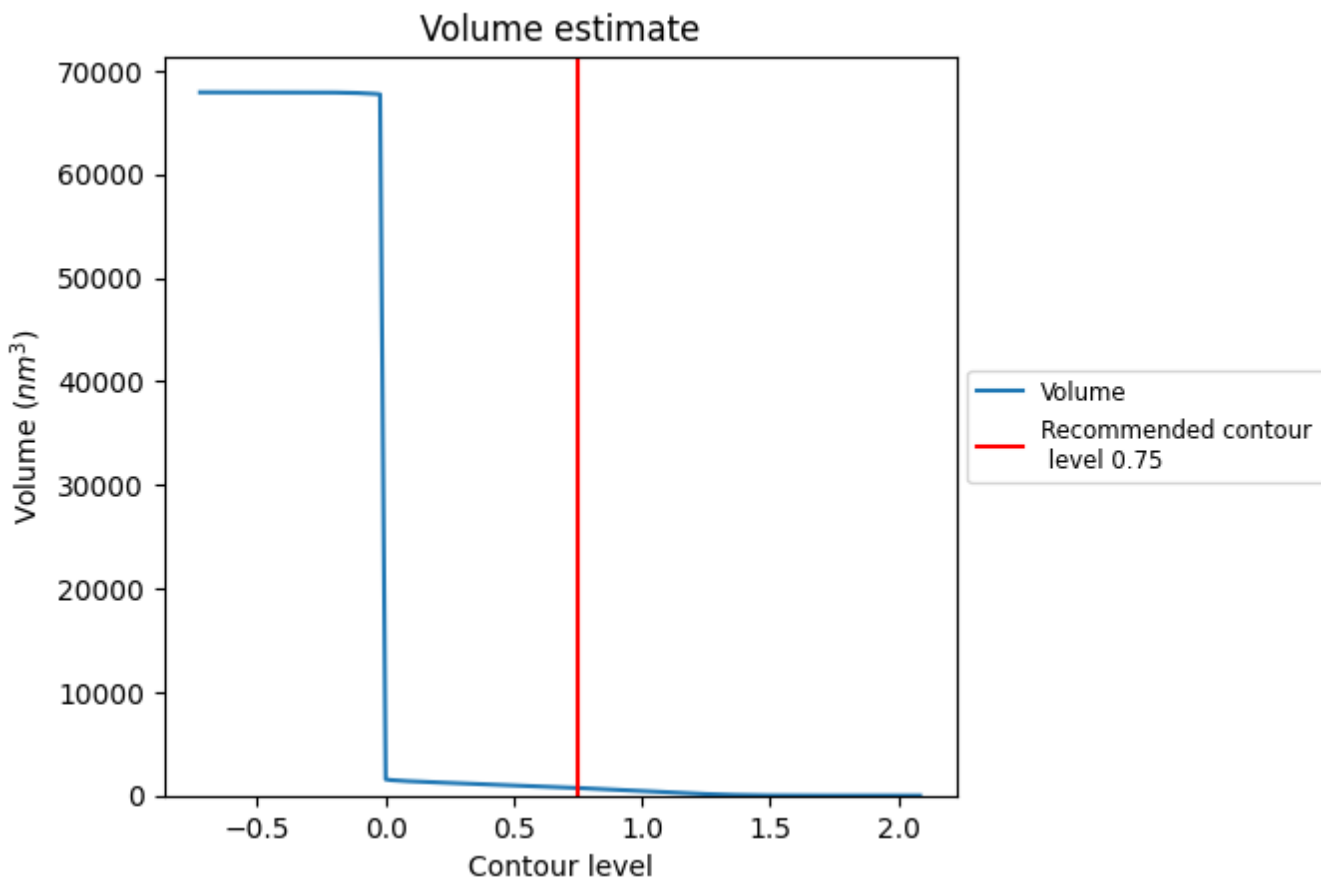

The volume at the recommended contour level is 733 nm<sup>3</sup>; this corresponds to an approximate mass of 662 kDa.

The volume estimate graph shows how the enclosed volume varies with the contour level. The recommended contour level is shown as a vertical line and the intersection between the line and the curve gives the volume of the enclosed surface at the given level.

### 7.3 Rotationally averaged power spectrum [i](#)

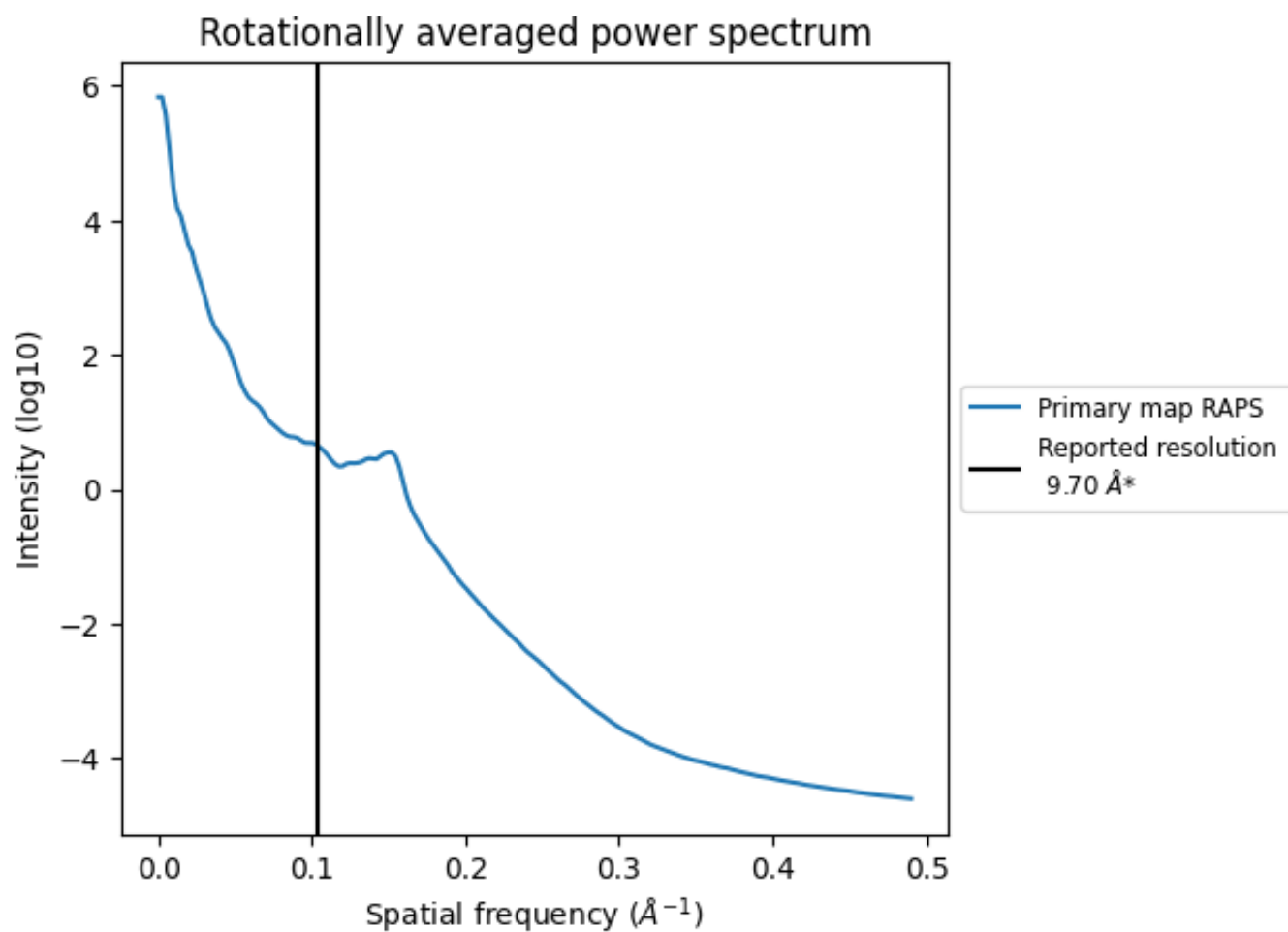

\*Reported resolution corresponds to spatial frequency of 0.103 Å<sup>-1</sup>

## 8 Fourier-Shell correlation

This section was not generated. No FSC curve or half-maps provided.

## 9 Map-model fit [i](#)

This section contains information regarding the fit between EMDB map EMD-30705 and PDB model 7DK7. Per-residue inclusion information can be found in section 3 on page 10.

### 9.1 Map-model overlay [i](#)

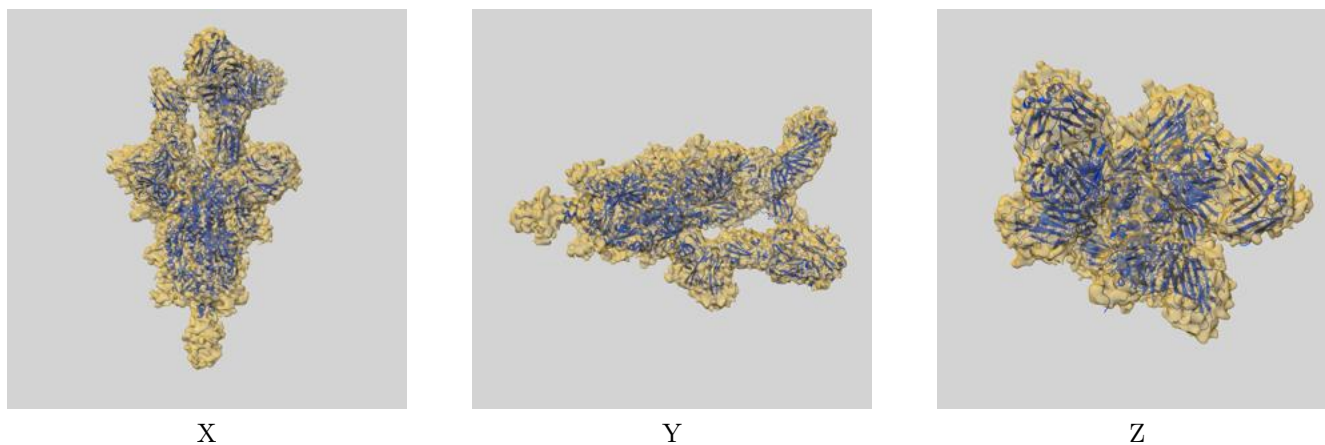

The images above show the 3D surface view of the map at the recommended contour level 0.75 at 50% transparency in yellow overlaid with a ribbon representation of the model coloured in blue. These images allow for the visual assessment of the quality of fit between the atomic model and the map.

## 9.2 Q-score mapped to coordinate model [\(i\)](#)

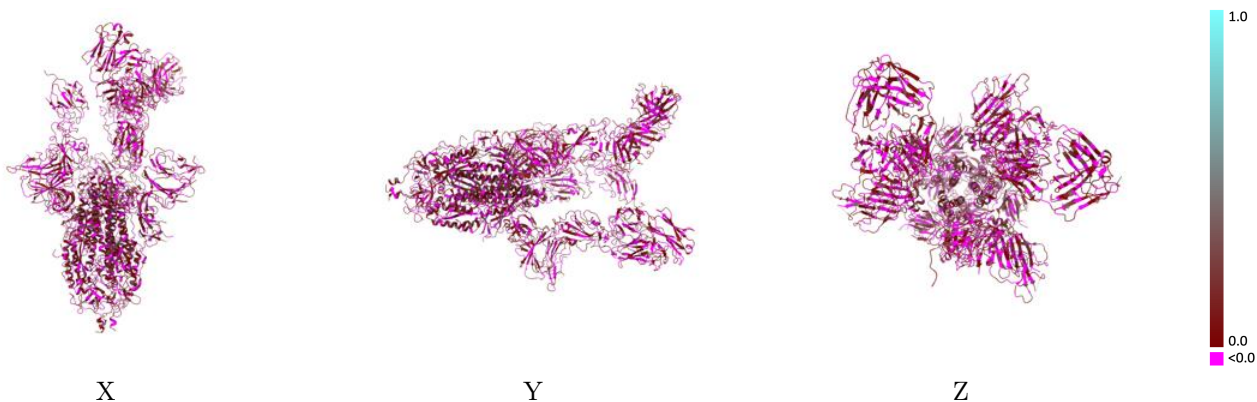

The images above show the model with each residue coloured according to its Q-score. This shows their resolvability in the map with higher Q-score values reflecting better resolvability. Please note: Q-score is calculating the resolvability of atoms, and thus high values are only expected at resolutions at which atoms can be resolved. Low Q-score values may therefore be expected for many entries.

## 9.3 Atom inclusion mapped to coordinate model [\(i\)](#)

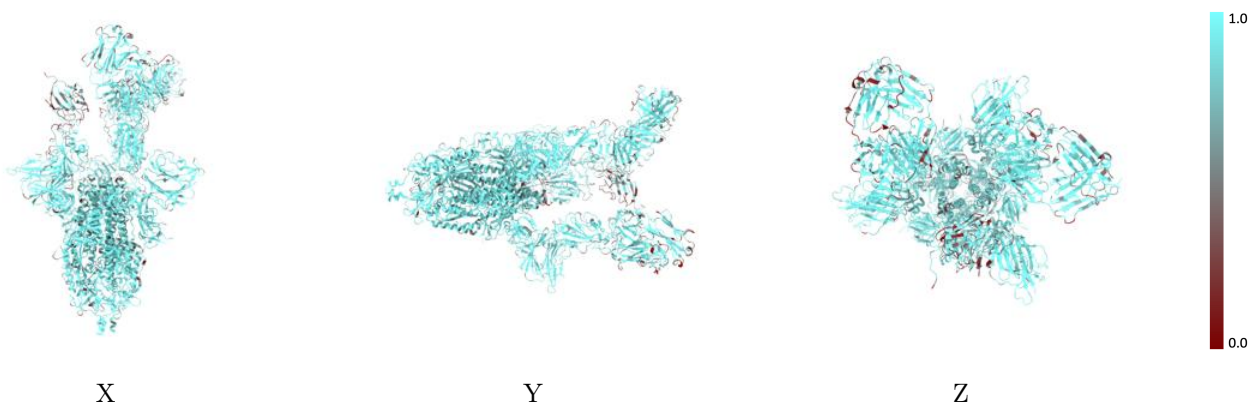

The images above show the model with each residue coloured according to its atom inclusion. This shows to what extent they are inside the map at the recommended contour level (0.75).

## 9.4 Atom inclusion [i](#)

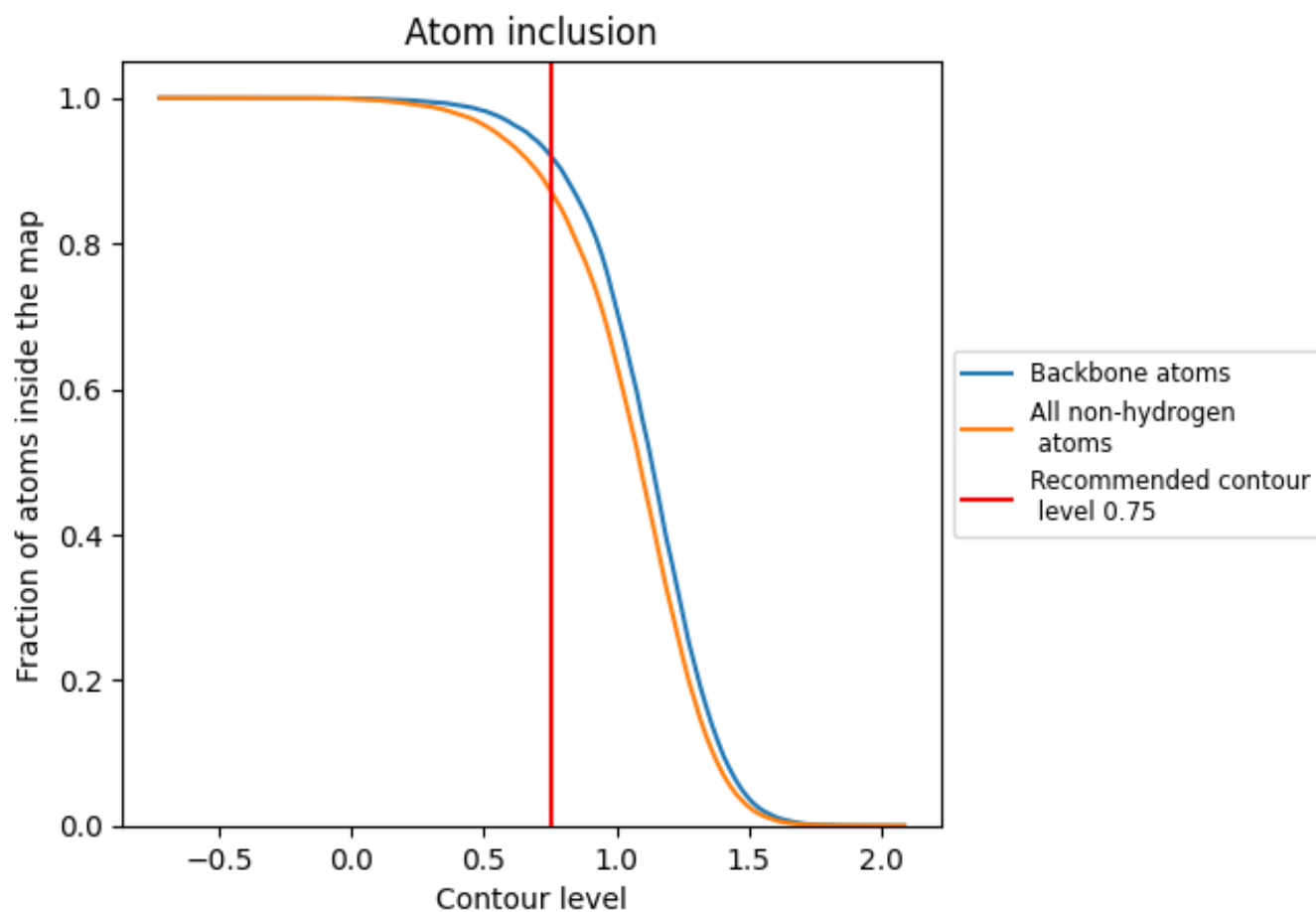





















At the recommended contour level, 92% of all backbone atoms, 87% of all non-hydrogen atoms, are inside the map.



## 9.5 Map-model fit summary

The table lists the average atom inclusion at the recommended contour level (0.75) and Q-score for the entire model and for each chain.

Chain	Atom inclusion	Q-score
All	 0.8734	 0.0660
A	 0.9104	 0.0790
B	 0.9079	 0.0750
C	 0.8780	 0.0590
a	 0.8308	 0.0470
b	 0.7943	 0.0360
c	 0.8333	 0.0520
d	 0.8721	 0.0620
e	 0.4074	 0.0240
f	 0.5400	 0.0550

