



Full wwPDB X-ray Structure Validation Report ⓘ

Sep 18, 2023 – 05:37 PM EDT

PDB ID : 5DQL
Title : Crystal Structure of 2-vinyl glyoxylate modified isocitrate lyase from Mycobacterium tuberculosis
Authors : Huang, H.-L.; Meek, T.D.
Deposited on : 2015-09-14
Resolution : 1.78 Å(reported)

This is a Full wwPDB X-ray Structure Validation Report for a publicly released PDB entry.

We welcome your comments at validation@mail.wwpdb.org

A user guide is available at

<https://www.wwpdb.org/validation/2017/XrayValidationReportHelp>

with specific help available everywhere you see the ⓘ symbol.

The types of validation reports are described at

<http://www.wwpdb.org/validation/2017/FAQs#types>.

The following versions of software and data (see [references ⓘ](#)) were used in the production of this report:

MolProbity : 4.02b-467
Mogul : 1.8.5 (274361), CSD as541be (2020)
Xtriage (Phenix) : 1.13
EDS : 2.35.1
Percentile statistics : 20191225.v01 (using entries in the PDB archive December 25th 2019)
Refmac : 5.8.0158
CCP4 : 7.0.044 (Gargrove)
Ideal geometry (proteins) : Engh & Huber (2001)
Ideal geometry (DNA, RNA) : Parkinson et al. (1996)
Validation Pipeline (wwPDB-VP) : 2.35.1

1 Overall quality at a glance

The following experimental techniques were used to determine the structure:

X-RAY DIFFRACTION

The reported resolution of this entry is 1.78 Å.

Percentile scores (ranging between 0-100) for global validation metrics of the entry are shown in the following graphic. The table shows the number of entries on which the scores are based.

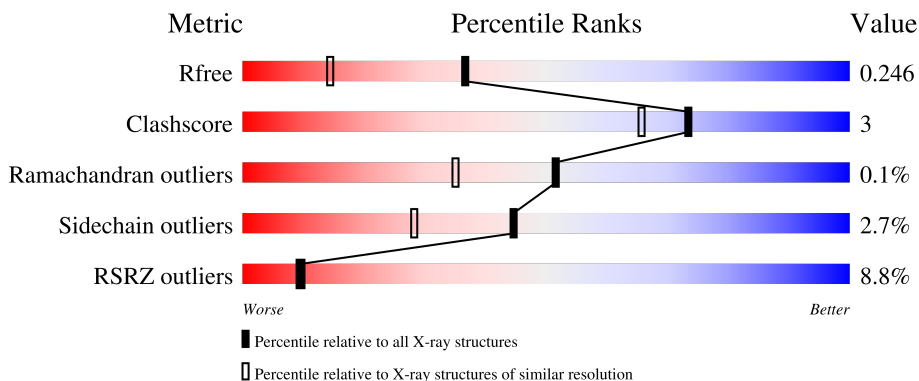

Metric	Whole archive (#Entries)	Similar resolution (#Entries, resolution range(Å))
R_{free}	130704	9185 (1.80-1.76)
Clashscore	141614	10184 (1.80-1.76)
Ramachandran outliers	138981	10051 (1.80-1.76)
Sidechain outliers	138945	10050 (1.80-1.76)
RSRZ outliers	127900	9032 (1.80-1.76)

The table below summarises the geometric issues observed across the polymeric chains and their fit to the electron density. The red, orange, yellow and green segments of the lower bar indicate the fraction of residues that contain outliers for ≥ 3 , 2, 1 and 0 types of geometric quality criteria respectively. A grey segment represents the fraction of residues that are not modelled. The numeric value for each fraction is indicated below the corresponding segment, with a dot representing fractions $\leq 5\%$. The upper red bar (where present) indicates the fraction of residues that have poor fit to the electron density. The numeric value is given above the bar.

Mol	Chain	Length	Quality of chain
1	A	428	
1	B	428	
1	C	428	
1	D	428	

The following table lists non-polymeric compounds, carbohydrate monomers and non-standard

residues in protein, DNA, RNA chains that are outliers for geometric or electron-density-fit criteria:

Mol	Type	Chain	Res	Chirality	Geometry	Clashes	Electron density
3	VGX	A	503	-	X	-	-
3	VGX	B	502	-	X	-	-

2 Entry composition [i](#)

There are 4 unique types of molecules in this entry. The entry contains 14521 atoms, of which 0 are hydrogens and 0 are deuteriums.

In the tables below, the ZeroOcc column contains the number of atoms modelled with zero occupancy, the AltConf column contains the number of residues with at least one atom in alternate conformation and the Trace column contains the number of residues modelled with at most 2 atoms.

- Molecule 1 is a protein called Isocitrate lyase 1.

Mol	Chain	Residues	Atoms					ZeroOcc	AltConf	Trace
			Total	C	N	O	S			
1	A	427	3308	2078	575	646	9	1	0	0
1	B	427	3308	2078	575	646	9	2	0	0
1	C	427	3324	2088	581	646	9	2	2	0
1	D	427	3308	2078	575	646	9	0	0	0

- Molecule 2 is MAGNESIUM ION (three-letter code: MG) (formula: Mg).

Mol	Chain	Residues	Atoms		ZeroOcc	AltConf
2	A	2	Total	Mg	0	0
			2	2		
2	B	1	Total	Mg	0	0
			1	1		
2	C	1	Total	Mg	0	0
			1	1		
2	D	1	Total	Mg	0	0
			1	1		

- Molecule 3 is 4-hydroxy-2-oxobutanoic acid (three-letter code: VGX) (formula: C₄H₆O₄).

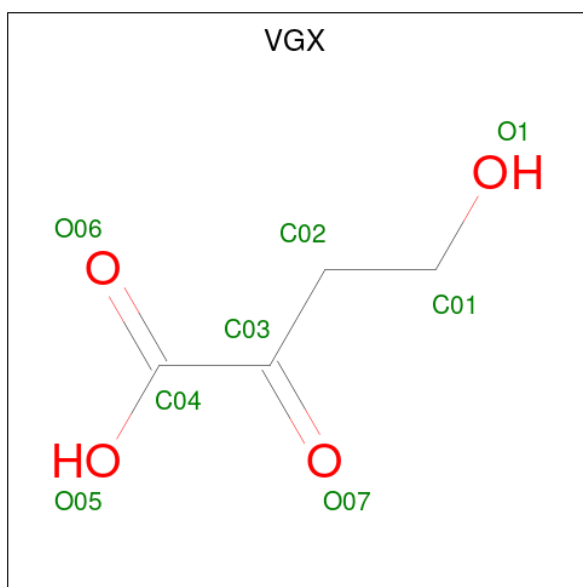

Mol	Chain	Residues	Atoms	ZeroOcc	AltConf
3	A	1	Total C O 7 4 3	0	0
3	B	1	Total C O 7 4 3	0	0
3	C	1	Total C O 7 4 3	1	0
3	D	1	Total C O 7 4 3	1	0

- Molecule 4 is water.

Mol	Chain	Residues	Atoms	ZeroOcc	AltConf
4	A	330	Total O 330 330	0	0
4	B	332	Total O 332 332	0	0
4	C	298	Total O 298 298	0	0
4	D	280	Total O 280 280	0	0

3 Residue-property plots [i](#)

These plots are drawn for all protein, RNA, DNA and oligosaccharide chains in the entry. The first graphic for a chain summarises the proportions of the various outlier classes displayed in the second graphic. The second graphic shows the sequence view annotated by issues in geometry and electron density. Residues are color-coded according to the number of geometric quality criteria for which they contain at least one outlier: green = 0, yellow = 1, orange = 2 and red = 3 or more. A red dot above a residue indicates a poor fit to the electron density ($RSRZ > 2$). Stretches of 2 or more consecutive residues without any outlier are shown as a green connector. Residues present in the sample, but not in the model, are shown in grey.

- Molecule 1: Isocitrate lyase 1

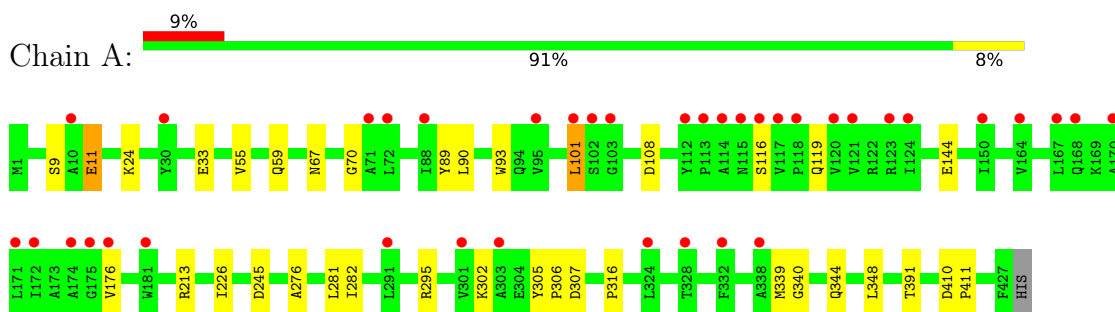

- Molecule 1: Isocitrate lyase 1

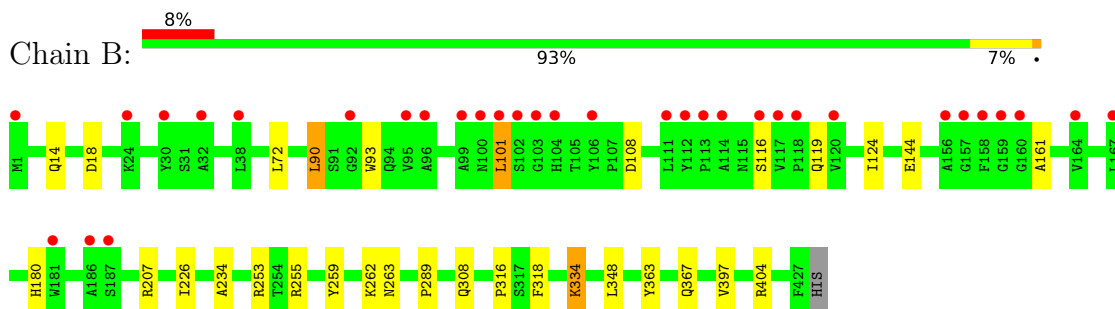

- Molecule 1: Isocitrate lyase 1

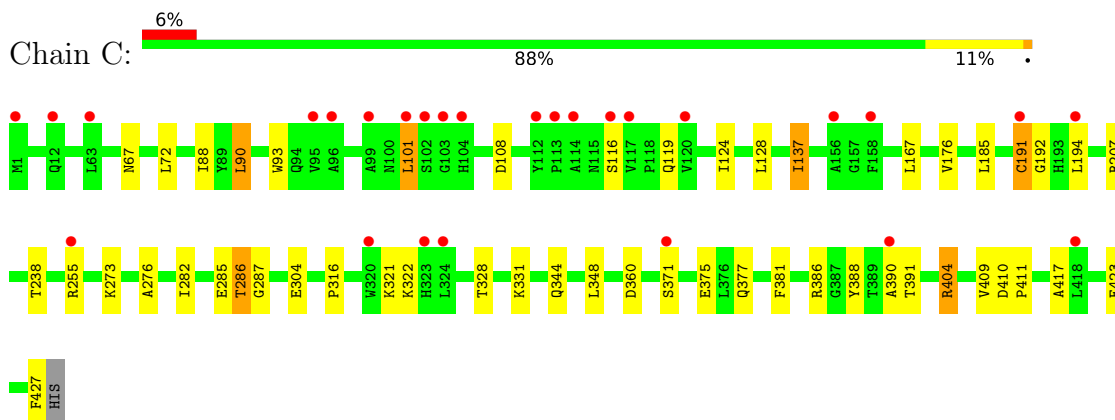

- Molecule 1: Isocitrate lyase 1

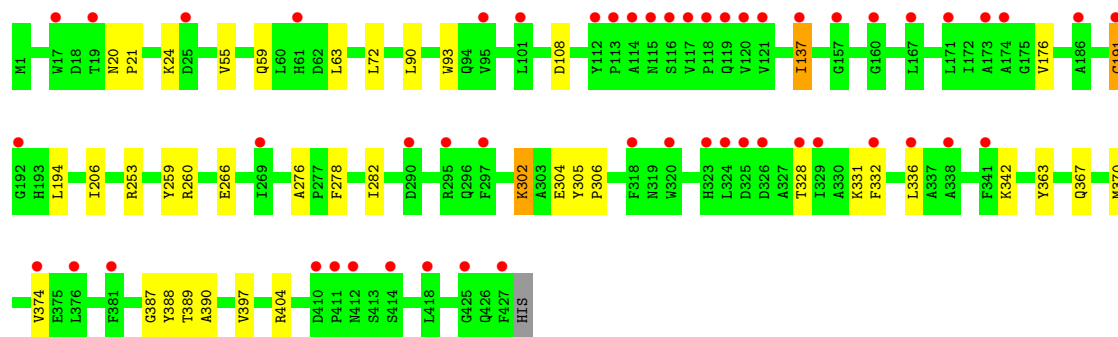
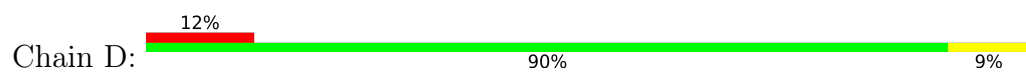

4 Data and refinement statistics

Property	Value	Source
Space group	P 21 21 21	Depositor
Cell constants a, b, c, α , β , γ	75.09Å 129.24Å 167.95Å 90.00° 90.00° 90.00°	Depositor
Resolution (Å)	34.27 – 1.78 42.31 – 1.78	Depositor EDS
% Data completeness (in resolution range)	99.4 (34.27-1.78) 99.3 (42.31-1.78)	Depositor EDS
R_{merge}	(Not available)	Depositor
R_{sym}	0.04	Depositor
$\langle I/\sigma(I) \rangle$ ¹	1.02 (at 1.78Å)	Xtrriage
Refinement program	PHENIX 1.8.2_1309	Depositor
R, R_{free}	0.203 , 0.246 0.203 , 0.246	Depositor DCC
R_{free} test set	7794 reflections (5.03%)	wwPDB-VP
Wilson B-factor (Å ²)	34.6	Xtrriage
Anisotropy	0.172	Xtrriage
Bulk solvent k_{sol} (e/Å ³), B_{sol} (Å ²)	0.28 , 32.2	EDS
L-test for twinning ²	$\langle L \rangle = 0.49$, $\langle L^2 \rangle = 0.32$	Xtrriage
Estimated twinning fraction	No twinning to report.	Xtrriage
F_o, F_c correlation	0.96	EDS
Total number of atoms	14521	wwPDB-VP
Average B, all atoms (Å ²)	32.0	wwPDB-VP

Xtrriage's analysis on translational NCS is as follows: *The largest off-origin peak in the Patterson function is 2.96% of the height of the origin peak. No significant pseudotranslation is detected.*

¹Intensities estimated from amplitudes.

²Theoretical values of $\langle |L| \rangle$, $\langle L^2 \rangle$ for acentric reflections are 0.5, 0.333 respectively for untwinned datasets, and 0.375, 0.2 for perfectly twinned datasets.

5 Model quality [i](#)

5.1 Standard geometry [i](#)

Bond lengths and bond angles in the following residue types are not validated in this section: MG, VGX

The Z score for a bond length (or angle) is the number of standard deviations the observed value is removed from the expected value. A bond length (or angle) with $|Z| > 5$ is considered an outlier worth inspection. RMSZ is the root-mean-square of all Z scores of the bond lengths (or angles).

Mol	Chain	Bond lengths		Bond angles	
		RMSZ	# Z >5	RMSZ	# Z >5
1	A	0.40	0/3379	0.54	0/4595
1	B	0.41	0/3379	0.57	0/4595
1	C	0.40	0/3401	0.54	0/4623
1	D	0.38	0/3379	0.53	0/4595
All	All	0.40	0/13538	0.55	0/18408

There are no bond length outliers.

There are no bond angle outliers.

There are no chirality outliers.

There are no planarity outliers.

5.2 Too-close contacts [i](#)

In the following table, the Non-H and H(model) columns list the number of non-hydrogen atoms and hydrogen atoms in the chain respectively. The H(added) column lists the number of hydrogen atoms added and optimized by MolProbity. The Clashes column lists the number of clashes within the asymmetric unit, whereas Symm-Clashes lists symmetry-related clashes.

Mol	Chain	Non-H	H(model)	H(added)	Clashes	Symm-Clashes
1	A	3308	0	3188	19	0
1	B	3308	0	3189	19	0
1	C	3324	0	3215	28	0
1	D	3308	0	3189	24	0
2	A	2	0	0	0	0
2	B	1	0	0	0	0
2	C	1	0	0	0	0
2	D	1	0	0	0	0
3	A	7	0	0	1	0

Continued on next page...

Continued from previous page...

Mol	Chain	Non-H	H(model)	H(added)	Clashes	Symm-Clashes
3	B	7	0	0	1	0
3	C	7	0	0	0	0
3	D	7	0	0	0	0
4	A	330	0	0	1	0
4	B	332	0	0	4	0
4	C	298	0	0	5	0
4	D	280	0	0	4	0
All	All	14521	0	12781	87	0

The all-atom clashscore is defined as the number of clashes found per 1000 atoms (including hydrogen atoms). The all-atom clashscore for this structure is 3.

All (87) close contacts within the same asymmetric unit are listed below, sorted by their clash magnitude.

Atom-1	Atom-2	Interatomic distance (Å)	Clash overlap (Å)
1:C:417:ALA:HB1	1:D:194:LEU:HD13	1.75	0.69
1:C:388:TYR:CZ	1:C:390:ALA:HB3	2.33	0.64
1:A:226:ILE:HG12	1:A:281:LEU:HB2	1.78	0.64
1:C:286:THR:HG21	4:C:737:HOH:O	2.00	0.61
1:A:101:LEU:HD22	1:A:116:SER:HA	1.82	0.61
1:A:276:ALA:HA	1:A:282:ILE:HD11	1.83	0.60
1:B:207:ARG:NH1	4:B:606:HOH:O	2.33	0.60
1:D:302:LYS:NZ	4:D:608:HOH:O	2.35	0.59
1:B:253:ARG:HD3	1:B:259:TYR:CZ	2.37	0.59
1:B:404:ARG:NH1	4:B:602:HOH:O	2.24	0.59
1:D:276:ALA:O	4:D:601:HOH:O	2.17	0.58
1:C:328:THR:HA	1:C:331:LYS:HG2	1.87	0.56
1:C:276:ALA:HA	1:C:282:ILE:HD11	1.88	0.55
1:A:101:LEU:HD21	1:A:119:GLN:HG3	1.88	0.55
1:C:93:TRP:CD1	1:C:108:ASP:HB2	2.43	0.54
1:C:101:LEU:HD22	1:C:116:SER:HA	1.89	0.53
1:C:371:SER:O	1:C:375:GLU:HG3	2.08	0.52
1:B:316:PRO:HG2	1:B:348:LEU:HB2	1.91	0.52
1:A:24:LYS:NZ	1:A:307:ASP:OD2	2.40	0.52
1:A:302:LYS:HD3	1:A:306:PRO:O	2.10	0.52
1:B:101:LEU:HD22	1:B:116:SER:HA	1.92	0.52
4:B:605:HOH:O	1:C:404[B]:ARG:NH2	2.42	0.51
1:D:276:ALA:HA	1:D:282:ILE:HD11	1.94	0.50
1:D:93:TRP:CD1	1:D:108:ASP:HB2	2.47	0.49
1:C:207[B]:ARG:NH1	4:C:614:HOH:O	2.46	0.49
1:C:191:CYS:HB3	1:C:194:LEU:HD12	1.94	0.49

Continued on next page...

Continued from previous page...

Atom-1	Atom-2	Interatomic distance (Å)	Clash overlap (Å)
1:C:90:LEU:HD22	1:C:124:ILE:HD12	1.93	0.48
1:B:289:PRO:HD3	1:B:318:PHE:CG	2.49	0.48
1:A:67:ASN:HA	1:A:344:GLN:O	2.13	0.48
1:A:302:LYS:NZ	1:A:340:GLY:HA3	2.29	0.48
1:B:308:GLN:NE2	4:B:601:HOH:O	2.14	0.47
1:C:286:THR:HG22	1:C:287:GLY:H	1.80	0.47
1:B:90:LEU:HD22	1:B:124:ILE:HD12	1.97	0.47
1:B:363:TYR:O	1:B:367:GLN:HG2	2.16	0.46
1:A:70:GLY:HA2	1:A:89:TYR:O	2.16	0.46
1:B:101:LEU:HD21	1:B:119:GLN:HG3	1.98	0.46
1:C:137:ILE:HD12	1:C:137:ILE:HA	1.66	0.46
1:D:137:ILE:HD11	1:D:404:ARG:HG2	1.98	0.46
1:A:302:LYS:HA	1:A:305:TYR:O	2.16	0.45
1:C:316:PRO:HG2	1:C:348:LEU:HB2	1.98	0.45
1:B:234:ALA:O	1:B:263:ASN:HB3	2.16	0.45
1:D:328:THR:HA	1:D:331:LYS:HG2	1.99	0.45
1:A:93:TRP:CD1	1:A:108:ASP:HB2	2.52	0.45
1:B:348:LEU:HD11	3:B:502:VGX:O07	2.17	0.45
1:C:192:GLY:HA3	1:C:285:GLU:HG2	1.99	0.45
1:D:388:TYR:CZ	1:D:390:ALA:HB3	2.51	0.45
1:D:363:TYR:O	1:D:367:GLN:HG2	2.17	0.44
1:D:59:GLN:O	1:D:63:LEU:HB2	2.17	0.44
1:D:260:ARG:HD3	4:D:828:HOH:O	2.16	0.44
1:B:334:LYS:H	1:B:334:LYS:HG2	1.54	0.44
1:D:370:MET:O	1:D:374:VAL:HG23	2.18	0.44
1:D:55:VAL:O	1:D:59:GLN:HG3	2.18	0.44
1:D:59:GLN:HA	1:D:63:LEU:HD23	2.00	0.44
1:B:180:HIS:HB3	1:B:226:ILE:HB	2.00	0.44
1:A:245:ASP:OD1	4:A:601:HOH:O	2.21	0.43
1:A:302:LYS:HZ3	1:A:340:GLY:HA3	1.83	0.43
1:A:316:PRO:HG2	1:A:348:LEU:HB2	2.00	0.43
1:C:360:ASP:C	4:C:620:HOH:O	2.56	0.43
1:C:119:GLN:NE2	4:C:608:HOH:O	2.38	0.43
1:C:377:GLN:HG2	1:C:381:PHE:CE2	2.54	0.43
1:B:93:TRP:CD1	1:B:108:ASP:HB2	2.54	0.42
1:B:207:ARG:HG2	1:C:409:VAL:HG12	2.00	0.42
1:C:386:ARG:HD2	1:D:363:TYR:CE2	2.53	0.42
1:D:108:ASP:HB3	1:D:191:CYS:HB3	2.01	0.42
1:A:295:ARG:CZ	1:A:339:MET:HE2	2.49	0.42
1:C:423:GLU:O	1:C:427:PHE:HB2	2.19	0.42
1:D:20:ASN:HA	1:D:21:PRO:HD2	1.91	0.42

Continued on next page...

Continued from previous page...

Atom-1	Atom-2	Interatomic distance (Å)	Clash overlap (Å)
1:A:9:SER:OG	1:A:11:GLU:HG2	2.19	0.42
1:A:55:VAL:O	1:A:59:GLN:HG3	2.19	0.42
1:C:67:ASN:HA	1:C:344:GLN:O	2.19	0.42
1:C:410:ASP:HA	1:C:411:PRO:HD2	1.87	0.42
1:C:273:LYS:HE2	1:C:304:GLU:HG3	2.02	0.42
1:D:206:ILE:HD12	1:D:278:PHE:CD2	2.54	0.42
1:D:266:GLU:HB2	4:D:757:HOH:O	2.20	0.42
1:A:348:LEU:HD11	3:A:503:VGX:O07	2.20	0.41
1:D:387:GLY:O	1:D:389:THR:HG23	2.20	0.41
1:D:253:ARG:HD3	1:D:259:TYR:CE2	2.55	0.41
1:D:342:LYS:HA	1:D:342:LYS:HD2	1.91	0.41
1:B:14:GLN:HG3	1:B:18:ASP:OD2	2.21	0.41
1:B:262:LYS:HE3	1:B:262:LYS:HB2	1.87	0.41
1:B:161:ALA:HB2	1:B:207:ARG:HD2	2.03	0.41
1:C:276:ALA:O	4:C:601:HOH:O	2.22	0.41
1:A:410:ASP:HA	1:A:411:PRO:HD2	1.87	0.40
1:C:185:LEU:HD13	1:C:238:THR:HG21	2.03	0.40
1:D:305:TYR:HA	1:D:306:PRO:HD2	1.85	0.40
1:D:332:PHE:CE2	1:D:336:LEU:HD11	2.56	0.40
1:C:88:ILE:CD1	1:C:128:LEU:HD11	2.52	0.40

There are no symmetry-related clashes.

5.3 Torsion angles [i](#)

5.3.1 Protein backbone [i](#)

In the following table, the Percentiles column shows the percent Ramachandran outliers of the chain as a percentile score with respect to all X-ray entries followed by that with respect to entries of similar resolution.

The Analysed column shows the number of residues for which the backbone conformation was analysed, and the total number of residues.

Mol	Chain	Analysed	Favoured	Allowed	Outliers	Percentiles	
1	A	425/428 (99%)	417 (98%)	8 (2%)	0	100	100
1	B	425/428 (99%)	418 (98%)	7 (2%)	0	100	100
1	C	427/428 (100%)	415 (97%)	12 (3%)	0	100	100
1	D	425/428 (99%)	414 (97%)	10 (2%)	1 (0%)	47	32
All	All	1702/1712 (99%)	1664 (98%)	37 (2%)	1 (0%)	51	35

All (1) Ramachandran outliers are listed below:

Mol	Chain	Res	Type
1	D	24	LYS

5.3.2 Protein sidechains [i](#)

In the following table, the Percentiles column shows the percent sidechain outliers of the chain as a percentile score with respect to all X-ray entries followed by that with respect to entries of similar resolution.

The Analysed column shows the number of residues for which the sidechain conformation was analysed, and the total number of residues.

Mol	Chain	Analysed	Rotameric	Outliers	Percentiles	
1	A	337/339 (99%)	329 (98%)	8 (2%)	49	33
1	B	337/339 (99%)	330 (98%)	7 (2%)	53	38
1	C	339/339 (100%)	325 (96%)	14 (4%)	30	14
1	D	337/339 (99%)	329 (98%)	8 (2%)	49	33
All	All	1350/1356 (100%)	1313 (97%)	37 (3%)	44	28

All (37) residues with a non-rotameric sidechain are listed below:

Mol	Chain	Res	Type
1	A	11	GLU
1	A	33	GLU
1	A	90	LEU
1	A	101	LEU
1	A	144	GLU
1	A	176	VAL
1	A	213	ARG
1	A	391	THR
1	B	72	LEU
1	B	90	LEU
1	B	101	LEU
1	B	144	GLU
1	B	255	ARG
1	B	334	LYS
1	B	397	VAL
1	C	72	LEU
1	C	90	LEU
1	C	101	LEU
1	C	137	ILE

Continued on next page...

Continued from previous page...

Mol	Chain	Res	Type
1	C	167	LEU
1	C	176	VAL
1	C	191	CYS
1	C	255	ARG
1	C	286	THR
1	C	321	LYS
1	C	322	LYS
1	C	391	THR
1	C	404[A]	ARG
1	C	404[B]	ARG
1	D	72	LEU
1	D	90	LEU
1	D	137	ILE
1	D	176	VAL
1	D	191	CYS
1	D	302	LYS
1	D	304	GLU
1	D	397	VAL

Sometimes sidechains can be flipped to improve hydrogen bonding and reduce clashes. There are no such sidechains identified.

5.3.3 RNA [i](#)

There are no RNA molecules in this entry.

5.4 Non-standard residues in protein, DNA, RNA chains [i](#)

There are no non-standard protein/DNA/RNA residues in this entry.

5.5 Carbohydrates [i](#)

There are no monosaccharides in this entry.

5.6 Ligand geometry [i](#)

Of 9 ligands modelled in this entry, 5 are monoatomic - leaving 4 for Mogul analysis.

In the following table, the Counts columns list the number of bonds (or angles) for which Mogul statistics could be retrieved, the number of bonds (or angles) that are observed in the model and

the number of bonds (or angles) that are defined in the Chemical Component Dictionary. The Link column lists molecule types, if any, to which the group is linked. The Z score for a bond length (or angle) is the number of standard deviations the observed value is removed from the expected value. A bond length (or angle) with $|Z| > 2$ is considered an outlier worth inspection. RMSZ is the root-mean-square of all Z scores of the bond lengths (or angles).

Mol	Type	Chain	Res	Link	Bond lengths			Bond angles		
					Counts	RMSZ	# Z > 2	Counts	RMSZ	# Z > 2
3	VGX	C	502	1	6,6,7	1.08	0	7,7,8	1.41	1 (14%)
3	VGX	D	502	1	6,6,7	1.08	0	7,7,8	1.40	1 (14%)
3	VGX	A	503	1	6,6,7	1.39	1 (16%)	7,7,8	2.29	2 (28%)
3	VGX	B	502	1	6,6,7	1.13	0	7,7,8	2.04	3 (42%)

In the following table, the Chirals column lists the number of chiral outliers, the number of chiral centers analysed, the number of these observed in the model and the number defined in the Chemical Component Dictionary. Similar counts are reported in the Torsion and Rings columns. '-' means no outliers of that kind were identified.

Mol	Type	Chain	Res	Link	Chirals	Torsions	Rings
3	VGX	C	502	1	-	5/6/6/7	-
3	VGX	D	502	1	-	6/6/6/7	-
3	VGX	A	503	1	-	6/6/6/7	-
3	VGX	B	502	1	-	5/6/6/7	-

All (1) bond length outliers are listed below:

Mol	Chain	Res	Type	Atoms	Z	Observed(Å)	Ideal(Å)
3	A	503	VGX	C03-C04	-2.43	1.50	1.53

All (7) bond angle outliers are listed below:

Mol	Chain	Res	Type	Atoms	Z	Observed(°)	Ideal(°)
3	A	503	VGX	C01-C02-C03	-4.68	103.34	114.04
3	B	502	VGX	C01-C02-C03	-3.48	106.08	114.04
3	A	503	VGX	O06-C04-C03	-3.28	117.34	121.72
3	B	502	VGX	C02-C03-C04	2.78	121.54	116.25
3	B	502	VGX	O06-C04-C03	-2.28	118.68	121.72
3	C	502	VGX	O05-C04-C03	2.23	120.06	113.97
3	D	502	VGX	O05-C04-C03	2.21	120.01	113.97

There are no chirality outliers.

All (22) torsion outliers are listed below:

Mol	Chain	Res	Type	Atoms
3	A	503	VGX	C02-C03-C04-O05
3	A	503	VGX	O07-C03-C04-O05
3	A	503	VGX	O07-C03-C04-O06
3	B	502	VGX	C02-C03-C04-O05
3	B	502	VGX	O07-C03-C04-O06
3	C	502	VGX	C01-C02-C03-C04
3	C	502	VGX	C01-C02-C03-O07
3	C	502	VGX	C02-C03-C04-O05
3	C	502	VGX	C02-C03-C04-O06
3	C	502	VGX	O07-C03-C04-O06
3	D	502	VGX	C01-C02-C03-C04
3	D	502	VGX	C01-C02-C03-O07
3	D	502	VGX	C02-C03-C04-O05
3	D	502	VGX	C02-C03-C04-O06
3	D	502	VGX	O07-C03-C04-O05
3	D	502	VGX	O07-C03-C04-O06
3	A	503	VGX	C02-C03-C04-O06
3	B	502	VGX	C02-C03-C04-O06
3	A	503	VGX	C01-C02-C03-C04
3	A	503	VGX	C01-C02-C03-O07
3	B	502	VGX	C01-C02-C03-O07
3	B	502	VGX	C01-C02-C03-C04

There are no ring outliers.

2 monomers are involved in 2 short contacts:

Mol	Chain	Res	Type	Clashes	Symm-Clashes
3	A	503	VGX	1	0
3	B	502	VGX	1	0

5.7 Other polymers [i](#)

There are no such residues in this entry.

5.8 Polymer linkage issues [i](#)

There are no chain breaks in this entry.

6 Fit of model and data [i](#)

6.1 Protein, DNA and RNA chains [i](#)

In the following table, the column labelled ‘#RSRZ> 2’ contains the number (and percentage) of RSRZ outliers, followed by percent RSRZ outliers for the chain as percentile scores relative to all X-ray entries and entries of similar resolution. The OWAB column contains the minimum, median, 95th percentile and maximum values of the occupancy-weighted average B-factor per residue. The column labelled ‘Q< 0.9’ lists the number of (and percentage) of residues with an average occupancy less than 0.9.

Mol	Chain	Analysed	<RSRZ>	#RSRZ>2	OWAB(Å ²)	Q<0.9
1	A	427/428 (99%)	0.56	38 (8%) 9 9	16, 29, 43, 52	4 (0%)
1	B	427/428 (99%)	0.47	33 (7%) 13 13	15, 29, 42, 52	8 (1%)
1	C	427/428 (99%)	0.50	27 (6%) 20 19	17, 30, 47, 56	5 (1%)
1	D	427/428 (99%)	0.80	52 (12%) 4 4	18, 34, 51, 61	3 (0%)
All	All	1708/1712 (99%)	0.58	150 (8%) 10 9	15, 30, 47, 61	20 (1%)

All (150) RSRZ outliers are listed below:

Mol	Chain	Res	Type	RSRZ
1	B	101	LEU	6.3
1	D	101	LEU	5.2
1	C	101	LEU	4.7
1	A	101	LEU	4.7
1	D	117	VAL	4.7
1	B	158	PHE	4.3
1	B	1	MET	4.3
1	A	171	LEU	4.1
1	A	120	VAL	4.1
1	D	114	ALA	4.0
1	D	121	VAL	4.0
1	D	414	SER	3.9
1	B	111	LEU	3.8
1	B	112	TYR	3.7
1	D	112	TYR	3.7
1	A	176	VAL	3.7
1	D	425	GLY	3.6
1	B	113	PRO	3.6
1	A	124	ILE	3.6
1	D	118	PRO	3.5
1	D	171	LEU	3.5

Continued on next page...

Continued from previous page...

Mol	Chain	Res	Type	RSRZ
1	A	172	ILE	3.5
1	C	194	LEU	3.5
1	C	103	GLY	3.5
1	A	170	ALA	3.5
1	B	102	SER	3.5
1	B	99	ALA	3.4
1	C	323	HIS	3.4
1	D	318	PHE	3.4
1	A	167	LEU	3.4
1	D	323	HIS	3.3
1	A	121	VAL	3.3
1	C	324	LEU	3.3
1	D	95	VAL	3.3
1	D	412	ASN	3.3
1	D	381	PHE	3.3
1	D	328	THR	3.3
1	D	115	ASN	3.3
1	A	117	VAL	3.2
1	B	167	LEU	3.2
1	C	102	SER	3.2
1	D	297	PHE	3.2
1	C	1	MET	3.1
1	B	156	ALA	3.1
1	B	103	GLY	3.1
1	B	106	TYR	3.1
1	B	95	VAL	3.1
1	B	120	VAL	3.1
1	D	116	SER	3.0
1	B	117	VAL	3.0
1	D	418	LEU	3.0
1	B	96	ALA	2.9
1	A	30	TYR	2.9
1	B	160	GLY	2.9
1	A	150	ILE	2.9
1	A	95	VAL	2.8
1	B	159	GLY	2.8
1	B	157	GLY	2.8
1	C	120	VAL	2.8
1	B	114	ALA	2.8
1	D	173	ALA	2.8
1	A	174	ALA	2.8
1	A	328	THR	2.7

Continued on next page...

Continued from previous page...

Mol	Chain	Res	Type	RSRZ
1	D	336	LEU	2.7
1	C	113	PRO	2.7
1	D	113	PRO	2.7
1	D	120	VAL	2.7
1	D	186	ALA	2.7
1	D	295	ARG	2.7
1	B	100	ASN	2.6
1	D	324	LEU	2.6
1	A	113	PRO	2.6
1	D	19	THR	2.6
1	D	320	TRP	2.6
1	D	427	PHE	2.6
1	C	95	VAL	2.6
1	A	114	ALA	2.6
1	B	181	TRP	2.6
1	B	116	SER	2.6
1	B	164	VAL	2.5
1	A	118	PRO	2.5
1	C	116	SER	2.5
1	A	303	ALA	2.5
1	A	332	PHE	2.5
1	B	92	GLY	2.5
1	A	10	ALA	2.5
1	C	96	ALA	2.5
1	D	341	PHE	2.5
1	A	115	ASN	2.4
1	A	324	LEU	2.4
1	D	167	LEU	2.4
1	A	181	TRP	2.4
1	C	191	CYS	2.4
1	D	174	ALA	2.4
1	A	116	SER	2.4
1	B	32	ALA	2.4
1	A	72	LEU	2.4
1	D	269	ILE	2.4
1	D	376	LEU	2.4
1	C	320	TRP	2.4
1	D	329	ILE	2.3
1	A	338	ALA	2.3
1	D	332	PHE	2.3
1	A	71	ALA	2.3
1	A	123	ARG	2.3

Continued on next page...

Continued from previous page...

Mol	Chain	Res	Type	RSRZ
1	C	255	ARG	2.3
1	B	187	SER	2.3
1	C	112	TYR	2.3
1	D	326	ASP	2.3
1	C	156	ALA	2.2
1	A	102	SER	2.2
1	C	371	SER	2.2
1	A	164	VAL	2.2
1	C	117	VAL	2.2
1	D	137	ILE	2.2
1	B	118	PRO	2.2
1	D	411	PRO	2.2
1	C	12	GLN	2.2
1	A	175	GLY	2.2
1	D	192	GLY	2.2
1	C	114	ALA	2.2
1	A	301	VAL	2.2
1	D	374	VAL	2.2
1	A	168	GLN	2.2
1	C	63	LEU	2.2
1	D	119	GLN	2.2
1	D	157	GLY	2.2
1	D	160	GLY	2.2
1	D	290	ASP	2.2
1	C	99	ALA	2.2
1	D	25	ASP	2.1
1	A	88	ILE	2.1
1	D	61	HIS	2.1
1	D	410	ASP	2.1
1	B	38	LEU	2.1
1	C	158	PHE	2.1
1	C	418	LEU	2.1
1	A	103	GLY	2.1
1	B	30	TYR	2.1
1	B	24	LYS	2.1
1	B	186	ALA	2.1
1	D	17	TRP	2.1
1	C	390	ALA	2.0
1	A	291	LEU	2.0
1	B	104	HIS	2.0
1	C	104	HIS	2.0
1	D	191	CYS	2.0

Continued on next page...

Continued from previous page...

Mol	Chain	Res	Type	RSRZ
1	D	325	ASP	2.0
1	D	338	ALA	2.0
1	A	112	TYR	2.0

6.2 Non-standard residues in protein, DNA, RNA chains [i](#)

There are no non-standard protein/DNA/RNA residues in this entry.

6.3 Carbohydrates [i](#)

There are no monosaccharides in this entry.

6.4 Ligands [i](#)

In the following table, the Atoms column lists the number of modelled atoms in the group and the number defined in the chemical component dictionary. The B-factors column lists the minimum, median, 95th percentile and maximum values of B factors of atoms in the group. The column labelled 'Q< 0.9' lists the number of atoms with occupancy less than 0.9.

Mol	Type	Chain	Res	Atoms	RSCC	RSR	B-factors(Å ²)	Q<0.9
2	MG	D	501	1/1	0.77	0.08	45,45,45,45	0
2	MG	C	501	1/1	0.82	0.09	43,43,43,43	0
2	MG	A	501	1/1	0.84	0.11	40,40,40,40	0
3	VGX	D	502	7/8	0.85	0.13	25,32,35,39	1
2	MG	B	501	1/1	0.87	0.09	35,35,35,35	0
2	MG	A	502	1/1	0.90	0.05	37,37,37,37	0
3	VGX	C	502	7/8	0.94	0.18	22,31,31,33	2
3	VGX	A	503	7/8	0.96	0.12	23,26,28,29	3
3	VGX	B	502	7/8	0.98	0.11	24,24,27,27	2

6.5 Other polymers [i](#)

There are no such residues in this entry.