



Full wwPDB X-ray Structure Validation Report ⓘ

Mar 3, 2024 – 08:27 PM EST

PDB ID : 6DWV
Title : Crystal structure of the LigJ Hydratase in the Apo state
Authors : Mabanglo, M.F.; Raushel, F.M.
Deposited on : 2018-06-28
Resolution : 2.20 Å(reported)

This is a Full wwPDB X-ray Structure Validation Report for a publicly released PDB entry.

We welcome your comments at validation@mail.wwpdb.org

A user guide is available at

<https://www.wwpdb.org/validation/2017/XrayValidationReportHelp>

with specific help available everywhere you see the ⓘ symbol.

The types of validation reports are described at

<http://www.wwpdb.org/validation/2017/FAQs#types>.

The following versions of software and data (see [references ⓘ](#)) were used in the production of this report:

MolProbity : 4.02b-467
Xtriage (Phenix) : 1.13
EDS : 2.36
Percentile statistics : 20191225.v01 (using entries in the PDB archive December 25th 2019)
Refmac : 5.8.0158
CCP4 : 7.0.044 (Gargrove)
Ideal geometry (proteins) : Engh & Huber (2001)
Ideal geometry (DNA, RNA) : Parkinson et al. (1996)
Validation Pipeline (wwPDB-VP) : 2.36

1 Overall quality at a glance

The following experimental techniques were used to determine the structure:

X-RAY DIFFRACTION

The reported resolution of this entry is 2.20 Å.

Percentile scores (ranging between 0-100) for global validation metrics of the entry are shown in the following graphic. The table shows the number of entries on which the scores are based.

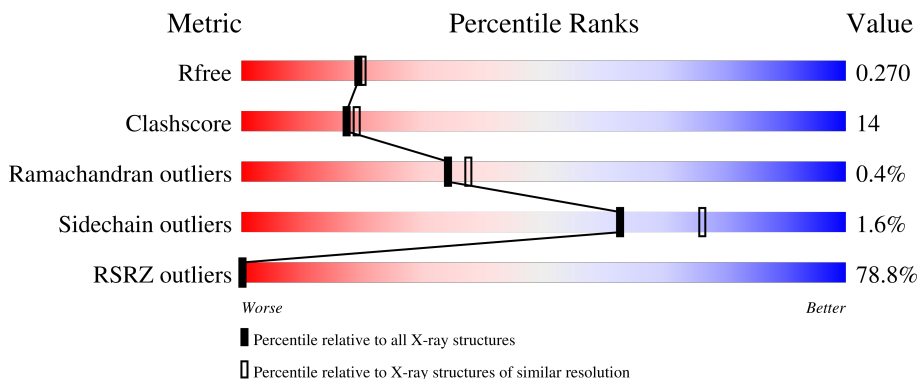

Metric	Whole archive (#Entries)	Similar resolution (#Entries, resolution range(Å))
R_{free}	130704	4898 (2.20-2.20)
Clashscore	141614	5594 (2.20-2.20)
Ramachandran outliers	138981	5503 (2.20-2.20)
Sidechain outliers	138945	5504 (2.20-2.20)
RSRZ outliers	127900	4800 (2.20-2.20)

The table below summarises the geometric issues observed across the polymeric chains and their fit to the electron density. The red, orange, yellow and green segments of the lower bar indicate the fraction of residues that contain outliers for ≥ 3 , 2, 1 and 0 types of geometric quality criteria respectively. A grey segment represents the fraction of residues that are not modelled. The numeric value for each fraction is indicated below the corresponding segment, with a dot representing fractions $\leq 5\%$. The upper red bar (where present) indicates the fraction of residues that have poor fit to the electron density. The numeric value is given above the bar.

Mol	Chain	Length	Quality of chain
1	A	341	
1	B	341	
1	C	341	
1	D	341	

The following table lists non-polymeric compounds, carbohydrate monomers and non-standard

residues in protein, DNA, RNA chains that are outliers for geometric or electron-density-fit criteria:

Mol	Type	Chain	Res	Chirality	Geometry	Clashes	Electron density
2	ZN	B	401	-	-	-	X

2 Entry composition [i](#)

There are 3 unique types of molecules in this entry. The entry contains 10970 atoms, of which 0 are hydrogens and 0 are deuteriums.

In the tables below, the ZeroOcc column contains the number of atoms modelled with zero occupancy, the AltConf column contains the number of residues with at least one atom in alternate conformation and the Trace column contains the number of residues modelled with at most 2 atoms.

- Molecule 1 is a protein called 4-oxalomesaconate hydratase.

Mol	Chain	Residues	Atoms					ZeroOcc	AltConf	Trace
			Total	C	N	O	S			
1	B	339	2658	1693	460	486	19	0	0	0
1	A	339	2658	1693	460	486	19	0	0	0
1	C	339	2658	1693	460	486	19	0	0	0
1	D	339	2658	1693	460	486	19	0	0	0

- Molecule 2 is ZINC ION (three-letter code: ZN) (formula: Zn).

Mol	Chain	Residues	Atoms		ZeroOcc	AltConf
2	B	1	Total	Zn	0	0
			1	1		
2	A	1	Total	Zn	0	0
			1	1		
2	C	1	Total	Zn	0	0
			1	1		
2	D	1	Total	Zn	0	0
			1	1		

- Molecule 3 is water.

Mol	Chain	Residues	Atoms		ZeroOcc	AltConf
3	B	103	Total	O	0	0
			103	103		
3	A	70	Total	O	0	0
			70	70		
3	C	87	Total	O	0	0
			87	87		
3	D	74	Total	O	0	0
			74	74		

3 Residue-property plots

These plots are drawn for all protein, RNA, DNA and oligosaccharide chains in the entry. The first graphic for a chain summarises the proportions of the various outlier classes displayed in the second graphic. The second graphic shows the sequence view annotated by issues in geometry and electron density. Residues are color-coded according to the number of geometric quality criteria for which they contain at least one outlier: green = 0, yellow = 1, orange = 2 and red = 3 or more. A red dot above a residue indicates a poor fit to the electron density ($RSRZ > 2$). Stretches of 2 or more consecutive residues without any outlier are shown as a green connector. Residues present in the sample, but not in the model, are shown in grey.

- Molecule 1: 4-oxalomesaconate hydratase

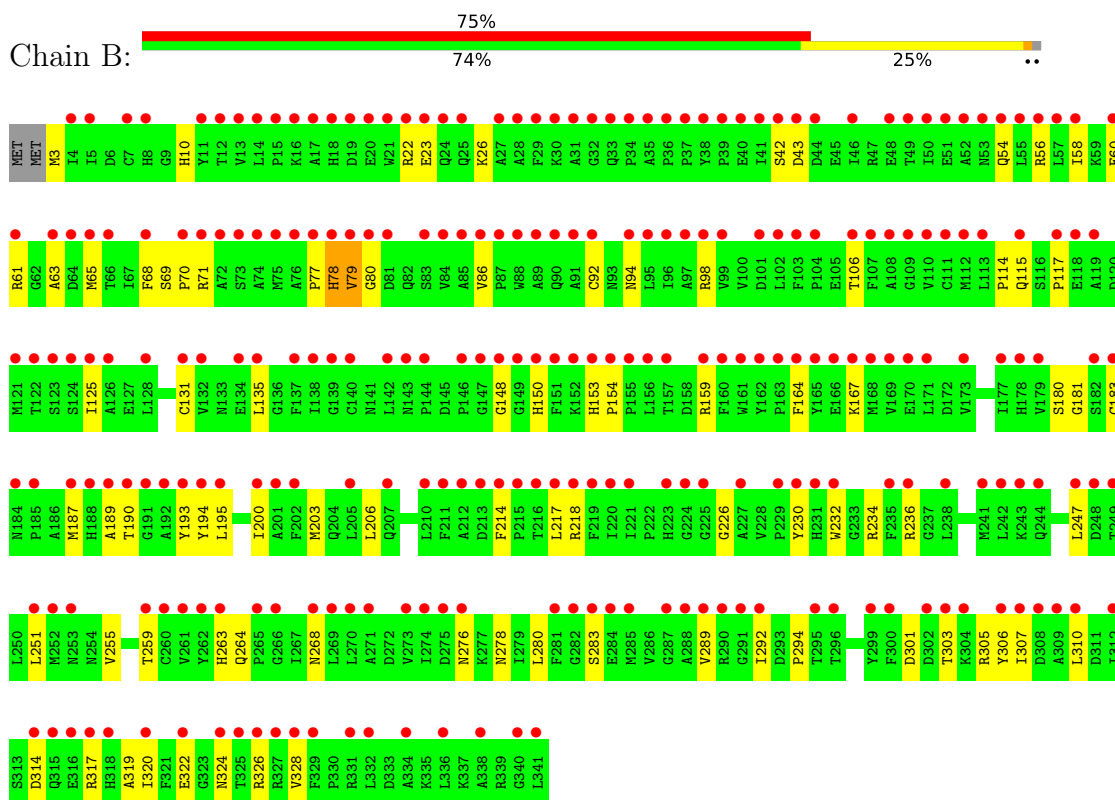

- Molecule 1: 4-oxalomesaconate hydratase

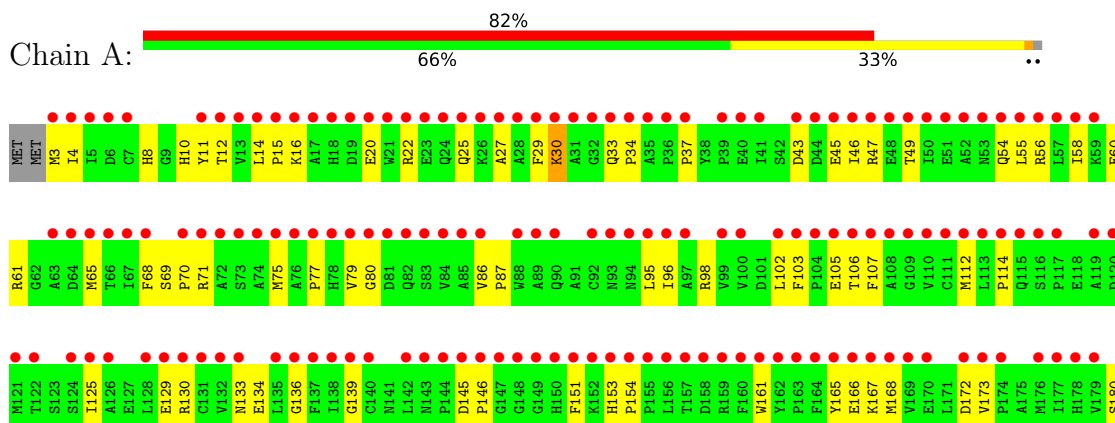

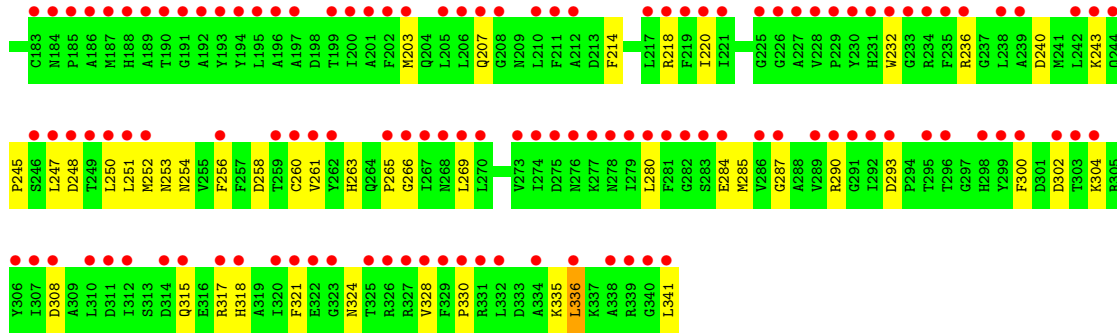

• Molecule 1: 4-oxalomesaconate hydratase

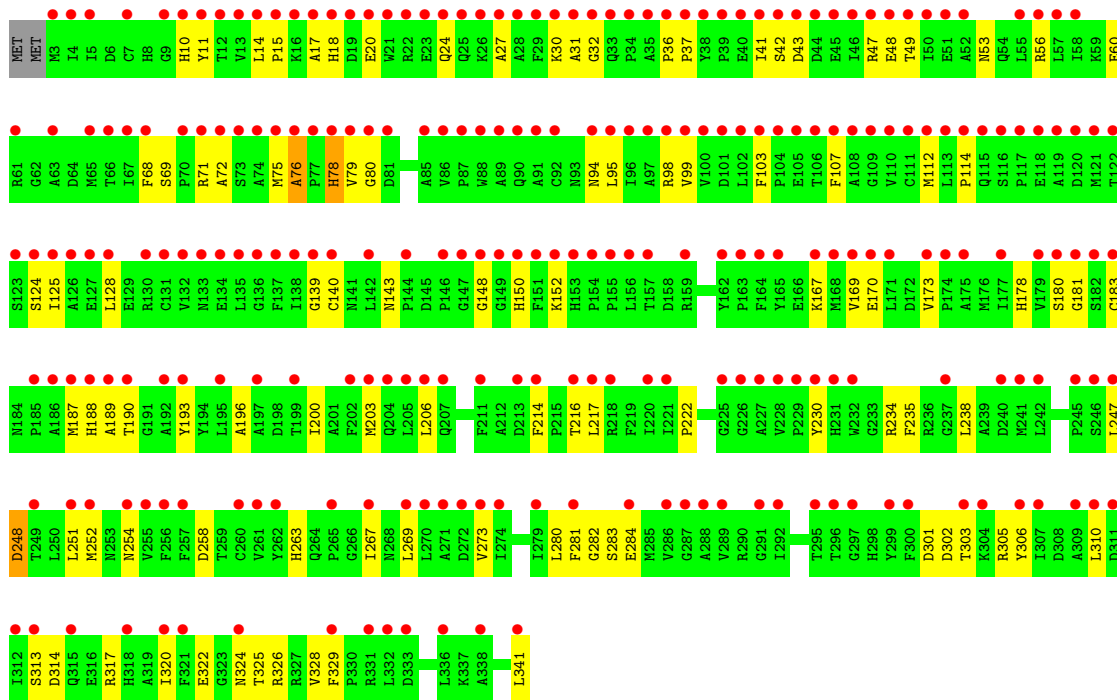

• Molecule 1: 4-oxalomesaconate hydratase

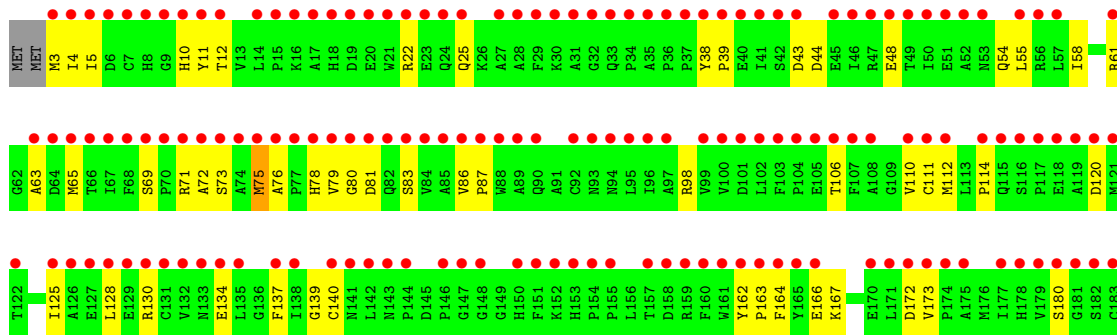
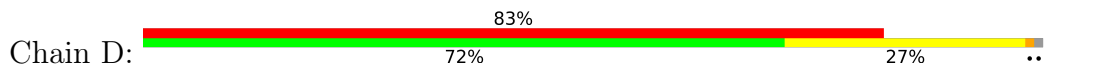



4 Data and refinement statistics i

Property	Value	Source
Space group	P 1 21 1	Depositor
Cell constants a, b, c, α , β , γ	82.17Å 78.22Å 135.69Å 90.00° 90.02° 90.00°	Depositor
Resolution (Å)	26.14 – 2.20 70.30 – 2.20	Depositor EDS
% Data completeness (in resolution range)	99.8 (26.14-2.20) 99.7 (70.30-2.20)	Depositor EDS
R_{merge}	(Not available)	Depositor
R_{sym}	(Not available)	Depositor
$\langle I/\sigma(I) \rangle$ ¹	37.80 (at 2.20Å)	Xtriage
Refinement program	PHENIX (1.13_2998: ???)	Depositor
R, R_{free}	0.204 , 0.278 0.203 , 0.270	Depositor DCC
R_{free} test set	2017 reflections (2.31%)	wwPDB-VP
Wilson B-factor (Å ²)	28.6	Xtriage
Anisotropy	0.543	Xtriage
Bulk solvent k_{sol} (e/Å ³), B_{sol} (Å ²)	0.36 , 28.6	EDS
L-test for twinning ²	$\langle L \rangle = 0.43$, $\langle L^2 \rangle = 0.25$	Xtriage
Estimated twinning fraction	0.022 for k,h,-l 0.019 for -k,-h,-l 0.408 for h,-k,-l	Xtriage
F_o, F_c correlation	0.94	EDS
Total number of atoms	10970	wwPDB-VP
Average B, all atoms (Å ²)	32.0	wwPDB-VP

Xtriage's analysis on translational NCS is as follows: *The analyses of the Patterson function reveals a significant off-origin peak that is 62.56 % of the origin peak, indicating pseudo-translational symmetry. The chance of finding a peak of this or larger height randomly in a structure without pseudo-translational symmetry is equal to 1.1061e-05. The detected translational NCS is most likely also responsible for the elevated intensity ratio.*

¹Intensities estimated from amplitudes.

²Theoretical values of $\langle |L| \rangle$, $\langle L^2 \rangle$ for acentric reflections are 0.5, 0.333 respectively for untwinned datasets, and 0.375, 0.2 for perfectly twinned datasets.

5 Model quality [i](#)

5.1 Standard geometry [i](#)

Bond lengths and bond angles in the following residue types are not validated in this section:
ZN

The Z score for a bond length (or angle) is the number of standard deviations the observed value is removed from the expected value. A bond length (or angle) with $|Z| > 5$ is considered an outlier worth inspection. RMSZ is the root-mean-square of all Z scores of the bond lengths (or angles).

Mol	Chain	Bond lengths		Bond angles	
		RMSZ	# Z >5	RMSZ	# Z >5
1	A	0.47	2/2732 (0.1%)	0.66	3/3715 (0.1%)
1	B	0.48	0/2732	0.64	0/3715
1	C	0.46	0/2732	0.65	1/3715 (0.0%)
1	D	0.43	0/2732	0.64	2/3715 (0.1%)
All	All	0.46	2/10928 (0.0%)	0.65	6/14860 (0.0%)

All (2) bond length outliers are listed below:

Mol	Chain	Res	Type	Atoms	Z	Observed(Å)	Ideal(Å)
1	A	243	LYS	CE-NZ	-7.61	1.30	1.49
1	A	243	LYS	CD-CE	-7.04	1.33	1.51

All (6) bond angle outliers are listed below:

Mol	Chain	Res	Type	Atoms	Z	Observed(°)	Ideal(°)
1	A	243	LYS	CD-CE-NZ	-7.23	95.06	111.70
1	D	258	ASP	CB-CG-OD1	6.54	124.19	118.30
1	A	243	LYS	CA-CB-CG	5.61	125.75	113.40
1	D	217	LEU	CA-CB-CG	5.61	128.19	115.30
1	A	336	LEU	CB-CG-CD1	-5.15	102.24	111.00
1	C	248	ASP	CB-CG-OD1	5.12	122.91	118.30

There are no chirality outliers.

There are no planarity outliers.

5.2 Too-close contacts [i](#)

In the following table, the Non-H and H(model) columns list the number of non-hydrogen atoms and hydrogen atoms in the chain respectively. The H(added) column lists the number of hydrogen

atoms added and optimized by MolProbity. The Clashes column lists the number of clashes within the asymmetric unit, whereas Symm-Clashes lists symmetry-related clashes.

Mol	Chain	Non-H	H(model)	H(added)	Clashes	Symm-Clashes
1	A	2658	0	2574	100	1
1	B	2658	0	2574	59	0
1	C	2658	0	2574	70	0
1	D	2658	0	2574	70	0
2	A	1	0	0	0	0
2	B	1	0	0	0	0
2	C	1	0	0	0	0
2	D	1	0	0	0	0
3	A	70	0	0	14	0
3	B	103	0	0	7	0
3	C	87	0	0	9	0
3	D	74	0	0	10	1
All	All	10970	0	10296	289	1

The all-atom clashscore is defined as the number of clashes found per 1000 atoms (including hydrogen atoms). The all-atom clashscore for this structure is 14.

All (289) close contacts within the same asymmetric unit are listed below, sorted by their clash magnitude.

Atom-1	Atom-2	Interatomic distance (Å)	Clash overlap (Å)
1:B:78:HIS:HE1	1:B:148:GLY:HA3	1.16	1.08
1:A:284:GLU:OE2	1:A:287:GLY:HA3	1.56	1.04
1:B:78:HIS:CE1	1:B:148:GLY:HA3	2.06	0.89
1:A:218:ARG:HH12	1:A:330:PRO:HD3	1.37	0.88
1:D:75:MET:HE2	1:D:112:MET:HB3	1.57	0.86
1:A:11:TYR:HH	1:A:49:THR:HG1	1.12	0.85
1:A:248:ASP:HA	1:A:252:MET:HB2	1.61	0.82
1:A:71:ARG:HH21	1:A:290:ARG:NH2	1.77	0.81
1:A:308:ASP:HA	1:A:317:ARG:HH12	1.46	0.81
1:D:248:ASP:HA	1:D:252:MET:HB2	1.61	0.81
1:D:245:PRO:HG2	1:D:250:LEU:HB2	1.64	0.80
1:A:153:HIS:HD2	1:A:161:TRP:CZ2	2.01	0.79
1:B:234:ARG:NH1	1:C:190:THR:O	2.16	0.76
1:B:183:CYS:SG	3:B:576:HOH:O	2.43	0.76
1:C:341:LEU:O	3:C:501:HOH:O	2.05	0.74
1:D:317:ARG:HD3	1:D:321:PHE:HE2	1.51	0.74
1:D:172:ASP:OD1	1:D:218:ARG:NH2	2.20	0.73
1:A:218:ARG:NH1	1:A:328:VAL:O	2.21	0.72
1:A:71:ARG:HH21	1:A:290:ARG:HH21	1.37	0.72

Continued on next page...

Continued from previous page...

Atom-1	Atom-2	Interatomic distance (Å)	Clash overlap (Å)
1:C:48:GLU:OE2	3:C:502:HOH:O	2.07	0.71
1:A:136:GLY:O	3:A:501:HOH:O	2.08	0.71
1:D:5:ILE:O	3:D:501:HOH:O	2.09	0.71
1:D:75:MET:CE	1:D:112:MET:HB3	2.20	0.70
1:C:310:LEU:O	1:C:317:ARG:NH2	2.16	0.69
1:D:333:ASP:OD1	3:D:502:HOH:O	2.10	0.69
1:A:43:ASP:OD1	1:A:98:ARG:NH2	2.26	0.69
1:A:240:ASP:OD2	3:A:502:HOH:O	2.10	0.68
1:C:314:ASP:OD1	3:C:503:HOH:O	2.10	0.68
1:A:43:ASP:O	1:A:47:ARG:HD2	1.94	0.68
1:D:61:ARG:O	3:D:503:HOH:O	2.11	0.68
1:B:58:ILE:HG23	1:B:63:ALA:HB3	1.75	0.68
1:B:218:ARG:NH1	1:B:328:VAL:O	2.26	0.68
1:B:289:VAL:O	3:B:501:HOH:O	2.11	0.68
1:A:153:HIS:CG	1:A:154:PRO:HD2	2.28	0.68
1:D:248:ASP:O	3:D:505:HOH:O	2.13	0.67
1:D:274:ILE:O	3:D:504:HOH:O	2.12	0.67
1:B:264:GLN:NE2	1:B:268:ASN:OD1	2.19	0.66
1:D:86:VAL:HA	1:D:114:PRO:HB3	1.78	0.66
1:C:284:GLU:OE1	3:C:505:HOH:O	2.14	0.66
1:B:150:HIS:ND1	1:C:150:HIS:O	2.24	0.65
1:A:15:PRO:HG3	1:A:45:GLU:HG3	1.79	0.65
1:C:203:MET:HG2	1:C:235:PHE:HE1	1.62	0.65
1:A:218:ARG:HG2	1:A:256:PHE:HE2	1.62	0.65
1:B:314:ASP:OD1	3:B:502:HOH:O	2.15	0.65
1:C:72:ALA:O	1:C:180:SER:OG	2.12	0.65
1:C:43:ASP:OD1	1:C:98:ARG:NH2	2.28	0.64
1:C:76:ALA:HB2	1:C:181:GLY:H	1.63	0.64
1:A:254:ASN:OD1	3:A:505:HOH:O	2.15	0.64
1:D:326:ARG:NH2	1:D:336:LEU:HB2	2.12	0.64
1:A:134:GLU:OE2	3:A:506:HOH:O	2.15	0.63
1:A:11:TYR:OH	1:A:49:THR:OG1	1.99	0.63
1:C:251:LEU:HB2	3:C:523:HOH:O	1.98	0.63
1:A:284:GLU:OE2	1:A:287:GLY:CA	2.39	0.62
1:A:260:CYS:SG	3:A:507:HOH:O	2.28	0.62
1:A:56:ARG:O	1:A:60:GLU:HG3	2.00	0.62
1:A:46:ILE:N	3:A:513:HOH:O	2.32	0.61
1:D:58:ILE:HG23	1:D:63:ALA:HB3	1.80	0.61
1:A:236:ARG:NH2	3:A:504:HOH:O	2.12	0.61
1:A:153:HIS:CD2	1:A:154:PRO:HD2	2.35	0.61
1:C:128:LEU:HD13	1:C:140:CYS:HB3	1.83	0.61

Continued on next page...

Continued from previous page...

Atom-1	Atom-2	Interatomic distance (Å)	Clash overlap (Å)
1:D:65:MET:HG2	1:D:106:THR:HA	1.83	0.61
1:D:55:LEU:HA	1:D:58:ILE:HD12	1.82	0.60
1:B:180:SER:OG	1:B:181:GLY:N	2.34	0.60
1:B:43:ASP:OD1	1:B:98:ARG:NH2	2.30	0.60
1:B:94:ASN:O	1:B:98:ARG:HG3	2.01	0.60
1:D:78:HIS:CE1	1:D:79:VAL:HG22	2.37	0.60
1:D:276:ASN:O	1:D:324:ASN:ND2	2.35	0.59
1:A:46:ILE:HG13	3:A:513:HOH:O	2.01	0.59
1:A:232:TRP:O	1:A:236:ARG:HG3	2.01	0.59
1:D:72:ALA:O	1:D:180:SER:OG	2.10	0.59
1:A:37:PRO:HD3	1:C:37:PRO:HA	1.84	0.59
1:B:230:TYR:HB2	1:C:230:TYR:CG	2.37	0.58
1:A:37:PRO:HG3	1:C:37:PRO:HB3	1.85	0.58
1:D:81:ASP:OD1	1:D:83:SER:OG	2.15	0.58
1:A:12:THR:HA	1:A:71:ARG:HD2	1.86	0.57
1:A:71:ARG:NH2	1:A:290:ARG:HH21	2.01	0.57
1:A:324:ASN:O	1:A:328:VAL:N	2.33	0.57
1:A:12:THR:HG22	1:A:71:ARG:HG3	1.86	0.56
1:C:282:GLY:HA3	3:C:542:HOH:O	2.06	0.56
1:B:77:PRO:HB3	1:B:115:GLN:O	2.05	0.56
1:A:14:LEU:HD23	3:A:542:HOH:O	2.05	0.56
1:A:139:GLY:HA2	1:A:173:VAL:HB	1.88	0.56
1:B:54:GLN:O	1:B:58:ILE:HG13	2.06	0.56
1:A:71:ARG:NH2	1:A:290:ARG:NH2	2.51	0.56
1:D:318:HIS:NE2	1:D:322:GLU:OE2	2.39	0.56
1:D:324:ASN:HB2	3:D:521:HOH:O	2.05	0.56
1:D:5:ILE:HB	1:D:325:THR:HG21	1.87	0.55
1:C:326:ARG:NH2	3:C:501:HOH:O	2.39	0.55
1:D:43:ASP:OD1	1:D:98:ARG:NH2	2.31	0.55
1:A:33:GLN:NE2	1:A:34:PRO:O	2.40	0.55
1:C:148:GLY:O	1:C:183:CYS:N	2.30	0.55
1:B:10:HIS:HB3	1:B:71:ARG:HA	1.89	0.54
1:A:22:ARG:NH1	1:A:25:GLN:OE1	2.40	0.54
1:A:16:LYS:O	1:A:20:GLU:HG3	2.07	0.54
1:A:77:PRO:HG2	1:A:146:PRO:HA	1.89	0.54
1:B:303:THR:HA	1:B:306:TYR:CD2	2.43	0.54
1:A:103:PHE:HB2	1:A:107:PHE:HD2	1.73	0.53
1:B:189:ALA:HA	1:B:193:TYR:HB3	1.89	0.53
1:A:98:ARG:O	1:A:102:LEU:HG	2.08	0.53
1:D:22:ARG:HH11	1:D:25:GLN:NE2	2.06	0.53
1:A:12:THR:HG22	1:A:71:ARG:NE	2.24	0.53

Continued on next page...

Continued from previous page...

Atom-1	Atom-2	Interatomic distance (Å)	Clash overlap (Å)
1:C:27:ALA:O	1:C:30:LYS:HB2	2.08	0.53
1:C:56:ARG:O	1:C:60:GLU:HG3	2.09	0.53
1:D:336:LEU:HA	1:D:339:ARG:HD3	1.91	0.52
1:B:320:ILE:O	3:B:503:HOH:O	2.19	0.52
1:D:71:ARG:HE	1:D:73:SER:H	1.57	0.52
1:B:203:MET:HG2	1:C:188:HIS:HB3	1.91	0.52
1:B:307:ILE:HA	1:B:310:LEU:HG	1.91	0.52
1:A:220:ILE:HD11	1:A:328:VAL:HG11	1.92	0.52
1:D:246:SER:OG	1:D:248:ASP:OD1	2.27	0.52
1:B:3:MET:O	1:B:322:GLU:HB2	2.10	0.51
1:D:3:MET:HB3	1:D:4:ILE:HD12	1.92	0.51
1:B:195:LEU:HD22	1:B:226:GLY:HA2	1.92	0.51
1:A:168:MET:O	1:A:172:ASP:N	2.44	0.51
1:D:163:PRO:O	3:D:506:HOH:O	2.19	0.51
1:C:94:ASN:O	1:C:98:ARG:HG3	2.10	0.51
1:A:65:MET:HG2	1:A:106:THR:HA	1.93	0.51
1:D:75:MET:CE	1:D:112:MET:CB	2.89	0.51
1:A:335:LYS:HE2	3:A:555:HOH:O	2.10	0.51
1:C:114:PRO:HD2	1:C:124:SER:HA	1.93	0.51
1:D:44:ASP:O	1:D:48:GLU:HG2	2.11	0.51
1:C:203:MET:HG2	1:C:235:PHE:CE1	2.46	0.50
1:A:280:LEU:HD21	1:A:328:VAL:HG21	1.94	0.50
1:B:322:GLU:OE2	1:B:326:ARG:NH1	2.45	0.50
1:B:283:SER:HB2	1:B:301:ASP:O	2.12	0.50
1:D:75:MET:HE2	1:D:112:MET:CB	2.36	0.50
1:A:86:VAL:HA	1:A:114:PRO:HB3	1.94	0.50
1:D:130:ARG:O	1:D:134:GLU:HB2	2.12	0.50
1:D:10:HIS:HA	1:D:69:SER:O	2.12	0.50
1:A:308:ASP:HA	1:A:317:ARG:NH1	2.20	0.49
1:D:54:GLN:O	1:D:58:ILE:HG13	2.11	0.49
1:B:56:ARG:O	1:B:60:GLU:HG3	2.12	0.49
1:C:248:ASP:HA	1:C:252:MET:HB2	1.94	0.49
1:C:303:THR:HA	1:C:306:TYR:CD2	2.48	0.49
1:C:169:VAL:HG22	1:C:216:THR:HG23	1.94	0.49
1:C:325:THR:HG23	1:C:329:PHE:CD1	2.48	0.49
1:B:150:HIS:CE1	1:C:152:LYS:HG2	2.48	0.49
1:D:125:ILE:HG23	1:D:167:LYS:HG2	1.93	0.49
1:A:125:ILE:HG23	1:A:167:LYS:HE3	1.93	0.49
1:D:38:TYR:CD2	1:D:39:PRO:HD2	2.47	0.48
1:D:248:ASP:HA	1:D:252:MET:CB	2.37	0.48
1:A:263:HIS:CD2	1:A:265:PRO:HD2	2.48	0.48

Continued on next page...

Continued from previous page...

Atom-1	Atom-2	Interatomic distance (Å)	Clash overlap (Å)
1:C:313:SER:O	1:C:317:ARG:HG3	2.13	0.48
1:A:304:LYS:NZ	1:A:308:ASP:OD1	2.46	0.48
1:B:230:TYR:CG	1:C:230:TYR:HB2	2.48	0.48
1:A:75:MET:HG2	1:A:112:MET:SD	2.53	0.48
1:C:139:GLY:HA2	1:C:173:VAL:HB	1.95	0.48
1:D:120:ASP:O	3:D:507:HOH:O	2.20	0.48
1:B:292:ILE:O	1:B:294:PRO:HD3	2.14	0.48
1:D:232:TRP:O	1:D:236:ARG:HG3	2.14	0.48
1:C:281:PHE:HB2	1:C:320:ILE:HG22	1.95	0.48
1:C:95:LEU:O	1:C:99:VAL:HG23	2.14	0.47
1:A:103:PHE:HB2	1:A:107:PHE:CD2	2.49	0.47
1:A:203:MET:O	1:A:207:GLN:HG3	2.14	0.47
1:D:228:VAL:HA	1:D:235:PHE:HE2	1.79	0.47
1:B:310:LEU:O	1:B:317:ARG:NH2	2.44	0.47
1:A:168:MET:HG2	1:A:173:VAL:HG23	1.96	0.47
1:A:304:LYS:HG3	1:A:321:PHE:CZ	2.50	0.47
1:D:128:LEU:HD22	1:D:164:PHE:CZ	2.49	0.47
1:B:319:ALA:HB1	1:B:324:ASN:OD1	2.13	0.46
1:C:125:ILE:HG23	1:C:167:LYS:HG2	1.96	0.46
1:A:27:ALA:O	1:A:30:LYS:HB3	2.15	0.46
1:C:189:ALA:HA	1:C:193:TYR:HB3	1.98	0.46
1:C:103:PHE:HB2	1:C:107:PHE:HD2	1.80	0.46
1:C:47:ARG:HG3	1:C:103:PHE:HZ	1.80	0.46
1:D:218:ARG:HD3	1:D:328:VAL:HA	1.96	0.46
1:B:117:PRO:HA	1:B:153:HIS:NE2	2.31	0.46
1:D:22:ARG:HH11	1:D:25:GLN:HE22	1.64	0.46
1:D:234:ARG:O	1:D:238:LEU:HG	2.16	0.46
1:A:261:VAL:HG11	1:A:266:GLY:HA3	1.98	0.45
1:D:3:MET:O	1:D:322:GLU:HB2	2.16	0.45
1:B:61:ARG:NH2	1:B:301:ASP:OD1	2.44	0.45
1:A:153:HIS:CD2	1:A:161:TRP:CZ2	2.92	0.45
1:C:269:LEU:O	1:C:273:VAL:HG22	2.16	0.45
1:D:79:VAL:HA	1:D:80:GLY:HA2	1.68	0.45
1:A:10:HIS:HA	1:A:69:SER:O	2.15	0.45
1:C:49:THR:HG21	3:C:560:HOH:O	2.15	0.45
1:C:234:ARG:O	1:C:238:LEU:HG	2.16	0.45
1:C:17:ALA:HA	1:C:20:GLU:HB2	1.98	0.45
1:B:22:ARG:NE	1:B:26:LYS:HE2	2.31	0.45
1:B:214:PHE:HB3	1:B:217:LEU:HB2	1.99	0.45
1:C:283:SER:HB2	1:C:301:ASP:O	2.17	0.45
1:D:111:CYS:HB3	1:D:137:PHE:CD2	2.51	0.45

Continued on next page...

Continued from previous page...

Atom-1	Atom-2	Interatomic distance (Å)	Clash overlap (Å)
1:C:78:HIS:CD2	1:C:78:HIS:H	2.33	0.45
1:A:236:ARG:HB3	3:A:503:HOH:O	2.15	0.45
1:D:162:TYR:O	1:D:166:GLU:HG3	2.15	0.45
1:B:303:THR:HA	1:B:306:TYR:CE2	2.52	0.45
1:A:12:THR:HB	1:A:71:ARG:HE	1.82	0.45
1:D:12:THR:HG22	1:D:71:ARG:HD2	1.99	0.44
1:C:24:GLN:HB3	1:C:36:PRO:HG2	2.00	0.44
1:C:15:PRO:HG2	1:C:41:ILE:HG21	2.00	0.44
1:B:200:ILE:HG12	1:C:187:MET:HG3	2.00	0.44
1:C:10:HIS:HA	1:C:69:SER:O	2.17	0.44
1:C:214:PHE:HB3	1:C:217:LEU:HB2	1.99	0.44
1:D:301:ASP:O	1:D:303:THR:N	2.51	0.44
1:A:33:GLN:HG2	1:A:34:PRO:O	2.17	0.44
1:A:86:VAL:HB	1:A:87:PRO:HD3	1.99	0.44
1:C:267:ILE:HG21	1:C:306:TYR:HB3	1.99	0.44
1:D:224:GLY:HA2	1:D:258:ASP:O	2.18	0.44
1:B:79:VAL:HA	1:B:80:GLY:HA2	1.31	0.44
1:C:322:GLU:OE2	1:C:326:ARG:NH1	2.47	0.44
1:B:154:PRO:O	3:B:504:HOH:O	2.21	0.44
1:A:61:ARG:NH1	1:A:302:ASP:HA	2.33	0.44
1:D:234:ARG:HD2	3:D:512:HOH:O	2.16	0.44
1:B:125:ILE:HG23	1:B:167:LYS:HG2	2.00	0.44
1:C:150:HIS:HB2	1:C:152:LYS:HG3	1.99	0.44
1:A:8:HIS:O	3:A:509:HOH:O	2.21	0.44
1:C:143:ASN:HA	1:C:178:HIS:O	2.17	0.43
1:D:10:HIS:HB3	1:D:71:ARG:HA	2.00	0.43
1:A:161:TRP:HB2	1:A:165:TYR:CE2	2.53	0.43
1:A:247:LEU:HD22	1:A:251:LEU:HD12	1.99	0.43
1:D:228:VAL:HA	1:D:235:PHE:CE2	2.53	0.43
1:C:217:LEU:O	1:C:254:ASN:ND2	2.41	0.43
1:C:258:ASP:HA	1:C:280:LEU:O	2.17	0.43
1:A:75:MET:HB2	1:A:180:SER:OG	2.19	0.43
1:A:79:VAL:HA	1:A:80:GLY:HA2	1.80	0.43
1:B:232:TRP:O	1:B:236:ARG:HG3	2.19	0.43
1:A:166:GLU:HG2	1:A:214:PHE:HE1	1.84	0.43
1:C:222:PRO:HA	1:C:258:ASP:OD2	2.19	0.43
1:A:11:TYR:CE2	1:A:95:LEU:HD21	2.54	0.43
1:A:55:LEU:HA	1:A:58:ILE:HD12	2.01	0.43
1:A:105:GLU:H	1:A:105:GLU:CD	2.21	0.43
1:D:86:VAL:HB	1:D:87:PRO:HD3	2.00	0.43
1:D:264:GLN:NE2	1:D:309:ALA:HB3	2.34	0.43

Continued on next page...

Continued from previous page...

Atom-1	Atom-2	Interatomic distance (Å)	Clash overlap (Å)
1:B:10:HIS:HA	1:B:69:SER:O	2.18	0.43
1:C:324:ASN:O	1:C:328:VAL:HG23	2.18	0.43
1:A:145:ASP:CG	1:A:151:PHE:HA	2.40	0.43
1:A:293:ASP:HA	1:A:300:PHE:CE2	2.54	0.42
1:B:195:LEU:CD2	1:B:226:GLY:HA2	2.50	0.42
1:A:315:GLN:O	1:A:318:HIS:HB3	2.19	0.42
1:D:318:HIS:O	1:D:322:GLU:N	2.48	0.42
1:D:328:VAL:O	1:D:330:PRO:HD3	2.18	0.42
1:B:131:CYS:HA	1:B:135:LEU:HD12	2.01	0.42
1:B:206:LEU:HD13	1:B:247:LEU:HD21	1.99	0.42
1:C:14:LEU:HD23	1:C:18:HIS:HD2	1.84	0.42
1:B:159:ARG:HG3	3:B:583:HOH:O	2.19	0.42
1:A:16:LYS:N	3:A:526:HOH:O	2.52	0.42
1:C:196:ALA:O	1:C:200:ILE:HD12	2.19	0.42
1:B:164:PHE:N	3:B:528:HOH:O	2.52	0.42
1:B:206:LEU:HD12	1:B:206:LEU:O	2.19	0.42
1:A:218:ARG:HH12	1:A:330:PRO:CD	2.19	0.42
1:D:300:PHE:N	3:D:530:HOH:O	2.52	0.42
1:B:187:MET:HG3	1:C:200:ILE:HG12	2.01	0.42
1:A:4:ILE:HG13	1:A:321:PHE:CD1	2.55	0.42
1:A:70:PRO:HD3	1:A:96:ILE:HG13	2.01	0.42
1:A:300:PHE:N	3:A:525:HOH:O	2.51	0.42
1:C:206:LEU:HD13	1:C:247:LEU:HD21	2.01	0.42
1:D:110:VAL:HG13	1:D:140:CYS:HA	2.02	0.42
1:A:12:THR:HG22	1:A:71:ARG:CG	2.49	0.42
1:A:129:GLU:O	1:A:133:ASN:HB2	2.20	0.42
1:D:12:THR:HG22	1:D:71:ARG:CD	2.49	0.42
1:D:308:ASP:HA	1:D:317:ARG:HE	1.85	0.42
1:B:255:VAL:O	1:B:278:ASN:ND2	2.52	0.41
1:A:55:LEU:HD22	1:A:103:PHE:CE2	2.55	0.41
1:A:218:ARG:HG2	1:A:256:PHE:CE2	2.50	0.41
1:C:15:PRO:HD3	3:C:504:HOH:O	2.19	0.41
1:C:49:THR:O	1:C:53:ASN:ND2	2.39	0.41
1:D:277:LYS:NZ	1:D:327:ARG:HH22	2.18	0.41
1:B:86:VAL:HA	1:B:114:PRO:HB3	2.01	0.41
1:A:3:MET:C	1:A:4:ILE:HD12	2.41	0.41
1:D:76:ALA:HB1	1:D:78:HIS:NE2	2.36	0.41
1:B:70:PRO:HB3	1:B:92:CYS:HB3	2.03	0.41
1:A:33:GLN:HG2	1:A:34:PRO:N	2.35	0.41
1:D:139:GLY:HA2	1:D:173:VAL:HB	2.02	0.41
1:B:247:LEU:HD22	1:B:251:LEU:HD12	2.01	0.41

Continued on next page...

Continued from previous page...

Atom-1	Atom-2	Interatomic distance (Å)	Clash overlap (Å)
1:D:336:LEU:HD22	1:D:339:ARG:NH1	2.35	0.41
1:D:260:CYS:SG	1:D:284:GLU:HB2	2.61	0.41
1:B:190:THR:HG22	1:B:194:TYR:CE2	2.55	0.41
1:B:259:THR:HG23	1:B:280:LEU:O	2.21	0.41
1:A:130:ARG:HA	1:A:134:GLU:HG3	2.03	0.41
1:C:11:TYR:O	1:C:14:LEU:HD11	2.20	0.41
1:A:10:HIS:HB3	1:A:71:ARG:HA	2.03	0.41
1:A:258:ASP:HA	1:A:280:LEU:O	2.21	0.41
1:A:284:GLU:CD	1:A:287:GLY:HA3	2.33	0.41
1:B:65:MET:HA	1:B:106:THR:O	2.21	0.40
1:A:256:PHE:HB3	1:A:280:LEU:HD13	2.02	0.40
1:C:302:ASP:CG	1:C:305:ARG:HG3	2.40	0.40
1:A:54:GLN:HA	1:A:285:MET:SD	2.61	0.40
1:C:75:MET:HB2	1:C:112:MET:SD	2.61	0.40
1:B:276:ASN:OD1	1:B:319:ALA:HB3	2.21	0.40
1:A:12:THR:CB	1:A:71:ARG:HE	2.34	0.40
1:A:218:ARG:HE	1:A:218:ARG:HB2	1.66	0.40
1:A:336:LEU:HB3	1:A:341:LEU:HD12	2.03	0.40
1:C:167:LYS:HD3	1:C:167:LYS:HA	1.82	0.40
1:C:167:LYS:NZ	1:C:170:GLU:OE1	2.29	0.40
1:D:270:LEU:HD12	1:D:274:ILE:HG13	2.04	0.40
1:B:218:ARG:HH11	1:B:328:VAL:HA	1.87	0.40
1:A:245:PRO:HB2	1:A:250:LEU:HB2	2.04	0.40
1:C:79:VAL:HA	1:C:80:GLY:HA2	1.53	0.40

All (1) symmetry-related close contacts are listed below. The label for Atom-2 includes the symmetry operator and encoded unit-cell translations to be applied.

Atom-1	Atom-2	Interatomic distance (Å)	Clash overlap (Å)
1:A:253:ASN:ND2	3:D:570:HOH:O[2_556]	2.16	0.04

5.3 Torsion angles [i](#)

5.3.1 Protein backbone [i](#)

In the following table, the Percentiles column shows the percent Ramachandran outliers of the chain as a percentile score with respect to all X-ray entries followed by that with respect to entries of similar resolution.

The Analysed column shows the number of residues for which the backbone conformation was

analysed, and the total number of residues.

Mol	Chain	Analysed	Favoured	Allowed	Outliers	Percentiles	
1	A	337/341 (99%)	317 (94%)	20 (6%)	0	100	100
1	B	337/341 (99%)	318 (94%)	17 (5%)	2 (1%)	25	26
1	C	337/341 (99%)	315 (94%)	18 (5%)	4 (1%)	13	10
1	D	337/341 (99%)	317 (94%)	20 (6%)	0	100	100
All	All	1348/1364 (99%)	1267 (94%)	75 (6%)	6 (0%)	34	37

All (6) Ramachandran outliers are listed below:

Mol	Chain	Res	Type
1	C	32	GLY
1	B	78	HIS
1	C	31	ALA
1	C	76	ALA
1	C	78	HIS
1	B	79	VAL

5.3.2 Protein sidechains [i](#)

In the following table, the Percentiles column shows the percent sidechain outliers of the chain as a percentile score with respect to all X-ray entries followed by that with respect to entries of similar resolution.

The Analysed column shows the number of residues for which the sidechain conformation was analysed, and the total number of residues.

Mol	Chain	Analysed	Rotameric	Outliers	Percentiles	
1	A	281/283 (99%)	277 (99%)	4 (1%)	67	80
1	B	281/283 (99%)	276 (98%)	5 (2%)	59	72
1	C	281/283 (99%)	277 (99%)	4 (1%)	67	80
1	D	281/283 (99%)	276 (98%)	5 (2%)	59	72
All	All	1124/1132 (99%)	1106 (98%)	18 (2%)	62	76

All (18) residues with a non-rotameric sidechain are listed below:

Mol	Chain	Res	Type
1	B	23	GLU
1	B	42	SER
1	B	68	PHE

Continued on next page...

Continued from previous page...

Mol	Chain	Res	Type
1	B	263	HIS
1	B	305	ARG
1	A	29	PHE
1	A	30	LYS
1	A	68	PHE
1	A	269	LEU
1	C	42	SER
1	C	68	PHE
1	C	71	ARG
1	C	263	HIS
1	D	11	TYR
1	D	75	MET
1	D	258	ASP
1	D	263	HIS
1	D	277	LYS

Sometimes sidechains can be flipped to improve hydrogen bonding and reduce clashes. All (6) such sidechains are listed below:

Mol	Chain	Res	Type
1	B	153	HIS
1	A	153	HIS
1	A	254	ASN
1	C	184	ASN
1	D	25	GLN
1	D	150	HIS

5.3.3 RNA [i](#)

There are no RNA molecules in this entry.

5.4 Non-standard residues in protein, DNA, RNA chains [i](#)

There are no non-standard protein/DNA/RNA residues in this entry.

5.5 Carbohydrates [i](#)

There are no monosaccharides in this entry.

5.6 Ligand geometry

Of 4 ligands modelled in this entry, 4 are monoatomic - leaving 0 for Mogul analysis.

There are no bond length outliers.

There are no bond angle outliers.

There are no chirality outliers.

There are no torsion outliers.

There are no ring outliers.

No monomer is involved in short contacts.

5.7 Other polymers

There are no such residues in this entry.

5.8 Polymer linkage issues

There are no chain breaks in this entry.

6 Fit of model and data [i](#)

6.1 Protein, DNA and RNA chains [i](#)

In the following table, the column labelled ‘#RSRZ > 2’ contains the number (and percentage) of RSRZ outliers, followed by percent RSRZ outliers for the chain as percentile scores relative to all X-ray entries and entries of similar resolution. The OWAB column contains the minimum, median, 95th percentile and maximum values of the occupancy-weighted average B-factor per residue. The column labelled ‘Q < 0.9’ lists the number of (and percentage) of residues with an average occupancy less than 0.9.

Mol	Chain	Analysed	<RSRZ>	#RSRZ>2	OWAB(Å ²)	Q<0.9
1	A	339/341 (99%)	3.70	279 (82%) 0 0	22, 37, 66, 84	0
1	B	339/341 (99%)	3.05	257 (75%) 0 0	16, 23, 45, 59	0
1	C	339/341 (99%)	3.33	250 (73%) 0 0	15, 24, 63, 98	0
1	D	339/341 (99%)	3.48	282 (83%) 0 0	25, 35, 51, 64	0
All	All	1356/1364 (99%)	3.39	1068 (78%) 0 0	15, 32, 55, 98	0

All (1068) RSRZ outliers are listed below:

Mol	Chain	Res	Type	RSRZ
1	A	29	PHE	16.4
1	B	28	ALA	16.2
1	A	35	ALA	16.1
1	D	79	VAL	15.9
1	B	76	ALA	15.3
1	C	21	TRP	14.7
1	C	36	PRO	14.0
1	A	63	ALA	13.4
1	C	31	ALA	13.1
1	A	27	ALA	11.8
1	C	38	TYR	11.5
1	C	29	PHE	11.3
1	C	30	LYS	11.2
1	C	79	VAL	11.0
1	B	84	VAL	11.0
1	C	78	HIS	11.0
1	C	25	GLN	10.8
1	B	79	VAL	10.8
1	D	117	PRO	10.8
1	C	33	GLN	10.7
1	D	313	SER	10.1

Continued on next page...

Continued from previous page...

Mol	Chain	Res	Type	RSRZ
1	C	35	ALA	10.0
1	D	72	ALA	10.0
1	C	34	PRO	10.0
1	A	24	GLN	9.9
1	B	149	GLY	9.9
1	A	41	ILE	9.1
1	D	75	MET	9.0
1	C	186	ALA	8.8
1	B	63	ALA	8.5
1	C	32	GLY	8.5
1	B	31	ALA	8.4
1	A	37	PRO	8.2
1	D	150	HIS	8.2
1	C	77	PRO	8.0
1	A	329	PHE	7.9
1	A	191	GLY	7.8
1	C	3	MET	7.8
1	D	182	SER	7.8
1	D	80	GLY	7.8
1	A	44	ASP	7.7
1	A	28	ALA	7.7
1	C	15	PRO	7.7
1	B	71	ARG	7.6
1	D	321	PHE	7.5
1	A	17	ALA	7.4
1	A	47	ARG	7.4
1	D	186	ALA	7.4
1	B	95	LEU	7.4
1	C	19	ASP	7.3
1	B	29	PHE	7.2
1	D	288	ALA	7.2
1	D	262	TYR	7.1
1	B	41	ILE	7.1
1	A	74	ALA	7.0
1	C	17	ALA	7.0
1	C	313	SER	7.0
1	C	182	SER	7.0
1	D	34	PRO	7.0
1	D	99	VAL	6.9
1	D	5	ILE	6.8
1	D	76	ALA	6.8
1	B	74	ALA	6.8

Continued on next page...

Continued from previous page...

Mol	Chain	Res	Type	RSRZ
1	A	73	SER	6.8
1	A	232	TRP	6.8
1	C	23	GLU	6.7
1	A	18	HIS	6.7
1	A	169	VAL	6.7
1	D	21	TRP	6.7
1	A	151	PHE	6.6
1	A	15	PRO	6.6
1	D	164	PHE	6.6
1	D	12	THR	6.5
1	A	184	ASN	6.5
1	A	114	PRO	6.5
1	A	75	MET	6.5
1	D	165	TYR	6.4
1	A	31	ALA	6.4
1	A	132	VAL	6.4
1	D	52	ALA	6.4
1	A	217	LEU	6.3
1	D	279	ILE	6.3
1	B	27	ALA	6.3
1	C	119	ALA	6.2
1	A	225	GLY	6.2
1	C	116	SER	6.2
1	D	92	CYS	6.2
1	C	47	ARG	6.2
1	A	55	LEU	6.2
1	A	189	ALA	6.1
1	B	48	GLU	6.1
1	D	35	ALA	6.1
1	A	290	ARG	6.1
1	D	32	GLY	6.1
1	A	212	ALA	6.1
1	A	183	CYS	6.1
1	A	95	LEU	6.0
1	B	310	LEU	6.0
1	A	194	TYR	6.0
1	B	18	HIS	5.9
1	D	214	PHE	5.9
1	A	162	TYR	5.9
1	B	16	LYS	5.9
1	C	75	MET	5.9
1	A	156	LEU	5.9

Continued on next page...

Continued from previous page...

Mol	Chain	Res	Type	RSRZ
1	B	78	HIS	5.9
1	C	132	VAL	5.9
1	D	36	PRO	5.9
1	D	37	PRO	5.9
1	D	125	ILE	5.8
1	A	86	VAL	5.8
1	A	21	TRP	5.8
1	D	260	CYS	5.8
1	A	48	GLU	5.8
1	C	150	HIS	5.8
1	C	52	ALA	5.8
1	A	77	PRO	5.8
1	C	18	HIS	5.8
1	D	100	VAL	5.8
1	D	286	VAL	5.7
1	A	267	ILE	5.7
1	A	328	VAL	5.7
1	A	178	HIS	5.7
1	B	153	HIS	5.7
1	D	292	ILE	5.6
1	C	271	ALA	5.6
1	D	312	ILE	5.6
1	A	283	SER	5.6
1	C	159	ARG	5.6
1	C	14	LEU	5.6
1	D	271	ALA	5.6
1	C	94	ASN	5.6
1	B	275	ASP	5.6
1	A	108	ALA	5.6
1	D	330	PRO	5.6
1	C	88	TRP	5.5
1	B	295	THR	5.5
1	B	33	GLN	5.5
1	D	338	ALA	5.5
1	D	230	TYR	5.5
1	A	259	THR	5.5
1	A	325	THR	5.5
1	D	40	GLU	5.4
1	B	163	PRO	5.4
1	D	31	ALA	5.4
1	C	171	LEU	5.4
1	D	332	LEU	5.4

Continued on next page...

Continued from previous page...

Mol	Chain	Res	Type	RSRZ
1	D	56	ARG	5.4
1	A	153	HIS	5.4
1	B	183	CYS	5.4
1	B	162	TYR	5.4
1	B	261	VAL	5.4
1	A	25	GLN	5.4
1	A	300	PHE	5.4
1	A	109	GLY	5.3
1	A	12	THR	5.3
1	D	135	LEU	5.3
1	A	88	TRP	5.3
1	A	269	LEU	5.3
1	D	140	CYS	5.3
1	D	47	ARG	5.3
1	A	84	VAL	5.3
1	C	173	VAL	5.3
1	A	152	LYS	5.3
1	D	77	PRO	5.3
1	D	318	HIS	5.3
1	A	5	ILE	5.3
1	A	291	GLY	5.3
1	D	317	ARG	5.3
1	D	185	PRO	5.3
1	A	273	VAL	5.2
1	C	26	LYS	5.2
1	D	29	PHE	5.2
1	A	20	GLU	5.2
1	B	72	ALA	5.2
1	A	32	GLY	5.2
1	A	79	VAL	5.2
1	A	99	VAL	5.2
1	A	314	ASP	5.2
1	C	11	TYR	5.2
1	D	38	TYR	5.2
1	D	173	VAL	5.2
1	A	327	ARG	5.2
1	C	242	LEU	5.1
1	A	334	ALA	5.1
1	C	112	MET	5.1
1	B	103	PHE	5.1
1	C	80	GLY	5.1
1	B	39	PRO	5.1

Continued on next page...

Continued from previous page...

Mol	Chain	Res	Type	RSRZ
1	B	190	THR	5.1
1	B	212	ALA	5.1
1	B	109	GLY	5.1
1	A	80	GLY	5.1
1	A	147	GLY	5.1
1	A	323	GLY	5.1
1	C	9	GLY	5.1
1	A	244	GLN	5.0
1	A	30	LYS	5.0
1	C	146	PRO	5.0
1	C	170	GLU	5.0
1	D	30	LYS	5.0
1	A	39	PRO	5.0
1	C	12	THR	5.0
1	D	227	ALA	5.0
1	D	74	ALA	5.0
1	A	11	TYR	5.0
1	A	34	PRO	4.9
1	A	111	CYS	4.9
1	B	238	LEU	4.9
1	D	23	GLU	4.9
1	C	306	TYR	4.9
1	A	128	LEU	4.9
1	A	135	LEU	4.9
1	C	181	GLY	4.9
1	B	273	VAL	4.9
1	A	120	ASP	4.9
1	C	92	CYS	4.9
1	D	70	PRO	4.9
1	C	157	THR	4.9
1	B	57	LEU	4.9
1	A	58	ILE	4.9
1	A	303	THR	4.9
1	B	34	PRO	4.8
1	D	274	ILE	4.8
1	B	317	ARG	4.8
1	B	119	ALA	4.8
1	B	283	SER	4.8
1	C	118	GLU	4.8
1	A	276	ASN	4.8
1	D	221	ILE	4.8
1	B	88	TRP	4.8

Continued on next page...

Continued from previous page...

Mol	Chain	Res	Type	RSRZ
1	A	149	GLY	4.8
1	C	73	SER	4.8
1	C	288	ALA	4.8
1	A	22	ARG	4.7
1	D	73	SER	4.7
1	D	17	ALA	4.7
1	C	312	ILE	4.7
1	A	57	LEU	4.7
1	A	211	PHE	4.7
1	D	306	TYR	4.7
1	A	96	ILE	4.7
1	C	76	ALA	4.7
1	A	179	VAL	4.7
1	A	261	VAL	4.7
1	D	287	GLY	4.6
1	D	25	GLN	4.6
1	D	67	ILE	4.6
1	C	68	PHE	4.6
1	A	193	TYR	4.6
1	B	156	LEU	4.6
1	C	55	LEU	4.6
1	A	51	GLU	4.6
1	A	143	ASN	4.6
1	D	151	PHE	4.6
1	C	286	VAL	4.6
1	C	81	ASP	4.6
1	D	309	ALA	4.6
1	C	139	GLY	4.6
1	B	151	PHE	4.5
1	C	24	GLN	4.5
1	C	50	ILE	4.5
1	B	80	GLY	4.5
1	A	107	PHE	4.5
1	A	3	MET	4.5
1	D	336	LEU	4.5
1	D	181	GLY	4.5
1	D	33	GLN	4.5
1	D	159	ARG	4.5
1	A	326	ARG	4.5
1	A	163	PRO	4.5
1	D	210	LEU	4.5
1	B	334	ALA	4.5

Continued on next page...

Continued from previous page...

Mol	Chain	Res	Type	RSRZ
1	C	40	GLU	4.5
1	C	104	PRO	4.5
1	D	170	GLU	4.5
1	C	318	HIS	4.5
1	D	132	VAL	4.5
1	B	91	ALA	4.5
1	C	85	ALA	4.4
1	C	117	PRO	4.4
1	A	71	ARG	4.4
1	B	50	ILE	4.4
1	B	249	THR	4.4
1	A	243	LYS	4.4
1	A	14	LEU	4.4
1	C	27	ALA	4.4
1	C	39	PRO	4.4
1	C	169	VAL	4.4
1	A	165	TYR	4.4
1	C	189	ALA	4.4
1	D	247	LEU	4.4
1	B	55	LEU	4.4
1	A	304	LYS	4.4
1	A	161	TRP	4.4
1	D	114	PRO	4.4
1	D	265	PRO	4.4
1	B	217	LEU	4.3
1	D	250	LEU	4.3
1	D	320	ILE	4.3
1	A	281	PHE	4.3
1	C	202	PHE	4.3
1	D	232	TRP	4.3
1	A	190	THR	4.3
1	D	307	ILE	4.3
1	B	73	SER	4.3
1	B	299	TYR	4.3
1	C	154	PRO	4.3
1	C	162	TYR	4.3
1	B	148	GLY	4.3
1	C	156	LEU	4.3
1	D	55	LEU	4.3
1	C	204	GLN	4.3
1	A	275	ASP	4.3
1	A	117	PRO	4.3

Continued on next page...

Continued from previous page...

Mol	Chain	Res	Type	RSRZ
1	D	193	TYR	4.3
1	A	338	ALA	4.3
1	D	254	ASN	4.3
1	B	11	TYR	4.3
1	B	160	PHE	4.3
1	A	137	PHE	4.3
1	B	152	LYS	4.2
1	D	208	GLY	4.2
1	B	178	HIS	4.2
1	D	264	GLN	4.2
1	A	230	TYR	4.2
1	D	261	VAL	4.2
1	D	4	ILE	4.2
1	D	69	SER	4.2
1	D	341	LEU	4.2
1	A	307	ILE	4.2
1	A	266	GLY	4.2
1	D	146	PRO	4.2
1	C	72	ALA	4.2
1	B	12	THR	4.2
1	C	127	GLU	4.2
1	A	103	PHE	4.2
1	A	299	TYR	4.2
1	B	307	ILE	4.2
1	B	231	HIS	4.1
1	D	325	THR	4.1
1	D	68	PHE	4.1
1	D	121	MET	4.1
1	D	127	GLU	4.1
1	D	153	HIS	4.1
1	B	164	PHE	4.1
1	C	96	ILE	4.1
1	D	200	ILE	4.1
1	D	131	CYS	4.1
1	A	146	PRO	4.1
1	D	294	PRO	4.1
1	C	113	LEU	4.1
1	A	321	PHE	4.1
1	A	89	ALA	4.1
1	D	15	PRO	4.1
1	A	296	THR	4.1
1	B	75	MET	4.1

Continued on next page...

Continued from previous page...

Mol	Chain	Res	Type	RSRZ
1	D	3	MET	4.1
1	C	74	ALA	4.0
1	C	108	ALA	4.0
1	B	265	PRO	4.0
1	D	255	VAL	4.0
1	B	326	ARG	4.0
1	A	221	ILE	4.0
1	D	142	LEU	4.0
1	C	70	PRO	4.0
1	C	311	ASP	4.0
1	A	72	ALA	4.0
1	C	122	THR	4.0
1	D	157	THR	4.0
1	A	246	SER	4.0
1	D	48	GLU	4.0
1	B	66	THR	4.0
1	C	86	VAL	4.0
1	B	165	TYR	4.0
1	C	232	TRP	4.0
1	C	28	ALA	4.0
1	B	282	GLY	4.0
1	D	39	PRO	4.0
1	B	179	VAL	4.0
1	C	153	HIS	4.0
1	D	88	TRP	4.0
1	D	218	ARG	4.0
1	C	216	THR	4.0
1	A	330	PRO	3.9
1	C	115	GLN	3.9
1	A	218	ARG	3.9
1	C	121	MET	3.9
1	D	22	ARG	3.9
1	B	167	LYS	3.9
1	D	11	TYR	3.9
1	A	239	ALA	3.9
1	D	249	THR	3.9
1	A	130	ARG	3.9
1	C	71	ARG	3.9
1	D	84	VAL	3.9
1	A	187	MET	3.9
1	A	265	PRO	3.9
1	A	197	ALA	3.9

Continued on next page...

Continued from previous page...

Mol	Chain	Res	Type	RSRZ
1	A	210	LEU	3.9
1	A	341	LEU	3.9
1	C	180	SER	3.9
1	A	68	PHE	3.9
1	B	289	VAL	3.9
1	A	106	THR	3.9
1	B	143	ASN	3.9
1	D	184	ASN	3.9
1	B	173	VAL	3.9
1	A	56	ARG	3.9
1	D	27	ALA	3.9
1	D	116	SER	3.9
1	D	272	ASP	3.9
1	D	147	GLY	3.8
1	B	187	MET	3.8
1	A	186	ALA	3.8
1	A	252	MET	3.8
1	A	262	TYR	3.8
1	C	22	ARG	3.8
1	D	231	HIS	3.8
1	C	279	ILE	3.8
1	D	228	VAL	3.8
1	D	81	ASP	3.8
1	B	30	LYS	3.8
1	C	320	ILE	3.8
1	D	177	ILE	3.8
1	C	151	PHE	3.8
1	A	177	ILE	3.8
1	C	99	VAL	3.8
1	C	226	GLY	3.8
1	A	43	ASP	3.8
1	D	57	LEU	3.8
1	A	78	HIS	3.8
1	A	16	LYS	3.8
1	B	21	TRP	3.8
1	D	161	TRP	3.8
1	B	42	SER	3.8
1	D	183	CYS	3.8
1	D	329	PHE	3.7
1	B	126	ALA	3.7
1	C	228	VAL	3.7
1	D	128	LEU	3.7

Continued on next page...

Continued from previous page...

Mol	Chain	Res	Type	RSRZ
1	C	164	PHE	3.7
1	B	5	ILE	3.7
1	A	312	ILE	3.7
1	D	105	GLU	3.7
1	C	111	CYS	3.7
1	B	194	TYR	3.7
1	D	41	ILE	3.7
1	B	191	GLY	3.7
1	C	66	THR	3.7
1	C	125	ILE	3.7
1	C	221	ILE	3.7
1	D	201	ALA	3.7
1	B	137	PHE	3.7
1	D	234	ARG	3.7
1	A	36	PRO	3.7
1	C	37	PRO	3.7
1	B	200	ILE	3.7
1	A	284	GLU	3.6
1	D	284	GLU	3.6
1	D	53	ASN	3.6
1	B	338	ALA	3.6
1	D	85	ALA	3.6
1	A	322	GLU	3.6
1	D	251	LEU	3.6
1	B	322	GLU	3.6
1	C	97	ALA	3.6
1	B	37	PRO	3.6
1	D	211	PHE	3.6
1	B	46	ILE	3.6
1	B	177	ILE	3.6
1	A	125	ILE	3.6
1	C	262	TYR	3.6
1	B	113	LEU	3.6
1	C	105	GLU	3.6
1	B	83	SER	3.6
1	B	52	ALA	3.6
1	D	295	THR	3.6
1	B	290	ARG	3.6
1	D	107	PHE	3.6
1	A	242	LEU	3.6
1	C	13	VAL	3.6
1	C	261	VAL	3.6

Continued on next page...

Continued from previous page...

Mol	Chain	Res	Type	RSRZ
1	A	124	SER	3.6
1	D	253	ASN	3.6
1	A	116	SER	3.6
1	C	272	ASP	3.6
1	D	326	ARG	3.6
1	B	288	ALA	3.6
1	C	338	ALA	3.6
1	A	131	CYS	3.6
1	C	152	LYS	3.6
1	D	138	ILE	3.6
1	C	135	LEU	3.6
1	B	230	TYR	3.6
1	D	155	PRO	3.6
1	B	124	SER	3.5
1	C	41	ILE	3.5
1	C	46	ILE	3.5
1	C	273	VAL	3.5
1	A	192	ALA	3.5
1	D	130	ARG	3.5
1	A	235	PHE	3.5
1	B	252	MET	3.5
1	A	65	MET	3.5
1	B	110	VAL	3.5
1	C	247	LEU	3.5
1	C	331	ARG	3.5
1	A	231	HIS	3.5
1	A	136	GLY	3.5
1	A	282	GLY	3.5
1	A	102	LEU	3.5
1	A	205	LEU	3.5
1	A	336	LEU	3.5
1	A	317	ARG	3.5
1	B	161	TRP	3.5
1	D	87	PRO	3.5
1	D	120	ASP	3.5
1	D	179	VAL	3.5
1	A	295	THR	3.5
1	B	304	LYS	3.5
1	B	58	ILE	3.5
1	B	87	PRO	3.5
1	D	103	PHE	3.5
1	D	10	HIS	3.5

Continued on next page...

Continued from previous page...

Mol	Chain	Res	Type	RSRZ
1	A	26	LYS	3.5
1	A	306	TYR	3.5
1	B	64	ASP	3.5
1	C	120	ASP	3.5
1	D	24	GLN	3.5
1	B	154	PRO	3.4
1	A	144	PRO	3.4
1	A	121	MET	3.4
1	C	138	ILE	3.4
1	A	302	ASP	3.4
1	A	277	LYS	3.4
1	B	166	GLU	3.4
1	B	168	MET	3.4
1	A	50	ILE	3.4
1	A	157	THR	3.4
1	C	211	PHE	3.4
1	D	206	LEU	3.4
1	B	44	ASP	3.4
1	A	100	VAL	3.4
1	A	170	GLU	3.4
1	A	140	CYS	3.4
1	A	298	HIS	3.4
1	B	241	MET	3.4
1	D	187	MET	3.4
1	B	205	LEU	3.4
1	A	46	ILE	3.4
1	A	93	ASN	3.4
1	A	236	ARG	3.4
1	A	33	GLN	3.4
1	A	318	HIS	3.4
1	B	128	LEU	3.4
1	D	97	ALA	3.4
1	A	90	GLN	3.4
1	C	315	GLN	3.4
1	B	263	HIS	3.4
1	D	18	HIS	3.4
1	A	66	THR	3.4
1	A	251	LEU	3.4
1	D	197	ALA	3.4
1	C	140	CYS	3.4
1	A	167	LYS	3.3
1	D	324	ASN	3.3

Continued on next page...

Continued from previous page...

Mol	Chain	Res	Type	RSRZ
1	B	121	MET	3.3
1	B	315	GLN	3.3
1	C	307	ILE	3.3
1	A	40	GLU	3.3
1	D	19	ASP	3.3
1	D	195	LEU	3.3
1	D	83	SER	3.3
1	B	324	ASN	3.3
1	C	133	ASN	3.3
1	B	284	GLU	3.3
1	C	45	GLU	3.3
1	A	168	MET	3.3
1	C	332	LEU	3.3
1	A	200	ILE	3.3
1	A	274	ILE	3.3
1	D	297	GLY	3.3
1	C	174	PRO	3.3
1	C	265	PRO	3.3
1	D	303	THR	3.3
1	A	97	ALA	3.3
1	A	159	ARG	3.3
1	C	109	GLY	3.3
1	A	238	LEU	3.3
1	A	67	ILE	3.3
1	C	136	GLY	3.3
1	D	118	GLU	3.3
1	A	166	GLU	3.3
1	D	327	ARG	3.3
1	A	82	GLN	3.2
1	D	238	LEU	3.2
1	D	285	MET	3.2
1	B	134	GLU	3.2
1	D	300	PHE	3.2
1	B	23	GLU	3.2
1	A	112	MET	3.2
1	D	162	TYR	3.2
1	B	86	VAL	3.2
1	C	289	VAL	3.2
1	B	101	ASP	3.2
1	A	154	PRO	3.2
1	D	104	PRO	3.2
1	D	280	LEU	3.2

Continued on next page...

Continued from previous page...

Mol	Chain	Res	Type	RSRZ
1	D	194	TYR	3.2
1	D	122	THR	3.2
1	B	213	ASP	3.2
1	B	210	LEU	3.2
1	D	217	LEU	3.2
1	D	310	LEU	3.2
1	C	274	ILE	3.2
1	B	202	PHE	3.2
1	A	19	ASP	3.2
1	B	276	ASN	3.2
1	B	211	PHE	3.2
1	A	199	THR	3.2
1	C	16	LYS	3.2
1	D	134	GLU	3.2
1	B	229	PRO	3.2
1	A	76	ALA	3.2
1	C	291	GLY	3.2
1	D	302	ASP	3.2
1	A	270	LEU	3.2
1	B	20	GLU	3.1
1	D	96	ILE	3.1
1	D	299	TYR	3.1
1	D	273	VAL	3.1
1	D	328	VAL	3.1
1	C	89	ALA	3.1
1	C	185	PRO	3.1
1	B	291	GLY	3.1
1	D	252	MET	3.1
1	B	107	PHE	3.1
1	B	219	PHE	3.1
1	C	214	PHE	3.1
1	B	193	TYR	3.1
1	A	173	VAL	3.1
1	D	222	PRO	3.1
1	B	112	MET	3.1
1	B	247	LEU	3.1
1	B	56	ARG	3.1
1	A	4	ILE	3.1
1	C	177	ILE	3.1
1	D	49	THR	3.1
1	A	293	ASP	3.1
1	D	281	PHE	3.1

Continued on next page...

Continued from previous page...

Mol	Chain	Res	Type	RSRZ
1	D	93	ASN	3.1
1	B	223	HIS	3.1
1	B	215	PRO	3.1
1	D	160	PHE	3.1
1	C	100	VAL	3.1
1	C	131	CYS	3.1
1	A	220	ILE	3.1
1	A	202	PHE	3.1
1	B	316	GLU	3.1
1	B	332	LEU	3.1
1	A	129	GLU	3.1
1	D	45	GLU	3.1
1	D	267	ILE	3.1
1	B	22	ARG	3.1
1	B	309	ALA	3.1
1	B	14	LEU	3.0
1	A	280	LEU	3.0
1	C	296	THR	3.0
1	C	218	ARG	3.0
1	C	260	CYS	3.0
1	C	165	TYR	3.0
1	B	15	PRO	3.0
1	B	341	LEU	3.0
1	D	204	GLN	3.0
1	D	240	ASP	3.0
1	D	219	PHE	3.0
1	A	315	GLN	3.0
1	D	78	HIS	3.0
1	A	268	ASN	3.0
1	C	192	ALA	3.0
1	C	292	ILE	3.0
1	D	192	ALA	3.0
1	C	148	GLY	3.0
1	D	291	GLY	3.0
1	B	19	ASP	3.0
1	B	36	PRO	3.0
1	C	249	THR	3.0
1	D	95	LEU	3.0
1	D	143	ASN	3.0
1	A	227	ALA	3.0
1	C	137	PHE	3.0
1	D	158	ASP	3.0

Continued on next page...

Continued from previous page...

Mol	Chain	Res	Type	RSRZ
1	B	94	ASN	3.0
1	B	111	CYS	3.0
1	C	10	HIS	3.0
1	C	183	CYS	3.0
1	D	209	ASN	3.0
1	A	234	ARG	3.0
1	D	152	LYS	3.0
1	C	63	ALA	3.0
1	C	309	ALA	3.0
1	D	319	ALA	3.0
1	B	292	ILE	3.0
1	A	219	PHE	3.0
1	D	110	VAL	3.0
1	B	150	HIS	3.0
1	B	35	ALA	2.9
1	A	83	SER	2.9
1	A	196	ALA	2.9
1	C	197	ALA	2.9
1	B	4	ILE	2.9
1	D	46	ILE	2.9
1	B	104	PRO	2.9
1	D	94	ASN	2.9
1	B	251	LEU	2.9
1	C	193	TYR	2.9
1	D	82	GLN	2.9
1	D	175	ALA	2.9
1	D	334	ALA	2.9
1	C	7	CYS	2.9
1	B	138	ILE	2.9
1	A	174	PRO	2.9
1	B	68	PHE	2.9
1	B	300	PHE	2.9
1	D	137	PHE	2.9
1	B	135	LEU	2.9
1	B	147	GLY	2.9
1	A	148	GLY	2.9
1	D	108	ALA	2.9
1	C	67	ILE	2.9
1	B	269	LEU	2.9
1	A	126	ALA	2.9
1	B	25	GLN	2.9
1	C	213	ASP	2.9

Continued on next page...

Continued from previous page...

Mol	Chain	Res	Type	RSRZ
1	C	124	SER	2.9
1	A	278	ASN	2.9
1	D	242	LEU	2.9
1	B	60	GLU	2.9
1	B	106	THR	2.9
1	A	92	CYS	2.9
1	C	257	PHE	2.9
1	C	300	PHE	2.9
1	A	250	LEU	2.9
1	D	270	LEU	2.9
1	B	81	ASP	2.9
1	A	64	ASP	2.9
1	C	44	ASP	2.9
1	C	130	ARG	2.9
1	B	54	GLN	2.8
1	D	188	HIS	2.8
1	B	306	TYR	2.8
1	A	249	THR	2.8
1	C	51	GLU	2.8
1	B	13	VAL	2.8
1	B	314	ASP	2.8
1	B	32	GLY	2.8
1	C	246	SER	2.8
1	C	49	THR	2.8
1	C	58	ILE	2.8
1	C	281	PHE	2.8
1	D	171	LEU	2.8
1	D	258	ASP	2.8
1	B	243	LYS	2.8
1	D	16	LYS	2.8
1	C	256	PHE	2.8
1	A	248	ASP	2.8
1	C	61	ARG	2.8
1	C	190	THR	2.8
1	B	221	ILE	2.8
1	A	256	PHE	2.8
1	D	256	PHE	2.8
1	B	132	VAL	2.8
1	B	189	ALA	2.8
1	A	201	ALA	2.8
1	B	303	THR	2.8
1	B	140	CYS	2.8

Continued on next page...

Continued from previous page...

Mol	Chain	Res	Type	RSRZ
1	D	7	CYS	2.8
1	A	59	LYS	2.8
1	B	192	ALA	2.7
1	A	289	VAL	2.7
1	C	126	ALA	2.7
1	D	86	VAL	2.7
1	D	202	PHE	2.7
1	C	102	LEU	2.7
1	A	49	THR	2.7
1	A	228	VAL	2.7
1	C	205	LEU	2.7
1	A	331	ARG	2.7
1	A	208	GLY	2.7
1	A	119	ALA	2.7
1	B	296	THR	2.7
1	C	303	THR	2.7
1	D	259	THR	2.7
1	A	133	ASN	2.7
1	D	223	HIS	2.7
1	C	254	ASN	2.7
1	D	106	THR	2.7
1	D	311	ASP	2.7
1	B	24	GLN	2.7
1	B	244	GLN	2.7
1	A	54	GLN	2.7
1	B	118	GLU	2.7
1	B	139	GLY	2.7
1	C	147	GLY	2.7
1	C	297	GLY	2.7
1	B	123	SER	2.7
1	D	119	ALA	2.7
1	B	329	PHE	2.7
1	B	102	LEU	2.7
1	B	242	LEU	2.7
1	A	340	GLY	2.7
1	B	70	PRO	2.7
1	A	320	ILE	2.7
1	A	122	THR	2.7
1	A	332	LEU	2.7
1	D	102	LEU	2.7
1	B	218	ARG	2.6
1	D	305	ARG	2.6

Continued on next page...

Continued from previous page...

Mol	Chain	Res	Type	RSRZ
1	B	77	PRO	2.6
1	C	134	GLU	2.6
1	C	324	ASN	2.6
1	B	142	LEU	2.6
1	C	206	LEU	2.6
1	C	336	LEU	2.6
1	D	141	ASN	2.6
1	B	312	ILE	2.6
1	A	52	ALA	2.6
1	C	5	ILE	2.6
1	D	63	ALA	2.6
1	C	269	LEU	2.6
1	C	187	MET	2.6
1	B	184	ASN	2.6
1	A	339	ARG	2.6
1	C	220	ILE	2.6
1	B	325	THR	2.6
1	D	66	THR	2.6
1	D	283	SER	2.6
1	C	252	MET	2.6
1	A	45	GLU	2.6
1	D	71	ARG	2.6
1	D	89	ALA	2.6
1	B	274	ILE	2.6
1	B	248	ASP	2.6
1	B	90	GLN	2.6
1	B	195	LEU	2.6
1	D	203	MET	2.6
1	D	101	ASP	2.6
1	D	215	PRO	2.6
1	A	279	ILE	2.6
1	C	56	ARG	2.5
1	C	95	LEU	2.5
1	C	217	LEU	2.5
1	B	308	ASP	2.5
1	D	340	GLY	2.5
1	A	53	ASN	2.5
1	B	185	PRO	2.5
1	A	104	PRO	2.5
1	C	144	PRO	2.5
1	A	23	GLU	2.5
1	A	113	LEU	2.5

Continued on next page...

Continued from previous page...

Mol	Chain	Res	Type	RSRZ
1	A	310	LEU	2.5
1	C	195	LEU	2.5
1	D	6	ASP	2.5
1	B	235	PHE	2.5
1	A	13	VAL	2.5
1	B	262	TYR	2.5
1	B	224	GLY	2.5
1	A	206	LEU	2.5
1	C	225	GLY	2.5
1	B	328	VAL	2.5
1	C	230	TYR	2.5
1	D	126	ALA	2.5
1	D	322	GLU	2.5
1	D	174	PRO	2.5
1	D	61	ARG	2.5
1	D	14	LEU	2.5
1	B	214	PHE	2.5
1	B	232	TRP	2.5
1	B	97	ALA	2.5
1	B	108	ALA	2.5
1	B	131	CYS	2.5
1	C	310	LEU	2.5
1	A	176	MET	2.5
1	D	241	MET	2.5
1	D	213	ASP	2.5
1	B	17	ALA	2.5
1	C	175	ALA	2.5
1	B	331	ARG	2.5
1	B	38	TYR	2.5
1	A	70	PRO	2.5
1	B	7	CYS	2.5
1	B	318	HIS	2.5
1	D	133	ASN	2.5
1	B	207	GLN	2.5
1	B	270	LEU	2.5
1	B	65	MET	2.4
1	B	170	GLU	2.4
1	D	51	GLU	2.4
1	B	188	HIS	2.4
1	A	150	HIS	2.4
1	C	4	ILE	2.4
1	D	42	SER	2.4

Continued on next page...

Continued from previous page...

Mol	Chain	Res	Type	RSRZ
1	C	231	HIS	2.4
1	D	331	ARG	2.4
1	A	142	LEU	2.4
1	C	270	LEU	2.4
1	C	341	LEU	2.4
1	C	168	MET	2.4
1	C	179	VAL	2.4
1	B	266	GLY	2.4
1	B	53	ASN	2.4
1	B	171	LEU	2.4
1	C	128	LEU	2.4
1	B	225	GLY	2.4
1	C	304	LYS	2.4
1	A	247	LEU	2.4
1	B	327	ARG	2.4
1	D	9	GLY	2.4
1	A	185	PRO	2.4
1	B	220	ILE	2.4
1	B	159	ARG	2.4
1	A	233	GLY	2.4
1	D	8	HIS	2.4
1	D	178	HIS	2.4
1	B	155	PRO	2.4
1	C	321	PHE	2.4
1	D	235	PHE	2.4
1	B	182	SER	2.4
1	B	61	ARG	2.3
1	A	155	PRO	2.3
1	C	20	GLU	2.3
1	C	155	PRO	2.3
1	B	99	VAL	2.3
1	C	43	ASP	2.3
1	D	248	ASP	2.3
1	B	125	ILE	2.3
1	C	48	GLU	2.3
1	C	110	VAL	2.3
1	C	149	GLY	2.3
1	D	225	GLY	2.3
1	B	146	PRO	2.3
1	C	245	PRO	2.3
1	B	201	ALA	2.3
1	B	285	MET	2.3

Continued on next page...

Continued from previous page...

Mol	Chain	Res	Type	RSRZ
1	D	43	ASP	2.3
1	B	117	PRO	2.3
1	C	101	ASP	2.3
1	C	163	PRO	2.3
1	D	154	PRO	2.3
1	B	271	ALA	2.3
1	B	157	THR	2.3
1	A	160	PHE	2.3
1	C	103	PHE	2.3
1	A	292	ILE	2.3
1	C	237	GLY	2.2
1	C	299	TYR	2.2
1	A	81	ASP	2.2
1	D	207	GLN	2.2
1	B	89	ALA	2.2
1	B	96	ILE	2.2
1	B	236	ARG	2.2
1	C	106	THR	2.2
1	A	203	MET	2.2
1	D	64	ASP	2.2
1	D	112	MET	2.2
1	D	198	ASP	2.2
1	B	92	CYS	2.2
1	C	107	PHE	2.2
1	D	257	PHE	2.2
1	C	91	ALA	2.2
1	C	167	LYS	2.2
1	D	28	ALA	2.2
1	B	302	ASP	2.2
1	A	6	ASP	2.2
1	C	240	ASP	2.2
1	D	65	MET	2.2
1	C	284	GLU	2.2
1	A	229	PRO	2.2
1	D	163	PRO	2.2
1	C	329	PHE	2.2
1	D	180	SER	2.2
1	A	311	ASP	2.2
1	B	40	GLU	2.2
1	A	188	HIS	2.2
1	C	57	LEU	2.2
1	C	241	MET	2.2

Continued on next page...

Continued from previous page...

Mol	Chain	Res	Type	RSRZ
1	C	114	PRO	2.2
1	B	281	PHE	2.2
1	B	260	CYS	2.2
1	D	129	GLU	2.2
1	D	296	THR	2.2
1	D	50	ILE	2.2
1	D	205	LEU	2.2
1	D	229	PRO	2.2
1	A	105	GLU	2.2
1	A	158	ASP	2.2
1	D	148	GLY	2.2
1	A	94	ASN	2.2
1	A	115	GLN	2.2
1	D	268	ASN	2.2
1	B	8	HIS	2.2
1	B	227	ALA	2.2
1	D	277	LYS	2.2
1	B	320	ILE	2.2
1	A	260	CYS	2.2
1	D	111	CYS	2.2
1	B	144	PRO	2.2
1	D	144	PRO	2.2
1	B	287	GLY	2.2
1	D	276	ASN	2.1
1	D	289	VAL	2.1
1	B	43	ASP	2.1
1	C	65	MET	2.1
1	C	333	ASP	2.1
1	D	115	GLN	2.1
1	C	42	SER	2.1
1	C	123	SER	2.1
1	A	7	CYS	2.1
1	C	203	MET	2.1
1	B	51	GLU	2.1
1	C	188	HIS	2.1
1	B	216	THR	2.1
1	A	85	ALA	2.1
1	C	295	THR	2.1
1	A	139	GLY	2.1
1	C	87	PRO	2.1
1	C	142	LEU	2.1
1	A	308	ASP	2.1

Continued on next page...

Continued from previous page...

Mol	Chain	Res	Type	RSRZ
1	B	268	ASN	2.1
1	A	164	PHE	2.1
1	D	166	GLU	2.1
1	A	287	GLY	2.1
1	D	243	LYS	2.1
1	B	115	GLN	2.1
1	A	207	GLN	2.1
1	B	49	THR	2.1
1	B	259	THR	2.1
1	B	253	ASN	2.1
1	D	196	ALA	2.1
1	A	110	VAL	2.1
1	C	287	GLY	2.1
1	C	229	PRO	2.1
1	B	336	LEU	2.1
1	A	138	ILE	2.1
1	C	207	GLN	2.1
1	B	98	ARG	2.1
1	C	199	THR	2.1
1	C	227	ALA	2.1
1	A	286	VAL	2.1
1	D	20	GLU	2.0
1	D	90	GLN	2.0
1	C	251	LEU	2.0
1	D	290	ARG	2.0
1	B	122	THR	2.0
1	C	90	GLN	2.0
1	A	172	ASP	2.0
1	C	267	ILE	2.0
1	A	145	ASP	2.0
1	C	98	ARG	2.0
1	B	169	VAL	2.0
1	C	255	VAL	2.0
1	D	304	LYS	2.0
1	A	195	LEU	2.0
1	B	340	GLY	2.0
1	A	226	GLY	2.0
1	D	172	ASP	2.0
1	B	85	ALA	2.0

6.2 Non-standard residues in protein, DNA, RNA chains [i](#)

There are no non-standard protein/DNA/RNA residues in this entry.

6.3 Carbohydrates [i](#)

There are no monosaccharides in this entry.

6.4 Ligands [i](#)

In the following table, the Atoms column lists the number of modelled atoms in the group and the number defined in the chemical component dictionary. The B-factors column lists the minimum, median, 95th percentile and maximum values of B factors of atoms in the group. The column labelled 'Q< 0.9' lists the number of atoms with occupancy less than 0.9.

Mol	Type	Chain	Res	Atoms	RSCC	RSR	B-factors(Å ²)	Q<0.9
2	ZN	B	401	1/1	0.56	0.44	34,34,34,34	0
2	ZN	C	401	1/1	0.79	0.12	40,40,40,40	0
2	ZN	A	401	1/1	0.88	0.21	33,33,33,33	0
2	ZN	D	401	1/1	0.90	0.10	25,25,25,25	0

6.5 Other polymers [i](#)

There are no such residues in this entry.