



## wwPDB EM Validation Summary Report ⓘ

Nov 19, 2022 – 08:43 pm GMT

PDB ID : 6EM5  
EMDB ID : EMD-3890  
Title : State D architectural model (Nsa1-TAP Flag-Ytm1) - Visualizing the assembly pathway of nucleolar pre-60S ribosomes  
Authors : Kater, L.; Cheng, J.; Barrio-Garcia, C.; Hurt, E.; Beckmann, R.  
Deposited on : 2017-10-01  
Resolution : 4.30 Å(reported)

This is a wwPDB EM Validation Summary Report for a publicly released PDB entry.

We welcome your comments at [validation@mail.wwpdb.org](mailto:validation@mail.wwpdb.org)

A user guide is available at

<https://www.wwpdb.org/validation/2017/EMValidationReportHelp>

with specific help available everywhere you see the ⓘ symbol.

The types of validation reports are described at

<http://www.wwpdb.org/validation/2017/FAQs#types>.

---

The following versions of software and data (see [references ⓘ](#)) were used in the production of this report:

EMDB validation analysis : 0.0.1.dev43  
MolProbity : 4.02b-467  
Percentile statistics : 20191225.v01 (using entries in the PDB archive December 25th 2019)  
MapQ : 1.9.9  
Ideal geometry (proteins) : Engh & Huber (2001)  
Ideal geometry (DNA, RNA) : Parkinson et al. (1996)  
Validation Pipeline (wwPDB-VP) : 2.31.2

# 1 Overall quality at a glance i

The following experimental techniques were used to determine the structure:  
*ELECTRON MICROSCOPY*

The reported resolution of this entry is 4.30 Å.

Percentile scores (ranging between 0-100) for global validation metrics of the entry are shown in the following graphic. The table shows the number of entries on which the scores are based.

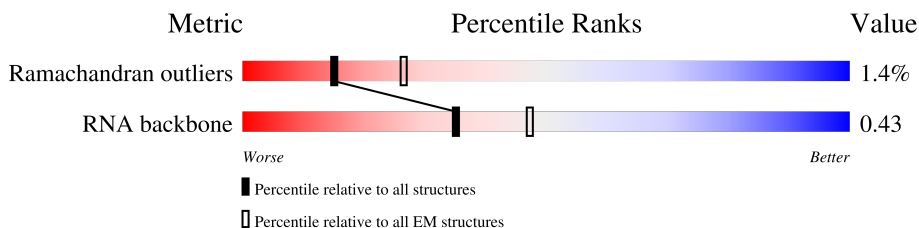











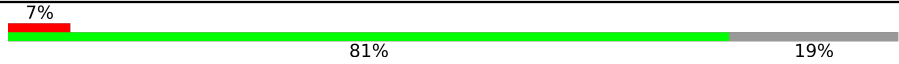
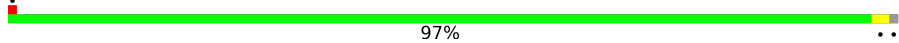

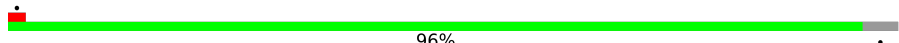
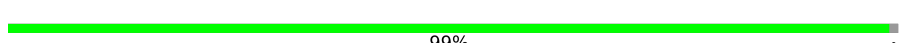
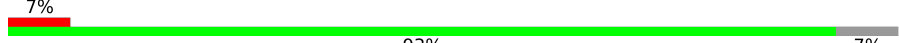
Metric	Whole archive (#Entries)	EM structures (#Entries)
Ramachandran outliers	154571	4023
RNA backbone	4643	859

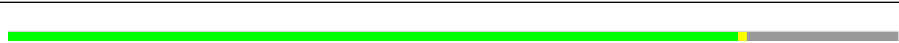
The table below summarises the geometric issues observed across the polymeric chains and their fit to the map. The red, orange, yellow and green segments of the bar indicate the fraction of residues that contain outliers for  $\geq 3$ , 2, 1 and 0 types of geometric quality criteria respectively. A grey segment represents the fraction of residues that are not modelled. The numeric value for each fraction is indicated below the corresponding segment, with a dot representing fractions  $\leq 5\%$ . The upper red bar (where present) indicates the fraction of residues that have poor fit to the EM map (all-atom inclusion  $< 40\%$ ). The numeric value is given above the bar.

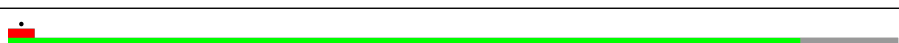
Mol	Chain	Length	Quality of chain
1	2	158	
2	6	232	
3	L	199	
4	M	138	
5	N	204	
6	Q	186	
7	R	189	
8	S	172	
9	T	160	

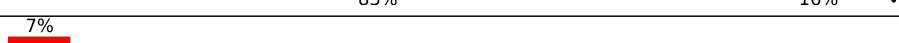
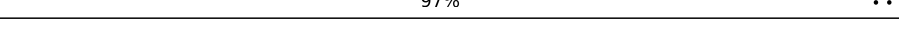
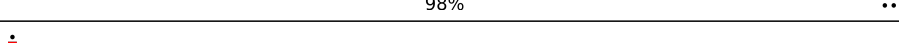
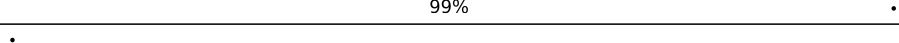
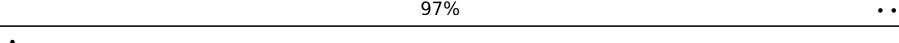
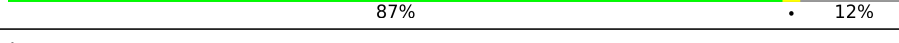
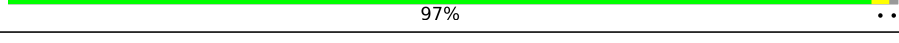
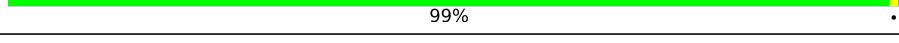









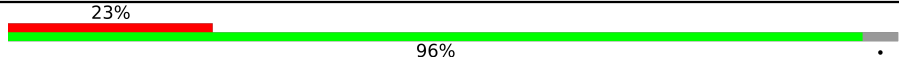
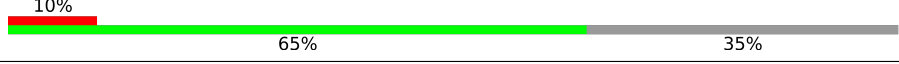



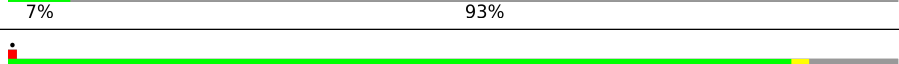
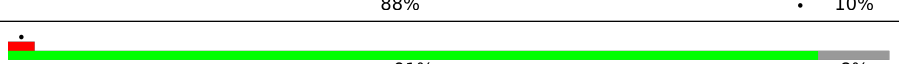
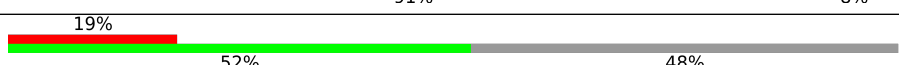
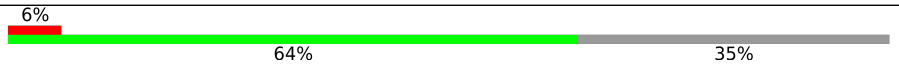

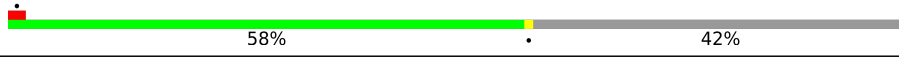
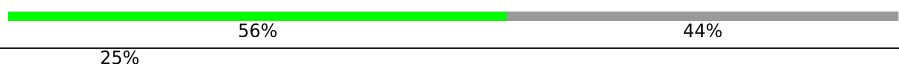
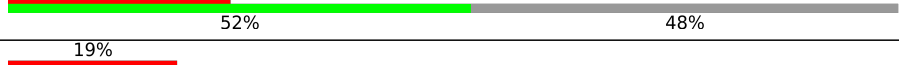
*Continued on next page...*

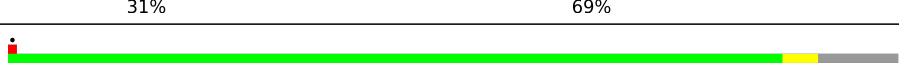
Continued from previous page...

Mol	Chain	Length	Quality of chain
10	U	121	 7% 81% 19%
11	Z	136	 97%
12	c	105	 5% 92% 8%
13	d	113	 5% 93% 5%
14	e	130	 96%
15	f	107	 99%
16	g	121	 7% 93% 7%
17	i	100	 71% 28%
18	j	88	 82% 17%
19	k	78	 97%
20	E	176	 89% 11%
21	G	256	 71% 28%
22	O	199	 83% 16%
23	V	137	 7% 97%
24	X	142	 98%
25	Y	127	 99%
26	h	120	 97%
27	B	387	 87% 12%
28	C	362	 97%
29	H	191	 99%
30	A	291	 67% 32%
31	K	376	 68% 32%
32	m	807	 7% 79% 20%
33	D	505	 38% 62%
34	W	236	 97%

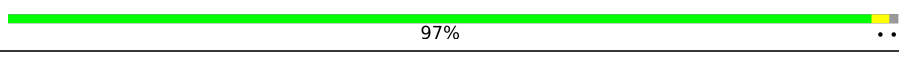
Continued on next page...

Continued from previous page...

Mol	Chain	Length	Quality of chain
35	l	181	
36	b	647	
37	o	220	
38	n	605	
39	r	261	
40	s	520	
41	t	322	
42	y	245	
43	z	106	
44	p	460	
45	q	618	
46	u	199	
47	v	231	
48	w	841	
49	I	663	
50	J	427	
51	x	295	
52	3	306	
53	4	278	
54	5	463	
55	1	3396	
56	F	244	
57	P	184	

## 2 Entry composition

There are 57 unique types of molecules in this entry. The entry contains 74285 atoms, of which 0 are hydrogens and 0 are deuteriums.

In the tables below, the AltConf column contains the number of residues with at least one atom in alternate conformation and the Trace column contains the number of residues modelled with at most 2 atoms.

- Molecule 1 is a RNA chain called 5.8S ribosomal RNA.

Mol	Chain	Residues	Atoms			AltConf	Trace	
			Total	C	O			P
1	2	158	1896	790	948	158	0	0

- Molecule 2 is a RNA chain called Internal Transcribed Spacer 2.

Mol	Chain	Residues	Atoms			AltConf	Trace	
			Total	C	O			P
2	6	65	780	325	390	65	0	0

- Molecule 3 is a protein called 60S ribosomal protein L13-A.

Mol	Chain	Residues	Atoms			AltConf	Trace	
			Total	C	N			O
3	L	122	488	244	122	122	0	0

- Molecule 4 is a protein called 60S ribosomal protein L14-A.

Mol	Chain	Residues	Atoms			AltConf	Trace	
			Total	C	N			O
4	M	136	544	272	136	136	0	0

- Molecule 5 is a protein called 60S ribosomal protein L15-A.

Mol	Chain	Residues	Atoms			AltConf	Trace	
			Total	C	N			O
5	N	186	744	372	186	186	0	0

- Molecule 6 is a protein called 60S ribosomal protein L18-A.

Mol	Chain	Residues	Atoms			AltConf	Trace	
			Total	C	N			O
6	Q	134	536	268	134	134	0	0

- Molecule 7 is a protein called 60S ribosomal protein L19-A.

Mol	Chain	Residues	Atoms				AltConf	Trace
			Total	C	N	O		
7	R	120	480	240	120	120	0	0

- Molecule 8 is a protein called 60S ribosomal protein L20-A.

Mol	Chain	Residues	Atoms				AltConf	Trace
			Total	C	N	O		
8	S	170	680	340	170	170	0	0

- Molecule 9 is a protein called 60S ribosomal protein L21-A.

Mol	Chain	Residues	Atoms				AltConf	Trace
			Total	C	N	O		
9	T	22	88	44	22	22	0	0

- Molecule 10 is a protein called 60S ribosomal protein L22-A.

Mol	Chain	Residues	Atoms				AltConf	Trace
			Total	C	N	O		
10	U	98	392	196	98	98	0	0

- Molecule 11 is a protein called 60S ribosomal protein L27-A.

Mol	Chain	Residues	Atoms				AltConf	Trace
			Total	C	N	O		
11	Z	135	540	270	135	135	0	0

- Molecule 12 is a protein called 60S ribosomal protein L30.

Mol	Chain	Residues	Atoms				AltConf	Trace
			Total	C	N	O		
12	c	97	388	194	97	97	0	0

- Molecule 13 is a protein called 60S ribosomal protein L31-A.

Mol	Chain	Residues	Atoms				AltConf	Trace
			Total	C	N	O		
13	d	107	428	214	107	107	0	0

- Molecule 14 is a protein called 60S ribosomal protein L32.

Mol	Chain	Residues	Atoms			AltConf	Trace	
			Total	C	N			O
14	e	125	500	250	125	125	0	0

- Molecule 15 is a protein called 60S ribosomal protein L33-A.

Mol	Chain	Residues	Atoms			AltConf	Trace	
			Total	C	N			O
15	f	106	424	212	106	106	0	0

- Molecule 16 is a protein called 60S ribosomal protein L34-A.

Mol	Chain	Residues	Atoms			AltConf	Trace	
			Total	C	N			O
16	g	112	448	224	112	112	0	0

- Molecule 17 is a protein called 60S ribosomal protein L36-B.

Mol	Chain	Residues	Atoms			AltConf	Trace	
			Total	C	N			O
17	i	72	288	144	72	72	0	0

- Molecule 18 is a protein called 60S ribosomal protein L37-A.

Mol	Chain	Residues	Atoms			AltConf	Trace	
			Total	C	N			O
18	j	73	292	146	73	73	0	0

- Molecule 19 is a protein called 60S ribosomal protein L38.

Mol	Chain	Residues	Atoms			AltConf	Trace	
			Total	C	N			O
19	k	77	308	154	77	77	0	0

- Molecule 20 is a protein called 60S ribosomal protein L6-A.

Mol	Chain	Residues	Atoms			AltConf	Trace	
			Total	C	N			O
20	E	156	624	312	156	156	0	0

- Molecule 21 is a protein called 60S ribosomal protein L8-A.

Mol	Chain	Residues	Atoms			AltConf	Trace	
21	G	184	Total	C	N	O	0	0
			736	368	184	184		

- Molecule 22 is a protein called 60S ribosomal protein L16-A.

Mol	Chain	Residues	Atoms			AltConf	Trace	
22	O	197	Total	C	N	O	0	0
			788	394	197	197		

- Molecule 23 is a protein called 60S ribosomal protein L23-A.

Mol	Chain	Residues	Atoms			AltConf	Trace	
23	V	134	Total	C	N	O	0	0
			536	268	134	134		

- Molecule 24 is a protein called 60S ribosomal protein L25.

Mol	Chain	Residues	Atoms			AltConf	Trace	
24	X	141	Total	C	N	O	0	0
			564	282	141	141		

- Molecule 25 is a protein called 60S ribosomal protein L26-A.

Mol	Chain	Residues	Atoms			AltConf	Trace	
25	Y	126	Total	C	N	O	0	0
			504	252	126	126		

- Molecule 26 is a protein called 60S ribosomal protein L35-A.

Mol	Chain	Residues	Atoms			AltConf	Trace	
26	h	119	Total	C	N	O	0	0
			476	238	119	119		

- Molecule 27 is a protein called 60S ribosomal protein L3.

Mol	Chain	Residues	Atoms			AltConf	Trace	
27	B	341	Total	C	N	O	0	0
			1364	682	341	341		

- Molecule 28 is a protein called 60S ribosomal protein L4-A.



Mol	Chain	Residues	Atoms			AltConf	Trace	
28	C	359	Total	C	N	O	0	0
			1436	718	359	359		

- Molecule 29 is a protein called 60S ribosomal protein L9-A.

Mol	Chain	Residues	Atoms			AltConf	Trace	
29	H	190	Total	C	N	O	0	0
			760	380	190	190		

- Molecule 30 is a protein called Ribosome biogenesis protein BRX1.

Mol	Chain	Residues	Atoms			AltConf	Trace	
30	A	198	Total	C	N	O	0	0
			792	396	198	198		

- Molecule 31 is a protein called Proteasome-interacting protein CIC1.

Mol	Chain	Residues	Atoms			AltConf	Trace	
31	K	257	Total	C	N	O	0	0
			1028	514	257	257		

- Molecule 32 is a protein called Ribosome biogenesis protein ERB1.

Mol	Chain	Residues	Atoms			AltConf	Trace	
32	m	645	Total	C	N	O	0	0
			2580	1290	645	645		

- Molecule 33 is a protein called ATP-dependent RNA helicase HAS1.

Mol	Chain	Residues	Atoms			AltConf	Trace	
33	D	194	Total	C	N	O	0	0
			776	388	194	194		

- Molecule 34 is a protein called Ribosome assembly factor MRT4.

Mol	Chain	Residues	Atoms			AltConf	Trace	
34	W	232	Total	C	N	O	0	0
			928	464	232	232		

- Molecule 35 is a protein called 60S ribosome subunit biogenesis protein NIP7.

Mol	Chain	Residues	Atoms			AltConf	Trace	
35	l	174	Total	C	N	O	0	0
			696	348	174	174		

- Molecule 36 is a protein called Nucleolar GTP-binding protein 1.

Mol	Chain	Residues	Atoms			AltConf	Trace	
36	b	421	Total	C	N	O	0	0
			1684	842	421	421		

- Molecule 37 is a protein called Ribosome biogenesis protein 15.

Mol	Chain	Residues	Atoms			AltConf	Trace	
37	o	133	Total	C	N	O	0	0
			532	266	133	133		

- Molecule 38 is a protein called Pescadillo homolog.

Mol	Chain	Residues	Atoms			AltConf	Trace	
38	n	411	Total	C	N	O	0	0
			1644	822	411	411		

- Molecule 39 is a protein called Ribosome biogenesis protein NSA2.

Mol	Chain	Residues	Atoms			AltConf	Trace	
39	r	176	Total	C	N	O	0	0
			704	352	176	176		

- Molecule 40 is a protein called Nuclear GTP-binding protein NUG1.

Mol	Chain	Residues	Atoms			AltConf	Trace	
40	s	36	Total	C	N	O	0	0
			144	72	36	36		

- Molecule 41 is a protein called Ribosome biogenesis protein RLP7.

Mol	Chain	Residues	Atoms			AltConf	Trace	
41	t	290	Total	C	N	O	0	0
			1160	580	290	290		

- Molecule 42 is a protein called Eukaryotic translation initiation factor 6.

Mol	Chain	Residues	Atoms			AltConf	Trace	
			Total	C	N			O
42	y	225	900	450	225	225	0	0

- Molecule 43 is a protein called UPF0642 protein YBL028C.

Mol	Chain	Residues	Atoms			AltConf	Trace	
			Total	C	N			O
43	z	55	220	110	55	55	0	0

- Molecule 44 is a protein called Ribosome biogenesis protein YTM1.

Mol	Chain	Residues	Atoms			AltConf	Trace	
			Total	C	N			O
44	p	298	1192	596	298	298	0	0

- Molecule 45 is a protein called 25S rRNA (cytosine(2870)-C(5))-methyltransferase.

Mol	Chain	Residues	Atoms			AltConf	Trace	
			Total	C	N			O
45	q	317	1268	634	317	317	0	0

- Molecule 46 is a protein called Ribosome biogenesis protein RLP24.

Mol	Chain	Residues	Atoms			AltConf	Trace	
			Total	C	N			O
46	u	116	464	232	116	116	0	0

- Molecule 47 is a protein called Nucleolar protein 16.

Mol	Chain	Residues	Atoms			AltConf	Trace	
			Total	C	N			O
47	v	130	520	260	130	130	0	0

- Molecule 48 is a protein called 27S pre-rRNA (guanosine(2922)-2'-O)-methyltransferase.

Mol	Chain	Residues	Atoms			AltConf	Trace	
			Total	C	N			O
48	w	436	1744	872	436	436	0	0

- Molecule 49 is a protein called Nucleolar complex-associated protein 3.

Mol	Chain	Residues	Atoms				AltConf	Trace
49	I	451	Total	C	N	O	0	0
			1804	902	451	451		

- Molecule 50 is a protein called rRNA-processing protein EBP2.

Mol	Chain	Residues	Atoms				AltConf	Trace
50	J	132	Total	C	N	O	0	0
			528	264	132	132		

- Molecule 51 is a protein called Ribosome production factor 1.

Mol	Chain	Residues	Atoms				AltConf	Trace
51	x	267	Total	C	N	O	0	0
			1068	534	267	267		

- Molecule 52 is a protein called Protein MAK16.

Mol	Chain	Residues	Atoms				AltConf	Trace
52	3	173	Total	C	N	O	0	0
			692	346	173	173		

- Molecule 53 is a protein called Ribosomal RNA-processing protein 1.

Mol	Chain	Residues	Atoms				AltConf	Trace
53	4	220	Total	C	N	O	0	0
			880	440	220	220		

- Molecule 54 is a protein called Ribosome biogenesis protein NSA1.

Mol	Chain	Residues	Atoms				AltConf	Trace
54	5	385	Total	C	N	O	0	0
			1540	770	385	385		

- Molecule 55 is a RNA chain called 25S ribosomal RNA.

Mol	Chain	Residues	Atoms				AltConf	Trace
55	1	2438	Total	C	O	P	0	0
			29253	12190	14626	2437		

- Molecule 56 is a protein called 60S ribosomal protein L7-A.

Mol	Chain	Residues	Atoms			AltConf	Trace	
			Total	C	N			O
56	F	241	964	482	241	241	0	0

- Molecule 57 is a protein called 60S ribosomal protein L17-A.

Mol	Chain	Residues	Atoms			AltConf	Trace	
			Total	C	N			O
57	P	137	548	274	137	137	0	0

### 3 Residue-property plots

These plots are drawn for all protein, RNA, DNA and oligosaccharide chains in the entry. The first graphic for a chain summarises the proportions of the various outlier classes displayed in the second graphic. The second graphic shows the sequence view annotated by issues in geometry and atom inclusion in map density. Residues are color-coded according to the number of geometric quality criteria for which they contain at least one outlier: green = 0, yellow = 1, orange = 2 and red = 3 or more. A red diamond above a residue indicates a poor fit to the EM map for this residue (all-atom inclusion < 40%). Stretches of 2 or more consecutive residues without any outlier are shown as a green connector. Residues present in the sample, but not in the model, are shown in grey.

- Molecule 1: 5.8S ribosomal RNA

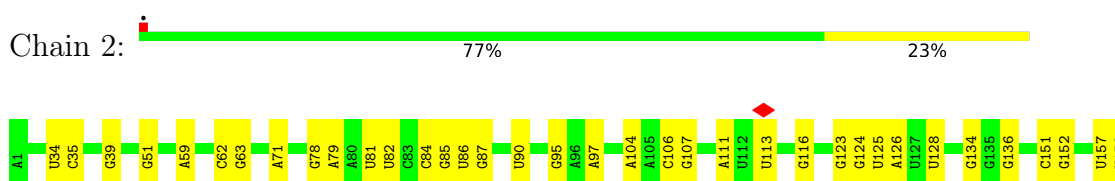

- Molecule 2: Internal Transcribed Spacer 2

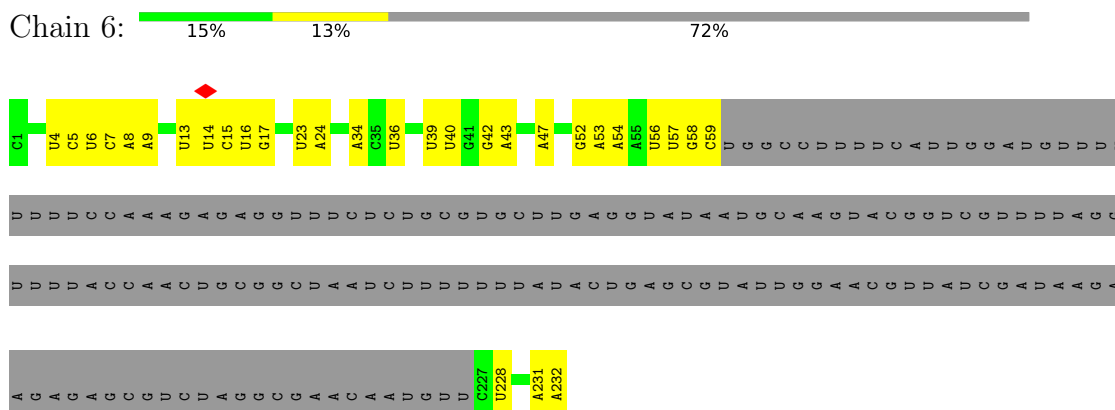

- Molecule 3: 60S ribosomal protein L13-A

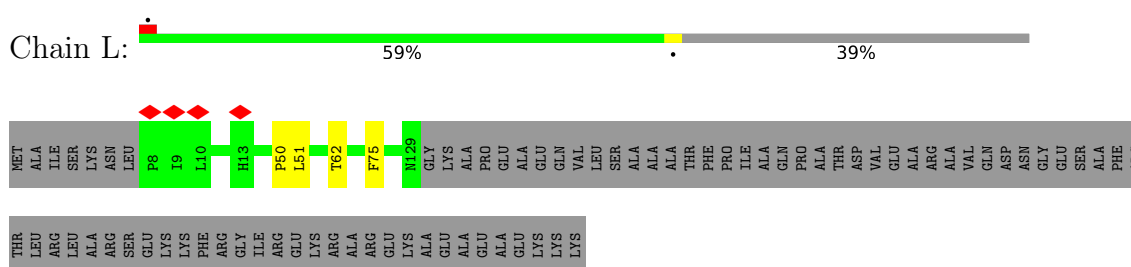

- Molecule 4: 60S ribosomal protein L14-A



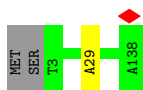

• Molecule 5: 60S ribosomal protein L15-A

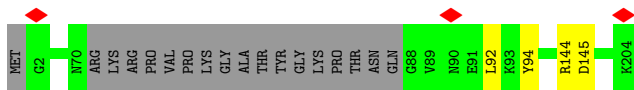
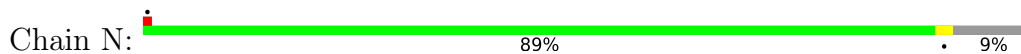

• Molecule 6: 60S ribosomal protein L18-A

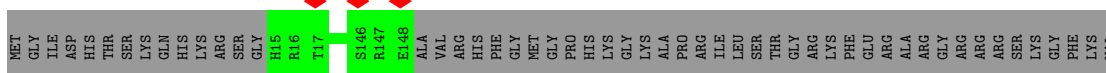

• Molecule 7: 60S ribosomal protein L19-A

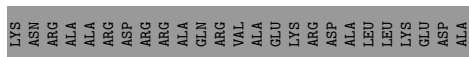
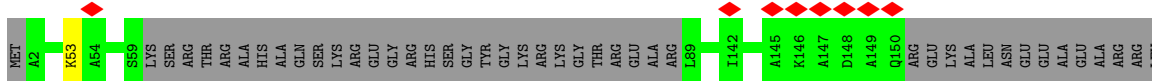

• Molecule 8: 60S ribosomal protein L20-A



• Molecule 9: 60S ribosomal protein L21-A

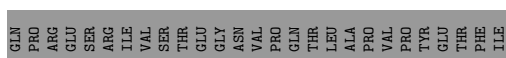
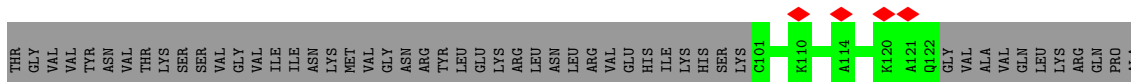
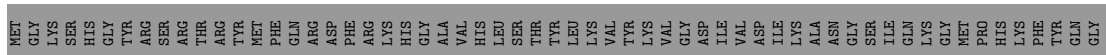

• Molecule 10: 60S ribosomal protein L22-A

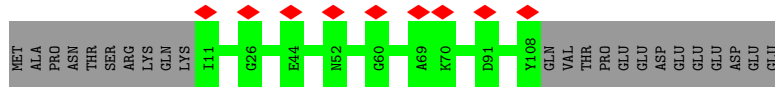
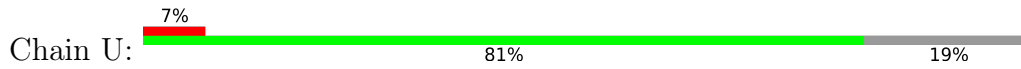

- Molecule 11: 60S ribosomal protein L27-A



- Molecule 12: 60S ribosomal protein L30

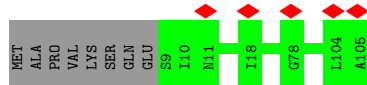
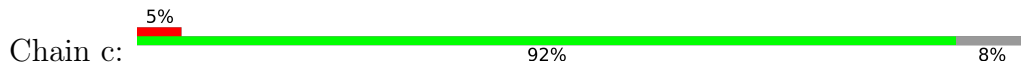

- Molecule 13: 60S ribosomal protein L31-A

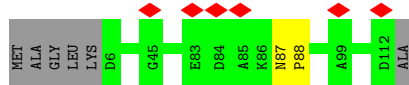
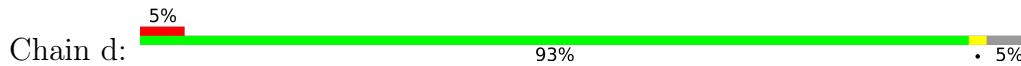

- Molecule 14: 60S ribosomal protein L32

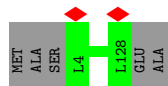

- Molecule 15: 60S ribosomal protein L33-A



- Molecule 16: 60S ribosomal protein L34-A

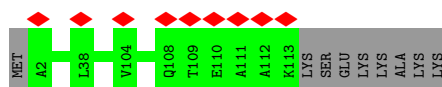



- Molecule 17: 60S ribosomal protein L36-B

Chain i:  71% 28%

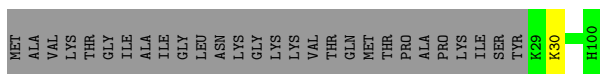

- Molecule 18: 60S ribosomal protein L37-A

Chain j:  82% 17%

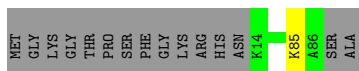

- Molecule 19: 60S ribosomal protein L38

Chain k:  97%



- Molecule 20: 60S ribosomal protein L6-A

Chain E:  89% 11%

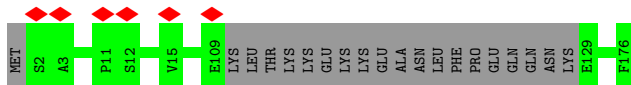

- Molecule 21: 60S ribosomal protein L8-A

Chain G:  71% 28%

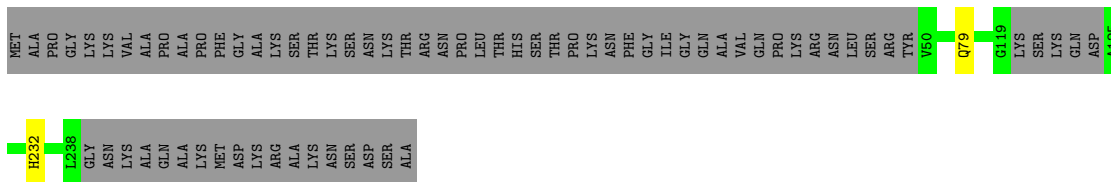

- Molecule 22: 60S ribosomal protein L16-A

Chain O:  83% 16%



- Molecule 23: 60S ribosomal protein L23-A

Chain V:  7% 97%

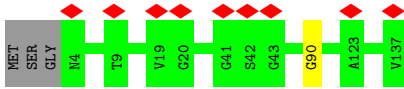

- Molecule 24: 60S ribosomal protein L25

Chain X: 98%



- Molecule 25: 60S ribosomal protein L26-A

Chain Y: 99%



- Molecule 26: 60S ribosomal protein L35-A

Chain h: 97%

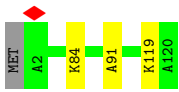

- Molecule 27: 60S ribosomal protein L3

Chain B: 87% 12%

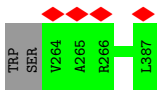
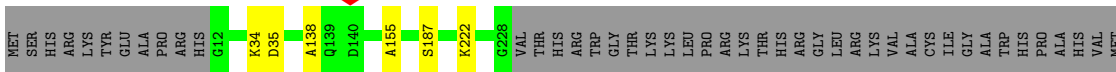

- Molecule 28: 60S ribosomal protein L4-A

Chain C: 97%



- Molecule 29: 60S ribosomal protein L9-A

Chain H: 99%

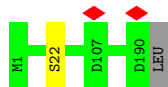

• Molecule 30: Ribosome biogenesis protein BRX1

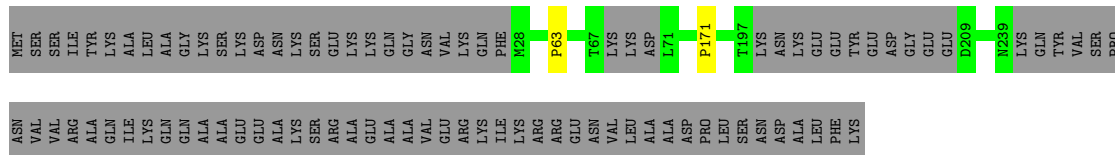

• Molecule 31: Proteasome-interacting protein CIC1

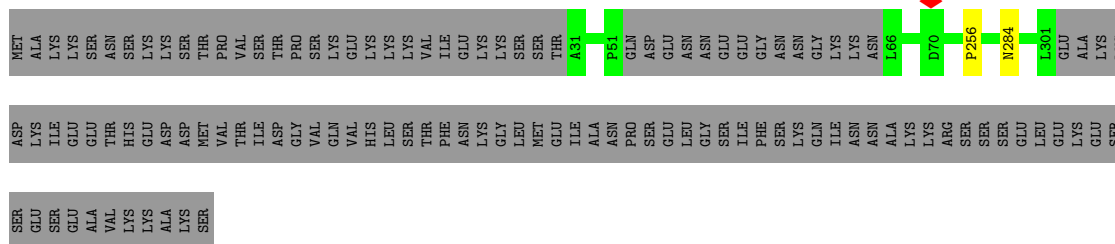

• Molecule 32: Ribosome biogenesis protein ERB1

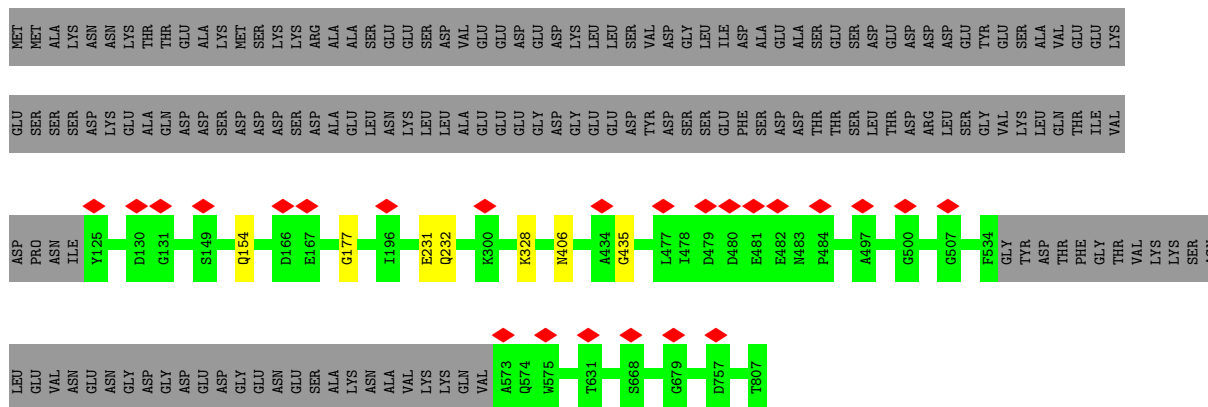
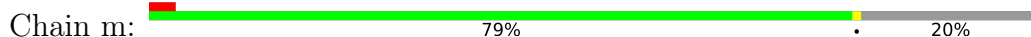

• Molecule 33: ATP-dependent RNA helicase HAS1

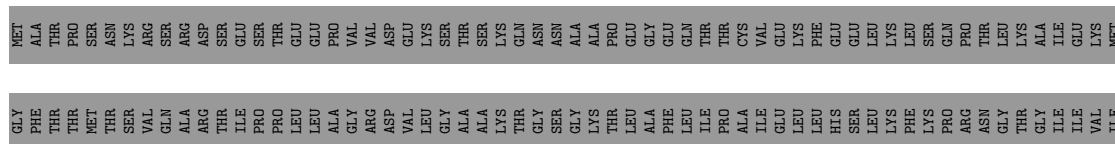

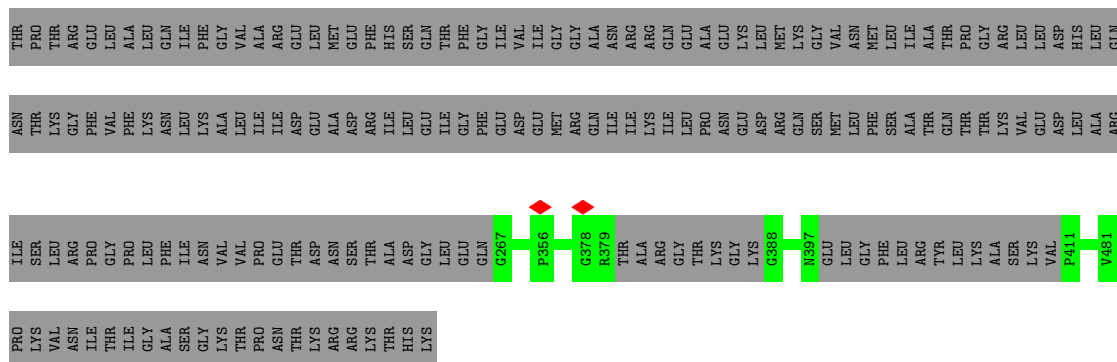

• Molecule 34: Ribosome assembly factor MRT4

Chain W: 97%

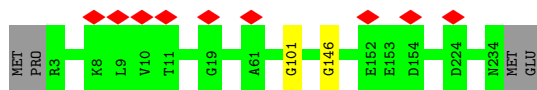

• Molecule 35: 60S ribosome subunit biogenesis protein NIP7

Chain I: 23%

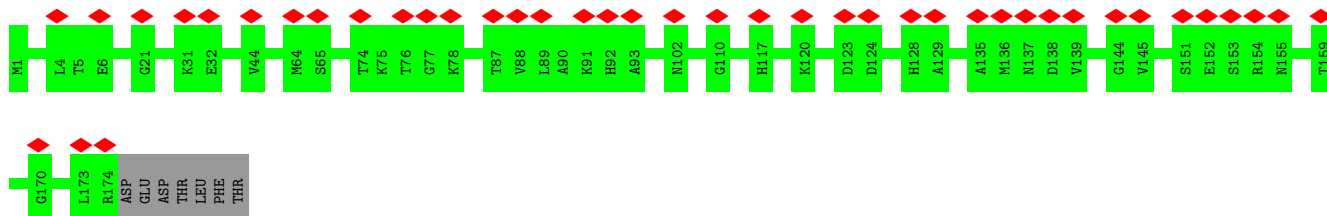

• Molecule 36: Nucleolar GTP-binding protein 1

Chain b: 10%

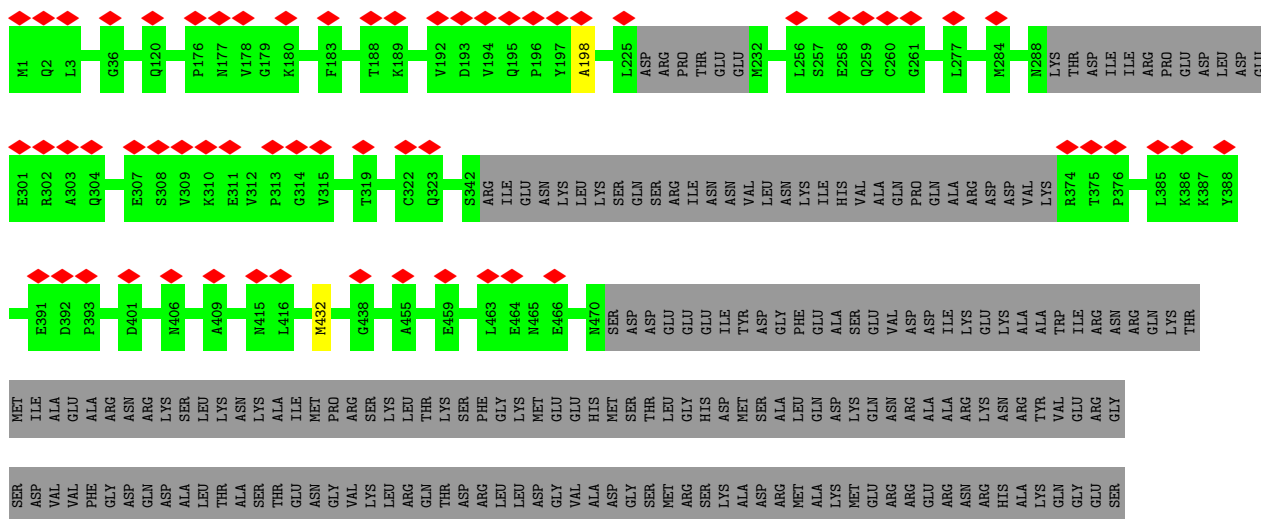





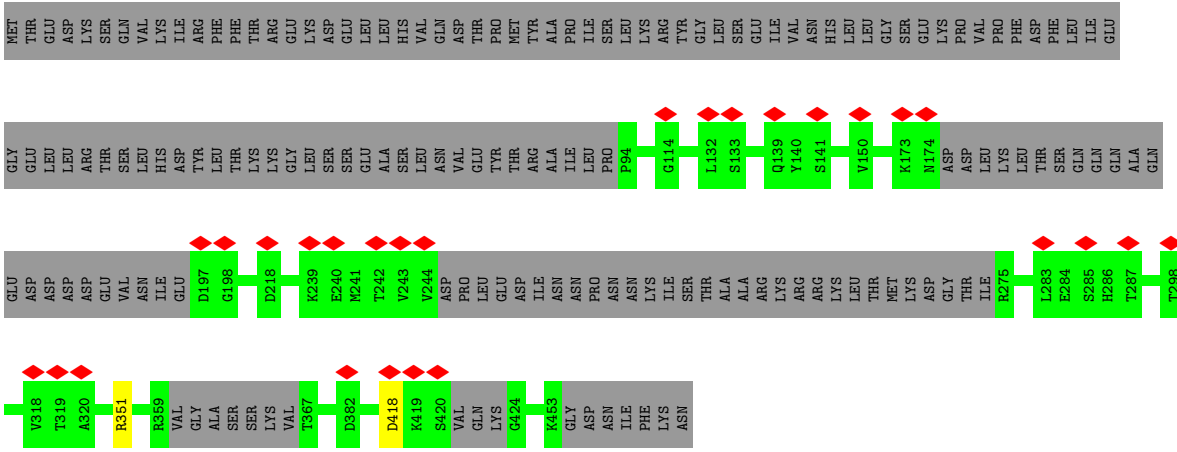

● Molecule 45: 25S rRNA (cytosine(2870)-C(5))-methyltransferase

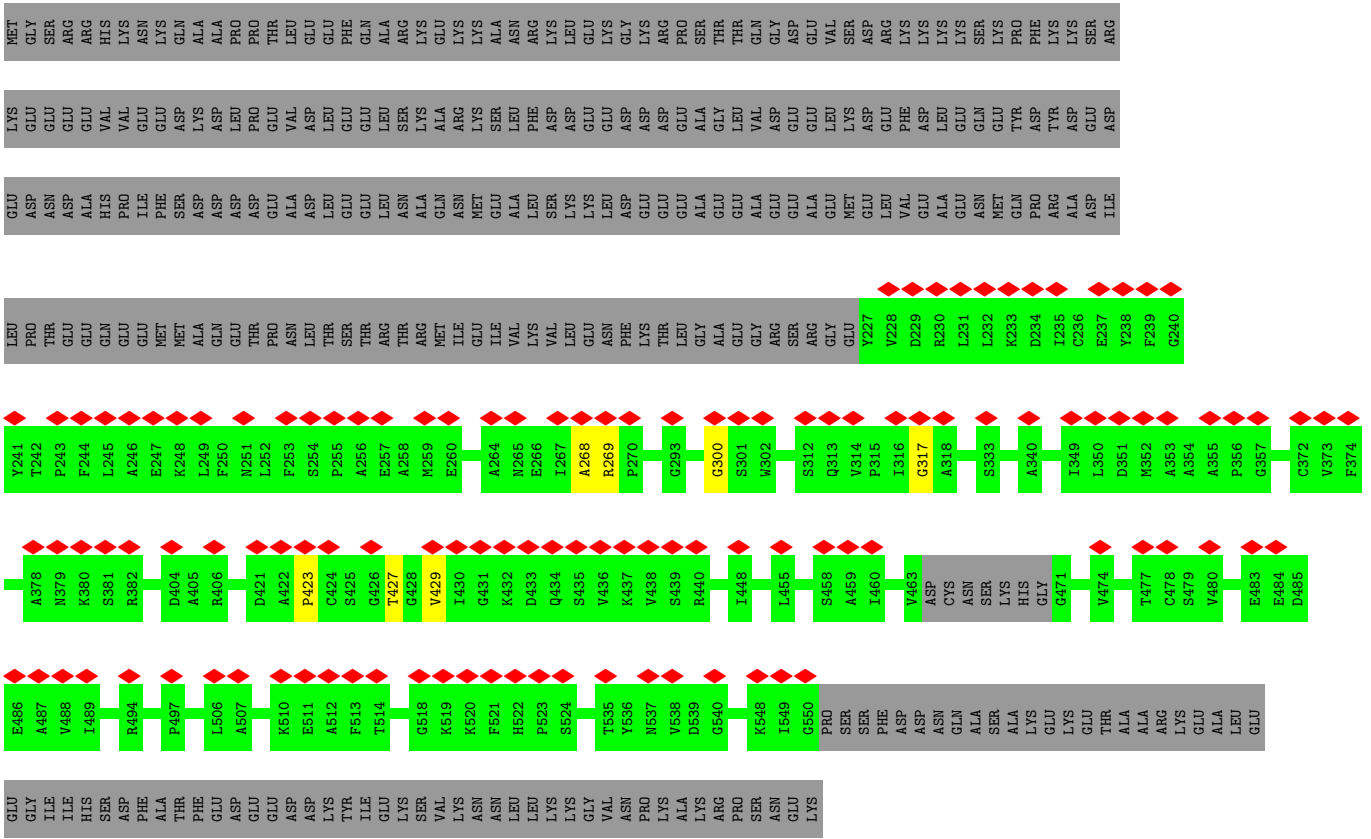

● Molecule 46: Ribosome biogenesis protein RLP24

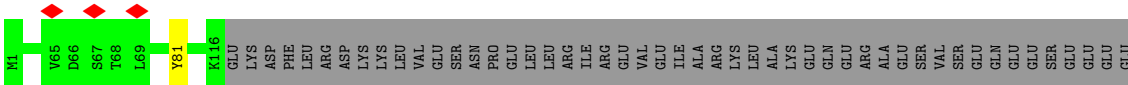





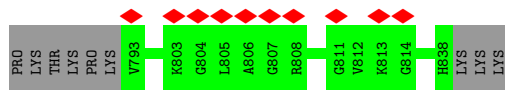

• Molecule 49: Nucleolar complex-associated protein 3

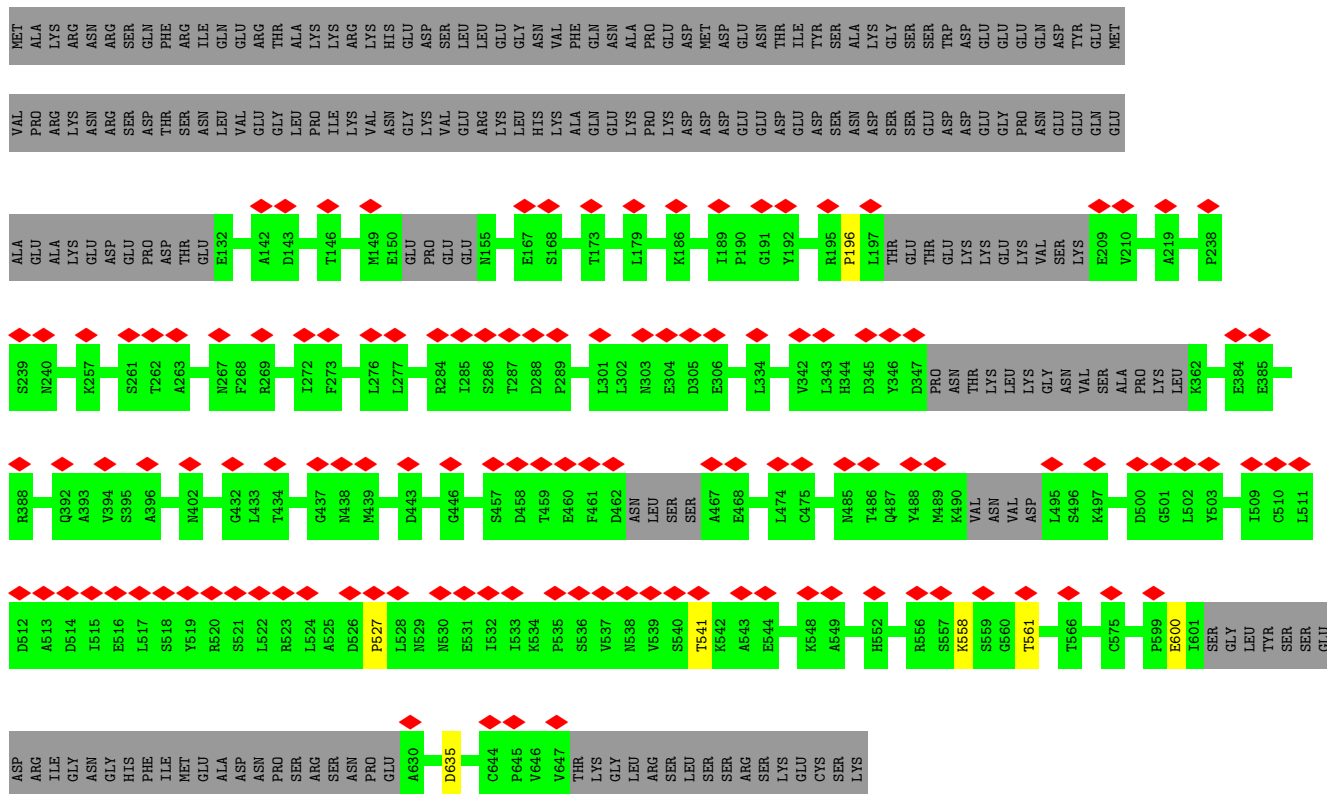

• Molecule 50: rRNA-processing protein EBP2

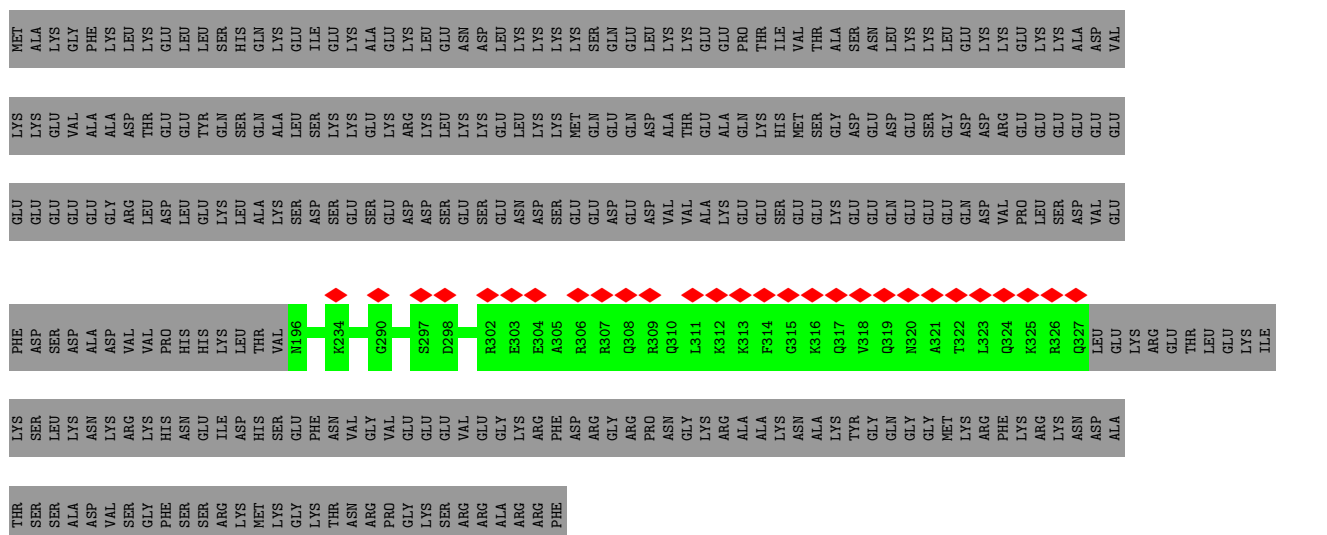



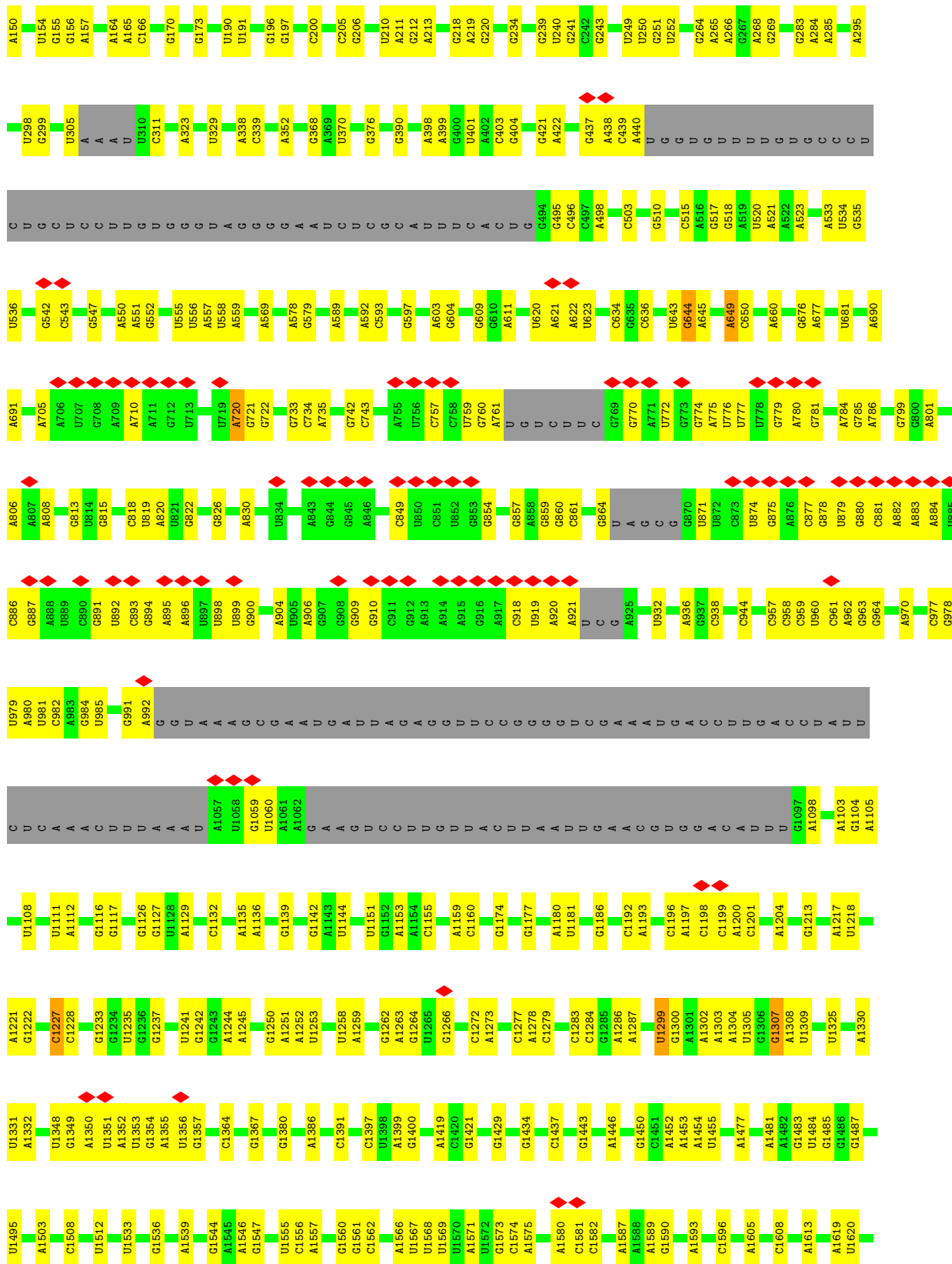

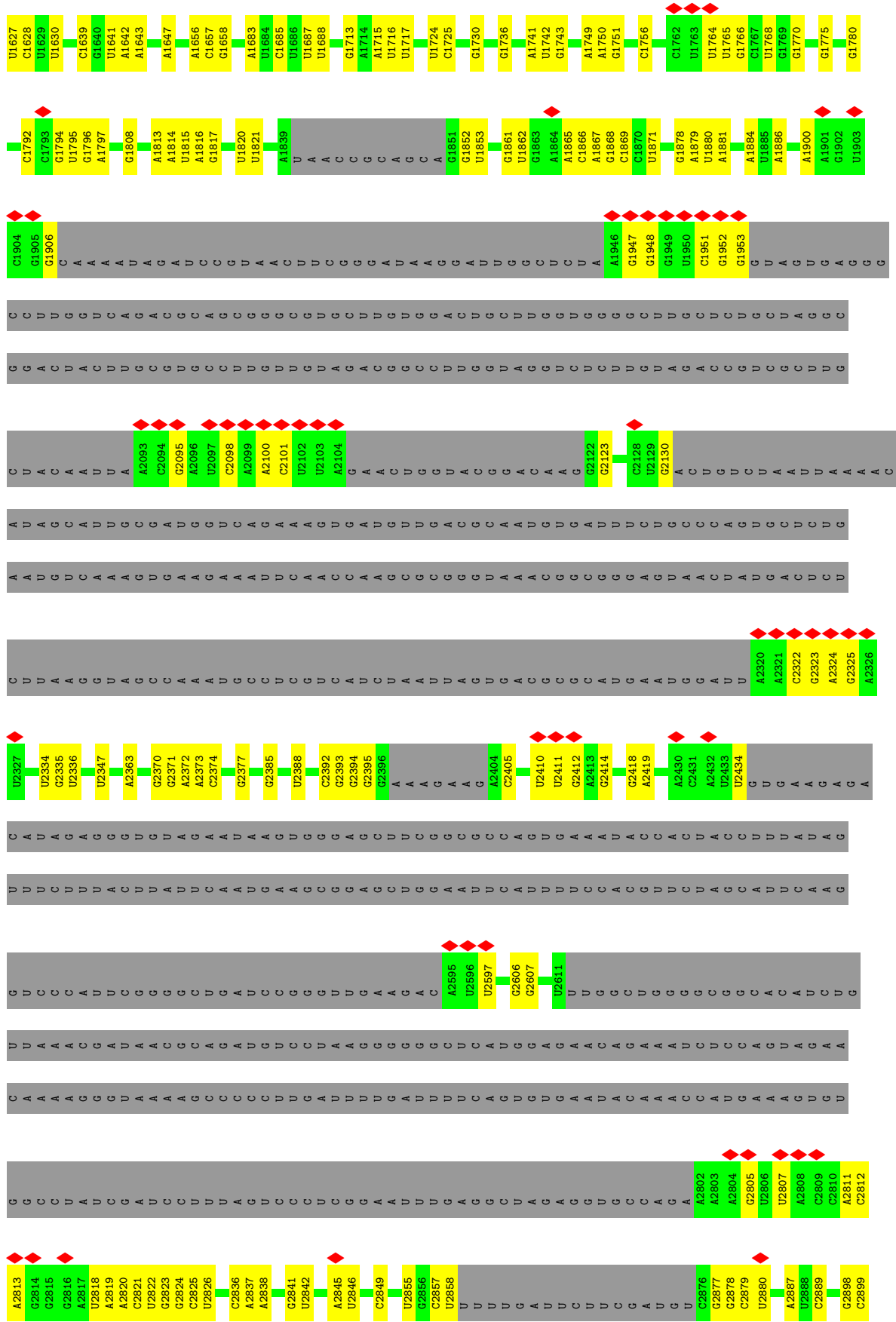

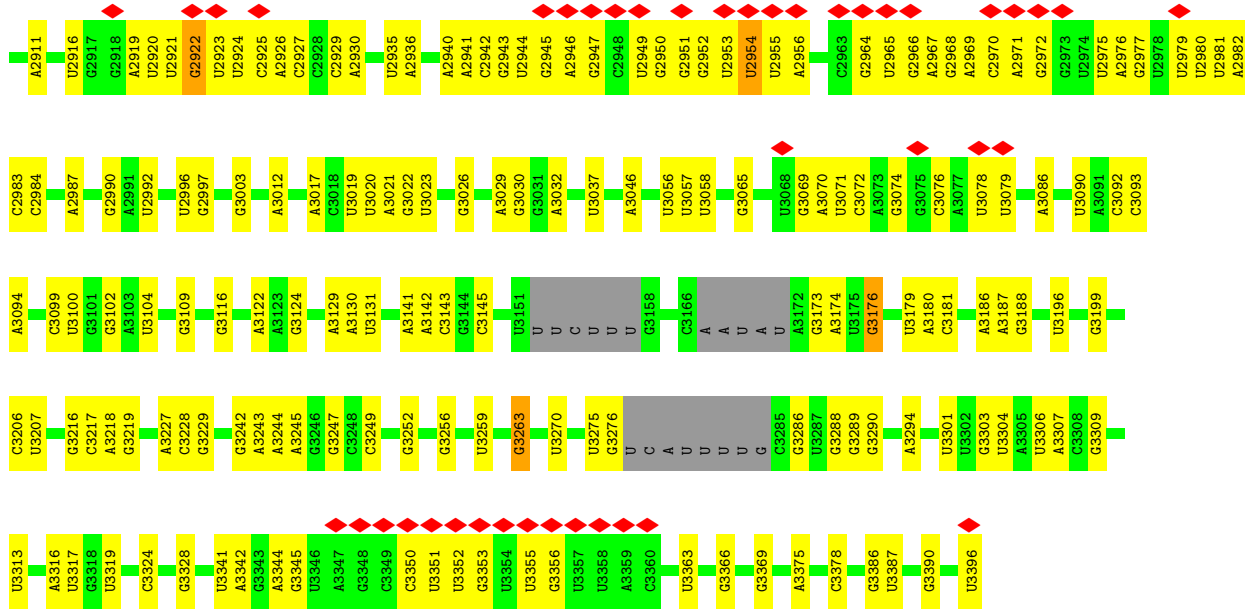

• Molecule 56: 60S ribosomal protein L7-A

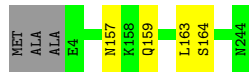

• Molecule 57: 60S ribosomal protein L17-A

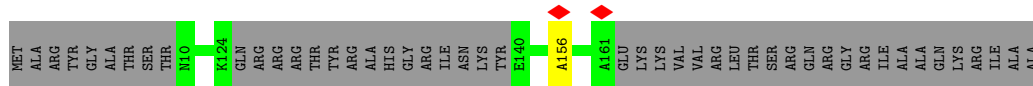

## 4 Experimental information

Property	Value	Source
EM reconstruction method	SINGLE PARTICLE	Depositor
Imposed symmetry	POINT, C1	Depositor
Number of particles used	37251	Depositor
Resolution determination method	FSC 0.143 CUT-OFF	Depositor
CTF correction method	NONE	Depositor
Microscope	FEI TITAN KRIOS	Depositor
Voltage (kV)	300	Depositor
Electron dose ( $e^-/\text{\AA}^2$ )	27	Depositor
Minimum defocus (nm)	Not provided	
Maximum defocus (nm)	Not provided	
Magnification	Not provided	
Image detector	FEI FALCON II (4k x 4k)	Depositor
Maximum map value	0.124	Depositor
Minimum map value	-0.041	Depositor
Average map value	0.001	Depositor
Map value standard deviation	0.007	Depositor
Recommended contour level	0.025	Depositor
Map size ( $\text{\AA}$ )	455.28, 455.28, 455.28	wwPDB
Map dimensions	420, 420, 420	wwPDB
Map angles ( $^\circ$ )	90.0, 90.0, 90.0	wwPDB
Pixel spacing ( $\text{\AA}$ )	1.084, 1.084, 1.084	Depositor

## 5 Model quality i

### 5.1 Standard geometry i

The Z score for a bond length (or angle) is the number of standard deviations the observed value is removed from the expected value. A bond length (or angle) with  $|Z| > 5$  is considered an outlier worth inspection. RMSZ is the root-mean-square of all Z scores of the bond lengths (or angles).

Mol	Chain	Bond lengths		Bond angles	
		RMSZ	# Z  >5	RMSZ	# Z  >5
1	2	0.25	0/2053	0.87	1/3156 (0.0%)
2	6	0.29	0/843	0.92	0/1292
3	L	0.36	0/486	0.61	0/604
4	M	0.35	0/543	0.55	0/677
5	N	0.34	0/742	0.59	0/924
6	Q	0.38	0/535	0.55	0/667
7	R	0.37	0/478	0.56	0/594
8	S	0.37	0/679	0.63	0/847
9	T	0.41	0/87	0.49	0/107
10	U	0.40	0/391	0.58	0/487
11	Z	0.37	0/539	0.65	0/672
12	c	0.38	0/387	0.54	0/482
13	d	0.36	0/427	0.57	0/532
14	e	0.36	0/499	0.60	0/622
15	f	0.32	0/423	0.58	0/527
16	g	0.36	0/447	0.58	0/557
17	i	0.36	0/287	0.59	0/357
18	j	0.35	0/291	0.61	0/362
19	k	0.36	0/307	0.60	0/382
20	E	0.37	0/622	0.60	0/774
21	G	0.38	0/734	0.64	0/914
22	O	0.25	0/787	0.40	0/982
23	V	0.37	0/535	0.59	0/667
24	X	0.37	0/563	0.59	0/702
25	Y	0.36	0/503	0.58	0/627
26	h	0.35	0/475	0.56	0/592
27	B	0.38	0/1362	0.63	0/1699
28	C	0.36	0/1435	0.59	0/1792
29	H	0.35	0/759	0.57	0/947
30	A	0.35	0/789	0.58	0/981
31	K	0.39	0/1026	0.61	0/1279
32	m	0.38	0/2578	0.61	0/3219
33	D	0.39	0/773	0.58	0/961
34	W	0.39	0/927	0.59	0/1157

Mol	Chain	Bond lengths		Bond angles	
		RMSZ	# Z  >5	RMSZ	# Z  >5
35	l	0.40	0/694	0.59	0/864
36	b	0.39	0/1680	0.57	0/2093
37	o	0.37	0/531	0.62	0/662
38	n	0.36	0/1640	0.55	0/2043
39	r	0.35	0/701	0.56	0/871
40	s	0.35	0/143	0.54	0/177
41	t	0.38	0/1158	0.58	0/1444
42	y	0.38	0/899	0.58	0/1122
43	z	0.37	0/219	0.54	0/272
44	p	0.38	0/1187	0.62	0/1475
45	q	0.42	0/1266	0.64	0/1579
46	u	0.36	0/463	0.56	0/577
47	v	0.35	0/517	0.54	0/641
48	w	0.38	0/1739	0.57	0/2165
49	I	0.40	0/1797	0.58	0/2234
50	J	0.37	0/527	0.56	0/657
51	x	0.40	0/1064	0.67	0/1323
52	3	0.36	0/691	0.63	0/862
53	4	0.29	0/878	0.75	2/1094 (0.2%)
54	5	0.36	0/1536	0.57	0/1913
55	1	0.49	4/31669 (0.0%)	0.91	24/48668 (0.0%)
56	F	0.35	0/963	0.57	0/1202
57	P	0.34	0/546	0.56	0/679
All	All	0.42	4/76820 (0.0%)	0.77	27/105758 (0.0%)

Chiral center outliers are detected by calculating the chiral volume of a chiral center and verifying if the center is modelled as a planar moiety or with the opposite hand. A planarity outlier is detected by checking planarity of atoms in a peptide group, atoms in a mainchain group or atoms of a sidechain that are expected to be planar.

Mol	Chain	#Chirality outliers	#Planarity outliers
5	N	0	1
53	4	0	2
All	All	0	3

All (4) bond length outliers are listed below:

Mol	Chain	Res	Type	Atoms	Z	Observed(Å)	Ideal(Å)
55	1	3263	G	O3'-P	-54.38	0.95	1.61
55	1	3301	U	O3'-P	37.14	2.05	1.61
55	1	3176	G	O3'-P	29.07	1.96	1.61
55	1	3145	C	O3'-P	-15.46	1.42	1.61



The worst 5 of 27 bond angle outliers are listed below:

Mol	Chain	Res	Type	Atoms	Z	Observed(°)	Ideal(°)
55	1	3263	G	P-O3'-C3'	-28.09	85.99	119.70
55	1	3263	G	OP1-P-O3'	-18.73	64.00	105.20
55	1	3145	C	P-O3'-C3'	-17.54	98.66	119.70
55	1	3301	U	P-O3'-C3'	-15.61	100.97	119.70
55	1	3263	G	O3'-P-O5'	13.97	130.55	104.00

There are no chirality outliers.

All (3) planarity outliers are listed below:

Mol	Chain	Res	Type	Group
53	4	135	TYR	Peptide
53	4	136	LEU	Peptide
5	N	92	LEU	Peptide

## 5.2 Too-close contacts [i](#)

Due to software issues we are unable to calculate clashes - this section is therefore empty.

## 5.3 Torsion angles [i](#)

### 5.3.1 Protein backbone [i](#)

In the following table, the Percentiles column shows the percent Ramachandran outliers of the chain as a percentile score with respect to all PDB entries followed by that with respect to all EM entries.

The Analysed column shows the number of residues for which the backbone conformation was analysed, and the total number of residues.

Mol	Chain	Analysed	Favoured	Allowed	Outliers	Percentiles	
3	L	119/199 (60%)	107 (90%)	8 (7%)	4 (3%)	3	29
4	M	134/138 (97%)	123 (92%)	10 (8%)	1 (1%)	22	62
5	N	182/204 (89%)	166 (91%)	13 (7%)	3 (2%)	9	45
6	Q	132/186 (71%)	123 (93%)	9 (7%)	0	100	100
7	R	116/189 (61%)	109 (94%)	6 (5%)	1 (1%)	17	56
8	S	168/172 (98%)	151 (90%)	13 (8%)	4 (2%)	6	36
9	T	20/160 (12%)	20 (100%)	0	0	100	100

*Continued on next page...*

Continued from previous page...

Mol	Chain	Analysed	Favoured	Allowed	Outliers	Percentiles	
10	U	96/121 (79%)	90 (94%)	6 (6%)	0	100	100
11	Z	133/136 (98%)	117 (88%)	13 (10%)	3 (2%)	6	37
12	c	95/105 (90%)	92 (97%)	3 (3%)	0	100	100
13	d	105/113 (93%)	96 (91%)	7 (7%)	2 (2%)	8	41
14	e	123/130 (95%)	120 (98%)	3 (2%)	0	100	100
15	f	104/107 (97%)	100 (96%)	4 (4%)	0	100	100
16	g	110/121 (91%)	106 (96%)	4 (4%)	0	100	100
17	i	70/100 (70%)	61 (87%)	8 (11%)	1 (1%)	11	47
18	j	71/88 (81%)	67 (94%)	3 (4%)	1 (1%)	11	47
19	k	75/78 (96%)	69 (92%)	5 (7%)	1 (1%)	12	48
20	E	152/176 (86%)	131 (86%)	21 (14%)	0	100	100
21	G	180/256 (70%)	166 (92%)	12 (7%)	2 (1%)	14	52
22	O	195/199 (98%)	125 (64%)	38 (20%)	32 (16%)	0	3
23	V	132/137 (96%)	123 (93%)	8 (6%)	1 (1%)	19	60
24	X	139/142 (98%)	122 (88%)	15 (11%)	2 (1%)	11	47
25	Y	124/127 (98%)	115 (93%)	9 (7%)	0	100	100
26	h	117/120 (98%)	108 (92%)	6 (5%)	3 (3%)	5	35
27	B	337/387 (87%)	293 (87%)	38 (11%)	6 (2%)	8	42
28	C	357/362 (99%)	317 (89%)	33 (9%)	7 (2%)	7	40
29	H	188/191 (98%)	172 (92%)	15 (8%)	1 (0%)	29	68
30	A	192/291 (66%)	174 (91%)	16 (8%)	2 (1%)	15	54
31	K	253/376 (67%)	231 (91%)	20 (8%)	2 (1%)	19	60
32	m	641/807 (79%)	577 (90%)	57 (9%)	7 (1%)	14	52
33	D	188/505 (37%)	167 (89%)	21 (11%)	0	100	100
34	W	230/236 (98%)	214 (93%)	14 (6%)	2 (1%)	17	56
35	l	170/181 (94%)	156 (92%)	14 (8%)	0	100	100
36	b	413/647 (64%)	387 (94%)	24 (6%)	2 (0%)	29	68
37	o	131/220 (60%)	121 (92%)	9 (7%)	1 (1%)	19	60
38	n	403/605 (67%)	373 (93%)	28 (7%)	2 (0%)	29	68
39	r	170/261 (65%)	149 (88%)	20 (12%)	1 (1%)	25	65
40	s	34/520 (6%)	33 (97%)	1 (3%)	0	100	100

Continued on next page...

Continued from previous page...

Mol	Chain	Analysed	Favoured	Allowed	Outliers	Percentiles	
41	t	286/322 (89%)	260 (91%)	20 (7%)	6 (2%)	7	39
42	y	223/245 (91%)	211 (95%)	11 (5%)	1 (0%)	34	72
43	z	53/106 (50%)	53 (100%)	0	0	100	100
44	p	288/460 (63%)	262 (91%)	24 (8%)	2 (1%)	22	62
45	q	313/618 (51%)	270 (86%)	36 (12%)	7 (2%)	6	38
46	u	114/199 (57%)	107 (94%)	6 (5%)	1 (1%)	17	56
47	v	124/231 (54%)	118 (95%)	6 (5%)	0	100	100
48	w	426/841 (51%)	389 (91%)	37 (9%)	0	100	100
49	I	437/663 (66%)	392 (90%)	38 (9%)	7 (2%)	9	45
50	J	130/427 (30%)	122 (94%)	8 (6%)	0	100	100
51	x	259/295 (88%)	220 (85%)	28 (11%)	11 (4%)	3	25
52	3	171/306 (56%)	148 (86%)	19 (11%)	4 (2%)	6	37
53	4	216/278 (78%)	197 (91%)	17 (8%)	2 (1%)	17	56
54	5	377/463 (81%)	356 (94%)	19 (5%)	2 (0%)	29	68
56	F	239/244 (98%)	227 (95%)	8 (3%)	4 (2%)	9	43
57	P	133/184 (72%)	127 (96%)	5 (4%)	1 (1%)	19	60
All	All	10388/14975 (69%)	9430 (91%)	816 (8%)	142 (1%)	15	47

5 of 142 Ramachandran outliers are listed below:

Mol	Chain	Res	Type
3	L	51	LEU
5	N	145	ASP
8	S	13	ARG
11	Z	103	GLN
19	k	33	LYS

### 5.3.2 Protein sidechains [i](#)

There are no protein residues with a non-rotameric sidechain to report in this entry.

### 5.3.3 RNA [i](#)

Mol	Chain	Analysed	Backbone Outliers	Pucker Outliers
1	2	157/158 (99%)	35 (22%)	0

Continued on next page...

*Continued from previous page...*

Mol	Chain	Analysed	Backbone Outliers	Pucker Outliers
2	6	63/232 (27%)	30 (47%)	0
55	1	2416/3396 (71%)	721 (29%)	0
All	All	2636/3786 (69%)	786 (29%)	0

5 of 786 RNA backbone outliers are listed below:

Mol	Chain	Res	Type
1	2	34	U
1	2	35	C
1	2	39	G
1	2	51	G
1	2	59	A

There are no RNA pucker outliers to report.

#### 5.4 Non-standard residues in protein, DNA, RNA chains [i](#)

There are no non-standard protein/DNA/RNA residues in this entry.

#### 5.5 Carbohydrates [i](#)

There are no monosaccharides in this entry.

#### 5.6 Ligand geometry [i](#)

There are no ligands in this entry.

#### 5.7 Other polymers [i](#)

There are no such residues in this entry.

#### 5.8 Polymer linkage issues [i](#)

The following chains have linkage breaks:

Mol	Chain	Number of breaks
55	1	5
35	1	1

*Continued on next page...*

*Continued from previous page...*

Mol	Chain	Number of breaks
3	L	1
51	x	1

The worst 5 of 8 chain breaks are listed below:

Model	Chain	Residue-1	Atom-1	Residue-2	Atom-2	Distance (Å)
1	1	135:ALA	C	136:MET	N	6.21
1	1	1792:C	O3'	1793:C	P	5.60
1	L	8:PRO	C	9:ILE	N	4.88
1	1	966:U	O3'	967:A	P	4.55
1	x	285:GLU	C	286:MET	N	3.36

## 6 Map visualisation [i](#)

This section contains visualisations of the EMDB entry EMD-3890. These allow visual inspection of the internal detail of the map and identification of artifacts.

No raw map or half-maps were deposited for this entry and therefore no images, graphs, etc. pertaining to the raw map can be shown.

### 6.1 Orthogonal projections [i](#)

#### 6.1.1 Primary map

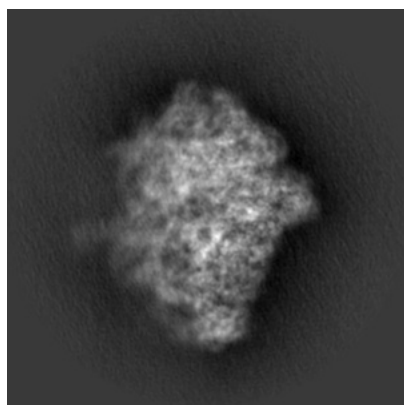

X

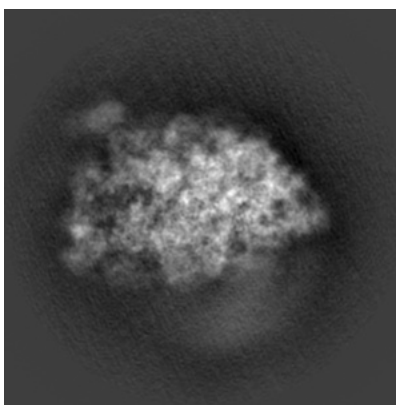

Y

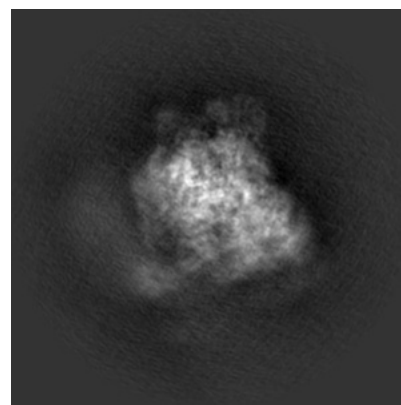

Z

The images above show the map projected in three orthogonal directions.

### 6.2 Central slices [i](#)

#### 6.2.1 Primary map

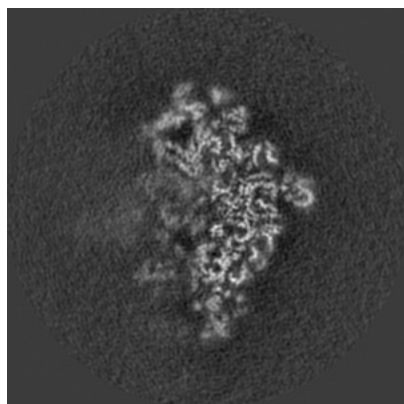

X Index: 210

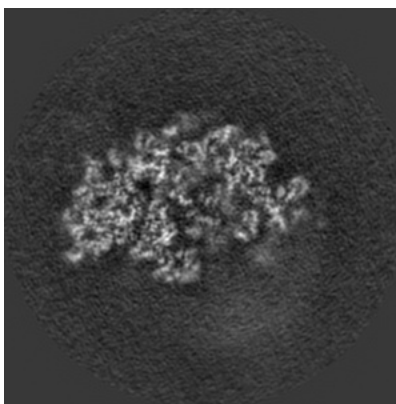

Y Index: 210

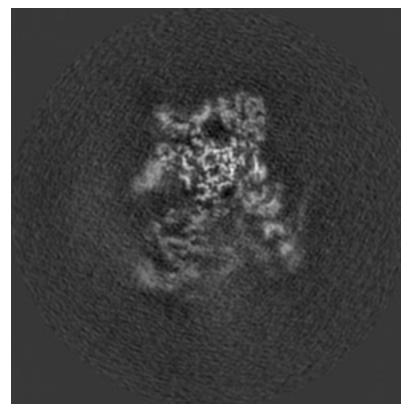

Z Index: 210

The images above show central slices of the map in three orthogonal directions.

## 6.3 Largest variance slices [i](#)

### 6.3.1 Primary map

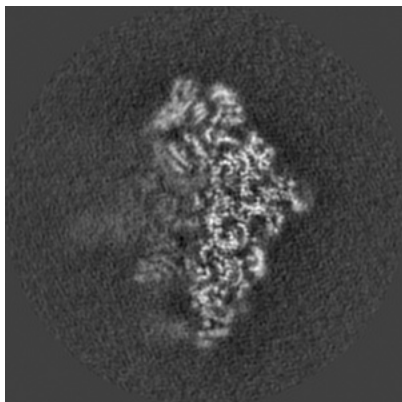

X Index: 203

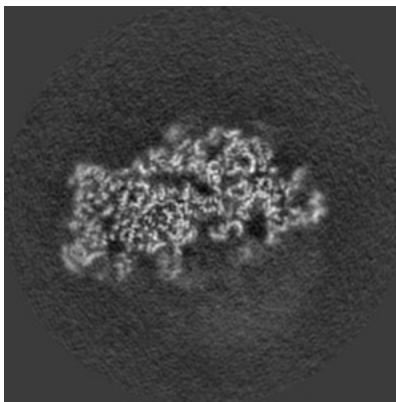

Y Index: 224

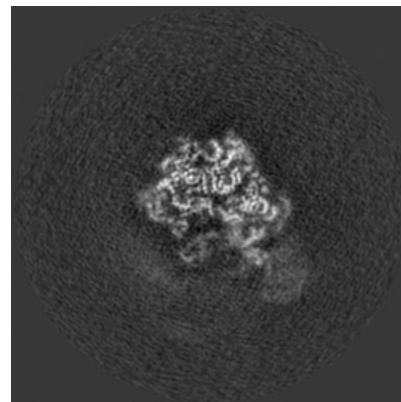

Z Index: 167

The images above show the largest variance slices of the map in three orthogonal directions.

## 6.4 Orthogonal surface views [i](#)

### 6.4.1 Primary map



X



Y



Z

The images above show the 3D surface view of the map at the recommended contour level 0.025. These images, in conjunction with the slice images, may facilitate assessment of whether an appropriate contour level has been provided.

## 6.5 Mask visualisation

This section was not generated. No masks/segmentation were deposited.



## 7 Map analysis [i](#)

This section contains the results of statistical analysis of the map.

### 7.1 Map-value distribution [i](#)

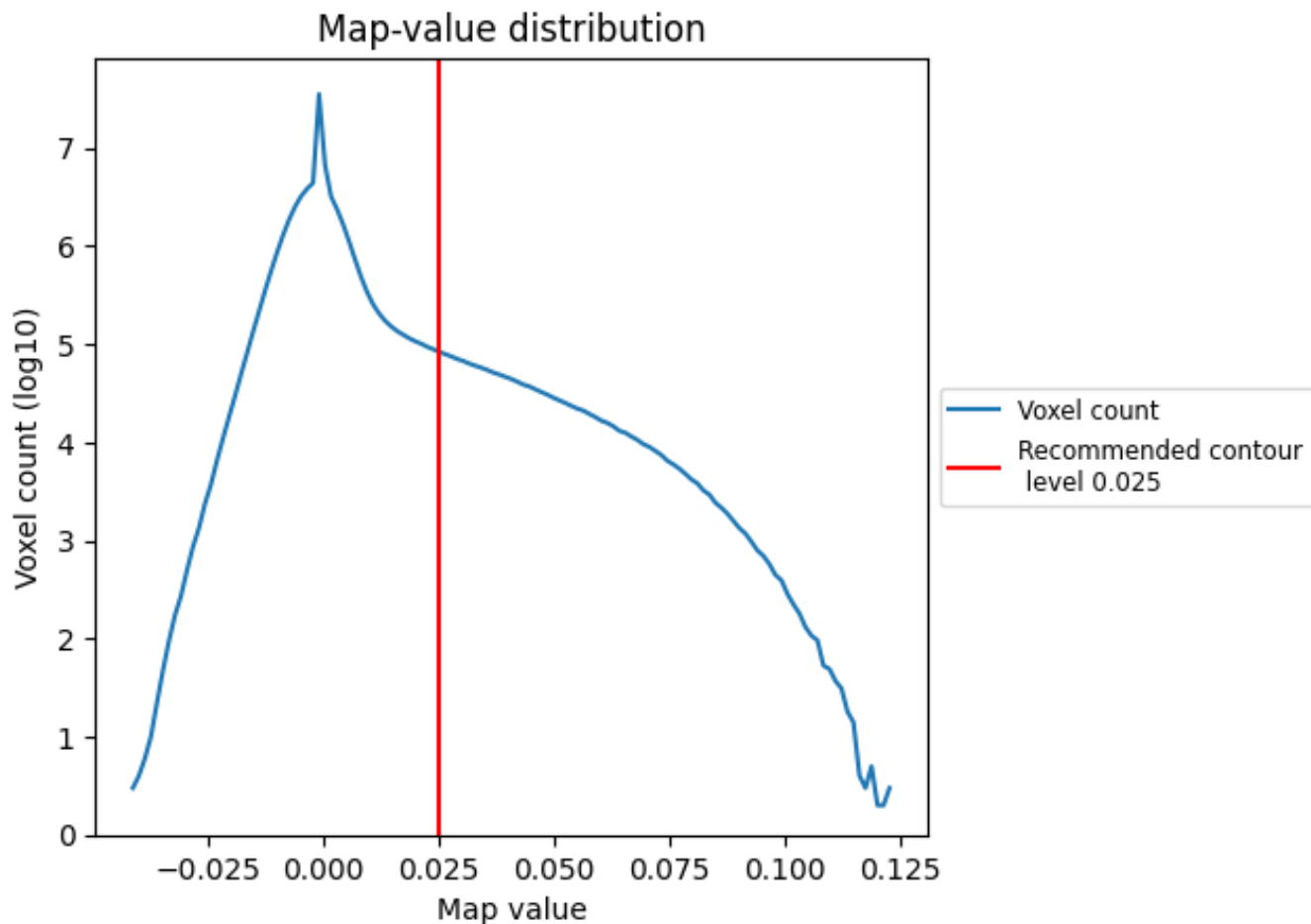

The map-value distribution is plotted in 128 intervals along the x-axis. The y-axis is logarithmic. A spike in this graph at zero usually indicates that the volume has been masked.

## 7.2 Volume estimate [i](#)

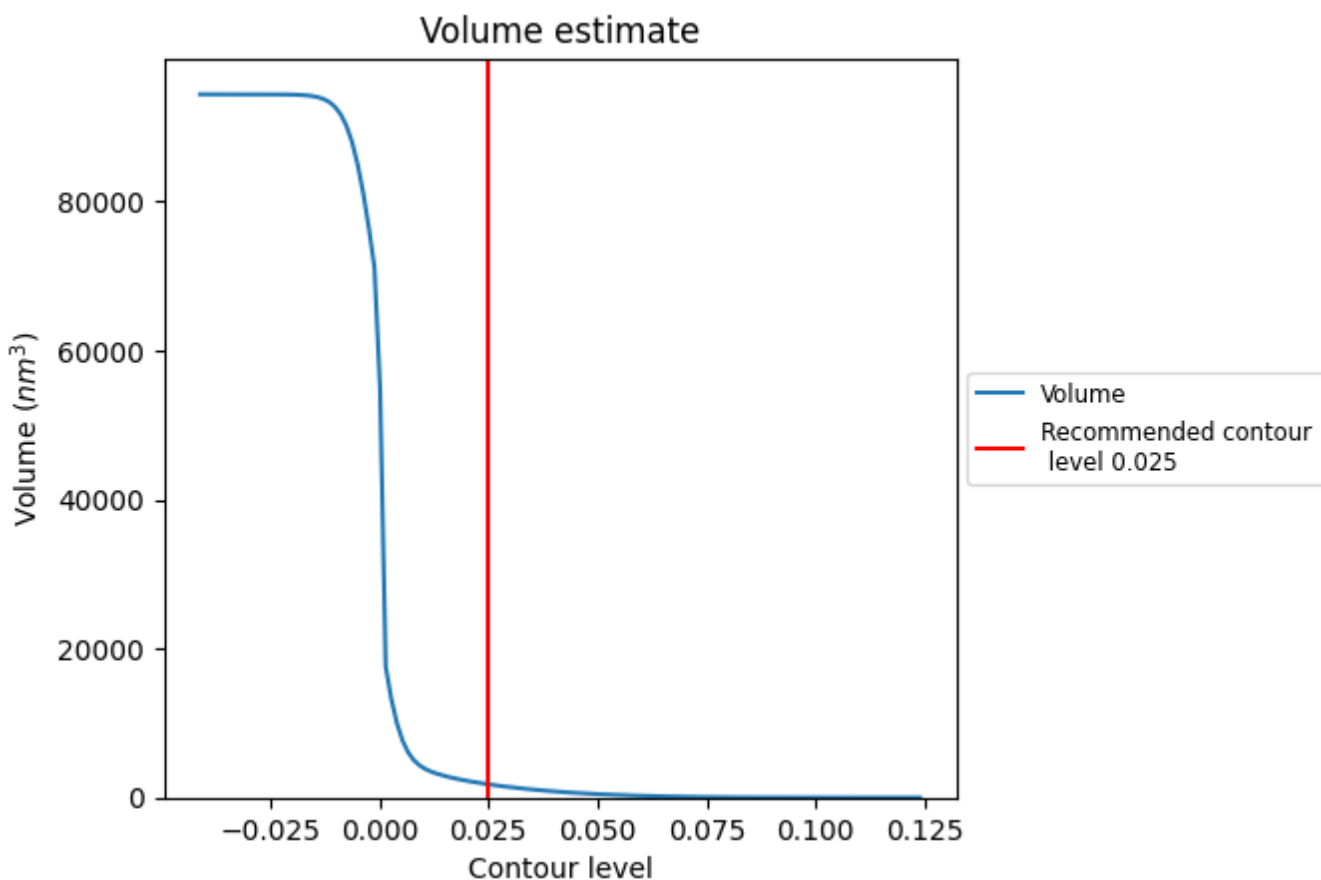

The volume at the recommended contour level is 1775  $\text{nm}^3$ ; this corresponds to an approximate mass of 1603 kDa.

The volume estimate graph shows how the enclosed volume varies with the contour level. The recommended contour level is shown as a vertical line and the intersection between the line and the curve gives the volume of the enclosed surface at the given level.

### 7.3 Rotationally averaged power spectrum [i](#)

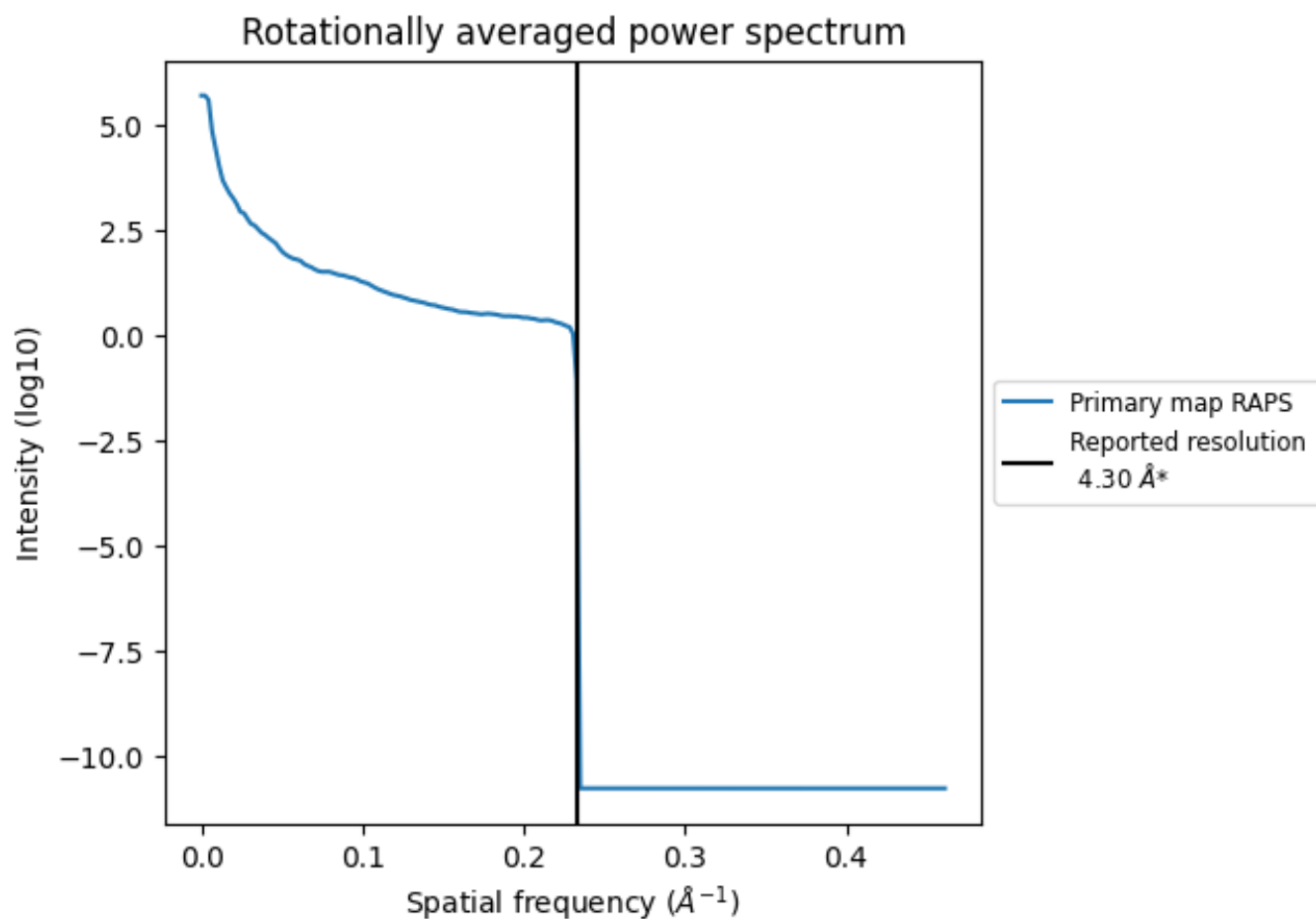

\*Reported resolution corresponds to spatial frequency of 0.233 Å<sup>-1</sup>

## 8 Fourier-Shell correlation [i](#)

Fourier-Shell Correlation (FSC) is the most commonly used method to estimate the resolution of single-particle and subtomogram-averaged maps. The shape of the curve depends on the imposed symmetry, mask and whether or not the two 3D reconstructions used were processed from a common reference. The reported resolution is shown as a black line. A curve is displayed for the half-bit criterion in addition to lines showing the 0.143 gold standard cut-off and 0.5 cut-off.

### 8.1 FSC [i](#)

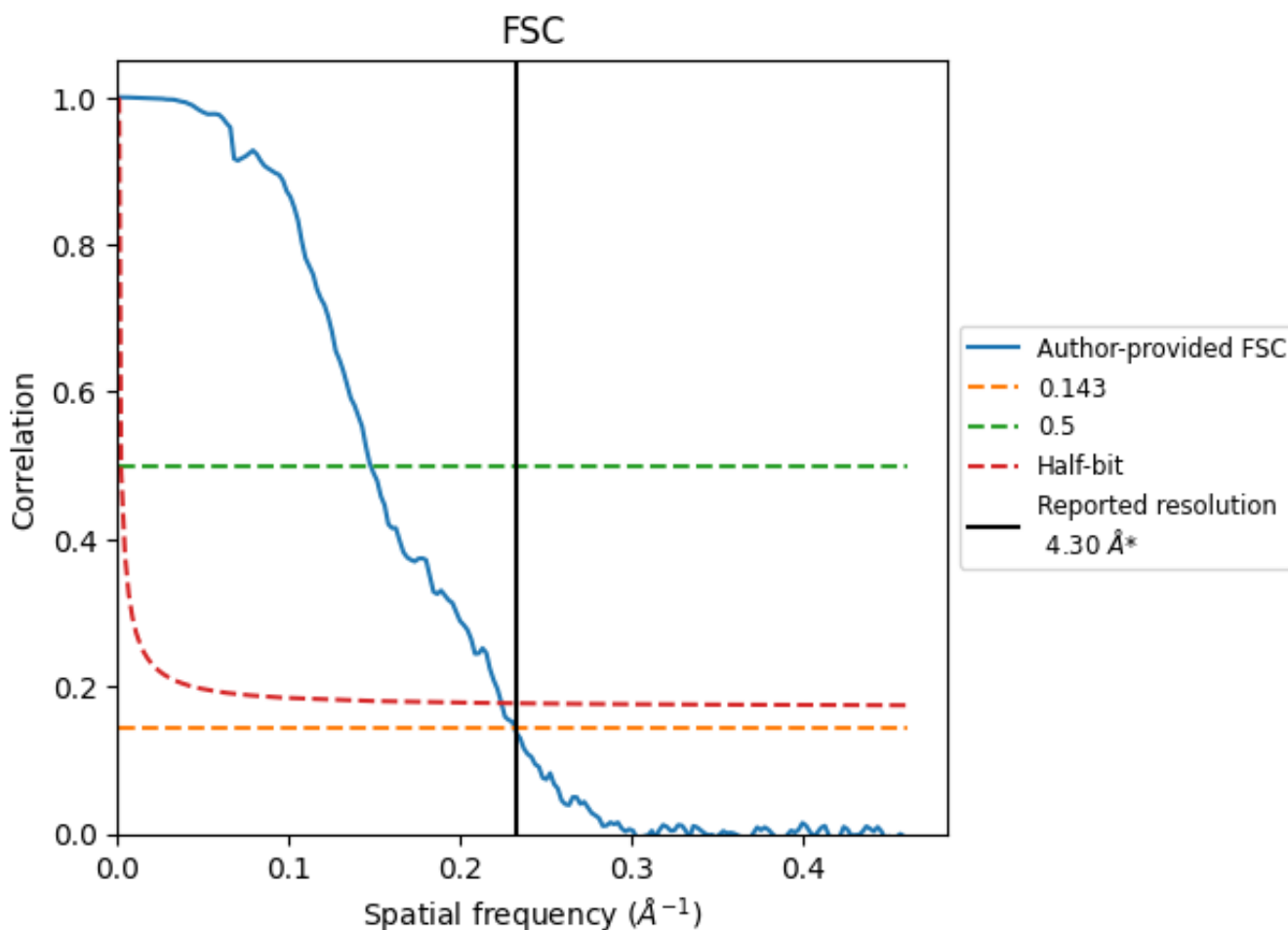

\*Reported resolution corresponds to spatial frequency of 0.233 Å<sup>-1</sup>

## 8.2 Resolution estimates [i](#)

Resolution estimate (Å)	Estimation criterion (FSC cut-off)		
	0.143	0.5	Half-bit
Reported by author	4.30	-	-
Author-provided FSC curve	4.31	6.77	4.46
Unmasked-calculated*	-	-	-

\*Resolution estimate based on FSC curve calculated by comparison of deposited half-maps.

## 9 Map-model fit [i](#)

This section contains information regarding the fit between EMDB map EMD-3890 and PDB model 6EM5. Per-residue inclusion information can be found in section 3 on page 14.

### 9.1 Map-model overlay [i](#)

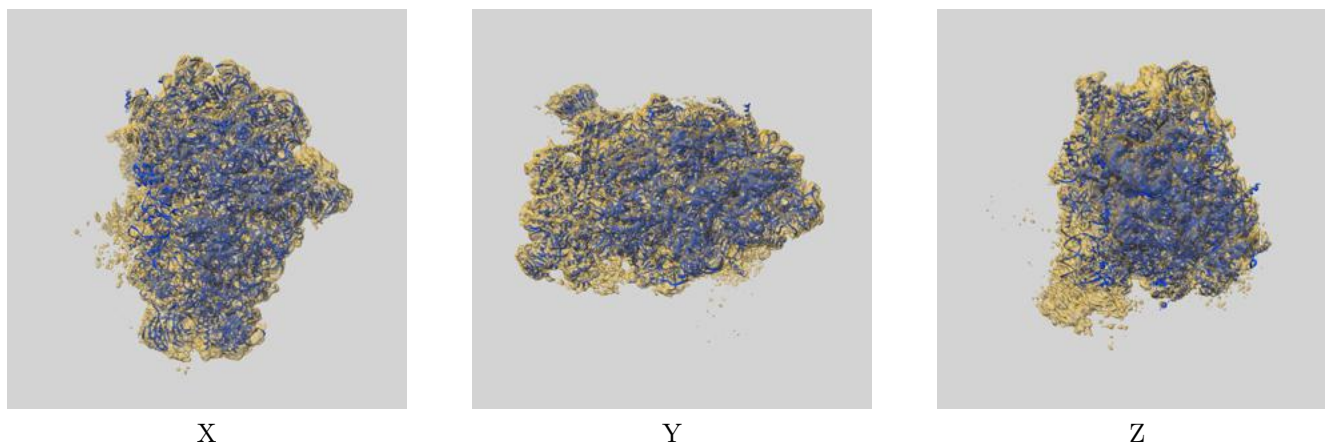

The images above show the 3D surface view of the map at the recommended contour level 0.025 at 50% transparency in yellow overlaid with a ribbon representation of the model coloured in blue. These images allow for the visual assessment of the quality of fit between the atomic model and the map.

## 9.2 Q-score mapped to coordinate model [i](#)

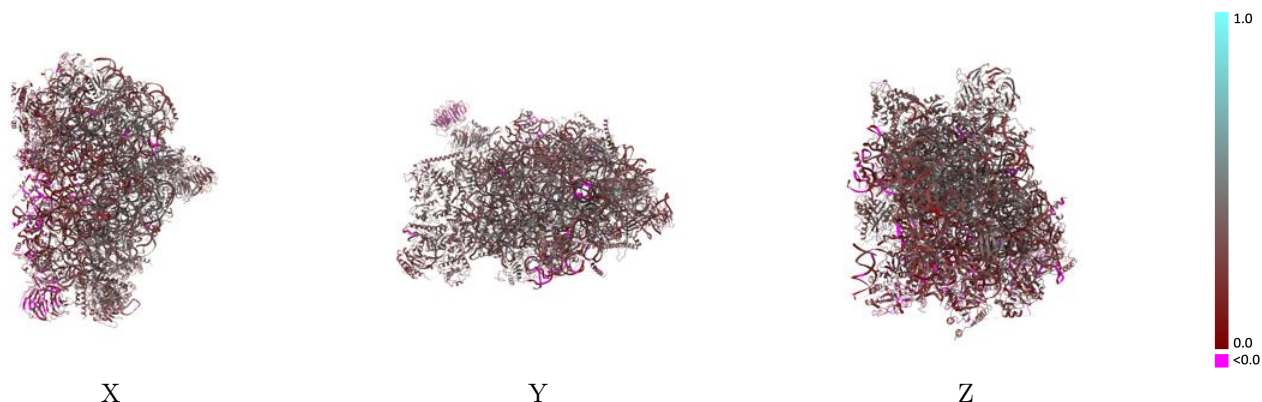

The images above show the model with each residue coloured according to its Q-score. This shows their resolvability in the map with higher Q-score values reflecting better resolvability. Please note: Q-score is calculating the resolvability of atoms, and thus high values are only expected at resolutions at which atoms can be resolved. Low Q-score values may therefore be expected for many entries.

## 9.3 Atom inclusion mapped to coordinate model [i](#)

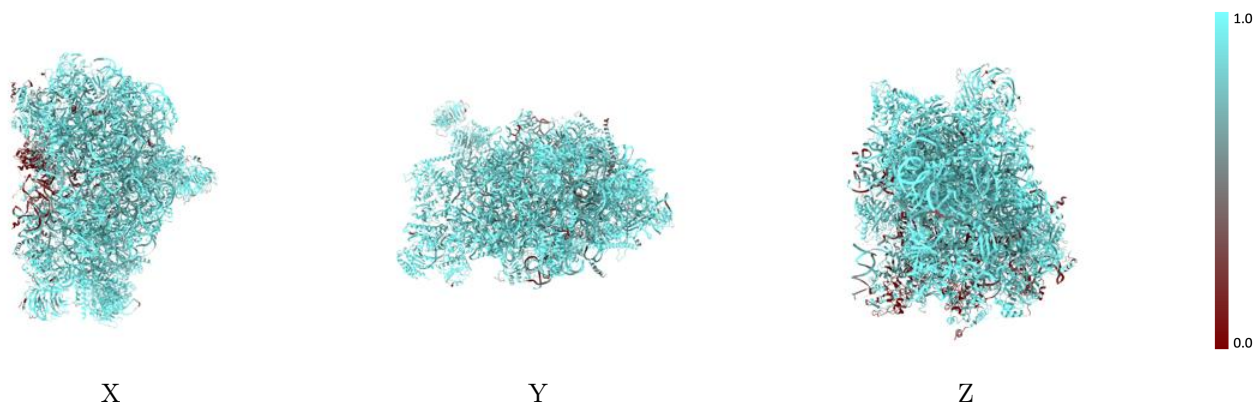

The images above show the model with each residue coloured according to its atom inclusion. This shows to what extent they are inside the map at the recommended contour level (0.025).

## 9.4 Atom inclusion [i](#)

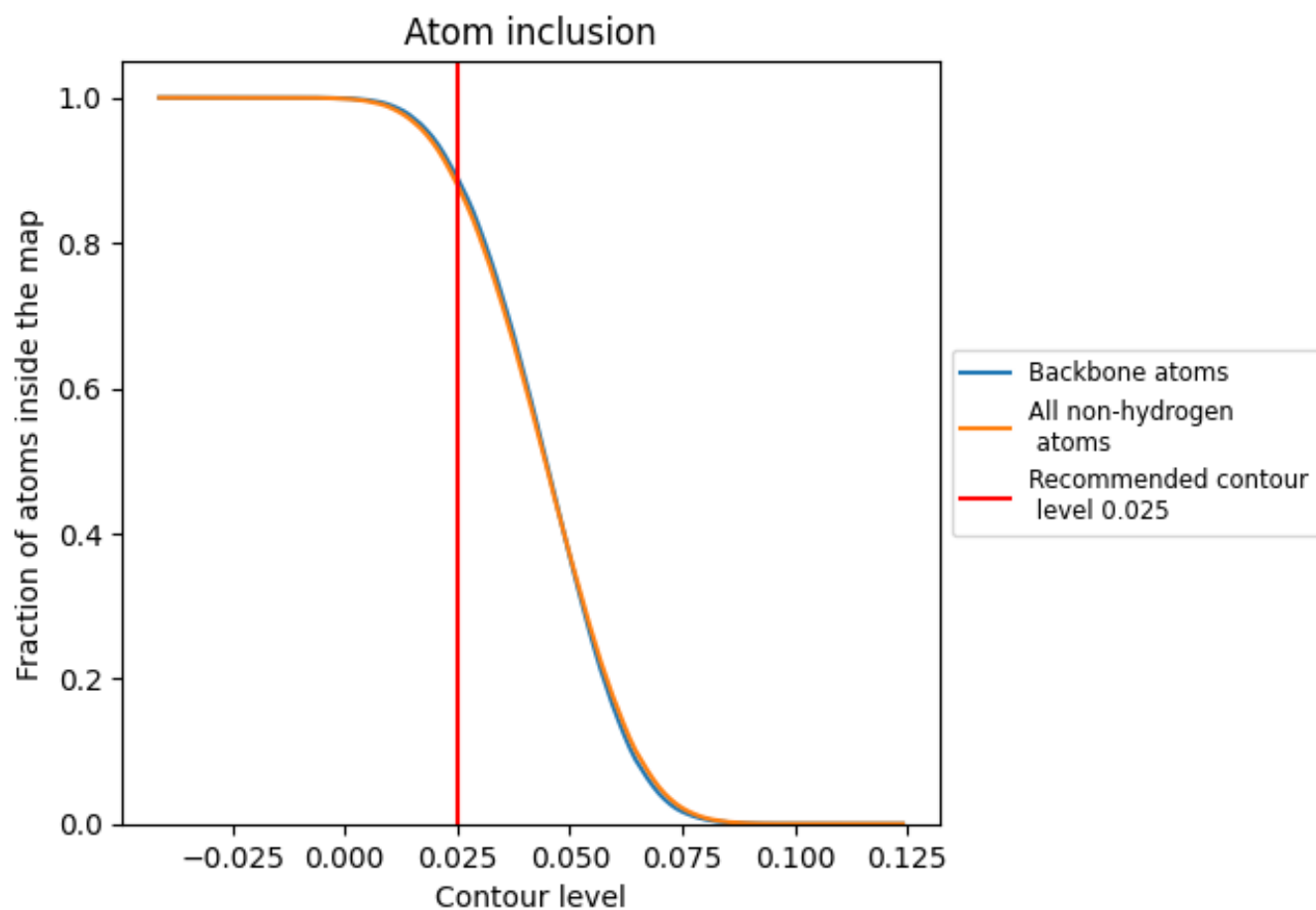







































































At the recommended contour level, 89% of all backbone atoms, 88% of all non-hydrogen atoms, are inside the map.



## 9.5 Map-model fit summary















































The table lists the average atom inclusion at the recommended contour level (0.025) and Q-score for the entire model and for each chain.

Chain	Atom inclusion	Q-score
All	 0.8802	 0.3050
1	 0.8645	 0.2710
2	 0.9705	 0.3480
3	 0.9668	 0.4000
4	 0.9636	 0.3490
5	 0.8903	 0.3590
6	 0.9513	 0.2910
A	 0.9697	 0.3530
B	 0.9707	 0.3790
C	 0.9561	 0.4000
D	 0.9562	 0.3220
E	 0.9519	 0.3460
F	 0.9927	 0.3810
G	 0.9769	 0.3820
H	 0.9789	 0.3770
I	 0.6236	 0.2580
J	 0.7500	 0.2780
K	 0.9669	 0.3120
L	 0.9529	 0.3870
M	 0.9871	 0.3800
N	 0.9435	 0.3970
O	 0.9822	 0.4130
P	 0.9708	 0.4030
Q	 0.9683	 0.3850
R	 0.8854	 0.2860
S	 0.9809	 0.3820
T	 0.6932	 0.1620
U	 0.8801	 0.2410
V	 0.8787	 0.3330
W	 0.9289	 0.2700
X	 0.9663	 0.3760
Y	 0.9861	 0.4140
Z	 0.9741	 0.3100
b	 0.7951	 0.2730
c	 0.8686	 0.1730



*Continued on next page...*

*Continued from previous page...*

Chain	Atom inclusion	Q-score
d	 0.9206	 0.3090
e	 0.9500	 0.4180
f	 0.9811	 0.4380
g	 0.8817	 0.3330
h	 0.9790	 0.3760
i	 0.9757	 0.3120
j	 0.9897	 0.4050
k	 0.9675	 0.3380
l	 0.6494	 0.2710
m	 0.9279	 0.3140
n	 0.9793	 0.3400
o	 0.9718	 0.3460
p	 0.8582	 0.1620
q	 0.5576	 0.2020
r	 0.8168	 0.3080
s	 0.8611	 0.3110
t	 0.9845	 0.3440
u	 0.9655	 0.3250
v	 0.9769	 0.3700
w	 0.4547	 0.2510
x	 0.9532	 0.3680
y	 0.9400	 0.2740
z	 0.5273	 0.2410