



wwPDB EM Validation Summary Report ⓘ

May 27, 2024 – 02:33 PM JST

PDB ID : 7EMF
EMDB ID : EMD-31191
Title : Human Mediator (deletion of MED1-IDR) in a Tail-extended conformation
Authors : Yin, X.; Li, J.; Wu, Z.; Liu, W.; Xu, Y.
Deposited on : 2021-04-13
Resolution : 3.50 Å (reported)

This is a wwPDB EM Validation Summary Report for a publicly released PDB entry.

We welcome your comments at validation@mail.wwpdb.org

A user guide is available at

<https://www.wwpdb.org/validation/2017/EMValidationReportHelp>

with specific help available everywhere you see the ⓘ symbol.

The types of validation reports are described at

<http://www.wwpdb.org/validation/2017/FAQs#types>.

The following versions of software and data (see [references ⓘ](#)) were used in the production of this report:

EMDB validation analysis : 0.0.1.dev92
MolProbity : 4.02b-467
Percentile statistics : 20191225.v01 (using entries in the PDB archive December 25th 2019)
MapQ : 1.9.13
Ideal geometry (proteins) : Engh & Huber (2001)
Ideal geometry (DNA, RNA) : Parkinson et al. (1996)
Validation Pipeline (wwPDB-VP) : 2.36.2

1 Overall quality at a glance i

The following experimental techniques were used to determine the structure:
ELECTRON MICROSCOPY

The reported resolution of this entry is 3.50 Å.

Percentile scores (ranging between 0-100) for global validation metrics of the entry are shown in the following graphic. The table shows the number of entries on which the scores are based.

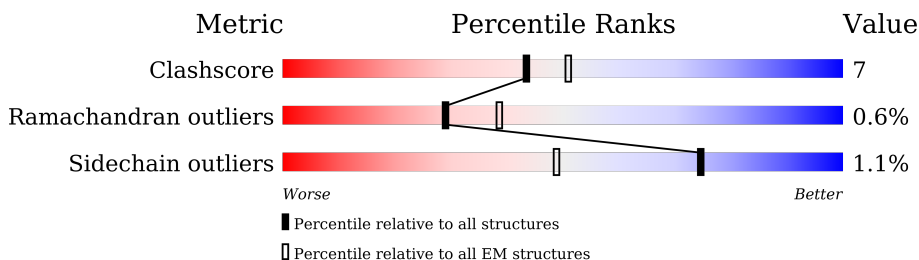

Metric	Whole archive (#Entries)	EM structures (#Entries)
Clashscore	158937	4297
Ramachandran outliers	154571	4023
Sidechain outliers	154315	3826

The table below summarises the geometric issues observed across the polymeric chains and their fit to the map. The red, orange, yellow and green segments of the bar indicate the fraction of residues that contain outliers for ≥ 3 , 2, 1 and 0 types of geometric quality criteria respectively. A grey segment represents the fraction of residues that are not modelled. The numeric value for each fraction is indicated below the corresponding segment, with a dot representing fractions $\leq 5\%$. The upper red bar (where present) indicates the fraction of residues that have poor fit to the EM map (all-atom inclusion $< 40\%$). The numeric value is given above the bar.

Mol	Chain	Length	Quality of chain
1	A	1581	
2	B	20	
3	D	270	
4	F	246	
5	G	233	
6	H	268	
7	I	146	
8	J	135	

Continued on next page...

Continued from previous page...

Mol	Chain	Length	Quality of chain
9	K	117	
10	N	1454	
11	O	788	
12	P	841	
13	Q	651	
14	R	208	
15	S	244	
16	T	212	
17	U	144	
18	V	200	
19	W	1368	
20	X	989	
21	Y	747	
22	Z	600	
23	0	311	
24	1	178	
25	2	200	
26	3	178	
27	4	131	

2 Entry composition [i](#)

There are 28 unique types of molecules in this entry. The entry contains 62334 atoms, of which 0 are hydrogens and 0 are deuteriums.

In the tables below, the AltConf column contains the number of residues with at least one atom in alternate conformation and the Trace column contains the number of residues modelled with at most 2 atoms.

- Molecule 1 is a protein called Mediator of RNA polymerase II transcription subunit 1.

Mol	Chain	Residues	Atoms					AltConf	Trace
			Total	C	N	O	S		
1	A	467	3578	2278	613	663	24	0	0

- Molecule 2 is a protein called Unknown Chain (poly A).

Mol	Chain	Residues	Atoms				AltConf	Trace
			Total	C	N	O		
2	B	20	100	60	20	20	0	0

- Molecule 3 is a protein called Mediator of RNA polymerase II transcription subunit 4.

Mol	Chain	Residues	Atoms					AltConf	Trace
			Total	C	N	O	S		
3	D	158	1268	791	228	243	6	0	0

- Molecule 4 is a protein called Mediator of RNA polymerase II transcription subunit 6.

Mol	Chain	Residues	Atoms					AltConf	Trace
			Total	C	N	O	S		
4	F	167	1374	888	238	243	5	0	0

- Molecule 5 is a protein called Mediator of RNA polymerase II transcription subunit 7.

Mol	Chain	Residues	Atoms					AltConf	Trace
			Total	C	N	O	S		
5	G	161	1348	856	239	243	10	0	0

- Molecule 6 is a protein called Isoform 2 of Mediator of RNA polymerase II transcription subunit 8.

Mol	Chain	Residues	Atoms					AltConf	Trace
			Total	C	N	O	S		
6	H	181	1422	888	250	280	4	0	0

- Molecule 7 is a protein called Mediator of RNA polymerase II transcription subunit 9.

Mol	Chain	Residues	Atoms					AltConf	Trace
			Total	C	N	O	S		
7	I	73	605	382	107	110	6	0	0

- Molecule 8 is a protein called Mediator of RNA polymerase II transcription subunit 10.

Mol	Chain	Residues	Atoms					AltConf	Trace
			Total	C	N	O	S		
8	J	122	840	527	151	159	3	0	0

- Molecule 9 is a protein called Mediator of RNA polymerase II transcription subunit 11.

Mol	Chain	Residues	Atoms					AltConf	Trace
			Total	C	N	O	S		
9	K	112	879	537	163	175	4	0	0

- Molecule 10 is a protein called Mediator of RNA polymerase II transcription subunit 14.

Mol	Chain	Residues	Atoms					AltConf	Trace
			Total	C	N	O	S		
10	N	1017	7772	4958	1365	1407	42	0	0

- Molecule 11 is a protein called Mediator of RNA polymerase II transcription subunit 15.

Mol	Chain	Residues	Atoms					AltConf	Trace
			Total	C	N	O	S		
11	O	157	1226	783	213	223	7	0	0

- Molecule 12 is a protein called Isoform 2 of Mediator of RNA polymerase II transcription subunit 16.

Mol	Chain	Residues	Atoms					AltConf	Trace
			Total	C	N	O	S		
12	P	766	5983	3816	1026	1092	49	0	0

- Molecule 13 is a protein called Mediator of RNA polymerase II transcription subunit 17.

Mol	Chain	Residues	Atoms					AltConf	Trace
			Total	C	N	O	S		
13	Q	551	4361	2760	780	801	20	0	0

- Molecule 14 is a protein called Mediator of RNA polymerase II transcription subunit 18.

Mol	Chain	Residues	Atoms					AltConf	Trace
			Total	C	N	O	S		
14	R	191	1532	971	270	276	15	0	0

- Molecule 15 is a protein called Mediator of RNA polymerase II transcription subunit 19.

Mol	Chain	Residues	Atoms					AltConf	Trace
			Total	C	N	O	S		
15	S	75	476	295	85	94	2	0	0

- Molecule 16 is a protein called Mediator of RNA polymerase II transcription subunit 20.

Mol	Chain	Residues	Atoms					AltConf	Trace
			Total	C	N	O	S		
16	T	193	1499	955	247	280	17	0	0

- Molecule 17 is a protein called Mediator of RNA polymerase II transcription subunit 21.

Mol	Chain	Residues	Atoms					AltConf	Trace
			Total	C	N	O	S		
17	U	121	918	570	153	190	5	0	0

- Molecule 18 is a protein called Mediator of RNA polymerase II transcription subunit 22.

Mol	Chain	Residues	Atoms					AltConf	Trace
			Total	C	N	O	S		
18	V	130	1063	656	181	222	4	0	0

- Molecule 19 is a protein called Mediator of RNA polymerase II transcription subunit 23.

Mol	Chain	Residues	Atoms					AltConf	Trace
			Total	C	N	O	S		
19	W	1334	10774	6967	1827	1909	71	0	0

- Molecule 20 is a protein called Mediator of RNA polymerase II transcription subunit 24.

Mol	Chain	Residues	Atoms					AltConf	Trace
			Total	C	N	O	S		
20	X	897	7061	4524	1190	1293	54	0	0

- Molecule 21 is a protein called Mediator of RNA polymerase II transcription subunit 25.

Mol	Chain	Residues	Atoms					AltConf	Trace
			Total	C	N	O	S		
21	Y	210	1605	1030	264	302	9	0	0

- Molecule 22 is a protein called Mediator of RNA polymerase II transcription subunit 26.

Mol	Chain	Residues	Atoms					AltConf	Trace
			Total	C	N	O	S		
22	Z	97	765	472	136	154	3	0	0

- Molecule 23 is a protein called Mediator of RNA polymerase II transcription subunit 27.

Mol	Chain	Residues	Atoms					AltConf	Trace
			Total	C	N	O	S		
23	0	267	2159	1373	384	390	12	0	0

- Molecule 24 is a protein called Mediator of RNA polymerase II transcription subunit 28.

Mol	Chain	Residues	Atoms					AltConf	Trace
			Total	C	N	O	S		
24	1	99	817	511	143	160	3	0	0

- Molecule 25 is a protein called Mediator of RNA polymerase II transcription subunit 29.

Mol	Chain	Residues	Atoms					AltConf	Trace
			Total	C	N	O	S		
25	2	115	899	563	155	172	9	0	0

- Molecule 26 is a protein called Mediator of RNA polymerase II transcription subunit 30.

Mol	Chain	Residues	Atoms					AltConf	Trace
			Total	C	N	O	S		
26	3	122	1022	639	187	189	7	0	0

- Molecule 27 is a protein called Mediator of RNA polymerase II transcription subunit 31.

Mol	Chain	Residues	Atoms					AltConf	Trace
			Total	C	N	O	S		
27	4	113	986	642	171	168	5	0	0

- Molecule 28 is ZINC ION (three-letter code: ZN) (formula: Zn).

Mol	Chain	Residues	Atoms		AltConf
28	P	1	Total 1	Zn 1	0
28	0	1	Total 1	Zn 1	0

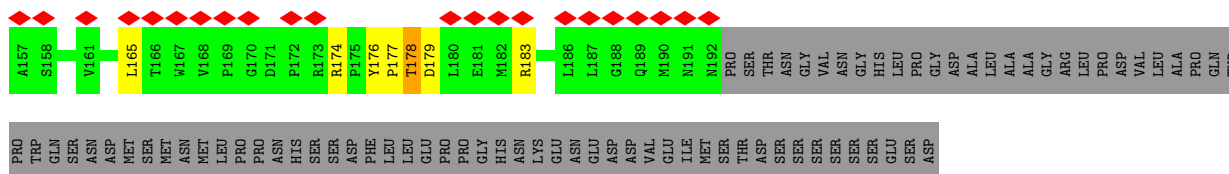

- Molecule 4: Mediator of RNA polymerase II transcription subunit 6

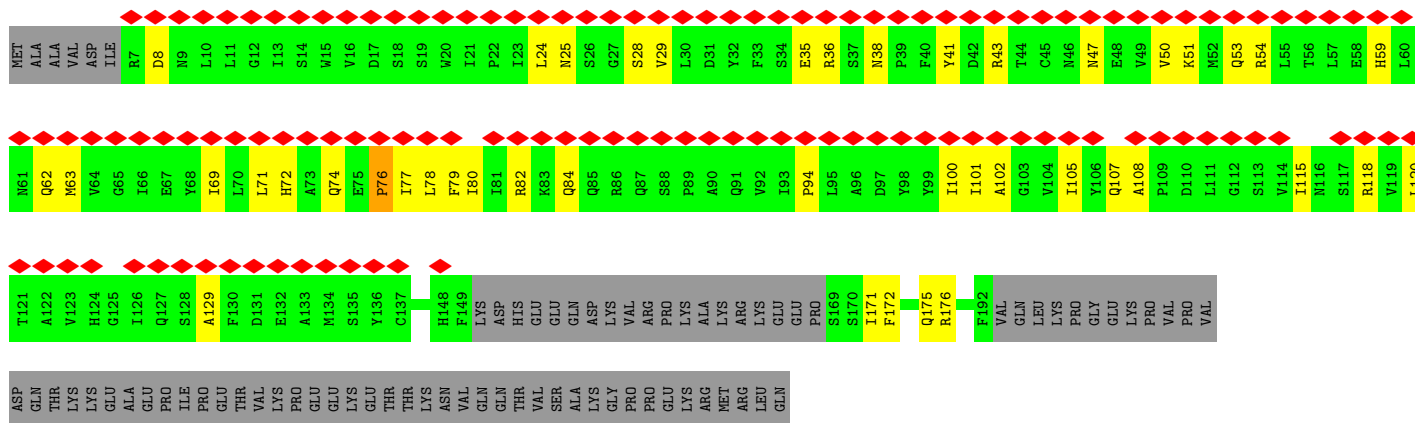

- Molecule 5: Mediator of RNA polymerase II transcription subunit 7

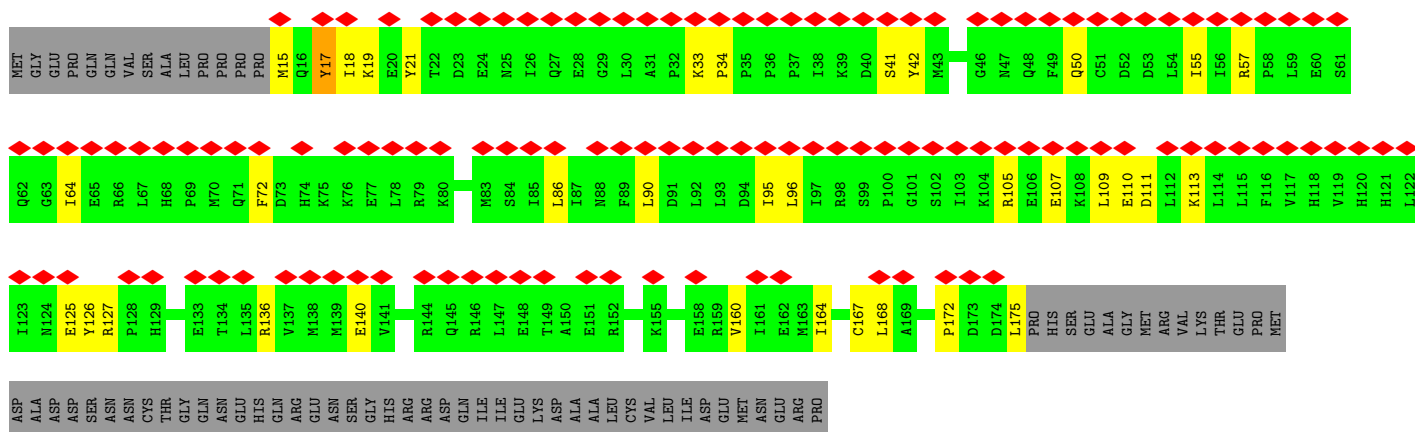

- Molecule 6: Isoform 2 of Mediator of RNA polymerase II transcription subunit 8

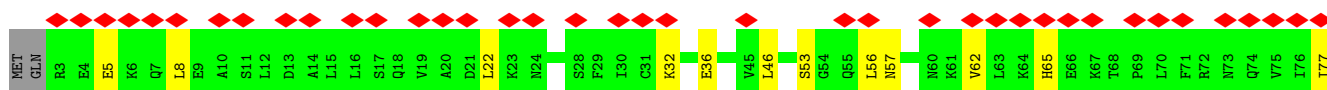

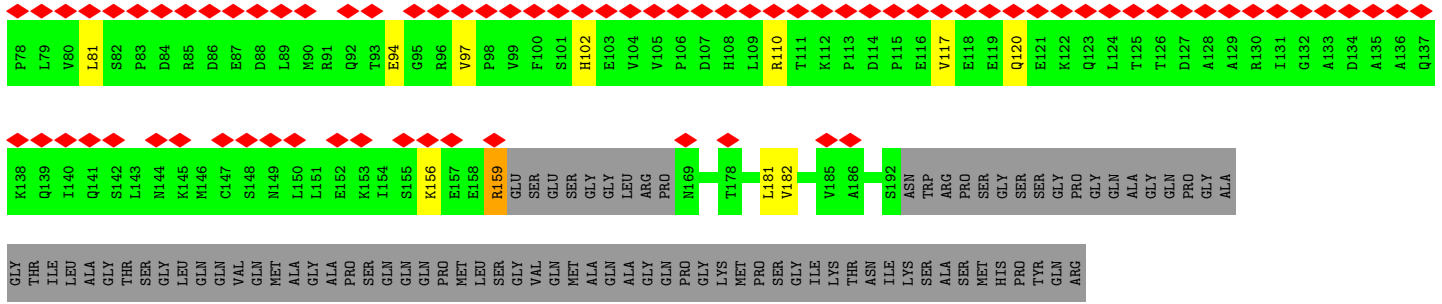

• Molecule 7: Mediator of RNA polymerase II transcription subunit 9

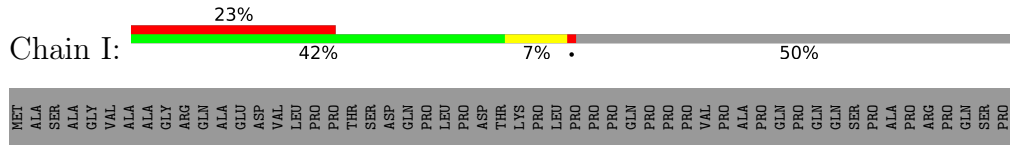

• Molecule 8: Mediator of RNA polymerase II transcription subunit 10

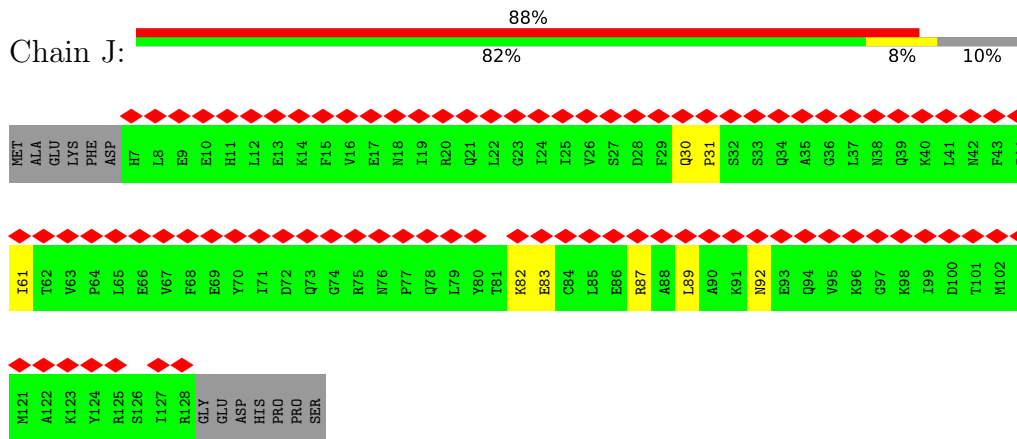

• Molecule 9: Mediator of RNA polymerase II transcription subunit 11

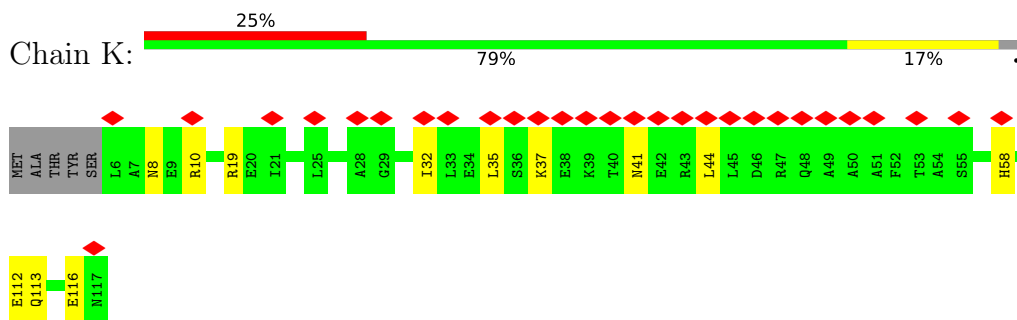

• Molecule 10: Mediator of RNA polymerase II transcription subunit 14

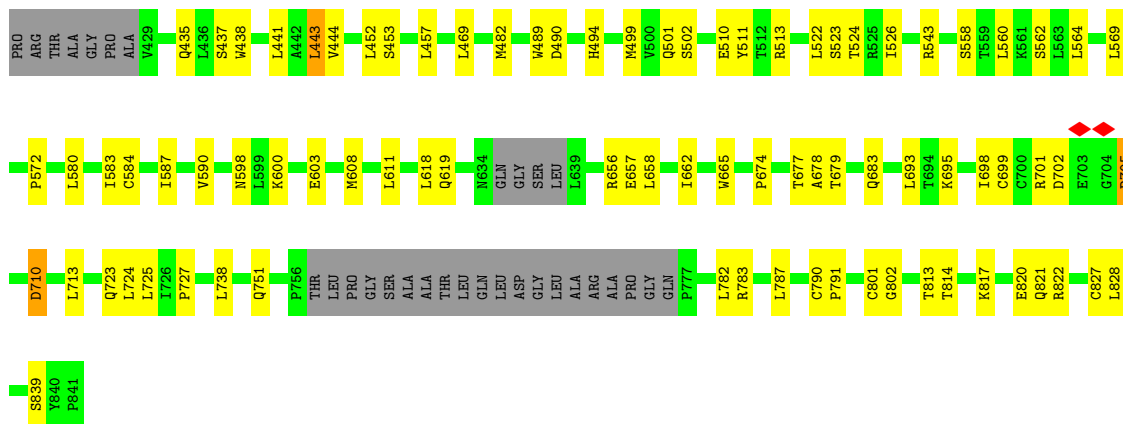

• Molecule 13: Mediator of RNA polymerase II transcription subunit 17

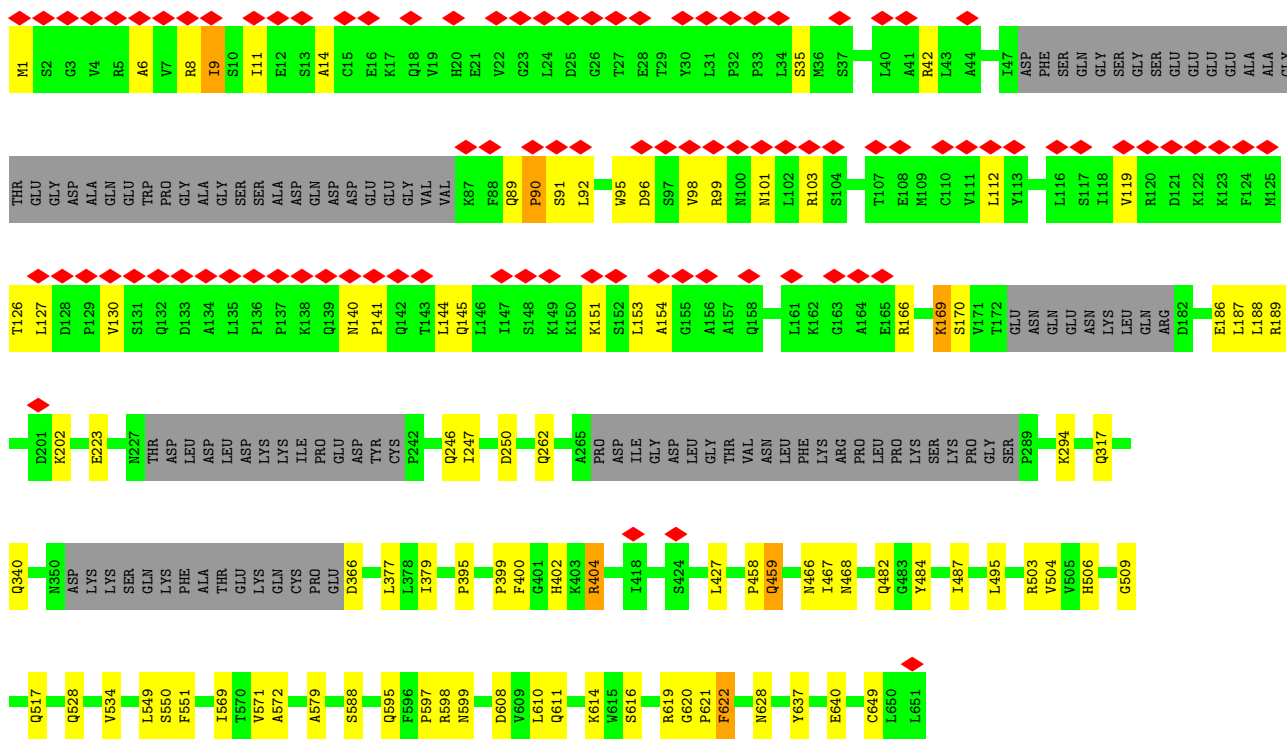

• Molecule 14: Mediator of RNA polymerase II transcription subunit 18

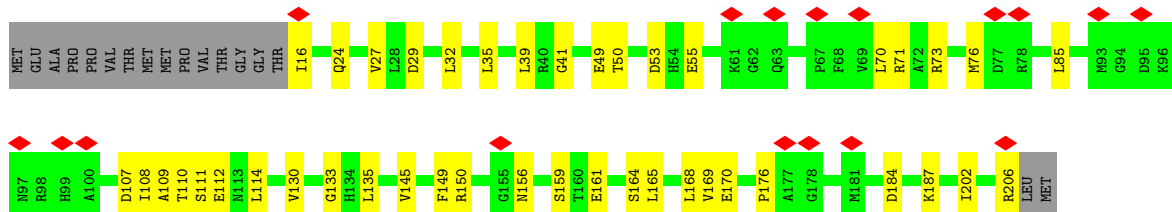

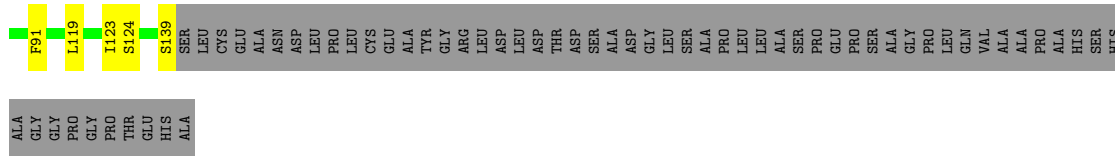

• Molecule 19: Mediator of RNA polymerase II transcription subunit 23

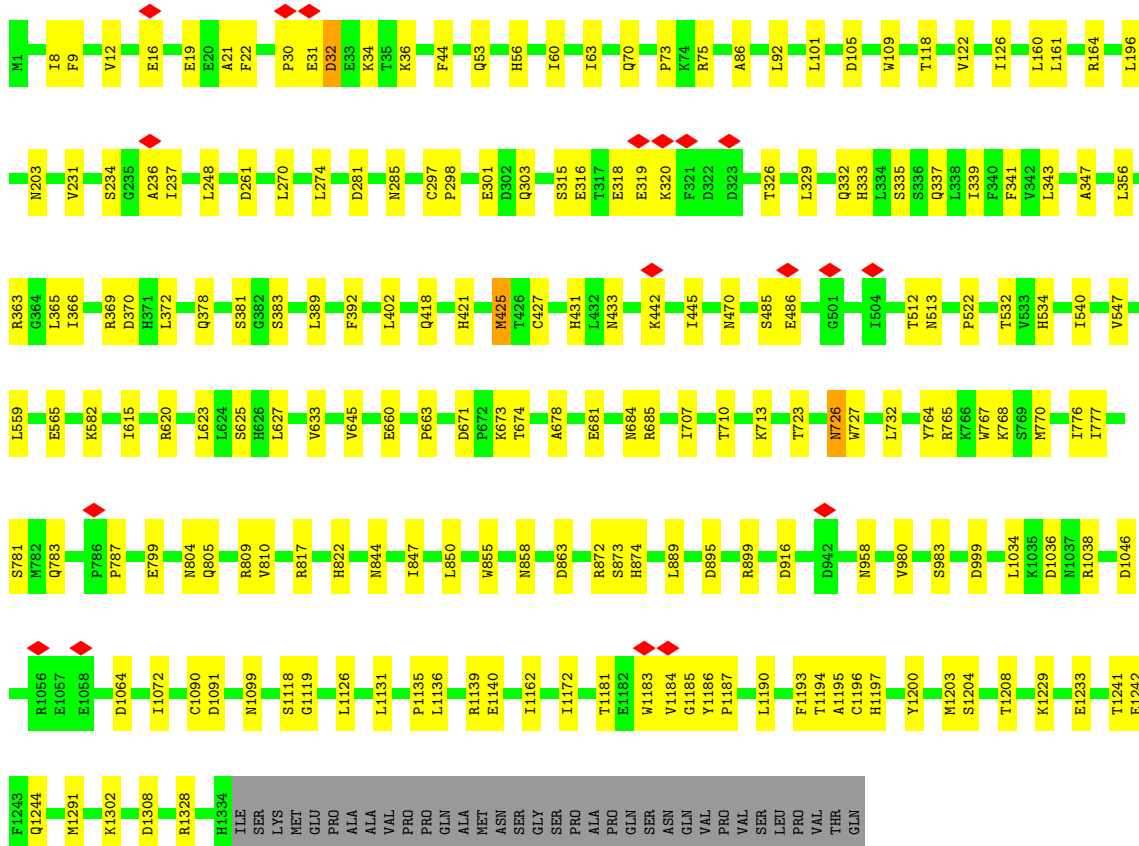
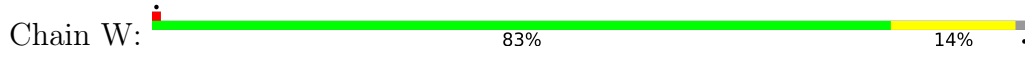

• Molecule 20: Mediator of RNA polymerase II transcription subunit 24

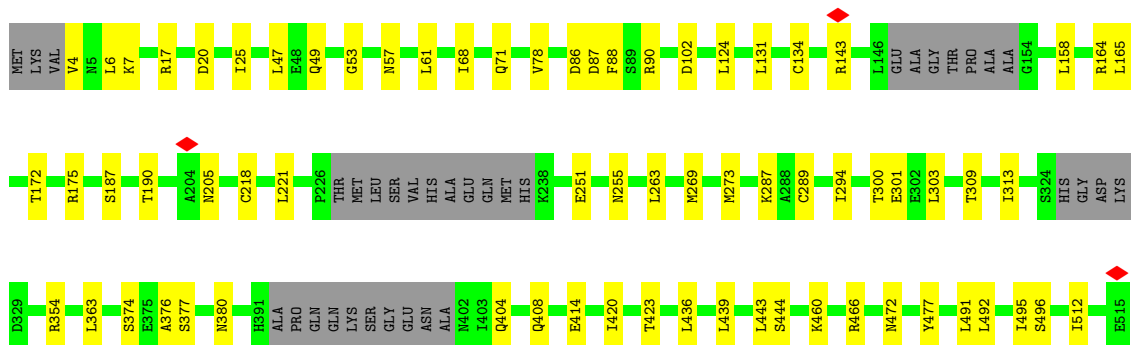
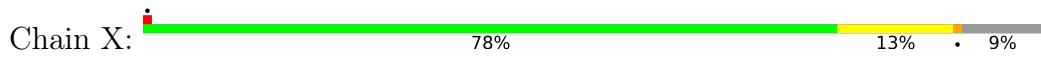

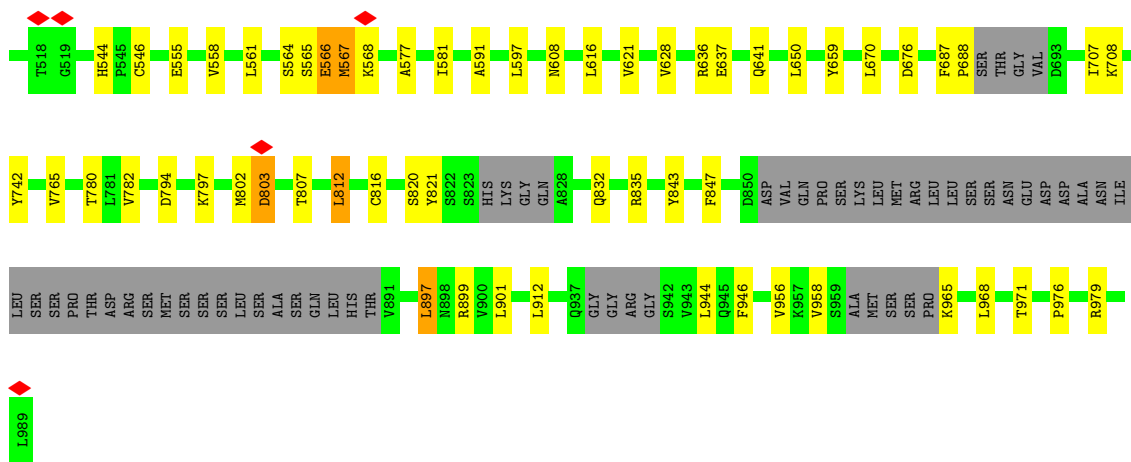

• Molecule 21: Mediator of RNA polymerase II transcription subunit 25

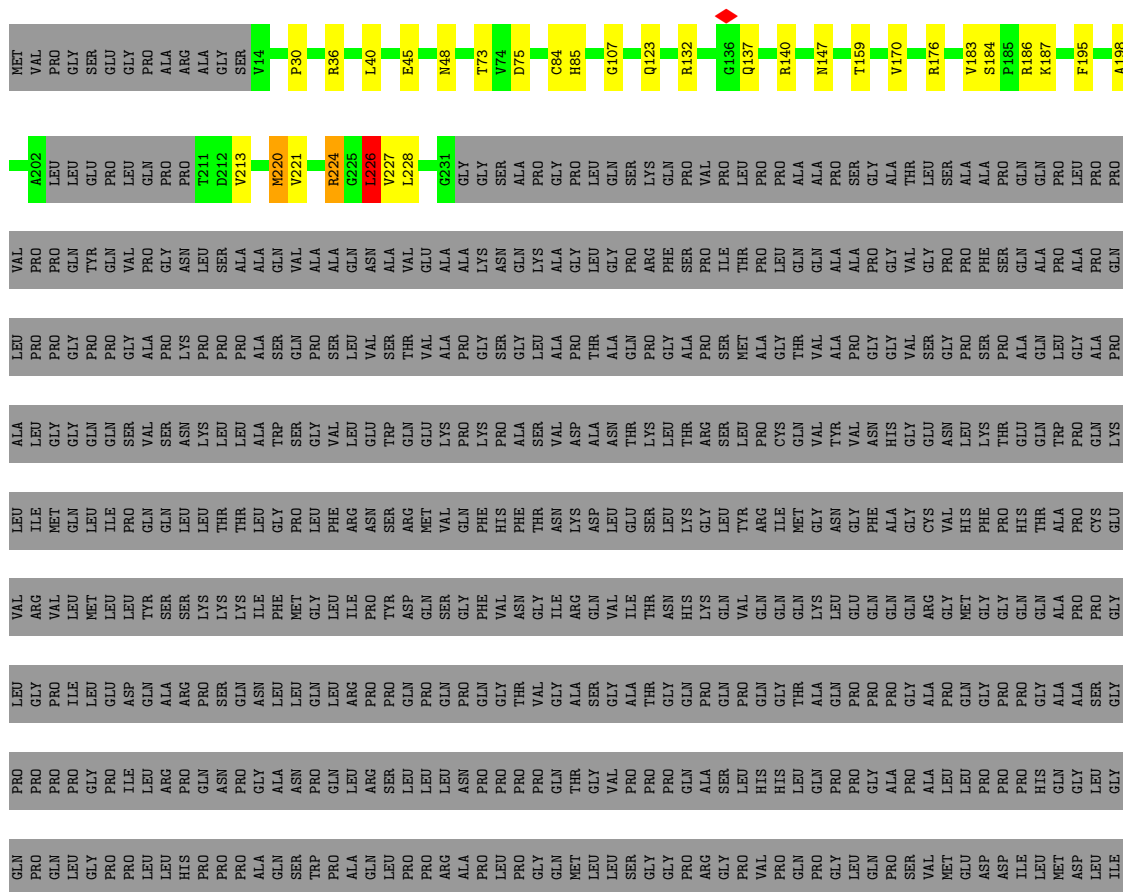

• Molecule 22: Mediator of RNA polymerase II transcription subunit 26

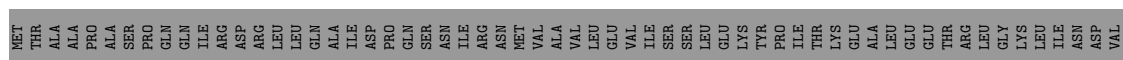

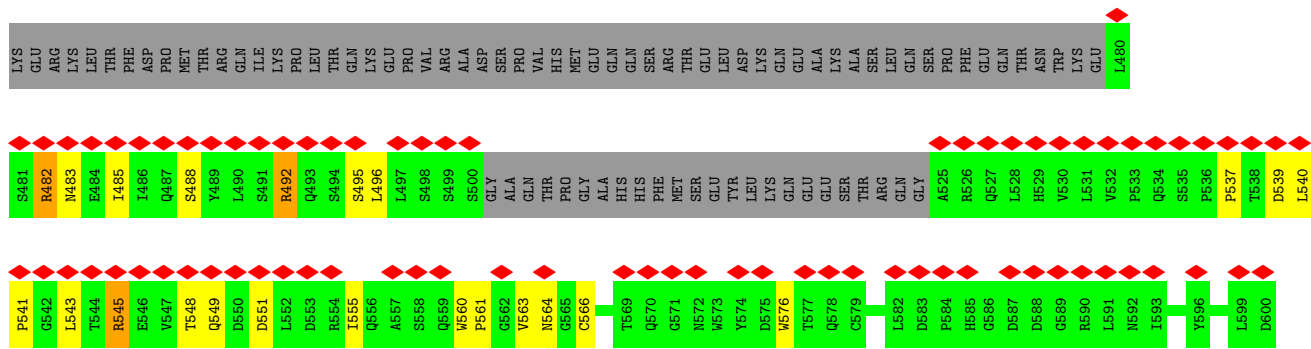
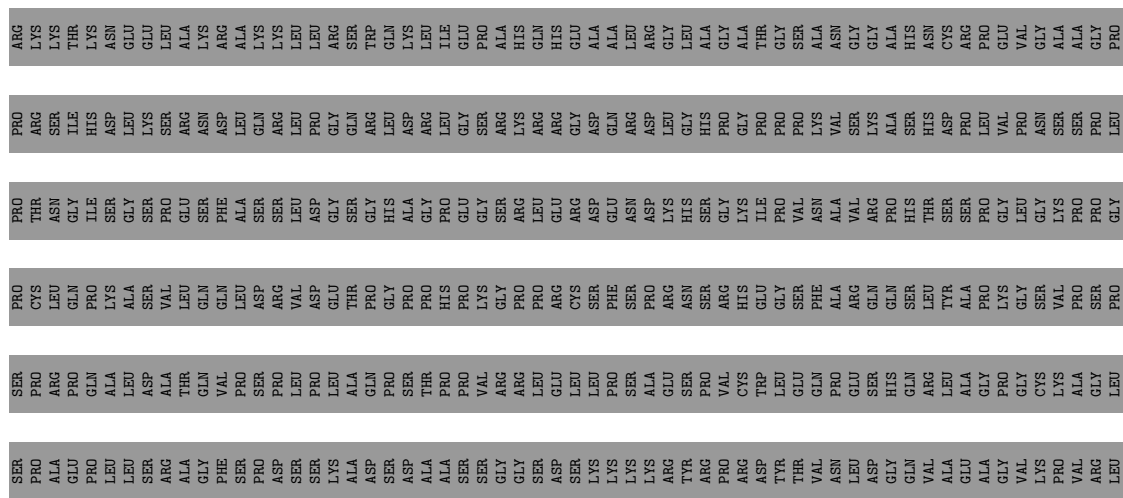

• Molecule 23: Mediator of RNA polymerase II transcription subunit 27

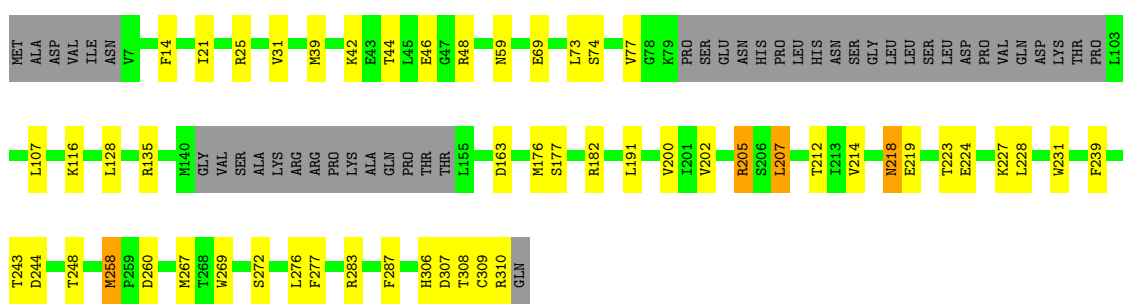

• Molecule 24: Mediator of RNA polymerase II transcription subunit 28

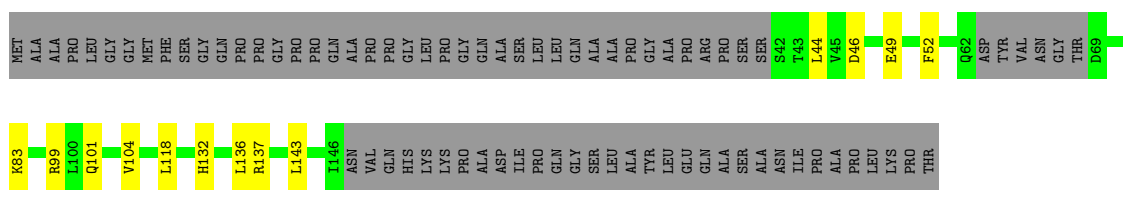

• Molecule 25: Mediator of RNA polymerase II transcription subunit 29

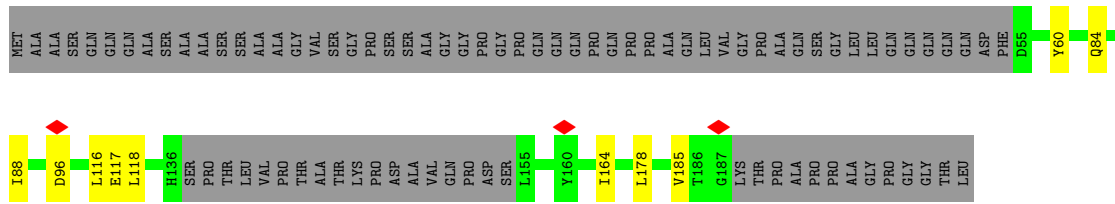

- Molecule 26: Mediator of RNA polymerase II transcription subunit 30

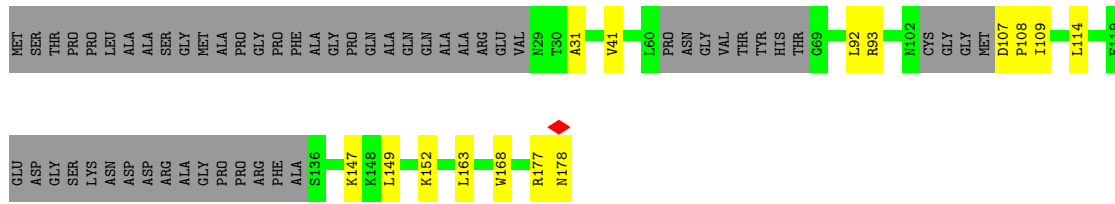

- Molecule 27: Mediator of RNA polymerase II transcription subunit 31

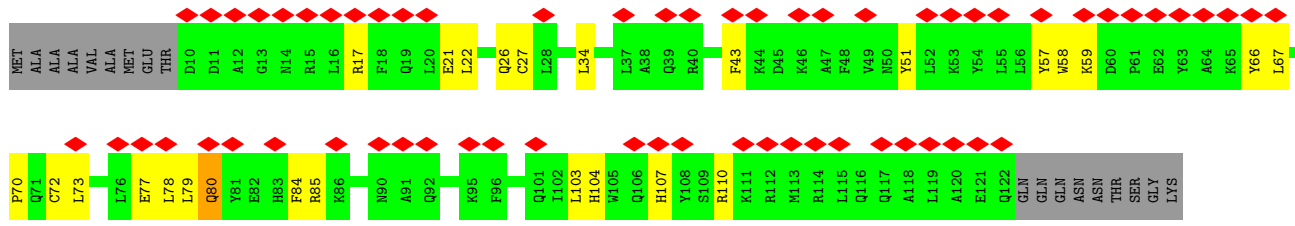

4 Experimental information

Property	Value	Source
EM reconstruction method	SINGLE PARTICLE	Depositor
Imposed symmetry	POINT, Not provided	
Number of particles used	95433	Depositor
Resolution determination method	FSC 0.143 CUT-OFF	Depositor
CTF correction method	PHASE FLIPPING AND AMPLITUDE CORRECTION	Depositor
Microscope	FEI TITAN KRIOS	Depositor
Voltage (kV)	300	Depositor
Electron dose ($e^-/\text{\AA}^2$)	50	Depositor
Minimum defocus (nm)	Not provided	
Maximum defocus (nm)	Not provided	
Magnification	Not provided	
Image detector	GATAN K2 SUMMIT (4k x 4k)	Depositor
Maximum map value	0.114	Depositor
Minimum map value	-0.064	Depositor
Average map value	0.000	Depositor
Map value standard deviation	0.002	Depositor
Recommended contour level	0.01	Depositor
Map size (Å)	539.648, 539.648, 539.648	wwPDB
Map dimensions	512, 512, 512	wwPDB
Map angles (°)	90.0, 90.0, 90.0	wwPDB
Pixel spacing (Å)	1.054, 1.054, 1.054	Depositor

5 Model quality [i](#)

5.1 Standard geometry [i](#)

Bond lengths and bond angles in the following residue types are not validated in this section:
ZN

The Z score for a bond length (or angle) is the number of standard deviations the observed value is removed from the expected value. A bond length (or angle) with $|Z| > 5$ is considered an outlier worth inspection. RMSZ is the root-mean-square of all Z scores of the bond lengths (or angles).

Mol	Chain	Bond lengths		Bond angles	
		RMSZ	# Z >5	RMSZ	# Z >5
1	A	0.51	0/3653	0.62	0/4961
2	B	0.68	0/99	0.77	0/137
3	D	0.40	0/1281	0.56	0/1718
4	F	0.37	0/1411	0.63	0/1916
5	G	0.51	0/1374	0.61	0/1847
6	H	0.35	0/1441	0.56	0/1946
7	I	0.36	0/612	0.58	0/815
8	J	0.33	0/849	0.54	1/1150 (0.1%)
9	K	0.42	0/885	0.53	0/1190
10	N	0.50	0/7923	0.64	11/10761 (0.1%)
11	O	0.59	0/1261	0.69	0/1731
12	P	0.65	0/6116	0.69	0/8311
13	Q	0.52	0/4444	0.61	0/6000
14	R	0.49	0/1562	0.60	0/2101
15	S	0.37	0/480	0.74	5/651 (0.8%)
16	T	0.57	0/1530	0.64	0/2066
17	U	0.53	0/927	0.64	0/1257
18	V	0.56	0/1072	0.65	0/1440
19	W	0.56	0/11056	0.60	0/15023
20	X	0.58	0/7191	0.63	0/9728
21	Y	0.57	0/1645	0.64	0/2240
22	Z	0.51	0/781	0.64	0/1067
23	0	0.57	0/2201	0.60	0/2972
24	1	0.47	0/825	0.55	0/1107
25	2	0.47	0/911	0.56	0/1229
26	3	0.45	0/1029	0.54	0/1378
27	4	0.48	0/1013	0.61	0/1364
All	All	0.53	0/63572	0.62	17/86106 (0.0%)

There are no bond length outliers.

The worst 5 of 17 bond angle outliers are listed below:

Mol	Chain	Res	Type	Atoms	Z	Observed(°)	Ideal(°)
10	N	1351	PRO	N-CA-CB	7.37	112.14	103.30
10	N	1343	PRO	N-CA-CB	7.30	112.06	103.30
10	N	1355	PRO	N-CA-CB	6.88	111.56	103.30
8	J	31	PRO	N-CA-CB	6.61	111.23	103.30
10	N	1352	PRO	N-CA-CB	6.35	110.92	103.30

There are no chirality outliers.

There are no planarity outliers.

5.2 Too-close contacts [i](#)

In the following table, the Non-H and H(model) columns list the number of non-hydrogen atoms and hydrogen atoms in the chain respectively. The H(added) column lists the number of hydrogen atoms added and optimized by MolProbity. The Clashes column lists the number of clashes within the asymmetric unit, whereas Symm-Clashes lists symmetry-related clashes.

Mol	Chain	Non-H	H(model)	H(added)	Clashes	Symm-Clashes
1	A	3578	0	3522	63	0
2	B	100	0	102	0	0
3	D	1268	0	1305	23	0
4	F	1374	0	1357	35	0
5	G	1348	0	1373	32	0
6	H	1422	0	1440	16	0
7	I	605	0	628	7	0
8	J	840	0	718	8	0
9	K	879	0	886	20	0
10	N	7772	0	7557	139	0
11	O	1226	0	1217	24	0
12	P	5983	0	6071	95	0
13	Q	4361	0	4445	71	0
14	R	1532	0	1542	25	0
15	S	476	0	347	3	0
16	T	1499	0	1484	24	0
17	U	918	0	905	26	0
18	V	1063	0	1051	25	0
19	W	10774	0	10838	130	0
20	X	7061	0	7223	84	0
21	Y	1605	0	1576	24	0
22	Z	765	0	728	16	0
23	0	2159	0	2176	45	0
24	1	817	0	818	13	0
25	2	899	0	908	11	0

Continued on next page...

Continued from previous page...

Mol	Chain	Non-H	H(model)	H(added)	Clashes	Symm-Clashes
26	3	1022	0	1054	14	0
27	4	986	0	965	27	0
28	0	1	0	0	0	0
28	P	1	0	0	0	0
All	All	62334	0	62236	874	0

The all-atom clashscore is defined as the number of clashes found per 1000 atoms (including hydrogen atoms). The all-atom clashscore for this structure is 7.

The worst 5 of 874 close contacts within the same asymmetric unit are listed below, sorted by their clash magnitude.

Atom-1	Atom-2	Interatomic distance (Å)	Clash overlap (Å)
5:G:18:ILE:HD11	27:4:51:TYR:OH	1.35	1.26
10:N:922:TYR:CE2	10:N:1215:ILE:HD13	1.76	1.19
10:N:885:LEU:HD21	10:N:1186:LEU:HD22	1.31	1.10
10:N:962:PHE:HB2	10:N:1210:PHE:CE2	1.88	1.08
10:N:932:GLY:HA2	10:N:1179:HIS:CE1	1.90	1.06

There are no symmetry-related clashes.

5.3 Torsion angles [i](#)

5.3.1 Protein backbone [i](#)

In the following table, the Percentiles column shows the percent Ramachandran outliers of the chain as a percentile score with respect to all PDB entries followed by that with respect to all EM entries.

The Analysed column shows the number of residues for which the backbone conformation was analysed, and the total number of residues.

Mol	Chain	Analysed	Favoured	Allowed	Outliers	Percentiles	
1	A	455/1581 (29%)	429 (94%)	23 (5%)	3 (1%)	22	61
2	B	18/20 (90%)	18 (100%)	0	0	100	100
3	D	154/270 (57%)	150 (97%)	3 (2%)	1 (1%)	25	64
4	F	163/246 (66%)	153 (94%)	8 (5%)	2 (1%)	13	50
5	G	159/233 (68%)	151 (95%)	8 (5%)	0	100	100
6	H	177/268 (66%)	165 (93%)	12 (7%)	0	100	100

Continued on next page...

Continued from previous page...

Mol	Chain	Analysed	Favoured	Allowed	Outliers	Percentiles	
7	I	69/146 (47%)	66 (96%)	1 (1%)	2 (3%)	4	31
8	J	120/135 (89%)	117 (98%)	2 (2%)	1 (1%)	19	58
9	K	110/117 (94%)	105 (96%)	5 (4%)	0	100	100
10	N	995/1454 (68%)	889 (89%)	95 (10%)	11 (1%)	14	52
11	O	153/788 (19%)	138 (90%)	13 (8%)	2 (1%)	12	48
12	P	756/841 (90%)	705 (93%)	49 (6%)	2 (0%)	41	75
13	Q	539/651 (83%)	505 (94%)	30 (6%)	4 (1%)	22	61
14	R	189/208 (91%)	180 (95%)	9 (5%)	0	100	100
15	S	67/244 (28%)	60 (90%)	5 (8%)	2 (3%)	4	30
16	T	189/212 (89%)	175 (93%)	13 (7%)	1 (0%)	29	68
17	U	117/144 (81%)	114 (97%)	2 (2%)	1 (1%)	17	56
18	V	128/200 (64%)	125 (98%)	2 (2%)	1 (1%)	19	58
19	W	1332/1368 (97%)	1262 (95%)	66 (5%)	4 (0%)	41	75
20	X	877/989 (89%)	829 (94%)	44 (5%)	4 (0%)	29	68
21	Y	206/747 (28%)	196 (95%)	9 (4%)	1 (0%)	29	68
22	Z	93/600 (16%)	83 (89%)	8 (9%)	2 (2%)	6	37
23	0	261/311 (84%)	245 (94%)	16 (6%)	0	100	100
24	1	95/178 (53%)	91 (96%)	3 (3%)	1 (1%)	14	52
25	2	111/200 (56%)	106 (96%)	5 (4%)	0	100	100
26	3	114/178 (64%)	111 (97%)	3 (3%)	0	100	100
27	4	111/131 (85%)	107 (96%)	3 (3%)	1 (1%)	17	56
All	All	7758/12460 (62%)	7275 (94%)	437 (6%)	46 (1%)	29	64

5 of 46 Ramachandran outliers are listed below:

Mol	Chain	Res	Type
7	I	105	PRO
10	N	186	ILE
10	N	525	TYR
10	N	689	PRO
10	N	1351	PRO

5.3.2 Protein sidechains [i](#)

In the following table, the Percentiles column shows the percent sidechain outliers of the chain as a percentile score with respect to all PDB entries followed by that with respect to all EM entries.

The Analysed column shows the number of residues for which the sidechain conformation was analysed, and the total number of residues.

Mol	Chain	Analysed	Rotameric	Outliers	Percentiles	
1	A	394/1391 (28%)	392 (100%)	2 (0%)	88	94
3	D	139/230 (60%)	139 (100%)	0	100	100
4	F	151/223 (68%)	151 (100%)	0	100	100
5	G	153/216 (71%)	150 (98%)	3 (2%)	55	79
6	H	161/225 (72%)	160 (99%)	1 (1%)	86	94
7	I	71/133 (53%)	70 (99%)	1 (1%)	67	85
8	J	66/124 (53%)	66 (100%)	0	100	100
9	K	94/98 (96%)	94 (100%)	0	100	100
10	N	810/1271 (64%)	802 (99%)	8 (1%)	76	88
11	O	141/697 (20%)	140 (99%)	1 (1%)	84	93
12	P	681/736 (92%)	671 (98%)	10 (2%)	65	84
13	Q	493/577 (85%)	485 (98%)	8 (2%)	62	83
14	R	169/183 (92%)	166 (98%)	3 (2%)	59	81
15	S	31/208 (15%)	31 (100%)	0	100	100
16	T	166/178 (93%)	163 (98%)	3 (2%)	59	81
17	U	98/119 (82%)	96 (98%)	2 (2%)	55	79
18	V	122/173 (70%)	118 (97%)	4 (3%)	38	68
19	W	1203/1232 (98%)	1200 (100%)	3 (0%)	93	98
20	X	789/864 (91%)	780 (99%)	9 (1%)	73	88
21	Y	175/601 (29%)	172 (98%)	3 (2%)	60	82
22	Z	89/512 (17%)	84 (94%)	5 (6%)	21	54
23	0	241/280 (86%)	234 (97%)	7 (3%)	42	71
24	1	94/152 (62%)	94 (100%)	0	100	100
25	2	102/163 (63%)	102 (100%)	0	100	100
26	3	116/155 (75%)	116 (100%)	0	100	100
27	4	102/115 (89%)	101 (99%)	1 (1%)	76	88

Continued on next page...

Continued from previous page...

Mol	Chain	Analysed	Rotameric	Outliers	Percentiles
All	All	6851/10856 (63%)	6777 (99%)	74 (1%)	74 88

5 of 74 residues with a non-rotameric sidechain are listed below:

Mol	Chain	Res	Type
20	X	897	LEU
23	0	218	ASN
21	Y	224	ARG
22	Z	551	ASP
12	P	699	CYS

Sometimes sidechains can be flipped to improve hydrogen bonding and reduce clashes. 5 of 109 such sidechains are listed below:

Mol	Chain	Res	Type
13	Q	411	GLN
19	W	203	ASN
20	X	544	HIS
13	Q	468	ASN
17	U	28	GLN

5.3.3 RNA [i](#)

There are no RNA molecules in this entry.

5.4 Non-standard residues in protein, DNA, RNA chains [i](#)

There are no non-standard protein/DNA/RNA residues in this entry.

5.5 Carbohydrates [i](#)

There are no monosaccharides in this entry.

5.6 Ligand geometry [i](#)

Of 2 ligands modelled in this entry, 2 are monoatomic - leaving 0 for Mogul analysis.

There are no bond length outliers.

There are no bond angle outliers.

There are no chirality outliers.

There are no torsion outliers.

There are no ring outliers.

No monomer is involved in short contacts.

5.7 Other polymers

There are no such residues in this entry.

5.8 Polymer linkage issues

There are no chain breaks in this entry.

6 Map visualisation [i](#)

This section contains visualisations of the EMDB entry EMD-31191. These allow visual inspection of the internal detail of the map and identification of artifacts.

No raw map or half-maps were deposited for this entry and therefore no images, graphs, etc. pertaining to the raw map can be shown.

6.1 Orthogonal projections [i](#)

6.1.1 Primary map

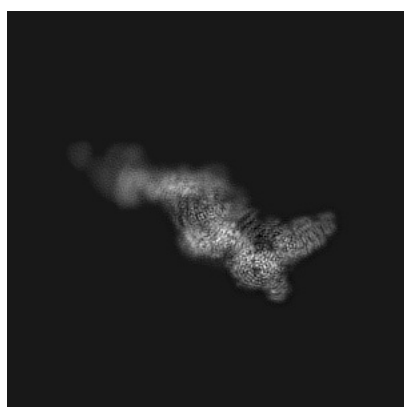

X

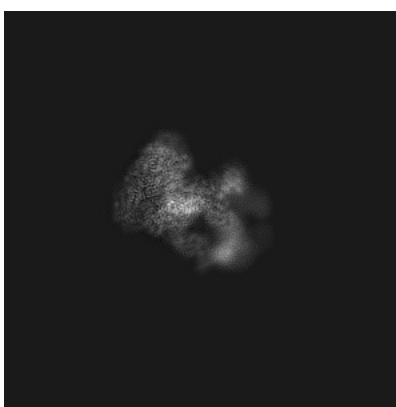

Y

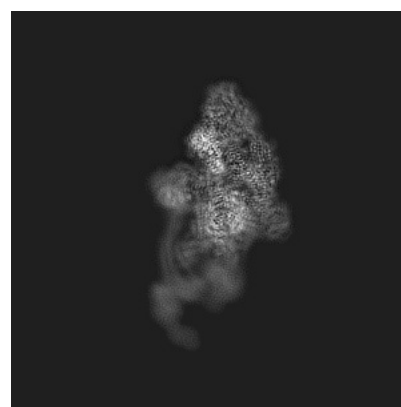

Z

The images above show the map projected in three orthogonal directions.

6.2 Central slices [i](#)

6.2.1 Primary map

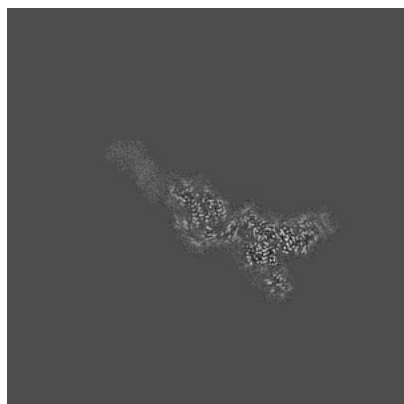

X Index: 256

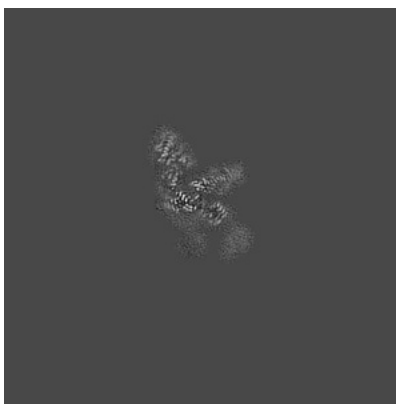

Y Index: 256

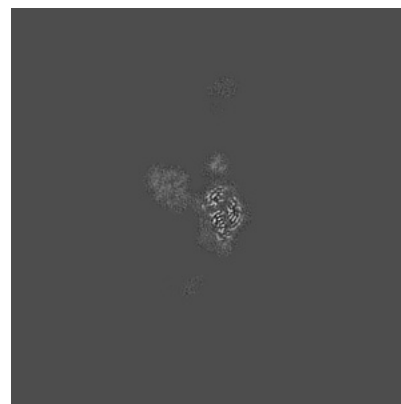

Z Index: 256

The images above show central slices of the map in three orthogonal directions.

6.3 Largest variance slices [i](#)

6.3.1 Primary map

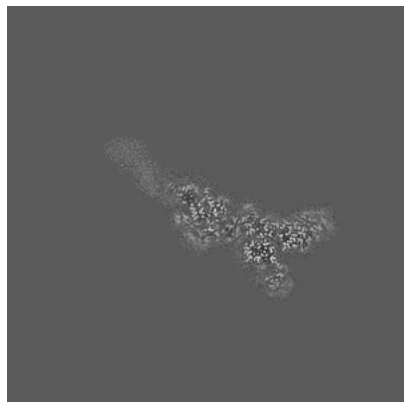

X Index: 258



Y Index: 308

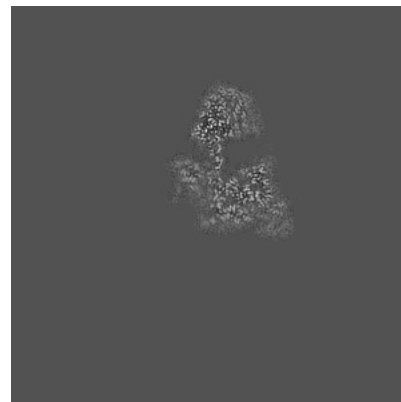

Z Index: 215

The images above show the largest variance slices of the map in three orthogonal directions.

6.4 Orthogonal standard-deviation projections (False-color) [i](#)

6.4.1 Primary map

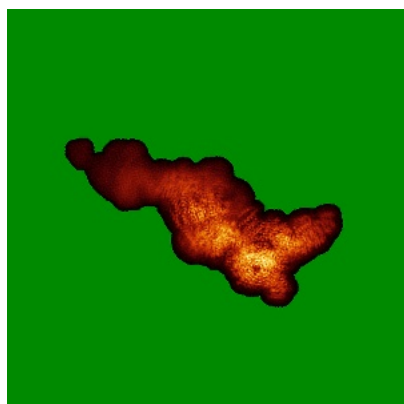

X

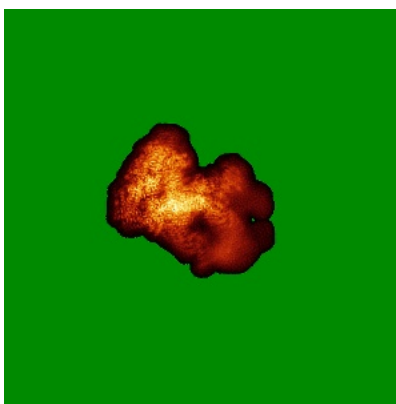

Y

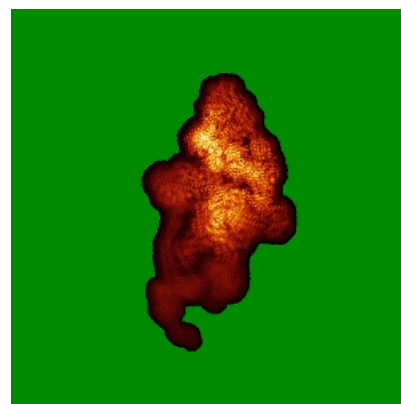

Z

The images above show the map standard deviation projections with false color in three orthogonal directions. Minimum values are shown in green, max in blue, and dark to light orange shades represent small to large values respectively.

6.5 Orthogonal surface views [i](#)

6.5.1 Primary map

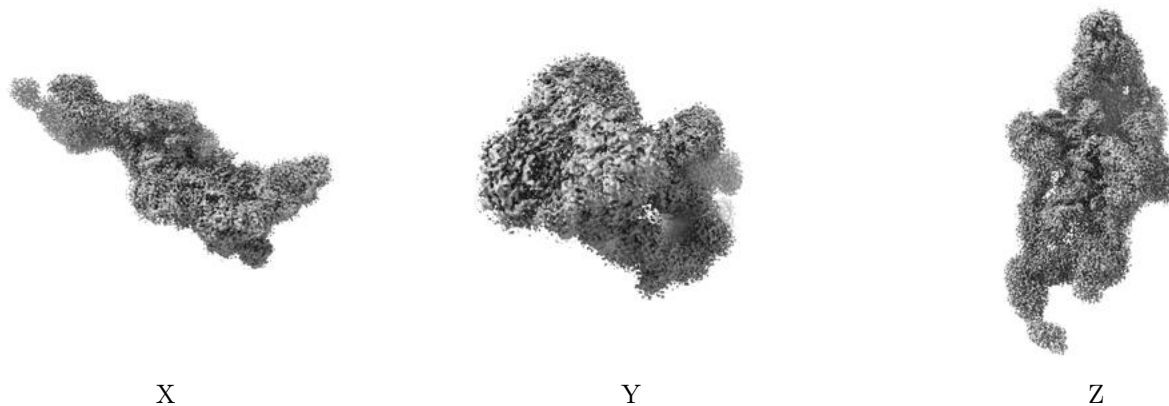

The images above show the 3D surface view of the map at the recommended contour level 0.01. These images, in conjunction with the slice images, may facilitate assessment of whether an appropriate contour level has been provided.

6.6 Mask visualisation [i](#)

This section was not generated. No masks/segmentation were deposited.

7 Map analysis [i](#)

This section contains the results of statistical analysis of the map.

7.1 Map-value distribution [i](#)

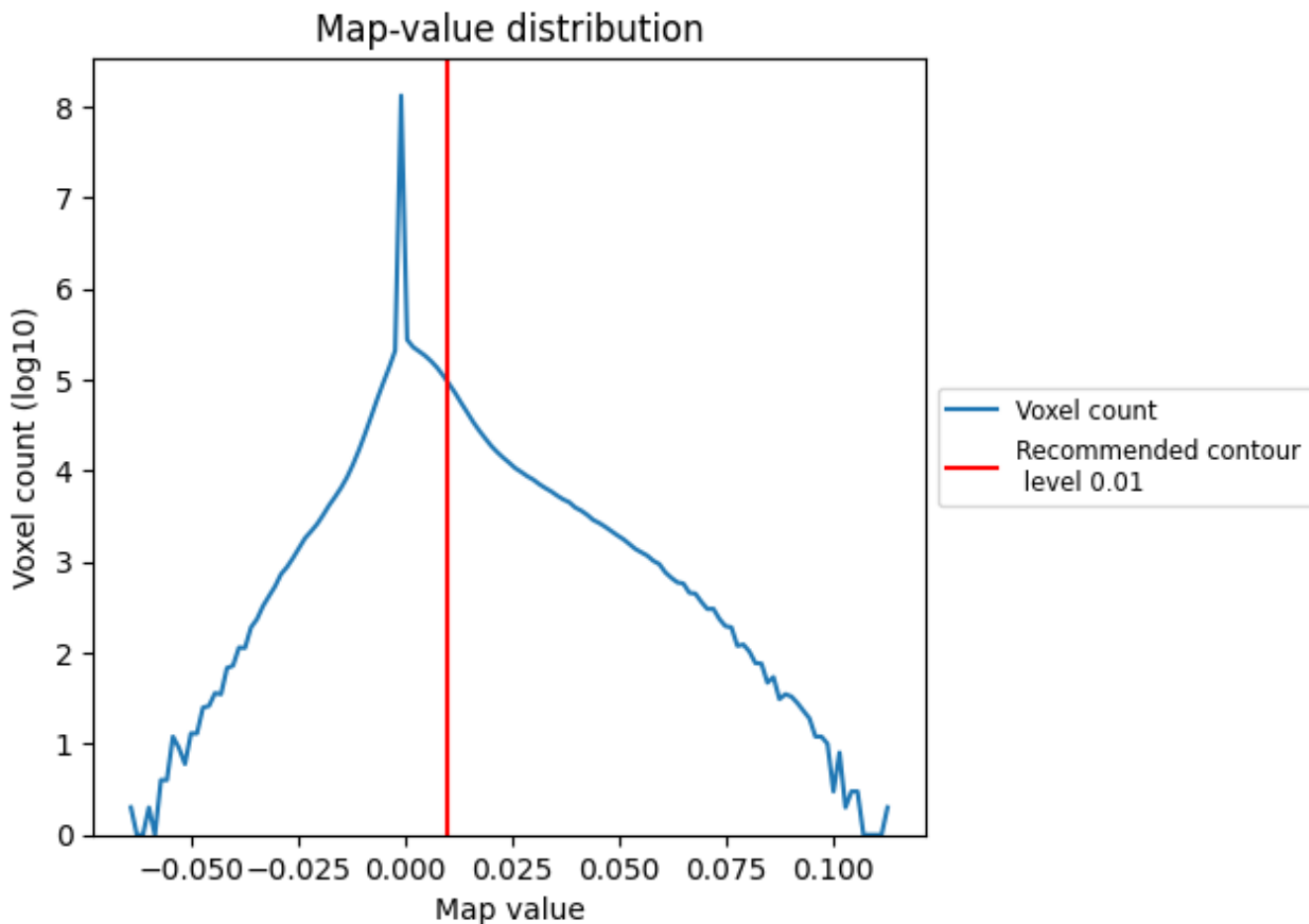

The map-value distribution is plotted in 128 intervals along the x-axis. The y-axis is logarithmic. A spike in this graph at zero usually indicates that the volume has been masked.

7.2 Volume estimate [\(i\)](#)

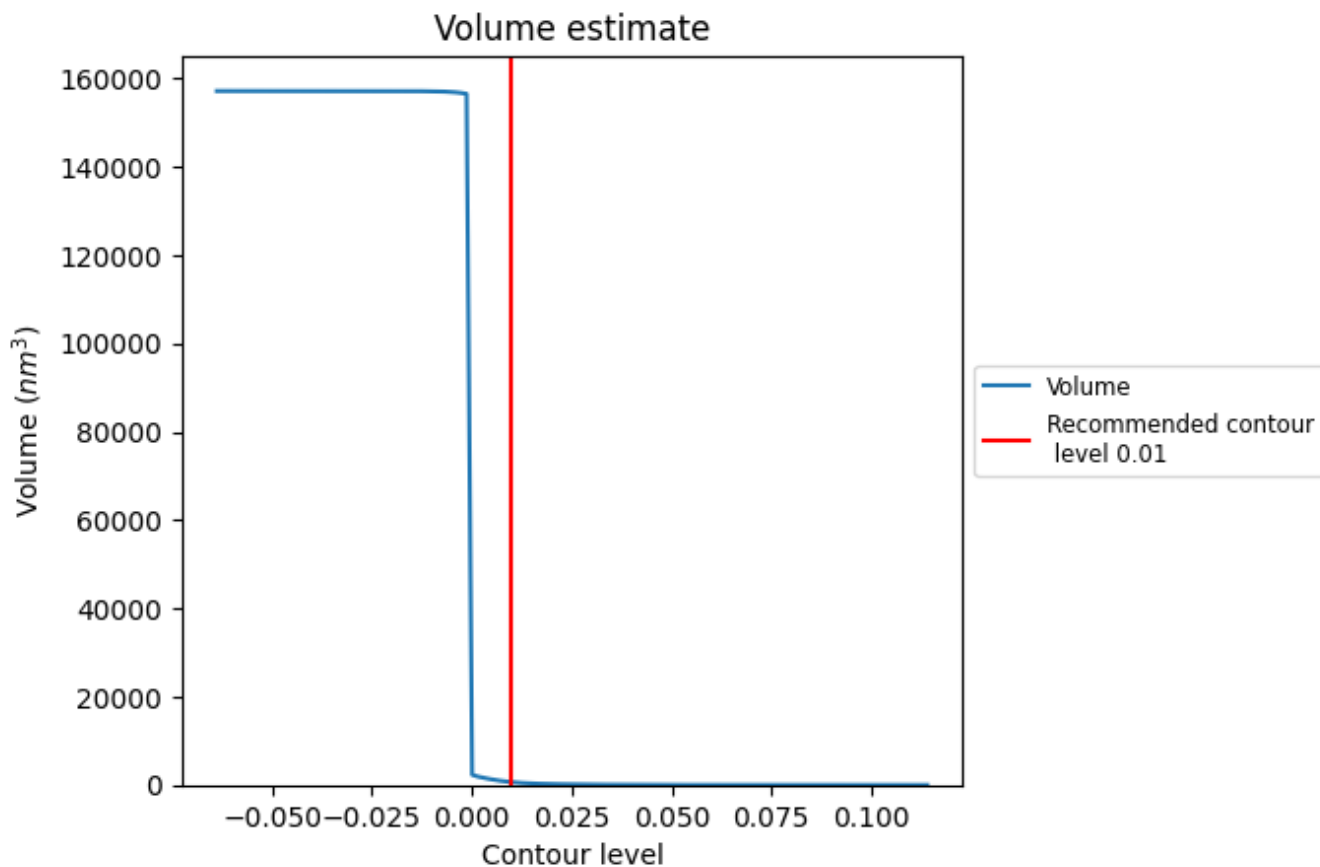

The volume at the recommended contour level is 635 nm³; this corresponds to an approximate mass of 574 kDa.

The volume estimate graph shows how the enclosed volume varies with the contour level. The recommended contour level is shown as a vertical line and the intersection between the line and the curve gives the volume of the enclosed surface at the given level.

7.3 Rotationally averaged power spectrum [i](#)

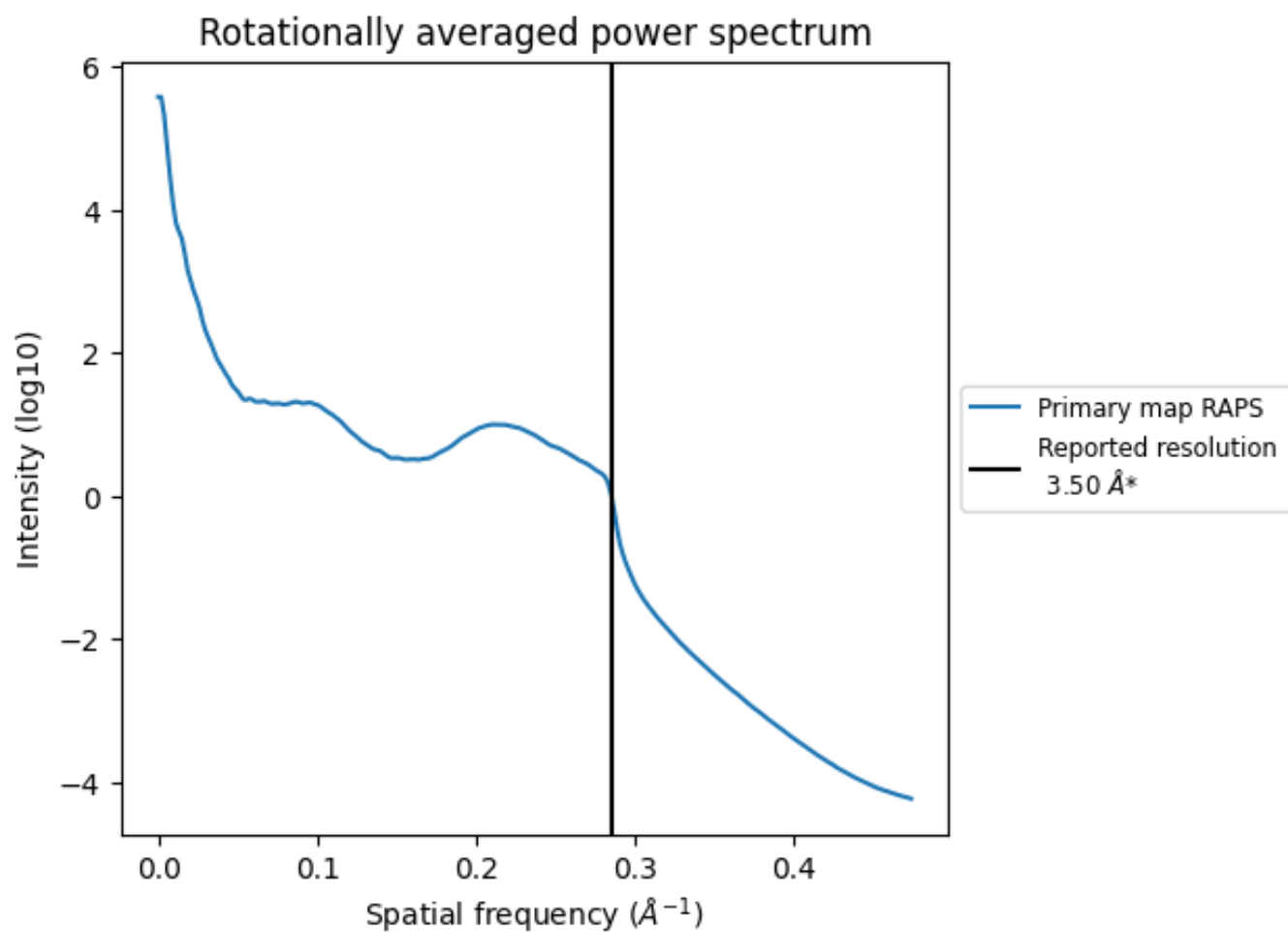

*Reported resolution corresponds to spatial frequency of 0.286 Å⁻¹

8 Fourier-Shell correlation

This section was not generated. No FSC curve or half-maps provided.

9 Map-model fit [i](#)

This section contains information regarding the fit between EMDB map EMD-31191 and PDB model 7EMF. Per-residue inclusion information can be found in section [3](#) on page [9](#).

9.1 Map-model overlay [i](#)

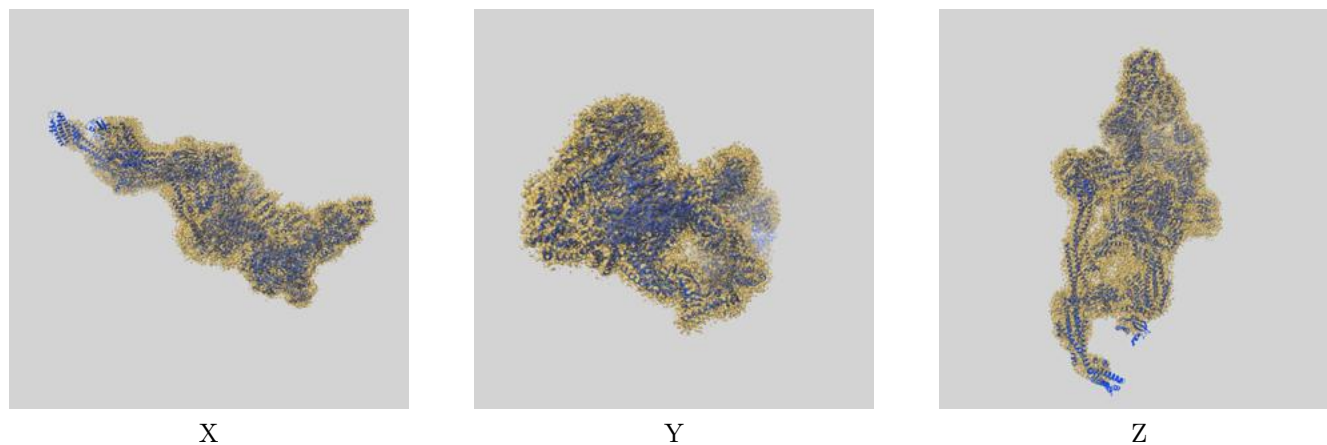

The images above show the 3D surface view of the map at the recommended contour level 0.01 at 50% transparency in yellow overlaid with a ribbon representation of the model coloured in blue. These images allow for the visual assessment of the quality of fit between the atomic model and the map.

9.2 Q-score mapped to coordinate model [\(i\)](#)

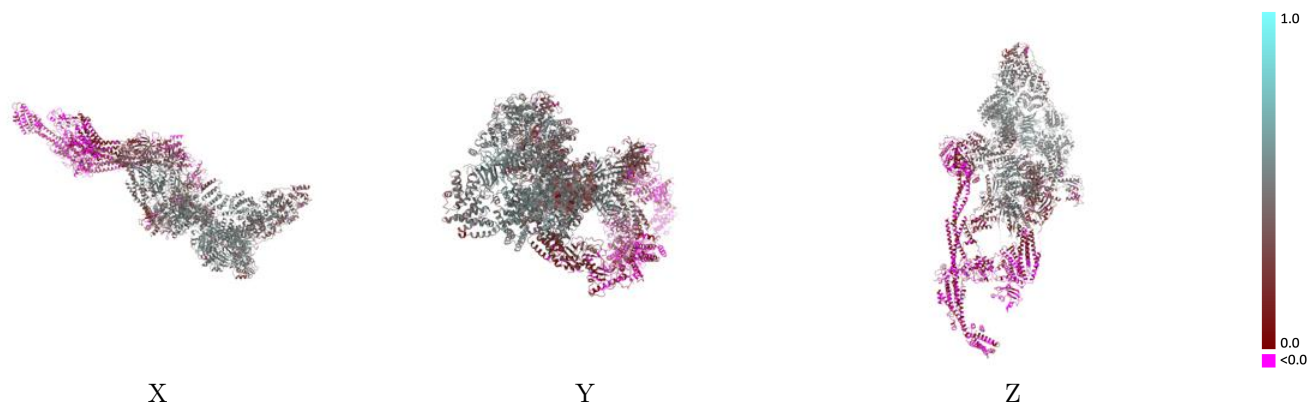

The images above show the model with each residue coloured according to its Q-score. This shows their resolvability in the map with higher Q-score values reflecting better resolvability. Please note: Q-score is calculating the resolvability of atoms, and thus high values are only expected at resolutions at which atoms can be resolved. Low Q-score values may therefore be expected for many entries.

9.3 Atom inclusion mapped to coordinate model [\(i\)](#)

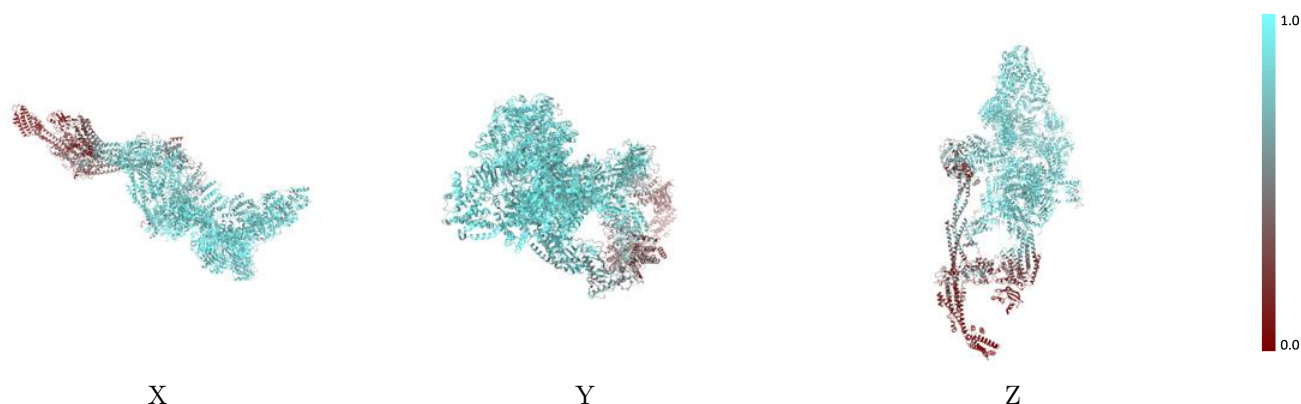

The images above show the model with each residue coloured according to its atom inclusion. This shows to what extent they are inside the map at the recommended contour level (0.01).



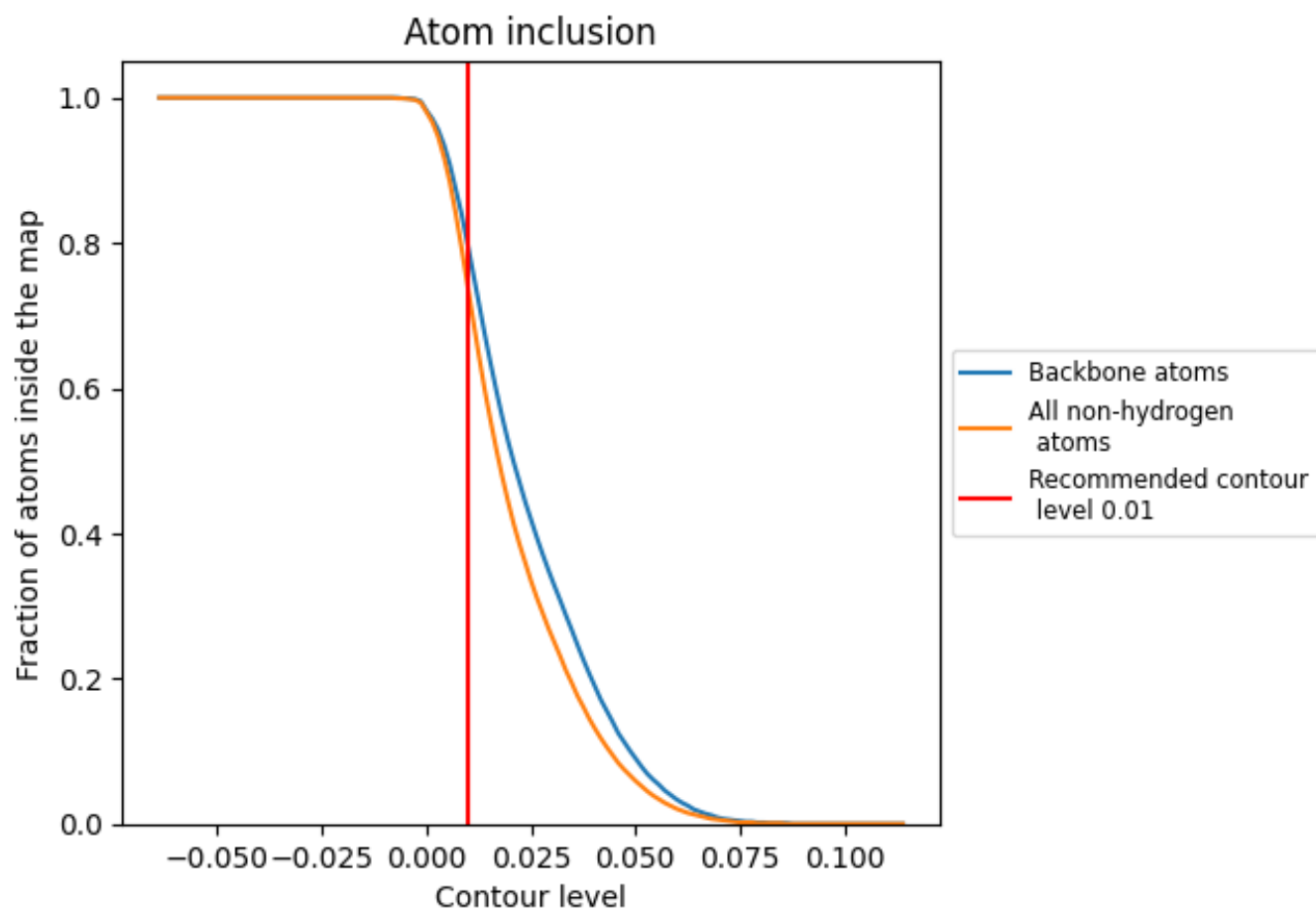





















































9.4 Atom inclusion [i](#)



At the recommended contour level, 80% of all backbone atoms, 74% of all non-hydrogen atoms, are inside the map.

9.5 Map-model fit summary

The table lists the average atom inclusion at the recommended contour level (0.01) and Q-score for the entire model and for each chain.

Chain	Atom inclusion	Q-score
All	 0.7370	 0.3310
0	 0.8880	 0.4600
1	 0.8880	 0.4270
2	 0.8460	 0.4080
3	 0.8680	 0.4040
4	 0.3910	 0.0270
A	 0.5810	 0.1230
B	 0.8100	 0.2100
D	 0.4450	 0.0670
F	 0.2530	 0.0420
G	 0.2630	 -0.0020
H	 0.3370	 0.0430
I	 0.4720	 0.0710
J	 0.0990	 0.0040
K	 0.6260	 0.2120
N	 0.7700	 0.3540
O	 0.8900	 0.4410
P	 0.9090	 0.5060
Q	 0.7480	 0.3540
R	 0.7530	 0.2470
S	 0.0720	 0.0080
T	 0.8260	 0.3300
U	 0.3040	 0.0120
V	 0.6880	 0.2070
W	 0.8760	 0.4390
X	 0.8750	 0.4380
Y	 0.8980	 0.4810
Z	 0.2200	 0.0280

