



wwPDB EM Validation Summary Report ⓘ

Nov 21, 2022 – 03:35 PM EST

PDB ID : 8ETG
EMDB ID : EMD-24397
Title : Fkbp39 associated 60S nascent ribosome State 3
Authors : Zhou, X.; Bilokapic, S.; Deshmukh, A.A.; Halic, M.
Deposited on : 2022-10-17
Resolution : 3.40 Å(reported)

This is a wwPDB EM Validation Summary Report for a publicly released PDB entry.

We welcome your comments at validation@mail.wwpdb.org

A user guide is available at

<https://www.wwpdb.org/validation/2017/EMValidationReportHelp>

with specific help available everywhere you see the ⓘ symbol.

The types of validation reports are described at

<http://www.wwpdb.org/validation/2017/FAQs#types>.

The following versions of software and data (see [references ⓘ](#)) were used in the production of this report:

EMDB validation analysis : 0.0.1.dev43
MolProbity : 4.02b-467
Percentile statistics : 20191225.v01 (using entries in the PDB archive December 25th 2019)
MapQ : 1.9.9
Ideal geometry (proteins) : Engh & Huber (2001)
Ideal geometry (DNA, RNA) : Parkinson et al. (1996)
Validation Pipeline (wwPDB-VP) : 2.31.2

1 Overall quality at a glance

The following experimental techniques were used to determine the structure:
ELECTRON MICROSCOPY

The reported resolution of this entry is 3.40 Å.

Percentile scores (ranging between 0-100) for global validation metrics of the entry are shown in the following graphic. The table shows the number of entries on which the scores are based.

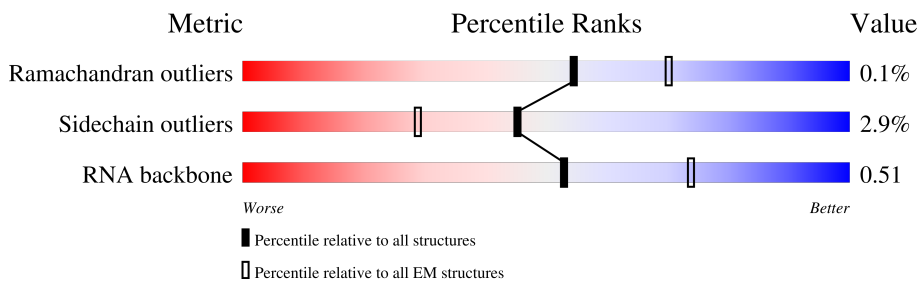











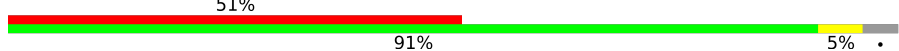

Metric	Whole archive (#Entries)	EM structures (#Entries)
Ramachandran outliers	154571	4023
Sidechain outliers	154315	3826
RNA backbone	4643	859

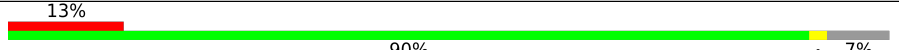
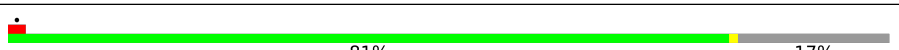
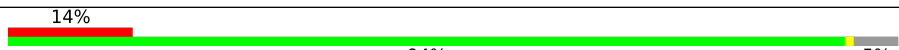
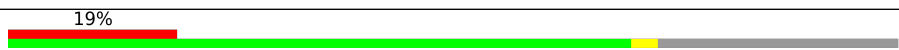
The table below summarises the geometric issues observed across the polymeric chains and their fit to the map. The red, orange, yellow and green segments of the bar indicate the fraction of residues that contain outliers for ≥ 3 , 2, 1 and 0 types of geometric quality criteria respectively. A grey segment represents the fraction of residues that are not modelled. The numeric value for each fraction is indicated below the corresponding segment, with a dot representing fractions $\leq 5\%$. The upper red bar (where present) indicates the fraction of residues that have poor fit to the EM map (all-atom inclusion $< 40\%$). The numeric value is given above the bar.

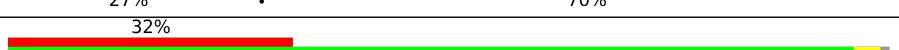
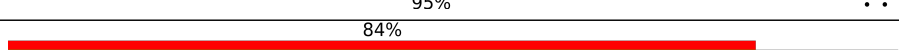
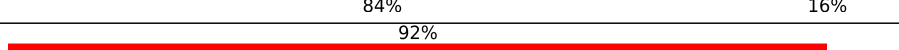
Mol	Chain	Length	Quality of chain
1	1	3497	
2	2	165	
3	3	302	
4	A	295	
5	B	388	
6	C	363	
7	D	578	
8	E	195	

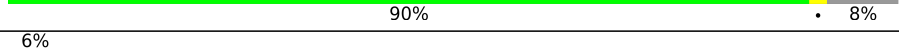
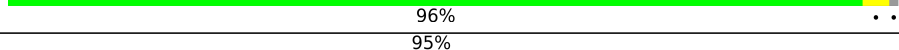
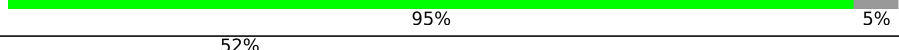
Continued on next page...

Continued from previous page...

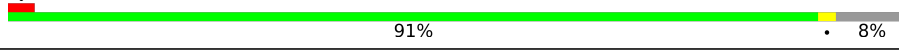
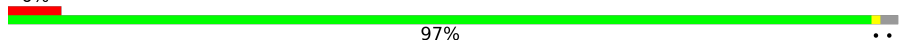
Mol	Chain	Length	Quality of chain
9	F	250	
10	G	259	
11	H	190	
12	K	373	
13	L	208	
14	M	134	
15	N	201	
16	O	197	
17	P	187	
18	Q	187	
19	R	193	
20	S	176	
21	U	117	
22	V	139	
23	W	241	
24	X	141	
25	Y	126	
26	Z	136	
27	a	148	
28	b	642	
29	c	117	
30	d	113	
31	e	127	
32	f	108	
33	g	112	

Continued on next page...

Continued from previous page...

Mol	Chain	Length	Quality of chain
34	h	122	
35	i	99	
36	j	91	
37	k	74	
38	m	740	
39	n	607	
40	o	276	
41	p	440	
42	r	260	
43	t	249	
44	u	192	
45	v	209	
46	y	244	
47	T	160	
48	6	300	

2 Entry composition

There are 49 unique types of molecules in this entry. The entry contains 99257 atoms, of which 0 are hydrogens and 0 are deuteriums.

In the tables below, the AltConf column contains the number of residues with at least one atom in alternate conformation and the Trace column contains the number of residues modelled with at most 2 atoms.

- Molecule 1 is a RNA chain called RNA (1912-MER).

Mol	Chain	Residues	Atoms					AltConf	Trace
			Total	C	N	O	P		
1	1	2018	43202	19298	7842	14044	2018	0	0

There is a discrepancy between the modelled and reference sequences:

Chain	Residue	Modelled	Actual	Comment	Reference
1	3196	U	C	conflict	GB 157310483

- Molecule 2 is a RNA chain called RNA (146-MER).

Mol	Chain	Residues	Atoms					AltConf	Trace
			Total	C	N	O	P		
2	2	146	3102	1388	547	1021	146	0	0

- Molecule 3 is a protein called Protein mak16.

Mol	Chain	Residues	Atoms					AltConf	Trace
			Total	C	N	O	S		
3	3	120	1015	642	190	177	6	0	0

- Molecule 4 is a protein called Ribosome biogenesis protein brx1.

Mol	Chain	Residues	Atoms				AltConf	Trace
			Total	C	N	O		
4	A	196	1015	610	201	204	0	0

- Molecule 5 is a protein called 60S ribosomal protein L3-A.

Mol	Chain	Residues	Atoms					AltConf	Trace
			Total	C	N	O	S		
5	B	334	2653	1682	491	471	9	0	0

- Molecule 6 is a protein called 60S ribosomal protein L4-B.

Mol	Chain	Residues	Atoms					AltConf	Trace
6	C	359	Total	C	N	O	S	0	0
			2795	1765	536	491	3		

- Molecule 7 is a protein called ATP-dependent RNA helicase has1.

Mol	Chain	Residues	Atoms				AltConf	Trace
7	D	82	Total	C	N	O	0	0
			408	244	82	82		

- Molecule 8 is a protein called 60S ribosomal protein L6.

Mol	Chain	Residues	Atoms					AltConf	Trace
8	E	145	Total	C	N	O	S	0	0
			1126	723	208	192	3		

- Molecule 9 is a protein called 60S ribosomal protein L7-B.

Mol	Chain	Residues	Atoms					AltConf	Trace
9	F	214	Total	C	N	O	S	0	0
			1745	1124	320	298	3		

- Molecule 10 is a protein called 60S ribosomal protein L8.

Mol	Chain	Residues	Atoms					AltConf	Trace
10	G	184	Total	C	N	O	S	0	0
			1452	934	262	254	2		

- Molecule 11 is a protein called 60S ribosomal protein L9-A.

Mol	Chain	Residues	Atoms					AltConf	Trace
11	H	183	Total	C	N	O	S	0	0
			1451	914	266	265	6		

- Molecule 12 is a protein called Putative ribosome biogenesis protein C8F11.04.

Mol	Chain	Residues	Atoms				AltConf	Trace
12	K	231	Total	C	N	O	0	0
			1145	683	231	231		

- Molecule 13 is a protein called 60S ribosomal protein L13.

Mol	Chain	Residues	Atoms					AltConf	Trace
13	L	118	Total	C	N	O	S	0	0
			962	603	204	154	1		

- Molecule 14 is a protein called 60S ribosomal protein L14.

Mol	Chain	Residues	Atoms					AltConf	Trace
14	M	124	Total	C	N	O	S	0	0
			1000	639	190	167	4		

- Molecule 15 is a protein called 60S ribosomal protein L15-A.

Mol	Chain	Residues	Atoms					AltConf	Trace
15	N	166	Total	C	N	O	S	0	0
			1406	883	291	229	3		

- Molecule 16 is a protein called 60S ribosomal protein L16-B.

Mol	Chain	Residues	Atoms					AltConf	Trace
16	O	187	Total	C	N	O	S	0	0
			1483	956	281	242	4		

- Molecule 17 is a protein called 60S ribosomal protein L17-A.

Mol	Chain	Residues	Atoms					AltConf	Trace
17	P	136	Total	C	N	O	S	0	0
			1080	690	196	191	3		

- Molecule 18 is a protein called 60S ribosomal protein L18-A.

Mol	Chain	Residues	Atoms					AltConf	Trace
18	Q	130	Total	C	N	O	S	0	0
			1020	646	196	177	1		

- Molecule 19 is a protein called 60S ribosomal protein L19-A.

Mol	Chain	Residues	Atoms					AltConf	Trace
19	R	57	Total	C	N	O	S	0	0
			456	282	93	78	3		

- Molecule 20 is a protein called 60S ribosomal protein L20-A.

Mol	Chain	Residues	Atoms					AltConf	Trace
			Total	C	N	O	S		
20	S	174	1434	925	269	235	5	0	0

- Molecule 21 is a protein called 60S ribosomal protein L22.

Mol	Chain	Residues	Atoms				AltConf	Trace
			Total	C	N	O		
21	U	98	484	288	98	98	0	0

- Molecule 22 is a protein called 60S ribosomal protein L23-A.

Mol	Chain	Residues	Atoms					AltConf	Trace
			Total	C	N	O	S		
22	V	129	976	617	179	172	8	0	0

- Molecule 23 is a protein called Ribosome assembly factor mrt4.

Mol	Chain	Residues	Atoms				AltConf	Trace
			Total	C	N	O		
23	W	193	948	562	193	193	0	0

- Molecule 24 is a protein called 60S ribosomal protein L25-A.

Mol	Chain	Residues	Atoms					AltConf	Trace
			Total	C	N	O	S		
24	X	130	1032	658	192	181	1	0	0

- Molecule 25 is a protein called 60S ribosomal protein L26.

Mol	Chain	Residues	Atoms					AltConf	Trace
			Total	C	N	O	S		
25	Y	125	998	622	201	173	2	0	0

- Molecule 26 is a protein called 60S ribosomal protein L27-A.

Mol	Chain	Residues	Atoms				AltConf	Trace
			Total	C	N	O		
26	Z	129	637	378	129	130	0	0

- Molecule 27 is a protein called 60S ribosomal protein L28-A.

Mol	Chain	Residues	Atoms				AltConf	Trace
27	a	94	Total	C	N	O	0	0
			747	474	142	131		

- Molecule 28 is a protein called Probable nucleolar GTP-binding protein 1.

Mol	Chain	Residues	Atoms				AltConf	Trace
28	b	378	Total	C	N	O	0	0
			1875	1119	378	378		

- Molecule 29 is a protein called 60S ribosomal protein L30-2.

Mol	Chain	Residues	Atoms				AltConf	Trace
29	c	66	Total	C	N	O	0	0
			325	193	66	66		

- Molecule 30 is a protein called 60S ribosomal protein L31.

Mol	Chain	Residues	Atoms					AltConf	Trace
30	d	94	Total	C	N	O	S	0	0
			787	500	156	128	3		

- Molecule 31 is a protein called 60S ribosomal protein L32-A.

Mol	Chain	Residues	Atoms					AltConf	Trace
31	e	117	Total	C	N	O	S	0	0
			939	588	190	156	5		

- Molecule 32 is a protein called 60S ribosomal protein L33-B.

Mol	Chain	Residues	Atoms					AltConf	Trace
32	f	106	Total	C	N	O	S	0	0
			839	534	162	140	3		

- Molecule 33 is a protein called 60S ribosomal protein L34-A.

Mol	Chain	Residues	Atoms				AltConf	Trace
33	g	87	Total	C	N	O	0	0
			428	254	87	87		

- Molecule 34 is a protein called 60S ribosomal protein L35.

Mol	Chain	Residues	Atoms				AltConf	Trace
34	h	121	Total	C	N	O	0	0
			999	629	194	176		

- Molecule 35 is a protein called 60S ribosomal protein L36-B.

Mol	Chain	Residues	Atoms					AltConf	Trace
35	i	78	Total	C	N	O	S	0	0
			637	394	135	107	1		

- Molecule 36 is a protein called 60S ribosomal protein L37-B.

Mol	Chain	Residues	Atoms					AltConf	Trace
36	j	71	Total	C	N	O	S	0	0
			563	346	121	90	6		

- Molecule 37 is a protein called 60S ribosomal protein L38-1.

Mol	Chain	Residues	Atoms				AltConf	Trace
37	k	70	Total	C	N	O	0	0
			349	209	70	70		

- Molecule 38 is a protein called Ribosome biogenesis protein erb1.

Mol	Chain	Residues	Atoms					AltConf	Trace
38	m	484	Total	C	N	O	S	0	0
			2881	1757	557	566	1		

- Molecule 39 is a protein called Pescadillo homolog.

Mol	Chain	Residues	Atoms					AltConf	Trace
39	n	416	Total	C	N	O	S	0	0
			3389	2186	587	604	12		

- Molecule 40 is a protein called Uncharacterized RNA-binding protein C1827.05c.

Mol	Chain	Residues	Atoms					AltConf	Trace
40	o	109	Total	C	N	O	S	0	0
			897	579	162	150	6		

- Molecule 41 is a protein called Ribosome biogenesis protein ytm1.

Mol	Chain	Residues	Atoms				AltConf	Trace
41	p	287	Total	C	N	O	0	0
			1416	842	287	287		

- Molecule 42 is a protein called Ribosome biogenesis protein nsa2.

Mol	Chain	Residues	Atoms					AltConf	Trace
42	r	154	Total	C	N	O	S	0	0
			1009	613	208	187	1		

- Molecule 43 is a protein called 60S ribosomal protein L7-A.

Mol	Chain	Residues	Atoms					AltConf	Trace
43	t	235	Total	C	N	O	S	0	0
			1948	1242	367	334	5		

- Molecule 44 is a protein called Ribosome biogenesis protein rlp24.

Mol	Chain	Residues	Atoms				AltConf	Trace
44	u	99	Total	C	N	O	0	0
			491	293	99	99		

- Molecule 45 is a protein called Nucleolar protein 16.

Mol	Chain	Residues	Atoms					AltConf	Trace
45	v	140	Total	C	N	O	S	0	0
			1143	721	220	199	3		

- Molecule 46 is a protein called Eukaryotic translation initiation factor 6.

Mol	Chain	Residues	Atoms				AltConf	Trace
46	y	225	Total	C	N	O	0	0
			1107	657	225	225		

- Molecule 47 is a protein called 60S ribosomal protein L21-A.

Mol	Chain	Residues	Atoms				AltConf	Trace
47	T	19	Total	C	N	O	0	0
			147	93	26	28		

- Molecule 48 is a RNA chain called RNA (62-MER).

Mol	Chain	Residues	Atoms					AltConf	Trace
			Total	C	N	O	P		
48	6	62	1315	590	229	434	62	0	0

- Molecule 49 is ZINC ION (three-letter code: ZN) (formula: Zn).

Mol	Chain	Residues	Atoms		AltConf
49	j	1	Total	Zn	0
			1	1	

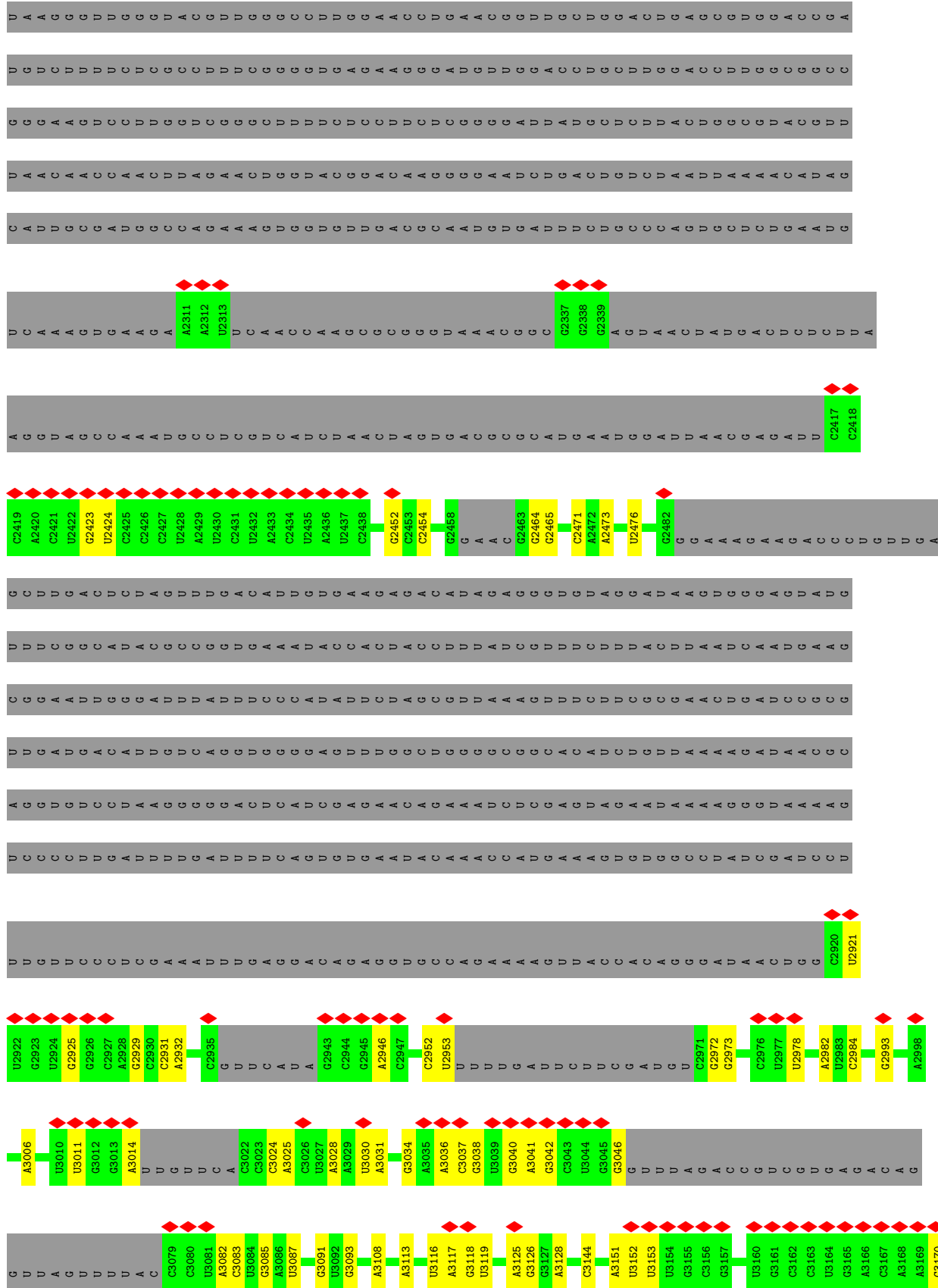

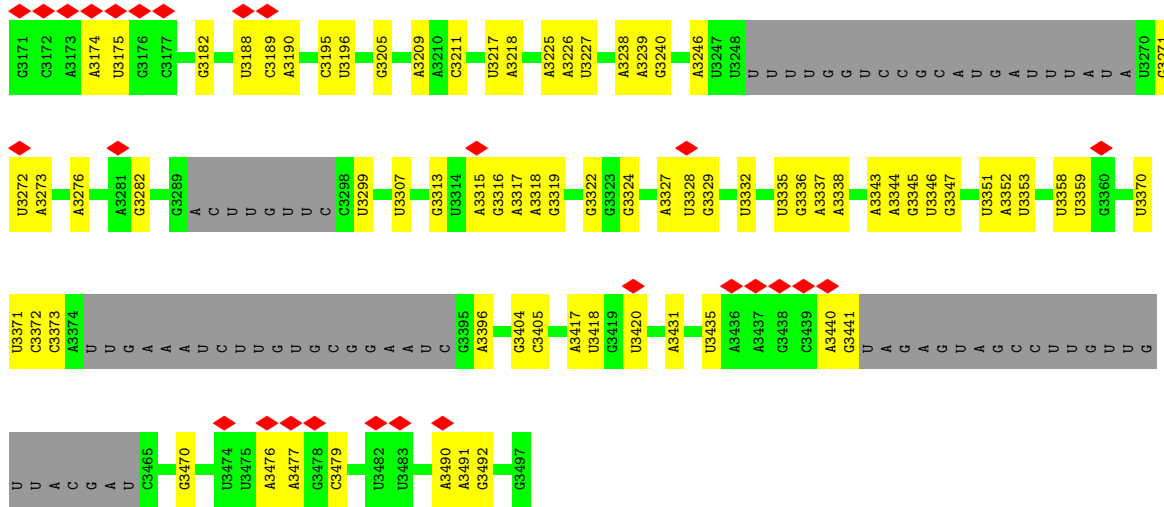

• Molecule 2: RNA (146-MER)

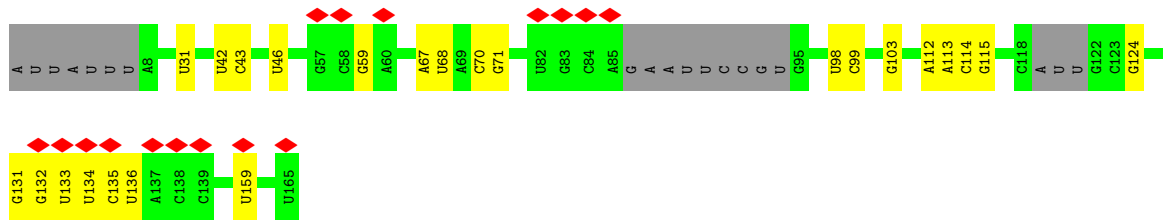
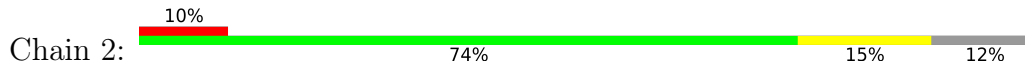

• Molecule 3: Protein mak16

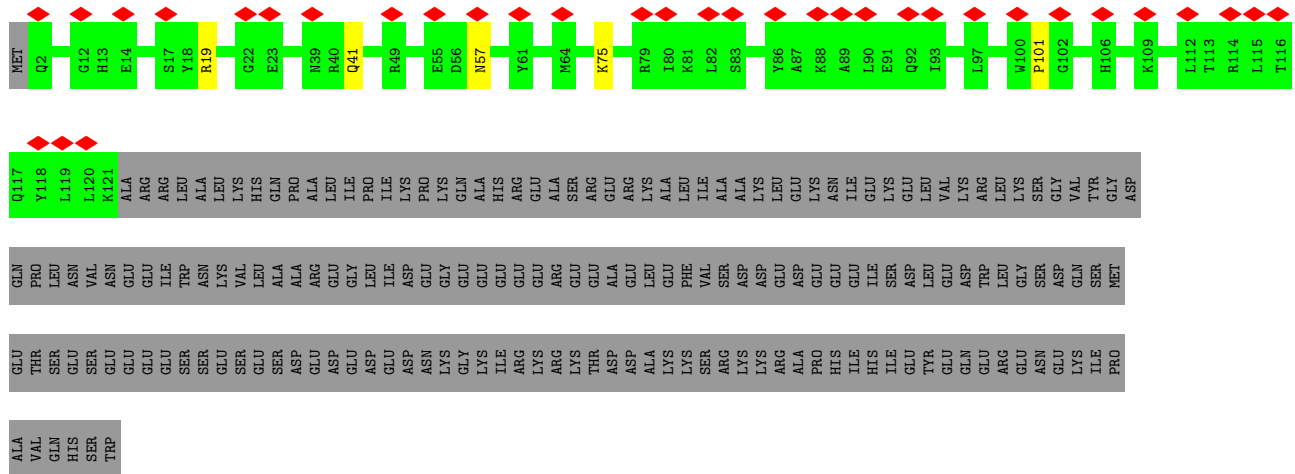

• Molecule 4: Ribosome biogenesis protein brx1



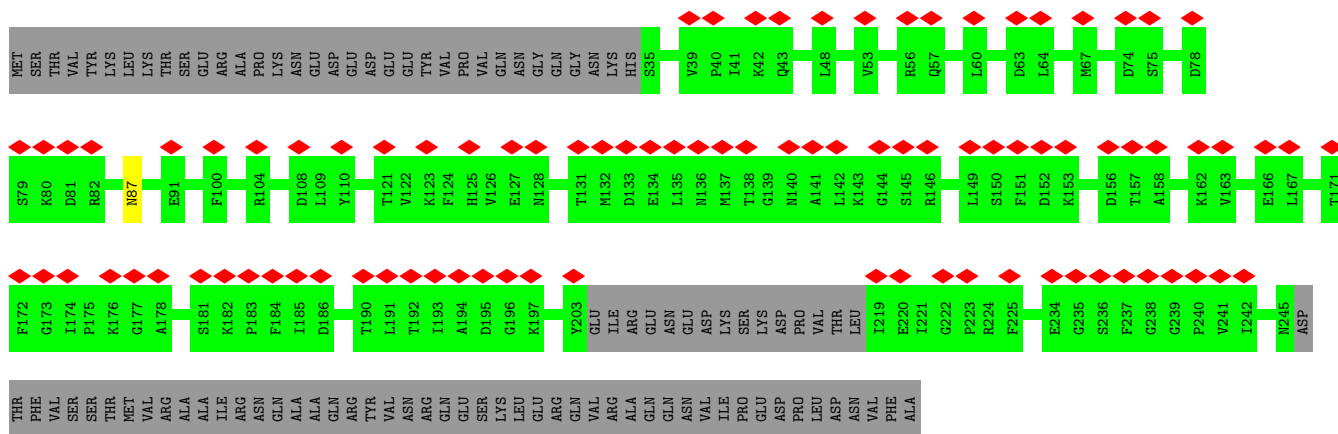

• Molecule 5: 60S ribosomal protein L3-A

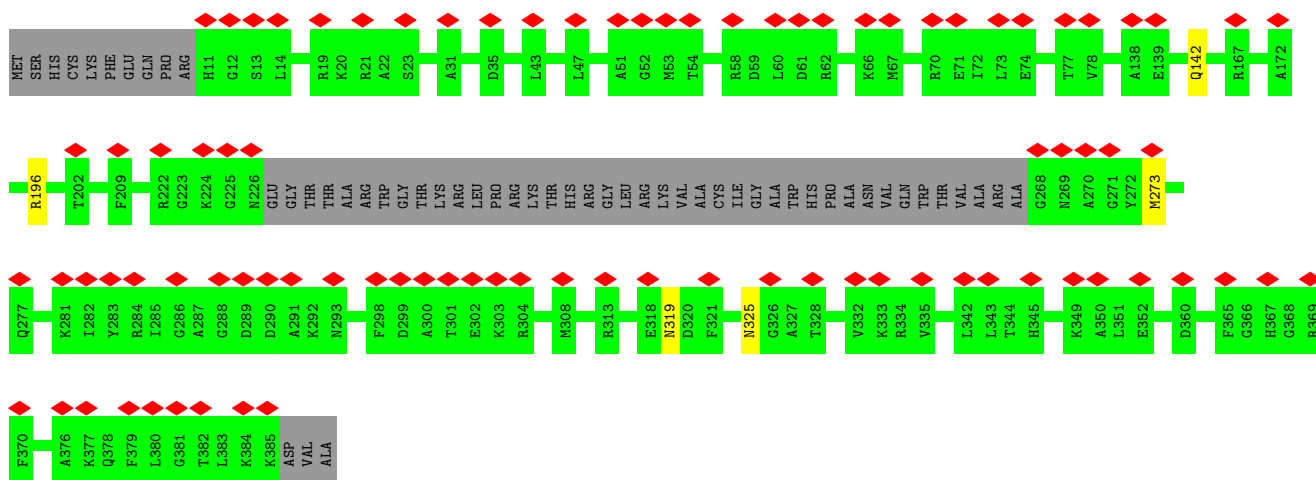
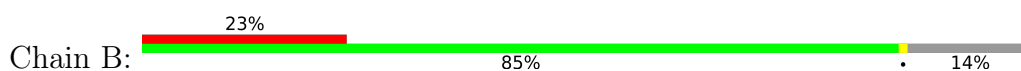

• Molecule 6: 60S ribosomal protein L4-B

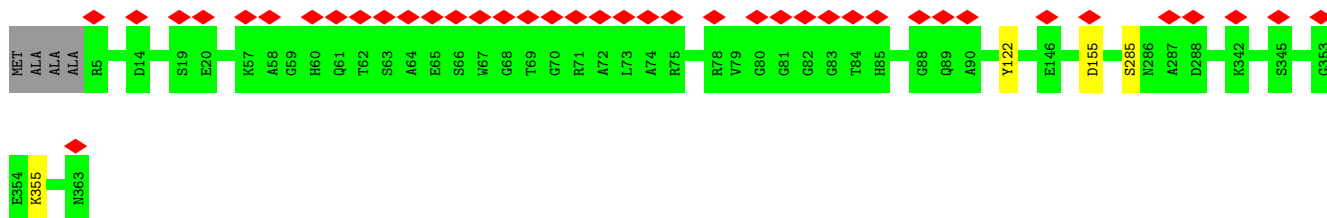

• Molecule 7: ATP-dependent RNA helicase has1

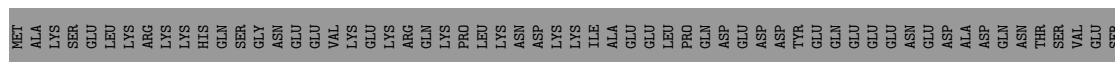

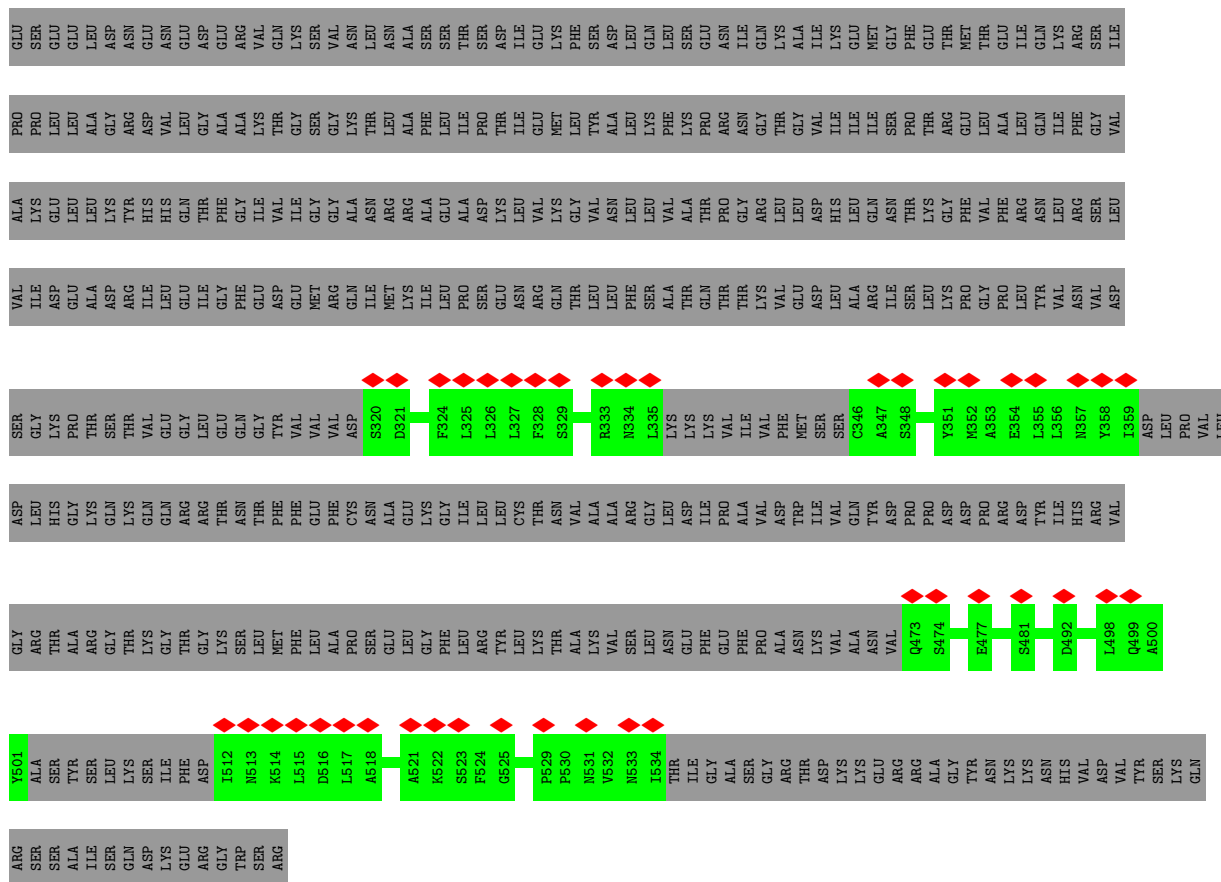

• Molecule 8: 60S ribosomal protein L6

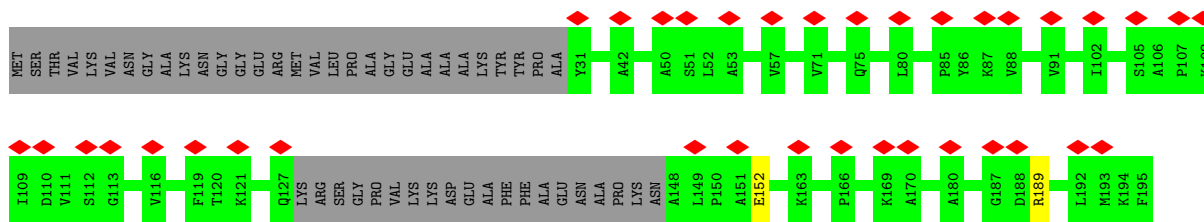

• Molecule 9: 60S ribosomal protein L7-B

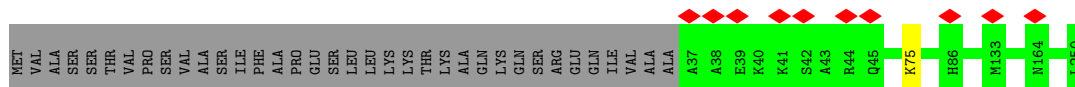
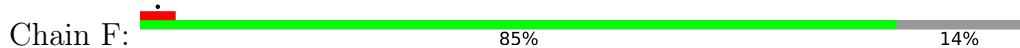

• Molecule 10: 60S ribosomal protein L8



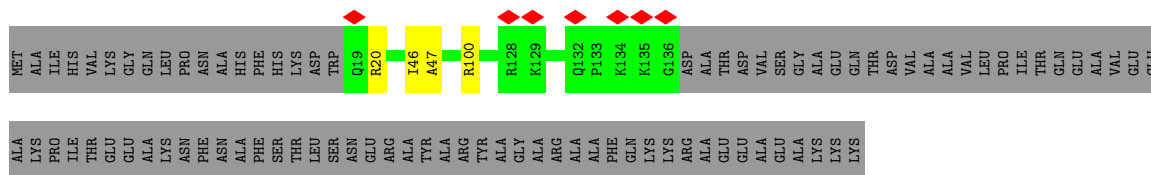

• Molecule 14: 60S ribosomal protein L14

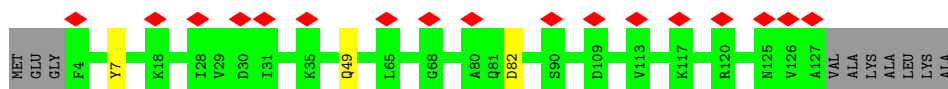
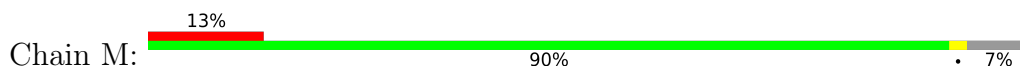

• Molecule 15: 60S ribosomal protein L15-A

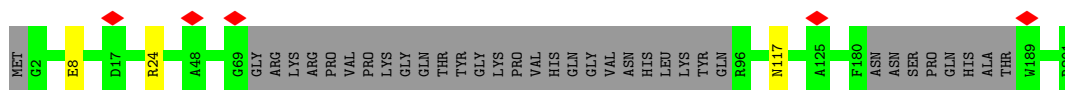
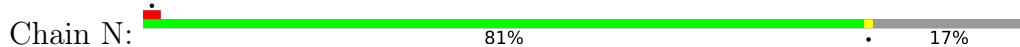

• Molecule 16: 60S ribosomal protein L16-B

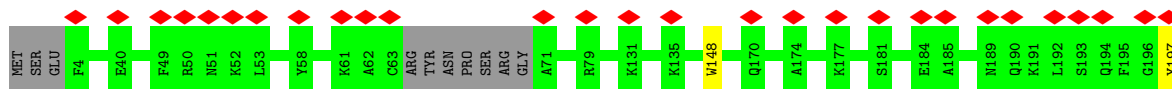

• Molecule 17: 60S ribosomal protein L17-A

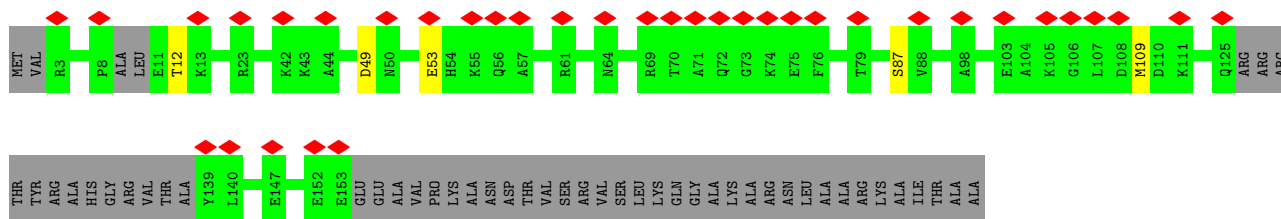

• Molecule 18: 60S ribosomal protein L18-A

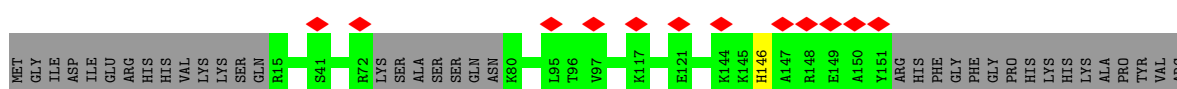



• Molecule 23: Ribosome assembly factor mrt4

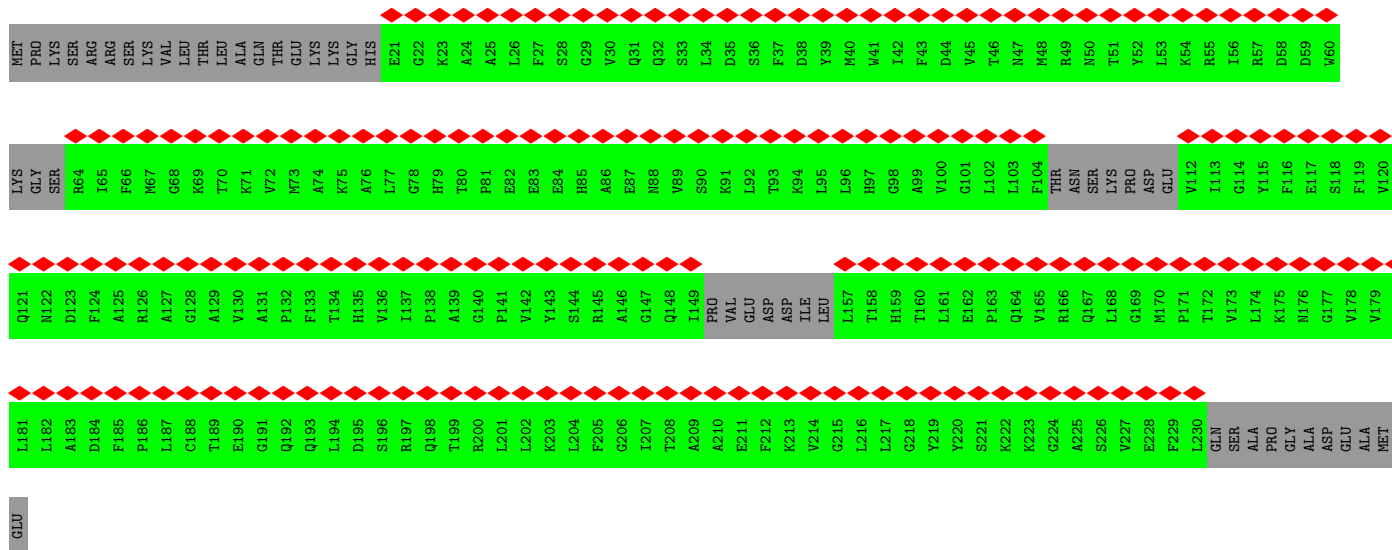
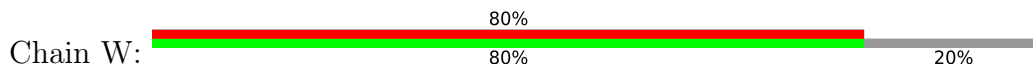

• Molecule 24: 60S ribosomal protein L25-A

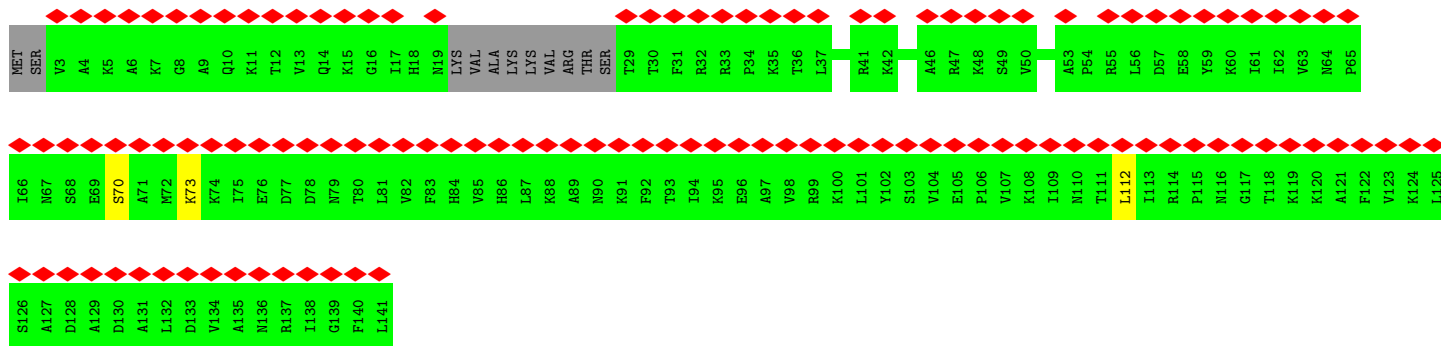
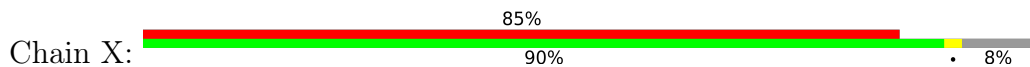

• Molecule 25: 60S ribosomal protein L26

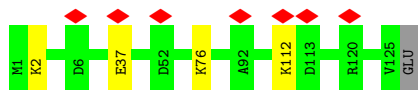

• Molecule 26: 60S ribosomal protein L27-A



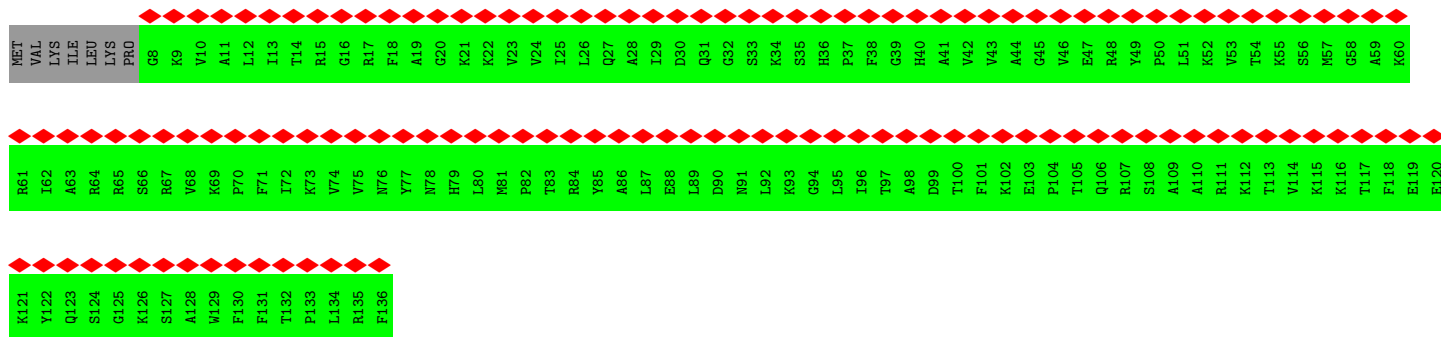

• Molecule 27: 60S ribosomal protein L28-A

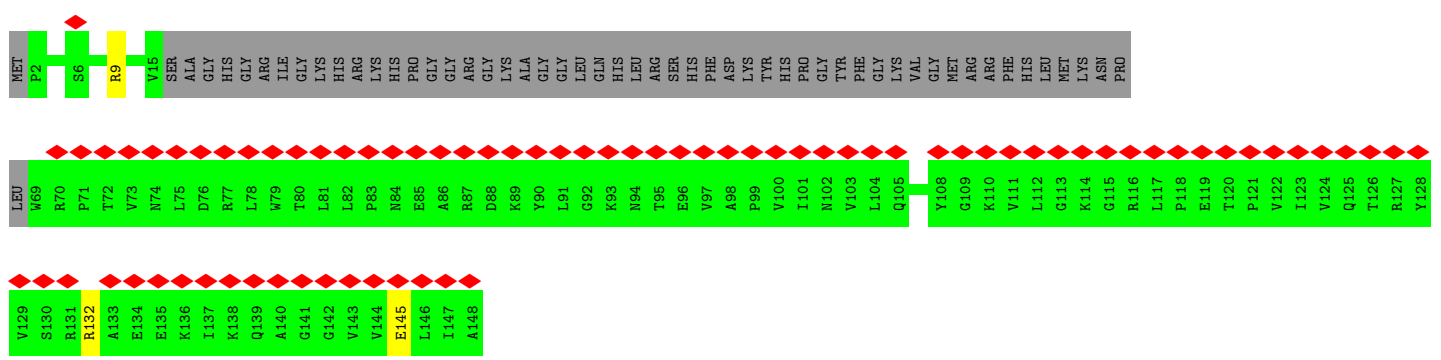

• Molecule 28: Probable nucleolar GTP-binding protein 1

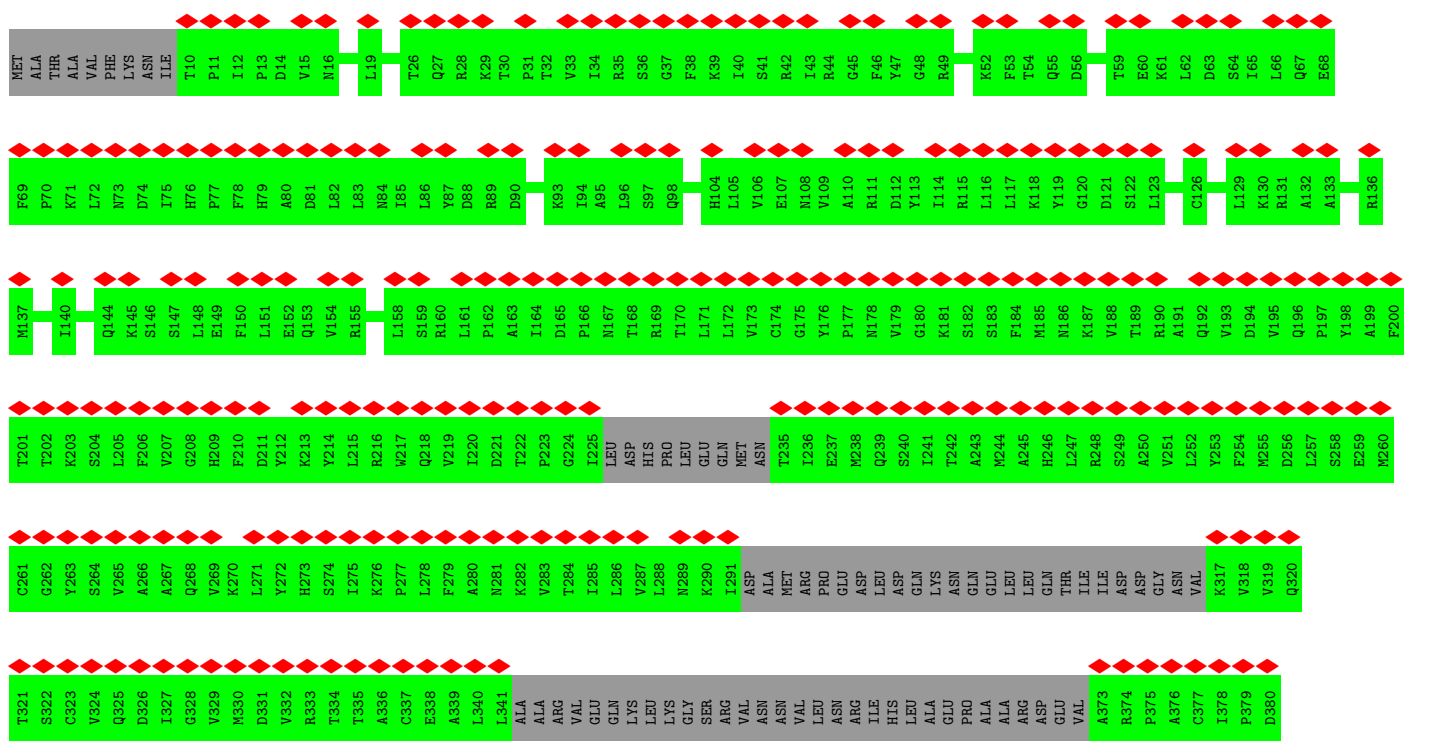

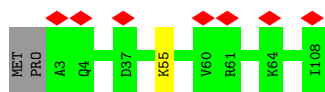

• Molecule 33: 60S ribosomal protein L34-A

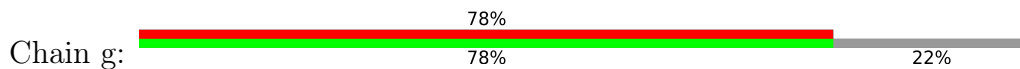

• Molecule 34: 60S ribosomal protein L35

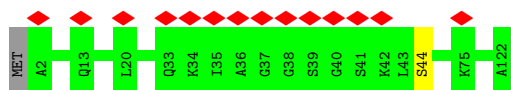

• Molecule 35: 60S ribosomal protein L36-B

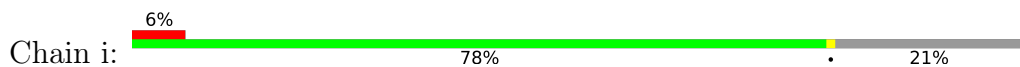

• Molecule 36: 60S ribosomal protein L37-B

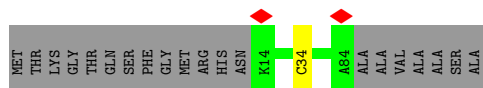
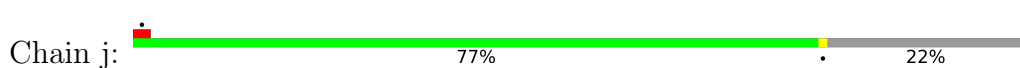

• Molecule 37: 60S ribosomal protein L38-1

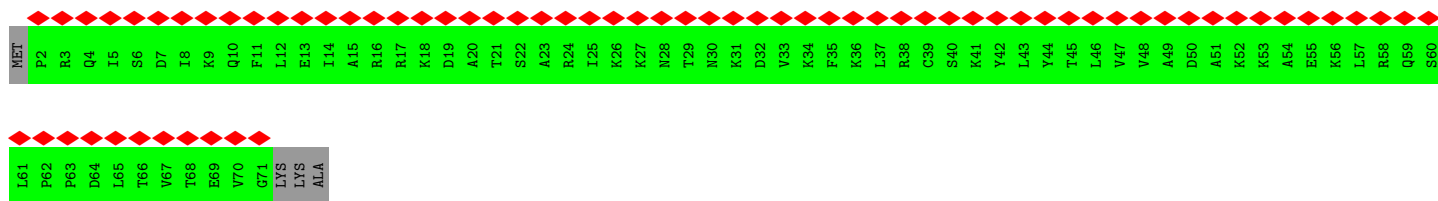

• Molecule 38: Ribosome biogenesis protein erb1

U U G A U A G A A A A A A A G A A A A U U A A G G A A A G A A A A A A C U A A A A A A G U U U U A A U C U C U U U U A U A

U U U G A A C C U U U A A C G A A A A A A A A A A G U U A U U U U U U U U U U C A C A G U A C C U U U U U U U

4 Experimental information

Property	Value	Source
EM reconstruction method	SINGLE PARTICLE	Depositor
Imposed symmetry	POINT, Not provided	
Number of particles used	19000	Depositor
Resolution determination method	FSC 0.143 CUT-OFF	Depositor
CTF correction method	PHASE FLIPPING AND AMPLITUDE CORRECTION	Depositor
Microscope	TFS KRIOS	Depositor
Voltage (kV)	300	Depositor
Electron dose ($e^-/\text{\AA}^2$)	60	Depositor
Minimum defocus (nm)	500	Depositor
Maximum defocus (nm)	2000	Depositor
Magnification	Not provided	
Image detector	GATAN K3 (6k x 4k)	Depositor
Maximum map value	0.532	Depositor
Minimum map value	-0.304	Depositor
Average map value	0.001	Depositor
Map value standard deviation	0.008	Depositor
Recommended contour level	0.05	Depositor
Map size (Å)	542.72, 542.72, 542.72	wwPDB
Map dimensions	512, 512, 512	wwPDB
Map angles (°)	90.0, 90.0, 90.0	wwPDB
Pixel spacing (Å)	1.06, 1.06, 1.06	Depositor

5 Model quality [i](#)

5.1 Standard geometry [i](#)

Bond lengths and bond angles in the following residue types are not validated in this section:
ZN

The Z score for a bond length (or angle) is the number of standard deviations the observed value is removed from the expected value. A bond length (or angle) with $|Z| > 5$ is considered an outlier worth inspection. RMSZ is the root-mean-square of all Z scores of the bond lengths (or angles).

Mol	Chain	Bond lengths		Bond angles	
		RMSZ	# Z >5	RMSZ	# Z >5
1	1	0.33	0/48337	0.75	0/75284
2	2	0.45	0/3465	0.76	0/5390
3	3	0.28	0/1037	0.53	0/1396
4	A	0.25	0/1015	0.45	0/1406
5	B	0.28	0/2706	0.54	0/3635
6	C	0.32	0/2848	0.57	0/3842
7	D	0.22	0/404	0.32	0/558
8	E	0.28	0/1146	0.56	0/1545
9	F	0.30	0/1781	0.52	0/2389
10	G	0.32	0/1474	0.52	0/1987
11	H	0.27	0/1470	0.56	0/1982
12	K	0.24	0/1143	0.42	0/1591
13	L	0.35	0/980	0.62	0/1314
14	M	0.30	0/1017	0.52	0/1365
15	N	0.36	0/1436	0.59	0/1920
16	O	0.29	0/1511	0.51	0/2023
17	P	0.30	0/1101	0.52	0/1475
18	Q	0.29	0/1031	0.56	0/1384
19	R	0.29	0/460	0.62	0/614
20	S	0.28	0/1470	0.56	0/1977
21	U	0.24	0/483	0.42	0/671
22	V	0.25	0/992	0.54	0/1337
23	W	0.24	0/944	0.44	0/1305
24	X	0.30	0/1048	0.56	0/1406
25	Y	0.32	0/1008	0.61	0/1341
26	Z	0.24	0/636	0.40	0/882
27	a	0.35	0/760	0.61	0/1026
28	b	0.23	0/1870	0.38	0/2601
29	c	0.24	0/323	0.40	0/446
30	d	0.43	0/801	0.71	0/1075
31	e	0.32	0/953	0.57	0/1271
32	f	0.32	0/859	0.55	0/1152

Mol	Chain	Bond lengths		Bond angles	
		RMSZ	# Z >5	RMSZ	# Z >5
33	g	0.24	0/427	0.41	0/592
34	h	0.29	0/1008	0.53	0/1340
35	i	0.27	0/643	0.57	0/852
36	j	0.34	0/575	0.61	0/761
37	k	0.24	0/348	0.39	0/485
38	m	0.29	0/2910	0.48	0/3993
39	n	0.28	0/3468	0.48	0/4670
40	o	0.32	0/919	0.57	0/1232
41	p	0.24	0/1411	0.44	0/1956
42	r	0.29	0/1014	0.57	0/1361
43	t	0.27	0/1979	0.52	0/2645
44	u	0.23	0/489	0.37	0/679
45	v	0.30	0/1161	0.56	0/1552
46	y	0.24	0/1106	0.45	0/1536
47	T	0.26	0/151	0.51	0/207
48	6	0.19	0/1466	0.68	0/2270
All	All	0.32	0/105584	0.65	0/153721

There are no bond length outliers.

There are no bond angle outliers.

There are no chirality outliers.

There are no planarity outliers.

5.2 Too-close contacts [i](#)

Due to software issues we are unable to calculate clashes - this section is therefore empty.

5.3 Torsion angles [i](#)

5.3.1 Protein backbone [i](#)

In the following table, the Percentiles column shows the percent Ramachandran outliers of the chain as a percentile score with respect to all PDB entries followed by that with respect to all EM entries.

The Analysed column shows the number of residues for which the backbone conformation was analysed, and the total number of residues.

Mol	Chain	Analysed	Favoured	Allowed	Outliers	Percentiles
3	3	118/302 (39%)	108 (92%)	10 (8%)	0	100 100

Continued on next page...

Continued from previous page...

Mol	Chain	Analysed	Favoured	Allowed	Outliers	Percentiles	
4	A	192/295 (65%)	188 (98%)	4 (2%)	0	100	100
5	B	330/388 (85%)	307 (93%)	23 (7%)	0	100	100
6	C	357/363 (98%)	329 (92%)	28 (8%)	0	100	100
7	D	74/578 (13%)	74 (100%)	0	0	100	100
8	E	141/195 (72%)	133 (94%)	8 (6%)	0	100	100
9	F	212/250 (85%)	202 (95%)	10 (5%)	0	100	100
10	G	180/259 (70%)	170 (94%)	8 (4%)	2 (1%)	14	44
11	H	181/190 (95%)	166 (92%)	15 (8%)	0	100	100
12	K	227/373 (61%)	213 (94%)	13 (6%)	1 (0%)	34	67
13	L	116/208 (56%)	108 (93%)	7 (6%)	1 (1%)	17	49
14	M	122/134 (91%)	116 (95%)	6 (5%)	0	100	100
15	N	160/201 (80%)	147 (92%)	13 (8%)	0	100	100
16	O	183/197 (93%)	180 (98%)	3 (2%)	0	100	100
17	P	130/187 (70%)	115 (88%)	14 (11%)	1 (1%)	19	51
18	Q	126/187 (67%)	119 (94%)	7 (6%)	0	100	100
19	R	55/193 (28%)	51 (93%)	4 (7%)	0	100	100
20	S	172/176 (98%)	160 (93%)	10 (6%)	2 (1%)	13	41
21	U	96/117 (82%)	92 (96%)	4 (4%)	0	100	100
22	V	127/139 (91%)	124 (98%)	3 (2%)	0	100	100
23	W	185/241 (77%)	176 (95%)	9 (5%)	0	100	100
24	X	126/141 (89%)	121 (96%)	5 (4%)	0	100	100
25	Y	123/126 (98%)	117 (95%)	6 (5%)	0	100	100
26	Z	127/136 (93%)	125 (98%)	2 (2%)	0	100	100
27	a	90/148 (61%)	87 (97%)	3 (3%)	0	100	100
28	b	368/642 (57%)	360 (98%)	8 (2%)	0	100	100
29	c	62/117 (53%)	60 (97%)	2 (3%)	0	100	100
30	d	90/113 (80%)	82 (91%)	7 (8%)	1 (1%)	14	44
31	e	115/127 (91%)	109 (95%)	6 (5%)	0	100	100
32	f	104/108 (96%)	96 (92%)	8 (8%)	0	100	100
33	g	85/112 (76%)	84 (99%)	1 (1%)	0	100	100
34	h	119/122 (98%)	117 (98%)	2 (2%)	0	100	100

Continued on next page...

Continued from previous page...

Mol	Chain	Analysed	Favoured	Allowed	Outliers	Percentiles	
35	i	76/99 (77%)	73 (96%)	3 (4%)	0	100	100
36	j	69/91 (76%)	67 (97%)	2 (3%)	0	100	100
37	k	68/74 (92%)	67 (98%)	1 (2%)	0	100	100
38	m	470/740 (64%)	450 (96%)	20 (4%)	0	100	100
39	n	410/607 (68%)	388 (95%)	22 (5%)	0	100	100
40	o	107/276 (39%)	102 (95%)	5 (5%)	0	100	100
41	p	277/440 (63%)	270 (98%)	7 (2%)	0	100	100
42	r	146/260 (56%)	143 (98%)	3 (2%)	0	100	100
43	t	233/249 (94%)	219 (94%)	14 (6%)	0	100	100
44	u	95/192 (50%)	90 (95%)	5 (5%)	0	100	100
45	v	136/209 (65%)	127 (93%)	9 (7%)	0	100	100
46	y	223/244 (91%)	219 (98%)	4 (2%)	0	100	100
47	T	17/160 (11%)	17 (100%)	0	0	100	100
All	All	7220/10706 (67%)	6868 (95%)	344 (5%)	8 (0%)	54	82

5 of 8 Ramachandran outliers are listed below:

Mol	Chain	Res	Type
17	P	12	THR
20	S	158	VAL
10	G	227	ASP
20	S	159	VAL
12	K	153	ILE

5.3.2 Protein sidechains [i](#)

In the following table, the Percentiles column shows the percent sidechain outliers of the chain as a percentile score with respect to all PDB entries followed by that with respect to all EM entries.

The Analysed column shows the number of residues for which the sidechain conformation was analysed, and the total number of residues.

Mol	Chain	Analysed	Rotameric	Outliers	Percentiles	
3	3	109/271 (40%)	104 (95%)	5 (5%)	27	57
4	A	11/266 (4%)	10 (91%)	1 (9%)	9	32
5	B	283/326 (87%)	278 (98%)	5 (2%)	59	79

Continued on next page...

Continued from previous page...

Mol	Chain	Analysed	Rotameric	Outliers	Percentiles	
6	C	296/297 (100%)	292 (99%)	4 (1%)	67	83
8	E	119/155 (77%)	117 (98%)	2 (2%)	60	80
9	F	180/210 (86%)	179 (99%)	1 (1%)	86	94
10	G	154/212 (73%)	152 (99%)	2 (1%)	69	84
11	H	164/170 (96%)	154 (94%)	10 (6%)	18	48
13	L	99/167 (59%)	96 (97%)	3 (3%)	41	68
14	M	107/113 (95%)	104 (97%)	3 (3%)	43	70
15	N	146/176 (83%)	143 (98%)	3 (2%)	53	76
16	O	153/162 (94%)	151 (99%)	2 (1%)	69	84
17	P	112/149 (75%)	108 (96%)	4 (4%)	35	63
18	Q	111/159 (70%)	110 (99%)	1 (1%)	78	90
19	R	51/162 (32%)	46 (90%)	5 (10%)	8	28
20	S	152/154 (99%)	148 (97%)	4 (3%)	46	72
22	V	102/107 (95%)	94 (92%)	8 (8%)	12	39
24	X	112/122 (92%)	109 (97%)	3 (3%)	44	70
25	Y	110/111 (99%)	106 (96%)	4 (4%)	35	63
27	a	81/122 (66%)	78 (96%)	3 (4%)	34	62
30	d	86/102 (84%)	75 (87%)	11 (13%)	4	16
31	e	100/107 (94%)	98 (98%)	2 (2%)	55	77
32	f	89/91 (98%)	88 (99%)	1 (1%)	73	86
34	h	106/107 (99%)	105 (99%)	1 (1%)	78	90
35	i	68/84 (81%)	67 (98%)	1 (2%)	65	82
36	j	58/71 (82%)	57 (98%)	1 (2%)	60	80
38	m	132/659 (20%)	128 (97%)	4 (3%)	41	68
39	n	364/532 (68%)	355 (98%)	9 (2%)	47	72
40	o	96/246 (39%)	94 (98%)	2 (2%)	53	76
42	r	59/224 (26%)	52 (88%)	7 (12%)	5	19
43	t	211/223 (95%)	206 (98%)	5 (2%)	49	74
45	v	120/181 (66%)	116 (97%)	4 (3%)	38	66
47	T	17/139 (12%)	17 (100%)	0	100	100
All	All	4158/6377 (65%)	4037 (97%)	121 (3%)	45	69

5 of 121 residues with a non-rotameric sidechain are listed below:

Mol	Chain	Res	Type
22	V	51	LEU
42	r	38	TYR
27	a	132	ARG
42	r	36	SER
45	v	176	THR

Sometimes sidechains can be flipped to improve hydrogen bonding and reduce clashes. 5 of 9 such sidechains are listed below:

Mol	Chain	Res	Type
43	t	163	ASN
45	v	194	ASN
11	H	41	HIS
13	L	66	ASN
17	P	54	HIS

5.3.3 RNA [i](#)

Mol	Chain	Analysed	Backbone Outliers	Pucker Outliers
1	1	1981/3497 (56%)	472 (23%)	23 (1%)
2	2	143/165 (86%)	23 (16%)	2 (1%)
48	6	57/300 (19%)	24 (42%)	0
All	All	2181/3962 (55%)	519 (23%)	25 (1%)

5 of 519 RNA backbone outliers are listed below:

Mol	Chain	Res	Type
1	1	5	G
1	1	6	A
1	1	7	C
1	1	25	U
1	1	26	A

5 of 25 RNA pucker outliers are listed below:

Mol	Chain	Res	Type
1	1	1540	A
1	1	3217	U
2	2	131	G
1	1	1916	G

Continued on next page...

Continued from previous page...

Mol	Chain	Res	Type
1	1	3239	A

5.4 Non-standard residues in protein, DNA, RNA chains [i](#)

There are no non-standard protein/DNA/RNA residues in this entry.

5.5 Carbohydrates [i](#)

There are no monosaccharides in this entry.

5.6 Ligand geometry [i](#)

Of 1 ligands modelled in this entry, 1 is monoatomic - leaving 0 for Mogul analysis.

There are no bond length outliers.

There are no bond angle outliers.

There are no chirality outliers.

There are no torsion outliers.

There are no ring outliers.

No monomer is involved in short contacts.

5.7 Other polymers [i](#)

There are no such residues in this entry.

5.8 Polymer linkage issues [i](#)

There are no chain breaks in this entry.

6 Map visualisation [i](#)

This section contains visualisations of the EMDB entry EMD-24397. These allow visual inspection of the internal detail of the map and identification of artifacts.

No raw map or half-maps were deposited for this entry and therefore no images, graphs, etc. pertaining to the raw map can be shown.

6.1 Orthogonal projections [i](#)

6.1.1 Primary map

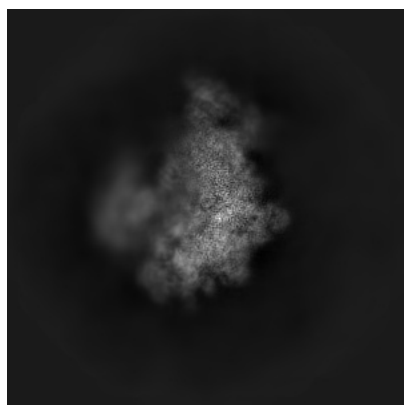

X

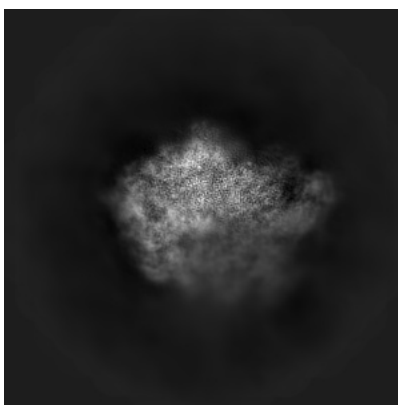

Y

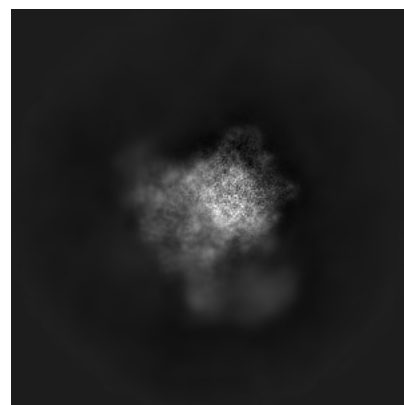

Z

The images above show the map projected in three orthogonal directions.

6.2 Central slices [i](#)

6.2.1 Primary map

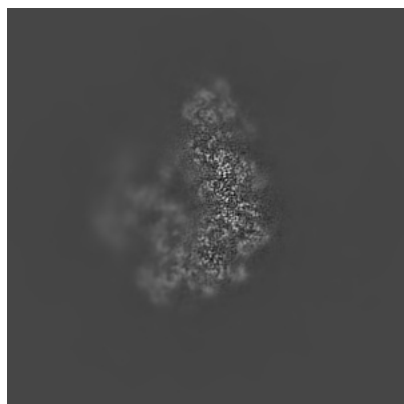

X Index: 256

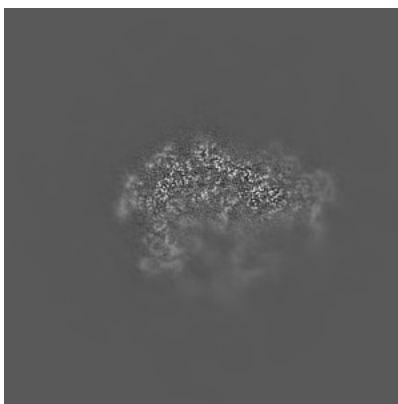

Y Index: 256

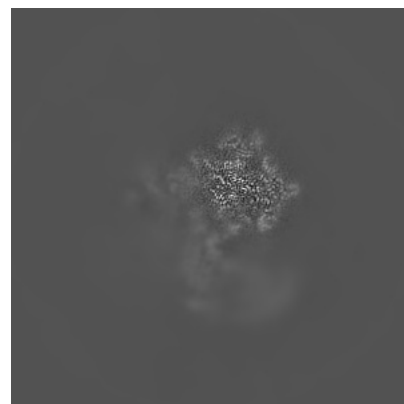

Z Index: 256

The images above show central slices of the map in three orthogonal directions.

6.3 Largest variance slices [i](#)

6.3.1 Primary map

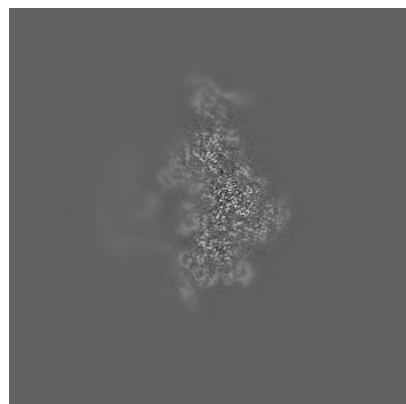

X Index: 282

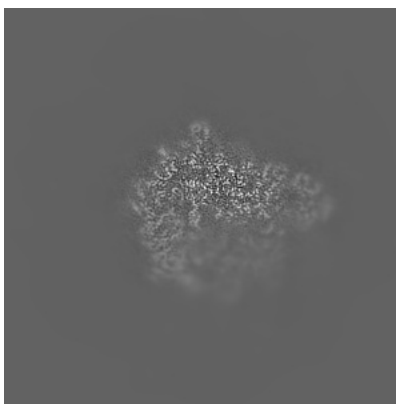

Y Index: 272

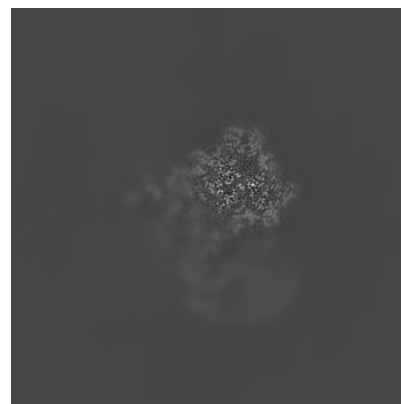

Z Index: 250

The images above show the largest variance slices of the map in three orthogonal directions.

6.4 Orthogonal surface views [i](#)

6.4.1 Primary map



X



Y



Z

The images above show the 3D surface view of the map at the recommended contour level 0.05. These images, in conjunction with the slice images, may facilitate assessment of whether an appropriate contour level has been provided.

6.5 Mask visualisation

This section was not generated. No masks/segmentation were deposited.

7 Map analysis [i](#)

This section contains the results of statistical analysis of the map.

7.1 Map-value distribution [i](#)

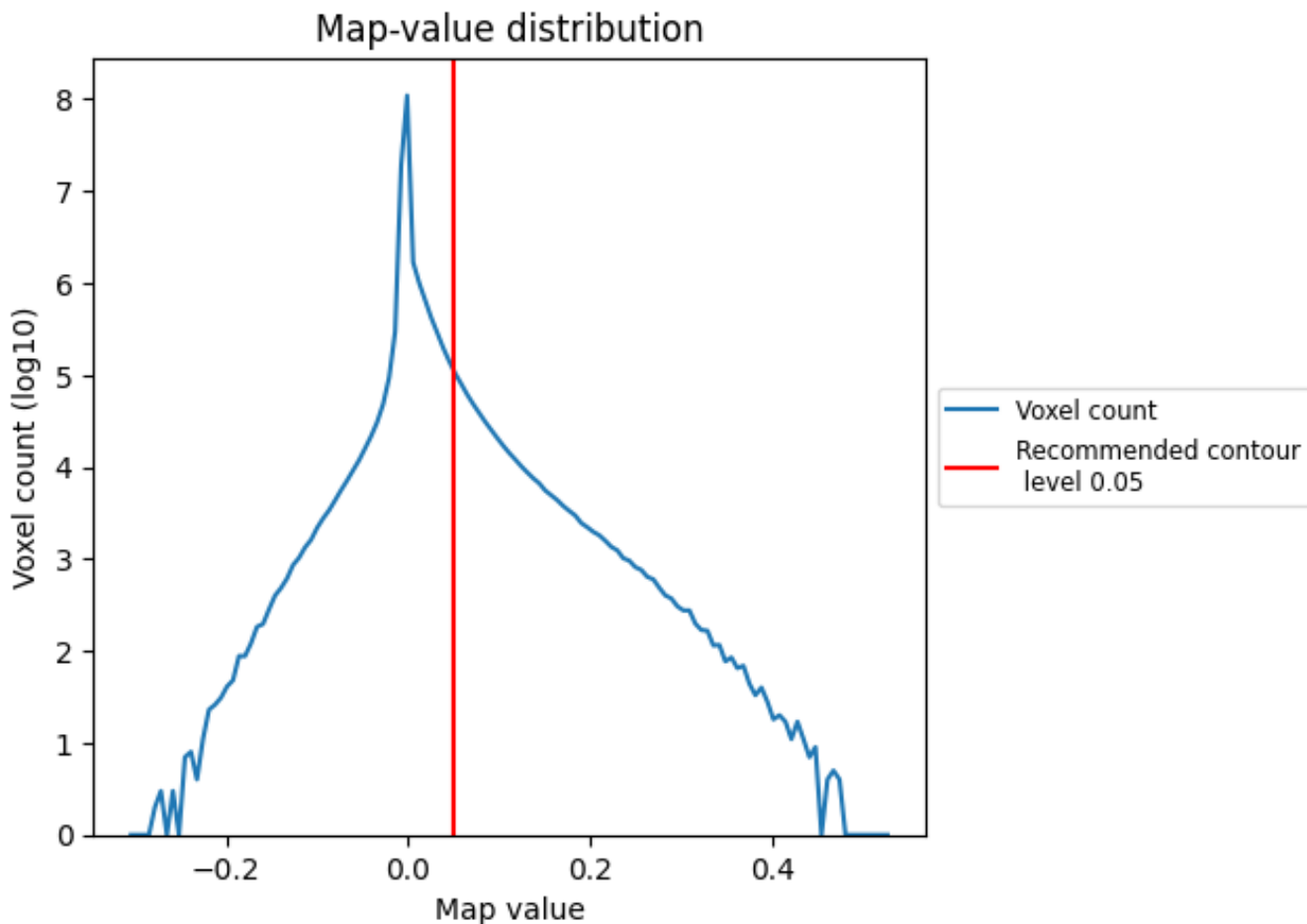

The map-value distribution is plotted in 128 intervals along the x-axis. The y-axis is logarithmic. A spike in this graph at zero usually indicates that the volume has been masked.

7.2 Volume estimate [i](#)

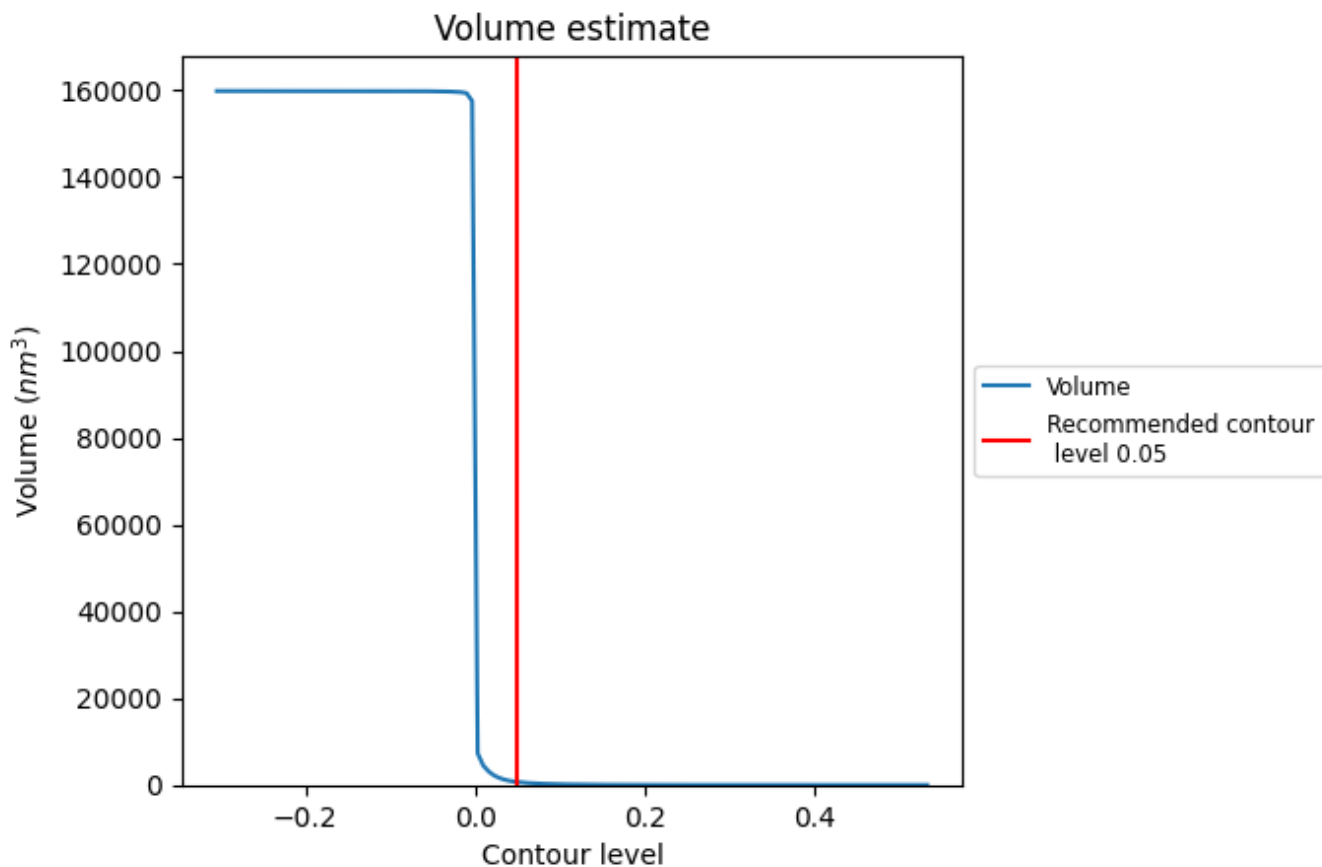

The volume at the recommended contour level is 669 nm^3 ; this corresponds to an approximate mass of 605 kDa.

The volume estimate graph shows how the enclosed volume varies with the contour level. The recommended contour level is shown as a vertical line and the intersection between the line and the curve gives the volume of the enclosed surface at the given level.

7.3 Rotationally averaged power spectrum [i](#)

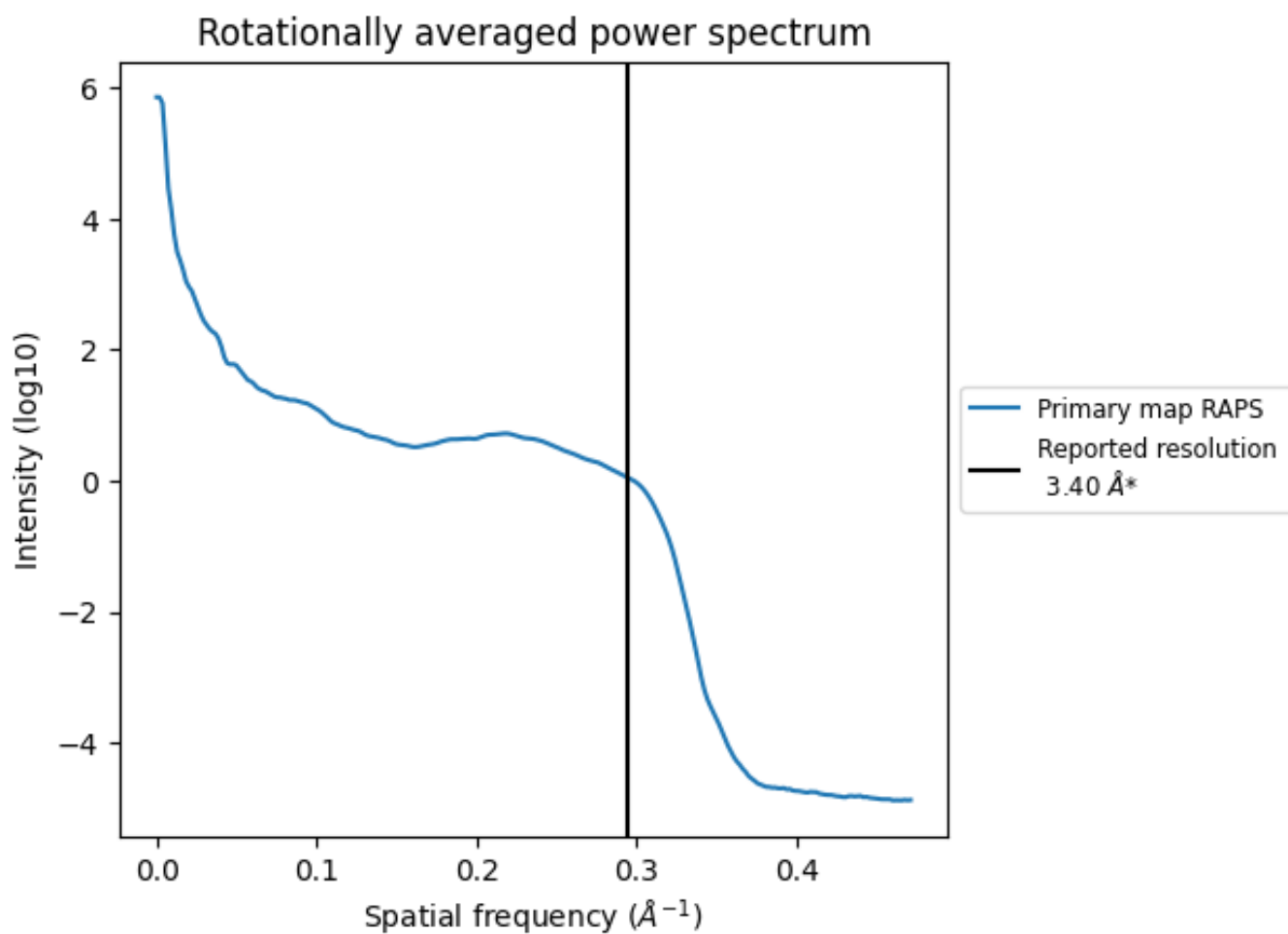

*Reported resolution corresponds to spatial frequency of 0.294\AA^{-1}

8 Fourier-Shell correlation

This section was not generated. No FSC curve or half-maps provided.

9 Map-model fit [i](#)

This section contains information regarding the fit between EMDB map EMD-24397 and PDB model 8ETG. Per-residue inclusion information can be found in section 3 on page 13.

9.1 Map-model overlay [i](#)

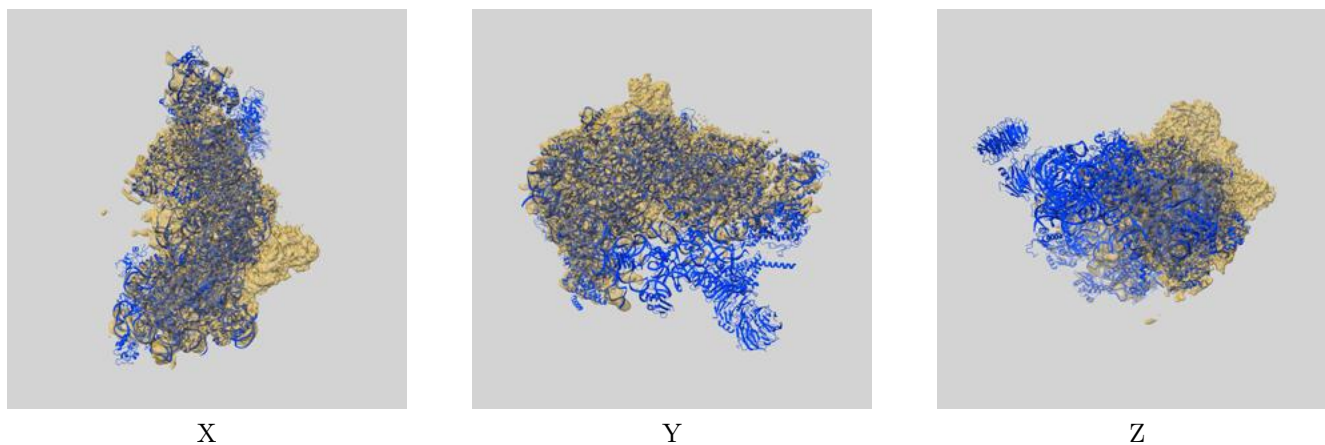

The images above show the 3D surface view of the map at the recommended contour level 0.05 at 50% transparency in yellow overlaid with a ribbon representation of the model coloured in blue. These images allow for the visual assessment of the quality of fit between the atomic model and the map.

9.2 Q-score mapped to coordinate model [i](#)

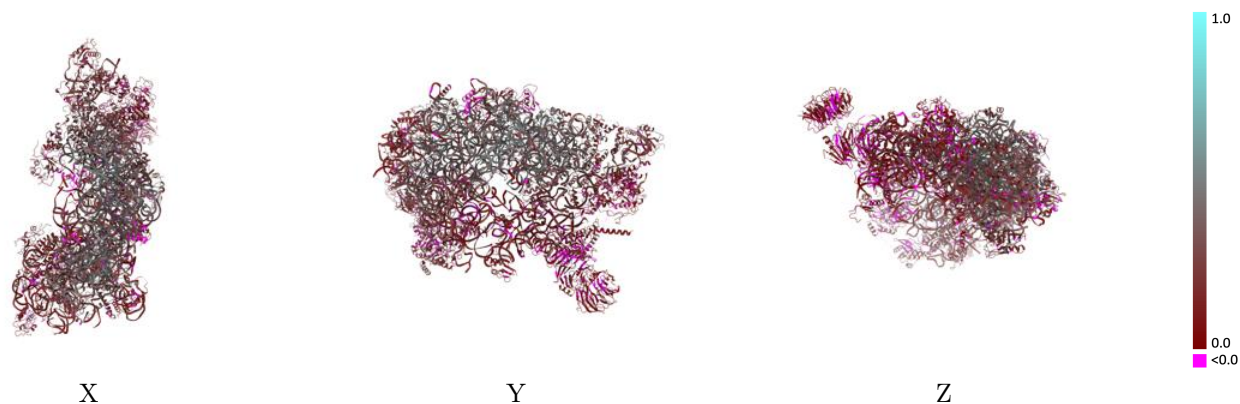

The images above show the model with each residue coloured according to its Q-score. This shows their resolvability in the map with higher Q-score values reflecting better resolvability. Please note: Q-score is calculating the resolvability of atoms, and thus high values are only expected at resolutions at which atoms can be resolved. Low Q-score values may therefore be expected for many entries.

9.3 Atom inclusion mapped to coordinate model [i](#)

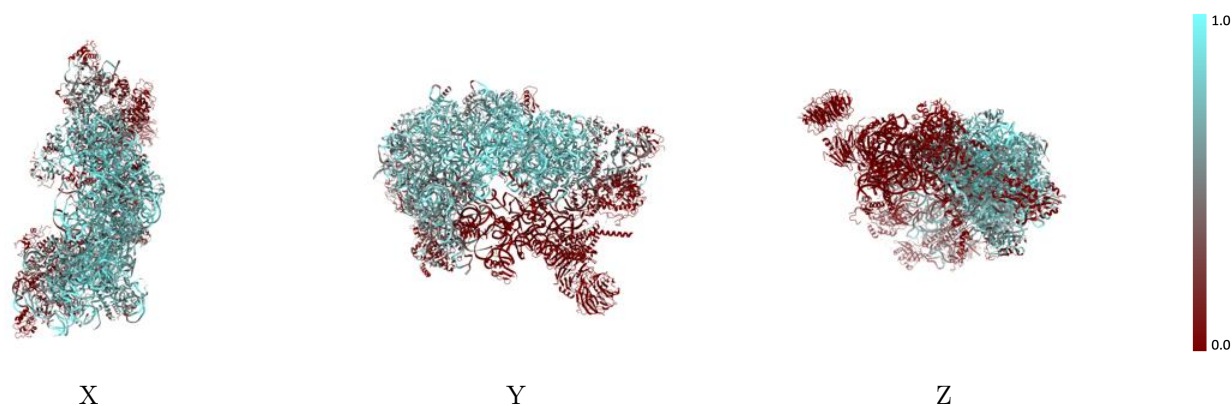

The images above show the model with each residue coloured according to its atom inclusion. This shows to what extent they are inside the map at the recommended contour level (0.05).



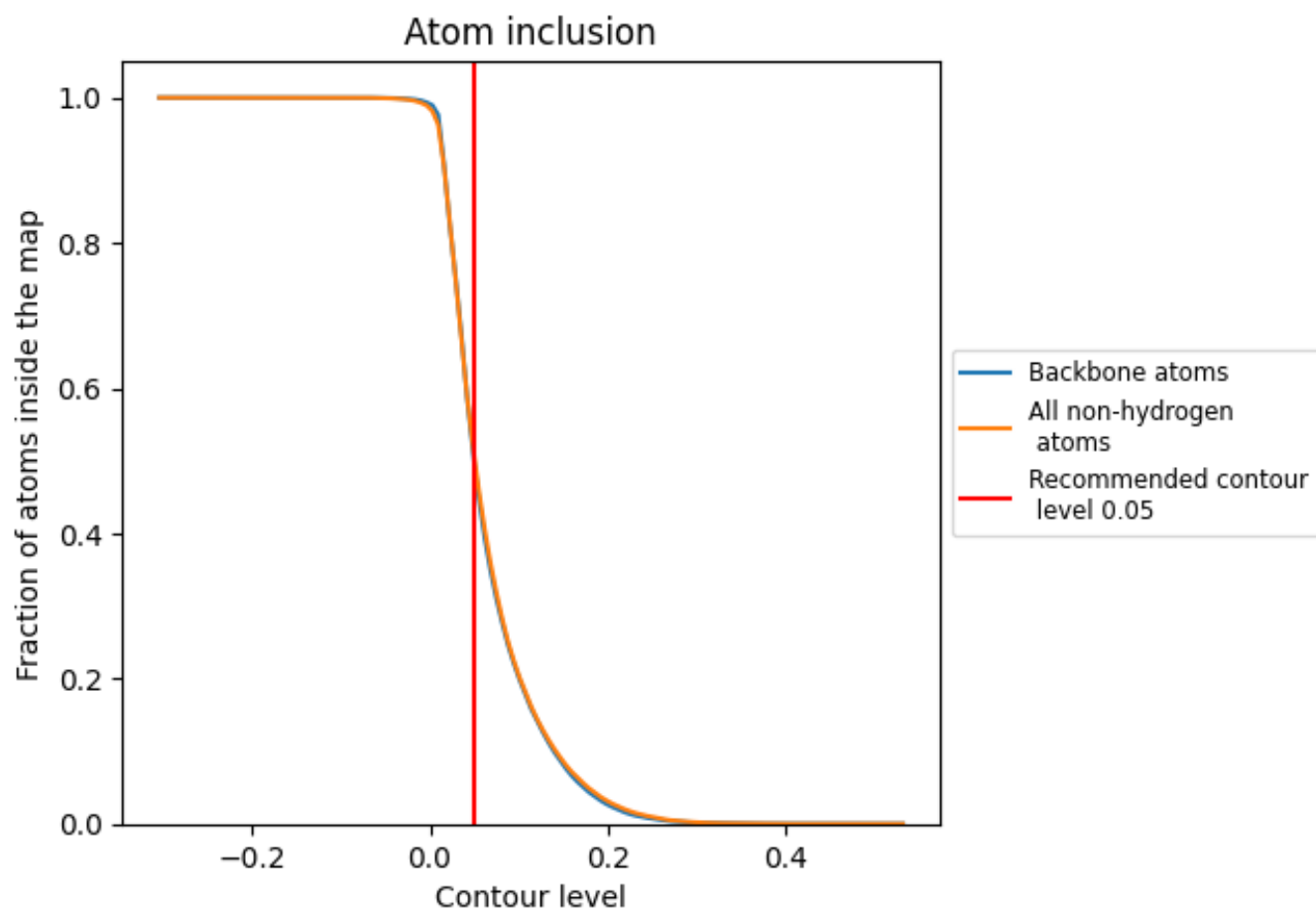



































































9.4 Atom inclusion [i](#)



At the recommended contour level, 50% of all backbone atoms, 51% of all non-hydrogen atoms, are inside the map.

9.5 Map-model fit summary





























The table lists the average atom inclusion at the recommended contour level (0.05) and Q-score for the entire model and for each chain.

Chain	Atom inclusion	Q-score
All	 0.5053	 0.2580
1	 0.6106	 0.2740
2	 0.7843	 0.3630
3	 0.5550	 0.1600
6	 0.4837	 0.2490
A	 0.4906	 0.2160
B	 0.5579	 0.2520
C	 0.7320	 0.3730
D	 0.4265	 0.3090
E	 0.5834	 0.2080
F	 0.7454	 0.3850
G	 0.6266	 0.2970
H	 0.3862	 0.1750
K	 0.2664	 0.2550
L	 0.8257	 0.4420
M	 0.6175	 0.2650
N	 0.7829	 0.4010
O	 0.6584	 0.3360
P	 0.5675	 0.2640
Q	 0.6910	 0.3180
R	 0.0000	 0.1510
S	 0.5212	 0.2810
T	 0.3469	 0.2810
U	 0.0000	 0.1600
V	 0.0399	 0.0870
W	 0.0042	 0.1490
X	 0.0987	 0.2120
Y	 0.7308	 0.3790
Z	 0.0000	 0.1140
a	 0.1533	 0.0820
b	 0.1627	 0.1630
c	 0.0000	 0.0820
d	 0.0040	 0.1560
e	 0.7735	 0.3970
f	 0.7742	 0.3980



Continued on next page...

Continued from previous page...

Chain	Atom inclusion	Q-score
g	 0.0000	 0.0670
h	 0.6863	 0.3740
i	 0.6875	 0.3140
j	 0.8278	 0.4290
k	 0.0000	 0.1790
m	 0.1130	 0.1280
n	 0.0818	 0.1570
o	 0.3326	 0.2010
p	 0.0000	 0.0760
r	 0.1447	 0.1580
t	 0.1373	 0.1360
u	 0.3462	 0.2140
v	 0.6184	 0.3110
y	 0.1400	 0.1250