



Full wwPDB X-ray Structure Validation Report ⓘ

Dec 14, 2022 – 08:04 PM EST

PDB ID : 8FBD
Title : Crystal structure of OrfX1-OrfX3 complex from Clostridium botulinum E1
Authors : Liu, S.; Gao, L.
Deposited on : 2022-11-29
Resolution : 2.05 Å(reported)

This is a Full wwPDB X-ray Structure Validation Report for a publicly released PDB entry.

We welcome your comments at validation@mail.wwpdb.org

A user guide is available at

<https://www.wwpdb.org/validation/2017/XrayValidationReportHelp>

with specific help available everywhere you see the ⓘ symbol.

The types of validation reports are described at

<http://www.wwpdb.org/validation/2017/FAQs#types>.

The following versions of software and data (see [references ⓘ](#)) were used in the production of this report:

MolProbity : 4.02b-467
Mogul : 1.8.5 (274361), CSD as541be (2020)
Xtriage (Phenix) : 1.13
EDS : 2.31.2
buster-report : 1.1.7 (2018)
Percentile statistics : 20191225.v01 (using entries in the PDB archive December 25th 2019)
Refmac : 5.8.0158
CCP4 : 7.0.044 (Gargrove)
Ideal geometry (proteins) : Engh & Huber (2001)
Ideal geometry (DNA, RNA) : Parkinson et al. (1996)
Validation Pipeline (wwPDB-VP) : 2.31.2

1 Overall quality at a glance

The following experimental techniques were used to determine the structure:

X-RAY DIFFRACTION

The reported resolution of this entry is 2.05 Å.

Percentile scores (ranging between 0-100) for global validation metrics of the entry are shown in the following graphic. The table shows the number of entries on which the scores are based.

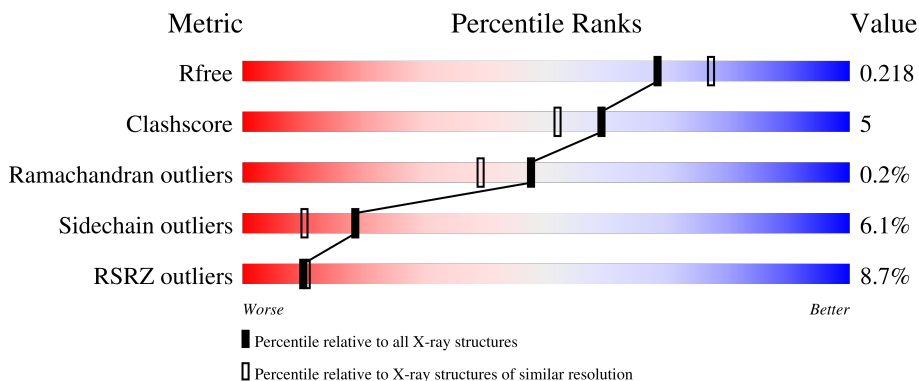

Metric	Whole archive (#Entries)	Similar resolution (#Entries, resolution range(Å))
R_{free}	130704	1692 (2.04-2.04)
Clashscore	141614	1773 (2.04-2.04)
Ramachandran outliers	138981	1752 (2.04-2.04)
Sidechain outliers	138945	1752 (2.04-2.04)
RSRZ outliers	127900	1672 (2.04-2.04)

The table below summarises the geometric issues observed across the polymeric chains and their fit to the electron density. The red, orange, yellow and green segments of the lower bar indicate the fraction of residues that contain outliers for ≥ 3 , 2, 1 and 0 types of geometric quality criteria respectively. A grey segment represents the fraction of residues that are not modelled. The numeric value for each fraction is indicated below the corresponding segment, with a dot representing fractions $\leq 5\%$. The upper red bar (where present) indicates the fraction of residues that have poor fit to the electron density. The numeric value is given above the bar.

Mol	Chain	Length	Quality of chain
1	A	144	
1	C	144	
2	B	487	
2	D	487	

2 Entry composition

There are 4 unique types of molecules in this entry. The entry contains 10536 atoms, of which 0 are hydrogens and 0 are deuteriums.

In the tables below, the ZeroOcc column contains the number of atoms modelled with zero occupancy, the AltConf column contains the number of residues with at least one atom in alternate conformation and the Trace column contains the number of residues modelled with at most 2 atoms.

- Molecule 1 is a protein called Neurotoxin complex component Orf-X1.

Mol	Chain	Residues	Atoms					ZeroOcc	AltConf	Trace
			Total	C	N	O	S			
1	A	141	1137	737	186	212	2	0	1	0
1	C	140	1111	719	180	210	2	0	0	0

- Molecule 2 is a protein called Neurotoxin complex component Orf-X3.

Mol	Chain	Residues	Atoms					ZeroOcc	AltConf	Trace
			Total	C	N	O	S			
2	B	487	3841	2474	618	740	9	0	6	0
2	D	487	3867	2489	620	749	9	0	6	0

There are 4 discrepancies between the modelled and reference sequences:

Chain	Residue	Modelled	Actual	Comment	Reference
B	244	ALA	LYS	engineered mutation	UNP A0A126JID3
B	245	ALA	LYS	engineered mutation	UNP A0A126JID3
D	244	ALA	LYS	engineered mutation	UNP A0A126JID3
D	245	ALA	LYS	engineered mutation	UNP A0A126JID3

- Molecule 3 is ACETATE ION (three-letter code: ACT) (formula: C₂H₃O₂) (labeled as "Ligand of Interest" by depositor).



Mol	Chain	Residues	Atoms	ZeroOcc	AltConf
3	B	1	Total C O 4 2 2	0	0
3	D	1	Total C O 4 2 2	0	0

- Molecule 4 is water.

Mol	Chain	Residues	Atoms	ZeroOcc	AltConf
4	A	58	Total O 58 58	0	0
4	B	229	Total O 229 229	0	0
4	C	22	Total O 22 22	0	0
4	D	263	Total O 263 263	0	0

3 Residue-property plots [i](#)

These plots are drawn for all protein, RNA, DNA and oligosaccharide chains in the entry. The first graphic for a chain summarises the proportions of the various outlier classes displayed in the second graphic. The second graphic shows the sequence view annotated by issues in geometry and electron density. Residues are color-coded according to the number of geometric quality criteria for which they contain at least one outlier: green = 0, yellow = 1, orange = 2 and red = 3 or more. A red dot above a residue indicates a poor fit to the electron density ($RSRZ > 2$). Stretches of 2 or more consecutive residues without any outlier are shown as a green connector. Residues present in the sample, but not in the model, are shown in grey.

- Molecule 1: Neurotoxin complex component Orf-X1

Chain A: 

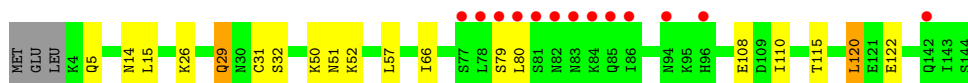

- Molecule 1: Neurotoxin complex component Orf-X1

Chain C: 

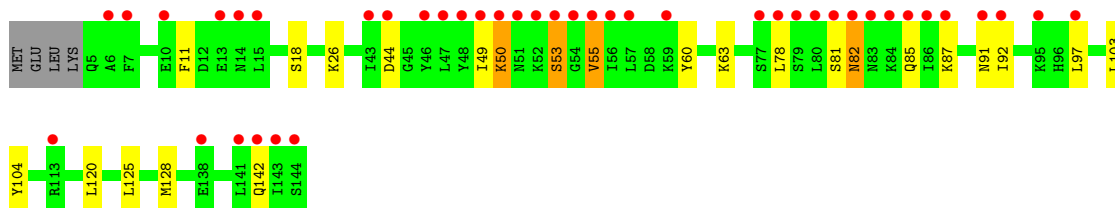

- Molecule 2: Neurotoxin complex component Orf-X3

Chain B: 

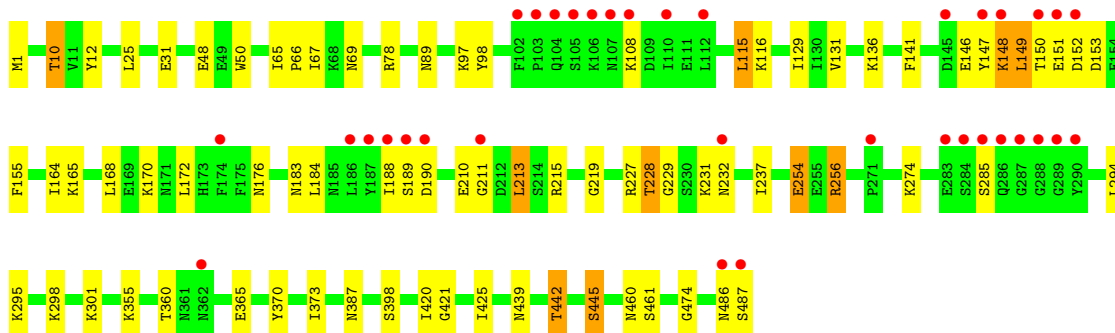

- Molecule 2: Neurotoxin complex component Orf-X3

Chain D: 

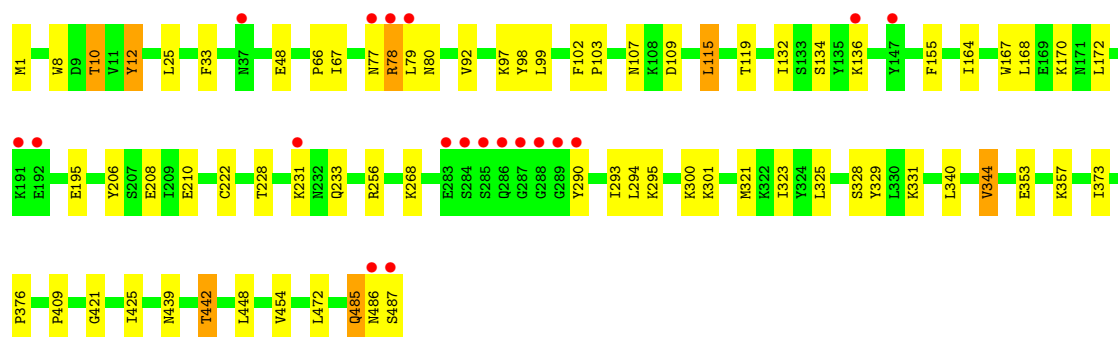

4 Data and refinement statistics

Property	Value	Source
Space group	P 21 21 21	Depositor
Cell constants a, b, c, α , β , γ	39.26Å 174.03Å 241.95Å 90.00° 90.00° 90.00°	Depositor
Resolution (Å)	49.67 – 2.05 49.67 – 2.05	Depositor EDS
% Data completeness (in resolution range)	98.9 (49.67-2.05) 98.9 (49.67-2.05)	Depositor EDS
R_{merge}	(Not available)	Depositor
R_{sym}	(Not available)	Depositor
$\langle I/\sigma(I) \rangle$ ¹	1.70 (at 2.05Å)	Xtrriage
Refinement program	PHENIX 1.15	Depositor
R, R_{free}	0.180 , 0.219 0.185 , 0.218	Depositor DCC
R_{free} test set	5220 reflections (4.99%)	wwPDB-VP
Wilson B-factor (Å ²)	34.1	Xtrriage
Anisotropy	0.058	Xtrriage
Bulk solvent k_{sol} (e/Å ³), B_{sol} (Å ²)	0.33 , 54.6	EDS
L-test for twinning ²	$\langle L \rangle = 0.45$, $\langle L^2 \rangle = 0.28$	Xtrriage
Estimated twinning fraction	No twinning to report.	Xtrriage
F_o, F_c correlation	0.95	EDS
Total number of atoms	10536	wwPDB-VP
Average B, all atoms (Å ²)	48.0	wwPDB-VP

Xtrriage's analysis on translational NCS is as follows: *The largest off-origin peak in the Patterson function is 3.03% of the height of the origin peak. No significant pseudotranslation is detected.*

¹Intensities estimated from amplitudes.

²Theoretical values of $\langle |L| \rangle$, $\langle L^2 \rangle$ for acentric reflections are 0.5, 0.333 respectively for untwinned datasets, and 0.375, 0.2 for perfectly twinned datasets.

5 Model quality [i](#)

5.1 Standard geometry [i](#)

Bond lengths and bond angles in the following residue types are not validated in this section: ACT

The Z score for a bond length (or angle) is the number of standard deviations the observed value is removed from the expected value. A bond length (or angle) with $|Z| > 5$ is considered an outlier worth inspection. RMSZ is the root-mean-square of all Z scores of the bond lengths (or angles).

Mol	Chain	Bond lengths		Bond angles	
		RMSZ	# Z >5	RMSZ	# Z >5
1	A	0.45	0/1153	0.56	0/1549
1	C	0.42	0/1126	0.54	1/1514 (0.1%)
2	B	0.49	0/3925	0.61	1/5330 (0.0%)
2	D	0.52	0/3951	0.57	0/5367
All	All	0.49	0/10155	0.58	2/13760 (0.0%)

Chiral center outliers are detected by calculating the chiral volume of a chiral center and verifying if the center is modelled as a planar moiety or with the opposite hand. A planarity outlier is detected by checking planarity of atoms in a peptide group, atoms in a mainchain group or atoms of a sidechain that are expected to be planar.

Mol	Chain	#Chirality outliers	#Planarity outliers
2	B	0	1

There are no bond length outliers.

All (2) bond angle outliers are listed below:

Mol	Chain	Res	Type	Atoms	Z	Observed($^{\circ}$)	Ideal($^{\circ}$)
2	B	474	GLY	N-CA-C	-5.52	99.30	113.10
1	C	82	ASN	CB-CA-C	5.45	121.30	110.40

There are no chirality outliers.

All (1) planarity outliers are listed below:

Mol	Chain	Res	Type	Group
2	B	210	GLU	Peptide

5.2 Too-close contacts

In the following table, the Non-H and H(model) columns list the number of non-hydrogen atoms and hydrogen atoms in the chain respectively. The H(added) column lists the number of hydrogen atoms added and optimized by MolProbity. The Clashes column lists the number of clashes within the asymmetric unit, whereas Symm-Clashes lists symmetry-related clashes.

Mol	Chain	Non-H	H(model)	H(added)	Clashes	Symm-Clashes
1	A	1137	0	1154	15	0
1	C	1111	0	1121	10	0
2	B	3841	0	3784	39	0
2	D	3867	0	3817	38	0
3	B	4	0	3	1	0
3	D	4	0	3	1	0
4	A	58	0	0	0	0
4	B	229	0	0	4	0
4	C	22	0	0	1	0
4	D	263	0	0	5	0
All	All	10536	0	9882	94	0

The all-atom clashscore is defined as the number of clashes found per 1000 atoms (including hydrogen atoms). The all-atom clashscore for this structure is 5.

All (94) close contacts within the same asymmetric unit are listed below, sorted by their clash magnitude.

Atom-1	Atom-2	Interatomic distance (Å)	Clash overlap (Å)
2:B:188:ILE:HD12	2:B:188:ILE:O	1.85	0.75
2:B:301:LYS:HZ2	3:B:501:ACT:C	2.03	0.71
2:B:129:ILE:HD11	2:B:172:LEU:HD22	1.73	0.70
2:B:486:ASN:O	2:B:487:SER:OG	2.11	0.67
2:D:376:PRO:HG3	2:D:409:PRO:HG3	1.79	0.62
2:D:329:TYR:HE1	2:D:373:ILE:HG13	1.64	0.61
1:A:29:GLN:OE1	1:A:32:SER:N	2.25	0.60
2:B:48:GLU:HB2	2:B:66:PRO:HG2	1.84	0.59
2:D:48:GLU:HB2	2:D:66:PRO:HG2	1.84	0.59
2:B:460:ASN:O	2:B:461:SER:HB2	2.01	0.58
2:D:119:THR:HB	2:D:172:LEU:HD22	1.86	0.58
2:B:370:TYR:HB3	2:B:420:ILE:HD11	1.86	0.56
2:B:89:ASN:HB3	2:B:136:LYS:HE2	1.88	0.55
2:B:67:ILE:HD13	2:B:164:ILE:HD13	1.89	0.55
1:C:87:LYS:NZ	1:C:142:GLN:HG3	2.21	0.55
1:C:11:PHE:HB3	1:C:18:SER:HB3	1.90	0.54
2:D:98:TYR:CZ	2:D:115:LEU:HG	2.43	0.54

Continued on next page...

Continued from previous page...

Atom-1	Atom-2	Interatomic distance (Å)	Clash overlap (Å)
2:B:421:GLY:O	2:B:425:ILE:HG12	2.08	0.54
1:C:49:ILE:HD11	1:C:60:TYR:HE2	1.73	0.54
2:D:67:ILE:HD13	2:D:164:ILE:HD13	1.89	0.53
2:D:268:LYS:NZ	4:D:610:HOH:O	2.35	0.53
2:D:485:GLN:O	2:D:486:ASN:HB2	2.09	0.53
2:D:78:ARG:HH11	2:D:78:ARG:CA	2.21	0.52
1:C:53:SER:HB3	1:C:55:VAL:HG23	1.93	0.51
1:C:81:SER:O	1:C:82:ASN:C	2.49	0.51
2:D:256:ARG:NH1	4:D:604:HOH:O	2.28	0.51
2:B:355:LYS:NZ	4:B:611:HOH:O	2.43	0.51
2:B:50:TRP:NE1	2:B:65:ILE:HG23	2.26	0.51
2:D:340:LEU:HB3	2:D:344[A]:VAL:HG13	1.93	0.51
1:A:66:ILE:HG22	1:A:110:ILE:HD12	1.91	0.51
2:D:293:ILE:HD11	2:D:295:LYS:HD2	1.92	0.50
2:D:321:MET:HE1	2:D:323:ILE:HD11	1.93	0.50
2:B:141:PHE:CE1	2:B:153:ASP:HB3	2.46	0.50
1:C:11:PHE:CD2	1:C:128:MET:HG3	2.47	0.50
2:D:77:ASN:ND2	2:D:78:ARG:NH1	2.60	0.50
2:B:254:GLU:OE1	4:B:601:HOH:O	2.20	0.49
2:D:439:ASN:HB3	2:D:442:THR:HB	1.93	0.49
2:D:97:LYS:HD3	2:D:99:LEU:HD21	1.94	0.49
1:C:50:LYS:HB3	1:C:55:VAL:O	2.13	0.49
2:D:78:ARG:NH1	2:D:78:ARG:HA	2.28	0.49
2:D:328:SER:HA	2:D:472:LEU:O	2.13	0.49
1:A:14:ASN:HB3	2:B:150:THR:CG2	2.42	0.49
2:B:211:GLY:H	2:B:215:ARG:NH1	2.10	0.48
2:B:227:ARG:NH1	2:B:256:ARG:HD2	2.28	0.48
2:B:98:TYR:CZ	2:B:115:LEU:HG	2.49	0.48
2:D:12:TYR:CE2	2:D:454:VAL:HG23	2.49	0.48
2:D:421:GLY:O	2:D:425:ILE:HG12	2.13	0.48
1:A:115:THR:HB	1:A:122:GLU:HG2	1.97	0.47
2:D:357:LYS:NZ	4:D:619:HOH:O	2.44	0.47
2:D:331:LYS:HG2	2:D:353:GLU:HG2	1.97	0.47
2:D:10[A]:THR:HG22	2:D:222:CYS:HB2	1.96	0.47
1:A:52:LYS:HE3	2:B:148[B]:LYS:HA	1.97	0.47
2:D:325:LEU:HD12	2:D:472:LEU:HD13	1.96	0.47
2:B:189:SER:OG	2:B:190:ASP:N	2.47	0.46
2:B:365:GLU:HB3	2:B:445:SER:HB2	1.97	0.46
1:C:103:LEU:HD23	1:C:104:TYR:N	2.30	0.46
2:D:92:VAL:HA	2:D:132:ILE:HD12	1.97	0.46
2:D:107:ASN:OD1	2:D:109:ASP:HB2	2.15	0.46

Continued on next page...

Continued from previous page...

Atom-1	Atom-2	Interatomic distance (Å)	Clash overlap (Å)
2:D:206:TYR:CE1	2:D:208:GLU:HB3	2.51	0.46
2:D:97:LYS:NZ	4:D:625:HOH:O	2.48	0.46
2:D:78:ARG:HH11	2:D:78:ARG:HA	1.80	0.45
2:B:10:THR:HG21	4:B:645:HOH:O	2.16	0.44
2:B:355:LYS:HB2	2:B:373:ILE:HD11	1.99	0.44
1:A:52:LYS:HE3	2:B:148[A]:LYS:HA	1.99	0.44
2:D:1:MET:HE2	4:D:861:HOH:O	2.17	0.44
2:D:78:ARG:HH11	2:D:78:ARG:N	2.16	0.44
2:B:228:THR:HG22	2:B:229:GLY:H	1.83	0.44
1:A:29:GLN:OE1	1:A:31:CYS:N	2.51	0.43
1:A:15:LEU:HG	2:B:150:THR:HG22	2.00	0.43
2:B:439:ASN:HB3	2:B:442:THR:HG22	2.00	0.43
1:A:51:ASN:HB3	1:A:57:LEU:HD11	2.00	0.43
2:D:294:LEU:HB3	2:D:323:ILE:HB	2.00	0.42
1:A:15:LEU:HD12	2:B:151:GLU:HB2	2.01	0.42
1:A:120:LEU:HD23	2:B:155:PHE:HZ	1.84	0.42
1:C:26:LYS:HE3	1:C:26:LYS:HB2	1.73	0.42
1:A:79:SER:HA	1:A:80:LEU:HA	1.72	0.42
2:B:25:LEU:HD12	2:B:25:LEU:HA	1.86	0.42
1:C:63:LYS:NZ	4:C:203:HOH:O	2.37	0.42
2:D:102:PHE:HA	2:D:103:PRO:C	2.40	0.42
2:B:131:VAL:HG23	2:B:165:LYS:HD2	2.02	0.42
2:D:33:PHE:HB2	2:D:167:TRP:CE2	2.55	0.42
2:D:79:LEU:HD22	2:D:155:PHE:HE2	1.85	0.41
2:B:184:LEU:HD23	2:B:184:LEU:HA	1.90	0.41
1:A:108:GLU:CD	1:A:108:GLU:H	2.23	0.41
2:D:301:LYS:NZ	3:D:501:ACT:OXT	2.52	0.41
1:A:120:LEU:CD2	2:B:155:PHE:HZ	2.34	0.40
2:D:170:LYS:HA	2:D:170:LYS:HD3	1.81	0.40
2:B:219:GLY:HA3	2:B:237:ILE:HD11	2.03	0.40
2:B:295:LYS:HZ1	2:B:298:LYS:HE3	1.86	0.40
2:D:8:TRP:CZ2	2:D:233:GLN:HB3	2.57	0.40
2:B:97:LYS:HD3	4:B:697:HOH:O	2.20	0.40
1:A:14:ASN:HB3	2:B:150:THR:HG21	2.04	0.40
2:B:116:LYS:NZ	2:B:176[A]:ASN:HB2	2.37	0.40
2:B:211:GLY:O	2:B:215:ARG:HD3	2.22	0.40

There are no symmetry-related clashes.

5.3 Torsion angles [i](#)

5.3.1 Protein backbone [i](#)

In the following table, the Percentiles column shows the percent Ramachandran outliers of the chain as a percentile score with respect to all X-ray entries followed by that with respect to entries of similar resolution.

The Analysed column shows the number of residues for which the backbone conformation was analysed, and the total number of residues.

Mol	Chain	Analysed	Favoured	Allowed	Outliers	Percentiles	
1	A	140/144 (97%)	133 (95%)	7 (5%)	0	100	100
1	C	138/144 (96%)	133 (96%)	5 (4%)	0	100	100
2	B	491/487 (101%)	470 (96%)	19 (4%)	2 (0%)	34	24
2	D	491/487 (101%)	474 (96%)	17 (4%)	0	100	100
All	All	1260/1262 (100%)	1210 (96%)	48 (4%)	2 (0%)	47	39

All (2) Ramachandran outliers are listed below:

Mol	Chain	Res	Type
2	B	213	LEU
2	B	149	LEU

5.3.2 Protein sidechains [i](#)

In the following table, the Percentiles column shows the percent sidechain outliers of the chain as a percentile score with respect to all X-ray entries followed by that with respect to entries of similar resolution.

The Analysed column shows the number of residues for which the sidechain conformation was analysed, and the total number of residues.

Mol	Chain	Analysed	Rotameric	Outliers	Percentiles	
1	A	126/137 (92%)	121 (96%)	5 (4%)	31	24
1	C	123/137 (90%)	112 (91%)	11 (9%)	9	4
2	B	421/428 (98%)	389 (92%)	32 (8%)	13	6
2	D	427/428 (100%)	404 (95%)	23 (5%)	22	13
All	All	1097/1130 (97%)	1026 (94%)	71 (6%)	18	9

All (71) residues with a non-rotameric sidechain are listed below:

Mol	Chain	Res	Type
1	A	5	GLN
1	A	26	LYS
1	A	29	GLN
1	A	50	LYS
1	A	120	LEU
2	B	1	MET
2	B	10	THR
2	B	12	TYR
2	B	31[A]	GLU
2	B	31[B]	GLU
2	B	69	ASN
2	B	78	ARG
2	B	108	LYS
2	B	115	LEU
2	B	146	GLU
2	B	147	TYR
2	B	148[A]	LYS
2	B	148[B]	LYS
2	B	149	LEU
2	B	152	ASP
2	B	168	LEU
2	B	170	LYS
2	B	183	ASN
2	B	213	LEU
2	B	228	THR
2	B	231	LYS
2	B	232	ASN
2	B	254	GLU
2	B	256	ARG
2	B	274	LYS
2	B	285	SER
2	B	294	LEU
2	B	360	THR
2	B	387	ASN
2	B	398	SER
2	B	442	THR
2	B	445	SER
1	C	44	ASP
1	C	50	LYS
1	C	53	SER
1	C	55	VAL
1	C	78	LEU
1	C	85	GLN

Continued on next page...

Continued from previous page...

Mol	Chain	Res	Type
1	C	91	ASN
1	C	92	ILE
1	C	97	LEU
1	C	120	LEU
1	C	125	LEU
2	D	10[A]	THR
2	D	10[B]	THR
2	D	12	TYR
2	D	25	LEU
2	D	78	ARG
2	D	80	ASN
2	D	115	LEU
2	D	134	SER
2	D	136	LYS
2	D	168	LEU
2	D	195	GLU
2	D	210	GLU
2	D	228	THR
2	D	231	LYS
2	D	290	TYR
2	D	300	LYS
2	D	344[A]	VAL
2	D	344[B]	VAL
2	D	442	THR
2	D	448[A]	LEU
2	D	448[B]	LEU
2	D	485	GLN
2	D	487	SER

Sometimes sidechains can be flipped to improve hydrogen bonding and reduce clashes. All (1) such sidechains are listed below:

Mol	Chain	Res	Type
1	A	14	ASN

5.3.3 RNA

There are no RNA molecules in this entry.

5.4 Non-standard residues in protein, DNA, RNA chains [i](#)

There are no non-standard protein/DNA/RNA residues in this entry.

5.5 Carbohydrates [i](#)

There are no monosaccharides in this entry.

5.6 Ligand geometry [i](#)

2 ligands are modelled in this entry.

In the following table, the Counts columns list the number of bonds (or angles) for which Mogul statistics could be retrieved, the number of bonds (or angles) that are observed in the model and the number of bonds (or angles) that are defined in the Chemical Component Dictionary. The Link column lists molecule types, if any, to which the group is linked. The Z score for a bond length (or angle) is the number of standard deviations the observed value is removed from the expected value. A bond length (or angle) with $|Z| > 2$ is considered an outlier worth inspection. RMSZ is the root-mean-square of all Z scores of the bond lengths (or angles).

Mol	Type	Chain	Res	Link	Bond lengths			Bond angles		
					Counts	RMSZ	$\# Z > 2$	Counts	RMSZ	$\# Z > 2$
3	ACT	D	501	-	3,3,3	0.79	0	3,3,3	1.39	0
3	ACT	B	501	-	3,3,3	1.14	0	3,3,3	0.74	0

There are no bond length outliers.

There are no bond angle outliers.

There are no chirality outliers.

There are no torsion outliers.

There are no ring outliers.

2 monomers are involved in 2 short contacts:

Mol	Chain	Res	Type	Clashes	Symm-Clashes
3	D	501	ACT	1	0
3	B	501	ACT	1	0

The following is a two-dimensional graphical depiction of Mogul quality analysis of bond lengths, bond angles, torsion angles, and ring geometry for all instances of the Ligand of Interest. In addition, ligands with molecular weight > 250 and outliers as shown on the validation Tables will also be included. For torsion angles, if less than 5% of the Mogul distribution of torsion angles is within 10 degrees of the torsion angle in question, then that torsion angle is considered an outlier. Any bond that is central to one or more torsion angles identified as an outlier by Mogul will be

highlighted in the graph. For rings, the root-mean-square deviation (RMSD) between the ring in question and similar rings identified by Mogul is calculated over all ring torsion angles. If the average RMSD is greater than 60 degrees and the minimal RMSD between the ring in question and any Mogul-identified rings is also greater than 60 degrees, then that ring is considered an outlier. The outliers are highlighted in purple. The color gray indicates Mogul did not find sufficient equivalents in the CSD to analyse the geometry.

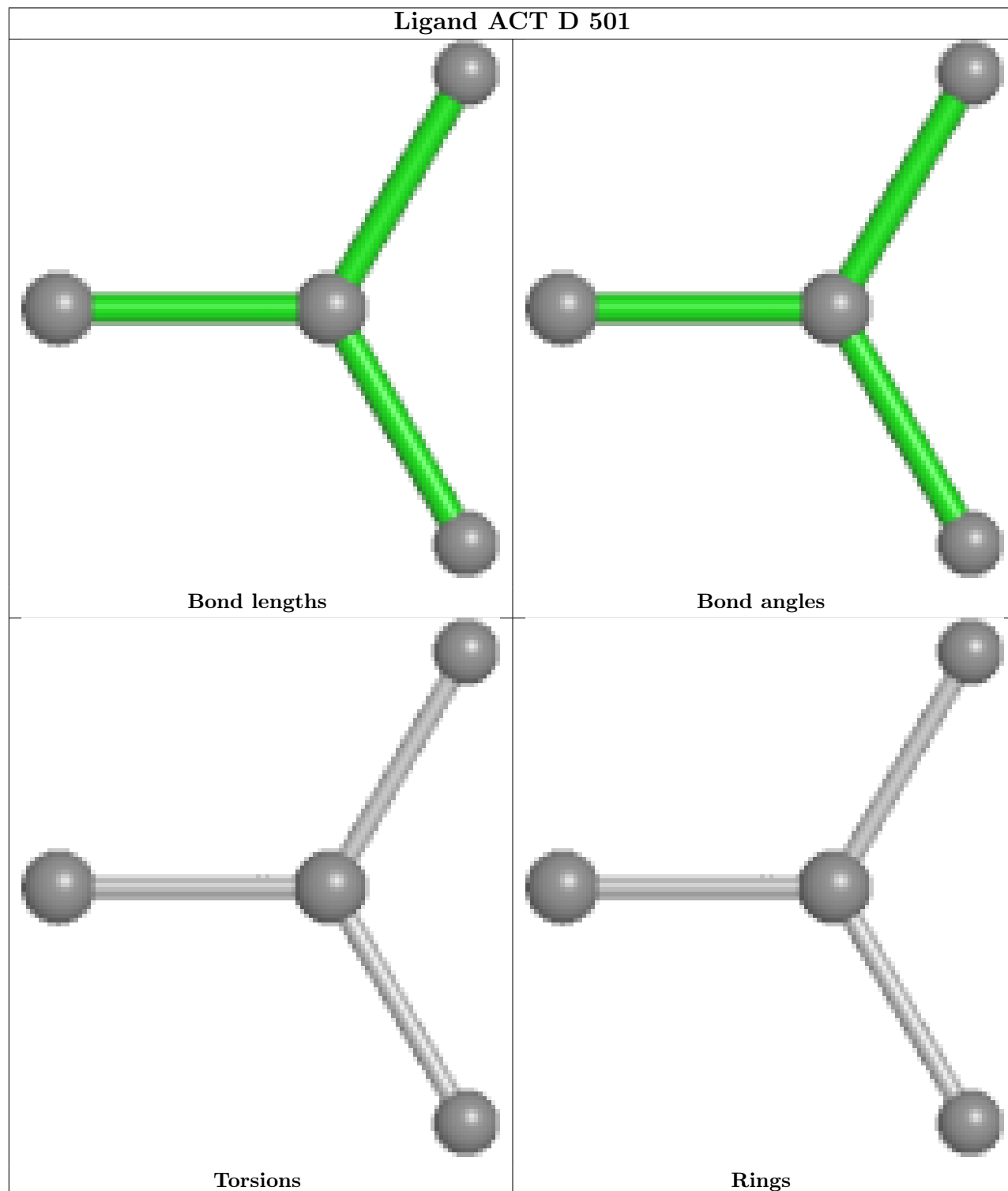

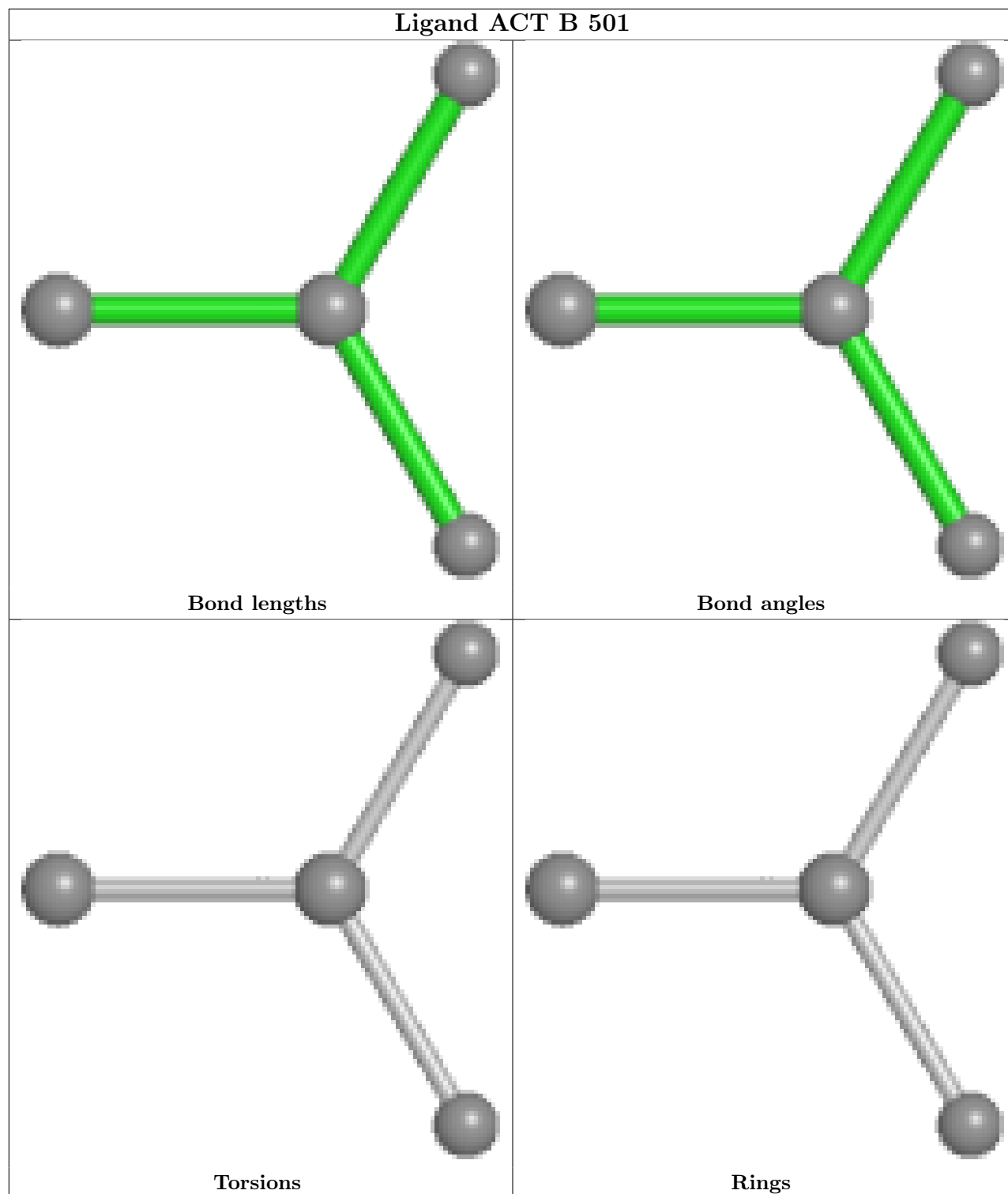

5.7 Other polymers [\(i\)](#)

There are no such residues in this entry.

5.8 Polymer linkage issues

There are no chain breaks in this entry.

6 Fit of model and data [i](#)

6.1 Protein, DNA and RNA chains [i](#)

In the following table, the column labelled ‘#RSRZ > 2’ contains the number (and percentage) of RSRZ outliers, followed by percent RSRZ outliers for the chain as percentile scores relative to all X-ray entries and entries of similar resolution. The OWAB column contains the minimum, median, 95th percentile and maximum values of the occupancy-weighted average B-factor per residue. The column labelled ‘Q < 0.9’ lists the number of (and percentage) of residues with an average occupancy less than 0.9.

Mol	Chain	Analysed	<RSRZ>	#RSRZ>2	OWAB(Å ²)	Q<0.9
1	A	141/144 (97%)	0.45	13 (9%) 9 9	28, 41, 81, 97	10 (7%)
1	C	140/144 (97%)	1.43	42 (30%) 0 0	35, 72, 108, 121	15 (10%)
2	B	487/487 (100%)	0.34	35 (7%) 15 17	21, 45, 77, 100	24 (4%)
2	D	487/487 (100%)	0.33	19 (3%) 39 42	21, 38, 73, 92	9 (1%)
All	All	1255/1262 (99%)	0.47	109 (8%) 10 10	21, 44, 88, 121	58 (4%)

All (109) RSRZ outliers are listed below:

Mol	Chain	Res	Type	RSRZ
2	D	285	SER	21.0
1	A	81	SER	11.6
2	B	284	SER	11.5
2	B	287	GLY	10.3
2	B	286	GLN	10.3
2	D	287	GLY	9.9
2	D	286	GLN	9.7
2	D	487	SER	9.6
2	D	288	GLY	9.5
1	C	81	SER	9.0
2	D	290	TYR	8.8
1	C	82	ASN	8.7
1	A	82	ASN	8.2
1	C	55	VAL	8.0
2	D	284	SER	7.9
2	B	285	SER	7.5
2	B	290	TYR	7.3
2	B	151	GLU	7.2
1	C	85	GLN	7.0
2	D	289	GLY	7.0
1	A	83	ASN	6.7

Continued on next page...

Continued from previous page...

Mol	Chain	Res	Type	RSRZ
1	C	84	LYS	6.5
1	C	80	LEU	6.4
2	B	487	SER	6.3
1	C	86	ILE	6.2
2	B	150	THR	5.9
1	C	56	ILE	5.9
1	C	14	ASN	5.7
1	C	79	SER	5.4
1	C	83	ASN	5.3
2	B	288	GLY	5.1
2	D	77	ASN	5.0
1	C	53	SER	4.8
2	B	189	SER	4.8
1	C	92	ILE	4.8
1	A	79	SER	4.6
1	A	84	LYS	4.5
1	A	80	LEU	4.4
2	B	187	TYR	4.4
1	C	78	LEU	4.3
1	C	142	GLN	4.1
1	C	51	ASN	4.0
1	C	50	LYS	4.0
2	B	186	LEU	4.0
2	B	147	TYR	4.0
2	B	190	ASP	3.9
1	C	48	TYR	3.8
2	B	105	SER	3.7
1	C	143	ILE	3.7
2	B	102	PHE	3.6
2	B	108	LYS	3.6
1	C	52	LYS	3.6
1	C	54	GLY	3.6
2	D	283	GLU	3.5
1	C	141	LEU	3.4
1	C	7	PHE	3.3
2	B	107	ASN	3.3
1	A	85	GLN	3.3
1	C	59	LYS	3.3
2	B	106	LYS	3.2
2	D	191	LYS	3.2
1	C	15	LEU	3.2
1	A	78	LEU	3.2

Continued on next page...

Continued from previous page...

Mol	Chain	Res	Type	RSRZ
2	D	486	ASN	3.1
2	D	78	ARG	3.1
2	B	271	PRO	3.0
2	B	289	GLY	3.0
1	C	77	SER	2.9
2	B	211	GLY	2.9
2	D	79	LEU	2.9
1	C	97	LEU	2.8
1	C	87	LYS	2.8
1	C	144	SER	2.8
2	D	147	TYR	2.7
2	B	174	PHE	2.7
1	C	95	LYS	2.7
2	B	112	LEU	2.6
2	B	103	PRO	2.6
1	A	77	SER	2.6
2	B	145	ASP	2.5
1	A	86	ILE	2.5
1	C	57	LEU	2.5
1	C	44	ASP	2.5
2	B	486	ASN	2.4
2	B	188	ILE	2.4
1	C	13	GLU	2.4
1	C	43	ILE	2.4
2	B	283	GLU	2.4
2	B	148[A]	LYS	2.3
1	C	49	ILE	2.3
2	D	192	GLU	2.3
2	B	232	ASN	2.3
2	B	152	ASP	2.3
1	C	6	ALA	2.2
2	B	362[A]	ASN	2.2
1	C	47	LEU	2.2
1	A	96	HIS	2.2
1	C	113	ARG	2.2
1	A	94	ASN	2.2
1	C	138	GLU	2.2
1	C	10	GLU	2.2
1	C	46	TYR	2.2
2	D	231	LYS	2.2
2	D	37	ASN	2.2
2	D	136	LYS	2.1

Continued on next page...

Continued from previous page...

Mol	Chain	Res	Type	RSRZ
1	A	142	GLN	2.1
1	C	91	ASN	2.1
2	B	104	GLN	2.1
2	B	110	ILE	2.0

6.2 Non-standard residues in protein, DNA, RNA chains [i](#)

There are no non-standard protein/DNA/RNA residues in this entry.

6.3 Carbohydrates [i](#)

There are no monosaccharides in this entry.

6.4 Ligands [i](#)

In the following table, the Atoms column lists the number of modelled atoms in the group and the number defined in the chemical component dictionary. The B-factors column lists the minimum, median, 95th percentile and maximum values of B factors of atoms in the group. The column labelled 'Q< 0.9' lists the number of atoms with occupancy less than 0.9.

Mol	Type	Chain	Res	Atoms	RSCC	RSR	B-factors(Å ²)	Q<0.9
3	ACT	B	501	4/4	0.86	0.18	39,40,41,42	4
3	ACT	D	501	4/4	0.86	0.14	46,50,51,52	4

The following is a graphical depiction of the model fit to experimental electron density of all instances of the Ligand of Interest. In addition, ligands with molecular weight > 250 and outliers as shown on the geometry validation Tables will also be included. Each fit is shown from different orientation to approximate a three-dimensional view.

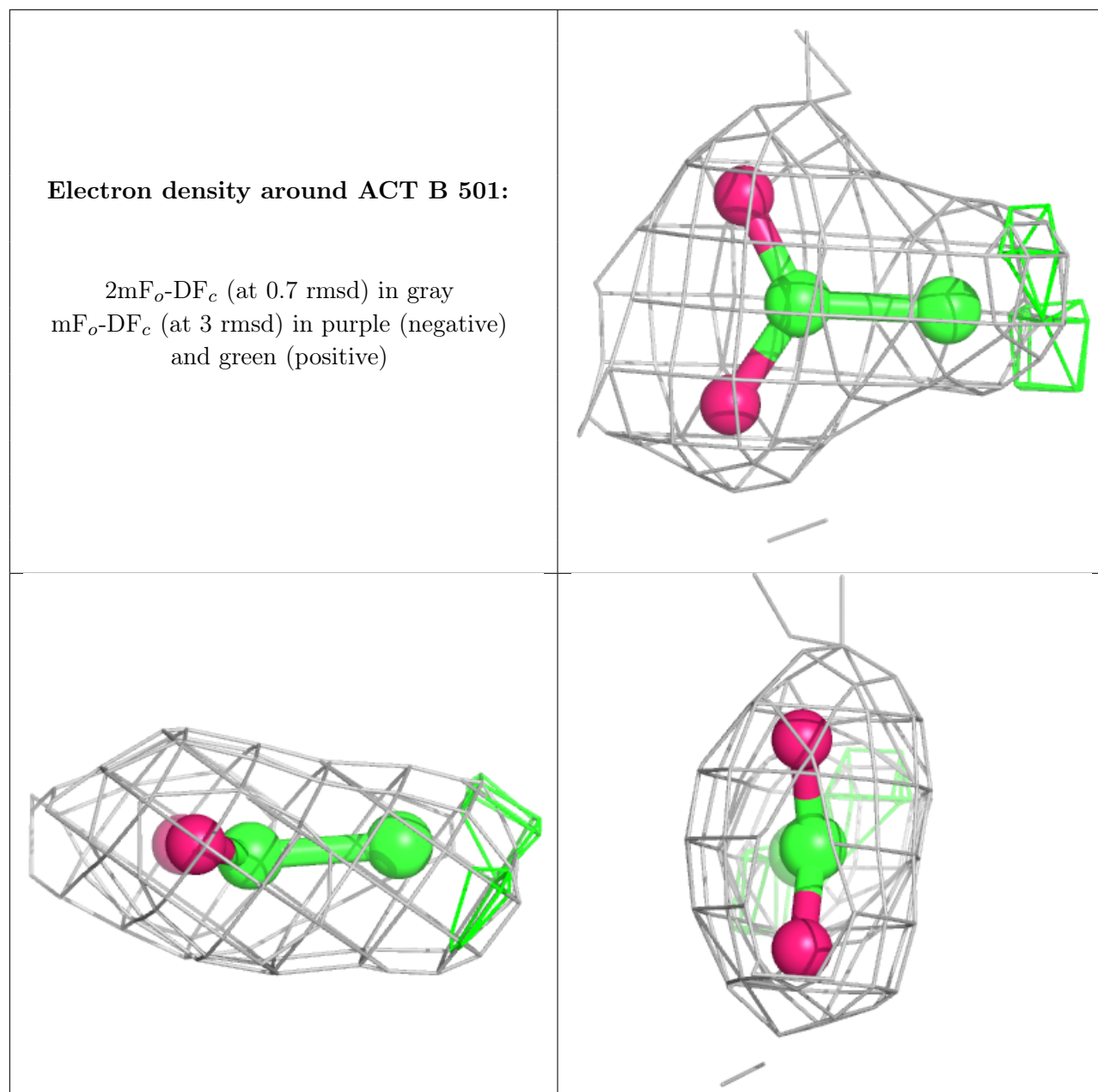

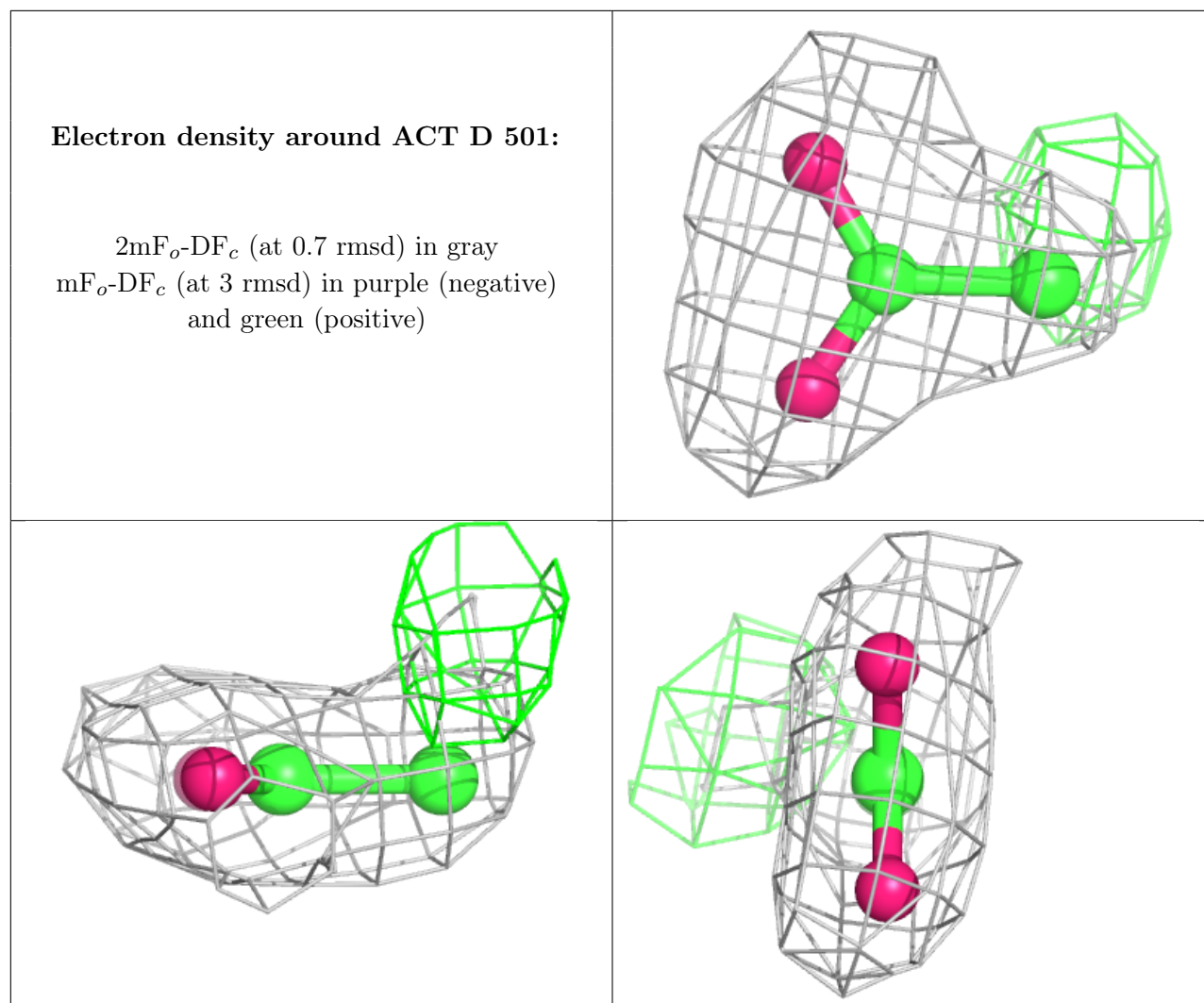

6.5 Other polymers [i](#)

There are no such residues in this entry.