



wwPDB X-ray Structure Validation Summary Report ⓘ

Aug 26, 2023 – 09:34 PM EDT

PDB ID : 3FCS
Title : Structure of complete ectodomain of integrin α IIBb3
Authors : Zhu, J.; Luo, B.-H.; Xiao, T.; Zhang, C.; Nishida, N.; Springer, T.A.
Deposited on : 2008-11-22
Resolution : 2.55 Å(reported)

This is a wwPDB X-ray Structure Validation Summary Report for a publicly released PDB entry.

We welcome your comments at validation@mail.wwpdb.org

A user guide is available at

<https://www.wwpdb.org/validation/2017/XrayValidationReportHelp>

with specific help available everywhere you see the ⓘ symbol.

The types of validation reports are described at

<http://www.wwpdb.org/validation/2017/FAQs#types>.

The following versions of software and data (see [references ⓘ](#)) were used in the production of this report:

MolProbity : 4.02b-467
Mogul : 1.8.5 (274361), CSD as541be (2020)
Xtrriage (Phenix) : 1.13
EDS : 2.35
Percentile statistics : 20191225.v01 (using entries in the PDB archive December 25th 2019)
Refmac : 5.8.0158
CCP4 : 7.0.044 (Gargrove)
Ideal geometry (proteins) : Engh & Huber (2001)
Ideal geometry (DNA, RNA) : Parkinson et al. (1996)
Validation Pipeline (wwPDB-VP) : 2.35

1 Overall quality at a glance

The following experimental techniques were used to determine the structure:

X-RAY DIFFRACTION

The reported resolution of this entry is 2.55 Å.

Percentile scores (ranging between 0-100) for global validation metrics of the entry are shown in the following graphic. The table shows the number of entries on which the scores are based.

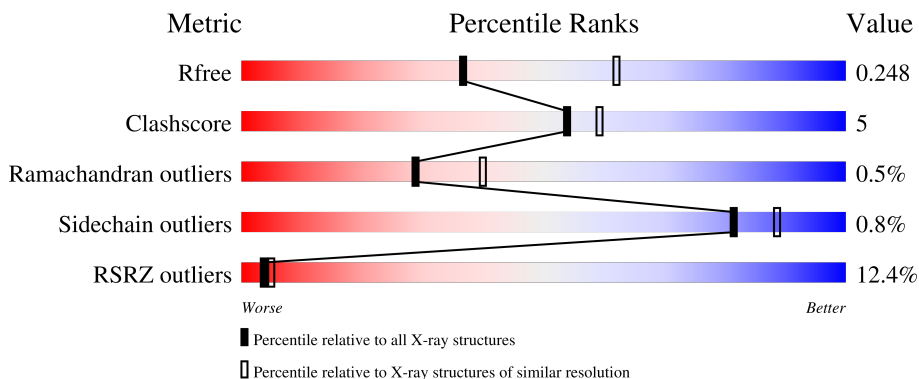





Metric	Whole archive (#Entries)	Similar resolution (#Entries, resolution range(Å))
R_{free}	130704	1284 (2.56-2.52)
Clashscore	141614	1332 (2.56-2.52)
Ramachandran outliers	138981	1315 (2.56-2.52)
Sidechain outliers	138945	1315 (2.56-2.52)
RSRZ outliers	127900	1272 (2.56-2.52)

The table below summarises the geometric issues observed across the polymeric chains and their fit to the electron density. The red, orange, yellow and green segments of the lower bar indicate the fraction of residues that contain outliers for ≥ 3 , 2, 1 and 0 types of geometric quality criteria respectively. A grey segment represents the fraction of residues that are not modelled. The numeric value for each fraction is indicated below the corresponding segment, with a dot representing fractions $\leq 5\%$. The upper red bar (where present) indicates the fraction of residues that have poor fit to the electron density. The numeric value is given above the bar.

Mol	Chain	Length	Quality of chain
1	A	959	 6% 83% 12% 5%
1	C	959	 15% 82% 11% 6%
2	B	690	 19% 87% 12%
2	D	690	 8% 78% 9% 13%
3	E	2	 50% 50%

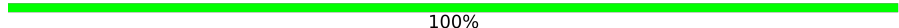
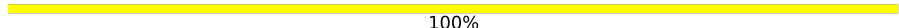
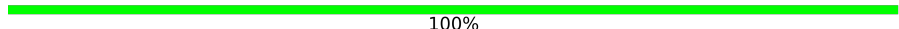
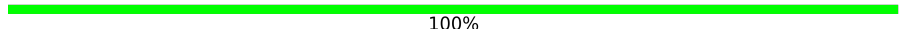
Continued on next page...

Continued from previous page...

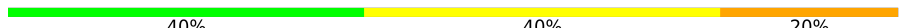
Mol	Chain	Length	Quality of chain
3	H	2	 100%
3	J	2	 100%
3	K	2	 100%
3	L	2	 100%
3	M	2	 50% 50%
3	N	2	 50% 50%
4	F	4	 50% 50%
5	G	3	 67% 33%
6	I	5	 40% 40% 20%

The following table lists non-polymeric compounds, carbohydrate monomers and non-standard residues in protein, DNA, RNA chains that are outliers for geometric or electron-density-fit criteria:

Mol	Type	Chain	Res	Chirality	Geometry	Clashes	Electron density
3	NAG	E	2	-	-	-	X
3	NAG	H	2	-	-	-	X
3	NAG	J	2	-	-	-	X
4	MAN	F	3	X	-	-	-
5	MAN	G	3	X	-	-	-
6	MAN	I	3	X	-	-	-
8	NAG	C	3570	X	-	-	-
8	NAG	D	3099	X	-	-	-

2 Entry composition i

There are 11 unique types of molecules in this entry. The entry contains 24961 atoms, of which 0 are hydrogens and 0 are deuteriums.

In the tables below, the ZeroOcc column contains the number of atoms modelled with zero occupancy, the AltConf column contains the number of residues with at least one atom in alternate conformation and the Trace column contains the number of residues modelled with at most 2 atoms.

- Molecule 1 is a protein called Integrin, alpha 2b.

Mol	Chain	Residues	Atoms					ZeroOcc	AltConf	Trace
			Total	C	N	O	S			
1	A	914	7033	4446	1231	1326	30	0	7	3
1	C	904	6953	4387	1224	1312	30	0	8	2

There are 2 discrepancies between the modelled and reference sequences:

Chain	Residue	Modelled	Actual	Comment	Reference
A	959	CYS	-	expression tag	UNP Q17R67
C	959	CYS	-	expression tag	UNP Q17R67

- Molecule 2 is a protein called Integrin beta-3.

Mol	Chain	Residues	Atoms					ZeroOcc	AltConf	Trace
			Total	C	N	O	S			
2	B	680	5220	3207	890	1052	71	0	1	0
2	D	603	4615	2839	790	923	63	0	3	0

There are 2 discrepancies between the modelled and reference sequences:

Chain	Residue	Modelled	Actual	Comment	Reference
B	688	CYS	PRO	engineered mutation	UNP P05106
D	688	CYS	PRO	engineered mutation	UNP P05106

- Molecule 3 is an oligosaccharide called 2-acetamido-2-deoxy-beta-D-glucopyranose-(1-4)-2-acetamido-2-deoxy-beta-D-glucopyranose.



Mol	Chain	Residues	Atoms				ZeroOcc	AltConf	Trace
3	E	2	Total	C	N	O	0	0	0
			28	16	2	10			
3	H	2	Total	C	N	O	0	0	0
			28	16	2	10			
3	J	2	Total	C	N	O	0	0	0
			28	16	2	10			
3	K	2	Total	C	N	O	0	0	0
			28	16	2	10			
3	L	2	Total	C	N	O	0	0	0
			28	16	2	10			
3	M	2	Total	C	N	O	0	0	0
			28	16	2	10			
3	N	2	Total	C	N	O	0	0	0
			28	16	2	10			

- Molecule 4 is an oligosaccharide called alpha-D-mannopyranose-(1-3)-alpha-D-mannopyranose-(1-4)-2-acetamido-2-deoxy-beta-D-glucopyranose-(1-4)-2-acetamido-2-deoxy-beta-D-glucopyranose.



Mol	Chain	Residues	Atoms				ZeroOcc	AltConf	Trace
4	F	4	Total	C	N	O	0	0	0
			50	28	2	20			

- Molecule 5 is an oligosaccharide called alpha-D-mannopyranose-(1-4)-2-acetamido-2-deoxy-beta-D-glucopyranose-(1-4)-2-acetamido-2-deoxy-beta-D-glucopyranose.

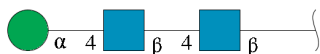

Mol	Chain	Residues	Atoms				ZeroOcc	AltConf	Trace
5	G	3	Total	C	N	O	0	0	0
			39	22	2	15			

- Molecule 6 is an oligosaccharide called alpha-D-mannopyranose-(1-2)-alpha-D-mannopyranose-(1-3)-alpha-D-mannopyranose-(1-4)-2-acetamido-2-deoxy-beta-D-glucopyranose-(1-4)-2-acetamido-2-deoxy-beta-D-glucopyranose.

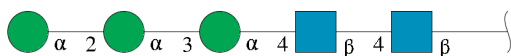

Mol	Chain	Residues	Atoms				ZeroOcc	AltConf	Trace
			Total	C	N	O			
6	I	5	61	34	2	25	0	0	0

- Molecule 7 is CALCIUM ION (three-letter code: CA) (formula: Ca).

Mol	Chain	Residues	Atoms		ZeroOcc	AltConf
			Total	Ca		
7	A	5	5	5	0	0
7	B	2	2	2	0	0
7	C	5	5	5	0	0
7	D	2	2	2	0	0

- Molecule 8 is 2-acetamido-2-deoxy-beta-D-glucopyranose (three-letter code: NAG) (formula: C₈H₁₅NO₆).

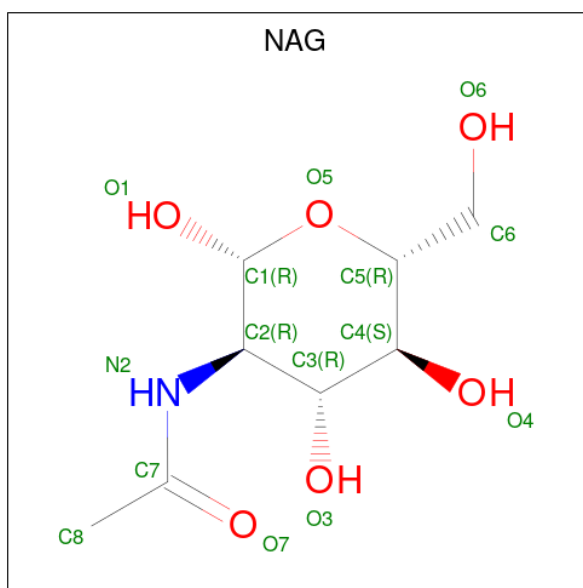

Mol	Chain	Residues	Atoms				ZeroOcc	AltConf
			Total	C	N	O		
8	A	1	14	8	1	5	0	0
8	A	1	14	8	1	5	0	0

Continued on next page...

Continued from previous page...

Mol	Chain	Residues	Atoms				ZeroOcc	AltConf
8	C	1	Total	C	N	O	0	0
			14	8	1	5		
8	C	1	Total	C	N	O	0	0
			14	8	1	5		
8	D	1	Total	C	N	O	0	0
			14	8	1	5		

- Molecule 9 is IMIDAZOLE (three-letter code: IMD) (formula: $C_3H_5N_2$).

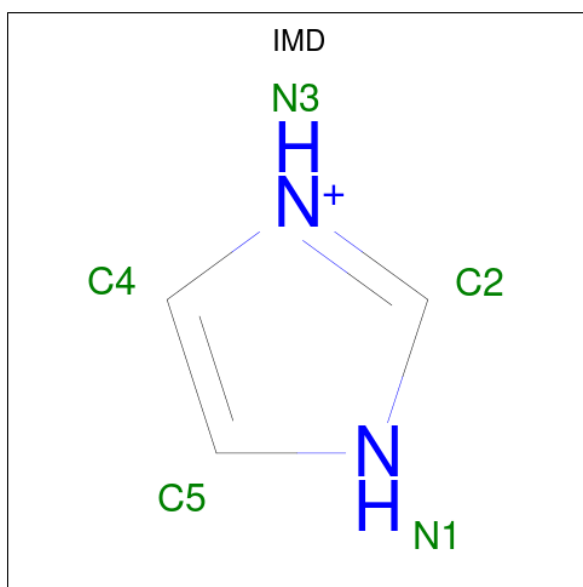

Mol	Chain	Residues	Atoms			ZeroOcc	AltConf
9	A	1	Total	C	N	0	0
			5	3	2		
9	C	1	Total	C	N	0	0
			5	3	2		
9	C	1	Total	C	N	0	0
			5	3	2		
9	C	1	Total	C	N	0	0
			5	3	2		
9	C	1	Total	C	N	0	0
			5	3	2		

- Molecule 10 is MAGNESIUM ION (three-letter code: MG) (formula: Mg).

Mol	Chain	Residues	Atoms	ZeroOcc	AltConf
10	B	1	Total Mg 1 1	0	0
10	D	1	Total Mg 1 1	0	0

- Molecule 11 is water.

Mol	Chain	Residues	Atoms	ZeroOcc	AltConf
11	A	232	Total O 232 232	0	0
11	B	73	Total O 73 73	0	0
11	C	270	Total O 270 270	0	0
11	D	103	Total O 103 103	0	0

3 Residue-property plots i

These plots are drawn for all protein, RNA, DNA and oligosaccharide chains in the entry. The first graphic for a chain summarises the proportions of the various outlier classes displayed in the second graphic. The second graphic shows the sequence view annotated by issues in geometry and electron density. Residues are color-coded according to the number of geometric quality criteria for which they contain at least one outlier: green = 0, yellow = 1, orange = 2 and red = 3 or more. A red dot above a residue indicates a poor fit to the electron density ($RSRZ > 2$). Stretches of 2 or more consecutive residues without any outlier are shown as a green connector. Residues present in the sample, but not in the model, are shown in grey.

- Molecule 1: Integrin, alpha 2b

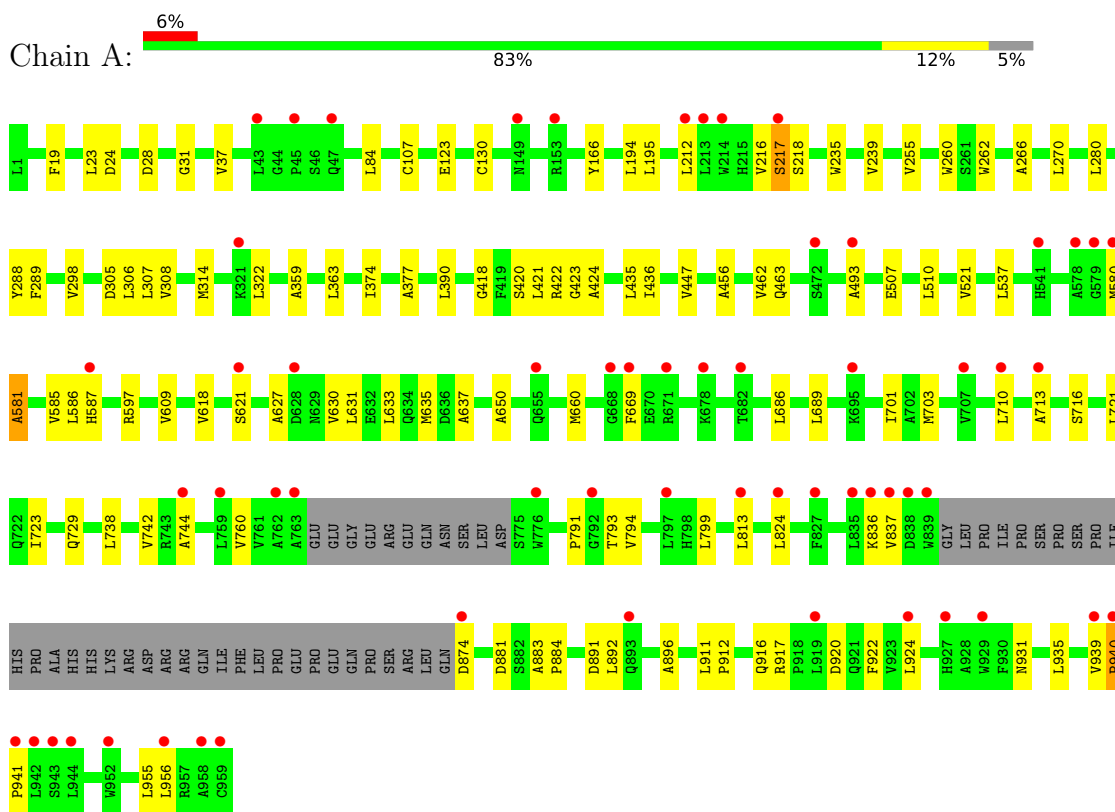

- Molecule 1: Integrin, alpha 2b

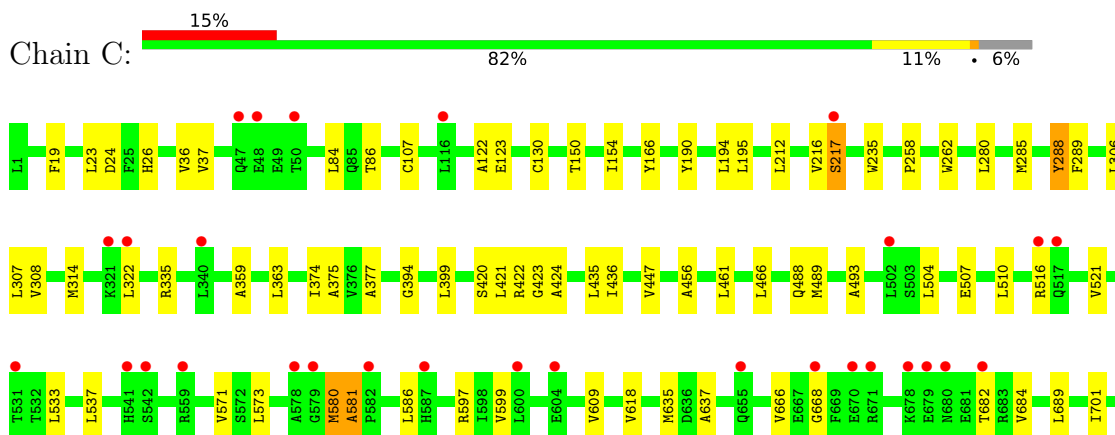

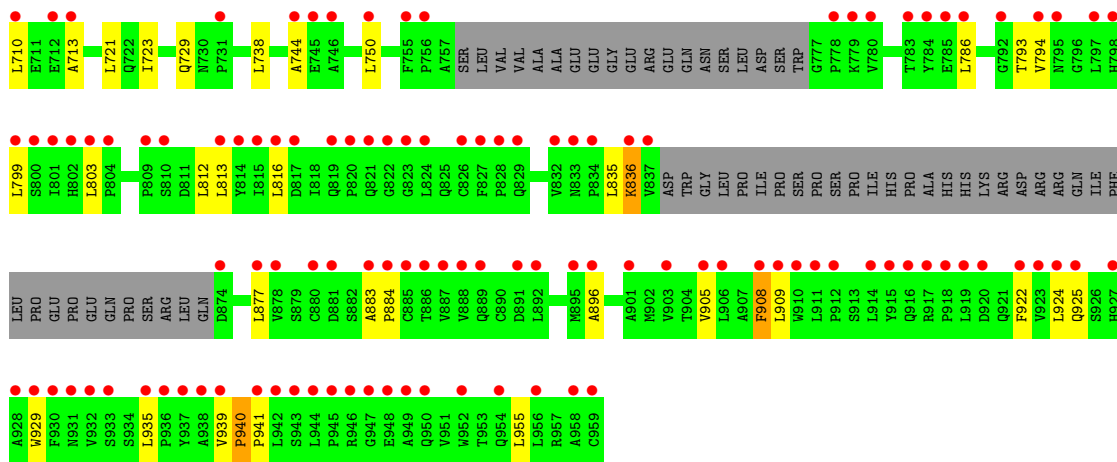

● Molecule 2: Integrin beta-3

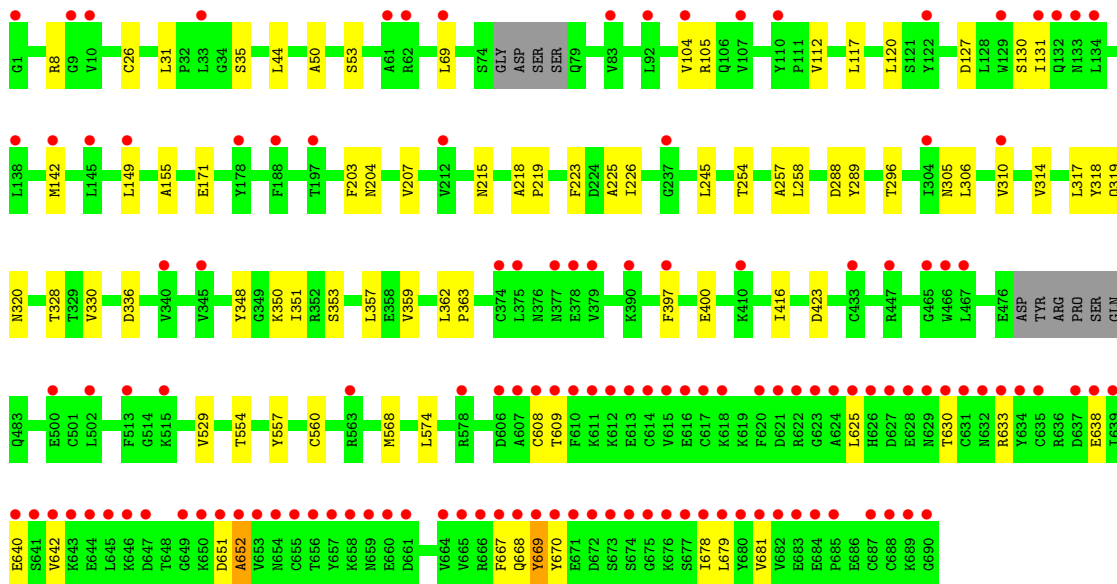
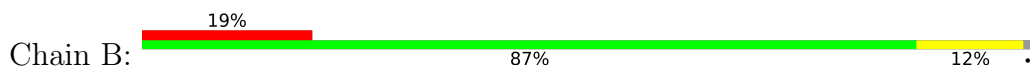

● Molecule 2: Integrin beta-3

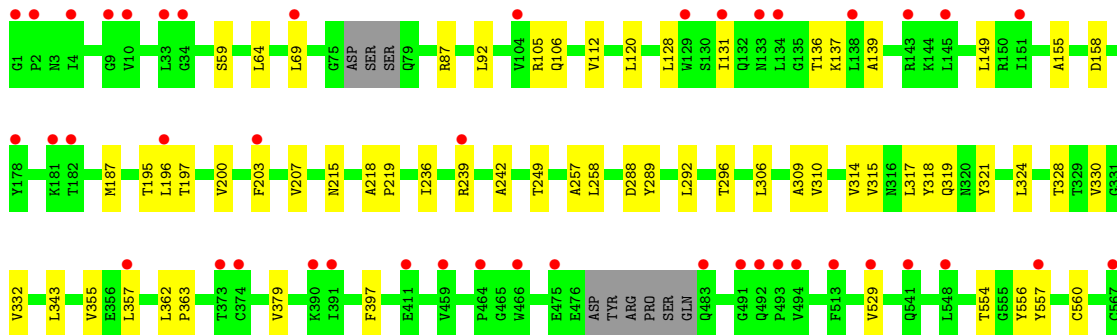
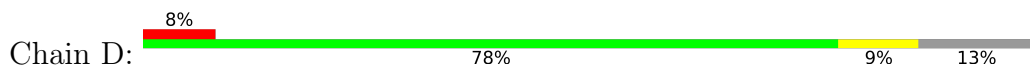

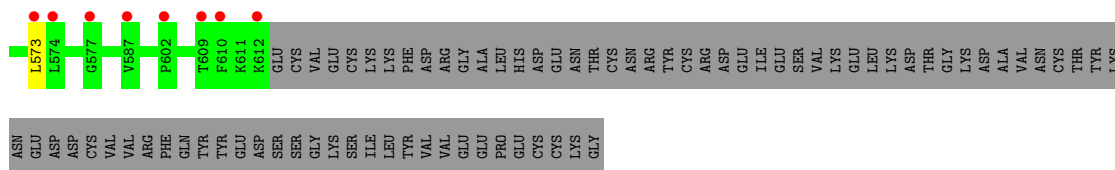

- Molecule 3: 2-acetamido-2-deoxy-beta-D-glucopyranose-(1-4)-2-acetamido-2-deoxy-beta-D-glucopyranose

Chain E: 50% 50%

MAG1
MAG2

- Molecule 3: 2-acetamido-2-deoxy-beta-D-glucopyranose-(1-4)-2-acetamido-2-deoxy-beta-D-glucopyranose

Chain H: 100%

MAG1
MAG2

- Molecule 3: 2-acetamido-2-deoxy-beta-D-glucopyranose-(1-4)-2-acetamido-2-deoxy-beta-D-glucopyranose

Chain J: 100%

MAG1
MAG2

- Molecule 3: 2-acetamido-2-deoxy-beta-D-glucopyranose-(1-4)-2-acetamido-2-deoxy-beta-D-glucopyranose

Chain K: 100%

MAG1
MAG2

- Molecule 3: 2-acetamido-2-deoxy-beta-D-glucopyranose-(1-4)-2-acetamido-2-deoxy-beta-D-glucopyranose

Chain L: 100%

MAG1
MAG2

- Molecule 3: 2-acetamido-2-deoxy-beta-D-glucopyranose-(1-4)-2-acetamido-2-deoxy-beta-D-glucopyranose

Chain M: 50% 50%



- Molecule 3: 2-acetamido-2-deoxy-beta-D-glucopyranose-(1-4)-2-acetamido-2-deoxy-beta-D-glucopyranose

Chain N:



- Molecule 4: alpha-D-mannopyranose-(1-3)-alpha-D-mannopyranose-(1-4)-2-acetamido-2-deoxy-beta-D-glucopyranose-(1-4)-2-acetamido-2-deoxy-beta-D-glucopyranose

Chain F:



- Molecule 5: alpha-D-mannopyranose-(1-4)-2-acetamido-2-deoxy-beta-D-glucopyranose-(1-4)-2-acetamido-2-deoxy-beta-D-glucopyranose

Chain G:



- Molecule 6: alpha-D-mannopyranose-(1-2)-alpha-D-mannopyranose-(1-3)-alpha-D-mannopyranose-(1-4)-2-acetamido-2-deoxy-beta-D-glucopyranose-(1-4)-2-acetamido-2-deoxy-beta-D-glucopyranose

Chain I:



4 Data and refinement statistics

Property	Value	Source
Space group	P 41	Depositor
Cell constants a, b, c, α , β , γ	81.30Å 81.30Å 654.62Å 90.00° 90.00° 90.00°	Depositor
Resolution (Å)	45.31 – 2.55 45.30 – 2.55	Depositor EDS
% Data completeness (in resolution range)	99.9 (45.31-2.55) 98.6 (45.30-2.55)	Depositor EDS
R_{merge}	0.07	Depositor
R_{sym}	0.07	Depositor
$\langle I/\sigma(I) \rangle$ ¹	1.47 (at 2.54Å)	Xtrriage
Refinement program	REFMAC 5.4.0066	Depositor
R, R_{free}	0.233 , 0.268 0.226 , 0.248	Depositor DCC
R_{free} test set	1785 reflections (1.32%)	wwPDB-VP
Wilson B-factor (Å ²)	49.7	Xtrriage
Anisotropy	0.133	Xtrriage
Bulk solvent k_{sol} (e/Å ³), B_{sol} (Å ²)	0.30 , 37.1	EDS
L-test for twinning ²	$\langle L \rangle = 0.40$, $\langle L^2 \rangle = 0.23$	Xtrriage
Estimated twinning fraction	0.155 for h,-k,-l	Xtrriage
F_o, F_c correlation	0.91	EDS
Total number of atoms	24961	wwPDB-VP
Average B, all atoms (Å ²)	37.0	wwPDB-VP

Xtrriage's analysis on translational NCS is as follows: *The largest off-origin peak in the Patterson function is 2.20% of the height of the origin peak. No significant pseudotranslation is detected.*

¹Intensities estimated from amplitudes.

²Theoretical values of $\langle |L| \rangle$, $\langle L^2 \rangle$ for acentric reflections are 0.5, 0.333 respectively for untwinned datasets, and 0.375, 0.2 for perfectly twinned datasets.

5 Model quality [i](#)

5.1 Standard geometry [i](#)

Bond lengths and bond angles in the following residue types are not validated in this section: IMD, NAG, MG, MAN, CA

The Z score for a bond length (or angle) is the number of standard deviations the observed value is removed from the expected value. A bond length (or angle) with $|Z| > 5$ is considered an outlier worth inspection. RMSZ is the root-mean-square of all Z scores of the bond lengths (or angles).

Mol	Chain	Bond lengths		Bond angles	
		RMSZ	# Z >5	RMSZ	# Z >5
1	A	0.24	0/7209	0.43	0/9823
1	C	0.25	0/7124	0.43	0/9705
2	B	0.23	0/5314	0.40	0/7182
2	D	0.24	0/4704	0.41	0/6362
All	All	0.24	0/24351	0.42	0/33072

There are no bond length outliers.

There are no bond angle outliers.

There are no chirality outliers.

There are no planarity outliers.

5.2 Too-close contacts [i](#)

In the following table, the Non-H and H(model) columns list the number of non-hydrogen atoms and hydrogen atoms in the chain respectively. The H(added) column lists the number of hydrogen atoms added and optimized by MolProbity. The Clashes column lists the number of clashes within the asymmetric unit, whereas Symm-Clashes lists symmetry-related clashes.

Mol	Chain	Non-H	H(model)	H(added)	Clashes	Symm-Clashes
1	A	7033	0	6875	80	0
1	C	6953	0	6797	79	0
2	B	5220	0	4964	53	0
2	D	4615	0	4405	42	0
3	E	28	0	25	1	0
3	H	28	0	25	0	0
3	J	28	0	25	0	0
3	K	28	0	25	0	0
3	L	28	0	25	0	0

Continued on next page...

Continued from previous page...

Mol	Chain	Non-H	H(model)	H(added)	Clashes	Symm-Clashes
3	M	28	0	25	0	0
3	N	28	0	25	0	0
4	F	50	0	43	1	0
5	G	39	0	34	2	0
6	I	61	0	52	4	0
7	A	5	0	0	0	0
7	B	2	0	0	0	0
7	C	5	0	0	0	0
7	D	2	0	0	0	0
8	A	28	0	26	1	0
8	C	28	0	26	2	0
8	D	14	0	13	0	0
9	A	5	0	5	0	0
9	C	25	0	25	0	0
10	B	1	0	0	0	0
10	D	1	0	0	0	0
11	A	232	0	0	3	0
11	B	73	0	0	0	0
11	C	270	0	0	1	0
11	D	103	0	0	3	0
All	All	24961	0	23440	251	0

The all-atom clashscore is defined as the number of clashes found per 1000 atoms (including hydrogen atoms). The all-atom clashscore for this structure is 5.

The worst 5 of 251 close contacts within the same asymmetric unit are listed below, sorted by their clash magnitude.

Atom-1	Atom-2	Interatomic distance (Å)	Clash overlap (Å)
1:C:507:GLU:HB2	8:C:3570:NAG:H82	1.38	1.02
1:C:816:LEU:HD11	1:C:908:PHE:CZ	2.08	0.88
2:D:573:LEU:O	11:D:693:HOH:O	2.05	0.74
2:B:320:ASN:HD22	4:F:1:NAG:H83	1.51	0.73
1:C:314:MET:CE	1:C:322:LEU:HD22	2.20	0.72

There are no symmetry-related clashes.

5.3 Torsion angles [i](#)

5.3.1 Protein backbone [i](#)

In the following table, the Percentiles column shows the percent Ramachandran outliers of the chain as a percentile score with respect to all X-ray entries followed by that with respect to entries of similar resolution.

The Analysed column shows the number of residues for which the backbone conformation was analysed, and the total number of residues.

Mol	Chain	Analysed	Favoured	Allowed	Outliers	Percentiles	
1	A	913/959 (95%)	864 (95%)	41 (4%)	8 (1%)	17	24
1	C	904/959 (94%)	863 (96%)	37 (4%)	4 (0%)	34	46
2	B	675/690 (98%)	613 (91%)	58 (9%)	4 (1%)	25	34
2	D	600/690 (87%)	559 (93%)	41 (7%)	0	100	100
All	All	3092/3298 (94%)	2899 (94%)	177 (6%)	16 (0%)	29	40

5 of 16 Ramachandran outliers are listed below:

Mol	Chain	Res	Type
1	A	217	SER
1	A	837	VAL
1	A	940	PRO
1	A	581	ALA
1	A	836	LYS

5.3.2 Protein sidechains [i](#)

In the following table, the Percentiles column shows the percent sidechain outliers of the chain as a percentile score with respect to all X-ray entries followed by that with respect to entries of similar resolution.

The Analysed column shows the number of residues for which the sidechain conformation was analysed, and the total number of residues.

Mol	Chain	Analysed	Rotameric	Outliers	Percentiles	
1	A	762/799 (95%)	755 (99%)	7 (1%)	78	86
1	C	753/799 (94%)	745 (99%)	8 (1%)	73	83
2	B	604/612 (99%)	598 (99%)	6 (1%)	76	84
2	D	534/612 (87%)	533 (100%)	1 (0%)	93	97
All	All	2653/2822 (94%)	2631 (99%)	22 (1%)	81	88

5 of 22 residues with a non-rotameric sidechain are listed below:

Mol	Chain	Res	Type
1	C	166	TYR
1	C	335	ARG
1	C	288	TYR
1	C	580	MET
1	A	874	ASP

Sometimes sidechains can be flipped to improve hydrogen bonding and reduce clashes. 5 of 14 such sidechains are listed below:

Mol	Chain	Res	Type
2	B	668	GLN
1	C	7	GLN
2	D	14	GLN
1	C	680	ASN
1	C	921	GLN

5.3.3 RNA [i](#)

There are no RNA molecules in this entry.

5.4 Non-standard residues in protein, DNA, RNA chains [i](#)

There are no non-standard protein/DNA/RNA residues in this entry.

5.5 Carbohydrates [i](#)

26 monosaccharides are modelled in this entry.

In the following table, the Counts columns list the number of bonds (or angles) for which Mogul statistics could be retrieved, the number of bonds (or angles) that are observed in the model and the number of bonds (or angles) that are defined in the Chemical Component Dictionary. The Link column lists molecule types, if any, to which the group is linked. The Z score for a bond length (or angle) is the number of standard deviations the observed value is removed from the expected value. A bond length (or angle) with $|Z| > 2$ is considered an outlier worth inspection. RMSZ is the root-mean-square of all Z scores of the bond lengths (or angles).

Mol	Type	Chain	Res	Link	Bond lengths			Bond angles		
					Counts	RMSZ	$\# Z > 2$	Counts	RMSZ	$\# Z > 2$
3	NAG	E	1	2,3	14,14,15	0.62	0	17,19,21	1.14	1 (5%)
3	NAG	E	2	3	14,14,15	0.60	0	17,19,21	0.95	1 (5%)

Mol	Type	Chain	Res	Link	Bond lengths			Bond angles		
					Counts	RMSZ	# Z > 2	Counts	RMSZ	# Z > 2
4	NAG	F	1	2,4	14,14,15	0.51	0	17,19,21	0.71	0
4	NAG	F	2	4	14,14,15	0.54	0	17,19,21	0.69	0
4	MAN	F	3	4	11,11,12	0.61	0	15,15,17	0.69	0
4	MAN	F	4	4	11,11,12	0.51	0	15,15,17	2.54	3 (20%)
5	NAG	G	1	2,5	14,14,15	0.64	0	17,19,21	0.68	0
5	NAG	G	2	5	14,14,15	0.52	0	17,19,21	0.82	0
5	MAN	G	3	5	11,11,12	0.64	0	15,15,17	0.61	0
3	NAG	H	1	2,3	14,14,15	0.67	0	17,19,21	0.88	0
3	NAG	H	2	3	14,14,15	0.54	0	17,19,21	0.66	0
6	NAG	I	1	2,6	14,14,15	0.63	0	17,19,21	0.91	1 (5%)
6	NAG	I	2	6	14,14,15	0.47	0	17,19,21	0.94	0
6	MAN	I	3	6	11,11,12	0.56	0	15,15,17	0.95	1 (6%)
6	MAN	I	4	6	11,11,12	0.56	0	15,15,17	0.72	0
6	MAN	I	5	6	11,11,12	0.62	0	15,15,17	0.74	0
3	NAG	J	1	3,1	14,14,15	0.51	0	17,19,21	1.26	2 (11%)
3	NAG	J	2	3	14,14,15	0.65	0	17,19,21	0.89	1 (5%)
3	NAG	K	1	2,3	14,14,15	0.62	0	17,19,21	0.71	0
3	NAG	K	2	3	14,14,15	0.57	0	17,19,21	0.67	0
3	NAG	L	1	2,3	14,14,15	0.55	0	17,19,21	0.63	0
3	NAG	L	2	3	14,14,15	0.53	0	17,19,21	0.63	0
3	NAG	M	1	2,3	14,14,15	0.59	0	17,19,21	0.84	1 (5%)
3	NAG	M	2	3	14,14,15	0.58	0	17,19,21	0.74	0
3	NAG	N	1	2,3	14,14,15	0.56	0	17,19,21	0.81	1 (5%)
3	NAG	N	2	3	14,14,15	0.61	0	17,19,21	0.70	0

In the following table, the Chirals column lists the number of chiral outliers, the number of chiral centers analysed, the number of these observed in the model and the number defined in the Chemical Component Dictionary. Similar counts are reported in the Torsion and Rings columns. '-' means no outliers of that kind were identified.

Mol	Type	Chain	Res	Link	Chirals	Torsions	Rings
3	NAG	E	1	2,3	-	2/6/23/26	0/1/1/1
3	NAG	E	2	3	-	0/6/23/26	0/1/1/1
4	NAG	F	1	2,4	-	2/6/23/26	0/1/1/1
4	NAG	F	2	4	-	0/6/23/26	0/1/1/1
4	MAN	F	3	4	1/1/4/5	0/2/19/22	0/1/1/1
4	MAN	F	4	4	-	2/2/19/22	0/1/1/1
5	NAG	G	1	2,5	-	0/6/23/26	0/1/1/1
5	NAG	G	2	5	-	4/6/23/26	0/1/1/1
5	MAN	G	3	5	1/1/4/5	2/2/19/22	0/1/1/1

Continued on next page...

Continued from previous page...

Mol	Type	Chain	Res	Link	Chirals	Torsions	Rings
3	NAG	H	1	2,3	-	0/6/23/26	0/1/1/1
3	NAG	H	2	3	-	0/6/23/26	0/1/1/1
6	NAG	I	1	2,6	-	2/6/23/26	0/1/1/1
6	NAG	I	2	6	-	0/6/23/26	0/1/1/1
6	MAN	I	3	6	1/1/4/5	2/2/19/22	0/1/1/1
6	MAN	I	4	6	-	0/2/19/22	0/1/1/1
6	MAN	I	5	6	-	2/2/19/22	0/1/1/1
3	NAG	J	1	3,1	-	3/6/23/26	0/1/1/1
3	NAG	J	2	3	-	2/6/23/26	0/1/1/1
3	NAG	K	1	2,3	-	2/6/23/26	0/1/1/1
3	NAG	K	2	3	-	0/6/23/26	0/1/1/1
3	NAG	L	1	2,3	-	0/6/23/26	0/1/1/1
3	NAG	L	2	3	-	2/6/23/26	0/1/1/1
3	NAG	M	1	2,3	-	0/6/23/26	0/1/1/1
3	NAG	M	2	3	-	0/6/23/26	0/1/1/1
3	NAG	N	1	2,3	-	0/6/23/26	0/1/1/1
3	NAG	N	2	3	-	1/6/23/26	0/1/1/1

There are no bond length outliers.

The worst 5 of 12 bond angle outliers are listed below:

Mol	Chain	Res	Type	Atoms	Z	Observed(°)	Ideal(°)
4	F	4	MAN	C1-O5-C5	7.33	122.12	112.19
4	F	4	MAN	C1-C2-C3	4.60	115.33	109.67
4	F	4	MAN	O5-C1-C2	4.16	117.19	110.77
3	E	1	NAG	C4-C3-C2	3.47	116.11	111.02
3	J	1	NAG	O4-C4-C5	3.22	117.29	109.30

All (3) chirality outliers are listed below:

Mol	Chain	Res	Type	Atom
4	F	3	MAN	C1
5	G	3	MAN	C1
6	I	3	MAN	C1

5 of 28 torsion outliers are listed below:

Mol	Chain	Res	Type	Atoms
3	J	2	NAG	O5-C5-C6-O6
3	J	1	NAG	O5-C5-C6-O6

Continued on next page...

Continued from previous page...

Mol	Chain	Res	Type	Atoms
5	G	3	MAN	O5-C5-C6-O6
5	G	2	NAG	O5-C5-C6-O6
3	J	1	NAG	C4-C5-C6-O6

There are no ring outliers.

5 monomers are involved in 7 short contacts:

Mol	Chain	Res	Type	Clashes	Symm-Clashes
5	G	1	NAG	2	0
4	F	1	NAG	1	0
6	I	3	MAN	1	0
6	I	2	NAG	4	0
3	E	1	NAG	1	0

The following is a two-dimensional graphical depiction of Mogul quality analysis of bond lengths, bond angles, torsion angles, and ring geometry for oligosaccharide.

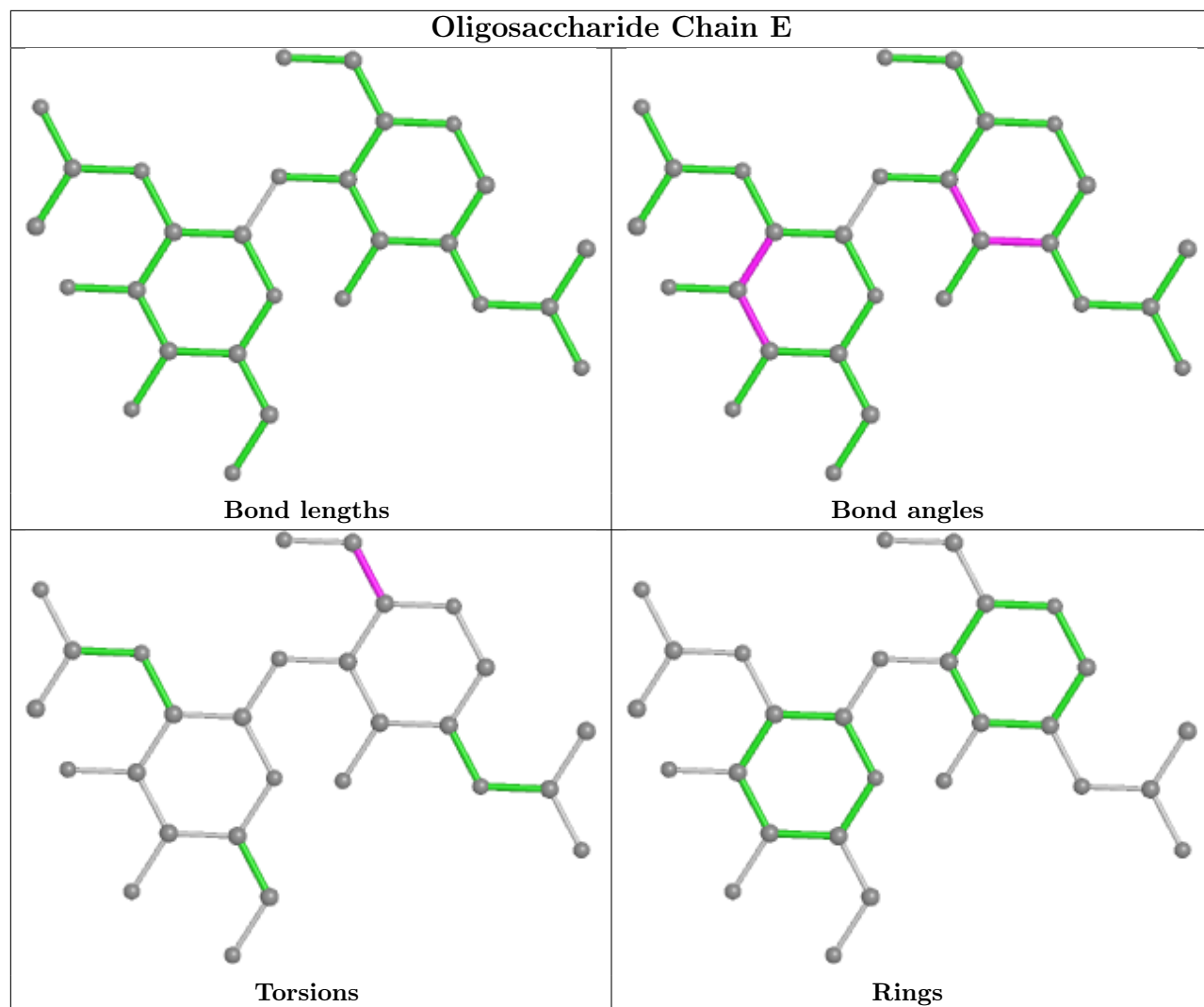

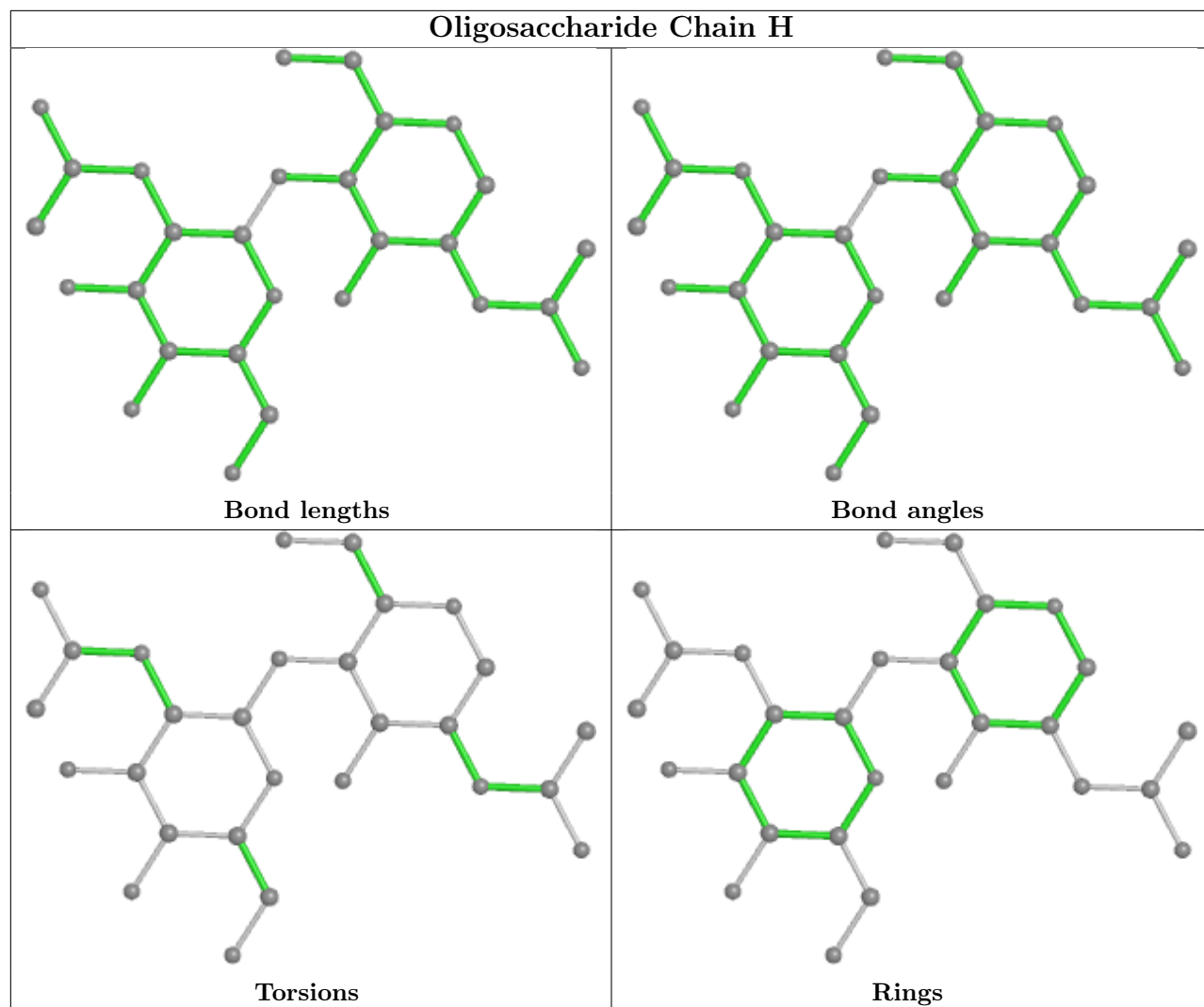

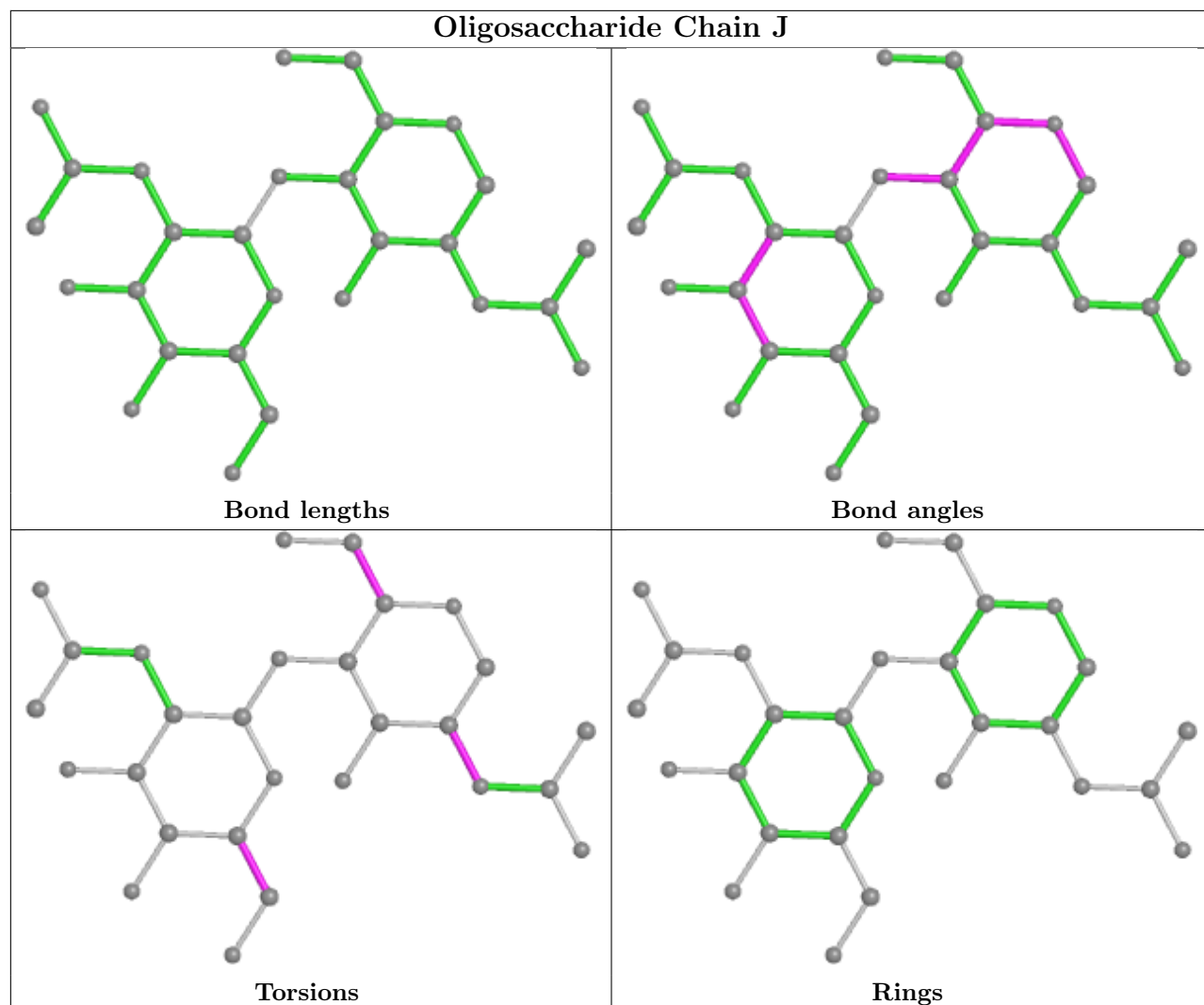

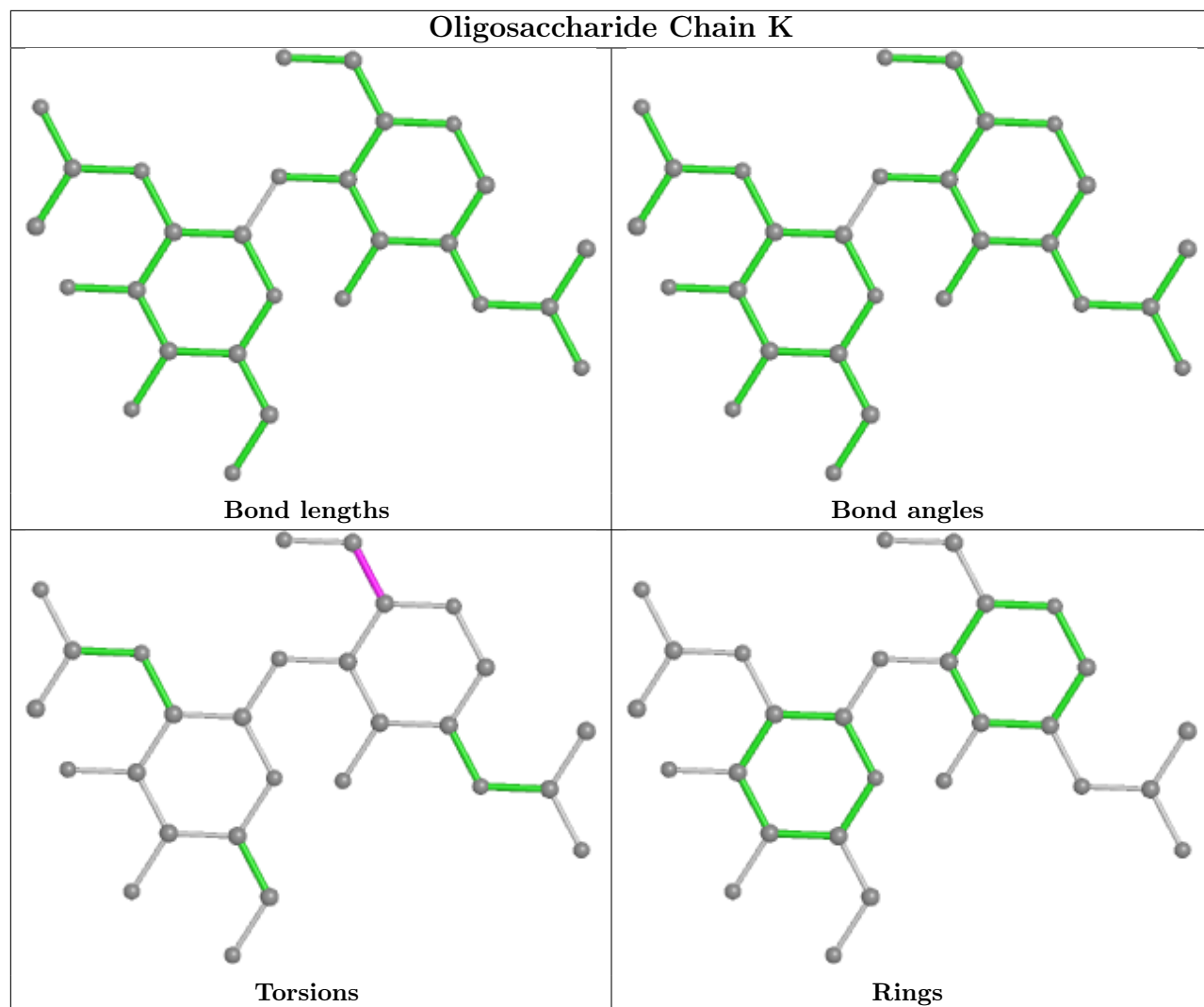

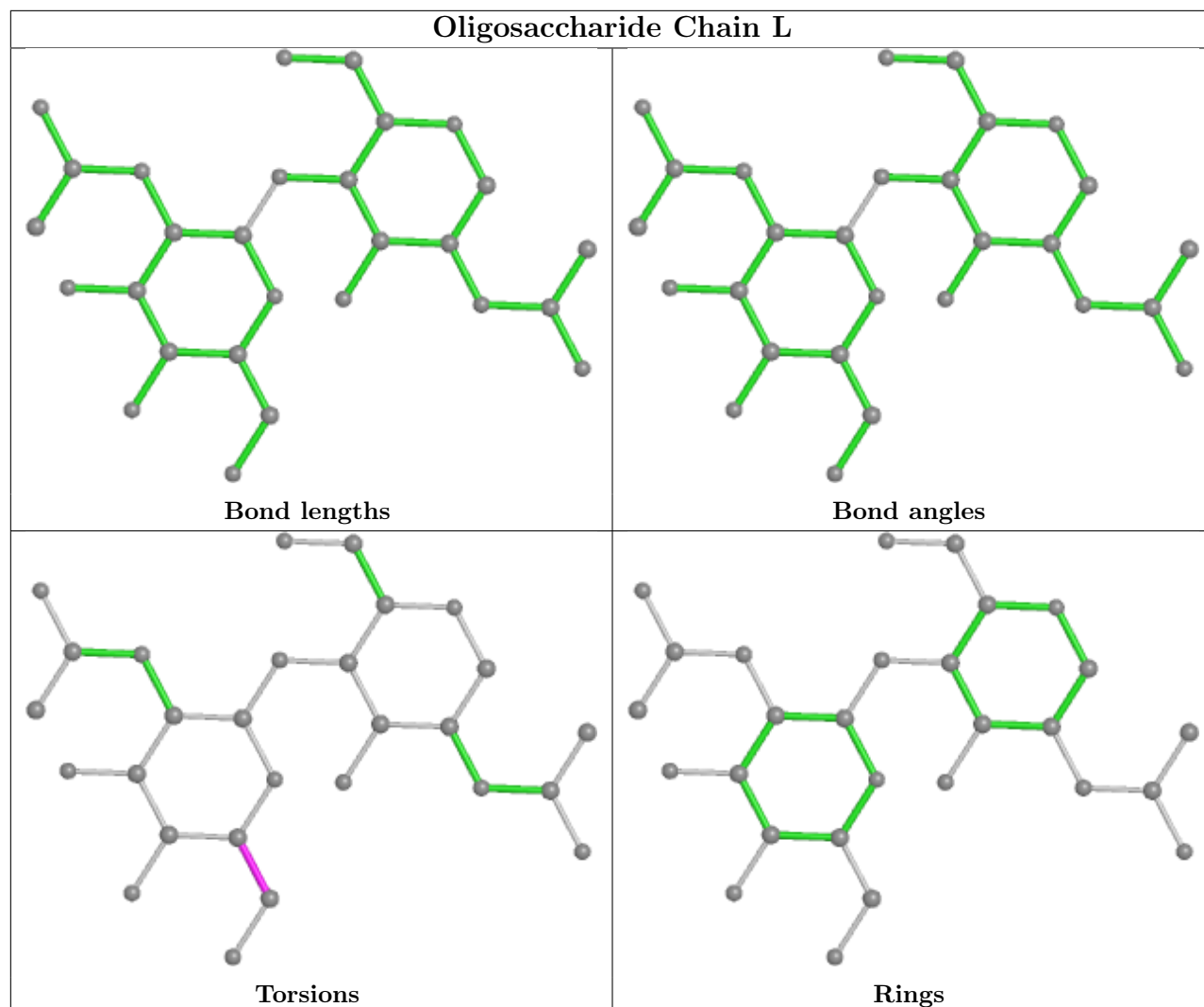

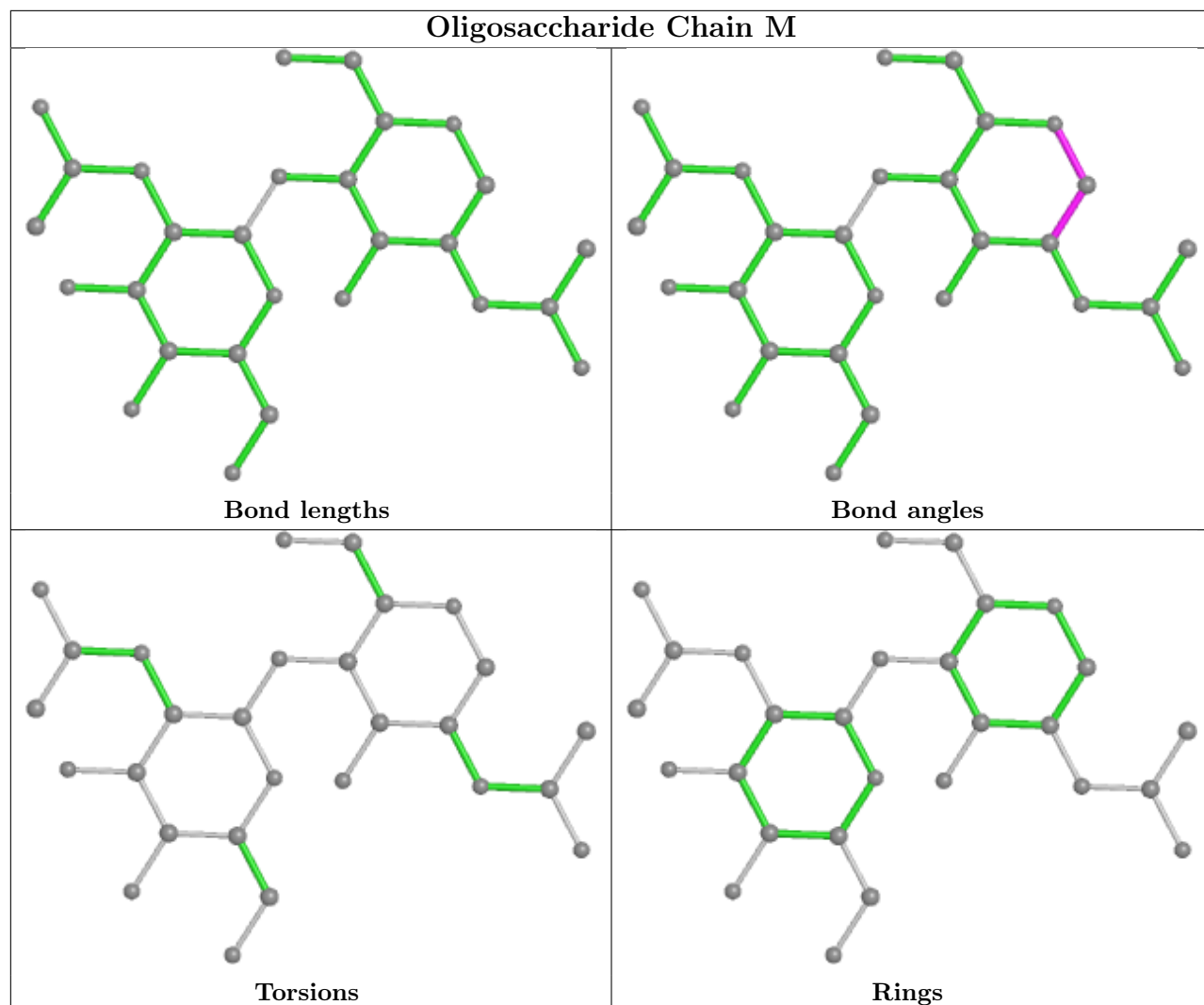

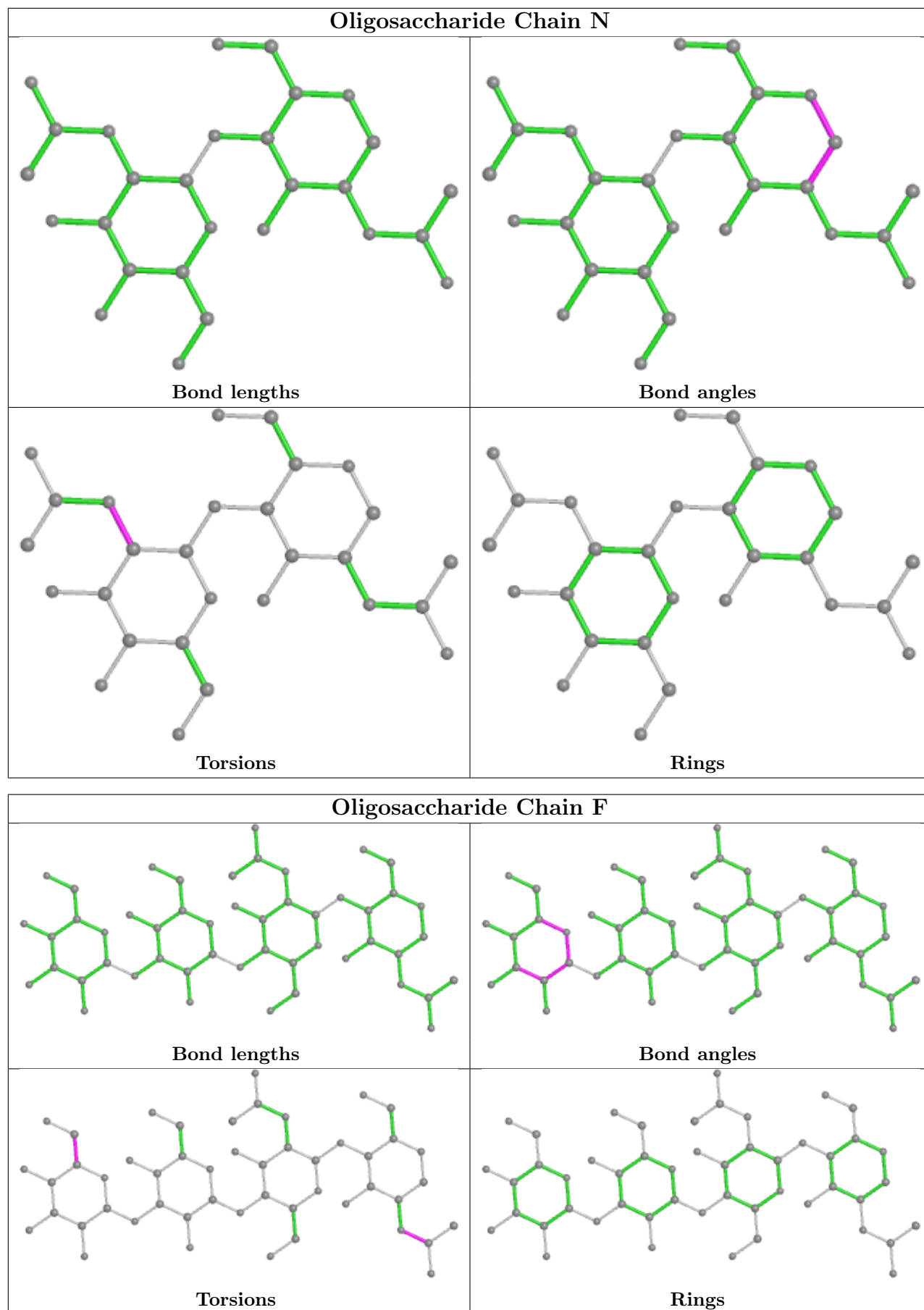

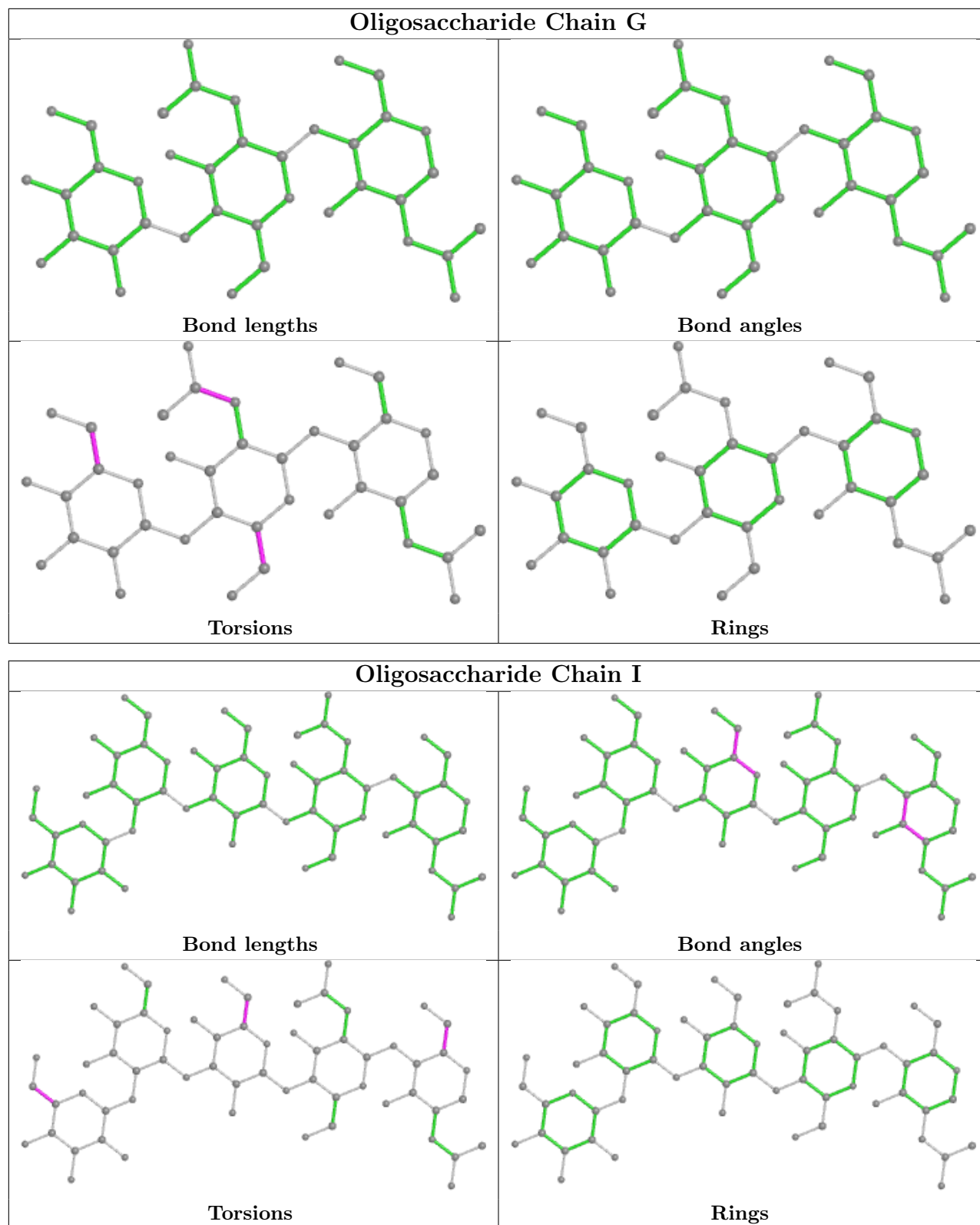

5.6 Ligand geometry [i](#)

Of 27 ligands modelled in this entry, 16 are monoatomic - leaving 11 for Mogul analysis.

In the following table, the Counts columns list the number of bonds (or angles) for which Mogul statistics could be retrieved, the number of bonds (or angles) that are observed in the model and the number of bonds (or angles) that are defined in the Chemical Component Dictionary. The Link column lists molecule types, if any, to which the group is linked. The Z score for a bond length (or angle) is the number of standard deviations the observed value is removed from the expected value. A bond length (or angle) with $|Z| > 2$ is considered an outlier worth inspection. RMSZ is the root-mean-square of all Z scores of the bond lengths (or angles).

Mol	Type	Chain	Res	Link	Bond lengths			Bond angles		
					Counts	RMSZ	# Z > 2	Counts	RMSZ	# Z > 2
8	NAG	D	3099	2	14,14,15	0.57	0	17,19,21	0.67	0
8	NAG	A	3570	1	14,14,15	0.65	0	17,19,21	1.60	2 (11%)
9	IMD	C	5001	-	3,5,5	0.43	0	4,5,5	0.60	0
8	NAG	C	3570	1	14,14,15	0.58	0	17,19,21	0.66	0
9	IMD	C	5004	-	3,5,5	0.42	0	4,5,5	0.58	0
9	IMD	A	5001	-	3,5,5	0.42	0	4,5,5	0.59	0
9	IMD	C	5002	-	3,5,5	0.44	0	4,5,5	0.59	0
8	NAG	C	3015	1	14,14,15	0.58	0	17,19,21	0.85	0
8	NAG	A	3015	1	14,14,15	0.49	0	17,19,21	0.73	0
9	IMD	C	960	-	3,5,5	0.45	0	4,5,5	0.58	0
9	IMD	C	5003	-	3,5,5	0.43	0	4,5,5	0.60	0

In the following table, the Chirals column lists the number of chiral outliers, the number of chiral centers analysed, the number of these observed in the model and the number defined in the Chemical Component Dictionary. Similar counts are reported in the Torsion and Rings columns. '-' means no outliers of that kind were identified.

Mol	Type	Chain	Res	Link	Chirals	Torsions	Rings
8	NAG	D	3099	2	1/1/5/7	0/6/23/26	0/1/1/1
8	NAG	A	3570	1	-	2/6/23/26	0/1/1/1
9	IMD	C	5001	-	-	-	0/1/1/1
8	NAG	C	3570	1	1/1/5/7	1/6/23/26	0/1/1/1
9	IMD	C	5004	-	-	-	0/1/1/1
9	IMD	A	5001	-	-	-	0/1/1/1
9	IMD	C	5002	-	-	-	0/1/1/1
8	NAG	C	3015	1	-	0/6/23/26	0/1/1/1
8	NAG	A	3015	1	-	0/6/23/26	0/1/1/1
9	IMD	C	960	-	-	-	0/1/1/1
9	IMD	C	5003	-	-	-	0/1/1/1

There are no bond length outliers.

All (2) bond angle outliers are listed below:

Mol	Chain	Res	Type	Atoms	Z	Observed(°)	Ideal(°)
8	A	3570	NAG	C1-O5-C5	5.40	119.51	112.19
8	A	3570	NAG	O5-C1-C2	2.72	115.58	111.29

All (2) chirality outliers are listed below:

Mol	Chain	Res	Type	Atom
8	C	3570	NAG	C1
8	D	3099	NAG	C1

All (3) torsion outliers are listed below:

Mol	Chain	Res	Type	Atoms
8	A	3570	NAG	O5-C5-C6-O6
8	A	3570	NAG	C4-C5-C6-O6
8	C	3570	NAG	C3-C2-N2-C7

There are no ring outliers.

2 monomers are involved in 3 short contacts:

Mol	Chain	Res	Type	Clashes	Symm-Clashes
8	A	3570	NAG	1	0
8	C	3570	NAG	2	0

5.7 Other polymers [i](#)

There are no such residues in this entry.

5.8 Polymer linkage issues [i](#)

There are no chain breaks in this entry.

6 Fit of model and data [i](#)

6.1 Protein, DNA and RNA chains [i](#)

In the following table, the column labelled ‘#RSRZ > 2’ contains the number (and percentage) of RSRZ outliers, followed by percent RSRZ outliers for the chain as percentile scores relative to all X-ray entries and entries of similar resolution. The OWAB column contains the minimum, median, 95th percentile and maximum values of the occupancy-weighted average B-factor per residue. The column labelled ‘Q < 0.9’ lists the number of (and percentage) of residues with an average occupancy less than 0.9.

Mol	Chain	Analysed	<RSRZ>	#RSRZ>2	OWAB(Å ²)	Q<0.9
1	A	914/959 (95%)	0.67	60 (6%) 18 21	23, 27, 53, 90	0
1	C	904/959 (94%)	1.11	142 (15%) 2 2	23, 27, 52, 90	16 (1%)
2	B	680/690 (98%)	1.66	129 (18%) 1 1	23, 46, 62, 72	84 (12%)
2	D	603/690 (87%)	0.78	52 (8%) 10 12	23, 44, 63, 72	0
All	All	3101/3298 (94%)	1.04	383 (12%) 4 5	23, 35, 59, 90	100 (3%)

The worst 5 of 383 RSRZ outliers are listed below:

Mol	Chain	Res	Type	RSRZ
2	B	614	CYS	21.4
2	B	670	TYR	20.9
2	B	652	ALA	20.6
2	B	680	TYR	20.3
2	B	641	SER	19.6

6.2 Non-standard residues in protein, DNA, RNA chains [i](#)

There are no non-standard protein/DNA/RNA residues in this entry.

6.3 Carbohydrates [i](#)

In the following table, the Atoms column lists the number of modelled atoms in the group and the number defined in the chemical component dictionary. The B-factors column lists the minimum, median, 95th percentile and maximum values of B factors of atoms in the group. The column labelled ‘Q < 0.9’ lists the number of atoms with occupancy less than 0.9.

Mol	Type	Chain	Res	Atoms	RSCC	RSR	B-factors(Å ²)	Q<0.9
6	MAN	I	5	11/12	0.42	0.32	94,95,96,96	0
6	MAN	I	3	11/12	0.51	0.21	87,88,90,92	0

Continued on next page...

Continued from previous page...

Mol	Type	Chain	Res	Atoms	RSCC	RSR	B-factors(\AA^2)	Q<0.9
6	MAN	I	4	11/12	0.57	0.39	94,94,95,95	0
3	NAG	M	2	14/15	0.66	0.37	90,91,92,92	0
3	NAG	M	1	14/15	0.69	0.32	83,86,87,89	0
4	MAN	F	3	11/12	0.70	0.23	89,90,91,92	0
3	NAG	H	2	14/15	0.71	0.42	88,89,90,90	0
4	MAN	F	4	11/12	0.73	0.25	92,93,94,94	0
3	NAG	J	2	14/15	0.76	0.46	66,69,69,69	0
3	NAG	E	2	14/15	0.76	0.42	77,78,78,79	0
6	NAG	I	2	14/15	0.77	0.27	79,80,83,85	0
3	NAG	L	2	14/15	0.78	0.30	61,62,63,64	0
3	NAG	N	2	14/15	0.78	0.32	75,76,78,78	0
3	NAG	N	1	14/15	0.81	0.28	69,72,74,75	0
4	NAG	F	2	14/15	0.81	0.37	77,79,83,86	0
3	NAG	E	1	14/15	0.82	0.33	71,73,75,76	0
3	NAG	H	1	14/15	0.82	0.29	81,82,84,86	0
5	NAG	G	2	14/15	0.84	0.25	66,69,70,72	0
5	MAN	G	3	11/12	0.84	0.31	73,74,75,75	0
4	NAG	F	1	14/15	0.84	0.32	61,65,69,74	0
6	NAG	I	1	14/15	0.88	0.16	68,69,72,75	0
3	NAG	J	1	14/15	0.89	0.21	51,56,58,62	0
3	NAG	K	2	14/15	0.89	0.26	66,69,69,69	0
3	NAG	K	1	14/15	0.90	0.14	55,57,60,63	0
5	NAG	G	1	14/15	0.91	0.18	51,54,57,62	0
3	NAG	L	1	14/15	0.92	0.17	55,56,59,60	0

The following is a graphical depiction of the model fit to experimental electron density for oligosaccharide. Each fit is shown from different orientation to approximate a three-dimensional view.

Electron density around Chain E:

$2mF_o-DF_c$ (at 0.7 rmsd) in gray
 mF_o-DF_c (at 3 rmsd) in purple (negative)
and green (positive)

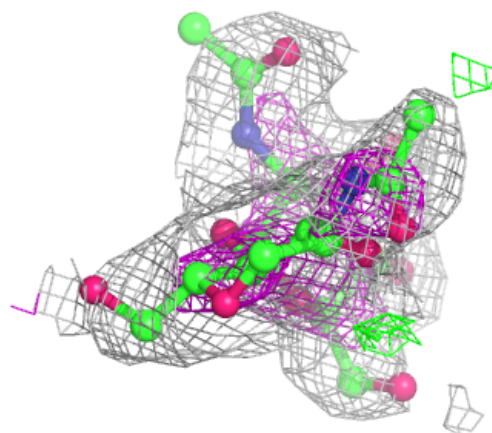
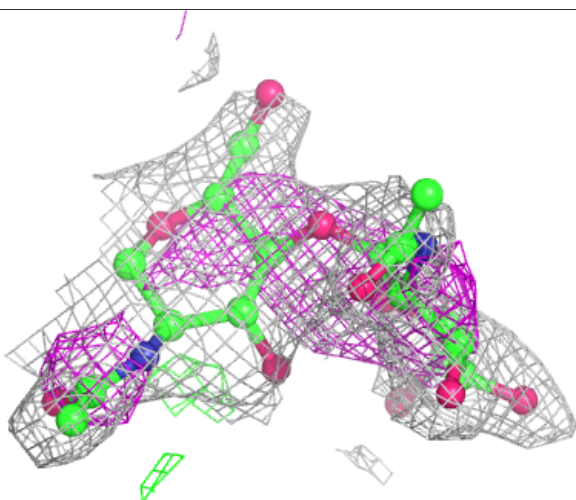
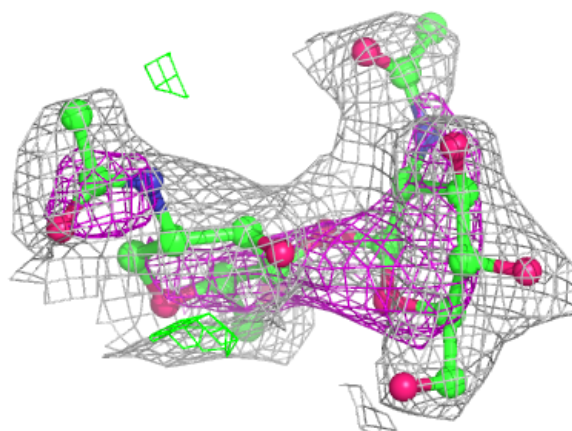

Electron density around Chain H:

$2mF_o-DF_c$ (at 0.7 rmsd) in gray
 mF_o-DF_c (at 3 rmsd) in purple (negative)
and green (positive)

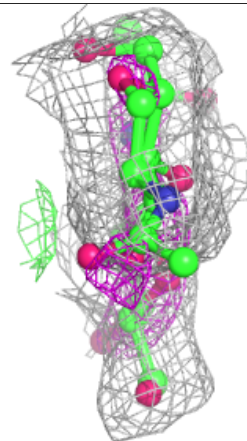
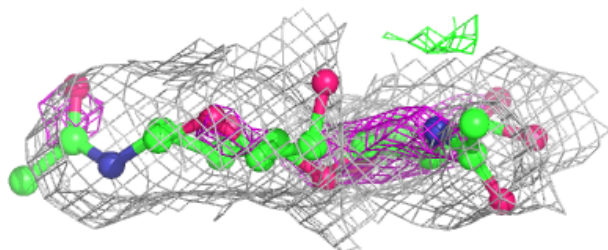
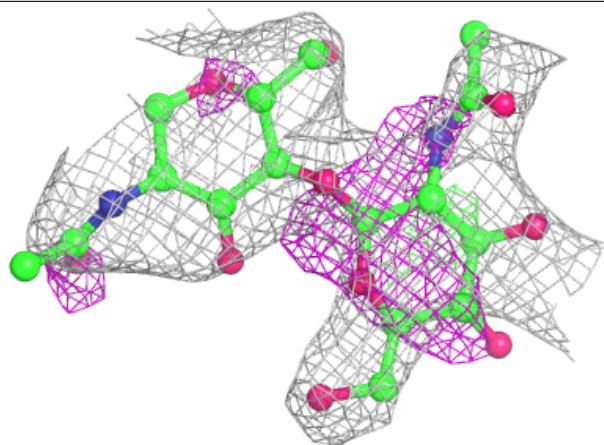

Electron density around Chain J:

$2mF_o-DF_c$ (at 0.7 rmsd) in gray
 mF_o-DF_c (at 3 rmsd) in purple (negative)
and green (positive)

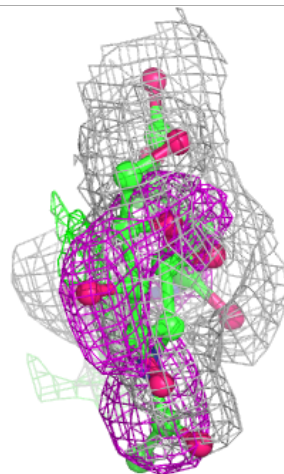
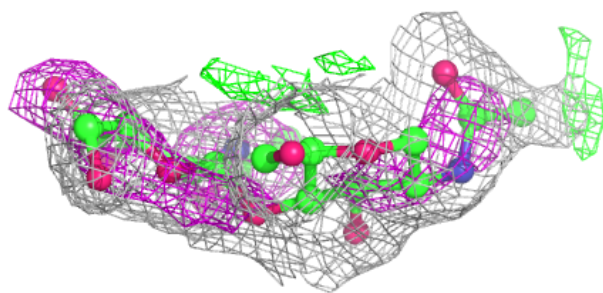
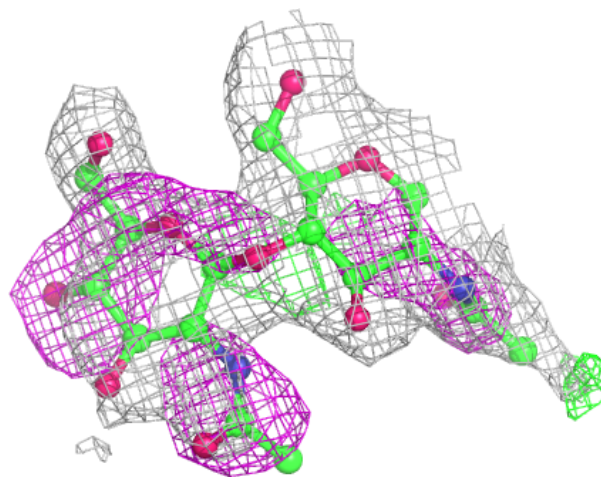

Electron density around Chain K:

$2mF_o-DF_c$ (at 0.7 rmsd) in gray
 mF_o-DF_c (at 3 rmsd) in purple (negative)
and green (positive)

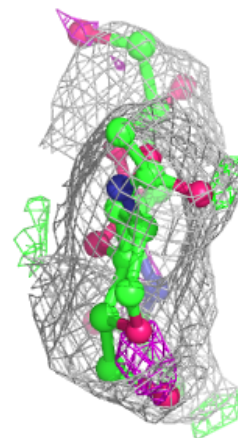
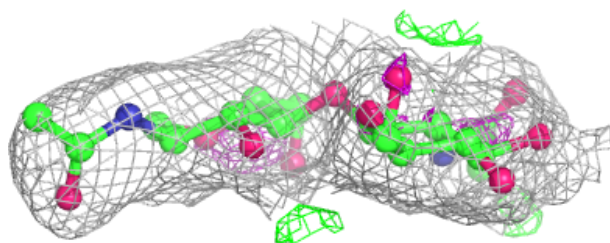
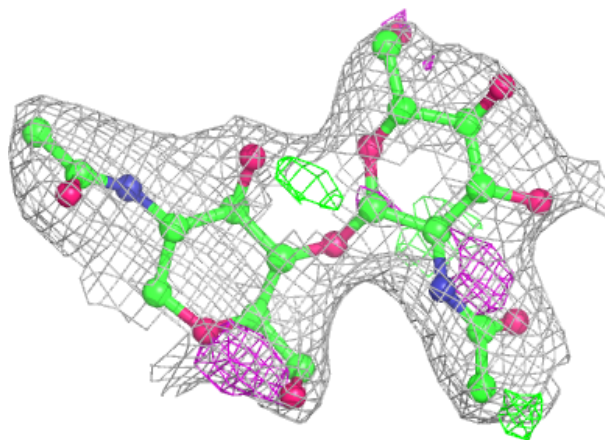

Electron density around Chain L:

$2mF_o-DF_c$ (at 0.7 rmsd) in gray
 mF_o-DF_c (at 3 rmsd) in purple (negative)
and green (positive)

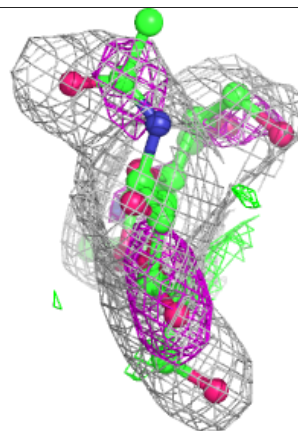
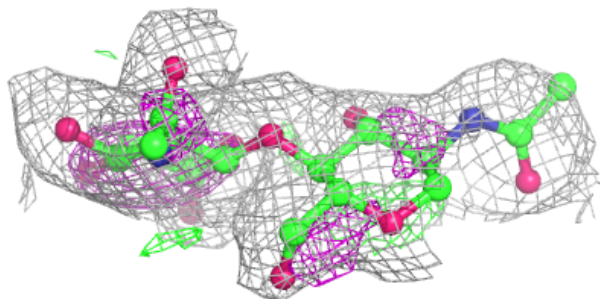
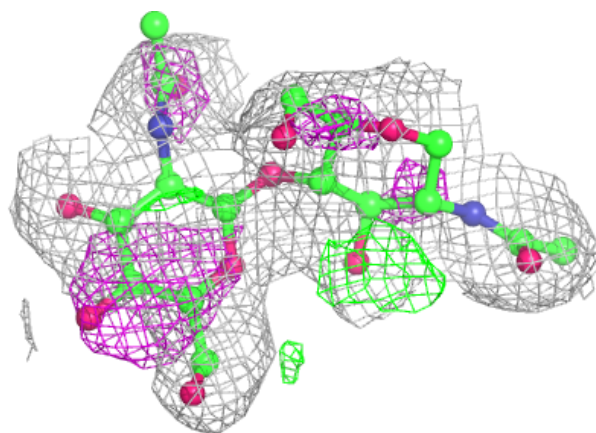
**Electron density around Chain M:**

$2mF_o-DF_c$ (at 0.7 rmsd) in gray
 mF_o-DF_c (at 3 rmsd) in purple (negative)
and green (positive)

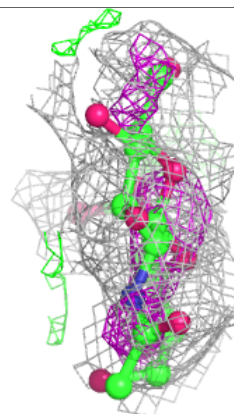
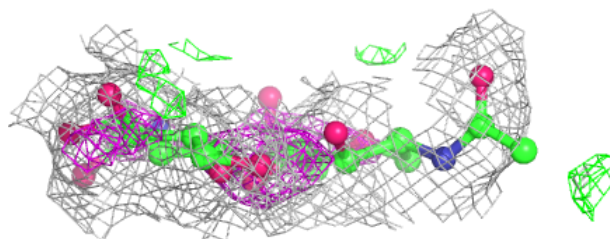
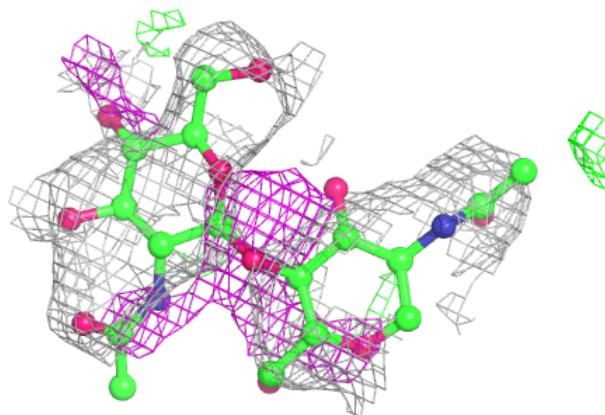

Electron density around Chain N:

$2mF_o-DF_c$ (at 0.7 rmsd) in gray
 mF_o-DF_c (at 3 rmsd) in purple (negative)
and green (positive)

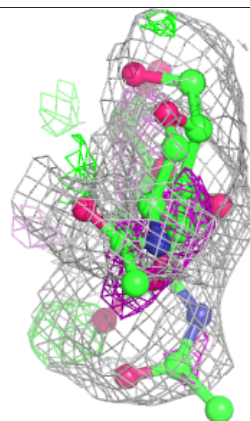
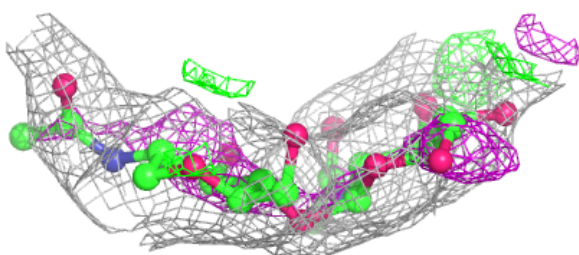
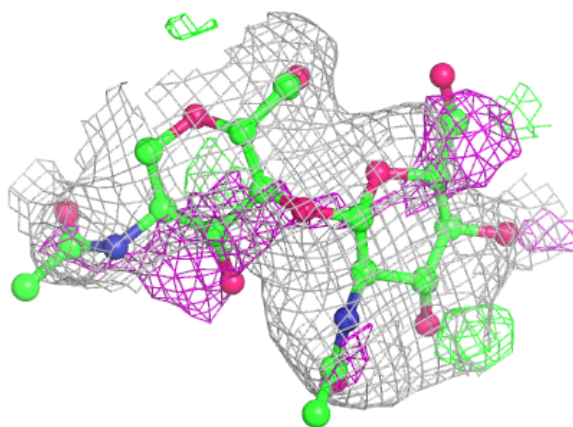
**Electron density around Chain F:**

$2mF_o-DF_c$ (at 0.7 rmsd) in gray
 mF_o-DF_c (at 3 rmsd) in purple (negative)
and green (positive)

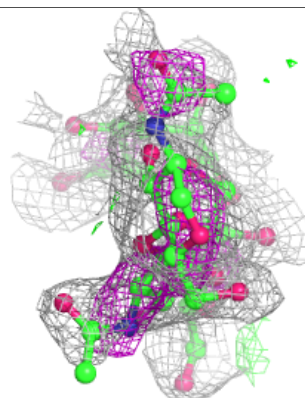
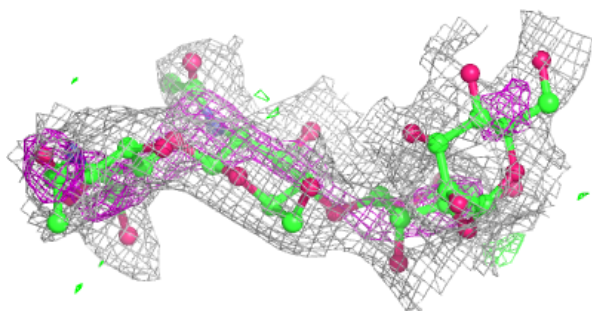
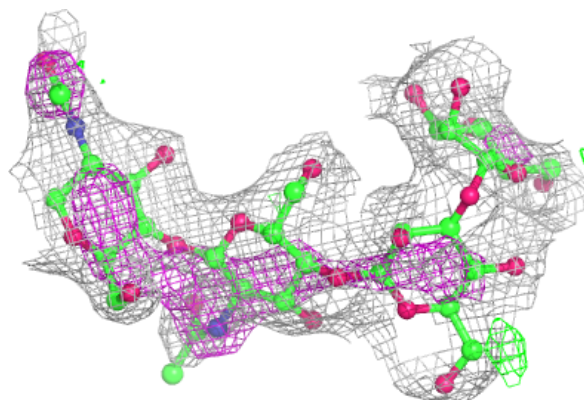

Electron density around Chain G:

$2mF_o-DF_c$ (at 0.7 rmsd) in gray
 mF_o-DF_c (at 3 rmsd) in purple (negative)
and green (positive)

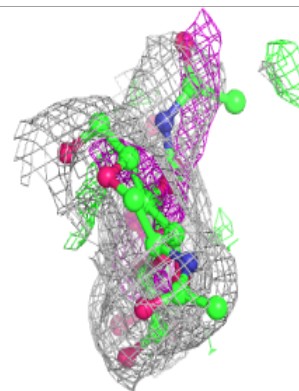
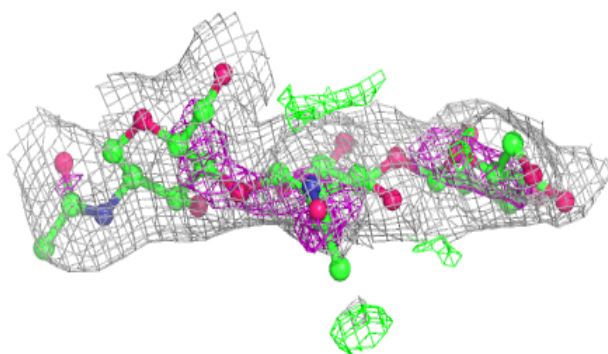
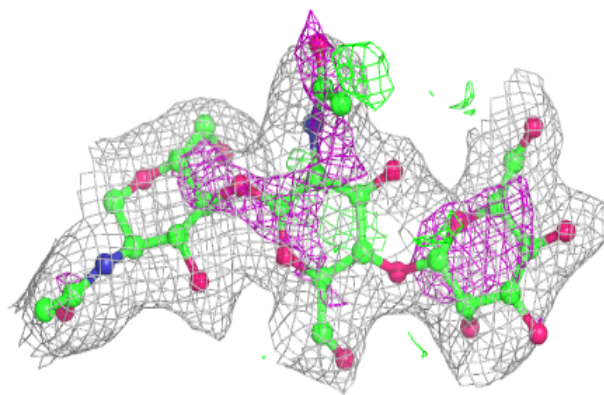
**Electron density around Chain I:**

$2mF_o-DF_c$ (at 0.7 rmsd) in gray
 mF_o-DF_c (at 3 rmsd) in purple (negative)
and green (positive)

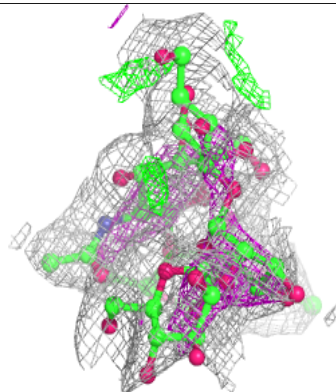
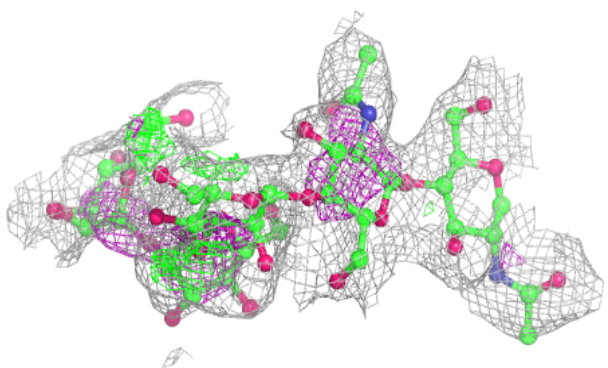
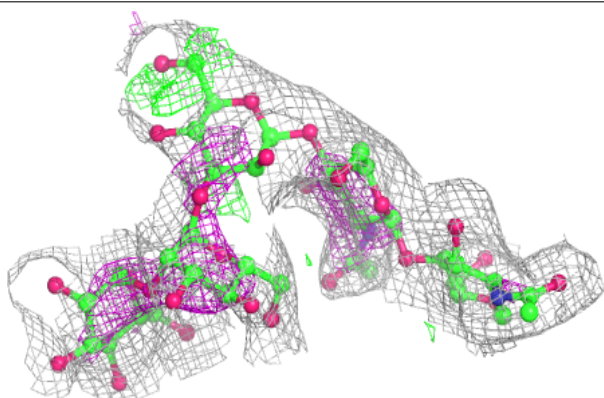

6.4 Ligands [i](#)

In the following table, the Atoms column lists the number of modelled atoms in the group and the number defined in the chemical component dictionary. The B-factors column lists the minimum, median, 95th percentile and maximum values of B factors of atoms in the group. The column labelled 'Q< 0.9' lists the number of atoms with occupancy less than 0.9.

Mol	Type	Chain	Res	Atoms	RSCC	RSR	B-factors(Å ²)	Q<0.9
10	MG	D	2001	1/1	0.74	0.10	23,23,23,23	0
8	NAG	D	3099	14/15	0.78	0.35	71,73,74,74	0
8	NAG	C	3015	14/15	0.81	0.27	51,55,55,56	0
10	MG	B	2001	1/1	0.82	0.10	23,23,23,23	0
8	NAG	C	3570	14/15	0.83	0.29	45,48,49,50	0
8	NAG	A	3570	14/15	0.86	0.24	35,38,39,39	14
7	CA	B	2002	1/1	0.88	0.10	34,34,34,34	0
7	CA	C	2008	1/1	0.90	0.15	14,14,14,14	0
8	NAG	A	3015	14/15	0.90	0.29	52,55,57,58	0
9	IMD	C	5001	5/5	0.91	0.18	52,52,52,52	0
7	CA	A	2007	1/1	0.91	0.21	20,20,20,20	0
7	CA	C	2005	1/1	0.91	0.22	41,41,41,41	0
7	CA	C	2006	1/1	0.92	0.16	29,29,29,29	0
9	IMD	C	5003	5/5	0.92	0.38	28,29,29,29	0
7	CA	A	2004	1/1	0.93	0.10	25,25,25,25	0
7	CA	A	2006	1/1	0.93	0.17	29,29,29,29	0
7	CA	C	2007	1/1	0.95	0.26	23,23,23,23	0
7	CA	A	2008	1/1	0.95	0.12	23,23,23,23	0
7	CA	D	2002	1/1	0.95	0.20	42,42,42,42	0
7	CA	B	2003	1/1	0.95	0.15	37,37,37,37	0
9	IMD	C	5004	5/5	0.96	0.35	47,48,48,48	0
9	IMD	C	960	5/5	0.96	0.16	33,33,34,34	0
9	IMD	A	5001	5/5	0.96	0.21	37,37,37,38	0
9	IMD	C	5002	5/5	0.97	0.16	21,21,21,22	0
7	CA	A	2005	1/1	0.98	0.21	17,17,17,17	0
7	CA	D	2003	1/1	0.98	0.17	26,26,26,26	0
7	CA	C	2004	1/1	0.98	0.21	29,29,29,29	0

6.5 Other polymers [i](#)

There are no such residues in this entry.