



wwPDB EM Validation Summary Report ⓘ

Nov 20, 2022 – 12:56 am GMT

PDB ID : 6FVW
EMDB ID : EMD-4322
Title : 26S proteasome, s4 state
Authors : Eisele, M.R.; Reed, R.G.; Rudack, T.; Schweitzer, A.; Beck, F.; Nagy, I.; Pfeifer, G.; Plitzko, J.M.; Baumeister, W.; Tomko, R.J.; Sakata, E.
Deposited on : 2018-03-05
Resolution : 4.50 Å(reported)

This is a wwPDB EM Validation Summary Report for a publicly released PDB entry.

We welcome your comments at validation@mail.wwpdb.org

A user guide is available at

<https://www.wwpdb.org/validation/2017/EMValidationReportHelp>

with specific help available everywhere you see the ⓘ symbol.

The types of validation reports are described at

<http://www.wwpdb.org/validation/2017/FAQs#types>.

The following versions of software and data (see [references ⓘ](#)) were used in the production of this report:

EMDB validation analysis : 0.0.1.dev43
Mogul : 1.8.4, CSD as541be (2020)
MolProbity : 4.02b-467
buster-report : 1.1.7 (2018)
Percentile statistics : 20191225.v01 (using entries in the PDB archive December 25th 2019)
MapQ : 1.9.9
Ideal geometry (proteins) : Engh & Huber (2001)
Ideal geometry (DNA, RNA) : Parkinson et al. (1996)
Validation Pipeline (wwPDB-VP) : 2.31.2

1 Overall quality at a glance i

The following experimental techniques were used to determine the structure:
ELECTRON MICROSCOPY

The reported resolution of this entry is 4.50 Å.

Percentile scores (ranging between 0-100) for global validation metrics of the entry are shown in the following graphic. The table shows the number of entries on which the scores are based.

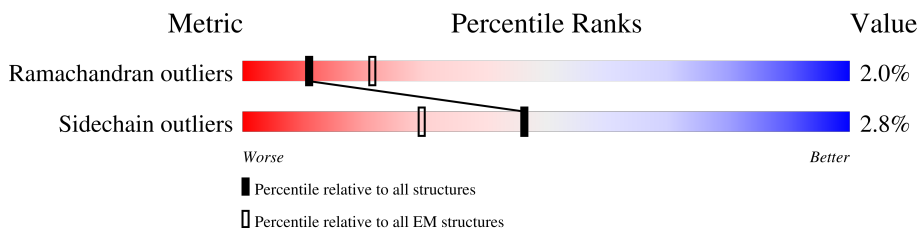











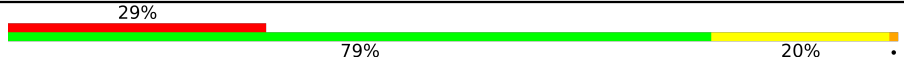
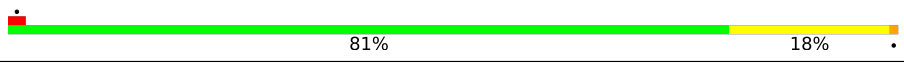
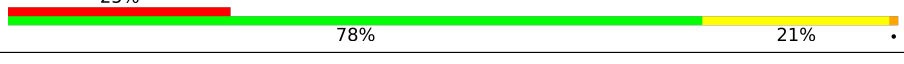

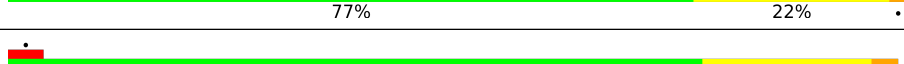
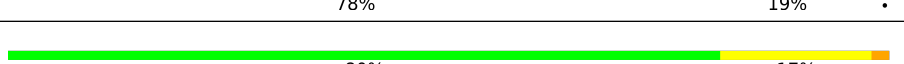
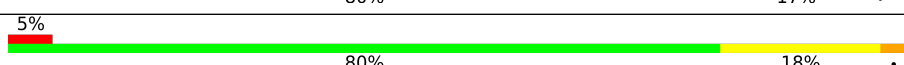
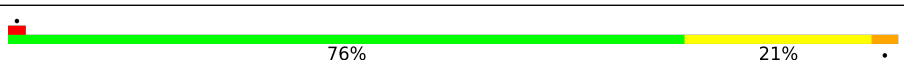

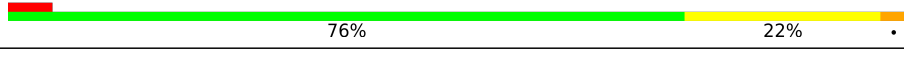
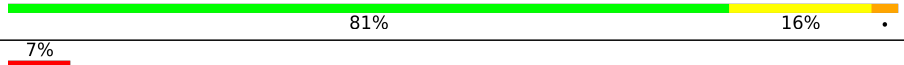

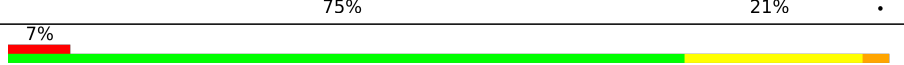
Metric	Whole archive (#Entries)	EM structures (#Entries)
Ramachandran outliers	154571	4023
Sidechain outliers	154315	3826

The table below summarises the geometric issues observed across the polymeric chains and their fit to the map. The red, orange, yellow and green segments of the bar indicate the fraction of residues that contain outliers for ≥ 3 , 2, 1 and 0 types of geometric quality criteria respectively. A grey segment represents the fraction of residues that are not modelled. The numeric value for each fraction is indicated below the corresponding segment, with a dot representing fractions $\leq 5\%$. The upper red bar (where present) indicates the fraction of residues that have poor fit to the EM map (all-atom inclusion $< 40\%$). The numeric value is given above the bar.

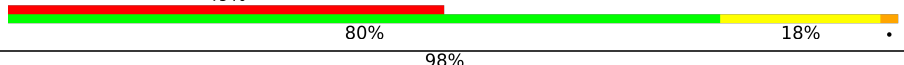
Mol	Chain	Length	Quality of chain
1	A	244	
1	a	244	
2	B	247	
2	b	247	
3	C	241	
3	c	241	
4	D	252	
4	d	252	
5	E	245	

Continued on next page...

Continued from previous page...

Mol	Chain	Length	Quality of chain
5	e	245	
6	F	232	
6	f	232	
7	G	245	
7	g	245	
8	1	196	
8	h	196	
9	2	226	
9	i	226	
10	3	204	
10	j	204	
11	4	195	
11	k	195	
12	5	212	
12	l	212	
13	6	222	
13	m	222	
14	7	232	
14	n	232	
15	W	197	
16	V	289	
17	T	266	
18	X	127	
19	Y	89	
20	Z	970	

Continued on next page...

Continued from previous page...

Mol	Chain	Length	Quality of chain
21	N	922	
22	S	475	
23	P	440	
24	Q	434	
25	R	405	
26	U	304	
27	O	388	
28	H	426	
29	I	385	
30	K	384	
31	L	388	
32	M	421	
33	J	403	

2 Entry composition [i](#)

There are 37 unique types of molecules in this entry. The entry contains 110594 atoms, of which 0 are hydrogens and 0 are deuteriums.

In the tables below, the AltConf column contains the number of residues with at least one atom in alternate conformation and the Trace column contains the number of residues modelled with at most 2 atoms.

- Molecule 1 is a protein called Proteasome subunit alpha type-1.

Mol	Chain	Residues	Atoms					AltConf	Trace
			Total	C	N	O	S		
1	a	244	Total	C	N	O	S	0	0
			1924	1223	323	370	8		
1	A	244	Total	C	N	O	S	0	0
			1924	1223	323	370	8		

- Molecule 2 is a protein called Proteasome subunit alpha type-2.

Mol	Chain	Residues	Atoms					AltConf	Trace
			Total	C	N	O	S		
2	b	247	Total	C	N	O	S	0	0
			1892	1206	312	371	3		
2	B	247	Total	C	N	O	S	0	0
			1892	1206	312	371	3		

- Molecule 3 is a protein called Proteasome subunit alpha type-3.

Mol	Chain	Residues	Atoms					AltConf	Trace
			Total	C	N	O	S		
3	c	241	Total	C	N	O	S	0	0
			1884	1190	315	376	3		
3	C	241	Total	C	N	O	S	0	0
			1884	1190	315	376	3		

- Molecule 4 is a protein called Proteasome subunit alpha type-4.

Mol	Chain	Residues	Atoms					AltConf	Trace
			Total	C	N	O	S		
4	d	252	Total	C	N	O	S	0	0
			1986	1237	351	394	4		
4	D	252	Total	C	N	O	S	0	0
			1986	1237	351	394	4		

- Molecule 5 is a protein called Proteasome subunit alpha type-5.

Mol	Chain	Residues	Atoms					AltConf	Trace
5	e	245	Total	C	N	O	S	0	0
			1889	1179	317	386	7		
5	E	245	Total	C	N	O	S	0	0
			1889	1179	317	386	7		

- Molecule 6 is a protein called Proteasome subunit alpha type-6.

Mol	Chain	Residues	Atoms					AltConf	Trace
6	f	232	Total	C	N	O	S	0	0
			1784	1120	311	349	4		
6	F	232	Total	C	N	O	S	0	0
			1784	1120	311	349	4		

- Molecule 7 is a protein called Probable proteasome subunit alpha type-7.

Mol	Chain	Residues	Atoms					AltConf	Trace
7	g	245	Total	C	N	O	S	0	0
			1905	1211	331	359	4		
7	G	245	Total	C	N	O	S	0	0
			1905	1211	331	359	4		

- Molecule 8 is a protein called Proteasome subunit beta type-1.

Mol	Chain	Residues	Atoms					AltConf	Trace
8	h	196	Total	C	N	O	S	0	0
			1512	955	250	300	7		
8	1	196	Total	C	N	O	S	0	0
			1512	955	250	300	7		

- Molecule 9 is a protein called Proteasome subunit beta type-2.

Mol	Chain	Residues	Atoms					AltConf	Trace
9	i	226	Total	C	N	O	S	0	0
			1720	1082	298	333	7		
9	2	226	Total	C	N	O	S	0	0
			1720	1082	298	333	7		

- Molecule 10 is a protein called Proteasome subunit beta type-3.

Mol	Chain	Residues	Atoms					AltConf	Trace
10	j	204	Total	C	N	O	S	0	0
			1581	1010	258	305	8		

Continued on next page...

Continued from previous page...

Mol	Chain	Residues	Atoms					AltConf	Trace
10	3	204	Total	C	N	O	S	0	0
			1581	1010	258	305	8		

- Molecule 11 is a protein called Proteasome subunit beta type-4.

Mol	Chain	Residues	Atoms					AltConf	Trace
11	k	195	Total	C	N	O	S	0	0
			1562	992	264	300	6		
11	4	195	Total	C	N	O	S	0	0
			1562	992	264	300	6		

- Molecule 12 is a protein called Proteasome subunit beta type-5.

Mol	Chain	Residues	Atoms					AltConf	Trace
12	1	212	Total	C	N	O	S	0	0
			1644	1045	280	312	7		
12	5	212	Total	C	N	O	S	0	0
			1644	1045	280	312	7		

- Molecule 13 is a protein called Proteasome subunit beta type-6.

Mol	Chain	Residues	Atoms					AltConf	Trace
13	m	222	Total	C	N	O	S	0	0
			1757	1115	303	335	4		
13	6	222	Total	C	N	O	S	0	0
			1757	1115	303	335	4		

- Molecule 14 is a protein called Proteasome subunit beta type-7.

Mol	Chain	Residues	Atoms					AltConf	Trace
14	n	232	Total	C	N	O	S	0	0
			1816	1148	311	350	7		
14	7	229	Total	C	N	O	S	0	0
			1790	1133	306	344	7		

- Molecule 15 is a protein called 26S proteasome regulatory subunit RPN10.

Mol	Chain	Residues	Atoms					AltConf	Trace
15	W	197	Total	C	N	O	S	0	0
			1535	962	269	301	3		

- Molecule 16 is a protein called Ubiquitin carboxyl-terminal hydrolase RPN11.

Mol	Chain	Residues	Atoms					AltConf	Trace
			Total	C	N	O	S		
16	V	289	2274	1425	389	446	14	0	0

- Molecule 17 is a protein called 26S proteasome regulatory subunit RPN12.

Mol	Chain	Residues	Atoms					AltConf	Trace
			Total	C	N	O	S		
17	T	266	2193	1405	349	433	6	0	0

- Molecule 18 is a protein called 26S proteasome regulatory subunit RPN13.

Mol	Chain	Residues	Atoms					AltConf	Trace
			Total	C	N	O	S		
18	X	127	1033	664	169	196	4	0	0

- Molecule 19 is a protein called 26S proteasome complex subunit SEM1.

Mol	Chain	Residues	Atoms					AltConf	Trace
			Total	C	N	O	S		
19	Y	89	731	447	119	164	1	0	0

- Molecule 20 is a protein called 26S proteasome regulatory subunit RPN1.

Mol	Chain	Residues	Atoms					AltConf	Trace
			Total	C	N	O	S		
20	Z	906	7005	4416	1150	1409	30	0	0

- Molecule 21 is a protein called 26S proteasome regulatory subunit RPN2.

Mol	Chain	Residues	Atoms					AltConf	Trace
			Total	C	N	O	S		
21	N	922	7158	4536	1205	1389	28	0	0

- Molecule 22 is a protein called 26S proteasome regulatory subunit RPN3.

Mol	Chain	Residues	Atoms					AltConf	Trace
			Total	C	N	O	S		
22	S	475	3895	2488	653	739	15	0	0

- Molecule 23 is a protein called 26S proteasome regulatory subunit RPN5.

Mol	Chain	Residues	Atoms					AltConf	Trace
			Total	C	N	O	S		
23	P	440	3609	2297	604	698	10	0	0

- Molecule 24 is a protein called 26S proteasome regulatory subunit RPN6.

Mol	Chain	Residues	Atoms					AltConf	Trace
			Total	C	N	O	S		
24	Q	434	3499	2225	577	681	16	0	0

- Molecule 25 is a protein called 26S proteasome regulatory subunit RPN7.

Mol	Chain	Residues	Atoms					AltConf	Trace
			Total	C	N	O	S		
25	R	405	3259	2077	535	637	10	0	0

- Molecule 26 is a protein called 26S proteasome regulatory subunit RPN8.

Mol	Chain	Residues	Atoms					AltConf	Trace
			Total	C	N	O	S		
26	U	304	2427	1529	414	477	7	0	0

- Molecule 27 is a protein called 26S proteasome regulatory subunit RPN9.

Mol	Chain	Residues	Atoms					AltConf	Trace
			Total	C	N	O	S		
27	O	388	3186	2051	519	608	8	0	0

- Molecule 28 is a protein called 26S proteasome regulatory subunit 7 homolog.

Mol	Chain	Residues	Atoms					AltConf	Trace
			Total	C	N	O	S		
28	H	426	3313	2056	592	648	17	0	0

- Molecule 29 is a protein called 26S proteasome regulatory subunit 4 homolog.

Mol	Chain	Residues	Atoms					AltConf	Trace
			Total	C	N	O	S		
29	I	385	3022	1899	508	598	17	0	0

- Molecule 30 is a protein called 26S proteasome regulatory subunit 6B homolog.

Mol	Chain	Residues	Atoms					AltConf	Trace
			Total	C	N	O	S		
30	K	384	3041	1911	533	587	10	0	0

- Molecule 31 is a protein called 26S proteasome subunit RPT4.

Mol	Chain	Residues	Atoms					AltConf	Trace
			Total	C	N	O	S		
31	L	388	3083	1942	548	581	12	0	0

- Molecule 32 is a protein called 26S proteasome regulatory subunit 6A.

Mol	Chain	Residues	Atoms					AltConf	Trace
			Total	C	N	O	S		
32	M	421	3285	2043	573	656	13	0	0

- Molecule 33 is a protein called 26S proteasome regulatory subunit 8 homolog.

Mol	Chain	Residues	Atoms					AltConf	Trace
			Total	C	N	O	S		
33	J	403	3156	1986	563	590	17	0	0

- Molecule 34 is ADENOSINE-5'-TRIPHOSPHATE (three-letter code: ATP) (formula: $C_{10}H_{16}N_5O_{13}P_3$).

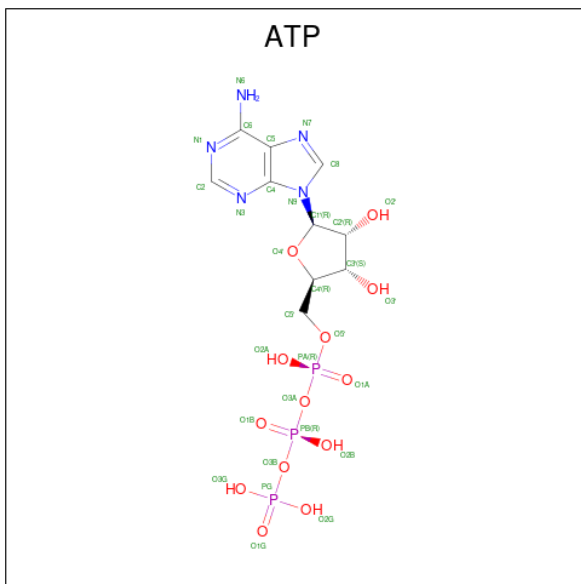

Mol	Chain	Residues	Atoms					AltConf
			Total	C	N	O	P	
34	H	1	31	10	5	13	3	0

Continued on next page...

Continued from previous page...

Mol	Chain	Residues	Atoms				AltConf	
			Total	C	N	O		P
34	I	1	Total 31	C 10	N 5	O 13	P 3	0
34	M	1	Total 31	C 10	N 5	O 13	P 3	0
34	J	1	Total 31	C 10	N 5	O 13	P 3	0

- Molecule 35 is MAGNESIUM ION (three-letter code: MG) (formula: Mg).

Mol	Chain	Residues	Atoms		AltConf
			Total	Mg	
35	H	1	Total 1	Mg 1	0
35	I	1	Total 1	Mg 1	0
35	K	1	Total 1	Mg 1	0
35	L	1	Total 1	Mg 1	0
35	M	1	Total 1	Mg 1	0
35	J	1	Total 1	Mg 1	0

- Molecule 36 is ADENOSINE-5'-DIPHOSPHATE (three-letter code: ADP) (formula: $C_{10}H_{15}N_5O_{10}P_2$).

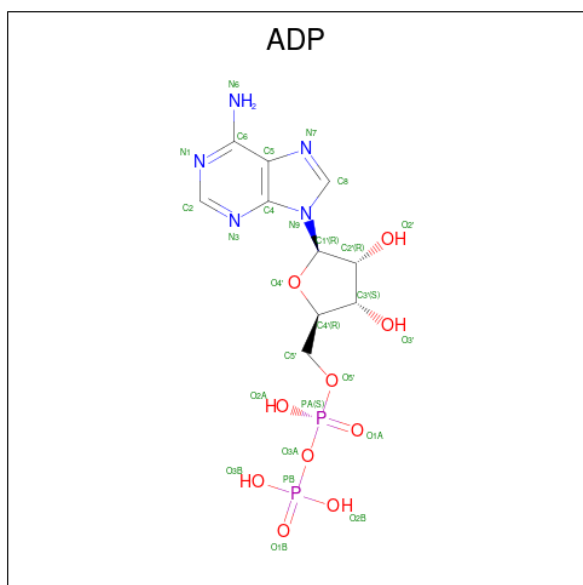

Mol	Chain	Residues	Atoms					AltConf
36	K	1	Total	C	N	O	P	0
			27	10	5	10	2	
36	L	1	Total	C	N	O	P	0
			27	10	5	10	2	

- Molecule 37 is water.

Mol	Chain	Residues	Atoms		AltConf
37	H	3	Total	O	0
			3	3	
37	I	3	Total	O	0
			3	3	
37	K	4	Total	O	0
			4	4	
37	L	4	Total	O	0
			4	4	
37	M	3	Total	O	0
			3	3	
37	J	3	Total	O	0
			3	3	

3 Residue-property plots [i](#)

These plots are drawn for all protein, RNA, DNA and oligosaccharide chains in the entry. The first graphic for a chain summarises the proportions of the various outlier classes displayed in the second graphic. The second graphic shows the sequence view annotated by issues in geometry and atom inclusion in map density. Residues are color-coded according to the number of geometric quality criteria for which they contain at least one outlier: green = 0, yellow = 1, orange = 2 and red = 3 or more. A red diamond above a residue indicates a poor fit to the EM map for this residue (all-atom inclusion < 40%). Stretches of 2 or more consecutive residues without any outlier are shown as a green connector. Residues present in the sample, but not in the model, are shown in grey.

- Molecule 1: Proteasome subunit alpha type-1

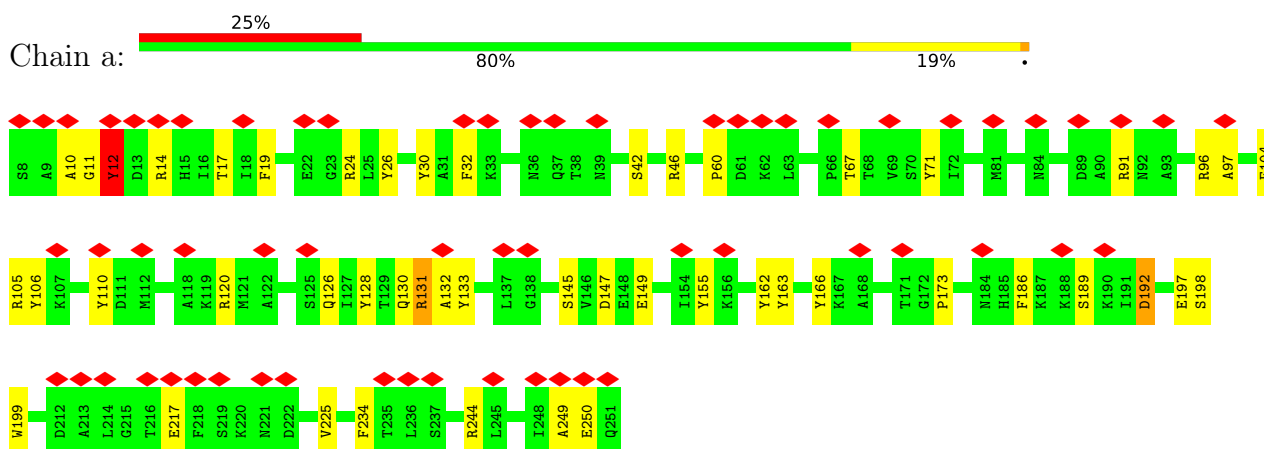

- Molecule 1: Proteasome subunit alpha type-1

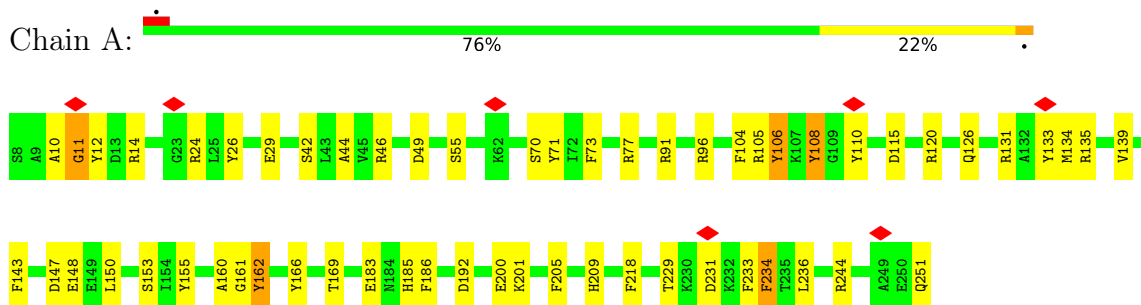

- Molecule 2: Proteasome subunit alpha type-2

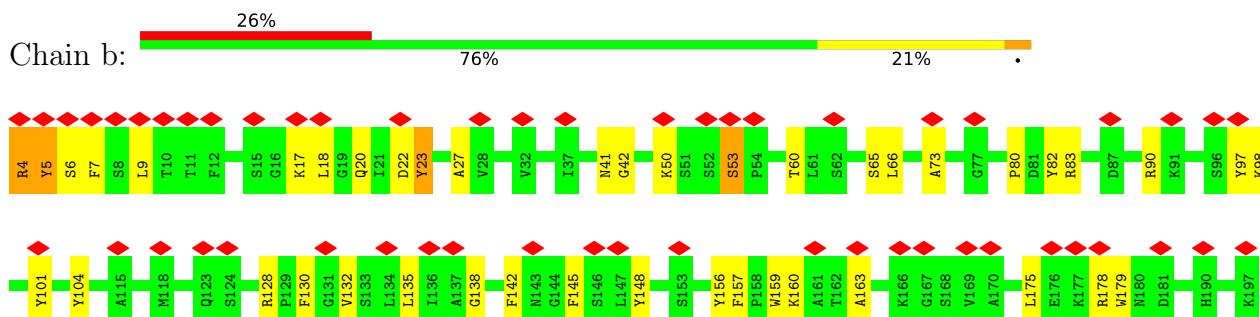

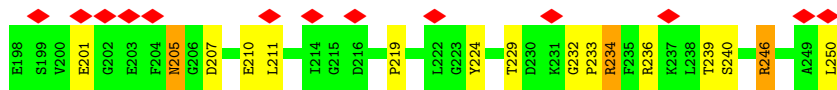

• Molecule 2: Proteasome subunit alpha type-2

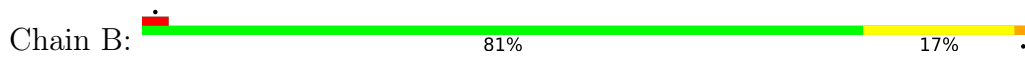

• Molecule 3: Proteasome subunit alpha type-3

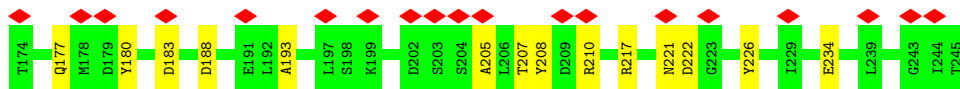
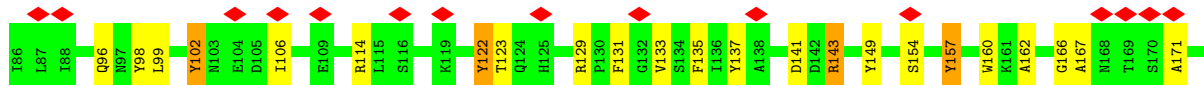
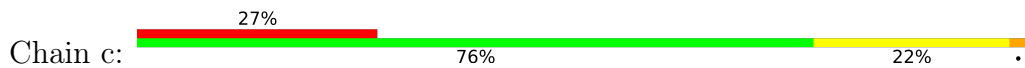

• Molecule 3: Proteasome subunit alpha type-3

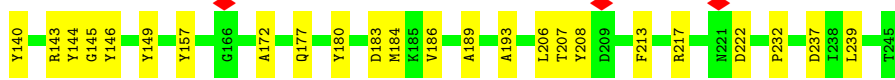
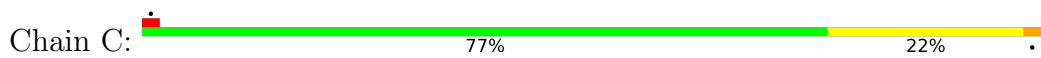

• Molecule 4: Proteasome subunit alpha type-4

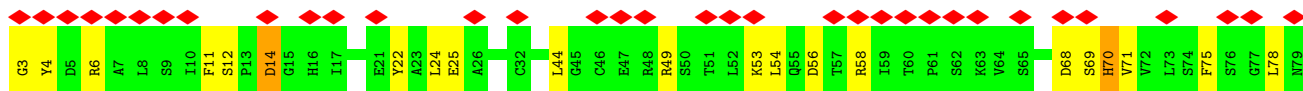

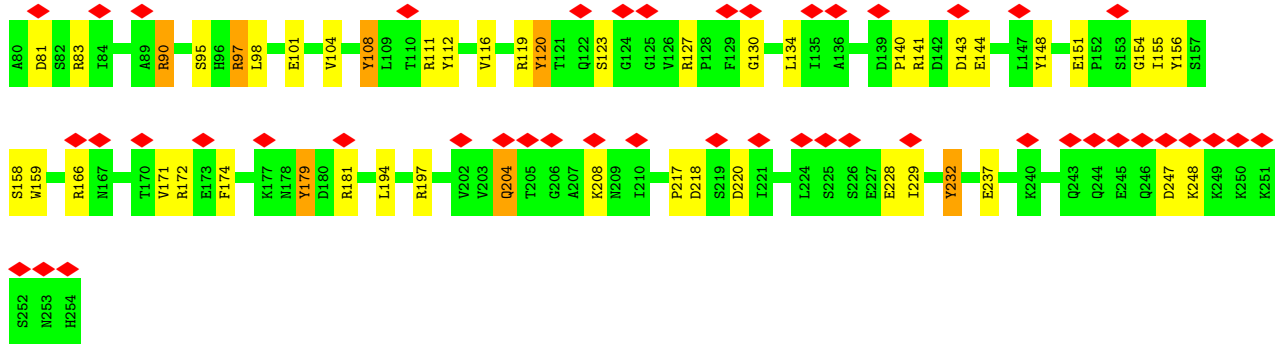

• Molecule 4: Proteasome subunit alpha type-4

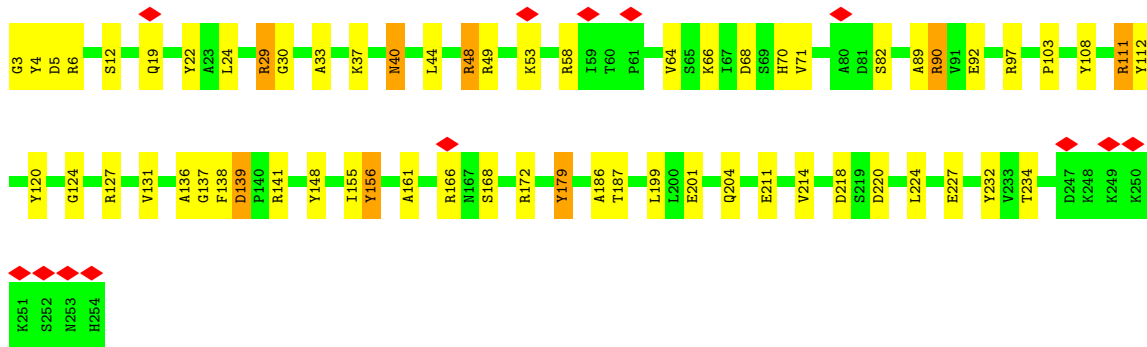
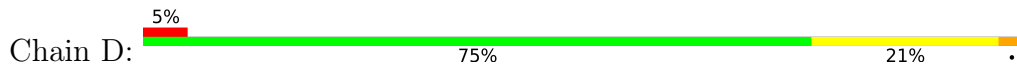

• Molecule 5: Proteasome subunit alpha type-5

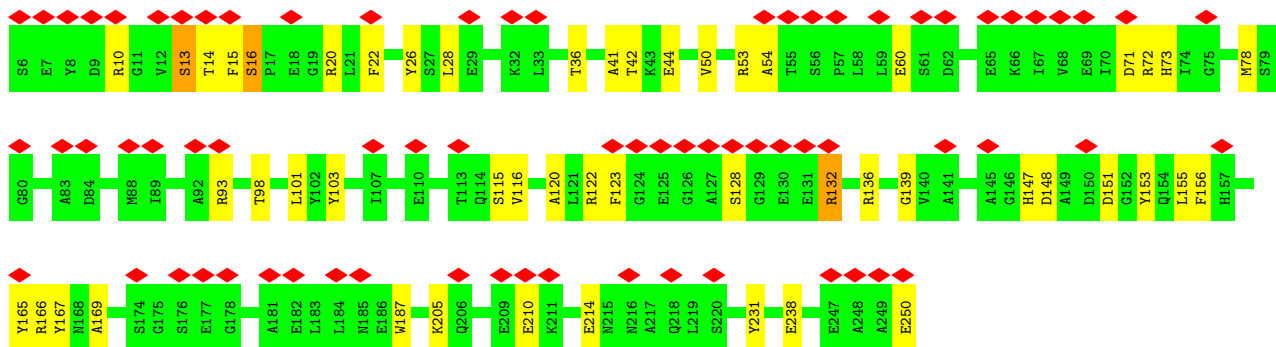
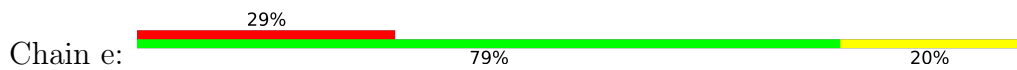

• Molecule 5: Proteasome subunit alpha type-5

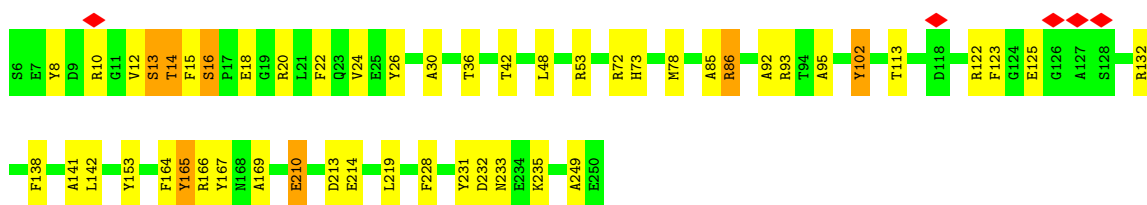
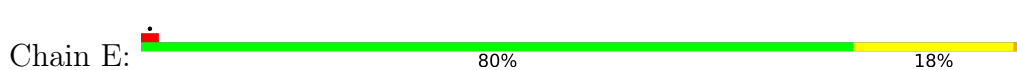

• Molecule 6: Proteasome subunit alpha type-6

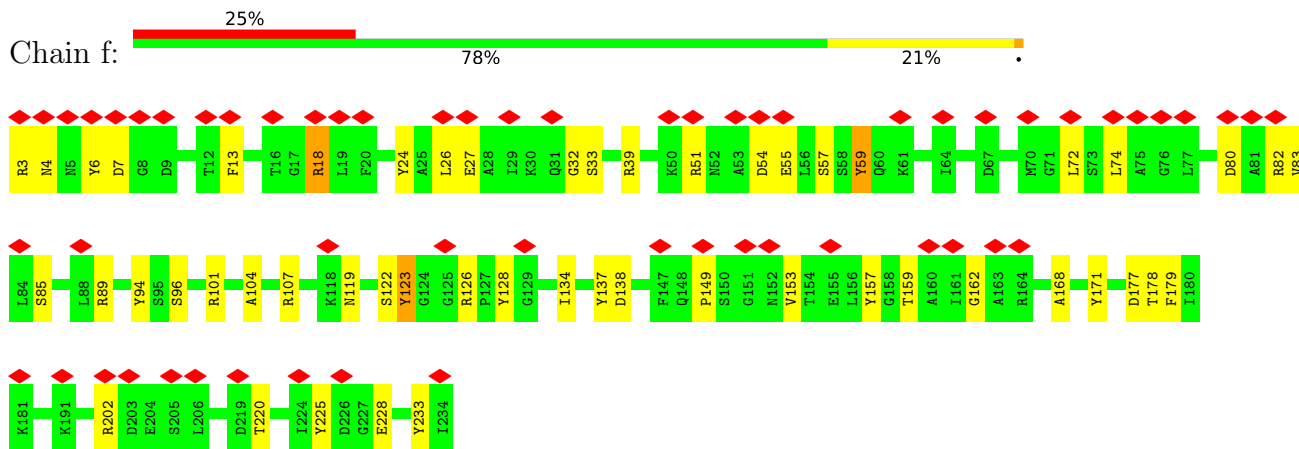

• Molecule 6: Proteasome subunit alpha type-6

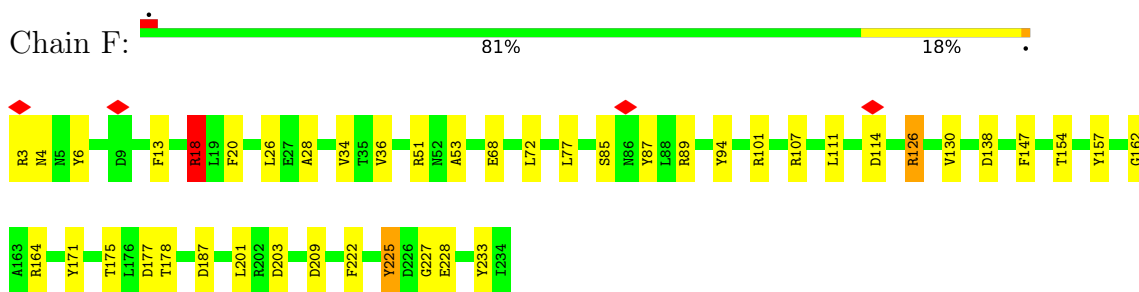

• Molecule 7: Probable proteasome subunit alpha type-7

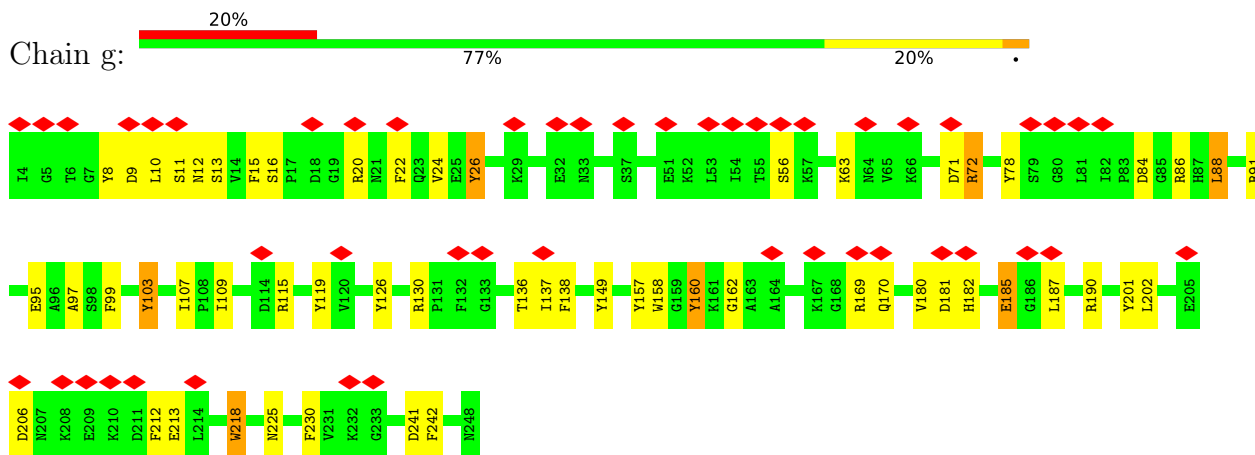

• Molecule 7: Probable proteasome subunit alpha type-7

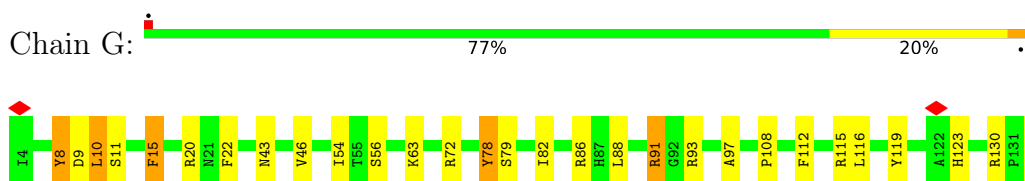



• Molecule 8: Proteasome subunit beta type-1

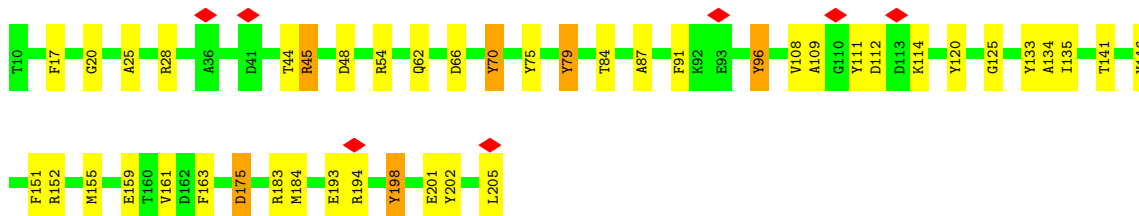
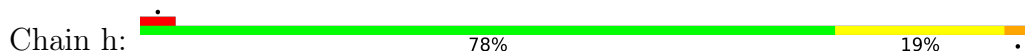

• Molecule 8: Proteasome subunit beta type-1

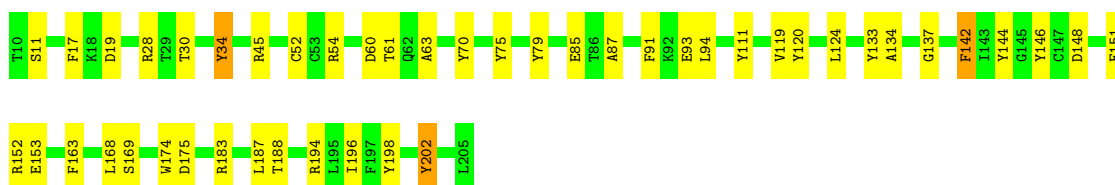
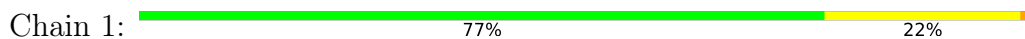

• Molecule 9: Proteasome subunit beta type-2

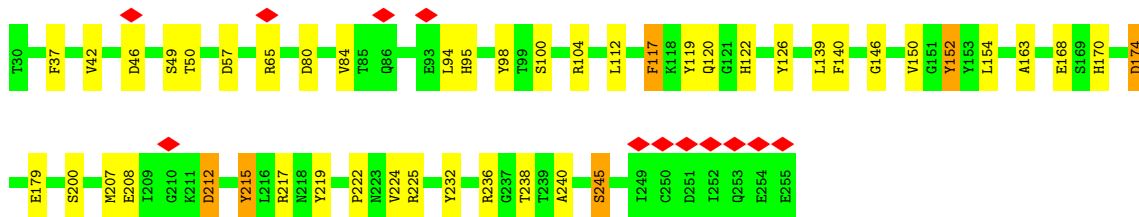
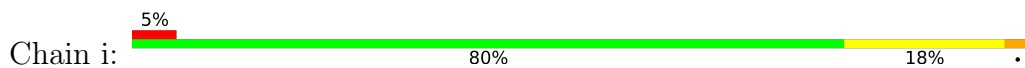

• Molecule 9: Proteasome subunit beta type-2

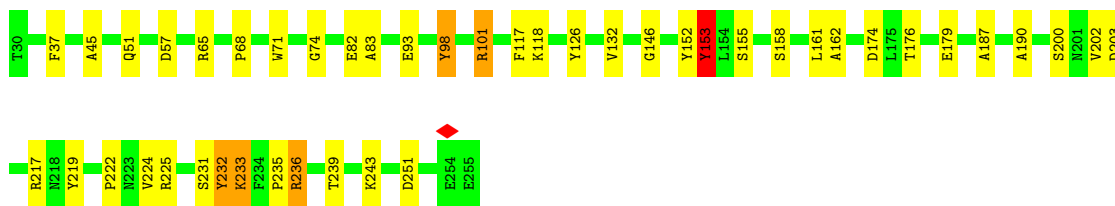
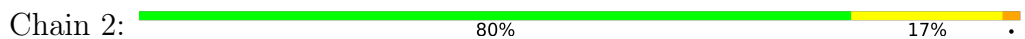

• Molecule 10: Proteasome subunit beta type-3

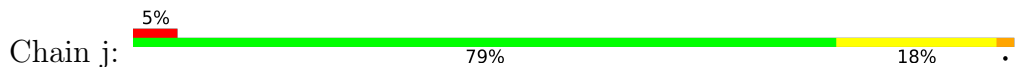

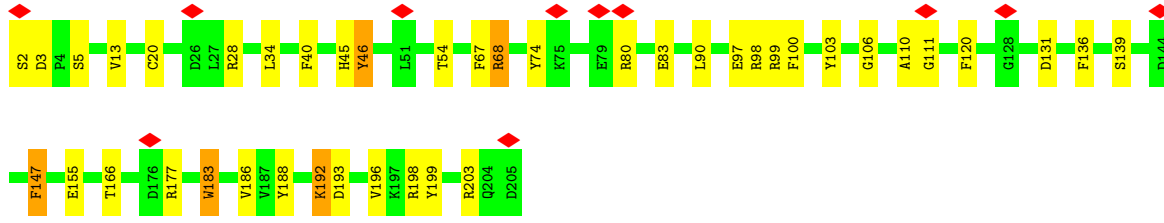

• Molecule 10: Proteasome subunit beta type-3

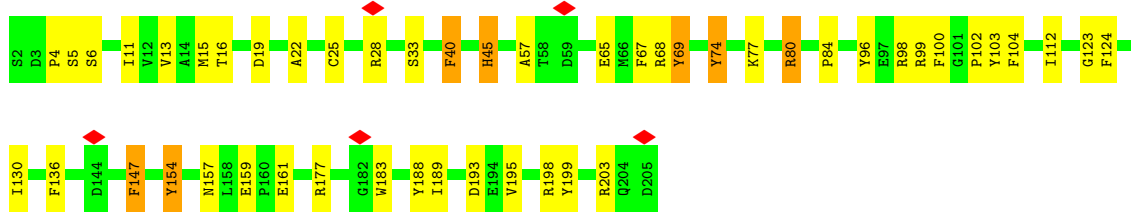
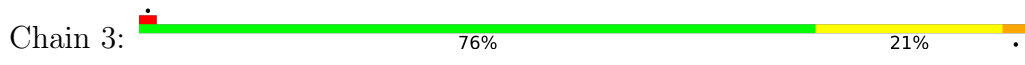

• Molecule 11: Proteasome subunit beta type-4

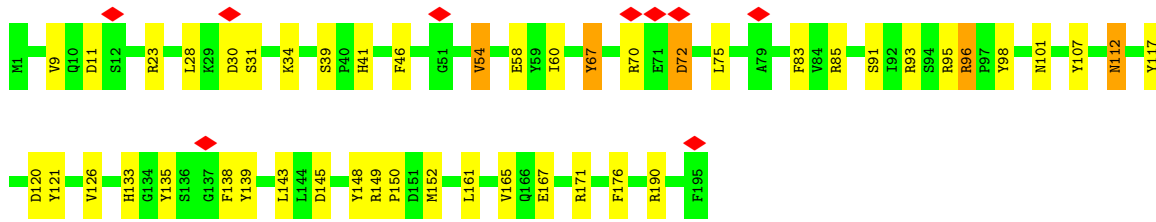
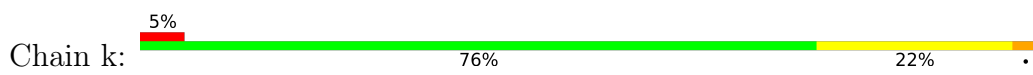

• Molecule 11: Proteasome subunit beta type-4

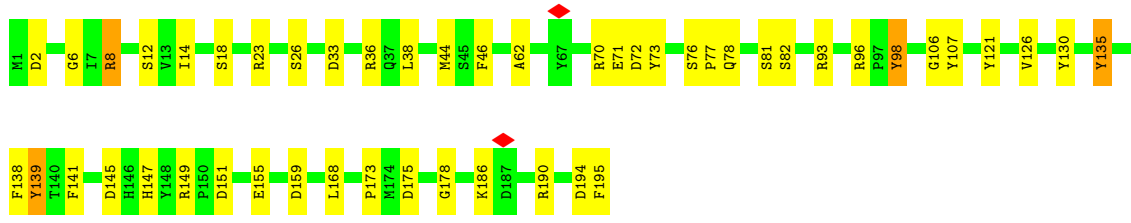
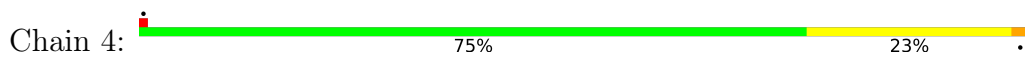

• Molecule 12: Proteasome subunit beta type-5

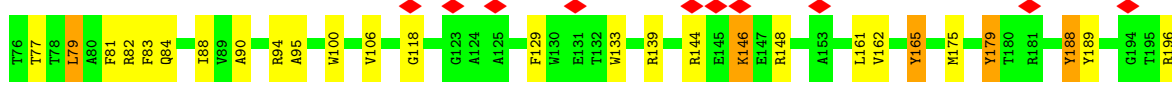
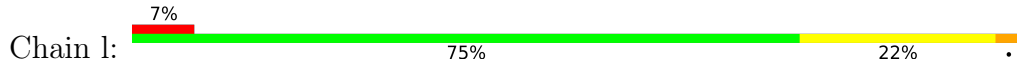

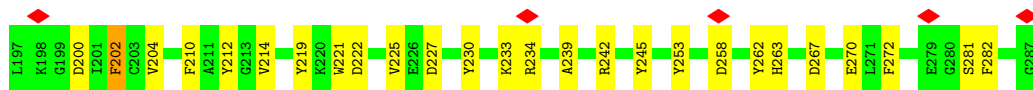

• Molecule 12: Proteasome subunit beta type-5

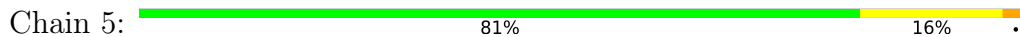

• Molecule 13: Proteasome subunit beta type-6

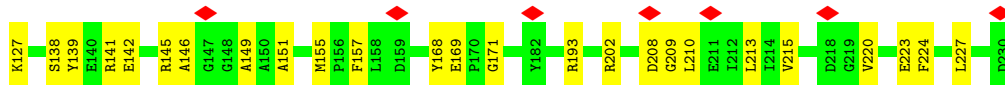
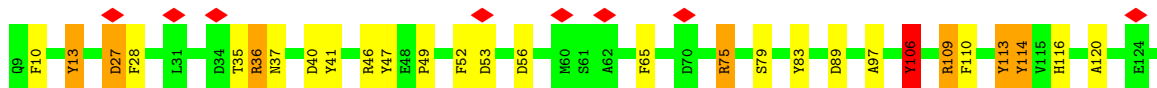
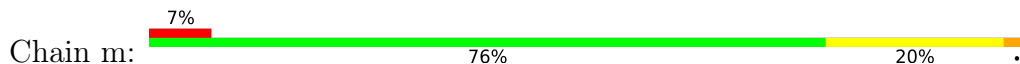

• Molecule 13: Proteasome subunit beta type-6

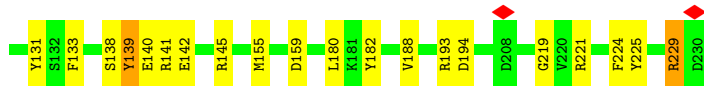
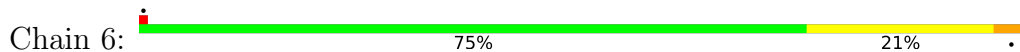

• Molecule 14: Proteasome subunit beta type-7

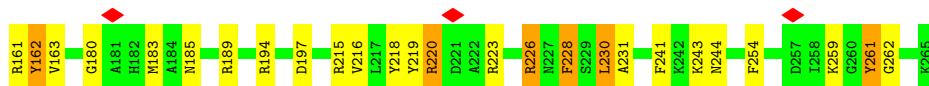
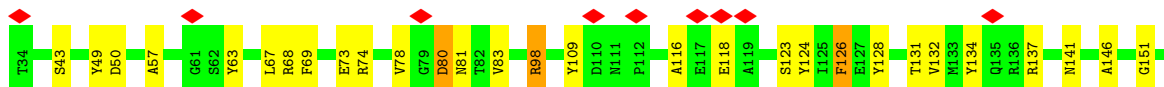
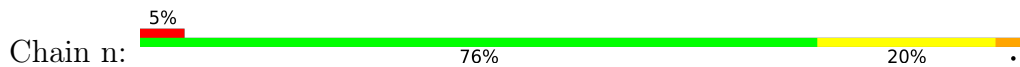

• Molecule 14: Proteasome subunit beta type-7

Chain 7:  75% 19%

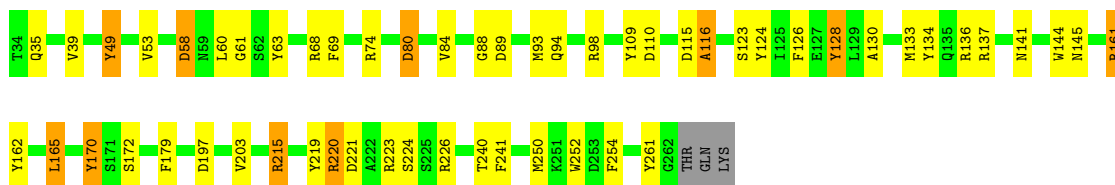

• Molecule 15: 26S proteasome regulatory subunit RPN10

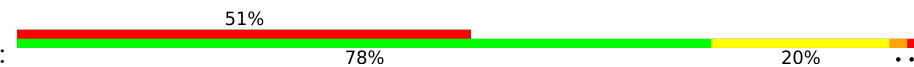
Chain W:  51% 78% 20%

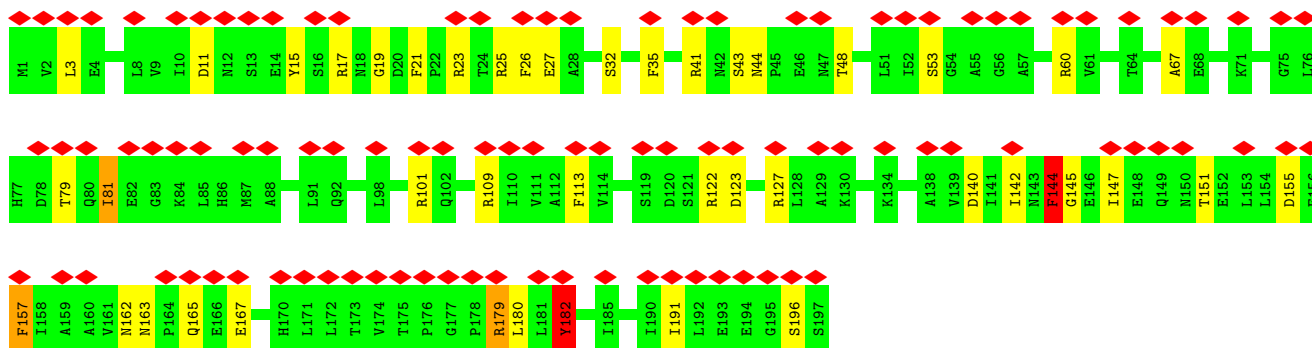

• Molecule 16: Ubiquitin carboxyl-terminal hydrolase RPN11

Chain V:  20% 81% 16%

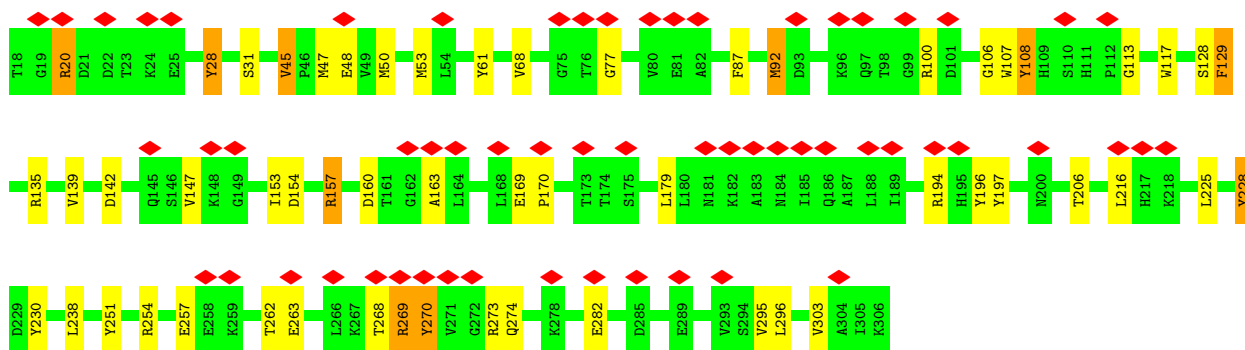

• Molecule 17: 26S proteasome regulatory subunit RPN12

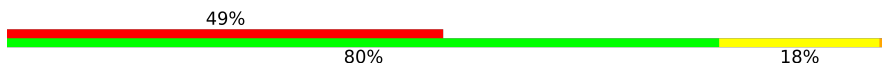
Chain T:  49% 80% 18%

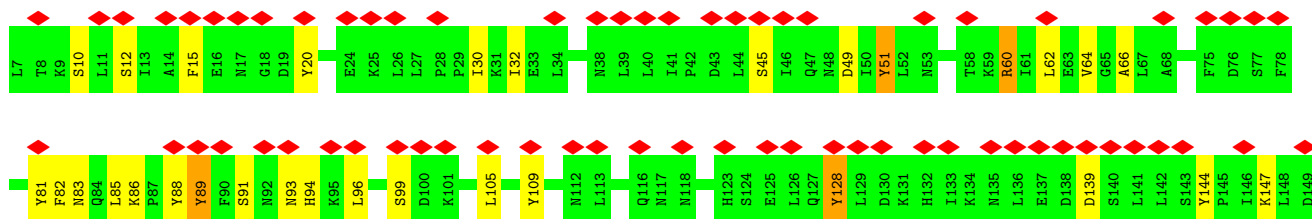

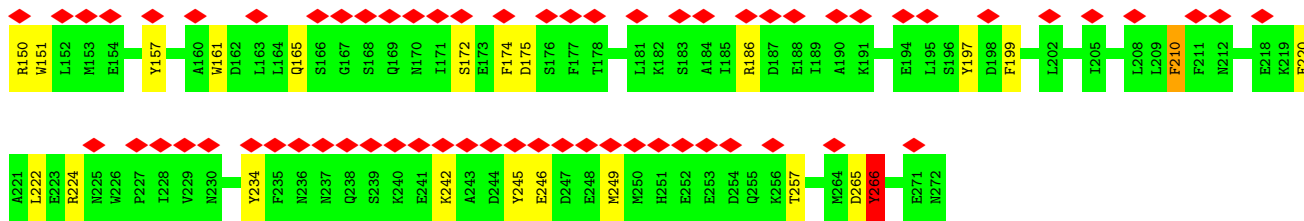

• Molecule 18: 26S proteasome regulatory subunit RPN13

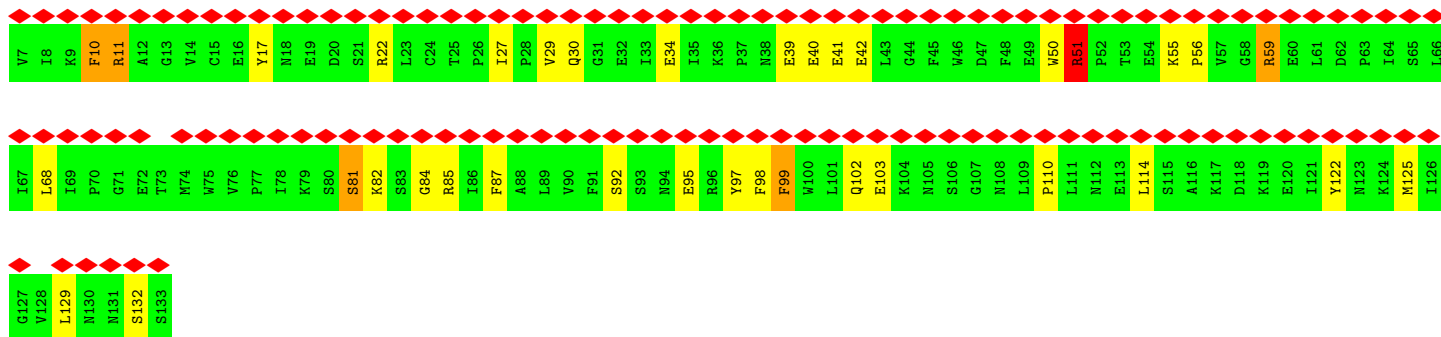
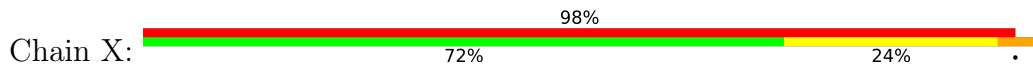

• Molecule 19: 26S proteasome complex subunit SEM1

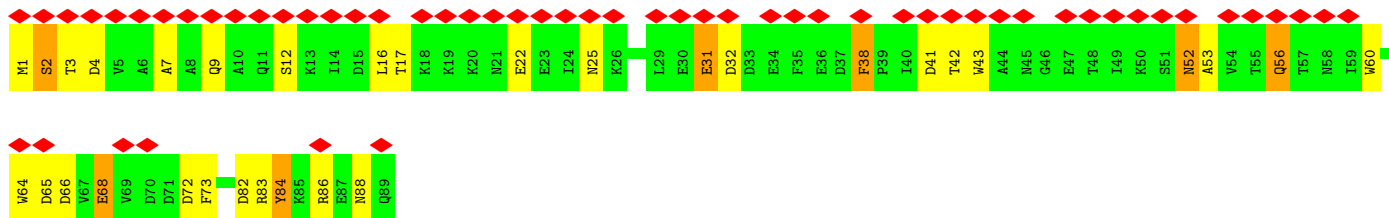

• Molecule 20: 26S proteasome regulatory subunit RPN1

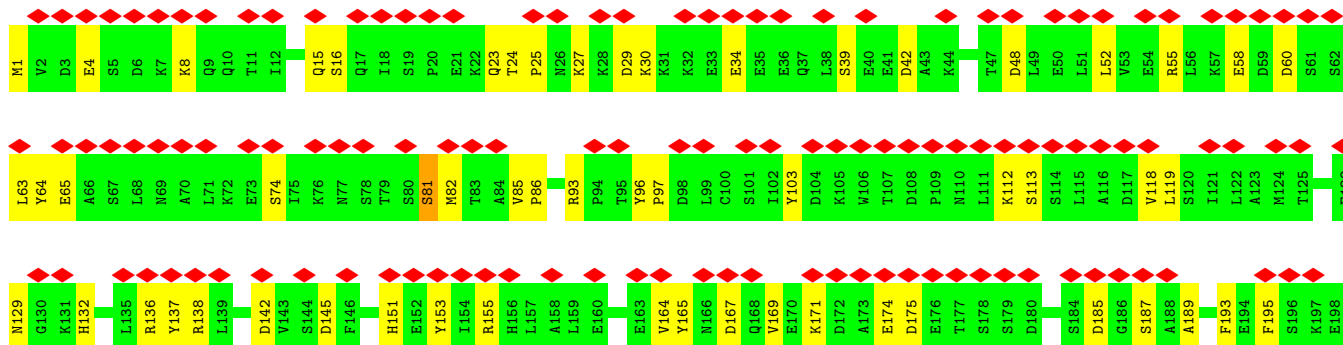

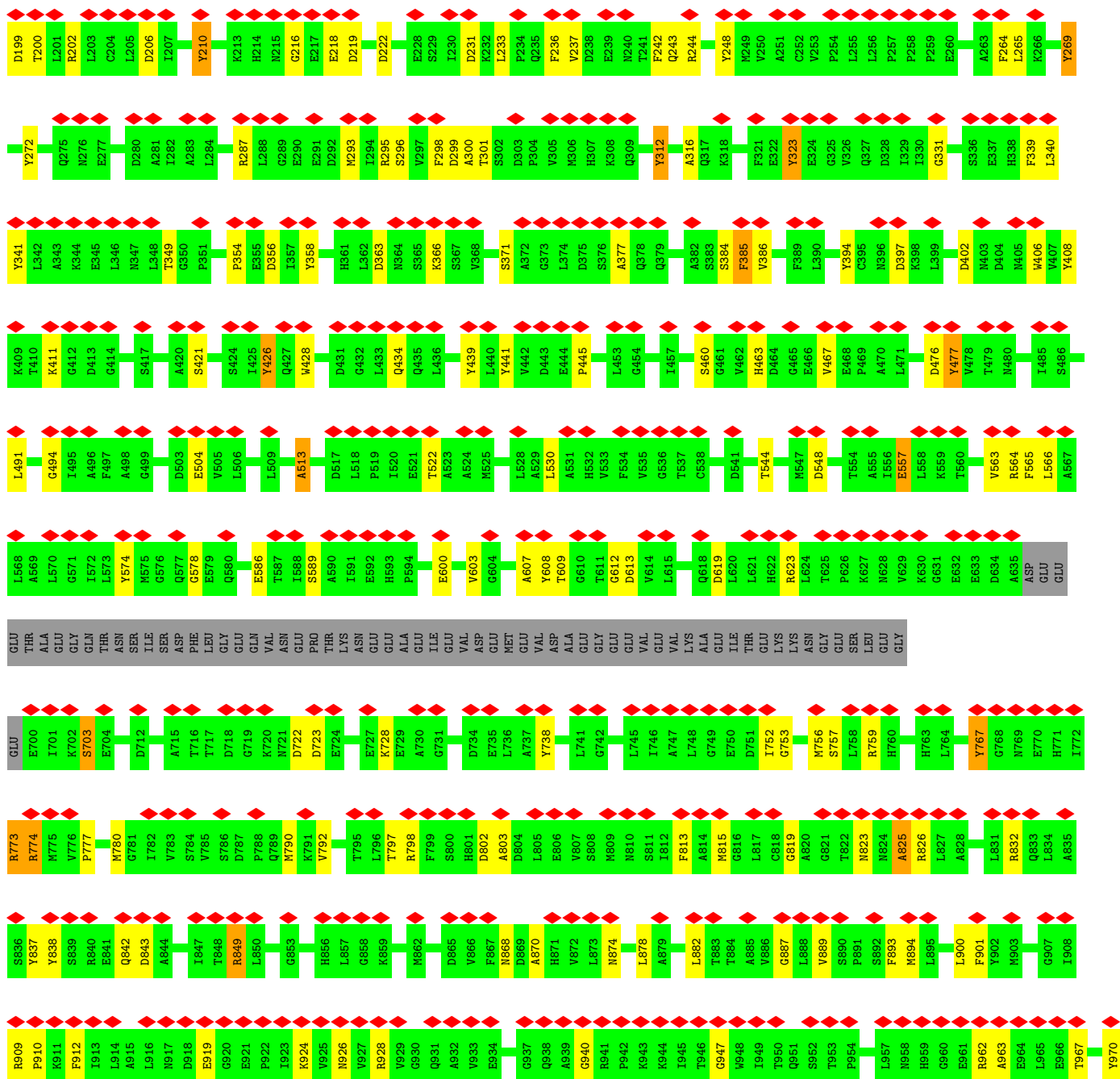

• Molecule 21: 26S proteasome regulatory subunit RPN2

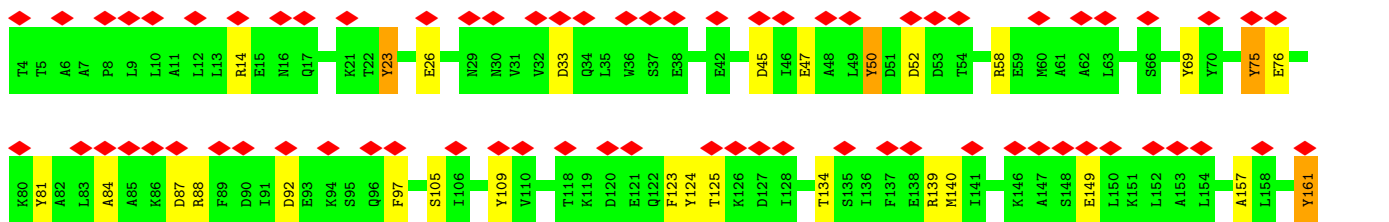
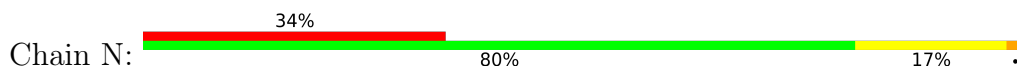

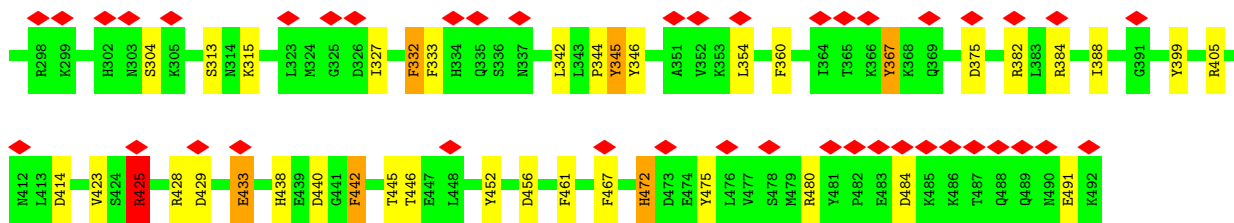

• Molecule 23: 26S proteasome regulatory subunit RPN5

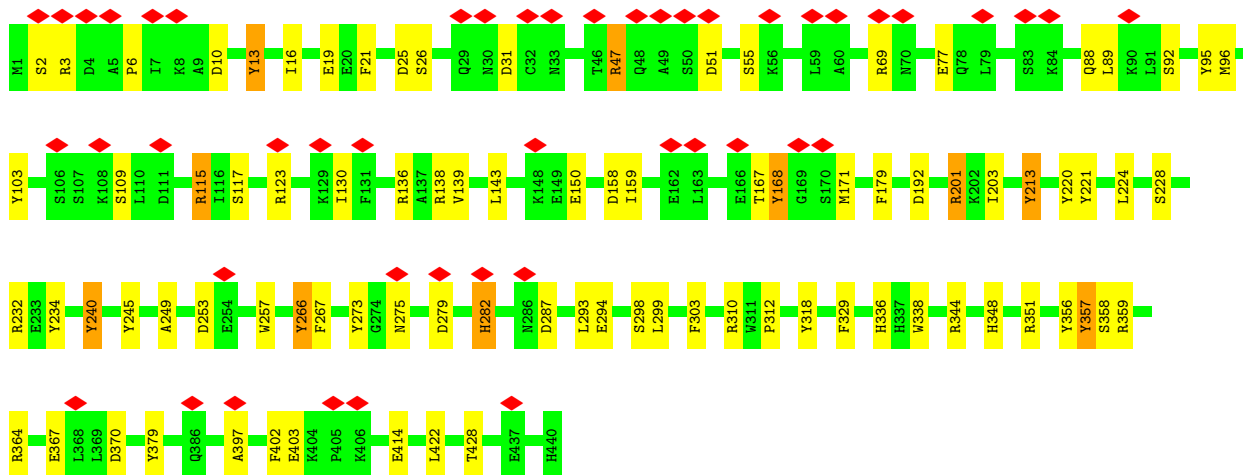
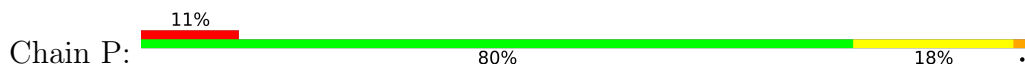

• Molecule 24: 26S proteasome regulatory subunit RPN6

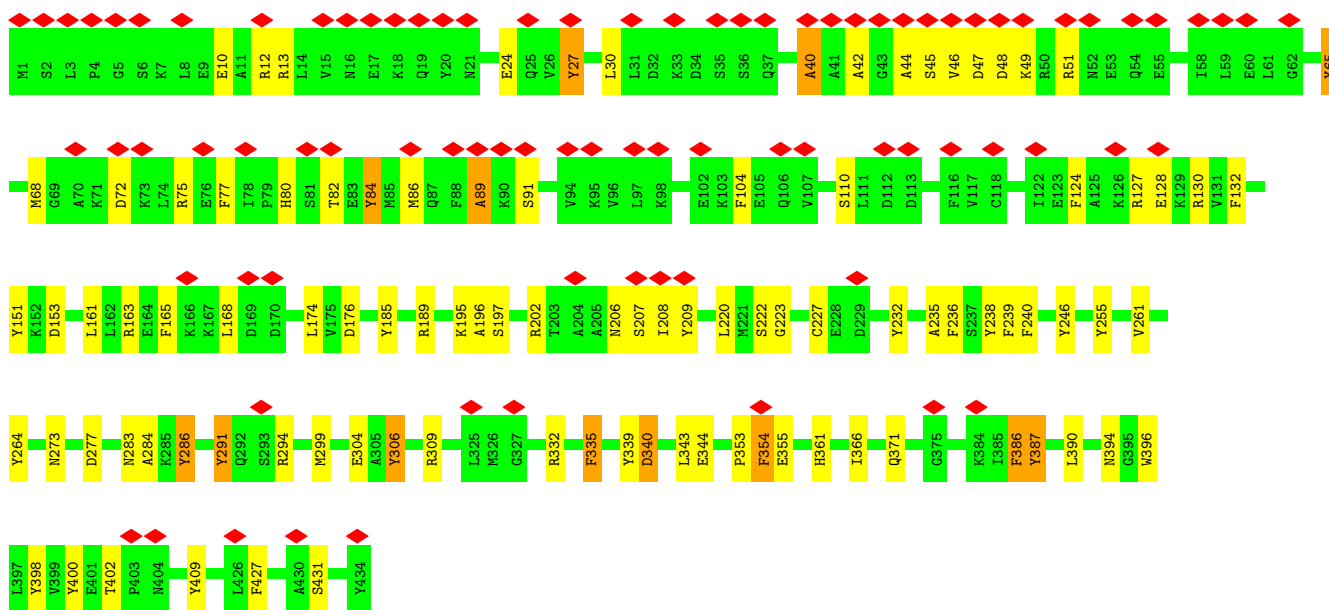
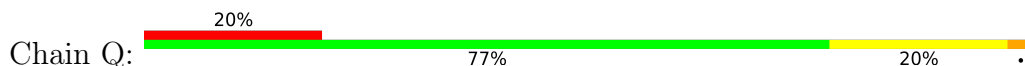

• Molecule 25: 26S proteasome regulatory subunit RPN7

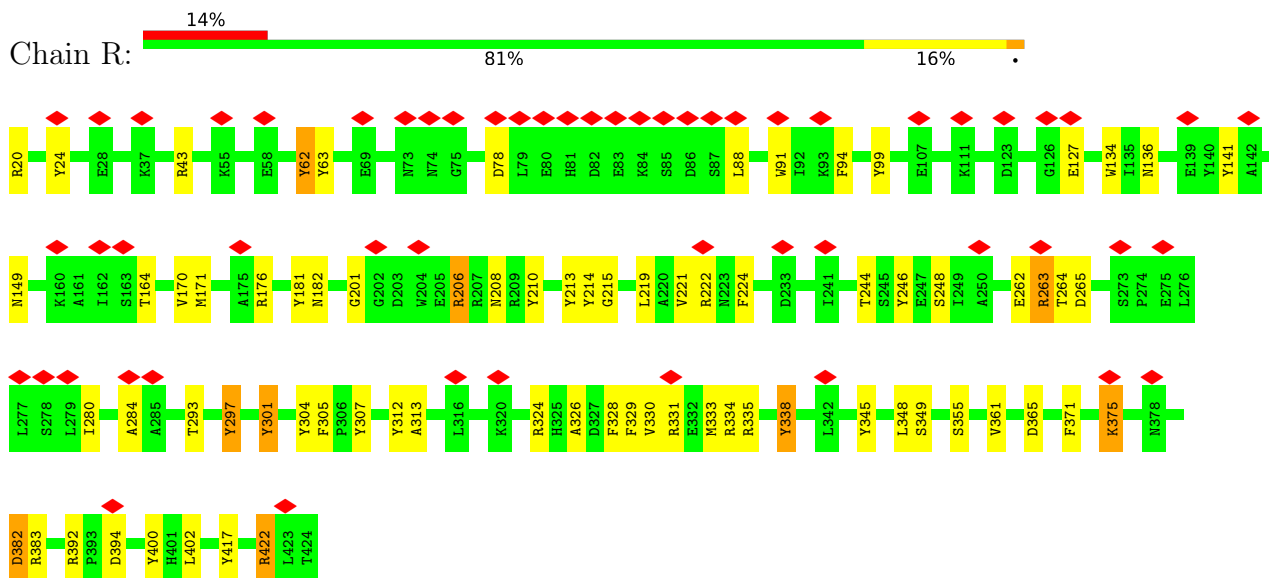

• Molecule 26: 26S proteasome regulatory subunit RPN8

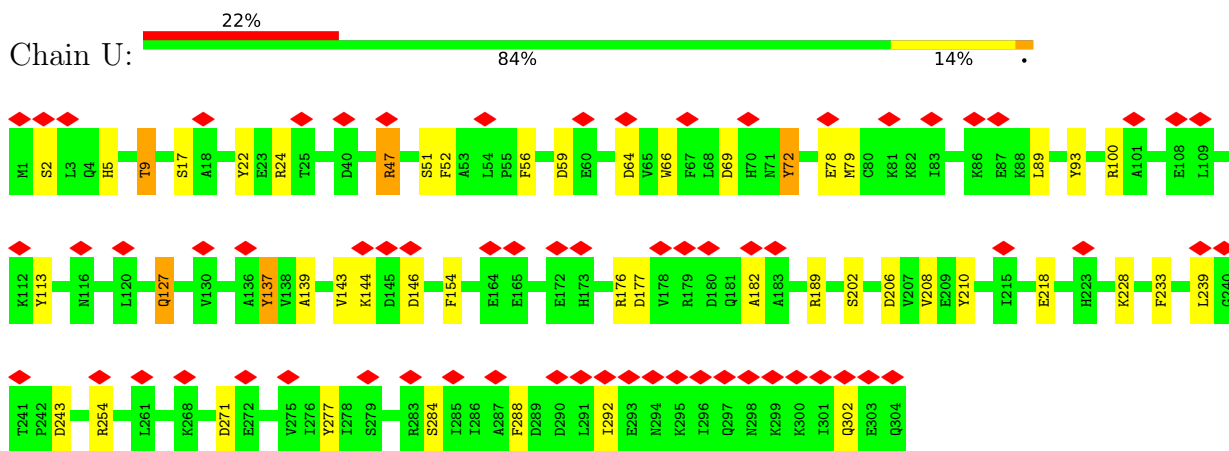

• Molecule 27: 26S proteasome regulatory subunit RPN9

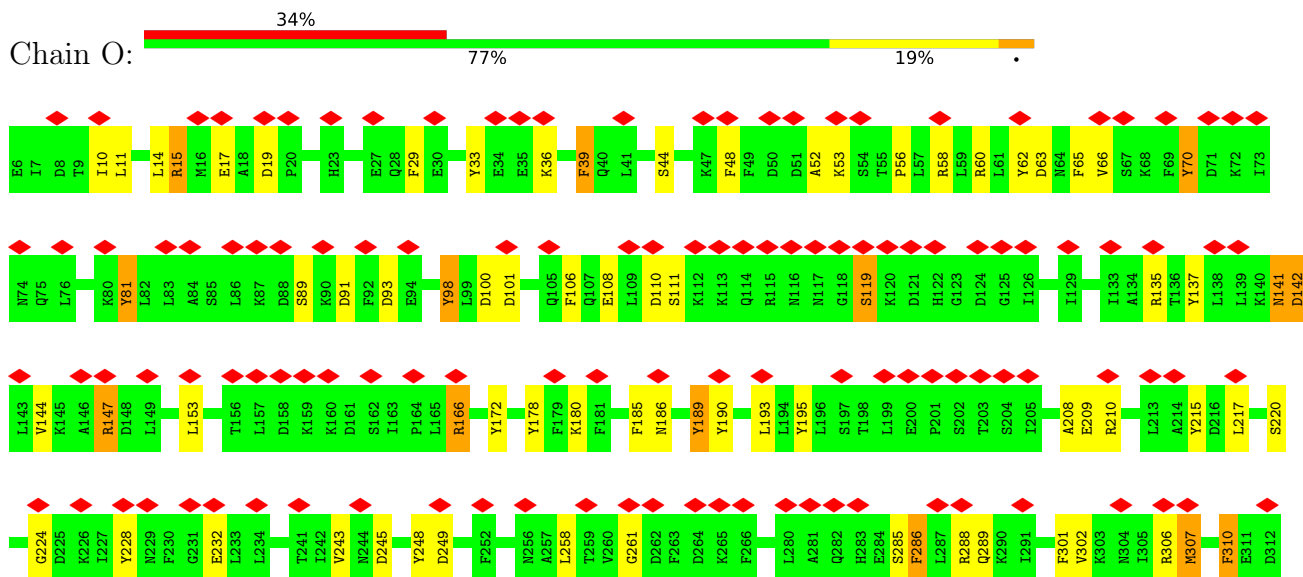

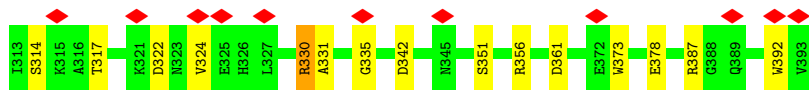

• Molecule 28: 26S proteasome regulatory subunit 7 homolog

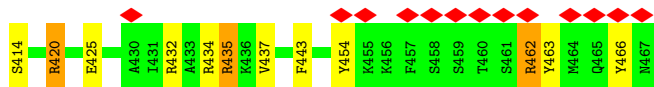
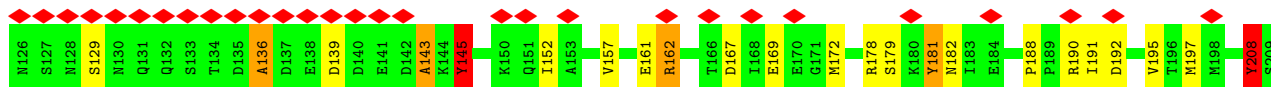
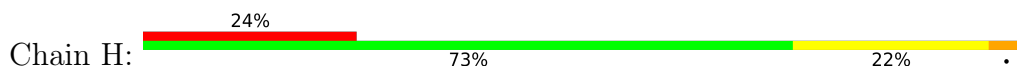

• Molecule 29: 26S proteasome regulatory subunit 4 homolog

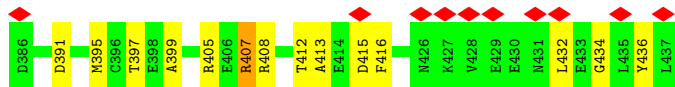
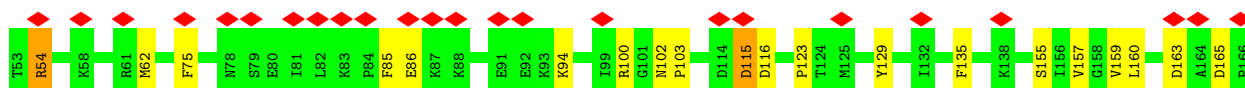
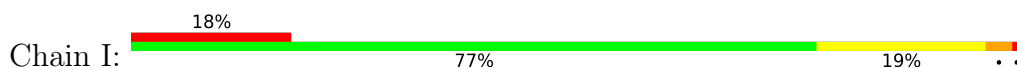

• Molecule 30: 26S proteasome regulatory subunit 6B homolog

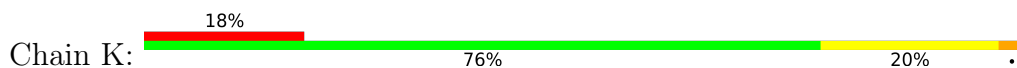

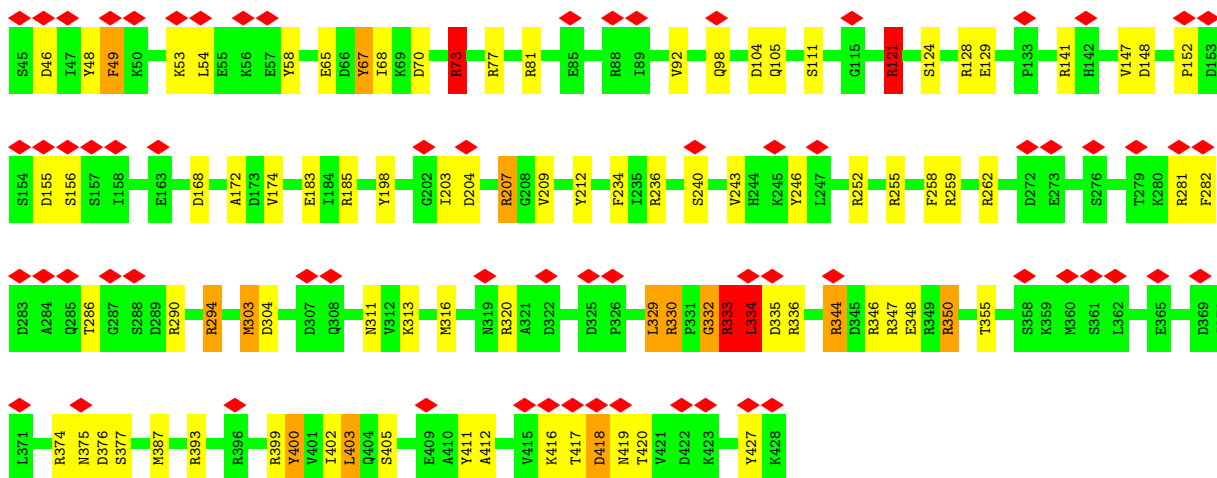

• Molecule 31: 26S proteasome subunit RPT4

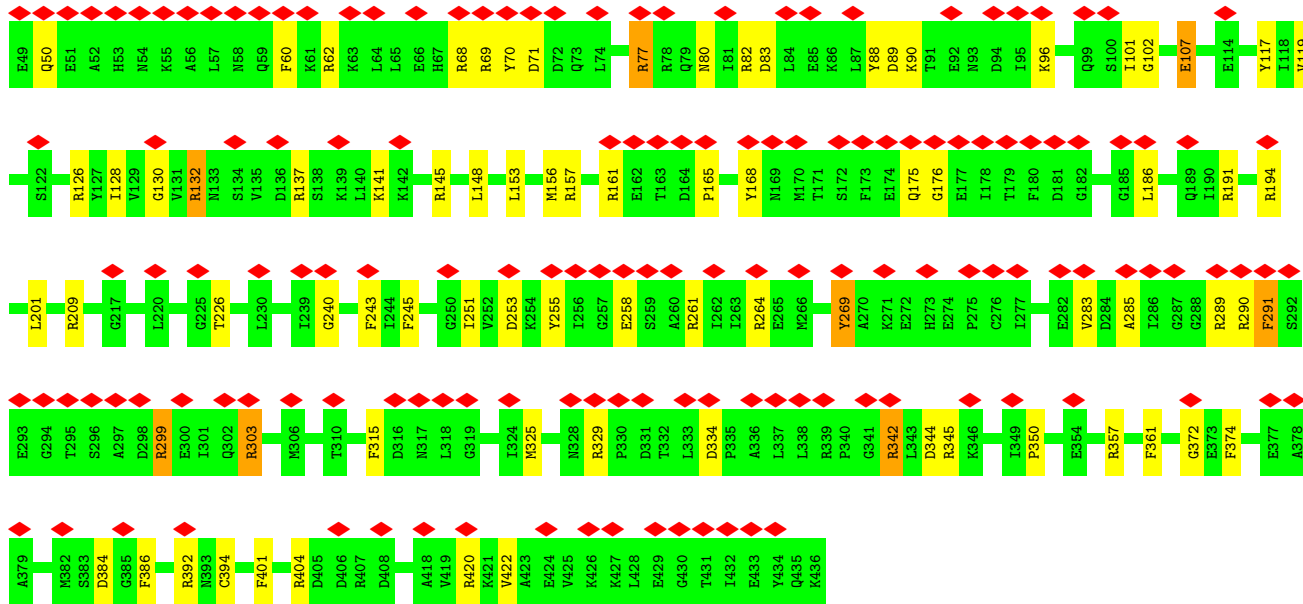
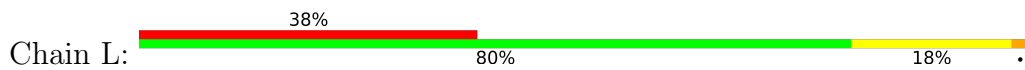

• Molecule 32: 26S proteasome regulatory subunit 6A

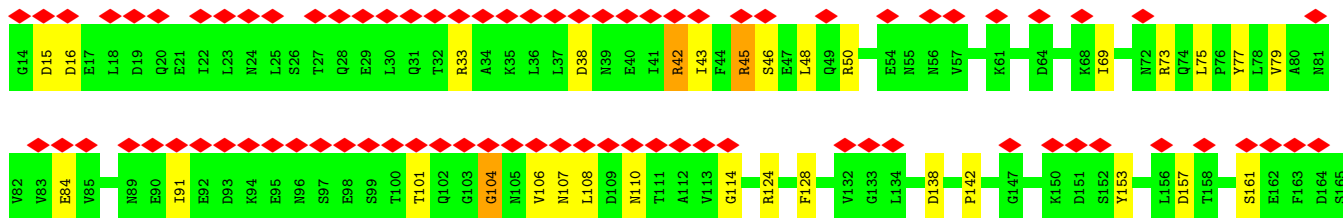
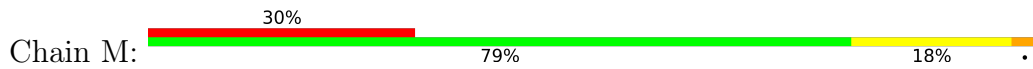

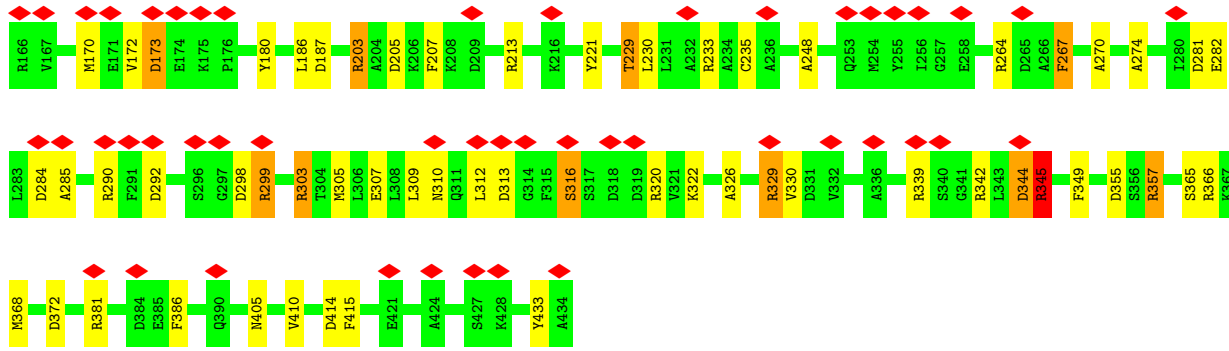

• Molecule 33: 26S proteasome regulatory subunit 8 homolog

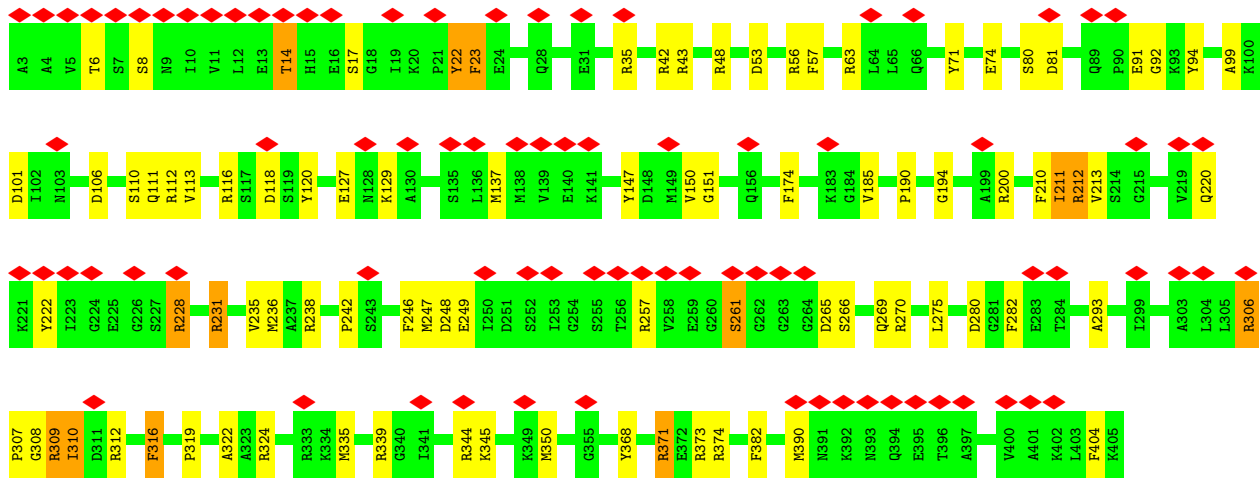
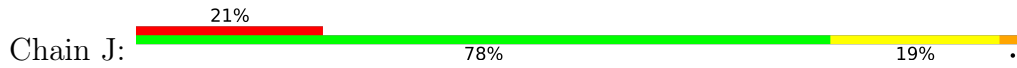

4 Experimental information

Property	Value	Source
EM reconstruction method	SINGLE PARTICLE	Depositor
Imposed symmetry	POINT, Not provided	
Number of particles used	351984	Depositor
Resolution determination method	FSC 0.143 CUT-OFF	Depositor
CTF correction method	PHASE FLIPPING AND AMPLITUDE CORRECTION	Depositor
Microscope	FEI TITAN KRIOS	Depositor
Voltage (kV)	300	Depositor
Electron dose ($e^-/\text{\AA}^2$)	35	Depositor
Minimum defocus (nm)	Not provided	
Maximum defocus (nm)	Not provided	
Magnification	Not provided	
Image detector	GATAN K2 SUMMIT (4k x 4k)	Depositor
Maximum map value	0.223	Depositor
Minimum map value	-0.185	Depositor
Average map value	0.000	Depositor
Map value standard deviation	0.007	Depositor
Recommended contour level	0.02	Depositor
Map size (Å)	529.92, 529.92, 529.92	wwPDB
Map dimensions	384, 384, 384	wwPDB
Map angles (°)	90.0, 90.0, 90.0	wwPDB
Pixel spacing (Å)	1.38, 1.38, 1.38	Depositor

5 Model quality i

5.1 Standard geometry i

Bond lengths and bond angles in the following residue types are not validated in this section: ADP, ATP, MG

The Z score for a bond length (or angle) is the number of standard deviations the observed value is removed from the expected value. A bond length (or angle) with $|Z| > 5$ is considered an outlier worth inspection. RMSZ is the root-mean-square of all Z scores of the bond lengths (or angles).

Mol	Chain	Bond lengths		Bond angles	
		RMSZ	# Z >5	RMSZ	# Z >5
1	A	1.76	22/1962 (1.1%)	1.91	51/2656 (1.9%)
1	a	1.74	26/1962 (1.3%)	1.90	42/2656 (1.6%)
2	B	1.67	15/1929 (0.8%)	1.92	42/2611 (1.6%)
2	b	1.69	22/1929 (1.1%)	1.96	52/2611 (2.0%)
3	C	1.75	14/1914 (0.7%)	1.93	32/2591 (1.2%)
3	c	1.71	16/1914 (0.8%)	1.93	54/2591 (2.1%)
4	D	1.74	20/2016 (1.0%)	2.03	52/2723 (1.9%)
4	d	1.75	19/2016 (0.9%)	1.97	55/2723 (2.0%)
5	E	1.79	19/1915 (1.0%)	1.82	36/2579 (1.4%)
5	e	1.75	13/1915 (0.7%)	2.02	49/2579 (1.9%)
6	F	1.74	17/1811 (0.9%)	1.92	34/2447 (1.4%)
6	f	1.69	18/1811 (1.0%)	1.91	47/2447 (1.9%)
7	G	1.71	15/1945 (0.8%)	1.94	45/2625 (1.7%)
7	g	1.67	15/1945 (0.8%)	2.01	54/2625 (2.1%)
8	1	1.74	17/1541 (1.1%)	1.99	46/2087 (2.2%)
8	h	1.74	11/1541 (0.7%)	1.98	42/2087 (2.0%)
9	2	1.70	11/1751 (0.6%)	1.92	38/2373 (1.6%)
9	i	1.70	13/1751 (0.7%)	1.89	39/2373 (1.6%)
10	3	1.76	15/1611 (0.9%)	2.03	40/2174 (1.8%)
10	j	1.75	14/1611 (0.9%)	1.87	32/2174 (1.5%)
11	4	1.81	28/1590 (1.8%)	1.90	34/2142 (1.6%)
11	k	1.72	17/1590 (1.1%)	1.93	36/2142 (1.7%)
12	5	1.74	16/1681 (1.0%)	1.92	35/2274 (1.5%)
12	l	1.75	14/1681 (0.8%)	1.97	52/2274 (2.3%)
13	6	1.75	19/1795 (1.1%)	2.01	49/2420 (2.0%)
13	m	1.70	11/1795 (0.6%)	1.98	48/2420 (2.0%)
14	7	1.71	20/1821 (1.1%)	2.04	51/2470 (2.1%)
14	n	1.75	17/1847 (0.9%)	1.94	49/2503 (2.0%)
15	W	1.72	17/1558 (1.1%)	1.86	28/2111 (1.3%)
16	V	1.71	24/2309 (1.0%)	1.87	47/3115 (1.5%)
17	T	1.64	18/2236 (0.8%)	1.88	52/3017 (1.7%)
18	X	1.76	10/1059 (0.9%)	2.00	20/1432 (1.4%)

Mol	Chain	Bond lengths		Bond angles	
		RMSZ	# Z >5	RMSZ	# Z >5
19	Y	1.69	8/741 (1.1%)	2.12	28/1000 (2.8%)
20	Z	1.67	56/7122 (0.8%)	1.88	167/9645 (1.7%)
21	N	1.69	61/7273 (0.8%)	1.89	159/9822 (1.6%)
22	S	1.69	33/3967 (0.8%)	1.99	99/5355 (1.8%)
23	P	1.65	31/3664 (0.8%)	1.89	82/4940 (1.7%)
24	Q	1.71	31/3556 (0.9%)	1.95	86/4787 (1.8%)
25	R	1.72	34/3314 (1.0%)	1.92	66/4469 (1.5%)
26	U	1.64	14/2461 (0.6%)	1.87	50/3327 (1.5%)
27	O	1.71	29/3247 (0.9%)	1.91	82/4380 (1.9%)
28	H	1.73	33/3363 (1.0%)	1.99	89/4532 (2.0%)
29	I	1.69	23/3061 (0.8%)	1.90	65/4121 (1.6%)
30	K	1.77	39/3084 (1.3%)	1.96	73/4162 (1.8%)
31	L	1.74	23/3129 (0.7%)	1.97	72/4204 (1.7%)
32	M	1.70	24/3323 (0.7%)	1.94	81/4478 (1.8%)
33	J	1.71	29/3197 (0.9%)	1.97	78/4296 (1.8%)
All	All	1.71	1011/112254 (0.9%)	1.93	2660/151570 (1.8%)

Chiral center outliers are detected by calculating the chiral volume of a chiral center and verifying if the center is modelled as a planar moiety or with the opposite hand. A planarity outlier is detected by checking planarity of atoms in a peptide group, atoms in a mainchain group or atoms of a sidechain that are expected to be planar.

Mol	Chain	#Chirality outliers	#Planarity outliers
1	A	0	7
1	a	0	5
2	B	0	4
2	b	0	8
3	C	0	15
3	c	0	7
4	D	0	9
4	d	0	8
5	E	0	7
5	e	0	3
6	F	0	4
6	f	0	8
7	G	0	6
7	g	0	7
8	1	0	5
8	h	0	5
9	2	0	7
9	i	0	6
10	3	0	3

Continued on next page...

Continued from previous page...

Mol	Chain	#Chirality outliers	#Planarity outliers
10	j	0	3
11	4	0	5
11	k	0	4
12	5	0	6
12	l	0	6
13	6	0	4
13	m	0	9
14	7	0	7
14	n	0	8
15	W	0	4
16	V	0	8
17	T	0	5
18	X	0	7
19	Y	0	2
20	Z	0	12
21	N	0	21
22	S	0	16
23	P	0	12
24	Q	0	8
25	R	0	7
26	U	0	3
27	O	0	11
28	H	0	20
29	I	0	18
30	K	0	15
31	L	0	9
32	M	0	10
33	J	0	12
All	All	0	376

The worst 5 of 1011 bond length outliers are listed below:

Mol	Chain	Res	Type	Atoms	Z	Observed(Å)	Ideal(Å)
25	R	355	SER	CA-CB	10.56	1.68	1.52
5	E	214	GLU	CG-CD	9.48	1.66	1.51
5	E	26	TYR	CG-CD2	9.46	1.51	1.39
29	I	405	ARG	NE-CZ	9.24	1.45	1.33
30	K	121	ARG	CD-NE	8.91	1.61	1.46

The worst 5 of 2660 bond angle outliers are listed below:

Mol	Chain	Res	Type	Atoms	Z	Observed(°)	Ideal(°)
4	D	6	ARG	NE-CZ-NH1	-20.22	110.19	120.30
4	D	6	ARG	NE-CZ-NH2	18.42	129.51	120.30
22	S	259	TYR	CB-CG-CD2	18.40	132.04	121.00
5	e	231	TYR	CB-CG-CD2	18.27	131.96	121.00
5	e	136	ARG	NE-CZ-NH1	16.91	128.75	120.30

There are no chirality outliers.

5 of 376 planarity outliers are listed below:

Mol	Chain	Res	Type	Group
1	a	106	TYR	Sidechain
1	a	11	GLY	Peptide
1	a	12	TYR	Peptide
1	a	131	ARG	Sidechain
1	a	96	ARG	Sidechain

5.2 Too-close contacts [i](#)

Due to software issues we are unable to calculate clashes - this section is therefore empty.

5.3 Torsion angles [i](#)

5.3.1 Protein backbone [i](#)

In the following table, the Percentiles column shows the percent Ramachandran outliers of the chain as a percentile score with respect to all PDB entries followed by that with respect to all EM entries.

The Analysed column shows the number of residues for which the backbone conformation was analysed, and the total number of residues.

Mol	Chain	Analysed	Favoured	Allowed	Outliers	Percentiles	
1	A	242/244 (99%)	231 (96%)	9 (4%)	2 (1%)	19	60
1	a	242/244 (99%)	227 (94%)	13 (5%)	2 (1%)	19	60
2	B	245/247 (99%)	232 (95%)	12 (5%)	1 (0%)	34	72
2	b	245/247 (99%)	231 (94%)	11 (4%)	3 (1%)	13	50
3	C	239/241 (99%)	222 (93%)	15 (6%)	2 (1%)	19	60
3	c	239/241 (99%)	227 (95%)	11 (5%)	1 (0%)	34	72
4	D	250/252 (99%)	238 (95%)	8 (3%)	4 (2%)	9	45

Continued on next page...

Continued from previous page...

Mol	Chain	Analysed	Favoured	Allowed	Outliers	Percentiles	
4	d	250/252 (99%)	235 (94%)	11 (4%)	4 (2%)	9	45
5	E	243/245 (99%)	226 (93%)	13 (5%)	4 (2%)	9	45
5	e	243/245 (99%)	225 (93%)	14 (6%)	4 (2%)	9	45
6	F	230/232 (99%)	219 (95%)	11 (5%)	0	100	100
6	f	230/232 (99%)	220 (96%)	10 (4%)	0	100	100
7	G	243/245 (99%)	225 (93%)	14 (6%)	4 (2%)	9	45
7	g	243/245 (99%)	226 (93%)	10 (4%)	7 (3%)	4	32
8	l	194/196 (99%)	185 (95%)	8 (4%)	1 (0%)	29	68
8	h	194/196 (99%)	182 (94%)	11 (6%)	1 (0%)	29	68
9	2	224/226 (99%)	211 (94%)	7 (3%)	6 (3%)	5	34
9	i	224/226 (99%)	209 (93%)	12 (5%)	3 (1%)	12	48
10	3	202/204 (99%)	188 (93%)	9 (4%)	5 (2%)	5	35
10	j	202/204 (99%)	187 (93%)	14 (7%)	1 (0%)	29	68
11	4	193/195 (99%)	183 (95%)	10 (5%)	0	100	100
11	k	193/195 (99%)	177 (92%)	12 (6%)	4 (2%)	7	39
12	5	210/212 (99%)	204 (97%)	6 (3%)	0	100	100
12	l	210/212 (99%)	196 (93%)	14 (7%)	0	100	100
13	6	220/222 (99%)	204 (93%)	13 (6%)	3 (1%)	11	47
13	m	220/222 (99%)	206 (94%)	10 (4%)	4 (2%)	8	42
14	7	227/232 (98%)	209 (92%)	15 (7%)	3 (1%)	12	48
14	n	230/232 (99%)	215 (94%)	12 (5%)	3 (1%)	12	48
15	W	195/197 (99%)	174 (89%)	14 (7%)	7 (4%)	3	28
16	V	287/289 (99%)	261 (91%)	22 (8%)	4 (1%)	11	47
17	T	264/266 (99%)	244 (92%)	15 (6%)	5 (2%)	8	41
18	X	125/127 (98%)	96 (77%)	20 (16%)	9 (7%)	1	16
19	Y	87/89 (98%)	74 (85%)	7 (8%)	6 (7%)	1	17
20	Z	902/970 (93%)	813 (90%)	66 (7%)	23 (2%)	5	35
21	N	920/922 (100%)	851 (92%)	51 (6%)	18 (2%)	7	40
22	S	473/475 (100%)	437 (92%)	21 (4%)	15 (3%)	4	30
23	P	438/440 (100%)	414 (94%)	20 (5%)	4 (1%)	17	56
24	Q	432/434 (100%)	395 (91%)	20 (5%)	17 (4%)	3	26

Continued on next page...

Continued from previous page...

Mol	Chain	Analysed	Favoured	Allowed	Outliers	Percentiles	
25	R	403/405 (100%)	375 (93%)	22 (6%)	6 (2%)	10	46
26	U	302/304 (99%)	290 (96%)	8 (3%)	4 (1%)	12	48
27	O	386/388 (100%)	364 (94%)	14 (4%)	8 (2%)	7	39
28	H	424/426 (100%)	369 (87%)	33 (8%)	22 (5%)	2	22
29	I	383/385 (100%)	341 (89%)	30 (8%)	12 (3%)	4	31
30	K	382/384 (100%)	339 (89%)	27 (7%)	16 (4%)	3	25
31	L	386/388 (100%)	361 (94%)	18 (5%)	7 (2%)	8	42
32	M	419/421 (100%)	379 (90%)	28 (7%)	12 (3%)	4	32
33	J	401/403 (100%)	351 (88%)	40 (10%)	10 (2%)	5	35
All	All	13936/14099 (99%)	12868 (92%)	791 (6%)	277 (2%)	11	40

5 of 277 Ramachandran outliers are listed below:

Mol	Chain	Res	Type
1	a	10	ALA
2	b	53	SER
4	d	204	GLN
5	e	14	THR
5	e	16	SER

5.3.2 Protein sidechains [i](#)

In the following table, the Percentiles column shows the percent sidechain outliers of the chain as a percentile score with respect to all PDB entries followed by that with respect to all EM entries.

The Analysed column shows the number of residues for which the sidechain conformation was analysed, and the total number of residues.

Mol	Chain	Analysed	Rotameric	Outliers	Percentiles	
1	A	207/207 (100%)	203 (98%)	4 (2%)	57	75
1	a	207/207 (100%)	201 (97%)	6 (3%)	42	64
2	B	206/206 (100%)	200 (97%)	6 (3%)	42	64
2	b	206/206 (100%)	202 (98%)	4 (2%)	57	75
3	C	201/201 (100%)	193 (96%)	8 (4%)	31	56
3	c	201/201 (100%)	195 (97%)	6 (3%)	41	63
4	D	224/224 (100%)	217 (97%)	7 (3%)	40	63

Continued on next page...

Continued from previous page...

Mol	Chain	Analysed	Rotameric	Outliers	Percentiles	
4	d	224/224 (100%)	213 (95%)	11 (5%)	25	51
5	E	201/201 (100%)	197 (98%)	4 (2%)	55	73
5	e	201/201 (100%)	198 (98%)	3 (2%)	65	80
6	F	191/191 (100%)	184 (96%)	7 (4%)	34	59
6	f	191/191 (100%)	185 (97%)	6 (3%)	40	63
7	G	202/202 (100%)	195 (96%)	7 (4%)	36	60
7	g	202/202 (100%)	193 (96%)	9 (4%)	27	54
8	l	162/162 (100%)	159 (98%)	3 (2%)	57	75
8	h	162/162 (100%)	158 (98%)	4 (2%)	47	68
9	2	185/185 (100%)	181 (98%)	4 (2%)	52	71
9	i	185/185 (100%)	180 (97%)	5 (3%)	44	66
10	3	172/172 (100%)	165 (96%)	7 (4%)	30	56
10	j	172/172 (100%)	167 (97%)	5 (3%)	42	64
11	4	173/173 (100%)	167 (96%)	6 (4%)	36	60
11	k	173/173 (100%)	167 (96%)	6 (4%)	36	60
12	5	169/169 (100%)	164 (97%)	5 (3%)	41	63
12	l	169/169 (100%)	164 (97%)	5 (3%)	41	63
13	6	185/185 (100%)	178 (96%)	7 (4%)	33	58
13	m	185/185 (100%)	182 (98%)	3 (2%)	62	79
14	7	195/198 (98%)	187 (96%)	8 (4%)	30	56
14	n	198/198 (100%)	194 (98%)	4 (2%)	55	73
15	W	171/171 (100%)	167 (98%)	4 (2%)	50	70
16	V	253/253 (100%)	247 (98%)	6 (2%)	49	69
17	T	249/249 (100%)	245 (98%)	4 (2%)	62	79
18	X	116/116 (100%)	112 (97%)	4 (3%)	37	61
19	Y	81/81 (100%)	77 (95%)	4 (5%)	25	51
20	Z	773/828 (93%)	745 (96%)	28 (4%)	35	60
21	N	776/776 (100%)	759 (98%)	17 (2%)	52	71
22	S	447/447 (100%)	435 (97%)	12 (3%)	44	66
23	P	412/412 (100%)	408 (99%)	4 (1%)	76	86
24	Q	391/391 (100%)	382 (98%)	9 (2%)	50	70

Continued on next page...

Continued from previous page...

Mol	Chain	Analysed	Rotameric	Outliers	Percentiles
25	R	356/356 (100%)	349 (98%)	7 (2%)	55 73
26	U	277/277 (100%)	275 (99%)	2 (1%)	84 90
27	O	363/363 (100%)	352 (97%)	11 (3%)	41 63
28	H	361/361 (100%)	351 (97%)	10 (3%)	43 65
29	I	342/342 (100%)	327 (96%)	15 (4%)	28 54
30	K	337/337 (100%)	327 (97%)	10 (3%)	41 63
31	L	332/332 (100%)	327 (98%)	5 (2%)	65 80
32	M	364/364 (100%)	354 (97%)	10 (3%)	44 66
33	J	350/350 (100%)	338 (97%)	12 (3%)	37 61
All	All	12100/12158 (100%)	11766 (97%)	334 (3%)	46 65

5 of 334 residues with a non-rotameric sidechain are listed below:

Mol	Chain	Res	Type
22	S	155	LEU
29	I	219	VAL
22	S	429	ASP
26	U	177	ASP
30	K	155	ASP

Sometimes sidechains can be flipped to improve hydrogen bonding and reduce clashes. 5 of 147 such sidechains are listed below:

Mol	Chain	Res	Type
26	U	21	HIS
33	J	205	HIS
27	O	40	GLN
29	I	365	HIS
7	G	87	HIS

5.3.3 RNA [i](#)

There are no RNA molecules in this entry.

5.4 Non-standard residues in protein, DNA, RNA chains [i](#)

There are no non-standard protein/DNA/RNA residues in this entry.

5.5 Carbohydrates [i](#)

There are no monosaccharides in this entry.

5.6 Ligand geometry [i](#)

Of 12 ligands modelled in this entry, 6 are monoatomic - leaving 6 for Mogul analysis.

In the following table, the Counts columns list the number of bonds (or angles) for which Mogul statistics could be retrieved, the number of bonds (or angles) that are observed in the model and the number of bonds (or angles) that are defined in the Chemical Component Dictionary. The Link column lists molecule types, if any, to which the group is linked. The Z score for a bond length (or angle) is the number of standard deviations the observed value is removed from the expected value. A bond length (or angle) with $|Z| > 2$ is considered an outlier worth inspection. RMSZ is the root-mean-square of all Z scores of the bond lengths (or angles).

Mol	Type	Chain	Res	Link	Bond lengths			Bond angles		
					Counts	RMSZ	# Z > 2	Counts	RMSZ	# Z > 2
36	ADP	K	501	35	24,29,29	1.86	7 (29%)	29,45,45	2.11	6 (20%)
34	ATP	H	501	35	26,33,33	1.27	2 (7%)	31,52,52	1.87	5 (16%)
34	ATP	M	501	35	26,33,33	1.28	2 (7%)	31,52,52	1.85	7 (22%)
36	ADP	L	501	35	24,29,29	2.04	5 (20%)	29,45,45	2.12	5 (17%)
34	ATP	I	501	35	26,33,33	1.49	5 (19%)	31,52,52	1.81	4 (12%)
34	ATP	J	501	35	26,33,33	1.63	3 (11%)	31,52,52	2.57	5 (16%)

In the following table, the Chirals column lists the number of chiral outliers, the number of chiral centers analysed, the number of these observed in the model and the number defined in the Chemical Component Dictionary. Similar counts are reported in the Torsion and Rings columns. '-' means no outliers of that kind were identified.

Mol	Type	Chain	Res	Link	Chirals	Torsions	Rings
36	ADP	K	501	35	-	4/12/32/32	0/3/3/3
34	ATP	H	501	35	-	4/18/38/38	0/3/3/3
34	ATP	M	501	35	-	5/18/38/38	0/3/3/3
36	ADP	L	501	35	-	3/12/32/32	0/3/3/3
34	ATP	I	501	35	-	7/18/38/38	0/3/3/3
34	ATP	J	501	35	-	3/18/38/38	0/3/3/3

The worst 5 of 24 bond length outliers are listed below:

Mol	Chain	Res	Type	Atoms	Z	Observed(Å)	Ideal(Å)
36	L	501	ADP	C2-N3	6.07	1.41	1.32

Continued on next page...

Continued from previous page...

Mol	Chain	Res	Type	Atoms	Z	Observed(Å)	Ideal(Å)
36	L	501	ADP	O4'-C1'	5.60	1.48	1.41
34	J	501	ATP	C4-N3	-5.29	1.28	1.35
36	K	501	ADP	C2'-C1'	-4.36	1.47	1.53
34	J	501	ATP	O4'-C1'	3.84	1.46	1.41

The worst 5 of 32 bond angle outliers are listed below:

Mol	Chain	Res	Type	Atoms	Z	Observed(°)	Ideal(°)
34	J	501	ATP	PA-O3A-PB	9.61	165.81	132.83
36	K	501	ADP	PA-O3A-PB	8.39	161.62	132.83
36	L	501	ADP	PA-O3A-PB	8.24	161.11	132.83
34	M	501	ATP	PB-O3B-PG	6.57	155.36	132.83
34	H	501	ATP	PA-O3A-PB	5.98	153.35	132.83

There are no chirality outliers.

5 of 26 torsion outliers are listed below:

Mol	Chain	Res	Type	Atoms
34	H	501	ATP	C5'-O5'-PA-O2A
34	H	501	ATP	C5'-O5'-PA-O3A
34	I	501	ATP	C5'-O5'-PA-O1A
34	I	501	ATP	C5'-O5'-PA-O2A
34	M	501	ATP	C5'-O5'-PA-O2A

There are no ring outliers.

No monomer is involved in short contacts.

The following is a two-dimensional graphical depiction of Mogul quality analysis of bond lengths, bond angles, torsion angles, and ring geometry for all instances of the Ligand of Interest. In addition, ligands with molecular weight > 250 and outliers as shown on the validation Tables will also be included. For torsion angles, if less than 5% of the Mogul distribution of torsion angles is within 10 degrees of the torsion angle in question, then that torsion angle is considered an outlier. Any bond that is central to one or more torsion angles identified as an outlier by Mogul will be highlighted in the graph. For rings, the root-mean-square deviation (RMSD) between the ring in question and similar rings identified by Mogul is calculated over all ring torsion angles. If the average RMSD is greater than 60 degrees and the minimal RMSD between the ring in question and any Mogul-identified rings is also greater than 60 degrees, then that ring is considered an outlier. The outliers are highlighted in purple. The color gray indicates Mogul did not find sufficient equivalents in the CSD to analyse the geometry.

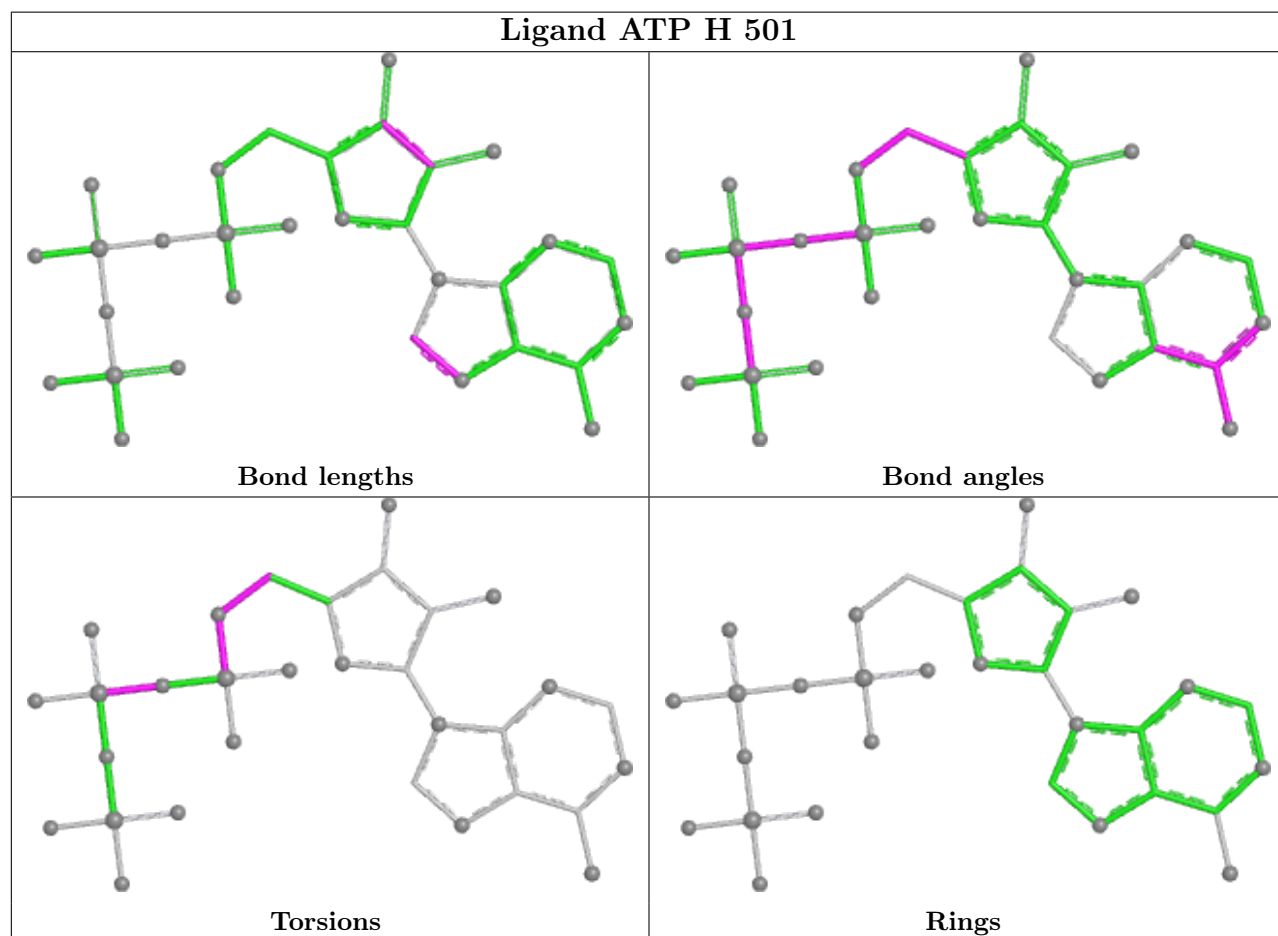
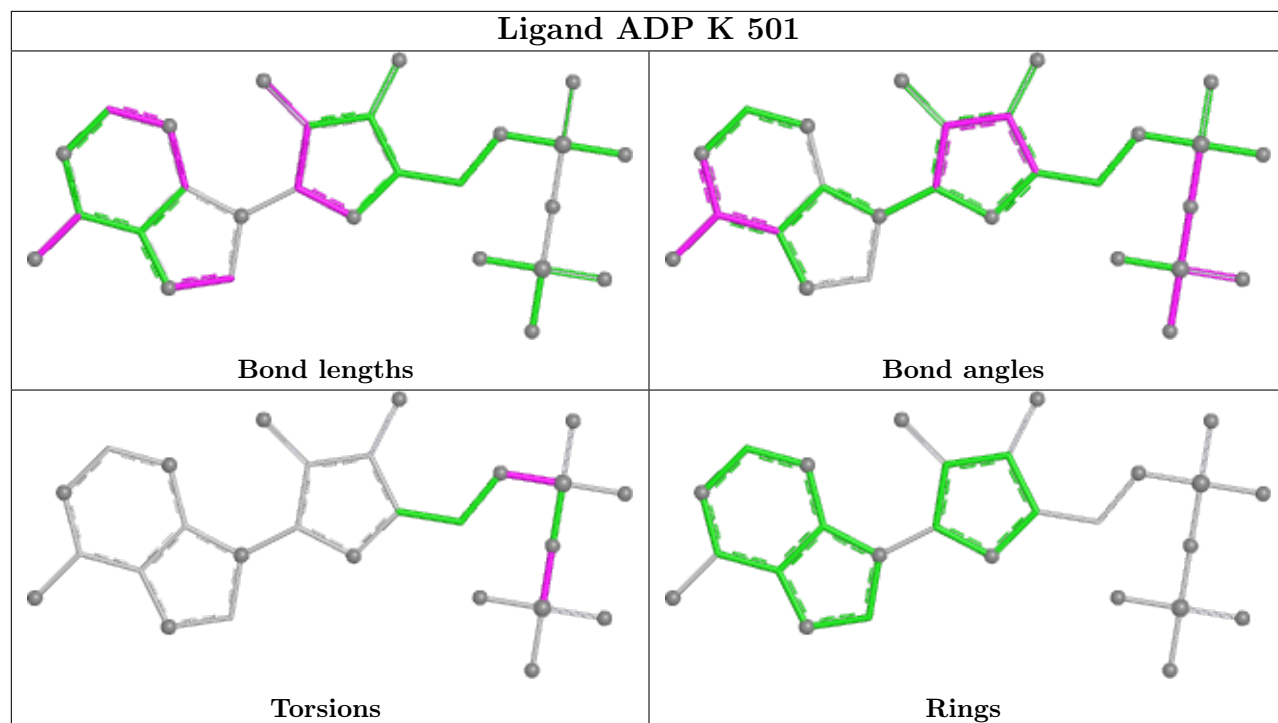

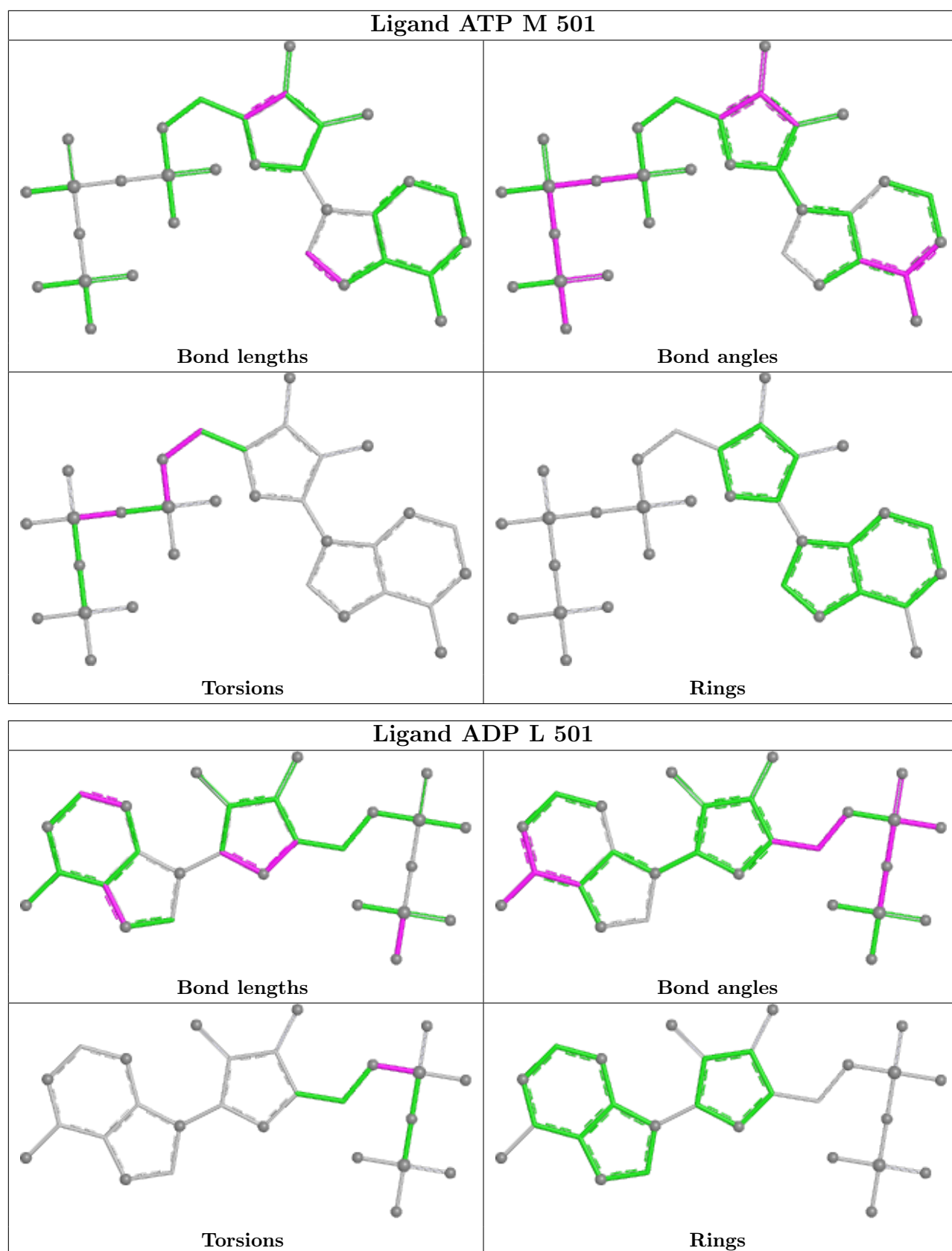

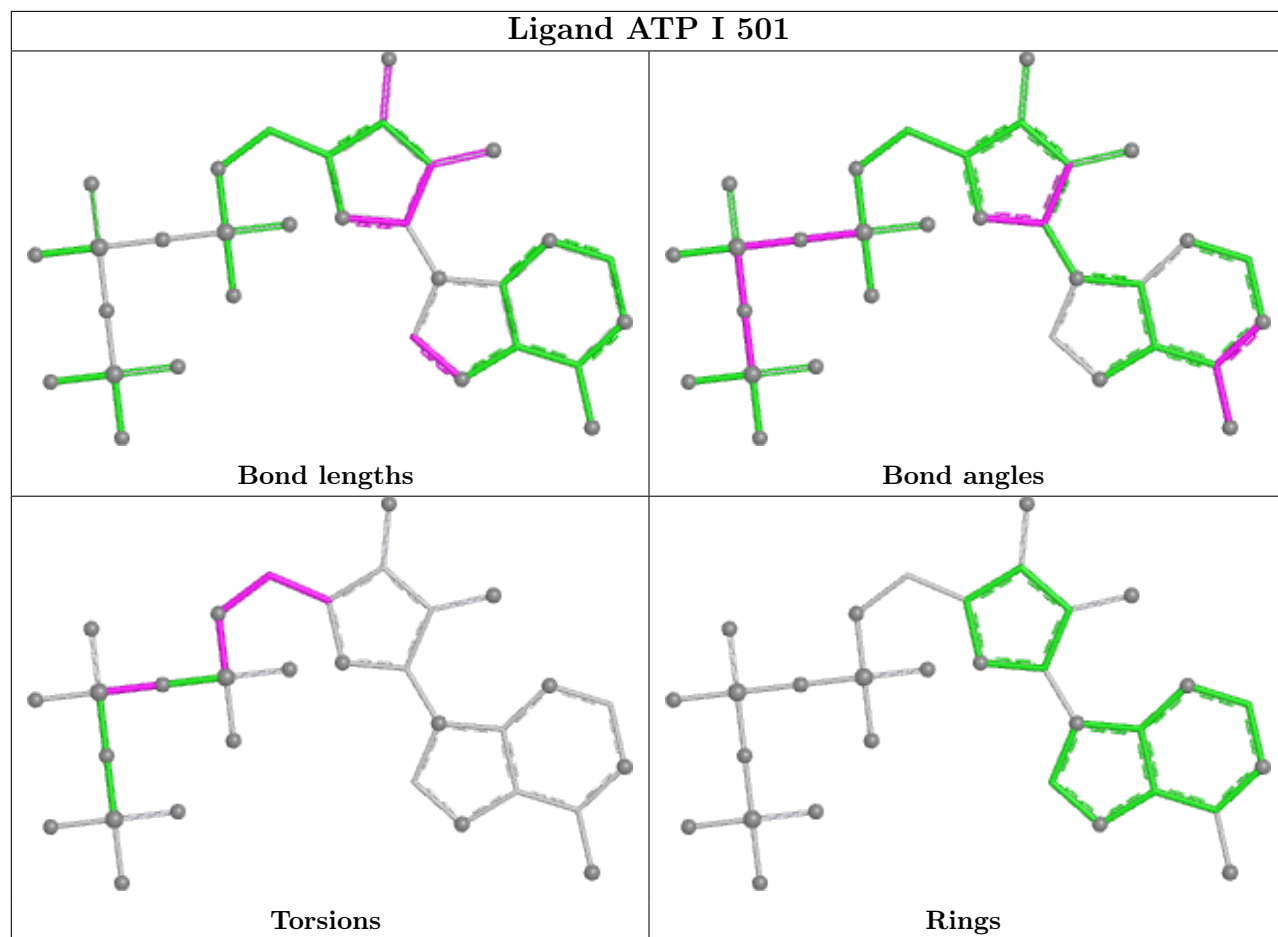

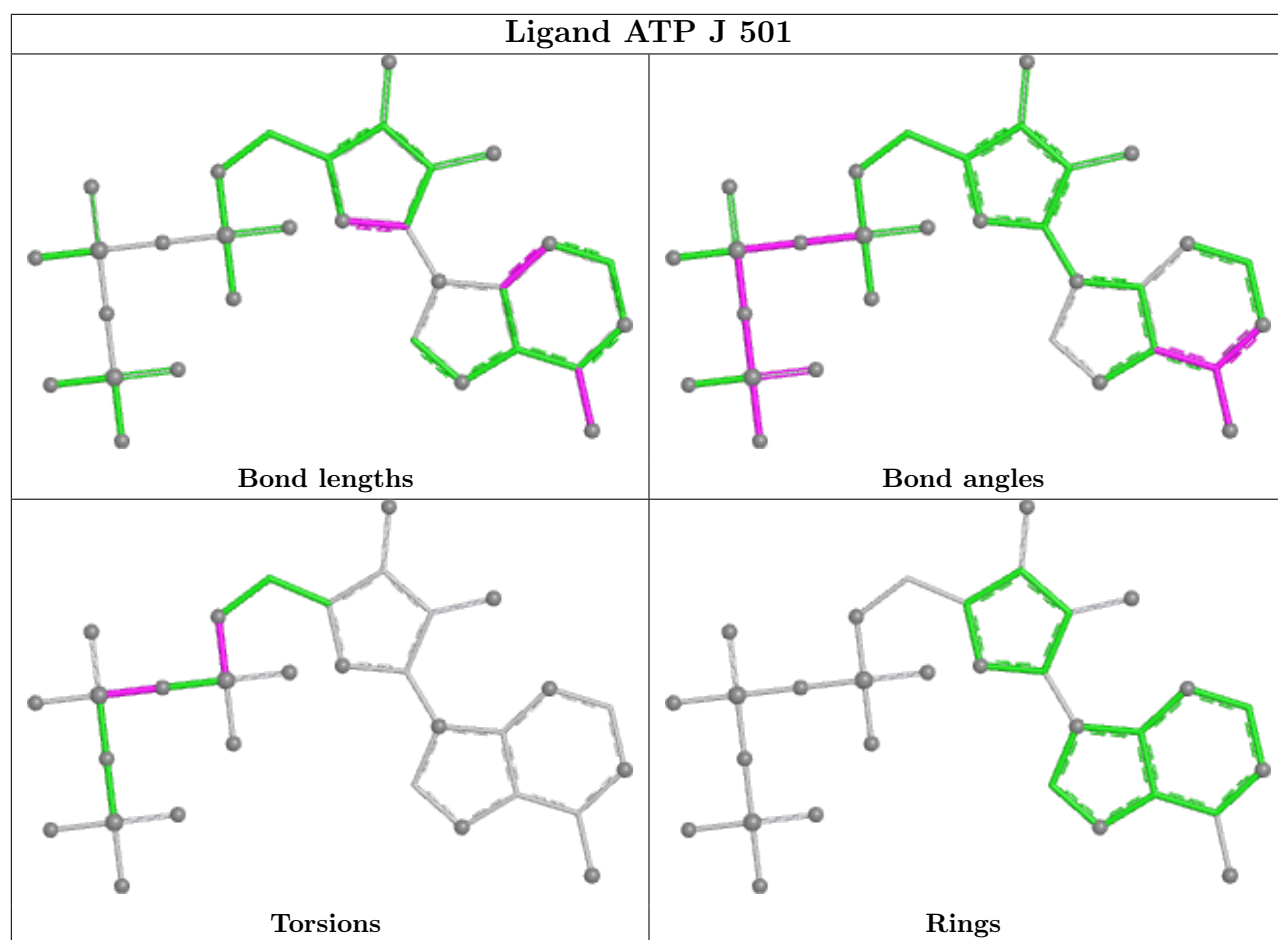

5.7 Other polymers [i](#)

There are no such residues in this entry.

5.8 Polymer linkage issues [i](#)

There are no chain breaks in this entry.

6 Map visualisation [i](#)

This section contains visualisations of the EMDB entry EMD-4322. These allow visual inspection of the internal detail of the map and identification of artifacts.

No raw map or half-maps were deposited for this entry and therefore no images, graphs, etc. pertaining to the raw map can be shown.

6.1 Orthogonal projections [i](#)

6.1.1 Primary map

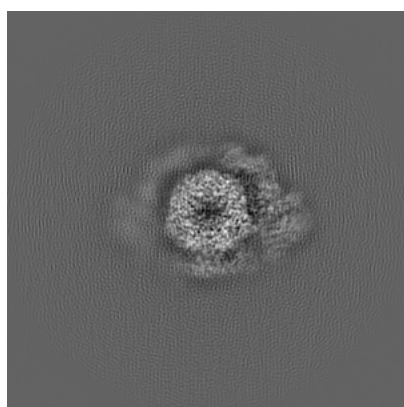

X

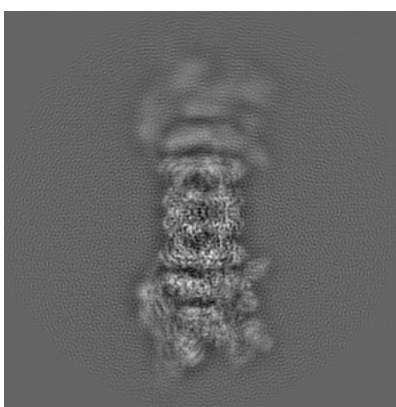

Y

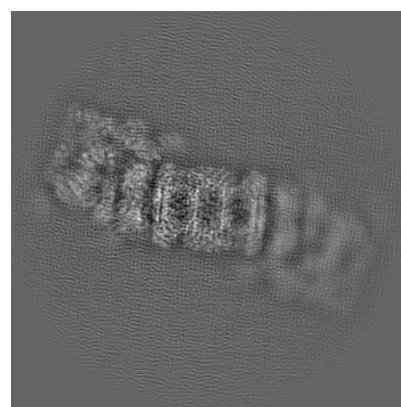

Z

The images above show the map projected in three orthogonal directions.

6.2 Central slices [i](#)

6.2.1 Primary map

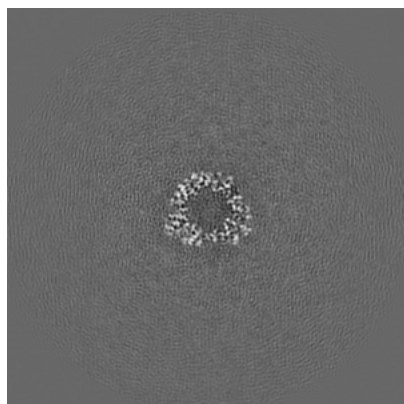

X Index: 192

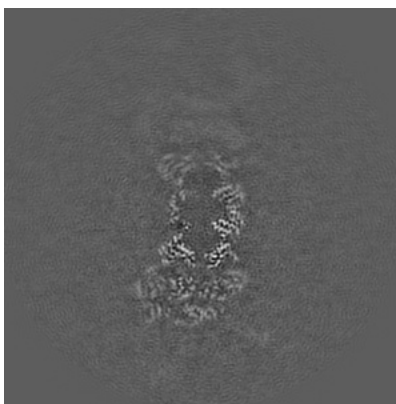

Y Index: 192

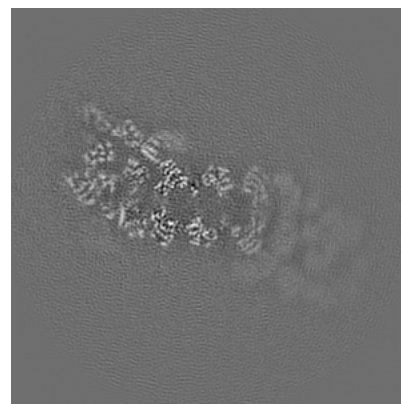

Z Index: 192

The images above show central slices of the map in three orthogonal directions.

6.3 Largest variance slices [i](#)

6.3.1 Primary map

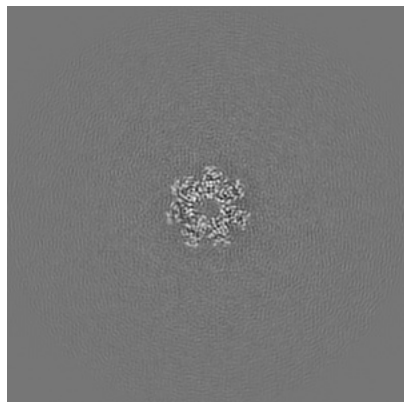

X Index: 177

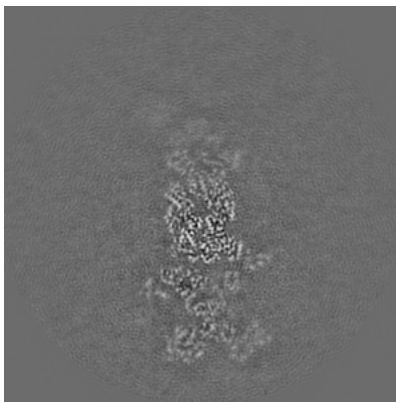

Y Index: 212

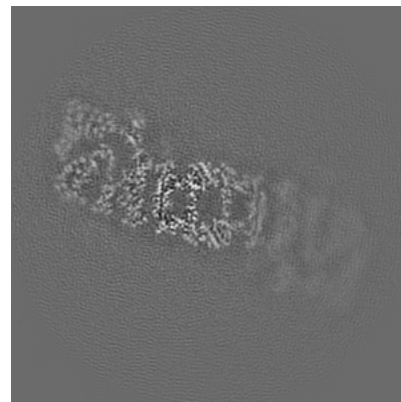

Z Index: 178

The images above show the largest variance slices of the map in three orthogonal directions.

6.4 Orthogonal surface views [i](#)

6.4.1 Primary map

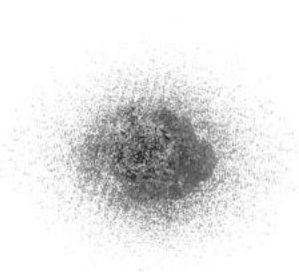

X



Y



Z

The images above show the 3D surface view of the map at the recommended contour level 0.02. These images, in conjunction with the slice images, may facilitate assessment of whether an appropriate contour level has been provided.

6.5 Mask visualisation

This section was not generated. No masks/segmentation were deposited.

7 Map analysis [i](#)

This section contains the results of statistical analysis of the map.

7.1 Map-value distribution [i](#)

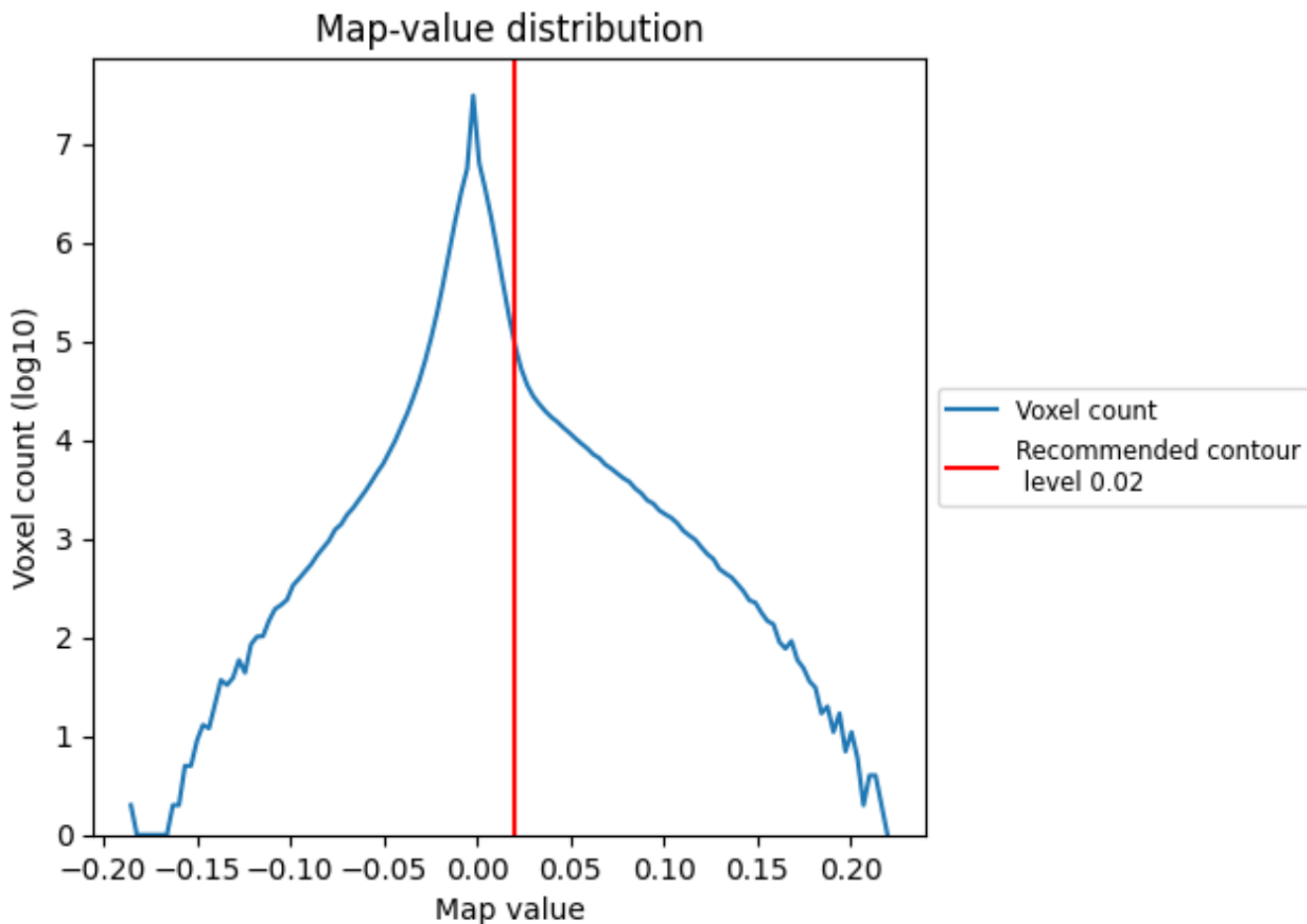

The map-value distribution is plotted in 128 intervals along the x-axis. The y-axis is logarithmic. A spike in this graph at zero usually indicates that the volume has been masked.

7.2 Volume estimate [i](#)

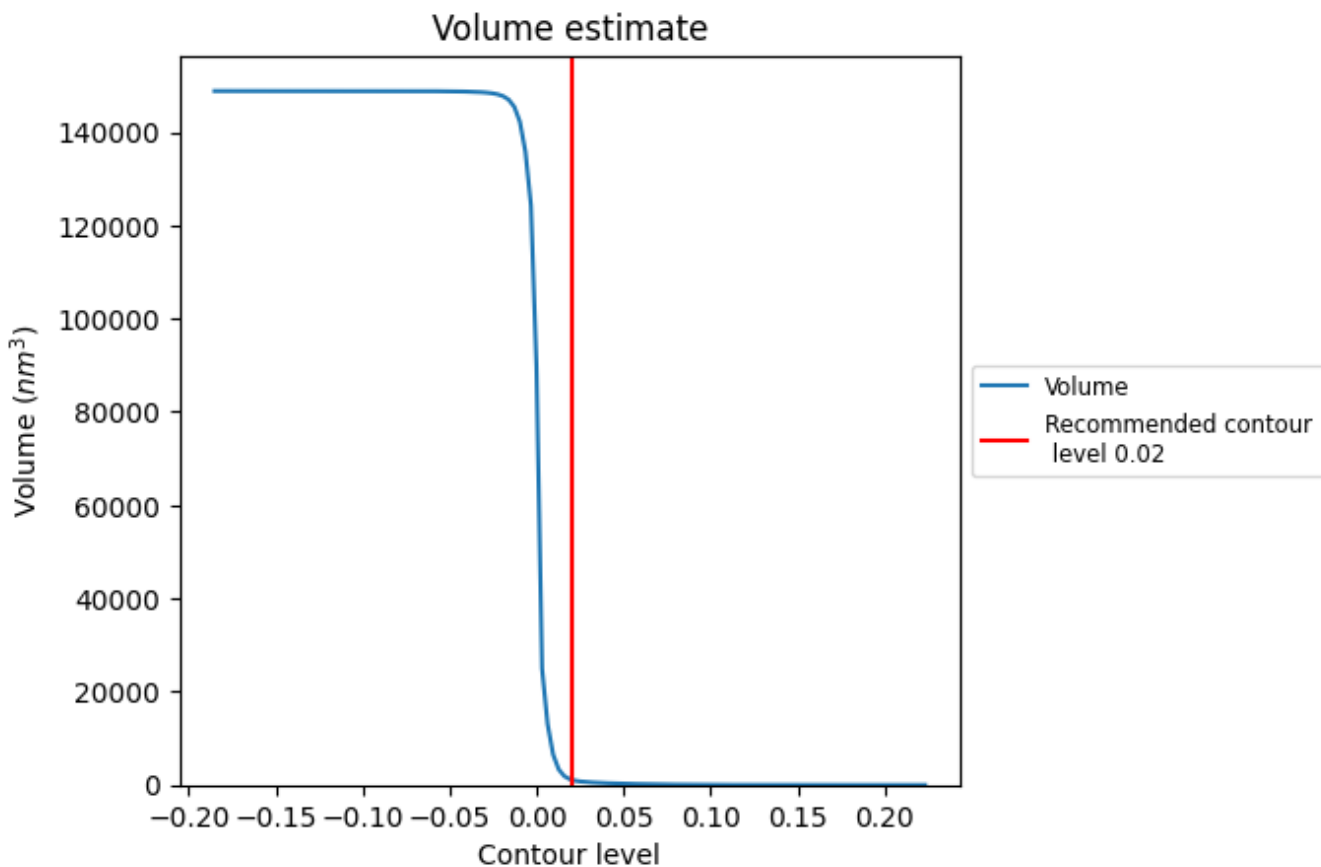

The volume at the recommended contour level is 1128 nm³; this corresponds to an approximate mass of 1019 kDa.

The volume estimate graph shows how the enclosed volume varies with the contour level. The recommended contour level is shown as a vertical line and the intersection between the line and the curve gives the volume of the enclosed surface at the given level.

7.3 Rotationally averaged power spectrum i

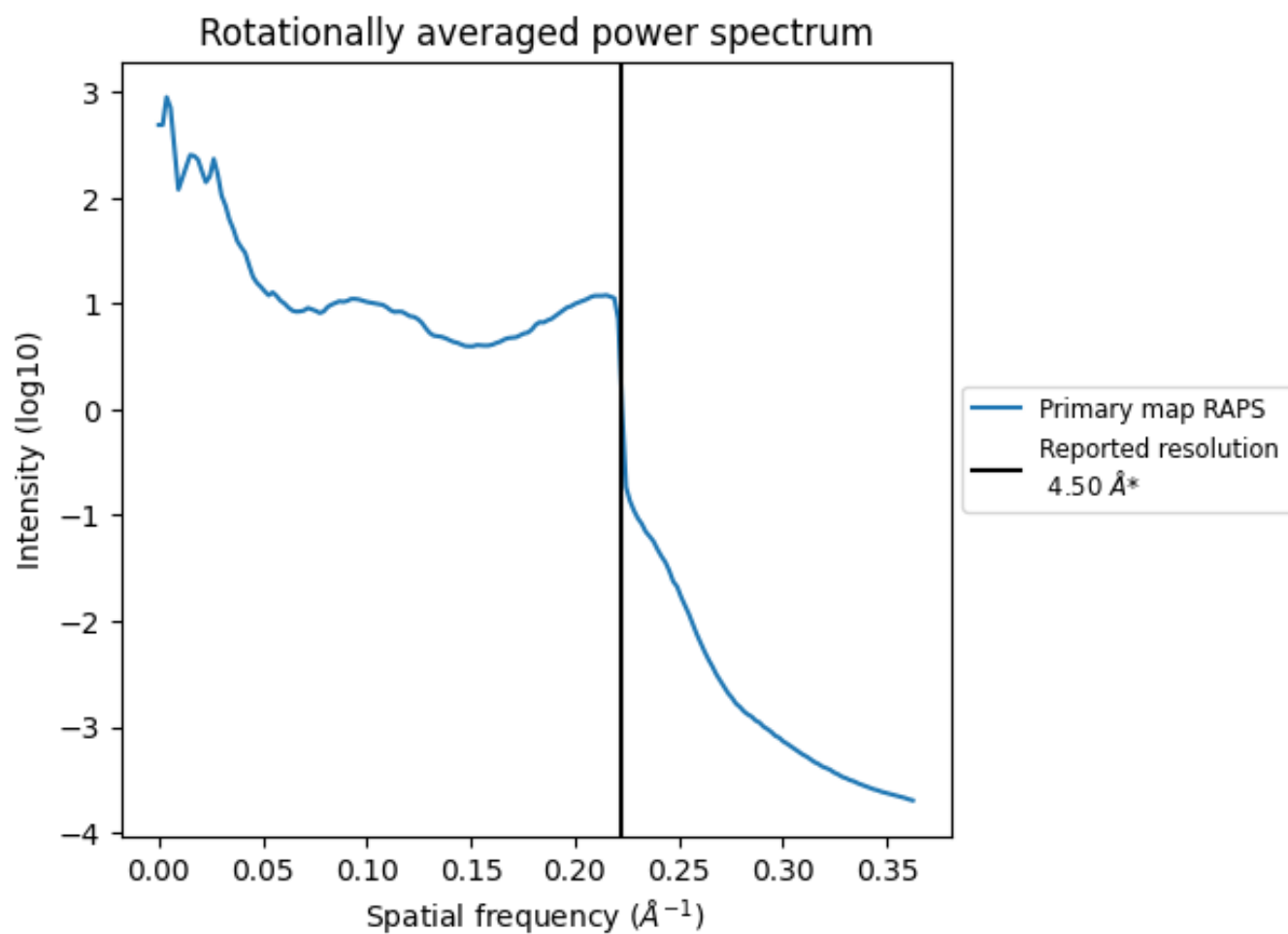

*Reported resolution corresponds to spatial frequency of 0.222 Å⁻¹

8 Fourier-Shell correlation

This section was not generated. No FSC curve or half-maps provided.

9 Map-model fit [i](#)

This section contains information regarding the fit between EMDB map EMD-4322 and PDB model 6FVW. Per-residue inclusion information can be found in section [3](#) on page [13](#).

9.1 Map-model overlay [i](#)

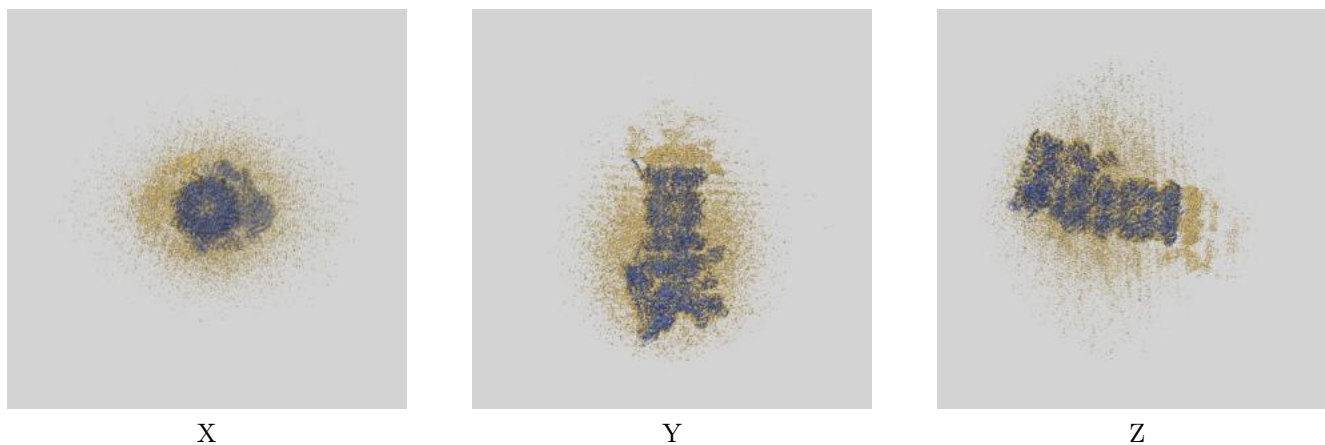

The images above show the 3D surface view of the map at the recommended contour level 0.02 at 50% transparency in yellow overlaid with a ribbon representation of the model coloured in blue. These images allow for the visual assessment of the quality of fit between the atomic model and the map.

9.2 Q-score mapped to coordinate model [i](#)

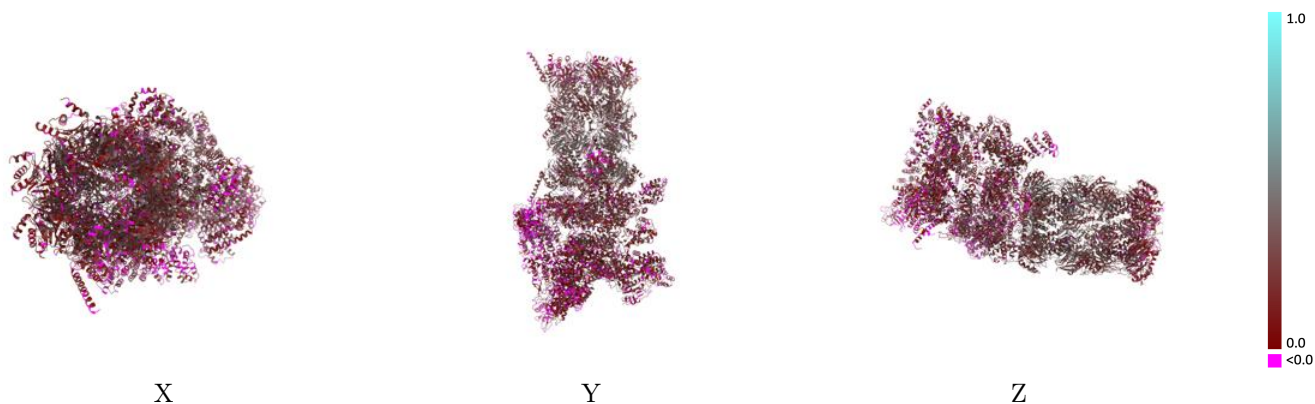

The images above show the model with each residue coloured according to its Q-score. This shows their resolvability in the map with higher Q-score values reflecting better resolvability. Please note: Q-score is calculating the resolvability of atoms, and thus high values are only expected at resolutions at which atoms can be resolved. Low Q-score values may therefore be expected for many entries.

9.3 Atom inclusion mapped to coordinate model [i](#)

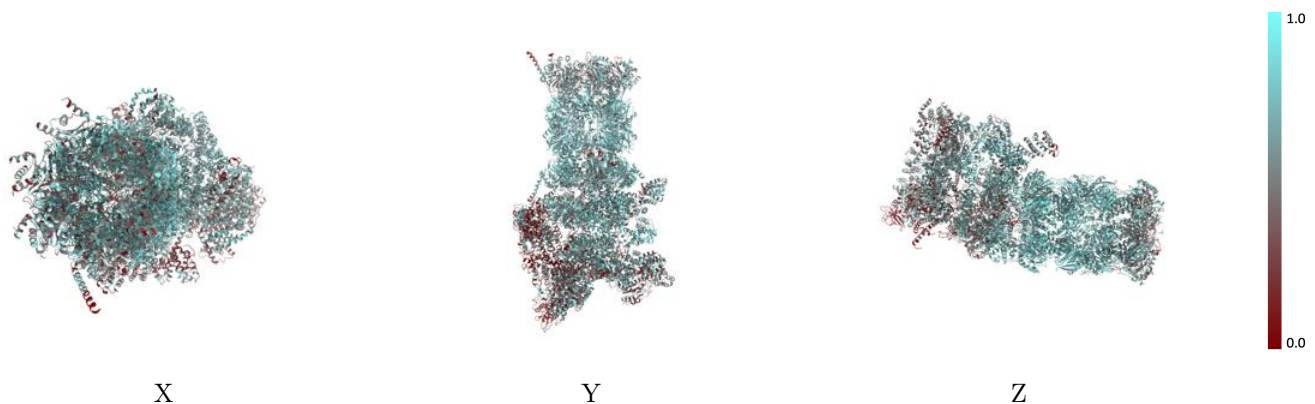

The images above show the model with each residue coloured according to its atom inclusion. This shows to what extent they are inside the map at the recommended contour level (0.02).



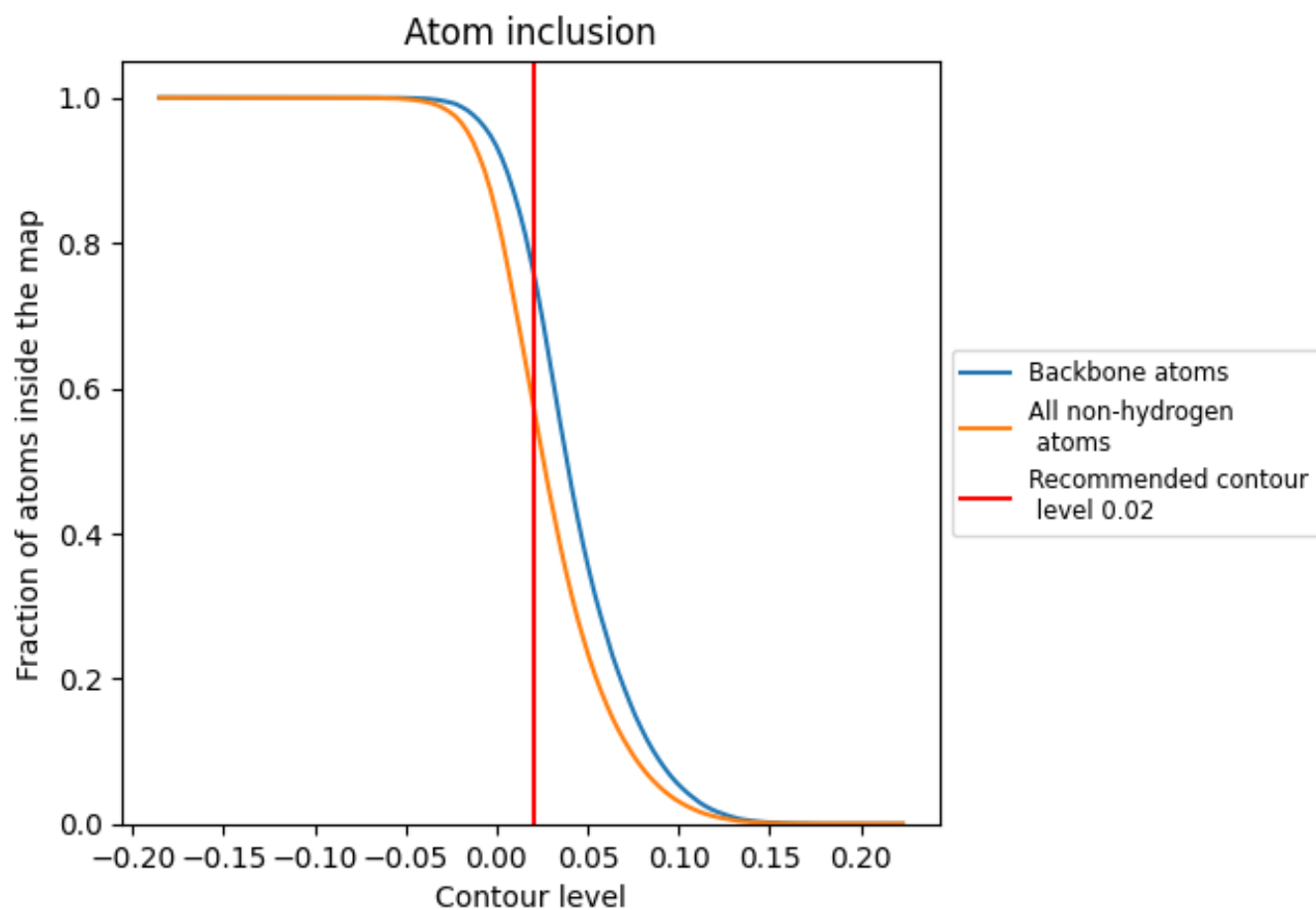



































































9.4 Atom inclusion [i](#)



At the recommended contour level, 76% of all backbone atoms, 58% of all non-hydrogen atoms, are inside the map.

9.5 Map-model fit summary



























The table lists the average atom inclusion at the recommended contour level (0.02) and Q-score for the entire model and for each chain.

Chain	Atom inclusion	Q-score
All	 0.5780	 0.2040
1	 0.7749	 0.3320
2	 0.7528	 0.3300
3	 0.7352	 0.3300
4	 0.7338	 0.3070
5	 0.7651	 0.3140
6	 0.7625	 0.3240
7	 0.7707	 0.3240
A	 0.7389	 0.3050
B	 0.7390	 0.3200
C	 0.7317	 0.2950
D	 0.7052	 0.2880
E	 0.7296	 0.3120
F	 0.7597	 0.3260
G	 0.7568	 0.3100
H	 0.5545	 0.2050
I	 0.6050	 0.2220
J	 0.5739	 0.2010
K	 0.6091	 0.2080
L	 0.4770	 0.1500
M	 0.5230	 0.1880
N	 0.4838	 0.1380
O	 0.4989	 0.1400
P	 0.6249	 0.1740
Q	 0.5863	 0.1670
R	 0.6086	 0.1790
S	 0.4385	 0.1320
T	 0.3997	 0.0990
U	 0.5504	 0.1900
V	 0.5841	 0.2010
W	 0.4052	 0.1250
X	 0.0385	 0.0180
Y	 0.3154	 0.0850
Z	 0.3415	 0.0390
a	 0.5302	 0.1750



Continued on next page...

Continued from previous page...

Chain	Atom inclusion	Q-score
b	 0.5134	 0.1790
c	 0.5409	 0.1860
d	 0.4877	 0.1540
e	 0.4957	 0.1560
f	 0.5526	 0.1980
g	 0.5536	 0.1860
h	 0.7062	 0.2840
i	 0.6973	 0.2820
j	 0.6787	 0.2750
k	 0.6893	 0.2680
l	 0.7035	 0.2790
m	 0.6934	 0.2770
n	 0.7201	 0.3030