



# Full wwPDB X-ray Structure Validation Report ⓘ

Aug 26, 2023 – 03:27 PM EDT

PDB ID : 3GGF  
Title : Crystal structure of human Serine/threonine-protein kinase MST4 in complex with an quinazolin  
Authors : Chaikuad, A.; Rellos, P.; Eidarus, S.; Das, S.; Pike, A.C.W.; Sethi, R.; Fedorov, O.; Savitsky, P.; Roos, A.K.; Filippakopoulos, P.; Arrowsmith, C.H.; Edwards, A.M.; Weigelt, J.; Bountra, C.; von Delft, F.; Knapp, S.; Structural Genomics Consortium (SGC)  
Deposited on : 2009-02-27  
Resolution : 2.35 Å(reported)

This is a Full wwPDB X-ray Structure Validation Report for a publicly released PDB entry.

We welcome your comments at [validation@mail.wwpdb.org](mailto:validation@mail.wwpdb.org)

A user guide is available at

<https://www.wwpdb.org/validation/2017/XrayValidationReportHelp>

with specific help available everywhere you see the ⓘ symbol.

The types of validation reports are described at

<http://www.wwpdb.org/validation/2017/FAQs#types>.

---

The following versions of software and data (see [references ⓘ](#)) were used in the production of this report:

MolProbity : 4.02b-467  
Mogul : 1.8.5 (274361), CSD as541be (2020)  
Xtriage (Phenix) : 1.13  
EDS : 2.35  
buster-report : 1.1.7 (2018)  
Percentile statistics : 20191225.v01 (using entries in the PDB archive December 25th 2019)  
Refmac : 5.8.0158  
CCP4 : 7.0.044 (Gargrove)  
Ideal geometry (proteins) : Engh & Huber (2001)

# 1 Overall quality at a glance

The following experimental techniques were used to determine the structure:

*X-RAY DIFFRACTION*

The reported resolution of this entry is 2.35 Å.

Percentile scores (ranging between 0-100) for global validation metrics of the entry are shown in the following graphic. The table shows the number of entries on which the scores are based.

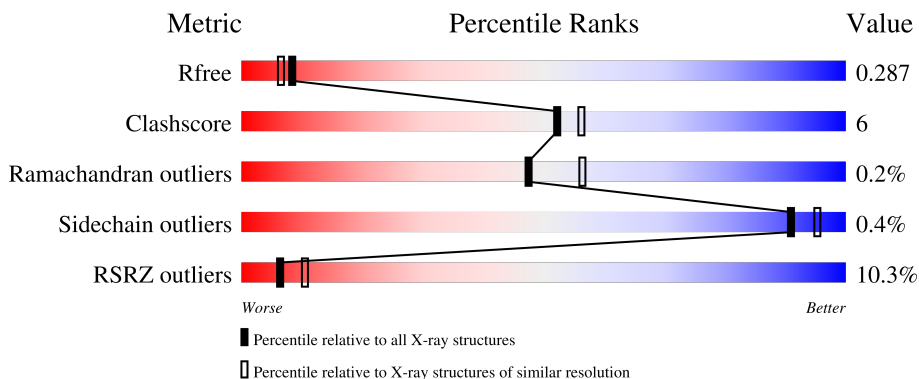

Metric	Whole archive (#Entries)	Similar resolution (#Entries, resolution range(Å))
$R_{free}$	130704	1164 (2.36-2.36)
Clashscore	141614	1232 (2.36-2.36)
Ramachandran outliers	138981	1211 (2.36-2.36)
Sidechain outliers	138945	1212 (2.36-2.36)
RSRZ outliers	127900	1150 (2.36-2.36)

The table below summarises the geometric issues observed across the polymeric chains and their fit to the electron density. The red, orange, yellow and green segments of the lower bar indicate the fraction of residues that contain outliers for  $\geq 3$ , 2, 1 and 0 types of geometric quality criteria respectively. A grey segment represents the fraction of residues that are not modelled. The numeric value for each fraction is indicated below the corresponding segment, with a dot representing fractions  $\leq 5\%$ . The upper red bar (where present) indicates the fraction of residues that have poor fit to the electron density. The numeric value is given above the bar.

Mol	Chain	Length	Quality of chain
1	A	301	 6% 81% 10% 9%
1	B	301	 12% 80% 10% 10%

Ideal geometry (DNA, RNA) : Parkinson et al. (1996)  
 Validation Pipeline (wwPDB-VP) : 2.35

## 2 Entry composition [i](#)

There are 4 unique types of molecules in this entry. The entry contains 4506 atoms, of which 0 are hydrogens and 0 are deuteriums.

In the tables below, the ZeroOcc column contains the number of atoms modelled with zero occupancy, the AltConf column contains the number of residues with at least one atom in alternate conformation and the Trace column contains the number of residues modelled with at most 2 atoms.

- Molecule 1 is a protein called Serine/threonine-protein kinase MST4.

Mol	Chain	Residues	Atoms					ZeroOcc	AltConf	Trace
			Total	C	N	O	S			
1	A	275	2171	1397	356	411	7	0	1	0
1	B	270	2124	1371	346	400	7	0	0	0

There are 2 discrepancies between the modelled and reference sequences:

Chain	Residue	Modelled	Actual	Comment	Reference
A	0	SER	-	expression tag	UNP Q9P289
B	0	SER	-	expression tag	UNP Q9P289

- Molecule 2 is CADMIUM ION (three-letter code: CD) (formula: Cd).

Mol	Chain	Residues	Atoms		ZeroOcc	AltConf
2	A	4	Total	Cd	0	0
			4	4		
2	B	3	Total	Cd	0	0
			3	3		

- Molecule 3 is [4-({4-[(5-CYCLOPROPYL-1H-PYRAZOL-3-YL)AMINO]QUINAZOLIN-2-YL}IMINO)CYCLOHEXA-2,5-DIEN-1-YL]ACETONITRILE (three-letter code: GVD) (formula: C<sub>22</sub>H<sub>19</sub>N<sub>7</sub>).

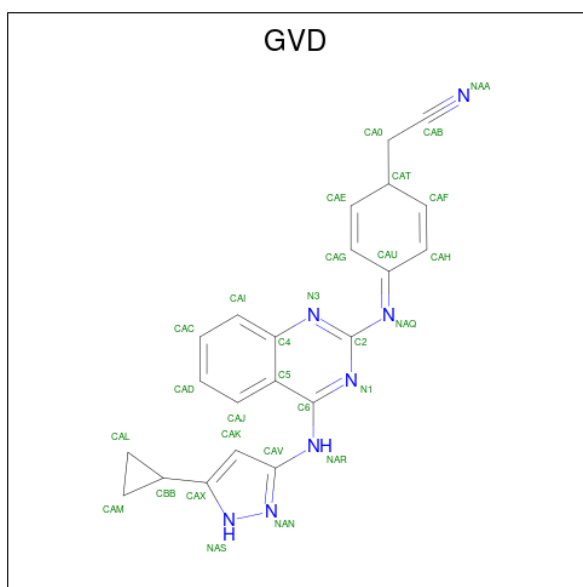

Mol	Chain	Residues	Atoms		ZeroOcc	AltConf
3	A	1	Total	C N	0	0
			29	22 7		
3	B	1	Total	C N	0	0
			29	22 7		

- Molecule 4 is water.

Mol	Chain	Residues	Atoms		ZeroOcc	AltConf
4	A	79	Total	O	0	0
			79	79		
4	B	67	Total	O	0	0
			67	67		

### 3 Residue-property plots [i](#)

These plots are drawn for all protein, RNA, DNA and oligosaccharide chains in the entry. The first graphic for a chain summarises the proportions of the various outlier classes displayed in the second graphic. The second graphic shows the sequence view annotated by issues in geometry and electron density. Residues are color-coded according to the number of geometric quality criteria for which they contain at least one outlier: green = 0, yellow = 1, orange = 2 and red = 3 or more. A red dot above a residue indicates a poor fit to the electron density ( $RSRZ > 2$ ). Stretches of 2 or more consecutive residues without any outlier are shown as a green connector. Residues present in the sample, but not in the model, are shown in grey.

- Molecule 1: Serine/threonine-protein kinase MST4

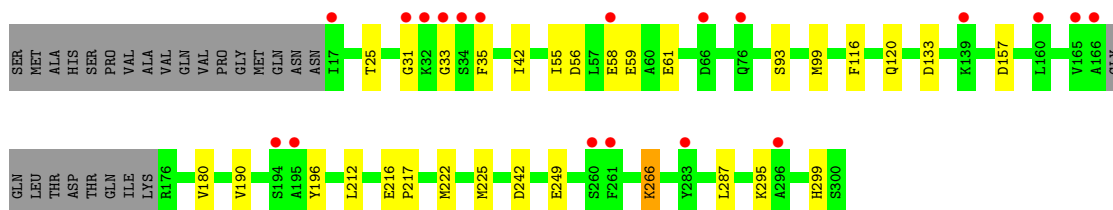
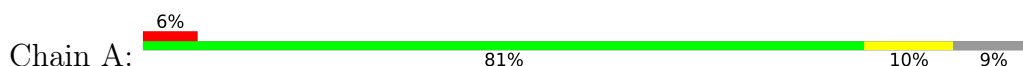

- Molecule 1: Serine/threonine-protein kinase MST4

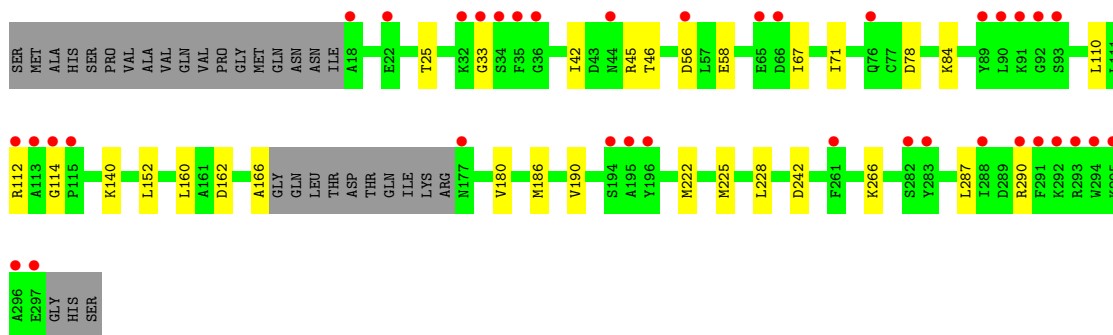
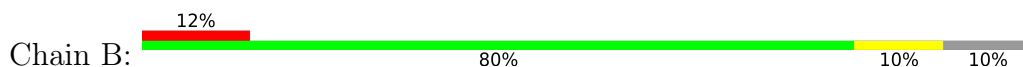

## 4 Data and refinement statistics

Property	Value	Source
Space group	P 21 21 21	Depositor
Cell constants a, b, c, $\alpha$ , $\beta$ , $\gamma$	65.92Å 91.25Å 108.97Å 90.00° 90.00° 90.00°	Depositor
Resolution (Å)	46.78 – 2.35 42.09 – 2.35	Depositor EDS
% Data completeness (in resolution range)	99.9 (46.78-2.35) 100.0 (42.09-2.35)	Depositor EDS
$R_{merge}$	0.14	Depositor
$R_{sym}$	(Not available)	Depositor
$\langle I/\sigma(I) \rangle$ <sup>1</sup>	2.03 (at 2.34Å)	Xtrriage
Refinement program	REFMAC 5.5.0085	Depositor
R, $R_{free}$	0.219 , 0.277 0.235 , 0.287	Depositor DCC
$R_{free}$ test set	1408 reflections (5.02%)	wwPDB-VP
Wilson B-factor (Å <sup>2</sup> )	32.5	Xtrriage
Anisotropy	0.148	Xtrriage
Bulk solvent $k_{sol}$ (e/Å <sup>3</sup> ), $B_{sol}$ (Å <sup>2</sup> )	0.38 , 48.2	EDS
L-test for twinning <sup>2</sup>	$\langle  L  \rangle = 0.48$ , $\langle L^2 \rangle = 0.31$	Xtrriage
Estimated twinning fraction	No twinning to report.	Xtrriage
$F_o, F_c$ correlation	0.92	EDS
Total number of atoms	4506	wwPDB-VP
Average B, all atoms (Å <sup>2</sup> )	22.0	wwPDB-VP

Xtrriage's analysis on translational NCS is as follows: *The analyses of the Patterson function reveals a significant off-origin peak that is 33.50 % of the origin peak, indicating pseudo-translational symmetry. The chance of finding a peak of this or larger height randomly in a structure without pseudo-translational symmetry is equal to 7.9252e-04. The detected translational NCS is most likely also responsible for the elevated intensity ratio.*

<sup>1</sup>Intensities estimated from amplitudes.

<sup>2</sup>Theoretical values of  $\langle |L| \rangle$ ,  $\langle L^2 \rangle$  for acentric reflections are 0.5, 0.333 respectively for untwinned datasets, and 0.375, 0.2 for perfectly twinned datasets.

## 5 Model quality

### 5.1 Standard geometry

Bond lengths and bond angles in the following residue types are not validated in this section: CD, GVD

The Z score for a bond length (or angle) is the number of standard deviations the observed value is removed from the expected value. A bond length (or angle) with  $|Z| > 5$  is considered an outlier worth inspection. RMSZ is the root-mean-square of all Z scores of the bond lengths (or angles).

Mol	Chain	Bond lengths		Bond angles	
		RMSZ	# Z  >5	RMSZ	# Z  >5
1	A	0.72	0/2216	0.72	0/2991
1	B	0.70	0/2168	0.72	0/2928
All	All	0.71	0/4384	0.72	0/5919

There are no bond length outliers.

There are no bond angle outliers.

There are no chirality outliers.

There are no planarity outliers.

### 5.2 Too-close contacts

In the following table, the Non-H and H(model) columns list the number of non-hydrogen atoms and hydrogen atoms in the chain respectively. The H(added) column lists the number of hydrogen atoms added and optimized by MolProbity. The Clashes column lists the number of clashes within the asymmetric unit, whereas Symm-Clashes lists symmetry-related clashes.

Mol	Chain	Non-H	H(model)	H(added)	Clashes	Symm-Clashes
1	A	2171	0	2160	31	2
1	B	2124	0	2119	21	2
2	A	4	0	0	0	1
2	B	3	0	0	0	1
3	A	29	0	18	2	0
3	B	29	0	18	2	0
4	A	79	0	0	7	0
4	B	67	0	0	1	2
All	All	4506	0	4315	48	4

The all-atom clashscore is defined as the number of clashes found per 1000 atoms (including hydrogen atoms). The all-atom clashscore for this structure is 6.

All (48) close contacts within the same asymmetric unit are listed below, sorted by their clash magnitude.

Atom-1	Atom-2	Interatomic distance (Å)	Clash overlap (Å)
1:A:33:GLY:CA	4:A:384:HOH:O	2.37	0.71
1:B:84:LYS:NZ	4:B:370:HOH:O	2.24	0.71
1:A:33:GLY:HA3	4:A:384:HOH:O	1.91	0.70
1:A:157:ASP:OD2	4:A:357:HOH:O	2.11	0.69
1:A:225:MET:HE2	1:B:180:VAL:HG13	1.74	0.69
1:A:120:GLN:NE2	1:A:287:LEU:CD1	2.57	0.67
1:A:120:GLN:CD	1:A:287:LEU:HD11	2.14	0.67
1:A:299:HIS:CG	1:A:299:HIS:O	2.52	0.62
1:A:33:GLY:N	4:A:384:HOH:O	2.33	0.61
1:A:180:VAL:HG13	1:B:225:MET:CE	2.31	0.60
1:B:114:GLY:O	1:B:290:ARG:NH2	2.33	0.60
3:B:304:GVD:N1	3:B:304:GVD:HAK	2.18	0.59
1:A:295:LYS:HE2	4:A:348:HOH:O	2.02	0.59
1:B:186:MET:HE2	1:B:190:VAL:HG12	1.84	0.59
1:A:61:GLU:CB	4:A:374:HOH:O	2.52	0.58
1:B:140:LYS:HB3	1:B:166:ALA:HB3	1.85	0.58
1:A:99:MET:CE	3:A:305:GVD:HAM1	2.36	0.56
3:B:304:GVD:N1	3:B:304:GVD:CAK	2.71	0.53
1:B:67:ILE:O	1:B:71:ILE:HG12	2.10	0.52
1:A:180:VAL:HG13	1:B:225:MET:HE3	1.91	0.52
1:B:110:LEU:HD13	1:B:287:LEU:HB3	1.92	0.52
1:A:59:GLU:OE2	1:B:112:ARG:NH2	2.45	0.49
1:A:35:PHE:HB2	1:A:55:ILE:HG22	1.96	0.48
1:A:180:VAL:HG13	1:B:225:MET:HE2	1.94	0.48
1:A:180:VAL:HG21	1:B:228:LEU:HD22	1.96	0.48
1:B:56:ASP:OD1	1:B:58:GLU:HB2	2.13	0.48
1:A:120:GLN:NE2	1:A:287:LEU:HD11	2.29	0.47
1:A:31:GLY:HA2	4:A:335:HOH:O	2.14	0.46
1:A:58:GLU:HA	1:A:93:SER:CB	2.45	0.46
1:A:99:MET:HE3	3:A:305:GVD:HAM1	1.99	0.45
1:A:120:GLN:CD	1:A:287:LEU:CD1	2.84	0.44
1:B:152:LEU:N	1:B:152:LEU:HD12	2.33	0.44
1:B:186:MET:HE2	1:B:190:VAL:CG1	2.48	0.44
1:A:133:ASP:OD1	1:A:266:LYS:HE3	2.18	0.43
1:B:25:THR:HB	1:B:42:ILE:CG2	2.49	0.43
1:A:216:GLU:HB2	1:A:217:PRO:HD2	2.00	0.43
1:A:116:PHE:CE2	1:A:212:LEU:HD22	2.55	0.42
1:A:58:GLU:HA	1:A:93:SER:HB3	2.00	0.42
1:B:25:THR:HB	1:B:42:ILE:HG22	2.01	0.42
1:A:56:ASP:OD1	1:A:58:GLU:HB2	2.20	0.41

*Continued on next page...*



Continued from previous page...

Atom-1	Atom-2	Interatomic distance (Å)	Clash overlap (Å)
1:A:222:MET:HB3	1:A:222:MET:HE2	1.89	0.41
1:B:45:ARG:HG2	1:B:46:THR:HG23	2.02	0.41
1:B:186:MET:CE	1:B:190:VAL:HG12	2.49	0.41
1:A:25:THR:HB	1:A:42:ILE:HG22	2.03	0.41
1:B:160:LEU:HB3	1:B:162:ASP:OD1	2.20	0.40
1:A:35:PHE:HB2	1:A:55:ILE:CG2	2.51	0.40
1:A:190:VAL:HG22	1:A:196:TYR:CG	2.56	0.40
1:B:222:MET:HE2	1:B:222:MET:HB3	1.92	0.40

All (4) symmetry-related close contacts are listed below. The label for Atom-2 includes the symmetry operator and encoded unit-cell translations to be applied.

Atom-1	Atom-2	Interatomic distance (Å)	Clash overlap (Å)
1:B:78:ASP:OD2	4:B:369:HOH:O[4_457]	2.04	0.16
1:A:242:ASP:OD2	2:A:302:CD:CD[4_447]	2.11	0.09
1:A:249:GLU:OE2	4:B:356:HOH:O[4_547]	2.14	0.06
1:B:242:ASP:OD2	2:B:302:CD:CD[4_557]	2.17	0.03

## 5.3 Torsion angles [i](#)

### 5.3.1 Protein backbone [i](#)

In the following table, the Percentiles column shows the percent Ramachandran outliers of the chain as a percentile score with respect to all X-ray entries followed by that with respect to entries of similar resolution.

The Analysed column shows the number of residues for which the backbone conformation was analysed, and the total number of residues.

Mol	Chain	Analysed	Favoured	Allowed	Outliers	Percentiles
1	A	272/301 (90%)	260 (96%)	12 (4%)	0	100 100
1	B	266/301 (88%)	254 (96%)	11 (4%)	1 (0%)	34 38
All	All	538/602 (89%)	514 (96%)	23 (4%)	1 (0%)	47 56

All (1) Ramachandran outliers are listed below:

Mol	Chain	Res	Type
1	B	33	GLY

### 5.3.2 Protein sidechains [i](#)

In the following table, the Percentiles column shows the percent sidechain outliers of the chain as a percentile score with respect to all X-ray entries followed by that with respect to entries of similar resolution.

The Analysed column shows the number of residues for which the sidechain conformation was analysed, and the total number of residues.

Mol	Chain	Analysed	Rotameric	Outliers	Percentiles	
1	A	233/261 (89%)	232 (100%)	1 (0%)	91	95
1	B	227/261 (87%)	226 (100%)	1 (0%)	91	95
All	All	460/522 (88%)	458 (100%)	2 (0%)	91	95

All (2) residues with a non-rotameric sidechain are listed below:

Mol	Chain	Res	Type
1	A	266	LYS
1	B	266	LYS

Sometimes sidechains can be flipped to improve hydrogen bonding and reduce clashes. There are no such sidechains identified.

### 5.3.3 RNA [i](#)

There are no RNA molecules in this entry.

## 5.4 Non-standard residues in protein, DNA, RNA chains [i](#)

There are no non-standard protein/DNA/RNA residues in this entry.

## 5.5 Carbohydrates [i](#)

There are no monosaccharides in this entry.

## 5.6 Ligand geometry [i](#)

Of 9 ligands modelled in this entry, 7 are monoatomic - leaving 2 for Mogul analysis.

In the following table, the Counts columns list the number of bonds (or angles) for which Mogul statistics could be retrieved, the number of bonds (or angles) that are observed in the model and the number of bonds (or angles) that are defined in the Chemical Component Dictionary. The

Link column lists molecule types, if any, to which the group is linked. The Z score for a bond length (or angle) is the number of standard deviations the observed value is removed from the expected value. A bond length (or angle) with  $|Z| > 2$  is considered an outlier worth inspection. RMSZ is the root-mean-square of all Z scores of the bond lengths (or angles).

Mol	Type	Chain	Res	Link	Bond lengths			Bond angles		
					Counts	RMSZ	# Z  > 2	Counts	RMSZ	# Z  > 2
3	GVD	A	305	2	28,33,33	2.54	8 (28%)	27,46,46	2.89	6 (22%)
3	GVD	B	304	2	28,33,33	2.69	9 (32%)	27,46,46	3.14	10 (37%)

In the following table, the Chirals column lists the number of chiral outliers, the number of chiral centers analysed, the number of these observed in the model and the number defined in the Chemical Component Dictionary. Similar counts are reported in the Torsion and Rings columns. '2' means no outliers of that kind were identified.

Mol	Type	Chain	Res	Link	Chirals	Torsions	Rings
3	GVD	A	305	2	-	3/12/27/27	0/5/5/5
3	GVD	B	304	2	-	5/12/27/27	0/5/5/5

All (17) bond length outliers are listed below:

Mol	Chain	Res	Type	Atoms	Z	Observed(Å)	Ideal(Å)
3	B	304	GVD	CAT-CAF	-6.48	1.38	1.50
3	A	305	GVD	NAS-NAN	-6.01	1.24	1.36
3	A	305	GVD	CAT-CAF	-5.99	1.39	1.50
3	B	304	GVD	CAK-CAV	-5.79	1.32	1.40
3	A	305	GVD	CAT-CAE	-5.79	1.39	1.50
3	B	304	GVD	CAT-CAE	-5.63	1.40	1.50
3	B	304	GVD	NAS-NAN	-5.43	1.25	1.36
3	B	304	GVD	CAG-CAE	4.19	1.41	1.33
3	A	305	GVD	CAK-CAV	-4.12	1.35	1.40
3	B	304	GVD	CAV-NAR	-3.78	1.34	1.39
3	A	305	GVD	CAG-CAE	3.57	1.40	1.33
3	A	305	GVD	CAH-CAF	3.49	1.40	1.33
3	B	304	GVD	CAK-CAX	-3.00	1.32	1.37
3	B	304	GVD	CAH-CAF	2.75	1.38	1.33
3	B	304	GVD	C4-N3	-2.36	1.33	1.38
3	A	305	GVD	CAK-CAX	-2.09	1.34	1.37
3	A	305	GVD	C5-C6	-2.08	1.40	1.43

All (16) bond angle outliers are listed below:

Mol	Chain	Res	Type	Atoms	Z	Observed(°)	Ideal(°)
3	A	305	GVD	CAV-NAN-NAS	10.07	109.77	103.66
3	B	304	GVD	CAV-NAN-NAS	7.93	108.47	103.66
3	B	304	GVD	CA0-CAT-CAE	6.93	125.07	111.82
3	B	304	GVD	CBB-CAX-CAK	-6.43	120.47	131.09
3	A	305	GVD	CAK-CAV-NAN	-6.16	107.99	112.13
3	A	305	GVD	CA0-CAT-CAF	5.42	122.19	111.82
3	B	304	GVD	CBB-CAX-NAS	4.59	129.63	122.62
3	B	304	GVD	CAK-CAV-NAN	-4.34	109.22	112.13
3	B	304	GVD	CAK-CAX-NAS	4.32	109.88	106.16
3	B	304	GVD	NAR-CAV-NAN	4.22	124.90	117.45
3	A	305	GVD	N1-C2-N3	-3.72	122.37	126.91
3	A	305	GVD	CA0-CAT-CAE	3.71	118.91	111.82
3	A	305	GVD	CAK-CAX-NAS	3.66	109.31	106.16
3	B	304	GVD	N1-C2-N3	-2.89	123.38	126.91
3	B	304	GVD	CAI-C4-C5	2.82	122.45	118.89
3	B	304	GVD	CA0-CAT-CAF	2.10	115.84	111.82

There are no chirality outliers.

All (8) torsion outliers are listed below:

Mol	Chain	Res	Type	Atoms
3	A	305	GVD	CAG-CAU-NAQ-C2
3	A	305	GVD	CAH-CAU-NAQ-C2
3	A	305	GVD	CAB-CA0-CAT-CAF
3	B	304	GVD	CAK-CAX-CBB-CAM
3	B	304	GVD	CAG-CAU-NAQ-C2
3	B	304	GVD	CAH-CAU-NAQ-C2
3	B	304	GVD	CAB-CA0-CAT-CAE
3	B	304	GVD	CAK-CAX-CBB-CAL

There are no ring outliers.

2 monomers are involved in 4 short contacts:

Mol	Chain	Res	Type	Clashes	Symm-Clashes
3	A	305	GVD	2	0
3	B	304	GVD	2	0

The following is a two-dimensional graphical depiction of Mogul quality analysis of bond lengths, bond angles, torsion angles, and ring geometry for all instances of the Ligand of Interest. In addition, ligands with molecular weight > 250 and outliers as shown on the validation Tables will also be included. For torsion angles, if less than 5% of the Mogul distribution of torsion angles is within 10 degrees of the torsion angle in question, then that torsion angle is considered an outlier. Any bond that is central to one or more torsion angles identified as an outlier by Mogul will be

highlighted in the graph. For rings, the root-mean-square deviation (RMSD) between the ring in question and similar rings identified by Mogul is calculated over all ring torsion angles. If the average RMSD is greater than 60 degrees and the minimal RMSD between the ring in question and any Mogul-identified rings is also greater than 60 degrees, then that ring is considered an outlier. The outliers are highlighted in purple. The color gray indicates Mogul did not find sufficient equivalents in the CSD to analyse the geometry.

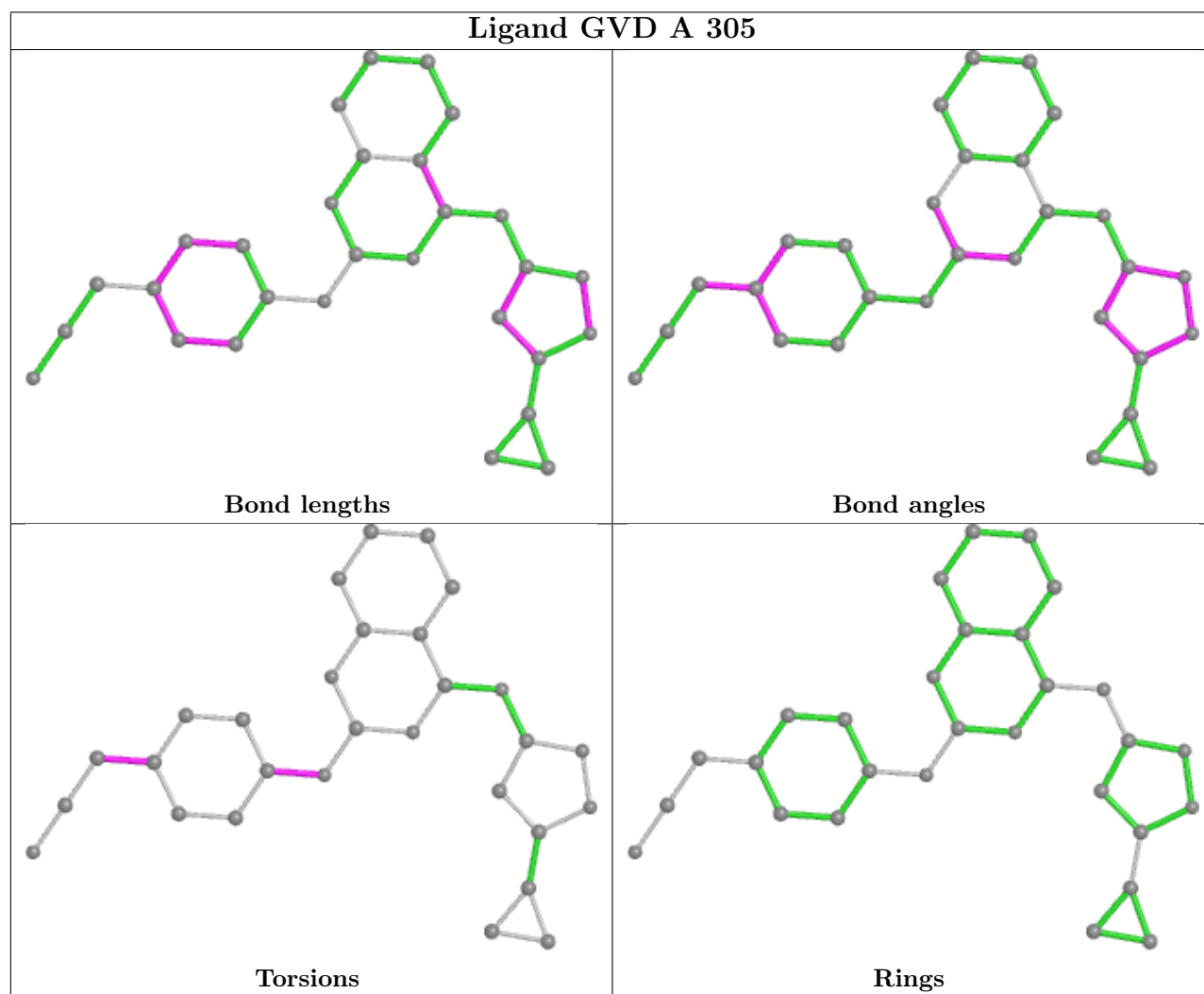

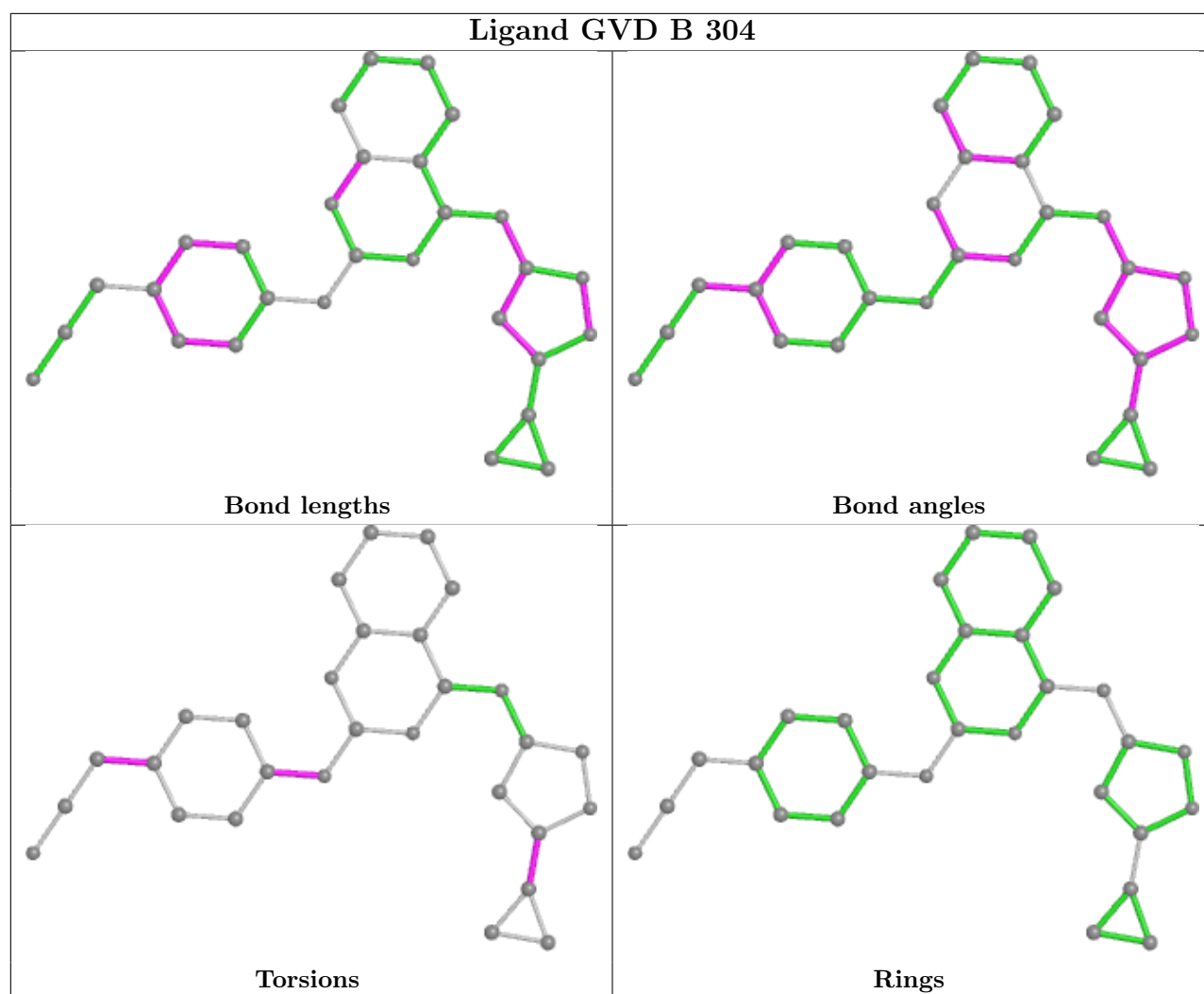

## 5.7 Other polymers [\(i\)](#)

There are no such residues in this entry.

## 5.8 Polymer linkage issues [\(i\)](#)

There are no chain breaks in this entry.

## 6 Fit of model and data

### 6.1 Protein, DNA and RNA chains

In the following table, the column labelled ‘#RSRZ > 2’ contains the number (and percentage) of RSRZ outliers, followed by percent RSRZ outliers for the chain as percentile scores relative to all X-ray entries and entries of similar resolution. The OWAB column contains the minimum, median, 95<sup>th</sup> percentile and maximum values of the occupancy-weighted average B-factor per residue. The column labelled ‘Q < 0.9’ lists the number of (and percentage) of residues with an average occupancy less than 0.9.

Mol	Chain	Analysed	<RSRZ>	#RSRZ>2	OWAB(Å <sup>2</sup> )	Q<0.9
1	A	275/301 (91%)	0.42	19 (6%) 16 24	4, 19, 46, 83	0
1	B	270/301 (89%)	0.59	37 (13%) 3 4	4, 19, 43, 73	0
All	All	545/602 (90%)	0.51	56 (10%) 6 10	4, 19, 44, 83	0

All (56) RSRZ outliers are listed below:

Mol	Chain	Res	Type	RSRZ
1	B	296	ALA	8.8
1	A	166	ALA	8.0
1	B	291	PHE	7.1
1	B	294	TRP	6.3
1	B	195	ALA	6.1
1	A	195	ALA	6.0
1	A	33	GLY	5.5
1	A	32	LYS	5.4
1	A	35	PHE	5.2
1	B	114	GLY	4.9
1	A	34	SER	4.6
1	B	295	LYS	4.2
1	B	297	GLU	4.2
1	B	33	GLY	4.1
1	A	66	ASP	4.1
1	A	17	ILE	4.1
1	B	65	GLU	3.7
1	B	34	SER	3.5
1	B	293	ARG	3.5
1	B	90	LEU	3.3
1	B	115	PRO	3.3
1	B	261	PHE	3.0
1	A	165	VAL	3.0
1	A	260	SER	2.9

*Continued on next page...*

*Continued from previous page...*

Mol	Chain	Res	Type	RSRZ
1	B	56	ASP	2.9
1	B	66	ASP	2.9
1	B	92	GLY	2.8
1	B	196	TYR	2.8
1	A	296	ALA	2.7
1	B	18	ALA	2.7
1	B	283	TYR	2.7
1	B	288	ILE	2.6
1	B	177	ASN	2.6
1	A	160	LEU	2.6
1	B	290	ARG	2.5
1	A	194	SER	2.5
1	A	76	GLN	2.5
1	B	32	LYS	2.5
1	A	261	PHE	2.4
1	B	194	SER	2.4
1	A	283	TYR	2.3
1	B	22	GLU	2.3
1	B	35	PHE	2.3
1	B	93	SER	2.3
1	A	58	GLU	2.3
1	B	36	GLY	2.3
1	A	139	LYS	2.2
1	B	292	LYS	2.2
1	B	91	LYS	2.2
1	B	282	SER	2.2
1	B	113	ALA	2.2
1	B	76	GLN	2.0
1	B	112	ARG	2.0
1	B	44	ASN	2.0
1	B	89	TYR	2.0
1	A	31	GLY	2.0

## 6.2 Non-standard residues in protein, DNA, RNA chains [i](#)

There are no non-standard protein/DNA/RNA residues in this entry.

## 6.3 Carbohydrates [i](#)

There are no monosaccharides in this entry.



## 6.4 Ligands

In the following table, the Atoms column lists the number of modelled atoms in the group and the number defined in the chemical component dictionary. The B-factors column lists the minimum, median, 95<sup>th</sup> percentile and maximum values of B factors of atoms in the group. The column labelled 'Q< 0.9' lists the number of atoms with occupancy less than 0.9.

Mol	Type	Chain	Res	Atoms	RSCC	RSR	B-factors(Å <sup>2</sup> )	Q<0.9
2	CD	B	303	1/1	0.73	0.12	59,59,59,59	1
3	GVD	B	304	29/29	0.94	0.17	5,22,44,55	0
2	CD	A	303	1/1	0.95	0.10	68,68,68,68	0
3	GVD	A	305	29/29	0.96	0.20	7,20,32,41	0
2	CD	A	301	1/1	0.99	0.10	43,43,43,43	1
2	CD	A	304	1/1	0.99	0.13	39,39,39,39	0
2	CD	B	301	1/1	0.99	0.12	48,48,48,48	0
2	CD	B	302	1/1	1.00	0.17	22,22,22,22	0
2	CD	A	302	1/1	1.00	0.17	23,23,23,23	0

The following is a graphical depiction of the model fit to experimental electron density of all instances of the Ligand of Interest. In addition, ligands with molecular weight > 250 and outliers as shown on the geometry validation Tables will also be included. Each fit is shown from different orientation to approximate a three-dimensional view.

**Electron density around GVD B 304:**

$2mF_o-DF_c$  (at 0.7 rmsd) in gray  
 $mF_o-DF_c$  (at 3 rmsd) in purple (negative)  
and green (positive)

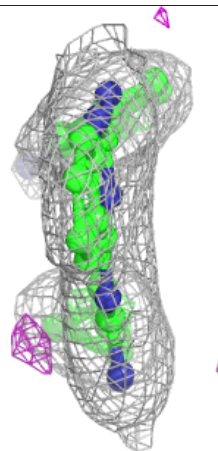
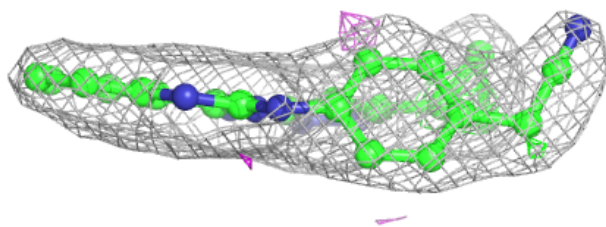
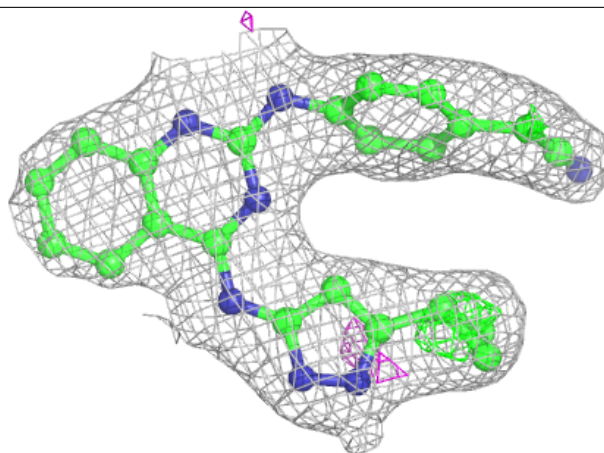

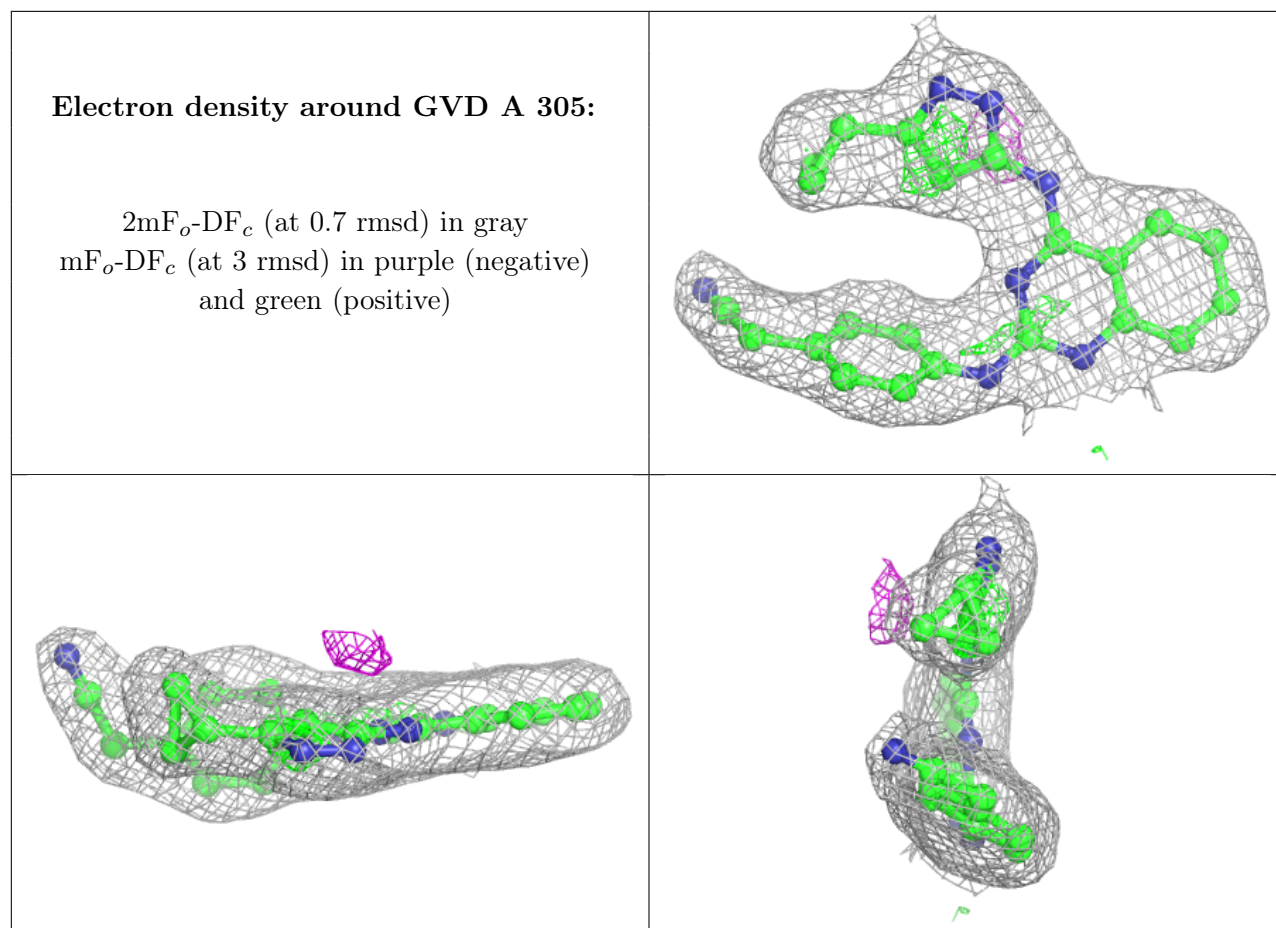

## 6.5 Other polymers [i](#)

There are no such residues in this entry.