



wwPDB X-ray Structure Validation Summary Report ⓘ

Aug 27, 2023 – 01:08 PM EDT

PDB ID : 3GYR
Title : Structure of Phenoxazinone synthase from Streptomyces antibioticus reveals a new type 2 copper center.
Authors : Smith, A.W.; Camara-Artigas, A.; Wang, M.; Francisco, W.A.; Allen, J.P.
Deposited on : 2009-04-05
Resolution : 2.30 Å (reported)

This is a wwPDB X-ray Structure Validation Summary Report for a publicly released PDB entry.

We welcome your comments at validation@mail.wwpdb.org

A user guide is available at

<https://www.wwpdb.org/validation/2017/XrayValidationReportHelp>

with specific help available everywhere you see the ⓘ symbol.

The types of validation reports are described at

<http://www.wwpdb.org/validation/2017/FAQs#types>.

The following versions of software and data (see [references ⓘ](#)) were used in the production of this report:

MolProbity : 4.02b-467
Mogul : 1.8.5 (274361), CSD as541be (2020)
Xtriage (Phenix) : 1.13
EDS : 2.35
Percentile statistics : 20191225.v01 (using entries in the PDB archive December 25th 2019)
Refmac : 5.8.0158
CCP4 : 7.0.044 (Gargrove)
Ideal geometry (proteins) : Engh & Huber (2001)
Ideal geometry (DNA, RNA) : Parkinson et al. (1996)
Validation Pipeline (wwPDB-VP) : 2.35

1 Overall quality at a glance

The following experimental techniques were used to determine the structure:

X-RAY DIFFRACTION

The reported resolution of this entry is 2.30 Å.

Percentile scores (ranging between 0-100) for global validation metrics of the entry are shown in the following graphic. The table shows the number of entries on which the scores are based.

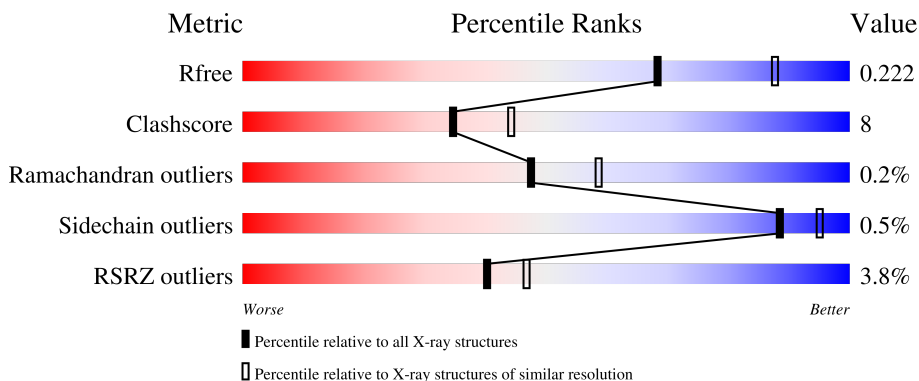

Metric	Whole archive (#Entries)	Similar resolution (#Entries, resolution range(Å))
R_{free}	130704	5042 (2.30-2.30)
Clashscore	141614	5643 (2.30-2.30)
Ramachandran outliers	138981	5575 (2.30-2.30)
Sidechain outliers	138945	5575 (2.30-2.30)
RSRZ outliers	127900	4938 (2.30-2.30)

The table below summarises the geometric issues observed across the polymeric chains and their fit to the electron density. The red, orange, yellow and green segments of the lower bar indicate the fraction of residues that contain outliers for ≥ 3 , 2, 1 and 0 types of geometric quality criteria respectively. A grey segment represents the fraction of residues that are not modelled. The numeric value for each fraction is indicated below the corresponding segment, with a dot representing fractions $\leq 5\%$. The upper red bar (where present) indicates the fraction of residues that have poor fit to the electron density. The numeric value is given above the bar.

Mol	Chain	Length	Quality of chain
1	A	612	
1	B	612	
1	C	612	
1	D	612	
1	E	612	

Continued on next page...

Continued from previous page...

Mol	Chain	Length	Quality of chain
1	F	612	<p>4% 81% 14% . .</p>
1	G	612	<p>4% 82% 13% . .</p>
1	H	612	<p>3% 80% 16% .</p>
1	I	612	<p>5% 78% 17% . .</p>
1	J	612	<p>3% 81% 15% . .</p>
1	K	612	<p>4% 79% 16% .</p>
1	L	612	<p>4% 80% 15% . .</p>

2 Entry composition [i](#)

There are 5 unique types of molecules in this entry. The entry contains 59241 atoms, of which 0 are hydrogens and 0 are deuteriums.

In the tables below, the ZeroOcc column contains the number of atoms modelled with zero occupancy, the AltConf column contains the number of residues with at least one atom in alternate conformation and the Trace column contains the number of residues modelled with at most 2 atoms.

- Molecule 1 is a protein called Phenoxazinone synthase.

Mol	Chain	Residues	Atoms					ZeroOcc	AltConf	Trace
			Total	C	N	O	S			
1	A	587	4560	2886	812	847	15	0	0	0
1	B	587	4560	2886	812	847	15	0	0	0
1	C	587	4560	2886	812	847	15	0	0	0
1	D	587	4560	2886	812	847	15	0	0	0
1	E	587	4560	2886	812	847	15	0	0	0
1	F	587	4560	2886	812	847	15	0	0	0
1	G	587	4560	2886	812	847	15	0	0	0
1	H	587	4560	2886	812	847	15	0	0	0
1	I	587	4560	2886	812	847	15	0	0	0
1	J	587	4560	2886	812	847	15	0	0	0
1	K	587	4560	2886	812	847	15	0	0	0
1	L	587	4560	2886	812	847	15	0	0	0

There are 12 discrepancies between the modelled and reference sequences:

Chain	Residue	Modelled	Actual	Comment	Reference
A	496	ARG	ALA	engineered mutation	UNP Q53692
B	496	ARG	ALA	engineered mutation	UNP Q53692
C	496	ARG	ALA	engineered mutation	UNP Q53692
D	496	ARG	ALA	engineered mutation	UNP Q53692
E	496	ARG	ALA	engineered mutation	UNP Q53692

Continued on next page...

Continued from previous page...

Chain	Residue	Modelled	Actual	Comment	Reference
F	496	ARG	ALA	engineered mutation	UNP Q53692
G	496	ARG	ALA	engineered mutation	UNP Q53692
H	496	ARG	ALA	engineered mutation	UNP Q53692
I	496	ARG	ALA	engineered mutation	UNP Q53692
J	496	ARG	ALA	engineered mutation	UNP Q53692
K	496	ARG	ALA	engineered mutation	UNP Q53692
L	496	ARG	ALA	engineered mutation	UNP Q53692

- Molecule 2 is COPPER (II) ION (three-letter code: CU) (formula: Cu).

Mol	Chain	Residues	Atoms	ZeroOcc	AltConf
2	A	3	Total Cu 3 3	0	0
2	B	3	Total Cu 3 3	0	0
2	C	3	Total Cu 3 3	0	0
2	D	3	Total Cu 3 3	0	0
2	E	3	Total Cu 3 3	0	0
2	F	3	Total Cu 3 3	0	0
2	G	3	Total Cu 3 3	0	0
2	H	3	Total Cu 3 3	0	0
2	I	3	Total Cu 3 3	0	0
2	J	3	Total Cu 3 3	0	0
2	K	3	Total Cu 3 3	0	0
2	L	3	Total Cu 3 3	0	0

- Molecule 3 is CU-O-CU LINKAGE (three-letter code: C2O) (formula: Cu₂O).

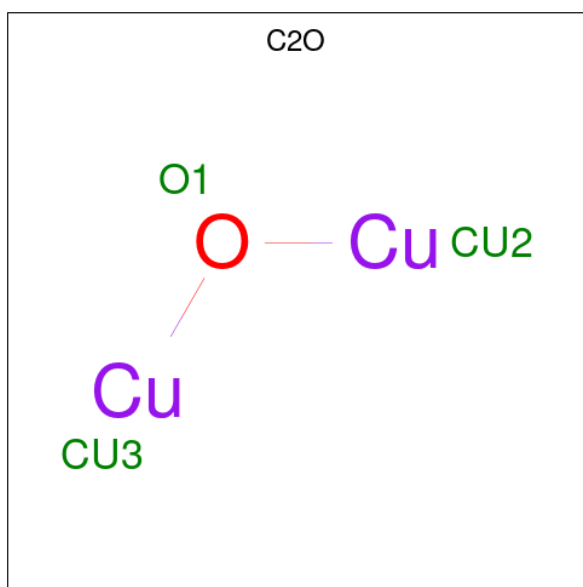

Mol	Chain	Residues	Atoms			ZeroOcc	AltConf
			Total	Cu	O		
3	A	1	3	2	1	0	0
3	B	1	3	2	1	0	0
3	C	1	3	2	1	0	0
3	D	1	3	2	1	0	0
3	E	1	3	2	1	0	0
3	F	1	3	2	1	0	0
3	G	1	3	2	1	0	0
3	H	1	3	2	1	0	0
3	I	1	3	2	1	0	0
3	J	1	3	2	1	0	0
3	K	1	3	2	1	0	0
3	L	1	3	2	1	0	0

- Molecule 4 is GLYCEROL (three-letter code: GOL) (formula: C₃H₈O₃).



Mol	Chain	Residues	Atoms	ZeroOcc	AltConf
4	A	1	Total C O 6 3 3	0	0
4	B	1	Total C O 6 3 3	0	0
4	C	1	Total C O 6 3 3	0	0
4	D	1	Total C O 6 3 3	0	0
4	E	1	Total C O 6 3 3	0	0
4	F	1	Total C O 6 3 3	0	0
4	G	1	Total C O 6 3 3	0	0
4	H	1	Total C O 6 3 3	0	0
4	I	1	Total C O 6 3 3	0	0
4	J	1	Total C O 6 3 3	0	0
4	K	1	Total C O 6 3 3	0	0
4	L	1	Total C O 6 3 3	0	0

- Molecule 5 is water.

Mol	Chain	Residues	Atoms		ZeroOcc	AltConf
5	A	354	Total 354	O 354	0	0
5	B	362	Total 362	O 362	0	0
5	C	398	Total 398	O 398	0	0
5	D	386	Total 386	O 386	0	0
5	E	357	Total 357	O 357	0	0
5	F	361	Total 361	O 361	0	0
5	G	359	Total 359	O 359	0	0
5	H	376	Total 376	O 376	0	0
5	I	330	Total 330	O 330	0	0
5	J	388	Total 388	O 388	0	0
5	K	359	Total 359	O 359	0	0
5	L	347	Total 347	O 347	0	0

3 Residue-property plots [i](#)

These plots are drawn for all protein, RNA, DNA and oligosaccharide chains in the entry. The first graphic for a chain summarises the proportions of the various outlier classes displayed in the second graphic. The second graphic shows the sequence view annotated by issues in geometry and electron density. Residues are color-coded according to the number of geometric quality criteria for which they contain at least one outlier: green = 0, yellow = 1, orange = 2 and red = 3 or more. A red dot above a residue indicates a poor fit to the electron density ($RSRZ > 2$). Stretches of 2 or more consecutive residues without any outlier are shown as a green connector. Residues present in the sample, but not in the model, are shown in grey.

- Molecule 1: Phenoxazinone synthase

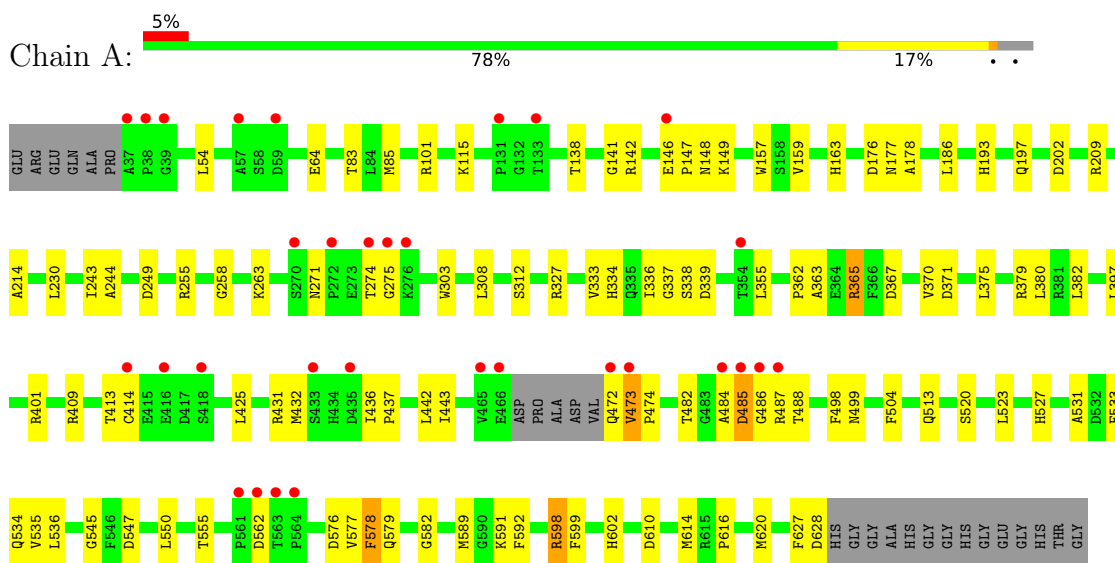

- Molecule 1: Phenoxazinone synthase

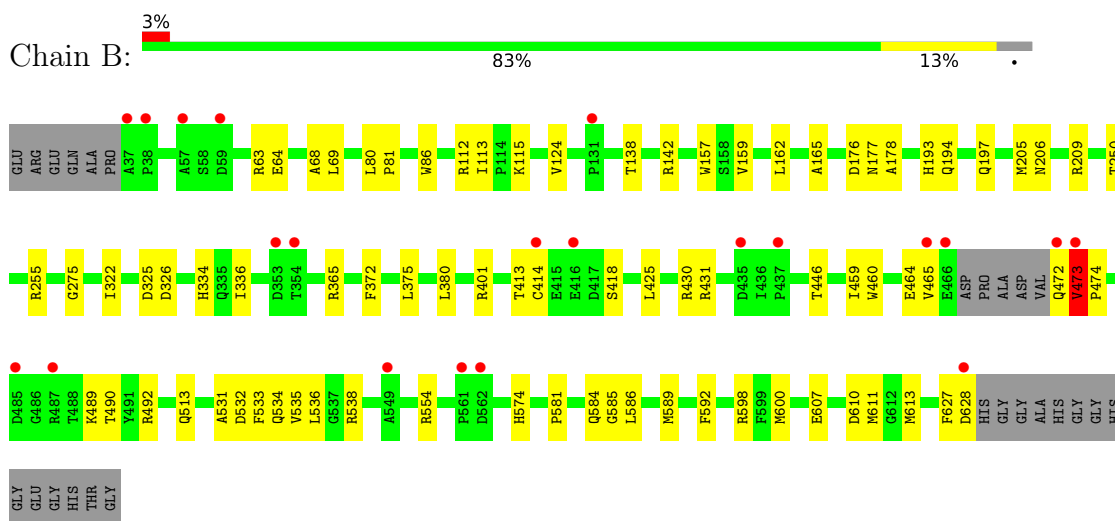

- Molecule 1: Phenoxazinone synthase

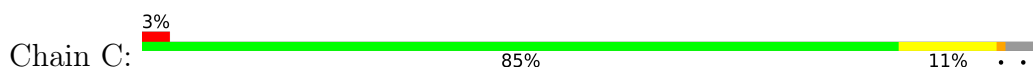

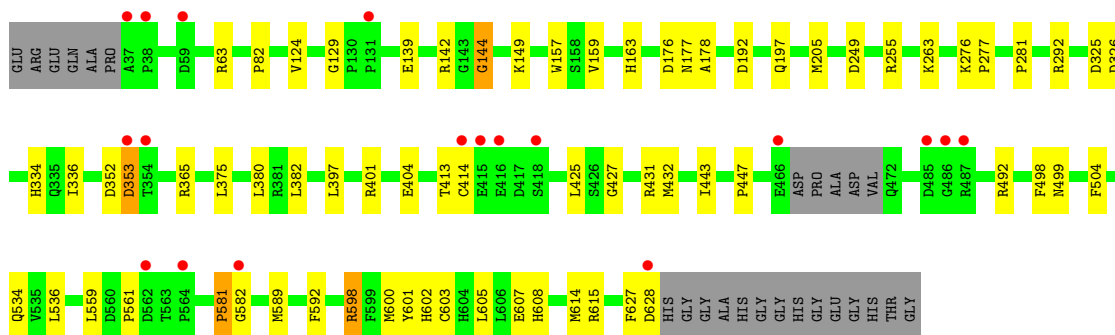

• Molecule 1: Phenoxazinone synthase

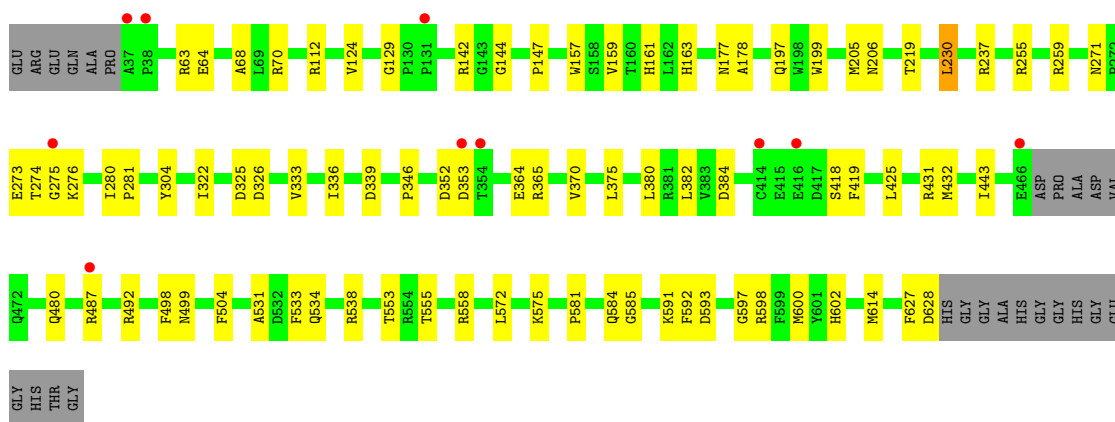
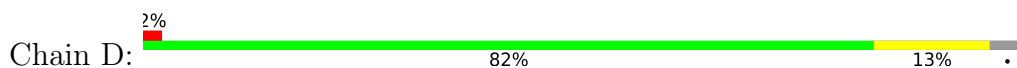

• Molecule 1: Phenoxazinone synthase

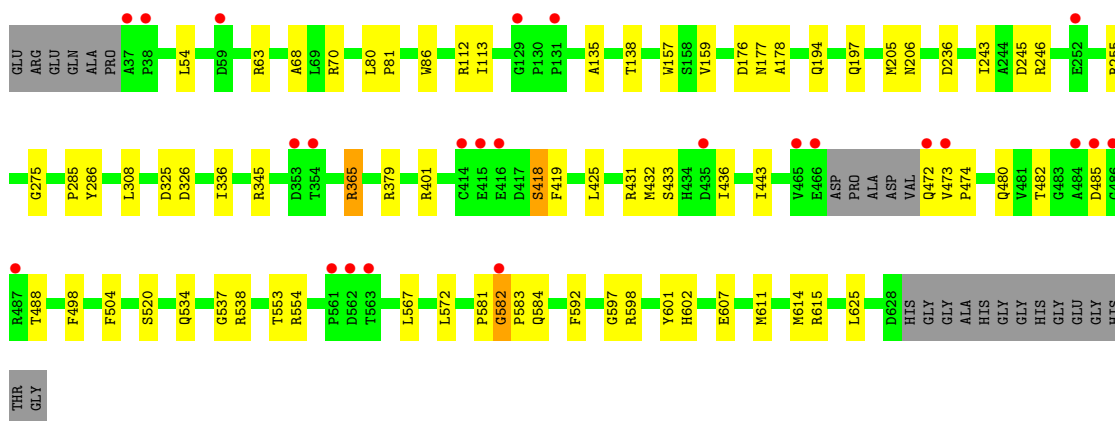
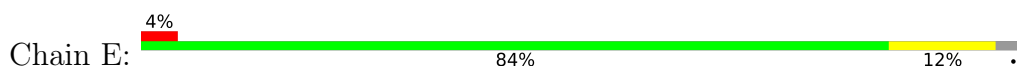

• Molecule 1: Phenoxazinone synthase

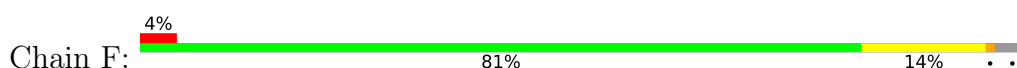

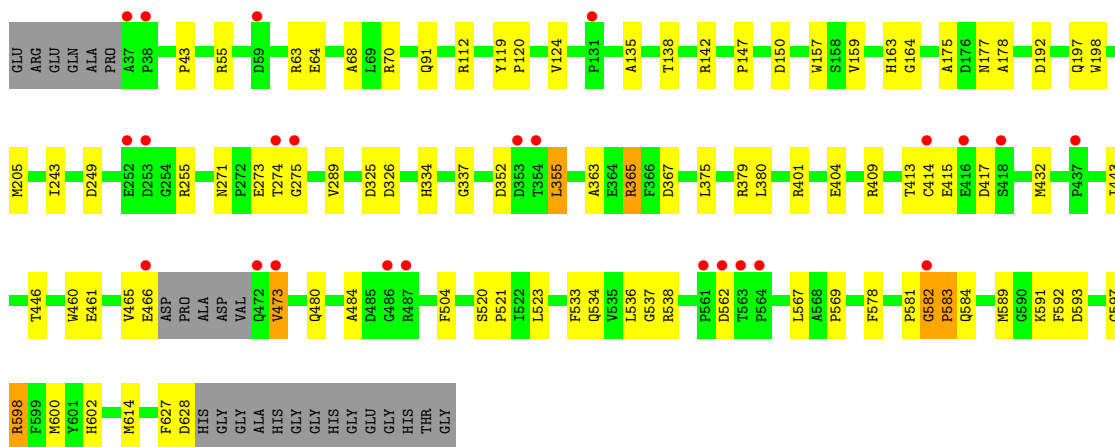

• Molecule 1: Phenoxazinone synthase

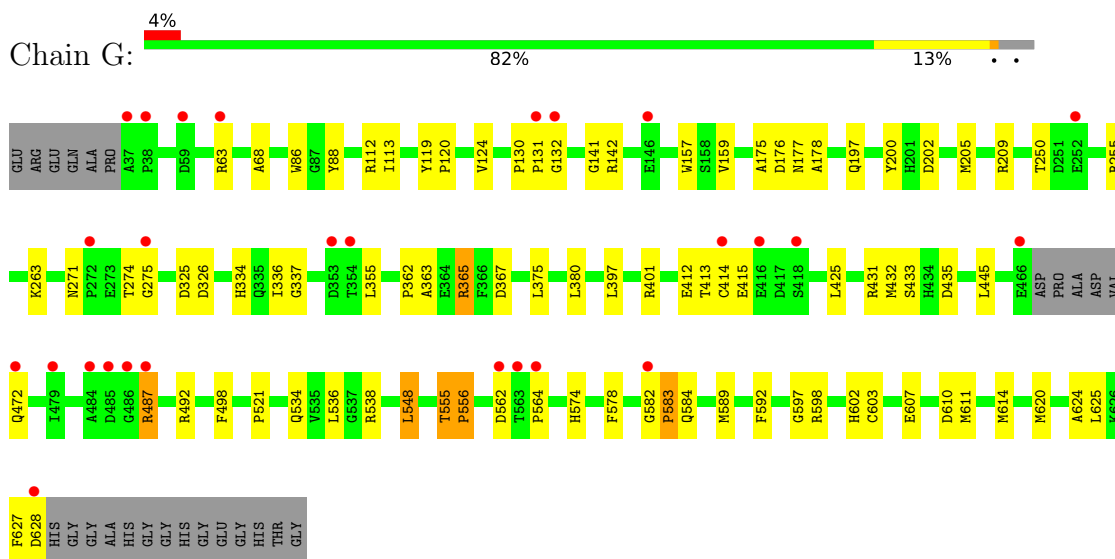

• Molecule 1: Phenoxazinone synthase

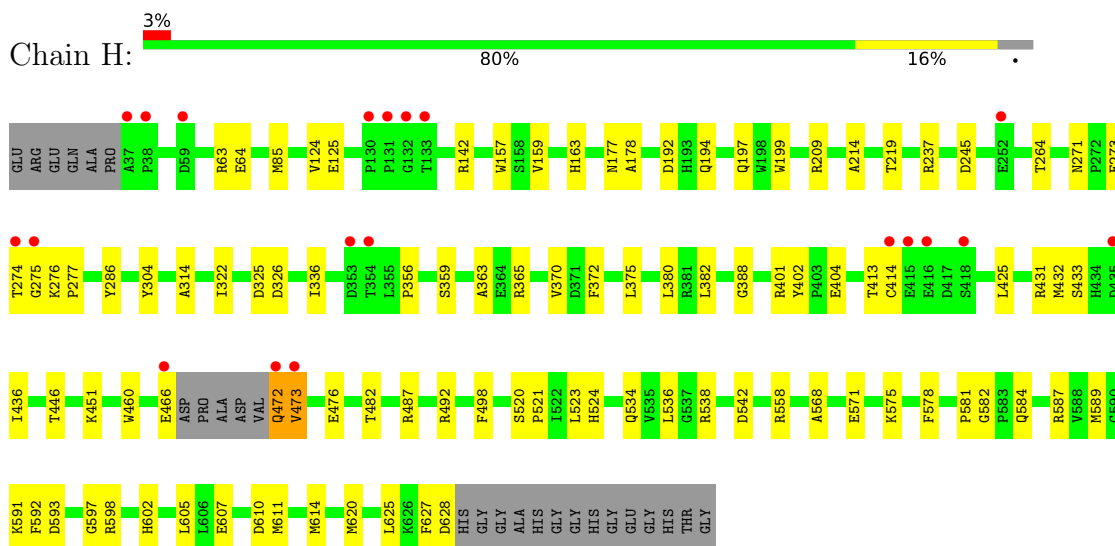

• Molecule 1: Phenoxazinone synthase

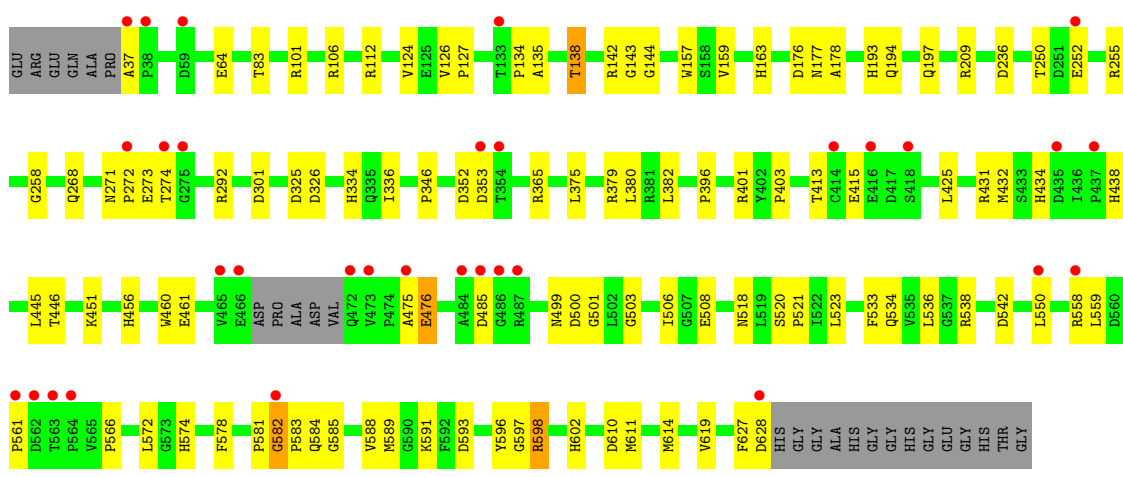
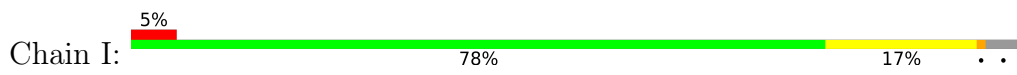

• Molecule 1: Phenoxazinone synthase

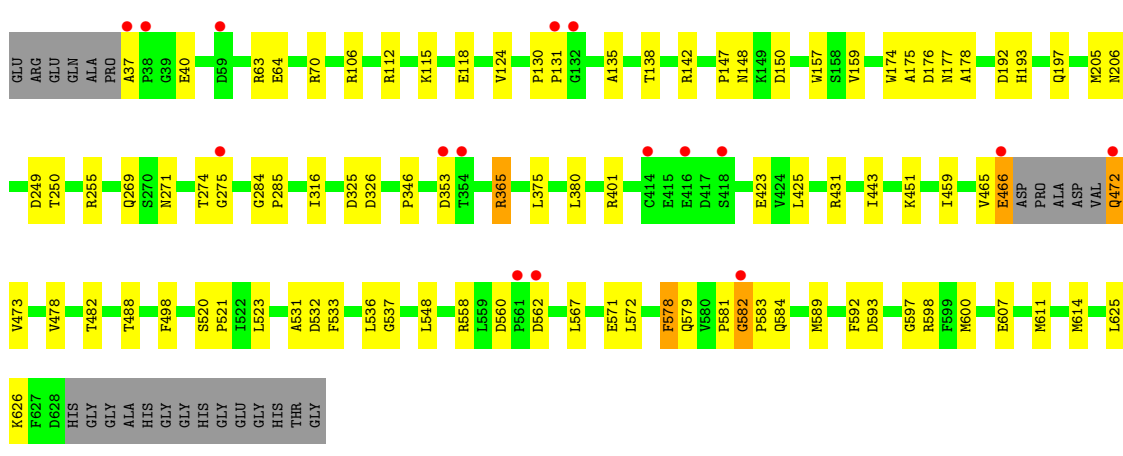
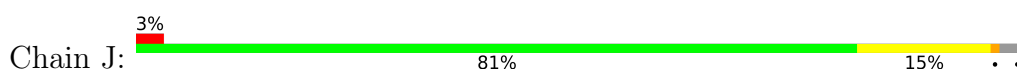

• Molecule 1: Phenoxazinone synthase

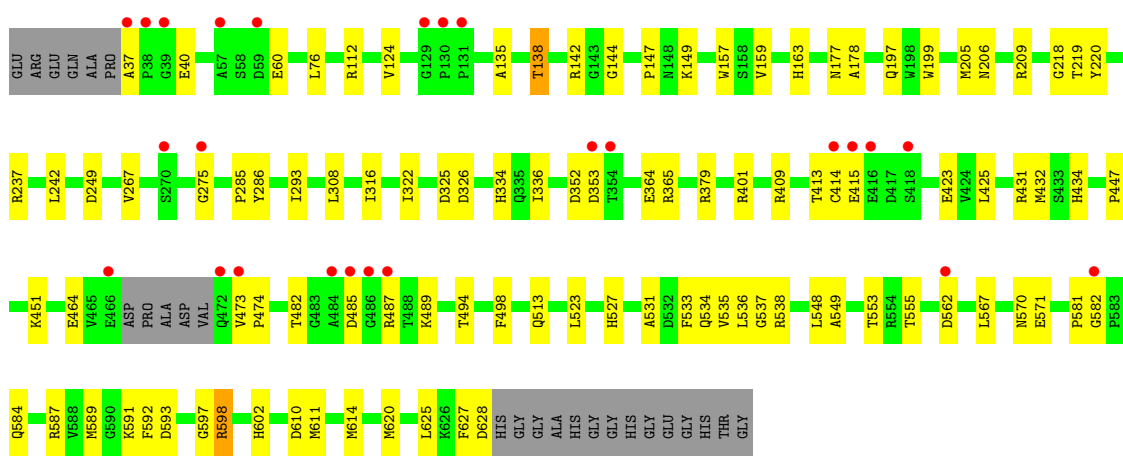
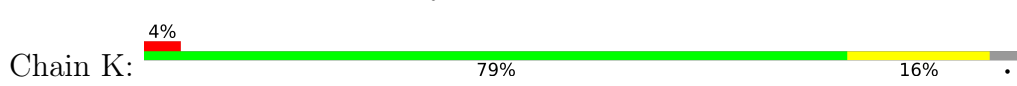

- Molecule 1: Phenoxazinone synthase

Chain L: 4% 80% 15%

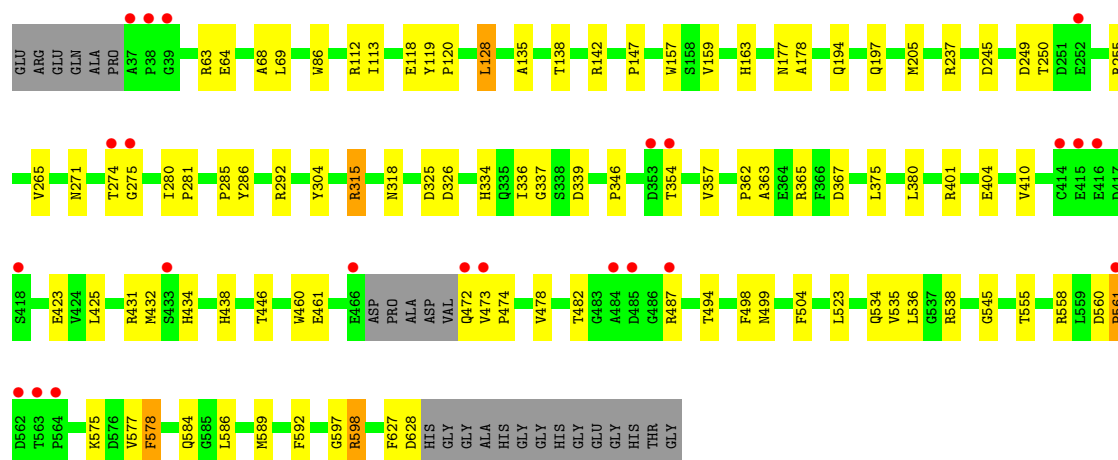

4 Data and refinement statistics

Property	Value	Source
Space group	P 1	Depositor
Cell constants a, b, c, α , β , γ	109.49Å 163.46Å 164.35Å 117.04° 95.74° 107.23°	Depositor
Resolution (Å)	20.00 – 2.30 20.00 – 2.30	Depositor EDS
% Data completeness (in resolution range)	86.3 (20.00-2.30) 86.3 (20.00-2.30)	Depositor EDS
R_{merge}	0.08	Depositor
R_{sym}	0.06	Depositor
$\langle I/\sigma(I) \rangle$ ¹	2.54 (at 2.30Å)	Xtrriage
Refinement program	REFMAC 5.5.0072, CNS	Depositor
R, R_{free}	0.165 , 0.222 0.165 , 0.222	Depositor DCC
R_{free} test set	17920 reflections (5.02%)	wwPDB-VP
Wilson B-factor (Å ²)	29.2	Xtrriage
Anisotropy	0.053	Xtrriage
Bulk solvent k_{sol} (e/Å ³), B_{sol} (Å ²)	0.37 , 53.2	EDS
L-test for twinning ²	$\langle L \rangle = 0.49$, $\langle L^2 \rangle = 0.32$	Xtrriage
Estimated twinning fraction	0.007 for -h,h+k+1,-l	Xtrriage
F_o, F_c correlation	0.96	EDS
Total number of atoms	59241	wwPDB-VP
Average B, all atoms (Å ²)	27.0	wwPDB-VP

Xtrriage's analysis on translational NCS is as follows: *The largest off-origin peak in the Patterson function is 3.55% of the height of the origin peak. No significant pseudotranslation is detected.*

¹Intensities estimated from amplitudes.

²Theoretical values of $\langle |L| \rangle$, $\langle L^2 \rangle$ for acentric reflections are 0.5, 0.333 respectively for untwinned datasets, and 0.375, 0.2 for perfectly twinned datasets.

5 Model quality i

5.1 Standard geometry i

Bond lengths and bond angles in the following residue types are not validated in this section: GOL, CU, C2O

The Z score for a bond length (or angle) is the number of standard deviations the observed value is removed from the expected value. A bond length (or angle) with $|Z| > 5$ is considered an outlier worth inspection. RMSZ is the root-mean-square of all Z scores of the bond lengths (or angles).

Mol	Chain	Bond lengths		Bond angles	
		RMSZ	# Z >5	RMSZ	# Z >5
1	A	0.66	0/4697	0.75	4/6423 (0.1%)
1	B	0.65	0/4697	0.74	0/6423
1	C	0.68	1/4697 (0.0%)	0.76	2/6423 (0.0%)
1	D	0.67	0/4697	0.73	2/6423 (0.0%)
1	E	0.67	0/4697	0.74	2/6423 (0.0%)
1	F	0.67	0/4697	0.74	3/6423 (0.0%)
1	G	0.69	1/4697 (0.0%)	0.76	2/6423 (0.0%)
1	H	0.66	0/4697	0.74	2/6423 (0.0%)
1	I	0.67	0/4697	0.74	3/6423 (0.0%)
1	J	0.67	0/4697	0.75	5/6423 (0.1%)
1	K	0.66	0/4697	0.74	2/6423 (0.0%)
1	L	0.65	0/4697	0.74	3/6423 (0.0%)
All	All	0.67	2/56364 (0.0%)	0.74	30/77076 (0.0%)

Chiral center outliers are detected by calculating the chiral volume of a chiral center and verifying if the center is modelled as a planar moiety or with the opposite hand. A planarity outlier is detected by checking planarity of atoms in a peptide group, atoms in a mainchain group or atoms of a sidechain that are expected to be planar.

Mol	Chain	#Chirality outliers	#Planarity outliers
1	A	0	2
1	B	0	4
1	C	0	5
1	D	0	5
1	E	0	2
1	F	0	4
1	G	0	2
1	H	0	2
1	I	0	1
1	J	0	3
1	K	0	5

Continued on next page...

Continued from previous page...

Mol	Chain	#Chirality outliers	#Planarity outliers
1	L	0	2
All	All	0	37

All (2) bond length outliers are listed below:

Mol	Chain	Res	Type	Atoms	Z	Observed(Å)	Ideal(Å)
1	G	603	CYS	CB-SG	-6.39	1.71	1.82
1	C	603	CYS	CB-SG	-5.81	1.72	1.81

The worst 5 of 30 bond angle outliers are listed below:

Mol	Chain	Res	Type	Atoms	Z	Observed(°)	Ideal(°)
1	A	365	ARG	NE-CZ-NH2	-9.62	115.49	120.30
1	A	365	ARG	NE-CZ-NH1	6.75	123.68	120.30
1	I	292	ARG	NE-CZ-NH1	6.34	123.47	120.30
1	A	598	ARG	NE-CZ-NH2	-6.15	117.22	120.30
1	C	292	ARG	NE-CZ-NH1	5.97	123.29	120.30

There are no chirality outliers.

5 of 37 planarity outliers are listed below:

Mol	Chain	Res	Type	Group
1	A	275	GLY	Peptide
1	A	592	PHE	Peptide
1	B	275	GLY	Peptide
1	B	581	PRO	Peptide
1	B	592	PHE	Peptide

5.2 Too-close contacts [\(i\)](#)

In the following table, the Non-H and H(model) columns list the number of non-hydrogen atoms and hydrogen atoms in the chain respectively. The H(added) column lists the number of hydrogen atoms added and optimized by MolProbity. The Clashes column lists the number of clashes within the asymmetric unit, whereas Symm-Clashes lists symmetry-related clashes.

Mol	Chain	Non-H	H(model)	H(added)	Clashes	Symm-Clashes
1	A	4560	0	4408	91	0
1	B	4560	0	4408	74	0
1	C	4560	0	4408	63	0
1	D	4560	0	4408	86	0

Continued on next page...

Continued from previous page...

Mol	Chain	Non-H	H(model)	H(added)	Clashes	Symm-Clashes
1	E	4560	0	4408	72	0
1	F	4560	0	4408	75	0
1	G	4560	0	4408	82	0
1	H	4560	0	4408	83	0
1	I	4560	0	4408	94	0
1	J	4560	0	4408	72	0
1	K	4560	0	4408	85	0
1	L	4560	0	4408	92	0
2	A	3	0	0	0	0
2	B	3	0	0	0	0
2	C	3	0	0	0	0
2	D	3	0	0	0	0
2	E	3	0	0	0	0
2	F	3	0	0	0	0
2	G	3	0	0	0	0
2	H	3	0	0	0	0
2	I	3	0	0	0	0
2	J	3	0	0	0	0
2	K	3	0	0	0	0
2	L	3	0	0	0	0
3	A	3	0	0	0	0
3	B	3	0	0	0	0
3	C	3	0	0	0	0
3	D	3	0	0	0	0
3	E	3	0	0	0	0
3	F	3	0	0	0	0
3	G	3	0	0	0	0
3	H	3	0	0	0	0
3	I	3	0	0	0	0
3	J	3	0	0	0	0
3	K	3	0	0	0	0
3	L	3	0	0	0	0
4	A	6	0	8	0	0
4	B	6	0	8	0	0
4	C	6	0	8	0	0
4	D	6	0	8	1	0
4	E	6	0	8	0	0
4	F	6	0	8	0	0
4	G	6	0	8	0	0
4	H	6	0	8	1	0
4	I	6	0	8	0	0
4	J	6	0	8	0	0

Continued on next page...

Continued from previous page...

Mol	Chain	Non-H	H(model)	H(added)	Clashes	Symm-Clashes
4	K	6	0	8	2	0
4	L	6	0	8	0	0
5	A	354	0	0	10	0
5	B	362	0	0	10	0
5	C	398	0	0	11	0
5	D	386	0	0	8	0
5	E	357	0	0	9	0
5	F	361	0	0	9	0
5	G	359	0	0	9	0
5	H	376	0	0	12	0
5	I	330	0	0	14	0
5	J	388	0	0	12	0
5	K	359	0	0	9	0
5	L	347	0	0	10	0
All	All	59241	0	52992	898	0

The all-atom clashscore is defined as the number of clashes found per 1000 atoms (including hydrogen atoms). The all-atom clashscore for this structure is 8.

The worst 5 of 898 close contacts within the same asymmetric unit are listed below, sorted by their clash magnitude.

Atom-1	Atom-2	Interatomic distance (Å)	Clash overlap (Å)
1:J:472:GLN:N	1:J:472:GLN:OE1	1.57	1.34
1:L:138:THR:HG22	1:L:401:ARG:NH1	1.42	1.32
1:L:138:THR:CG2	1:L:401:ARG:NH1	2.04	1.20
1:L:555:THR:HG22	5:L:3298:HOH:O	1.49	1.12
1:K:494:THR:HG22	5:K:684:HOH:O	1.52	1.07

There are no symmetry-related clashes.

5.3 Torsion angles [i](#)

5.3.1 Protein backbone [i](#)

In the following table, the Percentiles column shows the percent Ramachandran outliers of the chain as a percentile score with respect to all X-ray entries followed by that with respect to entries of similar resolution.

The Analysed column shows the number of residues for which the backbone conformation was analysed, and the total number of residues.

Mol	Chain	Analysed	Favoured	Allowed	Outliers	Percentiles	
1	A	583/612 (95%)	558 (96%)	23 (4%)	2 (0%)	41	50
1	B	583/612 (95%)	560 (96%)	22 (4%)	1 (0%)	47	58
1	C	583/612 (95%)	557 (96%)	26 (4%)	0	100	100
1	D	583/612 (95%)	561 (96%)	22 (4%)	0	100	100
1	E	583/612 (95%)	558 (96%)	23 (4%)	2 (0%)	41	50
1	F	583/612 (95%)	556 (95%)	24 (4%)	3 (0%)	29	35
1	G	583/612 (95%)	556 (95%)	24 (4%)	3 (0%)	29	35
1	H	583/612 (95%)	564 (97%)	18 (3%)	1 (0%)	47	58
1	I	583/612 (95%)	546 (94%)	34 (6%)	3 (0%)	29	35
1	J	583/612 (95%)	552 (95%)	29 (5%)	2 (0%)	41	50
1	K	583/612 (95%)	560 (96%)	23 (4%)	0	100	100
1	L	583/612 (95%)	558 (96%)	25 (4%)	0	100	100
All	All	6996/7344 (95%)	6686 (96%)	293 (4%)	17 (0%)	47	58

5 of 17 Ramachandran outliers are listed below:

Mol	Chain	Res	Type
1	E	582	GLY
1	G	555	THR
1	G	556	PRO
1	G	583	PRO
1	H	473	VAL

5.3.2 Protein sidechains [i](#)

In the following table, the Percentiles column shows the percent sidechain outliers of the chain as a percentile score with respect to all X-ray entries followed by that with respect to entries of similar resolution.

The Analysed column shows the number of residues for which the sidechain conformation was analysed, and the total number of residues.

Mol	Chain	Analysed	Rotameric	Outliers	Percentiles	
1	A	484/499 (97%)	482 (100%)	2 (0%)	91	96
1	B	484/499 (97%)	482 (100%)	2 (0%)	91	96
1	C	484/499 (97%)	483 (100%)	1 (0%)	93	97
1	D	484/499 (97%)	483 (100%)	1 (0%)	93	97

Continued on next page...

Continued from previous page...

Mol	Chain	Analysed	Rotameric	Outliers	Percentiles	
1	E	484/499 (97%)	483 (100%)	1 (0%)	93	97
1	F	484/499 (97%)	483 (100%)	1 (0%)	93	97
1	G	484/499 (97%)	480 (99%)	4 (1%)	81	91
1	H	484/499 (97%)	483 (100%)	1 (0%)	93	97
1	I	484/499 (97%)	481 (99%)	3 (1%)	86	94
1	J	484/499 (97%)	481 (99%)	3 (1%)	86	94
1	K	484/499 (97%)	482 (100%)	2 (0%)	91	96
1	L	484/499 (97%)	478 (99%)	6 (1%)	71	84
All	All	5808/5988 (97%)	5781 (100%)	27 (0%)	88	95

5 of 27 residues with a non-rotameric sidechain are listed below:

Mol	Chain	Res	Type
1	I	476	GLU
1	J	472	GLN
1	L	558	ARG
1	J	466	GLU
1	J	578	PHE

Sometimes sidechains can be flipped to improve hydrogen bonding and reduce clashes. 5 of 108 such sidechains are listed below:

Mol	Chain	Res	Type
1	G	334	HIS
1	I	271	ASN
1	L	191	ASN
1	G	574	HIS
1	H	334	HIS

5.3.3 RNA [i](#)

There are no RNA molecules in this entry.

5.4 Non-standard residues in protein, DNA, RNA chains [i](#)

There are no non-standard protein/DNA/RNA residues in this entry.

5.5 Carbohydrates [i](#)

There are no monosaccharides in this entry.

5.6 Ligand geometry [i](#)

Of 60 ligands modelled in this entry, 36 are monoatomic - leaving 24 for Mogul analysis.

In the following table, the Counts columns list the number of bonds (or angles) for which Mogul statistics could be retrieved, the number of bonds (or angles) that are observed in the model and the number of bonds (or angles) that are defined in the Chemical Component Dictionary. The Link column lists molecule types, if any, to which the group is linked. The Z score for a bond length (or angle) is the number of standard deviations the observed value is removed from the expected value. A bond length (or angle) with $|Z| > 2$ is considered an outlier worth inspection. RMSZ is the root-mean-square of all Z scores of the bond lengths (or angles).

Mol	Type	Chain	Res	Link	Bond lengths			Bond angles		
					Counts	RMSZ	$\# Z > 2$	Counts	RMSZ	$\# Z > 2$
3	C2O	L	1002	1	0,2,2	-	-	-		
4	GOL	L	5012	-	5,5,5	0.48	0	5,5,5	0.94	0
4	GOL	K	5011	-	5,5,5	0.37	0	5,5,5	1.18	0
4	GOL	D	5004	-	5,5,5	0.41	0	5,5,5	0.80	0
4	GOL	F	5006	-	5,5,5	0.25	0	5,5,5	0.78	0
4	GOL	B	5002	-	5,5,5	0.37	0	5,5,5	0.73	0
3	C2O	H	1002	1	0,2,2	-	-	-		
4	GOL	G	5007	-	5,5,5	0.20	0	5,5,5	0.60	0
3	C2O	J	1002	1	0,2,2	-	-	-		
3	C2O	G	1002	1	0,2,2	-	-	-		
4	GOL	E	5005	-	5,5,5	0.37	0	5,5,5	0.70	0
3	C2O	D	1002	1	0,2,2	-	-	-		
3	C2O	A	1002	1	0,2,2	-	-	-		
3	C2O	F	1002	1	0,2,2	-	-	-		
4	GOL	H	5008	-	5,5,5	0.38	0	5,5,5	0.78	0
4	GOL	J	5010	-	5,5,5	0.28	0	5,5,5	0.54	0
4	GOL	I	5009	-	5,5,5	0.27	0	5,5,5	0.89	0
3	C2O	I	1002	1	0,2,2	-	-	-		
4	GOL	C	5003	-	5,5,5	0.48	0	5,5,5	1.06	0
3	C2O	C	1002	1	0,2,2	-	-	-		
4	GOL	A	5001	-	5,5,5	0.45	0	5,5,5	0.94	0
3	C2O	E	1002	1	0,2,2	-	-	-		
3	C2O	B	1002	1	0,2,2	-	-	-		
3	C2O	K	1002	1	0,2,2	-	-	-		

In the following table, the Chirals column lists the number of chiral outliers, the number of chiral centers analysed, the number of these observed in the model and the number defined in the

Chemical Component Dictionary. Similar counts are reported in the Torsion and Rings columns. '-' means no outliers of that kind were identified.

Mol	Type	Chain	Res	Link	Chirals	Torsions	Rings
4	GOL	E	5005	-	-	4/4/4/4	-
4	GOL	I	5009	-	-	2/4/4/4	-
4	GOL	B	5002	-	-	2/4/4/4	-
4	GOL	G	5007	-	-	3/4/4/4	-
4	GOL	L	5012	-	-	2/4/4/4	-
4	GOL	K	5011	-	-	0/4/4/4	-
4	GOL	C	5003	-	-	2/4/4/4	-
4	GOL	H	5008	-	-	3/4/4/4	-
4	GOL	D	5004	-	-	0/4/4/4	-
4	GOL	J	5010	-	-	2/4/4/4	-
4	GOL	F	5006	-	-	4/4/4/4	-
4	GOL	A	5001	-	-	4/4/4/4	-

There are no bond length outliers.

There are no bond angle outliers.

There are no chirality outliers.

5 of 28 torsion outliers are listed below:

Mol	Chain	Res	Type	Atoms
4	B	5002	GOL	O2-C2-C3-O3
4	C	5003	GOL	O1-C1-C2-C3
4	G	5007	GOL	O1-C1-C2-C3
4	E	5005	GOL	O1-C1-C2-O2
4	F	5006	GOL	O2-C2-C3-O3

There are no ring outliers.

3 monomers are involved in 4 short contacts:

Mol	Chain	Res	Type	Clashes	Symm-Clashes
4	K	5011	GOL	2	0
4	D	5004	GOL	1	0
4	H	5008	GOL	1	0

5.7 Other polymers [i](#)

There are no such residues in this entry.

5.8 Polymer linkage issues

There are no chain breaks in this entry.

6 Fit of model and data [i](#)

6.1 Protein, DNA and RNA chains [i](#)

In the following table, the column labelled ‘#RSRZ > 2’ contains the number (and percentage) of RSRZ outliers, followed by percent RSRZ outliers for the chain as percentile scores relative to all X-ray entries and entries of similar resolution. The OWAB column contains the minimum, median, 95th percentile and maximum values of the occupancy-weighted average B-factor per residue. The column labelled ‘Q < 0.9’ lists the number of (and percentage) of residues with an average occupancy less than 0.9.

Mol	Chain	Analysed	<RSRZ>	#RSRZ>2	OWAB(Å ²)	Q<0.9
1	A	587/612 (95%)	-0.31	31 (5%) 26 33	15, 26, 51, 68	2 (0%)
1	B	587/612 (95%)	-0.32	21 (3%) 42 49	14, 25, 47, 69	4 (0%)
1	C	587/612 (95%)	-0.43	18 (3%) 49 56	14, 22, 46, 67	0
1	D	587/612 (95%)	-0.47	10 (1%) 70 76	14, 22, 44, 66	0
1	E	587/612 (95%)	-0.38	24 (4%) 37 44	14, 23, 47, 71	1 (0%)
1	F	587/612 (95%)	-0.32	24 (4%) 37 44	14, 23, 47, 69	3 (0%)
1	G	587/612 (95%)	-0.38	27 (4%) 32 39	14, 24, 47, 70	1 (0%)
1	H	587/612 (95%)	-0.38	20 (3%) 45 52	15, 24, 45, 70	2 (0%)
1	I	587/612 (95%)	-0.18	32 (5%) 25 31	15, 25, 53, 74	2 (0%)
1	J	587/612 (95%)	-0.39	16 (2%) 54 62	15, 23, 45, 61	2 (0%)
1	K	587/612 (95%)	-0.32	25 (4%) 35 42	15, 25, 49, 68	1 (0%)
1	L	587/612 (95%)	-0.32	23 (3%) 39 46	16, 25, 50, 71	1 (0%)
All	All	7044/7344 (95%)	-0.35	271 (3%) 40 47	14, 24, 48, 74	19 (0%)

The worst 5 of 271 RSRZ outliers are listed below:

Mol	Chain	Res	Type	RSRZ
1	I	472	GLN	31.7
1	L	472	GLN	21.9
1	H	473	VAL	17.4
1	I	473	VAL	17.0
1	F	472	GLN	16.8

6.2 Non-standard residues in protein, DNA, RNA chains [i](#)

There are no non-standard protein/DNA/RNA residues in this entry.

6.3 Carbohydrates [i](#)

There are no monosaccharides in this entry.

6.4 Ligands [i](#)

In the following table, the Atoms column lists the number of modelled atoms in the group and the number defined in the chemical component dictionary. The B-factors column lists the minimum, median, 95th percentile and maximum values of B factors of atoms in the group. The column labelled 'Q< 0.9' lists the number of atoms with occupancy less than 0.9.

Mol	Type	Chain	Res	Atoms	RSCC	RSR	B-factors(\AA^2)	Q<0.9
4	GOL	K	5011	6/6	0.84	0.18	29,41,42,43	0
4	GOL	D	5004	6/6	0.85	0.16	34,36,38,38	0
4	GOL	E	5005	6/6	0.86	0.14	35,40,43,43	0
4	GOL	L	5012	6/6	0.86	0.15	34,37,39,39	0
4	GOL	B	5002	6/6	0.88	0.16	33,39,42,42	0
4	GOL	H	5008	6/6	0.89	0.14	26,33,35,36	0
4	GOL	A	5001	6/6	0.89	0.14	25,32,38,39	0
4	GOL	C	5003	6/6	0.89	0.17	26,28,32,34	0
4	GOL	F	5006	6/6	0.91	0.13	38,39,41,43	0
4	GOL	I	5009	6/6	0.92	0.14	28,36,39,40	0
4	GOL	J	5010	6/6	0.93	0.12	27,35,35,37	0
3	C2O	A	1002	3/3	0.93	0.09	41,41,44,52	0
4	GOL	G	5007	6/6	0.93	0.11	30,39,41,42	0
3	C2O	K	1002	3/3	0.94	0.09	42,42,45,46	0
3	C2O	I	1002	3/3	0.95	0.06	37,37,46,47	0
3	C2O	B	1002	3/3	0.95	0.07	40,40,41,48	0
3	C2O	L	1002	3/3	0.95	0.08	39,39,41,46	0
3	C2O	J	1002	3/3	0.96	0.07	29,29,38,43	0
3	C2O	H	1002	3/3	0.96	0.07	38,38,40,45	0
3	C2O	C	1002	3/3	0.96	0.09	29,29,39,41	0
3	C2O	D	1002	3/3	0.97	0.06	30,30,39,41	0
3	C2O	F	1002	3/3	0.97	0.09	38,38,39,48	0
3	C2O	G	1002	3/3	0.97	0.06	41,41,42,49	0
2	CU	L	1005	1/1	0.97	0.03	41,41,41,41	0
3	C2O	E	1002	3/3	0.98	0.06	32,32,40,40	0
2	CU	K	1005	1/1	0.98	0.02	42,42,42,42	0
2	CU	E	1000	1/1	0.99	0.05	45,45,45,45	0
2	CU	E	1005	1/1	0.99	0.03	42,42,42,42	0
2	CU	F	1005	1/1	0.99	0.03	38,38,38,38	0
2	CU	G	1005	1/1	0.99	0.03	39,39,39,39	0
2	CU	H	1000	1/1	0.99	0.04	49,49,49,49	0
2	CU	H	1004	1/1	0.99	0.03	43,43,43,43	0

Continued on next page...

Continued from previous page...

Mol	Type	Chain	Res	Atoms	RSCC	RSR	B-factors(\AA^2)	Q<0.9
2	CU	I	1004	1/1	0.99	0.03	43,43,43,43	0
2	CU	I	1005	1/1	0.99	0.04	42,42,42,42	0
2	CU	J	1000	1/1	0.99	0.02	40,40,40,40	0
2	CU	J	1004	1/1	0.99	0.04	41,41,41,41	0
2	CU	J	1005	1/1	0.99	0.02	39,39,39,39	0
2	CU	K	1000	1/1	0.99	0.03	43,43,43,43	0
2	CU	K	1004	1/1	0.99	0.04	40,40,40,40	0
2	CU	A	1004	1/1	0.99	0.05	41,41,41,41	0
2	CU	L	1004	1/1	0.99	0.03	43,43,43,43	0
2	CU	A	1005	1/1	0.99	0.03	43,43,43,43	0
2	CU	B	1004	1/1	0.99	0.03	40,40,40,40	0
2	CU	C	1005	1/1	0.99	0.03	37,37,37,37	0
2	CU	D	1004	1/1	0.99	0.04	38,38,38,38	0
2	CU	D	1005	1/1	0.99	0.03	38,38,38,38	0
2	CU	G	1004	1/1	1.00	0.04	43,43,43,43	0
2	CU	L	1000	1/1	1.00	0.04	43,43,43,43	0
2	CU	D	1000	1/1	1.00	0.02	37,37,37,37	0
2	CU	A	1000	1/1	1.00	0.04	50,50,50,50	0
2	CU	B	1005	1/1	1.00	0.06	37,37,37,37	0
2	CU	H	1005	1/1	1.00	0.03	36,36,36,36	0
2	CU	I	1000	1/1	1.00	0.02	46,46,46,46	0
2	CU	C	1000	1/1	1.00	0.03	43,43,43,43	0
2	CU	E	1004	1/1	1.00	0.03	41,41,41,41	0
2	CU	C	1004	1/1	1.00	0.05	39,39,39,39	0
2	CU	F	1000	1/1	1.00	0.03	42,42,42,42	0
2	CU	F	1004	1/1	1.00	0.07	42,42,42,42	0
2	CU	B	1000	1/1	1.00	0.03	43,43,43,43	0
2	CU	G	1000	1/1	1.00	0.03	43,43,43,43	0

6.5 Other polymers [i](#)

There are no such residues in this entry.