



wwPDB X-ray Structure Validation Summary Report ⓘ

Dec 18, 2023 – 10:10 AM JST

PDB ID : 8HUH
Title : Crystal structure of T2R-TTL-3a complex
Authors : Wang, Y.X.; Chen, J.J.
Deposited on : 2022-12-23
Resolution : 2.80 Å(reported)

This is a wwPDB X-ray Structure Validation Summary Report for a publicly released PDB entry.

We welcome your comments at validation@mail.wwpdb.org

A user guide is available at

<https://www.wwpdb.org/validation/2017/XrayValidationReportHelp>

with specific help available everywhere you see the ⓘ symbol.

The types of validation reports are described at

<http://www.wwpdb.org/validation/2017/FAQs#types>.

The following versions of software and data (see [references ⓘ](#)) were used in the production of this report:

MolProbity : 4.02b-467
Mogul : 1.8.5 (274361), CSD as541be (2020)
Xtriage (Phenix) : 1.13
EDS : 2.36
buster-report : 1.1.7 (2018)
Percentile statistics : 20191225.v01 (using entries in the PDB archive December 25th 2019)
Refmac : 5.8.0158
CCP4 : 7.0.044 (Gargrove)
Ideal geometry (proteins) : Engh & Huber (2001)
Ideal geometry (DNA, RNA) : Parkinson et al. (1996)
Validation Pipeline (wwPDB-VP) : 2.36

1 Overall quality at a glance

The following experimental techniques were used to determine the structure:

X-RAY DIFFRACTION





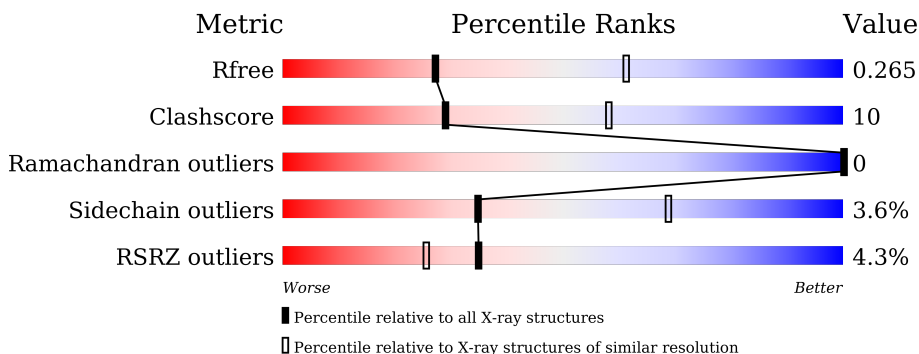

The reported resolution of this entry is 2.80 Å.

Percentile scores (ranging between 0-100) for global validation metrics of the entry are shown in the following graphic. The table shows the number of entries on which the scores are based.

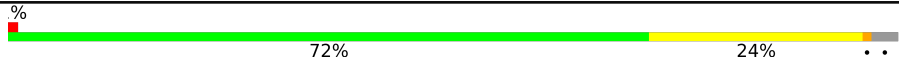

Metric	Whole archive (#Entries)	Similar resolution (#Entries, resolution range(Å))
R_{free}	130704	3140 (2.80-2.80)
Clashscore	141614	3569 (2.80-2.80)
Ramachandran outliers	138981	3498 (2.80-2.80)
Sidechain outliers	138945	3500 (2.80-2.80)
RSRZ outliers	127900	3078 (2.80-2.80)

The table below summarises the geometric issues observed across the polymeric chains and their fit to the electron density. The red, orange, yellow and green segments of the lower bar indicate the fraction of residues that contain outliers for ≥ 3 , 2, 1 and 0 types of geometric quality criteria respectively. A grey segment represents the fraction of residues that are not modelled. The numeric value for each fraction is indicated below the corresponding segment, with a dot representing fractions $\leq 5\%$. The upper red bar (where present) indicates the fraction of residues that have poor fit to the electron density. The numeric value is given above the bar.

Mol	Chain	Length	Quality of chain
1	A	450	 72% 24% 4%
1	C	450	 81% 16%
2	B	445	 74% 21% 4%
2	D	445	 68% 26% 5%
3	E	143	 66% 18% 6% 15%
4	F	384	 63% 18% 11% 18%

2 Entry composition [i](#)

There are 11 unique types of molecules in this entry. The entry contains 16899 atoms, of which 0 are hydrogens and 0 are deuteriums.

In the tables below, the ZeroOcc column contains the number of atoms modelled with zero occupancy, the AltConf column contains the number of residues with at least one atom in alternate conformation and the Trace column contains the number of residues modelled with at most 2 atoms.

- Molecule 1 is a protein called Tubulin alpha-1B chain.

Mol	Chain	Residues	Atoms					ZeroOcc	AltConf	Trace
			Total	C	N	O	S			
1	A	437	Total	C	N	O	S	0	0	0
			3403	2156	579	646	22			
1	C	440	Total	C	N	O	S	0	0	0
			3427	2169	581	655	22			

- Molecule 2 is a protein called Tubulin beta-2B chain.

Mol	Chain	Residues	Atoms					ZeroOcc	AltConf	Trace
			Total	C	N	O	S			
2	B	427	Total	C	N	O	S	0	0	0
			3336	2098	570	642	26			
2	D	421	Total	C	N	O	S	0	0	0
			3156	1975	534	622	25			

- Molecule 3 is a protein called Stathmin-4.

Mol	Chain	Residues	Atoms					ZeroOcc	AltConf	Trace
			Total	C	N	O	S			
3	E	121	Total	C	N	O	S	0	1	0
			983	605	178	195	5			

There are 2 discrepancies between the modelled and reference sequences:

Chain	Residue	Modelled	Actual	Comment	Reference
E	3	MET	-	expression tag	UNP P63043
E	4	ALA	-	expression tag	UNP P63043

- Molecule 4 is a protein called TTL.

Mol	Chain	Residues	Atoms					ZeroOcc	AltConf	Trace
			Total	C	N	O	S			
4	F	316	Total	C	N	O	S	0	0	0
			2383	1531	404	437	11			

There are 6 discrepancies between the modelled and reference sequences:

Chain	Residue	Modelled	Actual	Comment	Reference
F	379	HIS	-	expression tag	UNP E1BQ43
F	380	HIS	-	expression tag	UNP E1BQ43
F	381	HIS	-	expression tag	UNP E1BQ43
F	382	HIS	-	expression tag	UNP E1BQ43
F	383	HIS	-	expression tag	UNP E1BQ43
F	384	HIS	-	expression tag	UNP E1BQ43

- Molecule 5 is GUANOSINE-5'-TRIPHOSPHATE (three-letter code: GTP) (formula: $C_{10}H_{16}N_5O_{14}P_3$).

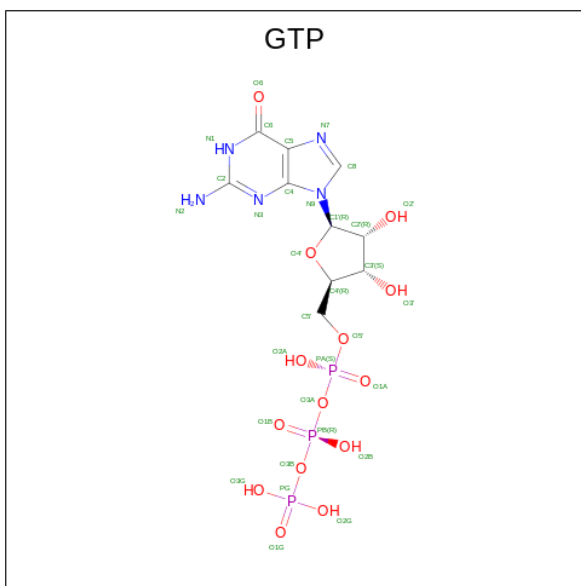

Mol	Chain	Residues	Atoms					ZeroOcc	AltConf
			Total	C	N	O	P		
5	A	1	Total	C	N	O	P	0	0
			32	10	5	14	3		
5	C	1	Total	C	N	O	P	0	0
			32	10	5	14	3		

- Molecule 6 is MAGNESIUM ION (three-letter code: MG) (formula: Mg).

Mol	Chain	Residues	Atoms		ZeroOcc	AltConf
			Total	Mg		
6	A	1	Total	Mg	0	0
			1	1		
6	B	1	Total	Mg	0	0
			1	1		
6	C	1	Total	Mg	0	0
			1	1		

- Molecule 7 is CALCIUM ION (three-letter code: CA) (formula: Ca).

Mol	Chain	Residues	Atoms	ZeroOcc	AltConf
7	A	1	Total Ca 1 1	0	0
7	C	1	Total Ca 1 1	0	0

- Molecule 8 is GUANOSINE-5'-DIPHOSPHATE (three-letter code: GDP) (formula: $C_{10}H_{15}N_5O_{11}P_2$).

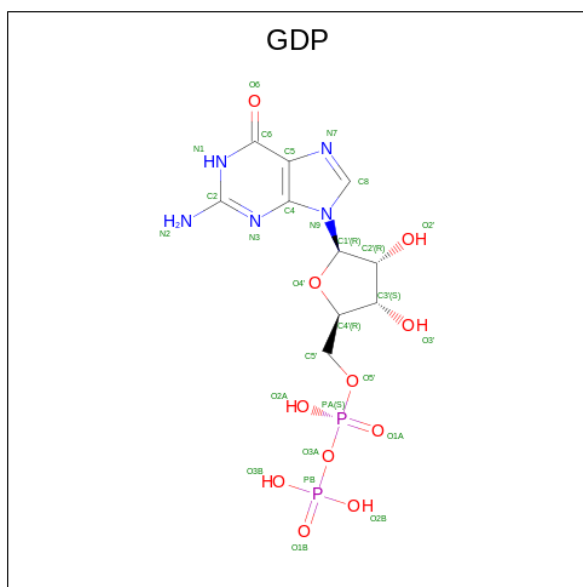

Mol	Chain	Residues	Atoms	ZeroOcc	AltConf
8	B	1	Total C N O P 28 10 5 11 2	0	0
8	D	1	Total C N O P 28 10 5 11 2	0	0

- Molecule 9 is 2-(N-MORPHOLINO)-ETHANESULFONIC ACID (three-letter code: MES) (formula: $C_6H_{13}NO_4S$).

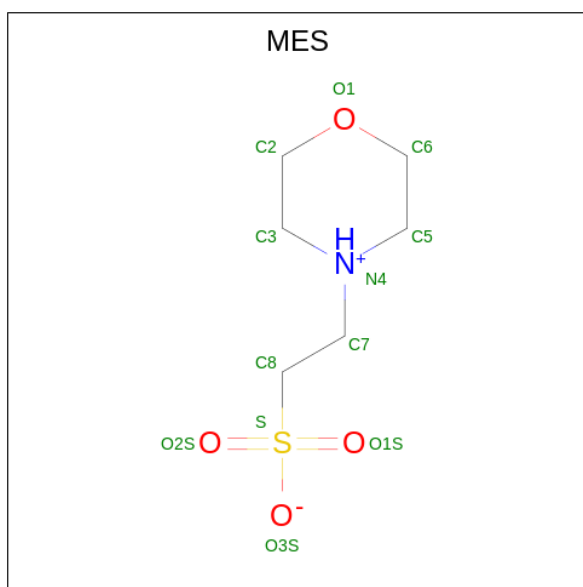

Mol	Chain	Residues	Atoms					ZeroOcc	AltConf
			Total	C	N	O	S		
9	B	1	12	6	1	4	1	0	0
9	B	1	12	6	1	4	1	0	0

- Molecule 10 is 2-(1-methylindol-4-yl)-4-(3,4,5-trimethoxyphenyl)-1 {H}-imidazo[4,5-c]pyridine (three-letter code: MXV) (formula: C₂₄H₂₂N₄O₃) (labeled as "Ligand of Interest" by depositor).

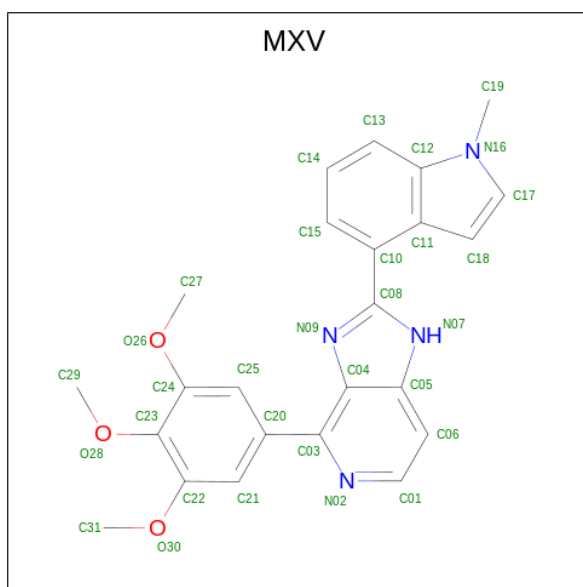

Mol	Chain	Residues	Atoms				ZeroOcc	AltConf
			Total	C	N	O		
10	B	1	31	24	4	3	0	0

- Molecule 11 is PHOSPHOMETHYLPHOSPHONIC ACID ADENYLATE ESTER (three-letter code: ACP) (formula: $C_{11}H_{18}N_5O_{12}P_3$).

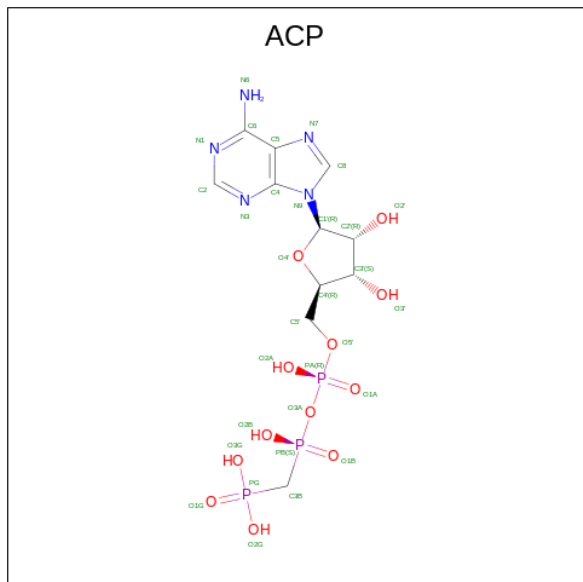

Mol	Chain	Residues	Atoms					ZeroOcc	AltConf
			Total	C	N	O	P		
11	F	1	31	11	5	12	3	0	0

3 Residue-property plots

These plots are drawn for all protein, RNA, DNA and oligosaccharide chains in the entry. The first graphic for a chain summarises the proportions of the various outlier classes displayed in the second graphic. The second graphic shows the sequence view annotated by issues in geometry and electron density. Residues are color-coded according to the number of geometric quality criteria for which they contain at least one outlier: green = 0, yellow = 1, orange = 2 and red = 3 or more. A red dot above a residue indicates a poor fit to the electron density ($RSRZ > 2$). Stretches of 2 or more consecutive residues without any outlier are shown as a green connector. Residues present in the sample, but not in the model, are shown in grey.

- Molecule 1: Tubulin alpha-1B chain

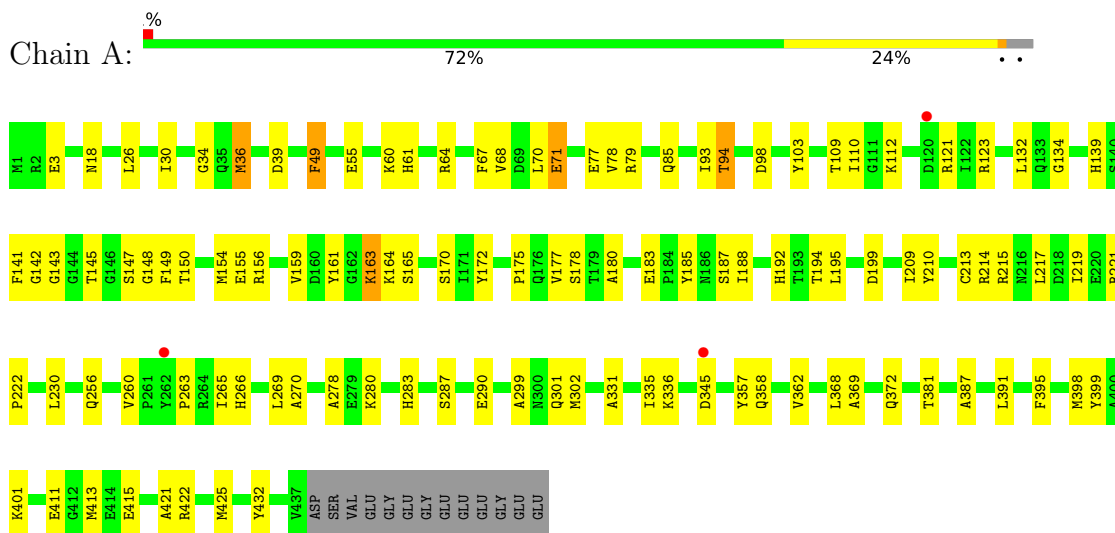

- Molecule 1: Tubulin alpha-1B chain

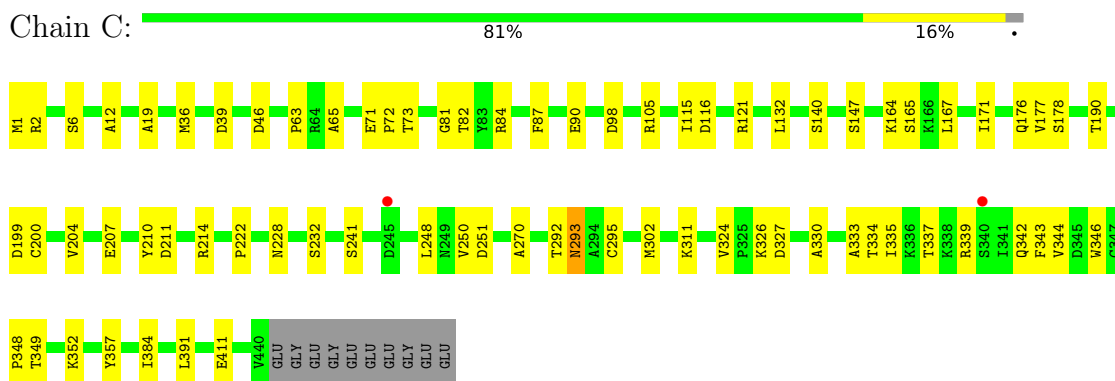

- Molecule 2: Tubulin beta-2B chain

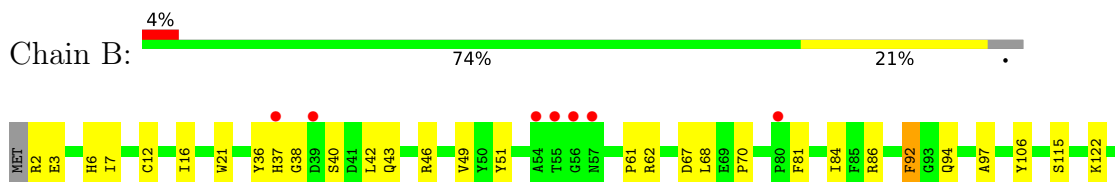

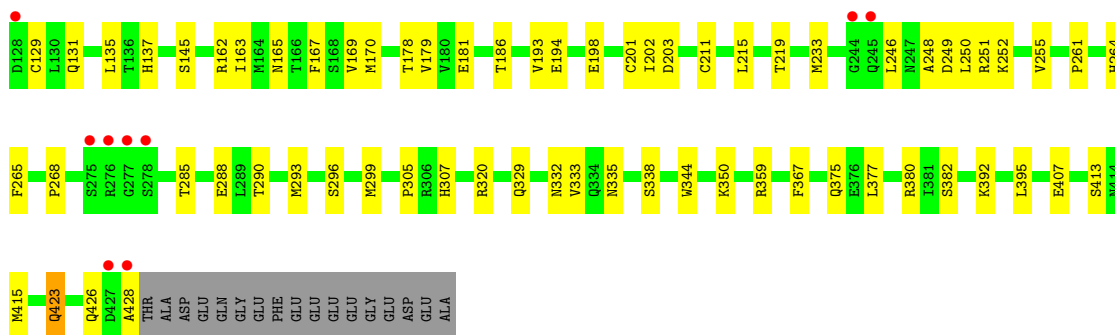

• Molecule 2: Tubulin beta-2B chain

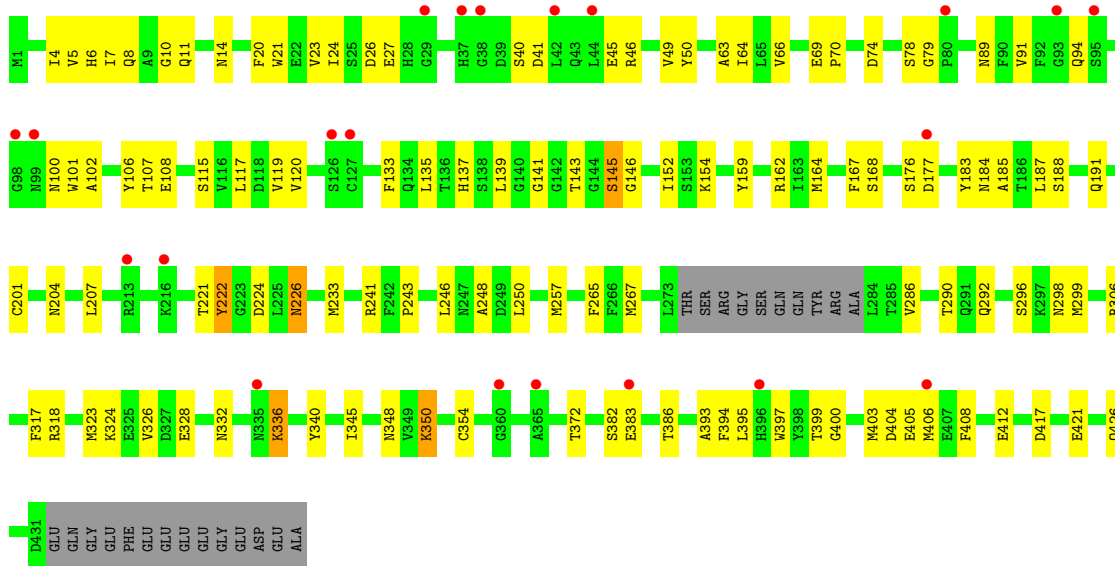

• Molecule 3: Stathmin-4

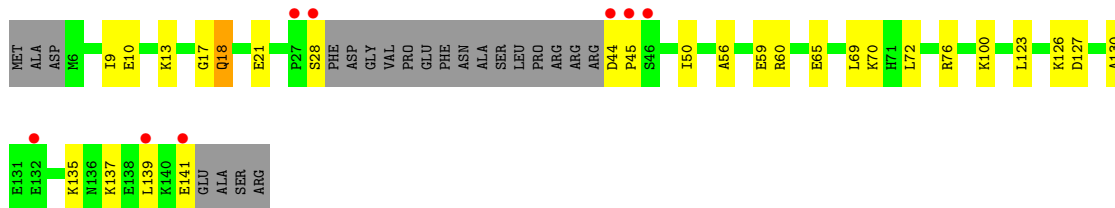

• Molecule 4: TTL



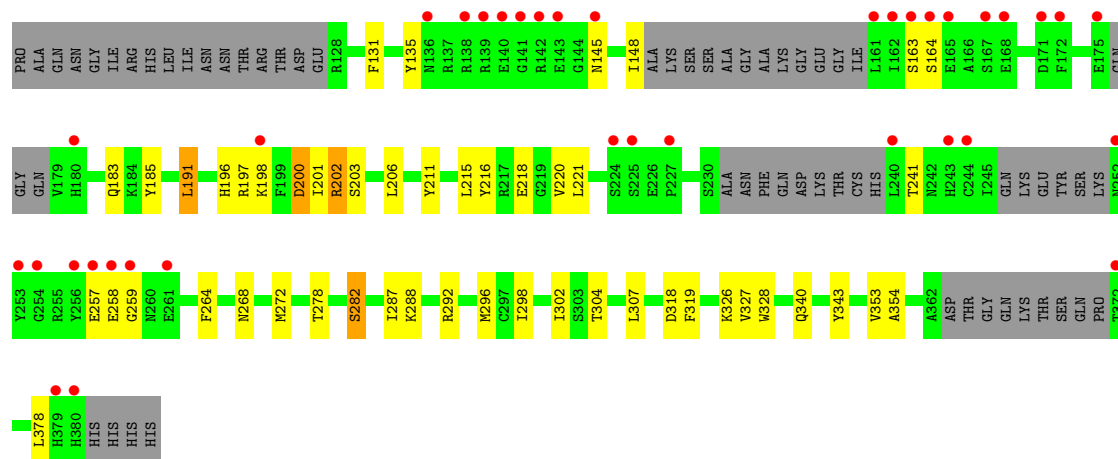

4 Data and refinement statistics

Property	Value	Source
Space group	P 21 21 21	Depositor
Cell constants a, b, c, α , β , γ	105.19Å 157.88Å 182.14Å 90.00° 90.00° 90.00°	Depositor
Resolution (Å)	19.89 – 2.80 19.89 – 2.80	Depositor EDS
% Data completeness (in resolution range)	99.3 (19.89-2.80) 99.3 (19.89-2.80)	Depositor EDS
R_{merge}	(Not available)	Depositor
R_{sym}	(Not available)	Depositor
$\langle I/\sigma(I) \rangle$ ¹	1.66 (at 2.79Å)	Xtrriage
Refinement program	PHENIX v1.2	Depositor
R, R_{free}	0.214 , 0.266 0.215 , 0.265	Depositor DCC
R_{free} test set	1999 reflections (2.68%)	wwPDB-VP
Wilson B-factor (Å ²)	54.9	Xtrriage
Anisotropy	0.243	Xtrriage
Bulk solvent k_{sol} (e/Å ³), B_{sol} (Å ²)	0.32 , 53.2	EDS
L-test for twinning ²	$\langle L \rangle = 0.50$, $\langle L^2 \rangle = 0.33$	Xtrriage
Estimated twinning fraction	No twinning to report.	Xtrriage
F_o, F_c correlation	0.92	EDS
Total number of atoms	16899	wwPDB-VP
Average B, all atoms (Å ²)	59.0	wwPDB-VP

Xtrriage's analysis on translational NCS is as follows: *The largest off-origin peak in the Patterson function is 2.53% of the height of the origin peak. No significant pseudotranslation is detected.*

¹Intensities estimated from amplitudes.

²Theoretical values of $\langle |L| \rangle$, $\langle L^2 \rangle$ for acentric reflections are 0.5, 0.333 respectively for untwinned datasets, and 0.375, 0.2 for perfectly twinned datasets.

5 Model quality [i](#)

5.1 Standard geometry [i](#)

Bond lengths and bond angles in the following residue types are not validated in this section: GDP, MG, GTP, MXV, ACP, MES, CA

The Z score for a bond length (or angle) is the number of standard deviations the observed value is removed from the expected value. A bond length (or angle) with $|Z| > 5$ is considered an outlier worth inspection. RMSZ is the root-mean-square of all Z scores of the bond lengths (or angles).

Mol	Chain	Bond lengths		Bond angles	
		RMSZ	# $ Z > 5$	RMSZ	# $ Z > 5$
1	A	0.48	0/3480	0.67	0/4725
1	C	0.53	0/3505	0.70	0/4759
2	B	0.50	0/3411	0.68	0/4622
2	D	0.47	1/3224 (0.0%)	0.68	3/4389 (0.1%)
3	E	0.50	0/995	0.67	0/1327
4	F	0.42	0/2434	0.62	1/3311 (0.0%)
All	All	0.49	1/17049 (0.0%)	0.67	4/23133 (0.0%)

All (1) bond length outliers are listed below:

Mol	Chain	Res	Type	Atoms	Z	Observed(Å)	Ideal(Å)
2	D	226	ASN	CB-CG	6.26	1.65	1.51

All (4) bond angle outliers are listed below:

Mol	Chain	Res	Type	Atoms	Z	Observed(°)	Ideal(°)
2	D	393	ALA	N-CA-C	6.54	128.66	111.00
4	F	200	ASP	CB-CG-OD2	5.54	123.28	118.30
2	D	145	SER	N-CA-C	5.34	125.42	111.00
2	D	246	LEU	CA-CB-CG	5.26	127.40	115.30

There are no chirality outliers.

There are no planarity outliers.

5.2 Too-close contacts [i](#)

In the following table, the Non-H and H(model) columns list the number of non-hydrogen atoms and hydrogen atoms in the chain respectively. The H(added) column lists the number of hydrogen atoms added and optimized by MolProbity. The Clashes column lists the number of clashes within

the asymmetric unit, whereas Symm-Clashes lists symmetry-related clashes.

Mol	Chain	Non-H	H(model)	H(added)	Clashes	Symm-Clashes
1	A	3403	0	3318	80	0
1	C	3427	0	3325	46	0
2	B	3336	0	3197	65	0
2	D	3156	0	2893	70	0
3	E	983	0	966	20	0
4	F	2383	0	2181	49	0
5	A	32	0	12	0	0
5	C	32	0	12	0	0
6	A	1	0	0	0	0
6	B	1	0	0	0	0
6	C	1	0	0	0	0
7	A	1	0	0	0	0
7	C	1	0	0	0	0
8	B	28	0	12	1	0
8	D	28	0	12	5	0
9	B	24	0	24	2	0
10	B	31	0	0	2	0
11	F	31	0	14	2	0
All	All	16899	0	15966	316	0

The all-atom clashscore is defined as the number of clashes found per 1000 atoms (including hydrogen atoms). The all-atom clashscore for this structure is 10.

The worst 5 of 316 close contacts within the same asymmetric unit are listed below, sorted by their clash magnitude.

Atom-1	Atom-2	Interatomic distance (Å)	Clash overlap (Å)
1:A:93:ILE:HD11	1:A:121:ARG:HG3	1.62	0.79
1:A:175:PRO:HA	1:A:178:SER:HB2	1.64	0.79
4:F:79:LYS:O	4:F:83:THR:HG22	1.83	0.77
2:D:292:GLN:HE21	2:D:298:ASN:HD21	1.31	0.77
4:F:292:ARG:HG2	4:F:296:MET:HE1	1.67	0.76

There are no symmetry-related clashes.

5.3 Torsion angles [i](#)

5.3.1 Protein backbone [i](#)

In the following table, the Percentiles column shows the percent Ramachandran outliers of the chain as a percentile score with respect to all X-ray entries followed by that with respect to entries

of similar resolution.

The Analysed column shows the number of residues for which the backbone conformation was analysed, and the total number of residues.

Mol	Chain	Analysed	Favoured	Allowed	Outliers	Percentiles	
1	A	435/450 (97%)	409 (94%)	26 (6%)	0	100	100
1	C	438/450 (97%)	421 (96%)	17 (4%)	0	100	100
2	B	425/445 (96%)	412 (97%)	13 (3%)	0	100	100
2	D	417/445 (94%)	395 (95%)	22 (5%)	0	100	100
3	E	118/143 (82%)	118 (100%)	0	0	100	100
4	F	302/384 (79%)	290 (96%)	12 (4%)	0	100	100
All	All	2135/2317 (92%)	2045 (96%)	90 (4%)	0	100	100

There are no Ramachandran outliers to report.

5.3.2 Protein sidechains [i](#)

In the following table, the Percentiles column shows the percent sidechain outliers of the chain as a percentile score with respect to all X-ray entries followed by that with respect to entries of similar resolution.

The Analysed column shows the number of residues for which the sidechain conformation was analysed, and the total number of residues.

Mol	Chain	Analysed	Rotameric	Outliers	Percentiles	
1	A	365/378 (97%)	354 (97%)	11 (3%)	41	75
1	C	368/378 (97%)	360 (98%)	8 (2%)	52	83
2	B	362/383 (94%)	352 (97%)	10 (3%)	43	77
2	D	326/383 (85%)	311 (95%)	15 (5%)	27	60
3	E	104/127 (82%)	98 (94%)	6 (6%)	20	50
4	F	233/342 (68%)	219 (94%)	14 (6%)	19	48
All	All	1758/1991 (88%)	1694 (96%)	64 (4%)	35	69

5 of 64 residues with a non-rotameric sidechain are listed below:

Mol	Chain	Res	Type
4	F	191	LEU
4	F	211	TYR
1	C	251	ASP

Continued on next page...

Continued from previous page...

Mol	Chain	Res	Type
1	C	241	SER
4	F	220	VAL

Sometimes sidechains can be flipped to improve hydrogen bonding and reduce clashes. 5 of 12 such sidechains are listed below:

Mol	Chain	Res	Type
2	D	134	GLN
2	D	292	GLN
3	E	124	GLN
2	D	335	ASN
2	B	43	GLN

5.3.3 RNA [i](#)

There are no RNA molecules in this entry.

5.4 Non-standard residues in protein, DNA, RNA chains [i](#)

There are no non-standard protein/DNA/RNA residues in this entry.

5.5 Carbohydrates [i](#)

There are no monosaccharides in this entry.

5.6 Ligand geometry [i](#)

Of 13 ligands modelled in this entry, 5 are monoatomic - leaving 8 for Mogul analysis.

In the following table, the Counts columns list the number of bonds (or angles) for which Mogul statistics could be retrieved, the number of bonds (or angles) that are observed in the model and the number of bonds (or angles) that are defined in the Chemical Component Dictionary. The Link column lists molecule types, if any, to which the group is linked. The Z score for a bond length (or angle) is the number of standard deviations the observed value is removed from the expected value. A bond length (or angle) with $|Z| > 2$ is considered an outlier worth inspection. RMSZ is the root-mean-square of all Z scores of the bond lengths (or angles).

Mol	Type	Chain	Res	Link	Bond lengths			Bond angles		
					Counts	RMSZ	$\# Z > 2$	Counts	RMSZ	$\# Z > 2$
9	MES	B	503	-	12,12,12	2.25	1 (8%)	14,16,16	2.11	5 (35%)

Mol	Type	Chain	Res	Link	Bond lengths			Bond angles		
					Counts	RMSZ	# Z > 2	Counts	RMSZ	# Z > 2
11	ACP	F	401	-	27,33,33	1.15	1 (3%)	32,52,52	1.25	4 (12%)
5	GTP	C	501	6	26,34,34	1.15	1 (3%)	32,54,54	1.61	9 (28%)
9	MES	B	504	-	12,12,12	2.48	1 (8%)	14,16,16	1.92	4 (28%)
8	GDP	B	501	6	24,30,30	0.91	1 (4%)	30,47,47	1.30	3 (10%)
5	GTP	A	501	6	26,34,34	1.24	2 (7%)	32,54,54	1.53	6 (18%)
8	GDP	D	501	-	24,30,30	1.63	3 (12%)	30,47,47	1.56	7 (23%)
10	MXV	B	505	-	30,35,35	1.82	4 (13%)	36,51,51	1.54	5 (13%)

In the following table, the Chirals column lists the number of chiral outliers, the number of chiral centers analysed, the number of these observed in the model and the number defined in the Chemical Component Dictionary. Similar counts are reported in the Torsion and Rings columns. '-' means no outliers of that kind were identified.

Mol	Type	Chain	Res	Link	Chirals	Torsions	Rings
9	MES	B	503	-	-	4/6/14/14	0/1/1/1
11	ACP	F	401	-	-	4/15/38/38	0/3/3/3
5	GTP	C	501	6	-	6/18/38/38	0/3/3/3
9	MES	B	504	-	-	3/6/14/14	0/1/1/1
8	GDP	B	501	6	-	3/12/32/32	0/3/3/3
5	GTP	A	501	6	-	8/18/38/38	0/3/3/3
8	GDP	D	501	-	-	4/12/32/32	0/3/3/3
10	MXV	B	505	-	-	0/14/14/14	0/5/5/5

The worst 5 of 14 bond length outliers are listed below:

Mol	Chain	Res	Type	Atoms	Z	Observed(Å)	Ideal(Å)
9	B	504	MES	C8-S	-8.25	1.65	1.77
9	B	503	MES	C8-S	-7.40	1.67	1.77
10	B	505	MXV	C20-C03	-6.74	1.39	1.49
11	F	401	ACP	PB-O3A	5.26	1.64	1.58
8	D	501	GDP	C6-N1	-4.91	1.30	1.37

The worst 5 of 43 bond angle outliers are listed below:

Mol	Chain	Res	Type	Atoms	Z	Observed(°)	Ideal(°)
9	B	504	MES	C5-N4-C3	5.53	121.27	108.83
11	F	401	ACP	PB-O3A-PA	-4.67	117.74	132.56
10	B	505	MXV	C31-O30-C22	-4.22	111.16	117.53
9	B	503	MES	C5-N4-C3	4.07	117.99	108.83

Continued on next page...

Continued from previous page...

Mol	Chain	Res	Type	Atoms	Z	Observed(°)	Ideal(°)
8	D	501	GDP	C3'-C2'-C1'	3.70	106.55	100.98

There are no chirality outliers.

5 of 32 torsion outliers are listed below:

Mol	Chain	Res	Type	Atoms
5	A	501	GTP	PB-O3B-PG-O2G
5	A	501	GTP	C5'-O5'-PA-O2A
5	C	501	GTP	PB-O3B-PG-O3G
5	C	501	GTP	C5'-O5'-PA-O1A
5	C	501	GTP	C5'-O5'-PA-O2A

There are no ring outliers.

5 monomers are involved in 12 short contacts:

Mol	Chain	Res	Type	Clashes	Symm-Clashes
11	F	401	ACP	2	0
9	B	504	MES	2	0
8	B	501	GDP	1	0
8	D	501	GDP	5	0
10	B	505	MXV	2	0

The following is a two-dimensional graphical depiction of Mogul quality analysis of bond lengths, bond angles, torsion angles, and ring geometry for all instances of the Ligand of Interest. In addition, ligands with molecular weight > 250 and outliers as shown on the validation Tables will also be included. For torsion angles, if less than 5% of the Mogul distribution of torsion angles is within 10 degrees of the torsion angle in question, then that torsion angle is considered an outlier. Any bond that is central to one or more torsion angles identified as an outlier by Mogul will be highlighted in the graph. For rings, the root-mean-square deviation (RMSD) between the ring in question and similar rings identified by Mogul is calculated over all ring torsion angles. If the average RMSD is greater than 60 degrees and the minimal RMSD between the ring in question and any Mogul-identified rings is also greater than 60 degrees, then that ring is considered an outlier. The outliers are highlighted in purple. The color gray indicates Mogul did not find sufficient equivalents in the CSD to analyse the geometry.

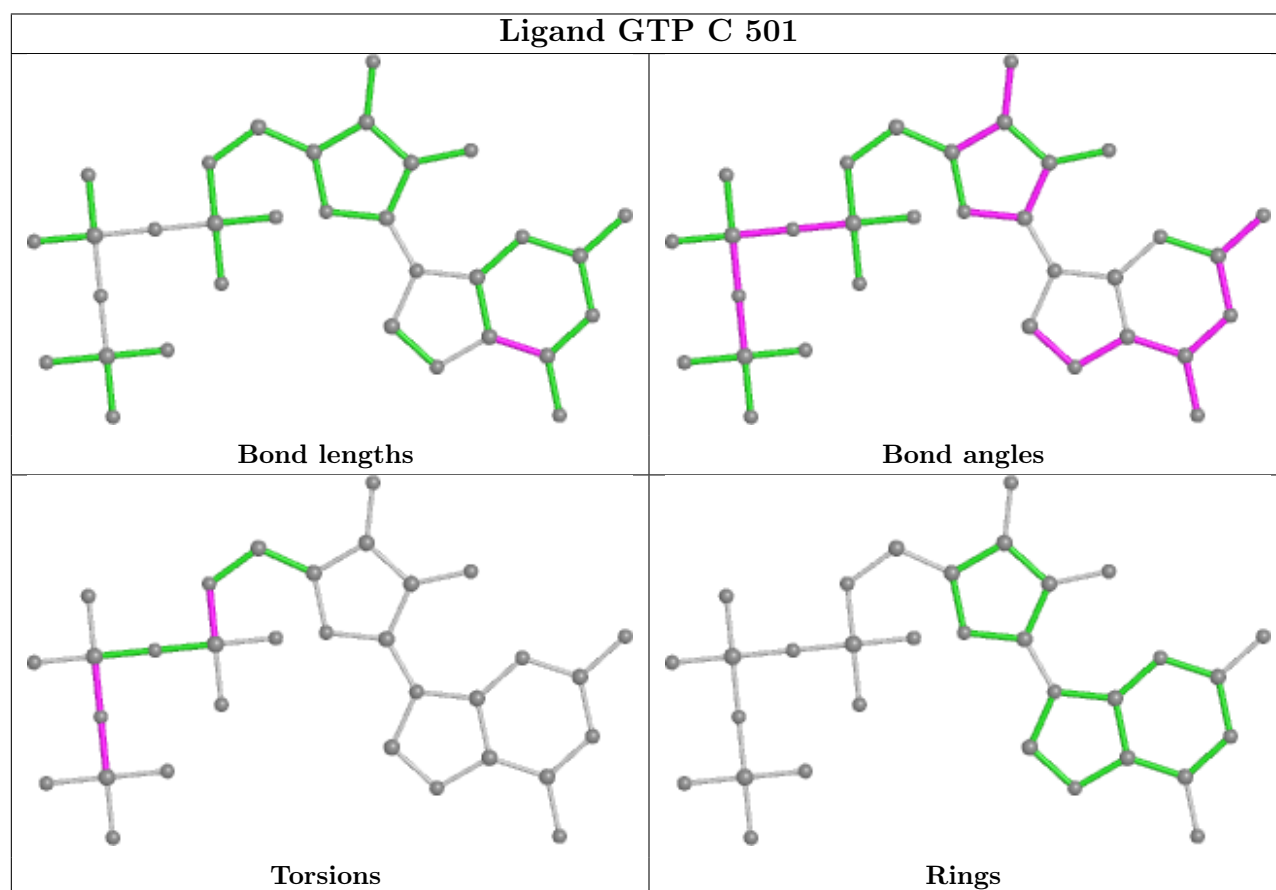
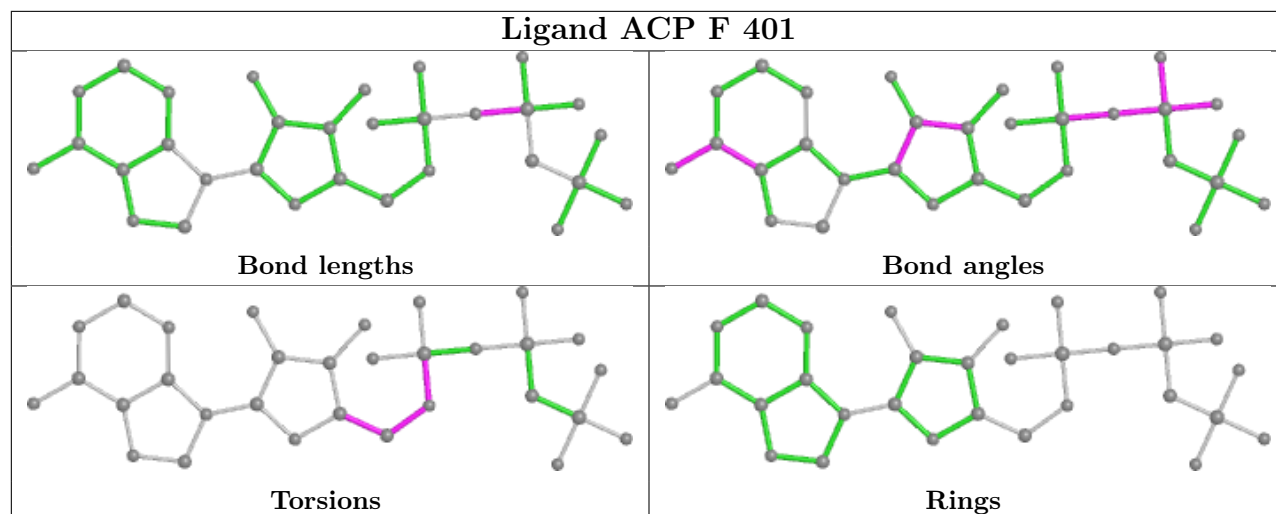

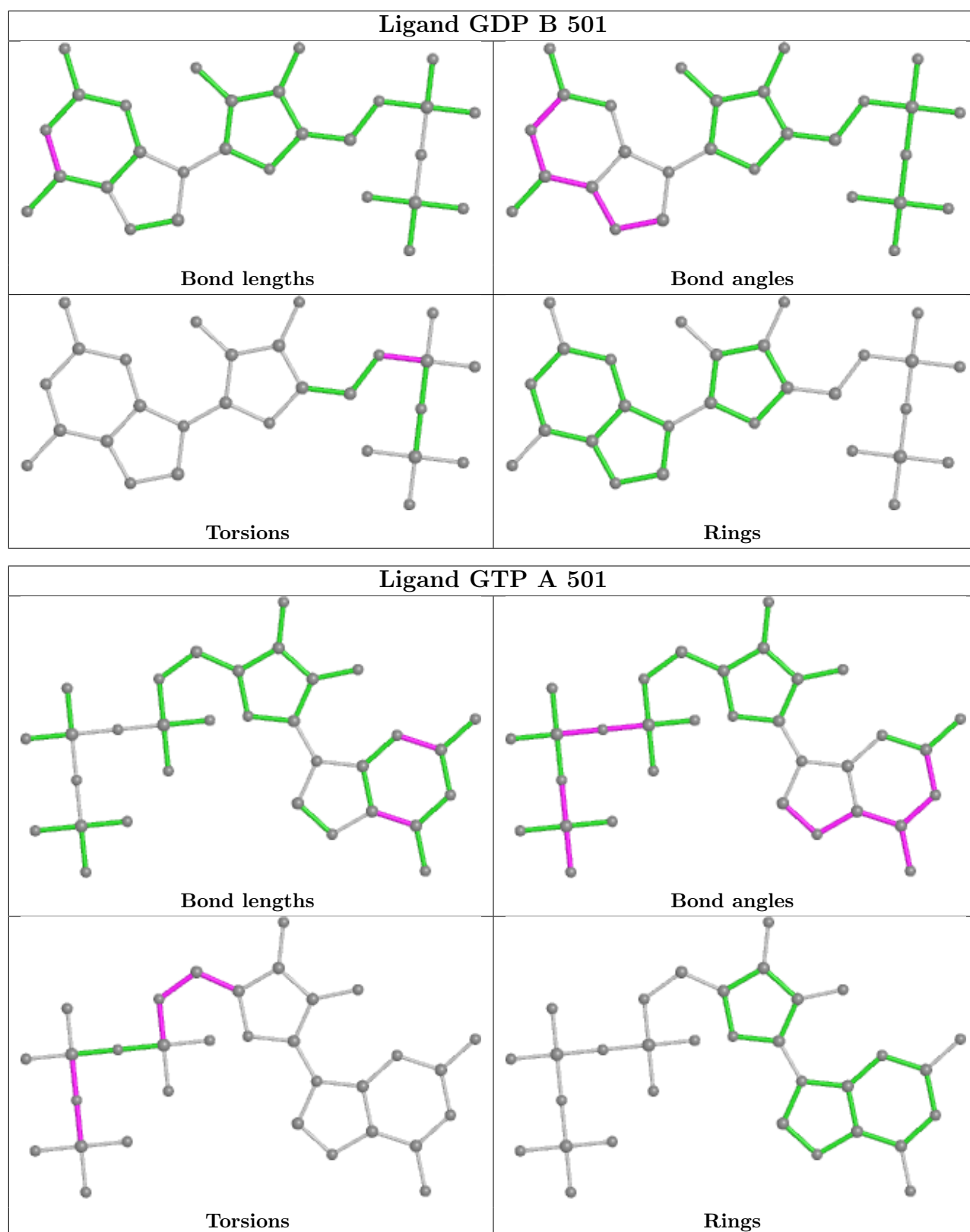

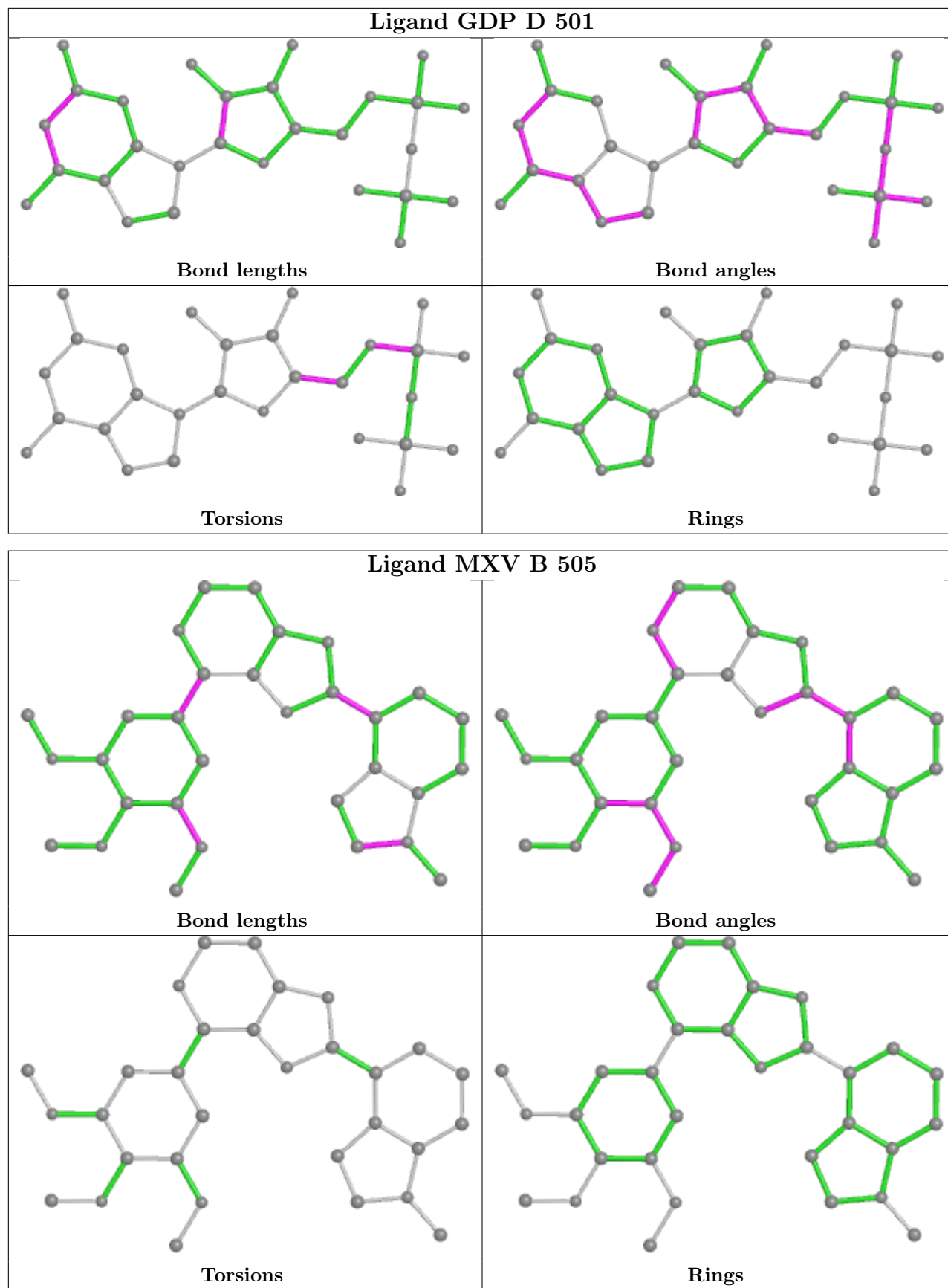

5.7 Other polymers [i](#)

There are no such residues in this entry.

5.8 Polymer linkage issues [i](#)

There are no chain breaks in this entry.

6 Fit of model and data [i](#)

6.1 Protein, DNA and RNA chains [i](#)

In the following table, the column labelled ‘#RSRZ > 2’ contains the number (and percentage) of RSRZ outliers, followed by percent RSRZ outliers for the chain as percentile scores relative to all X-ray entries and entries of similar resolution. The OWAB column contains the minimum, median, 95th percentile and maximum values of the occupancy-weighted average B-factor per residue. The column labelled ‘Q < 0.9’ lists the number of (and percentage) of residues with an average occupancy less than 0.9.

Mol	Chain	Analysed	<RSRZ>	#RSRZ>2	OWAB(Å ²)	Q<0.9
1	A	437/450 (97%)	-0.31	3 (0%) 87 84	30, 51, 78, 90	0
1	C	440/450 (97%)	-0.51	2 (0%) 91 88	23, 38, 64, 82	0
2	B	427/445 (95%)	-0.20	16 (3%) 41 31	25, 48, 85, 128	0
2	D	421/445 (94%)	0.16	21 (4%) 28 19	35, 74, 109, 130	0
3	E	121/143 (84%)	0.30	8 (6%) 18 11	36, 67, 108, 122	0
4	F	316/384 (82%)	0.48	42 (13%) 3 2	40, 79, 134, 150	0
All	All	2162/2317 (93%)	-0.09	92 (4%) 35 25	23, 56, 107, 150	0

The worst 5 of 92 RSRZ outliers are listed below:

Mol	Chain	Res	Type	RSRZ
4	F	225	SER	6.7
4	F	244	CYS	5.6
4	F	163	SER	4.9
2	D	98	GLY	4.8
2	D	216	LYS	4.6

6.2 Non-standard residues in protein, DNA, RNA chains [i](#)

There are no non-standard protein/DNA/RNA residues in this entry.

6.3 Carbohydrates [i](#)

There are no monosaccharides in this entry.

6.4 Ligands

In the following table, the Atoms column lists the number of modelled atoms in the group and the number defined in the chemical component dictionary. The B-factors column lists the minimum, median, 95th percentile and maximum values of B factors of atoms in the group. The column labelled 'Q<0.9' lists the number of atoms with occupancy less than 0.9.

Mol	Type	Chain	Res	Atoms	RSCC	RSR	B-factors(Å ²)	Q<0.9
11	ACP	F	401	31/31	0.78	0.29	93,117,154,164	0
8	GDP	D	501	28/28	0.88	0.20	65,77,89,96	0
9	MES	B	504	12/12	0.90	0.27	74,78,87,92	0
7	CA	C	503	1/1	0.93	0.06	57,57,57,57	0
10	MXV	B	505	31/31	0.93	0.15	41,51,57,61	0
6	MG	B	502	1/1	0.93	0.26	40,40,40,40	0
9	MES	B	503	12/12	0.95	0.16	47,59,80,84	0
6	MG	C	502	1/1	0.95	0.31	37,37,37,37	0
5	GTP	C	501	32/32	0.98	0.12	29,34,37,39	0
6	MG	A	502	1/1	0.98	0.40	39,39,39,39	0
8	GDP	B	501	28/28	0.98	0.13	22,37,46,68	0
5	GTP	A	501	32/32	0.98	0.11	34,40,45,45	0
7	CA	A	503	1/1	0.99	0.07	82,82,82,82	0

The following is a graphical depiction of the model fit to experimental electron density of all instances of the Ligand of Interest. In addition, ligands with molecular weight > 250 and outliers as shown on the geometry validation Tables will also be included. Each fit is shown from different orientation to approximate a three-dimensional view.

Electron density around ACP F 401:

$2mF_o-DF_c$ (at 0.7 rmsd) in gray
 mF_o-DF_c (at 3 rmsd) in purple (negative)
and green (positive)

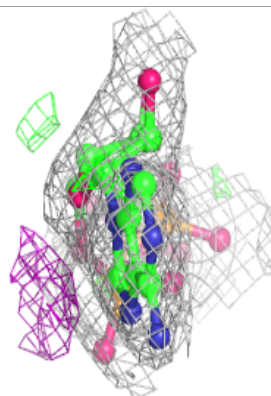
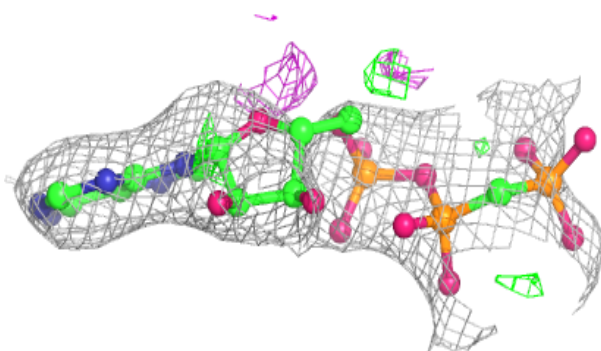
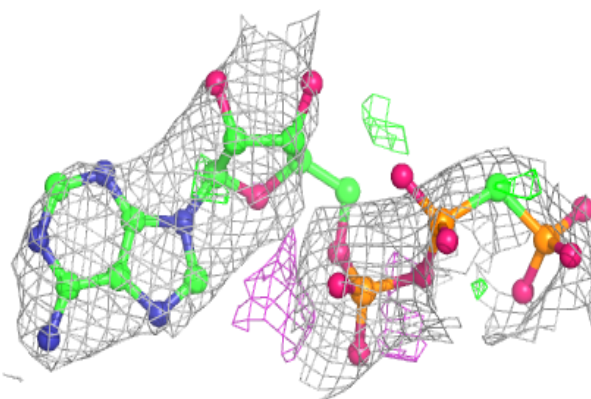
**Electron density around GDP D 501:**

$2mF_o-DF_c$ (at 0.7 rmsd) in gray
 mF_o-DF_c (at 3 rmsd) in purple (negative)
and green (positive)

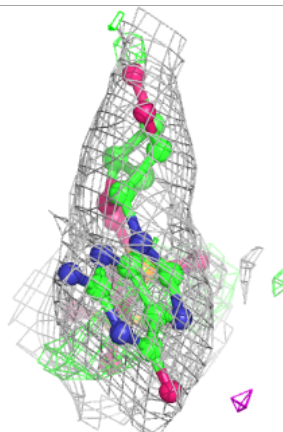
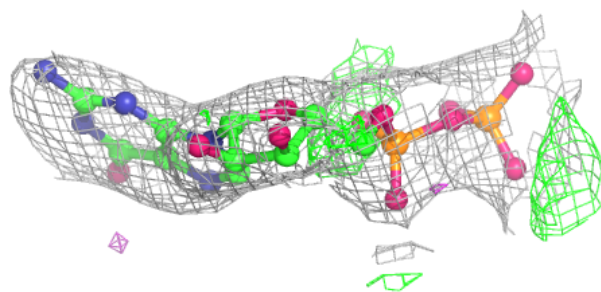
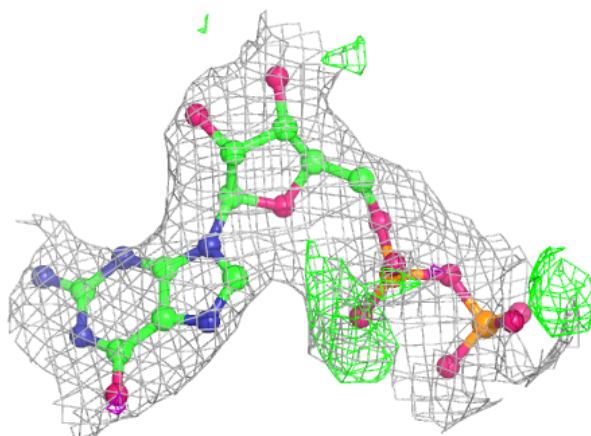

Electron density around MXV B 505:

$2mF_o-DF_c$ (at 0.7 rmsd) in gray
 mF_o-DF_c (at 3 rmsd) in purple (negative)
and green (positive)

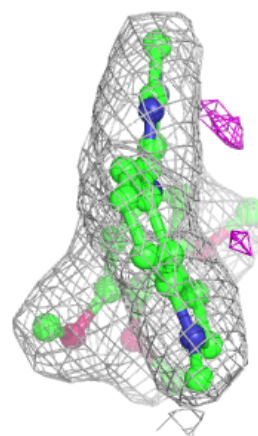
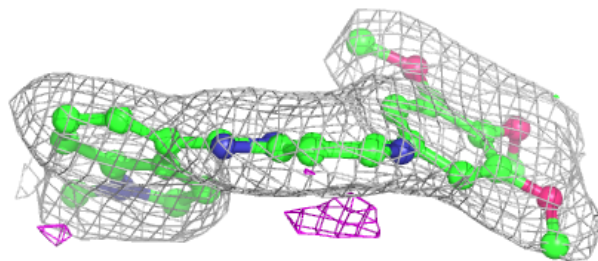
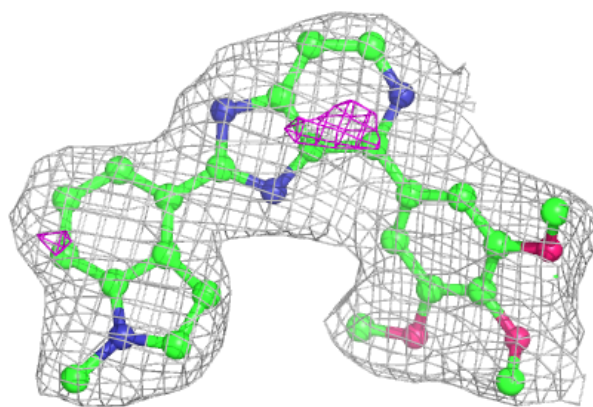

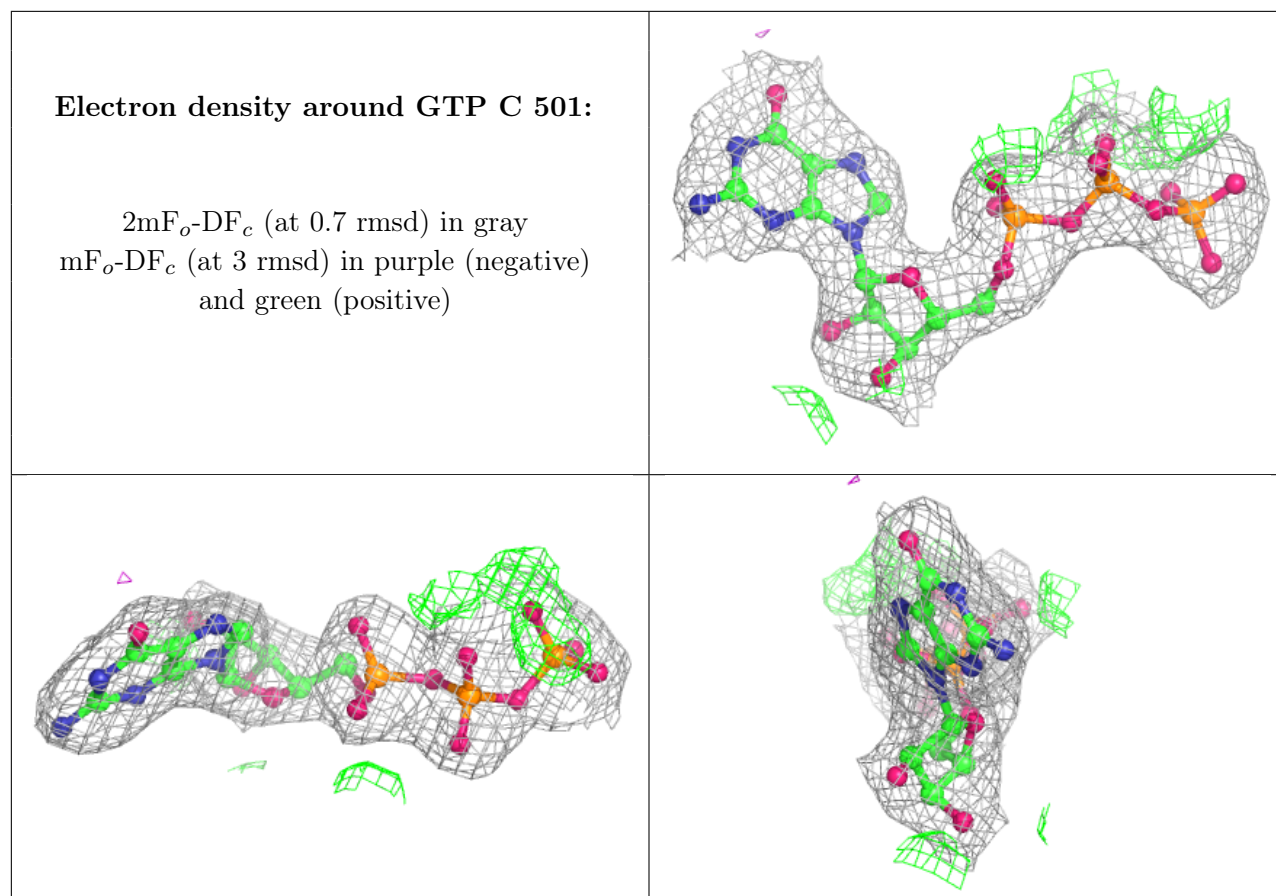

Electron density around GDP B 501:

$2mF_o-DF_c$ (at 0.7 rmsd) in gray
 mF_o-DF_c (at 3 rmsd) in purple (negative)
and green (positive)

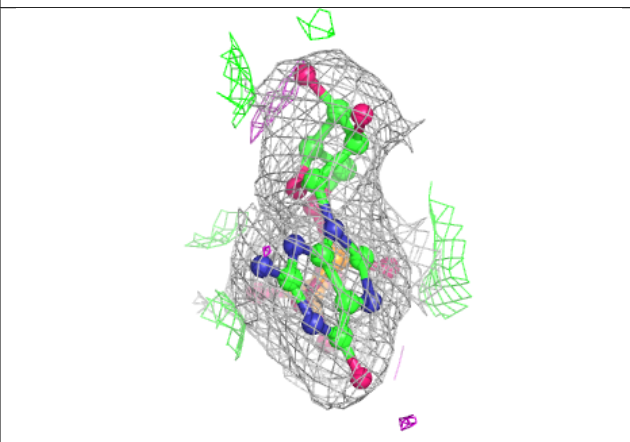
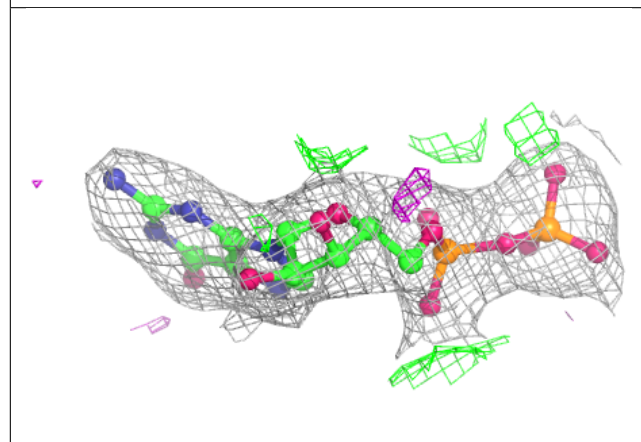
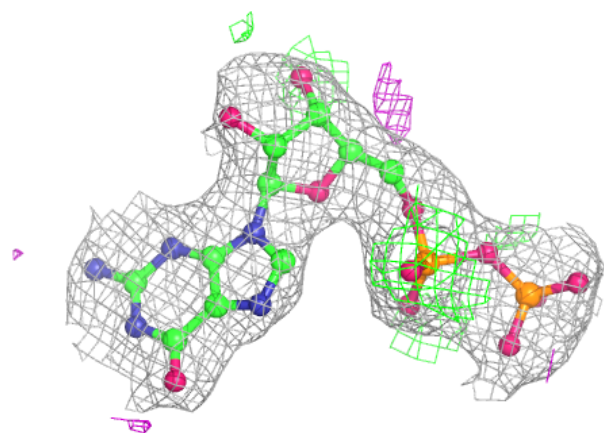
**Electron density around GTP A 501:**

$2mF_o-DF_c$ (at 0.7 rmsd) in gray
 mF_o-DF_c (at 3 rmsd) in purple (negative)
and green (positive)

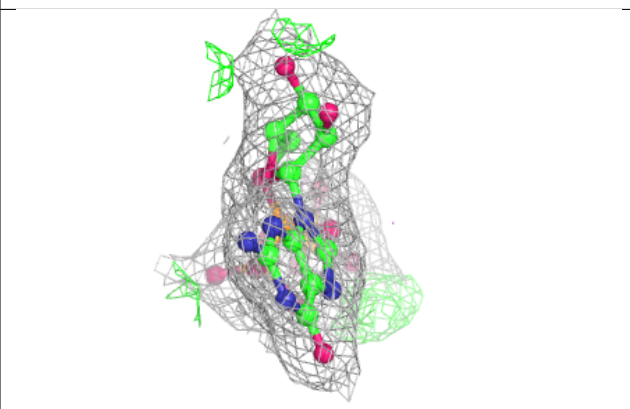
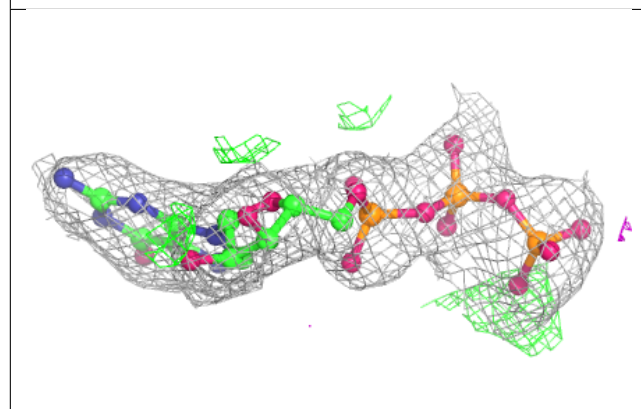
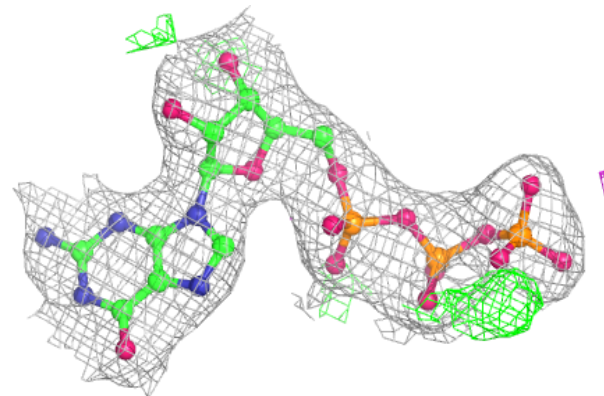

6.5 Other polymers [i](#)

There are no such residues in this entry.