



wwPDB X-ray Structure Validation Summary Report ⓘ

Jun 15, 2024 – 05:11 PM EDT

PDB ID : 2IFA
Title : Crystal Structure of the PUTATIVE NITROREDUCTASE (SMU.260) IN COMPLEX WITH FMN FROM STREPTOCOCCUS MUTANS, NORTH-EAST STRUCTURAL GENOMICS TARGET SMR5.
Authors : Forouhar, F.; Chen, Y.; Xiao, R.; Ma, L.C.; Byler, T.; Acton, T.B.; Montelione, G.T.; Tong, L.; Hunt, J.F.; Northeast Structural Genomics Consortium (NESG)
Deposited on : 2006-09-20
Resolution : 2.30 Å(reported)

This is a wwPDB X-ray Structure Validation Summary Report for a publicly released PDB entry.

We welcome your comments at validation@mail.wwpdb.org

A user guide is available at

<https://www.wwpdb.org/validation/2017/XrayValidationReportHelp>

with specific help available everywhere you see the ⓘ symbol.

The types of validation reports are described at

<http://www.wwpdb.org/validation/2017/FAQs#types>.

The following versions of software and data (see [references ⓘ](#)) were used in the production of this report:

MolProbity : 4.02b-467
Mogul : 2022.3.0, CSD as543be (2022)
Xtriage (Phenix) : 1.20.1
EDS : 2.37.1
buster-report : 1.1.7 (2018)
Percentile statistics : 20191225.v01 (using entries in the PDB archive December 25th 2019)
Refmac : 5.8.0158
CCP4 : 7.0.044 (Gargrove)
Ideal geometry (proteins) : Engh & Huber (2001)

1 Overall quality at a glance

The following experimental techniques were used to determine the structure:

X-RAY DIFFRACTION

The reported resolution of this entry is 2.30 Å.

Percentile scores (ranging between 0-100) for global validation metrics of the entry are shown in the following graphic. The table shows the number of entries on which the scores are based.

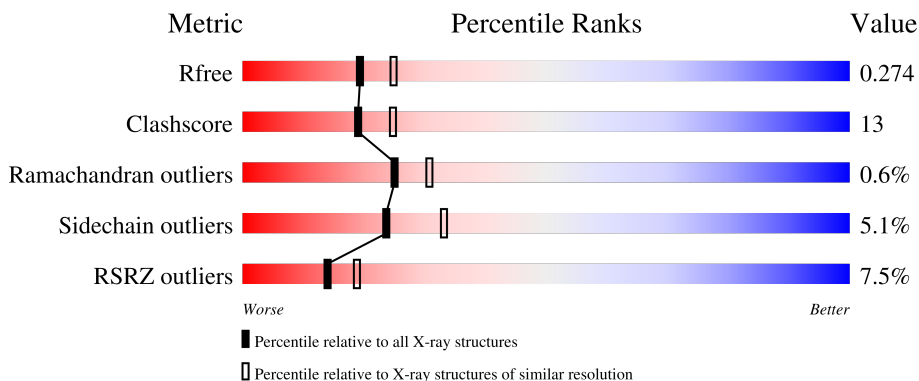

Metric	Whole archive (#Entries)	Similar resolution (#Entries, resolution range(Å))
R_{free}	130704	5042 (2.30-2.30)
Clashscore	141614	5643 (2.30-2.30)
Ramachandran outliers	138981	5575 (2.30-2.30)
Sidechain outliers	138945	5575 (2.30-2.30)
RSRZ outliers	127900	4938 (2.30-2.30)



The table below summarises the geometric issues observed across the polymeric chains and their fit to the electron density. The red, orange, yellow and green segments of the lower bar indicate the fraction of residues that contain outliers for ≥ 3 , 2, 1 and 0 types of geometric quality criteria respectively. A grey segment represents the fraction of residues that are not modelled. The numeric value for each fraction is indicated below the corresponding segment, with a dot representing fractions $\leq 5\%$. The upper red bar (where present) indicates the fraction of residues that have poor fit to the electron density. The numeric value is given above the bar.

Mol	Chain	Length	Quality of chain
1	A	208	 70% 25% . .
1	B	208	 71% 23% . .
1	C	208	 72% 25% .

Continued on next page...

Ideal geometry (DNA, RNA) : Parkinson et al. (1996)
Validation Pipeline (wwPDB-VP) : 2.37.1

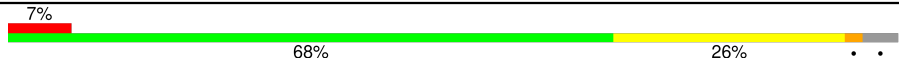
Continued from previous page...

Mol	Chain	Length	Quality of chain
1	D	208	
1	E	208	
1	F	208	

2 Entry composition

There are 3 unique types of molecules in this entry. The entry contains 10188 atoms, of which 0 are hydrogens and 0 are deuteriums.

In the tables below, the ZeroOcc column contains the number of atoms modelled with zero occupancy, the AltConf column contains the number of residues with at least one atom in alternate conformation and the Trace column contains the number of residues modelled with at most 2 atoms.

- Molecule 1 is a protein called Hypothetical protein SMU.260.

Mol	Chain	Residues	Atoms					ZeroOcc	AltConf	Trace
			Total	C	N	O	Se			
1	A	200	1582	1017	263	299	3	0	0	0
1	B	201	1591	1022	264	302	3	0	0	0
1	C	201	1591	1022	264	302	3	0	0	0
1	D	200	1582	1017	263	299	3	0	0	0
1	E	201	1591	1022	264	302	3	0	0	0
1	F	199	1574	1011	262	298	3	0	0	0

There are 72 discrepancies between the modelled and reference sequences:

Chain	Residue	Modelled	Actual	Comment	Reference
A	1	MSE	MET	MODIFIED RESIDUE	UNP Q8DW21
A	145	MSE	MET	MODIFIED RESIDUE	UNP Q8DW21
A	170	MSE	MET	MODIFIED RESIDUE	UNP Q8DW21
A	189	MSE	MET	MODIFIED RESIDUE	UNP Q8DW21
A	201	LEU	-	EXPRESSION TAG	UNP Q8DW21
A	202	GLU	-	EXPRESSION TAG	UNP Q8DW21
A	203	HIS	-	EXPRESSION TAG	UNP Q8DW21
A	204	HIS	-	EXPRESSION TAG	UNP Q8DW21
A	205	HIS	-	EXPRESSION TAG	UNP Q8DW21
A	206	HIS	-	EXPRESSION TAG	UNP Q8DW21
A	207	HIS	-	EXPRESSION TAG	UNP Q8DW21
A	208	HIS	-	EXPRESSION TAG	UNP Q8DW21
B	1	MSE	MET	MODIFIED RESIDUE	UNP Q8DW21
B	145	MSE	MET	MODIFIED RESIDUE	UNP Q8DW21
B	170	MSE	MET	MODIFIED RESIDUE	UNP Q8DW21
B	189	MSE	MET	MODIFIED RESIDUE	UNP Q8DW21
B	201	LEU	-	EXPRESSION TAG	UNP Q8DW21

Continued on next page...

Continued from previous page...

Chain	Residue	Modelled	Actual	Comment	Reference
B	202	GLU	-	EXPRESSION TAG	UNP Q8DW21
B	203	HIS	-	EXPRESSION TAG	UNP Q8DW21
B	204	HIS	-	EXPRESSION TAG	UNP Q8DW21
B	205	HIS	-	EXPRESSION TAG	UNP Q8DW21
B	206	HIS	-	EXPRESSION TAG	UNP Q8DW21
B	207	HIS	-	EXPRESSION TAG	UNP Q8DW21
B	208	HIS	-	EXPRESSION TAG	UNP Q8DW21
C	1	MSE	MET	MODIFIED RESIDUE	UNP Q8DW21
C	145	MSE	MET	MODIFIED RESIDUE	UNP Q8DW21
C	170	MSE	MET	MODIFIED RESIDUE	UNP Q8DW21
C	189	MSE	MET	MODIFIED RESIDUE	UNP Q8DW21
C	201	LEU	-	EXPRESSION TAG	UNP Q8DW21
C	202	GLU	-	EXPRESSION TAG	UNP Q8DW21
C	203	HIS	-	EXPRESSION TAG	UNP Q8DW21
C	204	HIS	-	EXPRESSION TAG	UNP Q8DW21
C	205	HIS	-	EXPRESSION TAG	UNP Q8DW21
C	206	HIS	-	EXPRESSION TAG	UNP Q8DW21
C	207	HIS	-	EXPRESSION TAG	UNP Q8DW21
C	208	HIS	-	EXPRESSION TAG	UNP Q8DW21
D	1	MSE	MET	MODIFIED RESIDUE	UNP Q8DW21
D	145	MSE	MET	MODIFIED RESIDUE	UNP Q8DW21
D	170	MSE	MET	MODIFIED RESIDUE	UNP Q8DW21
D	189	MSE	MET	MODIFIED RESIDUE	UNP Q8DW21
D	201	LEU	-	EXPRESSION TAG	UNP Q8DW21
D	202	GLU	-	EXPRESSION TAG	UNP Q8DW21
D	203	HIS	-	EXPRESSION TAG	UNP Q8DW21
D	204	HIS	-	EXPRESSION TAG	UNP Q8DW21
D	205	HIS	-	EXPRESSION TAG	UNP Q8DW21
D	206	HIS	-	EXPRESSION TAG	UNP Q8DW21
D	207	HIS	-	EXPRESSION TAG	UNP Q8DW21
D	208	HIS	-	EXPRESSION TAG	UNP Q8DW21
E	1	MSE	MET	MODIFIED RESIDUE	UNP Q8DW21
E	145	MSE	MET	MODIFIED RESIDUE	UNP Q8DW21
E	170	MSE	MET	MODIFIED RESIDUE	UNP Q8DW21
E	189	MSE	MET	MODIFIED RESIDUE	UNP Q8DW21
E	201	LEU	-	EXPRESSION TAG	UNP Q8DW21
E	202	GLU	-	EXPRESSION TAG	UNP Q8DW21
E	203	HIS	-	EXPRESSION TAG	UNP Q8DW21
E	204	HIS	-	EXPRESSION TAG	UNP Q8DW21
E	205	HIS	-	EXPRESSION TAG	UNP Q8DW21
E	206	HIS	-	EXPRESSION TAG	UNP Q8DW21
E	207	HIS	-	EXPRESSION TAG	UNP Q8DW21

Continued on next page...

Continued from previous page...

Chain	Residue	Modelled	Actual	Comment	Reference
E	208	HIS	-	EXPRESSION TAG	UNP Q8DW21
F	1	MSE	MET	MODIFIED RESIDUE	UNP Q8DW21
F	145	MSE	MET	MODIFIED RESIDUE	UNP Q8DW21
F	170	MSE	MET	MODIFIED RESIDUE	UNP Q8DW21
F	189	MSE	MET	MODIFIED RESIDUE	UNP Q8DW21
F	201	LEU	-	EXPRESSION TAG	UNP Q8DW21
F	202	GLU	-	EXPRESSION TAG	UNP Q8DW21
F	203	HIS	-	EXPRESSION TAG	UNP Q8DW21
F	204	HIS	-	EXPRESSION TAG	UNP Q8DW21
F	205	HIS	-	EXPRESSION TAG	UNP Q8DW21
F	206	HIS	-	EXPRESSION TAG	UNP Q8DW21
F	207	HIS	-	EXPRESSION TAG	UNP Q8DW21
F	208	HIS	-	EXPRESSION TAG	UNP Q8DW21

- Molecule 2 is FLAVIN MONONUCLEOTIDE (three-letter code: FMN) (formula: C₁₇H₂₁N₄O₉P).

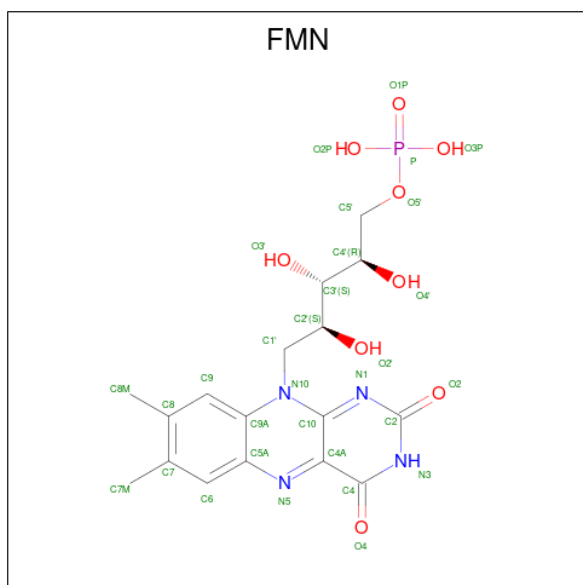

Mol	Chain	Residues	Atoms					ZeroOcc	AltConf
2	A	1	Total	C	N	O	P	0	0
			31	17	4	9	1		
2	B	1	Total	C	N	O	P	0	0
			31	17	4	9	1		
2	C	1	Total	C	N	O	P	0	0
			31	17	4	9	1		
2	D	1	Total	C	N	O	P	0	0
			31	17	4	9	1		
2	E	1	Total	C	N	O	P	0	0
			31	17	4	9	1		

Continued on next page...

Continued from previous page...

Mol	Chain	Residues	Atoms					ZeroOcc	AltConf
			Total	C	N	O	P		
2	F	1	31	17	4	9	1	0	0

- Molecule 3 is water.

Mol	Chain	Residues	Atoms		ZeroOcc	AltConf
3	A	129	Total 129	O 129	0	0
3	B	105	Total 105	O 105	0	0
3	C	78	Total 78	O 78	0	0
3	D	70	Total 70	O 70	0	0
3	E	62	Total 62	O 62	0	0
3	F	47	Total 47	O 47	0	0

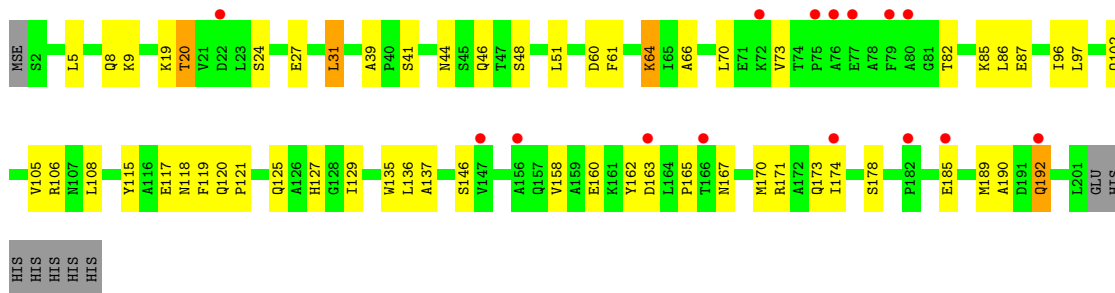

- Molecule 1: Hypothetical protein SMU.260

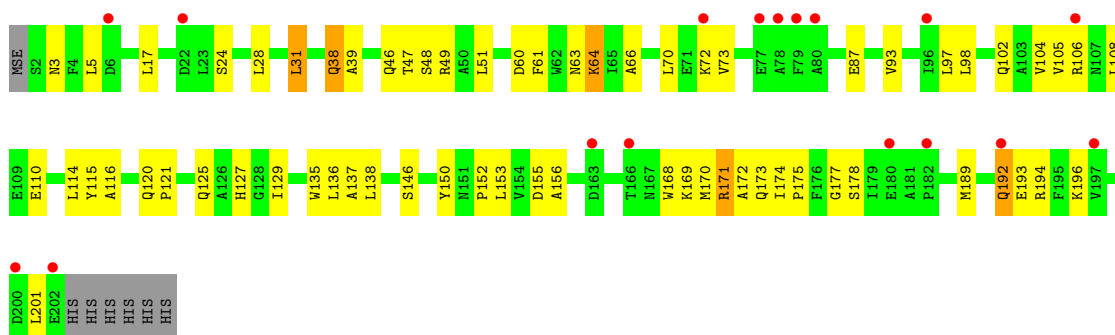

- Molecule 1: Hypothetical protein SMU.260

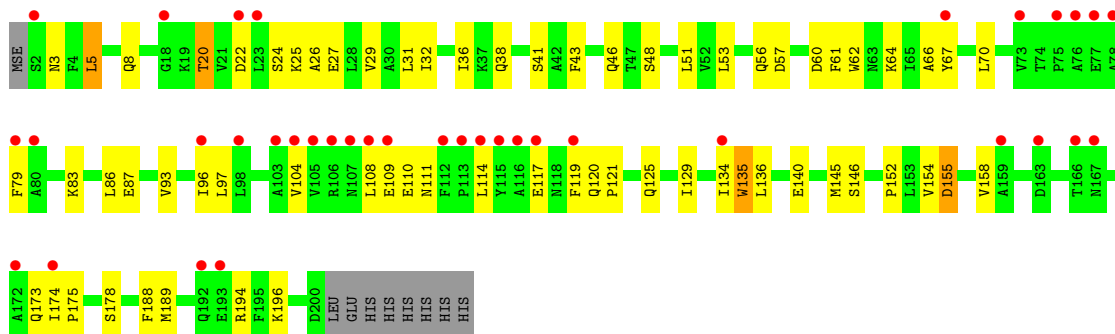

4 Data and refinement statistics

Property	Value	Source
Space group	P 1 21 1	Depositor
Cell constants a, b, c, α , β , γ	109.44Å 60.87Å 109.16Å 90.00° 117.83° 90.00°	Depositor
Resolution (Å)	29.03 – 2.30 29.03 – 2.30	Depositor EDS
% Data completeness (in resolution range)	89.3 (29.03-2.30) 96.3 (29.03-2.30)	Depositor EDS
R_{merge}	0.07	Depositor
R_{sym}	0.06	Depositor
$\langle I/\sigma(I) \rangle$ ¹	4.51 (at 2.31Å)	Xtriage
Refinement program	CNS 1.1, XTALVIEW	Depositor
R, R_{free}	0.218 , 0.273 0.220 , 0.274	Depositor DCC
R_{free} test set	10430 reflections (9.75%)	wwPDB-VP
Wilson B-factor (Å ²)	21.6	Xtriage
Anisotropy	0.243	Xtriage
Bulk solvent k_{sol} (e/Å ³), B_{sol} (Å ²)	0.33 , 49.6	EDS
L-test for twinning ²	$\langle L \rangle = 0.49$, $\langle L^2 \rangle = 0.32$	Xtriage
Estimated twinning fraction	0.006 for l,k,-h-l 0.006 for -h-l,k,h 0.018 for -h-l,-k,l 0.016 for h,-k,-h-l 0.017 for l,-k,h	Xtriage
F_o, F_c correlation	0.90	EDS
Total number of atoms	10188	wwPDB-VP
Average B, all atoms (Å ²)	28.0	wwPDB-VP

Xtriage's analysis on translational NCS is as follows: *The largest off-origin peak in the Patterson function is 4.92% of the height of the origin peak. No significant pseudotranslation is detected.*

¹Intensities estimated from amplitudes.

²Theoretical values of $\langle |L| \rangle$, $\langle L^2 \rangle$ for acentric reflections are 0.5, 0.333 respectively for untwinned datasets, and 0.375, 0.2 for perfectly twinned datasets.

5 Model quality

5.1 Standard geometry

Bond lengths and bond angles in the following residue types are not validated in this section: FMN

The Z score for a bond length (or angle) is the number of standard deviations the observed value is removed from the expected value. A bond length (or angle) with $|Z| > 5$ is considered an outlier worth inspection. RMSZ is the root-mean-square of all Z scores of the bond lengths (or angles).

Mol	Chain	Bond lengths		Bond angles	
		RMSZ	# Z >5	RMSZ	# Z >5
1	A	0.40	0/1615	0.54	0/2184
1	B	0.40	0/1624	0.55	0/2196
1	C	0.39	0/1624	0.53	0/2196
1	D	0.38	0/1615	0.53	0/2184
1	E	0.35	0/1624	0.47	0/2196
1	F	0.34	0/1607	0.47	0/2173
All	All	0.38	0/9709	0.52	0/13129

There are no bond length outliers.

There are no bond angle outliers.

There are no chirality outliers.

There are no planarity outliers.

5.2 Too-close contacts

In the following table, the Non-H and H(model) columns list the number of non-hydrogen atoms and hydrogen atoms in the chain respectively. The H(added) column lists the number of hydrogen atoms added and optimized by MolProbity. The Clashes column lists the number of clashes within the asymmetric unit, whereas Symm-Clashes lists symmetry-related clashes.

Mol	Chain	Non-H	H(model)	H(added)	Clashes	Symm-Clashes
1	A	1582	0	1549	43	0
1	B	1591	0	1555	47	0
1	C	1591	0	1555	46	0
1	D	1582	0	1549	43	0
1	E	1591	0	1555	56	0
1	F	1574	0	1538	51	0
2	A	31	0	19	4	0

Continued on next page...

Continued from previous page...

Mol	Chain	Non-H	H(model)	H(added)	Clashes	Symm-Clashes
2	B	31	0	19	2	0
2	C	31	0	19	5	0
2	D	31	0	19	3	0
2	E	31	0	19	5	0
2	F	31	0	19	3	0
3	A	129	0	0	4	0
3	B	105	0	0	4	0
3	C	78	0	0	3	0
3	D	70	0	0	3	0
3	E	62	0	0	4	0
3	F	47	0	0	5	0
All	All	10188	0	9415	249	0

The all-atom clashscore is defined as the number of clashes found per 1000 atoms (including hydrogen atoms). The all-atom clashscore for this structure is 13.

The worst 5 of 249 close contacts within the same asymmetric unit are listed below, sorted by their clash magnitude.

Atom-1	Atom-2	Interatomic distance (Å)	Clash overlap (Å)
1:D:39:ALA:HB1	1:D:129:ILE:HG22	1.57	0.86
1:A:120:GLN:HB3	1:A:121:PRO:HD3	1.60	0.83
1:E:170:MSE:HE2	1:E:173:GLN:HE21	1.45	0.82
1:B:6:ASP:O	1:B:10:GLN:HG3	1.79	0.82
1:C:46:GLN:HE22	1:D:189:MSE:H	1.29	0.81

There are no symmetry-related clashes.

5.3 Torsion angles [i](#)

5.3.1 Protein backbone [i](#)

In the following table, the Percentiles column shows the percent Ramachandran outliers of the chain as a percentile score with respect to all X-ray entries followed by that with respect to entries of similar resolution.

The Analysed column shows the number of residues for which the backbone conformation was analysed, and the total number of residues.

Mol	Chain	Analysed	Favoured	Allowed	Outliers	Percentiles
1	A	198/208 (95%)	191 (96%)	6 (3%)	1 (0%)	29 35

Continued on next page...

Continued from previous page...

Mol	Chain	Analysed	Favoured	Allowed	Outliers	Percentiles	
1	B	199/208 (96%)	184 (92%)	14 (7%)	1 (0%)	29	35
1	C	199/208 (96%)	191 (96%)	8 (4%)	0	100	100
1	D	198/208 (95%)	189 (96%)	9 (4%)	0	100	100
1	E	199/208 (96%)	185 (93%)	12 (6%)	2 (1%)	15	17
1	F	197/208 (95%)	181 (92%)	13 (7%)	3 (2%)	10	10
All	All	1190/1248 (95%)	1121 (94%)	62 (5%)	7 (1%)	25	31

5 of 7 Ramachandran outliers are listed below:

Mol	Chain	Res	Type
1	A	116	ALA
1	B	78	ALA
1	F	109	GLU
1	F	79	PHE
1	F	119	PHE

5.3.2 Protein sidechains [i](#)

In the following table, the Percentiles column shows the percent sidechain outliers of the chain as a percentile score with respect to all X-ray entries followed by that with respect to entries of similar resolution.

The Analysed column shows the number of residues for which the sidechain conformation was analysed, and the total number of residues.

Mol	Chain	Analysed	Rotameric	Outliers	Percentiles	
1	A	163/167 (98%)	158 (97%)	5 (3%)	40	55
1	B	164/167 (98%)	156 (95%)	8 (5%)	25	35
1	C	164/167 (98%)	157 (96%)	7 (4%)	29	40
1	D	163/167 (98%)	153 (94%)	10 (6%)	18	25
1	E	164/167 (98%)	155 (94%)	9 (6%)	21	30
1	F	162/167 (97%)	151 (93%)	11 (7%)	16	21
All	All	980/1002 (98%)	930 (95%)	50 (5%)	24	33

5 of 50 residues with a non-rotameric sidechain are listed below:

Mol	Chain	Res	Type
1	D	160	GLU

Continued on next page...

Continued from previous page...

Mol	Chain	Res	Type
1	E	135	TRP
1	F	155	ASP
1	D	192	GLN
1	E	64	LYS

Sometimes sidechains can be flipped to improve hydrogen bonding and reduce clashes. 5 of 41 such sidechains are listed below:

Mol	Chain	Res	Type
1	E	33	GLN
1	E	157	GLN
1	E	46	GLN
1	E	125	GLN
1	F	33	GLN

5.3.3 RNA [i](#)

There are no RNA molecules in this entry.

5.4 Non-standard residues in protein, DNA, RNA chains [i](#)

There are no non-standard protein/DNA/RNA residues in this entry.

5.5 Carbohydrates [i](#)

There are no monosaccharides in this entry.

5.6 Ligand geometry [i](#)

6 ligands are modelled in this entry.

In the following table, the Counts columns list the number of bonds (or angles) for which Mogul statistics could be retrieved, the number of bonds (or angles) that are observed in the model and the number of bonds (or angles) that are defined in the Chemical Component Dictionary. The Link column lists molecule types, if any, to which the group is linked. The Z score for a bond length (or angle) is the number of standard deviations the observed value is removed from the expected value. A bond length (or angle) with $|Z| > 2$ is considered an outlier worth inspection. RMSZ is the root-mean-square of all Z scores of the bond lengths (or angles).

Mol	Type	Chain	Res	Link	Bond lengths			Bond angles		
					Counts	RMSZ	# Z > 2	Counts	RMSZ	# Z > 2
2	FMN	C	503	-	33,33,33	3.09	16 (48%)	48,50,50	2.58	17 (35%)
2	FMN	D	504	-	33,33,33	2.94	17 (51%)	48,50,50	2.54	16 (33%)
2	FMN	A	501	-	33,33,33	3.14	19 (57%)	48,50,50	2.54	15 (31%)
2	FMN	E	505	-	33,33,33	2.87	17 (51%)	48,50,50	2.49	14 (29%)
2	FMN	F	506	-	33,33,33	2.98	18 (54%)	48,50,50	2.54	16 (33%)
2	FMN	B	502	-	33,33,33	3.01	17 (51%)	48,50,50	2.55	15 (31%)

In the following table, the Chirals column lists the number of chiral outliers, the number of chiral centers analysed, the number of these observed in the model and the number defined in the Chemical Component Dictionary. Similar counts are reported in the Torsion and Rings columns. '-' means no outliers of that kind were identified.

Mol	Type	Chain	Res	Link	Chirals	Torsions	Rings
2	FMN	C	503	-	-	0/18/18/18	0/3/3/3
2	FMN	D	504	-	-	0/18/18/18	0/3/3/3
2	FMN	A	501	-	-	0/18/18/18	0/3/3/3
2	FMN	E	505	-	-	0/18/18/18	0/3/3/3
2	FMN	F	506	-	-	0/18/18/18	0/3/3/3
2	FMN	B	502	-	-	0/18/18/18	0/3/3/3

The worst 5 of 104 bond length outliers are listed below:

Mol	Chain	Res	Type	Atoms	Z	Observed(Å)	Ideal(Å)
2	C	503	FMN	C6-C7	7.61	1.50	1.39
2	D	504	FMN	C6-C7	7.51	1.49	1.39
2	F	506	FMN	C6-C7	7.49	1.49	1.39
2	C	503	FMN	C6-C5A	7.18	1.50	1.40
2	F	506	FMN	C6-C5A	7.01	1.50	1.40

The worst 5 of 93 bond angle outliers are listed below:

Mol	Chain	Res	Type	Atoms	Z	Observed(°)	Ideal(°)
2	C	503	FMN	C5A-N5-C4A	8.87	132.44	118.09
2	A	501	FMN	C5A-N5-C4A	8.78	132.29	118.09
2	D	504	FMN	C5A-N5-C4A	8.49	131.81	118.09
2	B	502	FMN	C5A-N5-C4A	8.48	131.80	118.09
2	E	505	FMN	C5A-N5-C4A	8.44	131.75	118.09

There are no chirality outliers.

There are no torsion outliers.

There are no ring outliers.

6 monomers are involved in 22 short contacts:

Mol	Chain	Res	Type	Clashes	Symm-Clashes
2	C	503	FMN	5	0
2	D	504	FMN	3	0
2	A	501	FMN	4	0
2	E	505	FMN	5	0
2	F	506	FMN	3	0
2	B	502	FMN	2	0

The following is a two-dimensional graphical depiction of Mogul quality analysis of bond lengths, bond angles, torsion angles, and ring geometry for all instances of the Ligand of Interest. In addition, ligands with molecular weight > 250 and outliers as shown on the validation Tables will also be included. For torsion angles, if less than 5% of the Mogul distribution of torsion angles is within 10 degrees of the torsion angle in question, then that torsion angle is considered an outlier. Any bond that is central to one or more torsion angles identified as an outlier by Mogul will be highlighted in the graph. For rings, the root-mean-square deviation (RMSD) between the ring in question and similar rings identified by Mogul is calculated over all ring torsion angles. If the average RMSD is greater than 60 degrees and the minimal RMSD between the ring in question and any Mogul-identified rings is also greater than 60 degrees, then that ring is considered an outlier. The outliers are highlighted in purple. The color gray indicates Mogul did not find sufficient equivalents in the CSD to analyse the geometry.

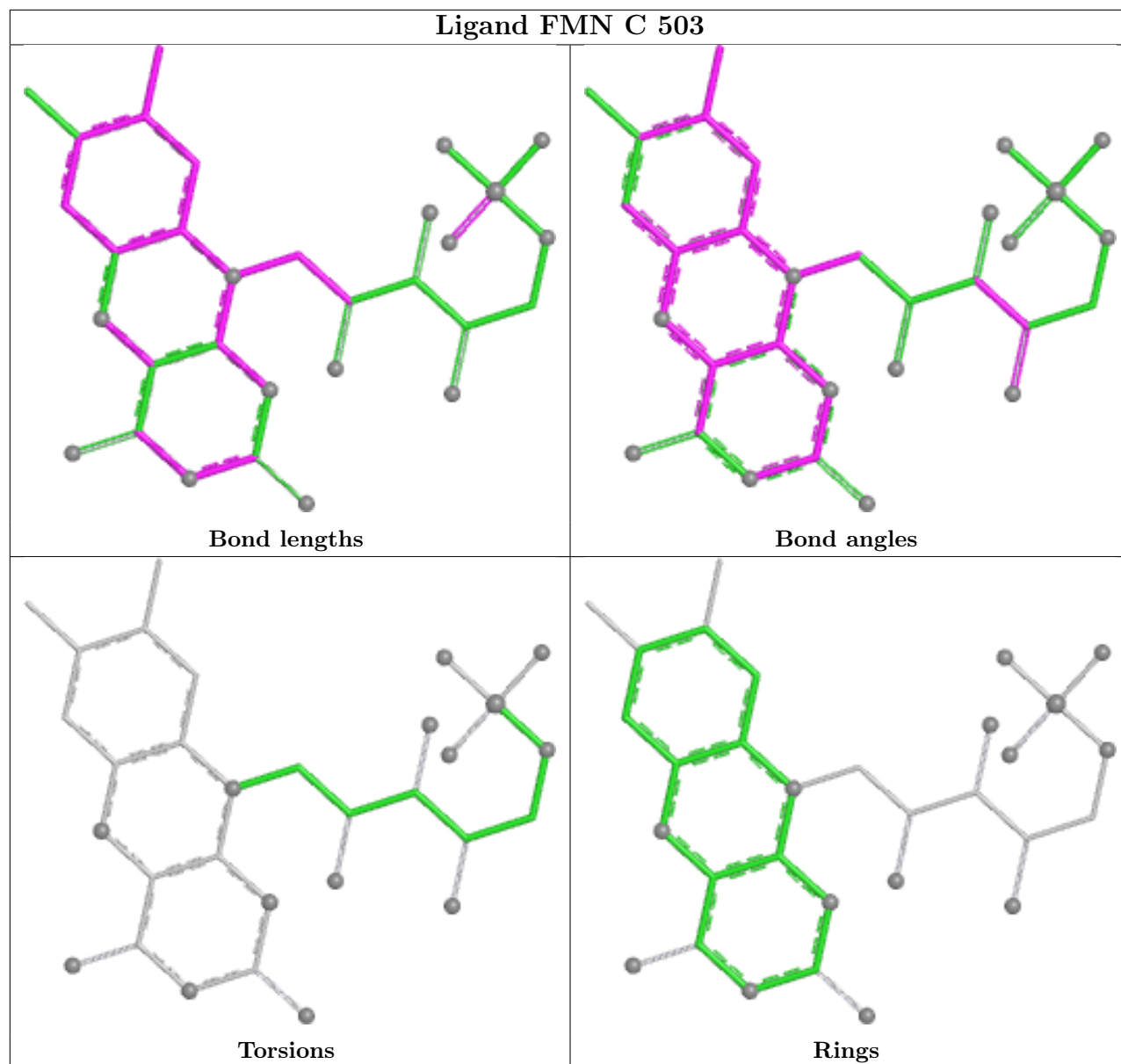

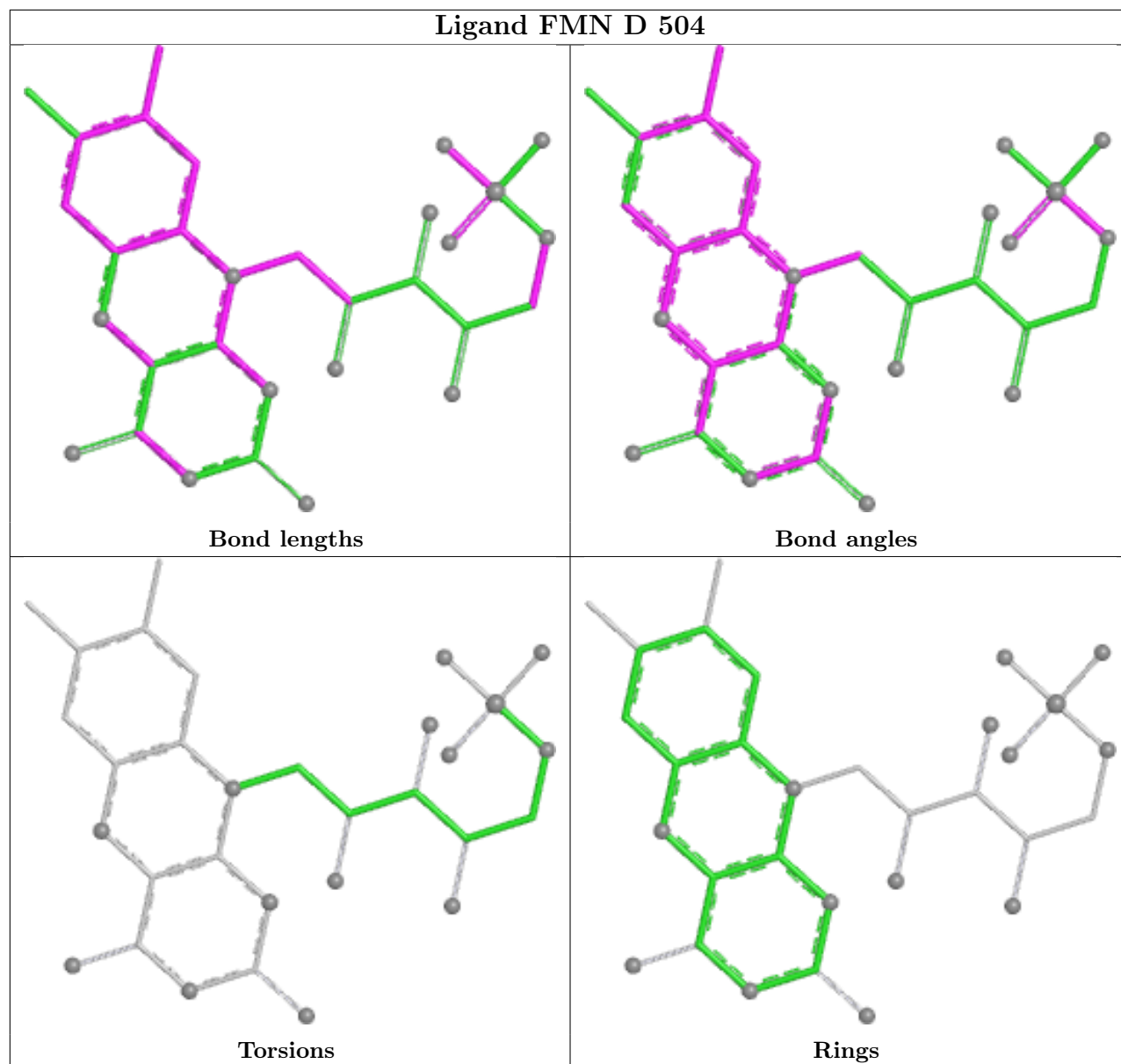

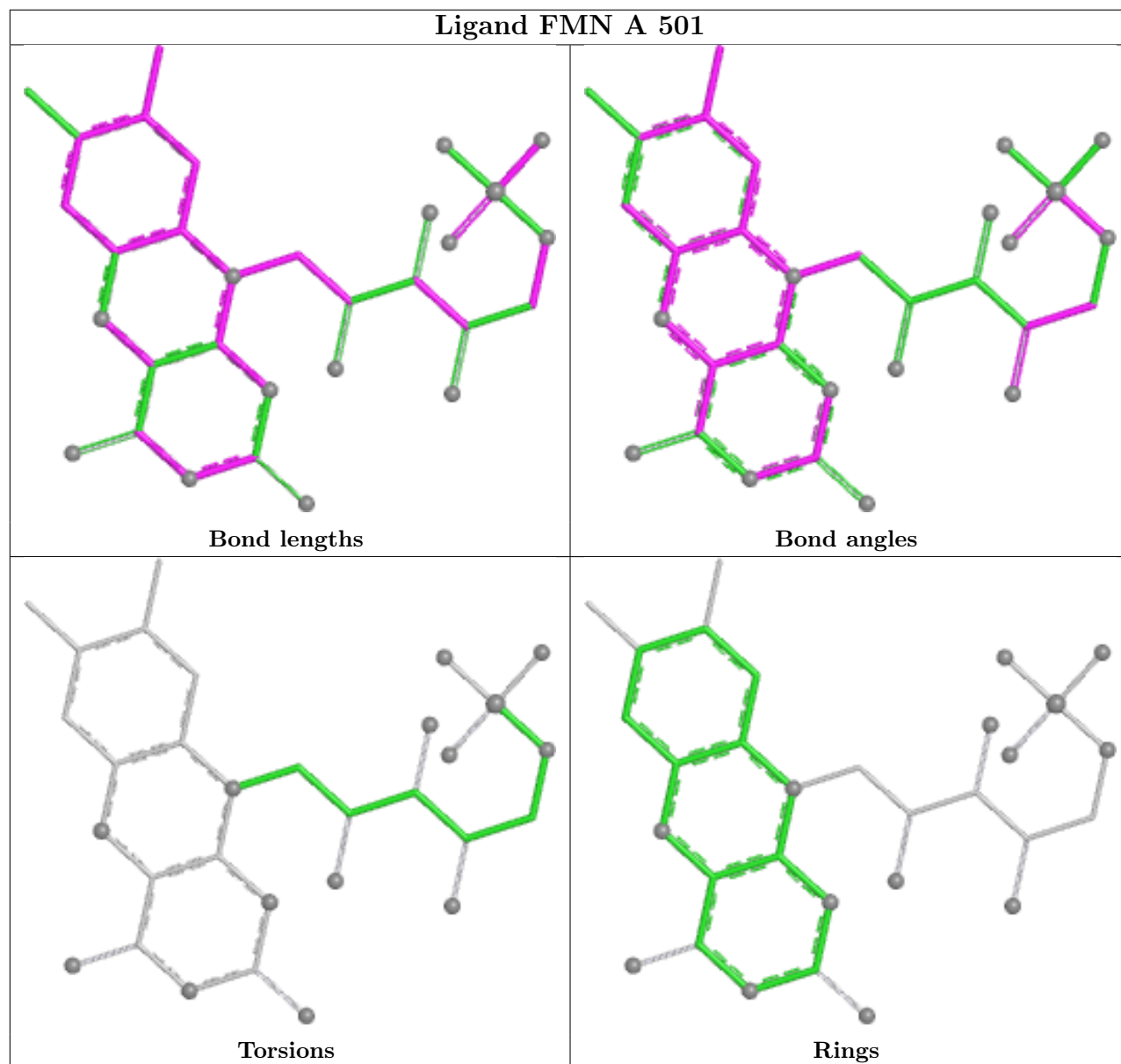

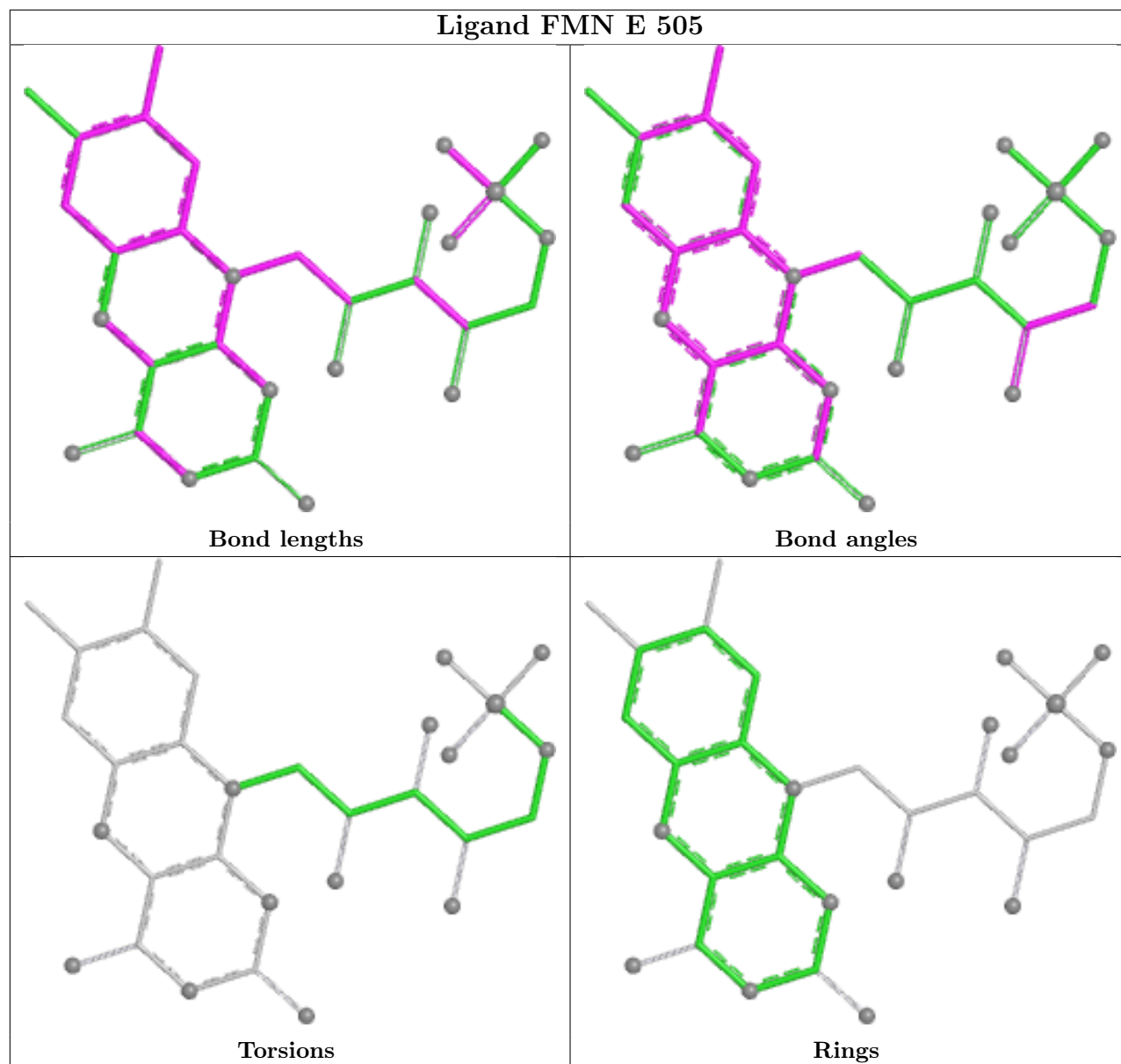

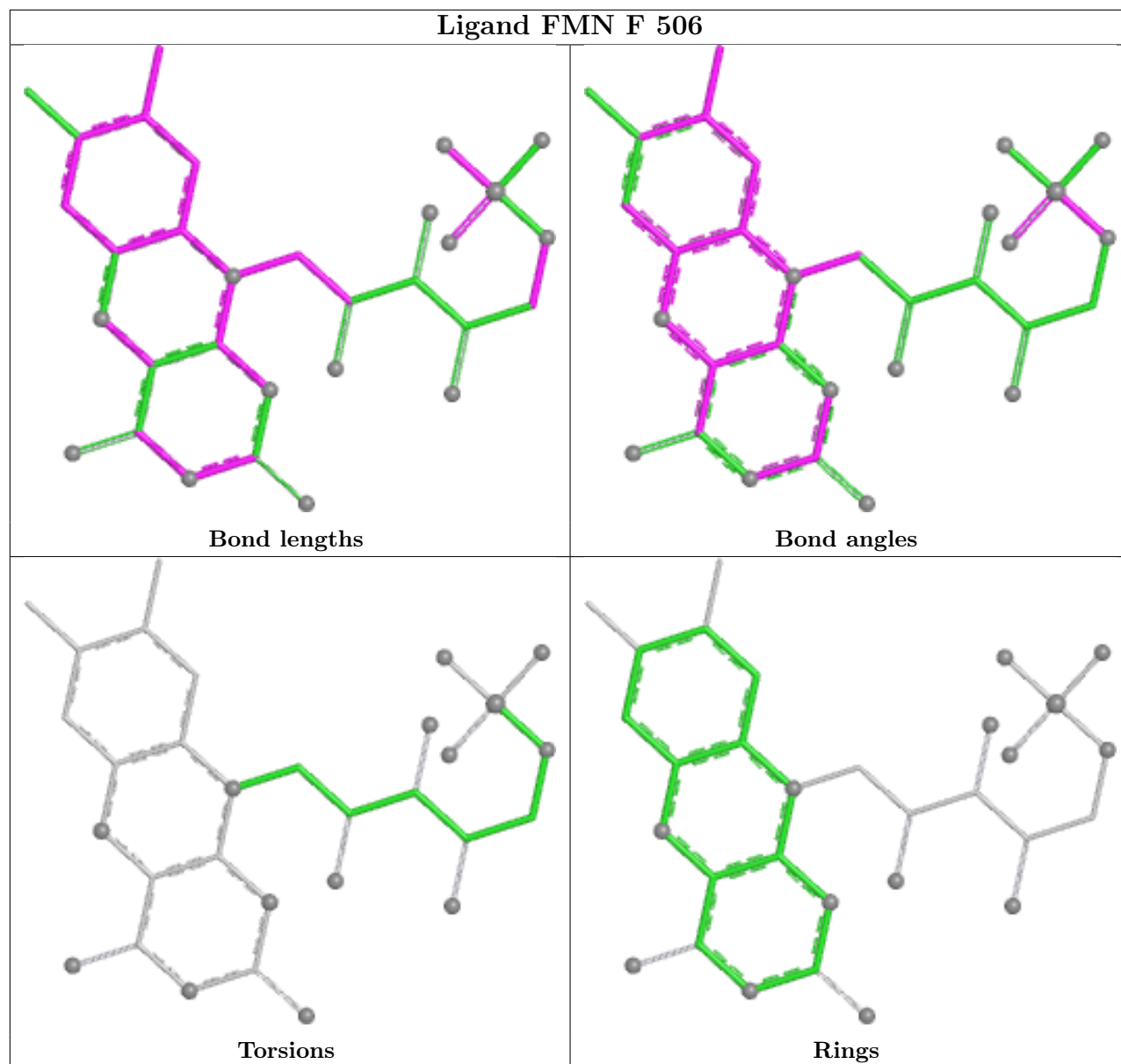

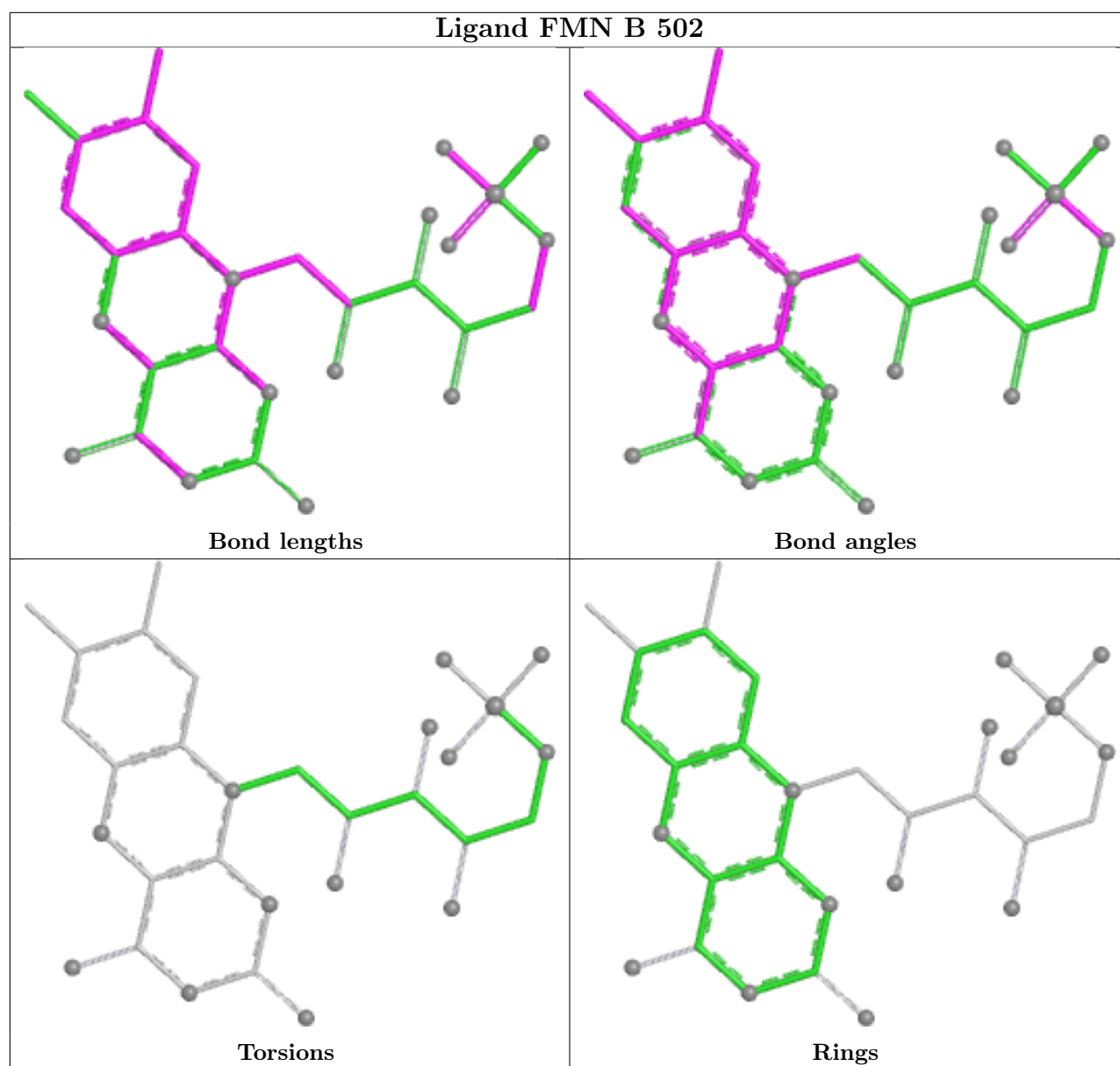

5.7 Other polymers [\(i\)](#)

There are no such residues in this entry.

5.8 Polymer linkage issues [\(i\)](#)

There are no chain breaks in this entry.

6 Fit of model and data [i](#)

6.1 Protein, DNA and RNA chains [i](#)

In the following table, the column labelled ‘#RSRZ > 2’ contains the number (and percentage) of RSRZ outliers, followed by percent RSRZ outliers for the chain as percentile scores relative to all X-ray entries and entries of similar resolution. The OWAB column contains the minimum, median, 95th percentile and maximum values of the occupancy-weighted average B-factor per residue. The column labelled ‘Q < 0.9’ lists the number of (and percentage) of residues with an average occupancy less than 0.9.

Mol	Chain	Analysed	<RSRZ>	#RSRZ>2	OWAB(Å ²)	Q<0.9
1	A	197/208 (94%)	-0.10	3 (1%) 73 79	8, 18, 37, 46	0
1	B	198/208 (95%)	0.16	8 (4%) 38 45	7, 21, 47, 54	0
1	C	198/208 (95%)	0.14	9 (4%) 33 40	9, 22, 42, 58	0
1	D	197/208 (94%)	0.31	15 (7%) 13 18	7, 26, 54, 64	0
1	E	198/208 (95%)	0.60	17 (8%) 10 14	15, 36, 52, 59	0
1	F	196/208 (94%)	0.97	37 (18%) 1 1	15, 40, 64, 72	0
All	All	1184/1248 (94%)	0.35	89 (7%) 14 19	7, 26, 53, 72	0

The worst 5 of 89 RSRZ outliers are listed below:

Mol	Chain	Res	Type	RSRZ
1	F	79	PHE	6.7
1	F	107	ASN	6.4
1	F	103	ALA	5.6
1	F	163	ASP	5.5
1	F	80	ALA	5.0

6.2 Non-standard residues in protein, DNA, RNA chains [i](#)

There are no non-standard protein/DNA/RNA residues in this entry.

6.3 Carbohydrates [i](#)

There are no monosaccharides in this entry.

6.4 Ligands [i](#)

In the following table, the Atoms column lists the number of modelled atoms in the group and the number defined in the chemical component dictionary. The B-factors column lists the minimum, median, 95th percentile and maximum values of B factors of atoms in the group. The column labelled 'Q< 0.9' lists the number of atoms with occupancy less than 0.9.

Mol	Type	Chain	Res	Atoms	RSCC	RSR	B-factors(Å ²)	Q<0.9
2	FMN	E	505	31/31	0.89	0.18	16,19,27,28	0
2	FMN	C	503	31/31	0.93	0.16	9,17,22,27	0
2	FMN	D	504	31/31	0.94	0.17	19,23,27,31	0
2	FMN	B	502	31/31	0.94	0.16	11,15,21,22	0
2	FMN	A	501	31/31	0.95	0.16	9,17,21,24	0
2	FMN	F	506	31/31	0.95	0.13	16,18,22,24	0

The following is a graphical depiction of the model fit to experimental electron density of all instances of the Ligand of Interest. In addition, ligands with molecular weight > 250 and outliers as shown on the geometry validation Tables will also be included. Each fit is shown from different orientation to approximate a three-dimensional view.

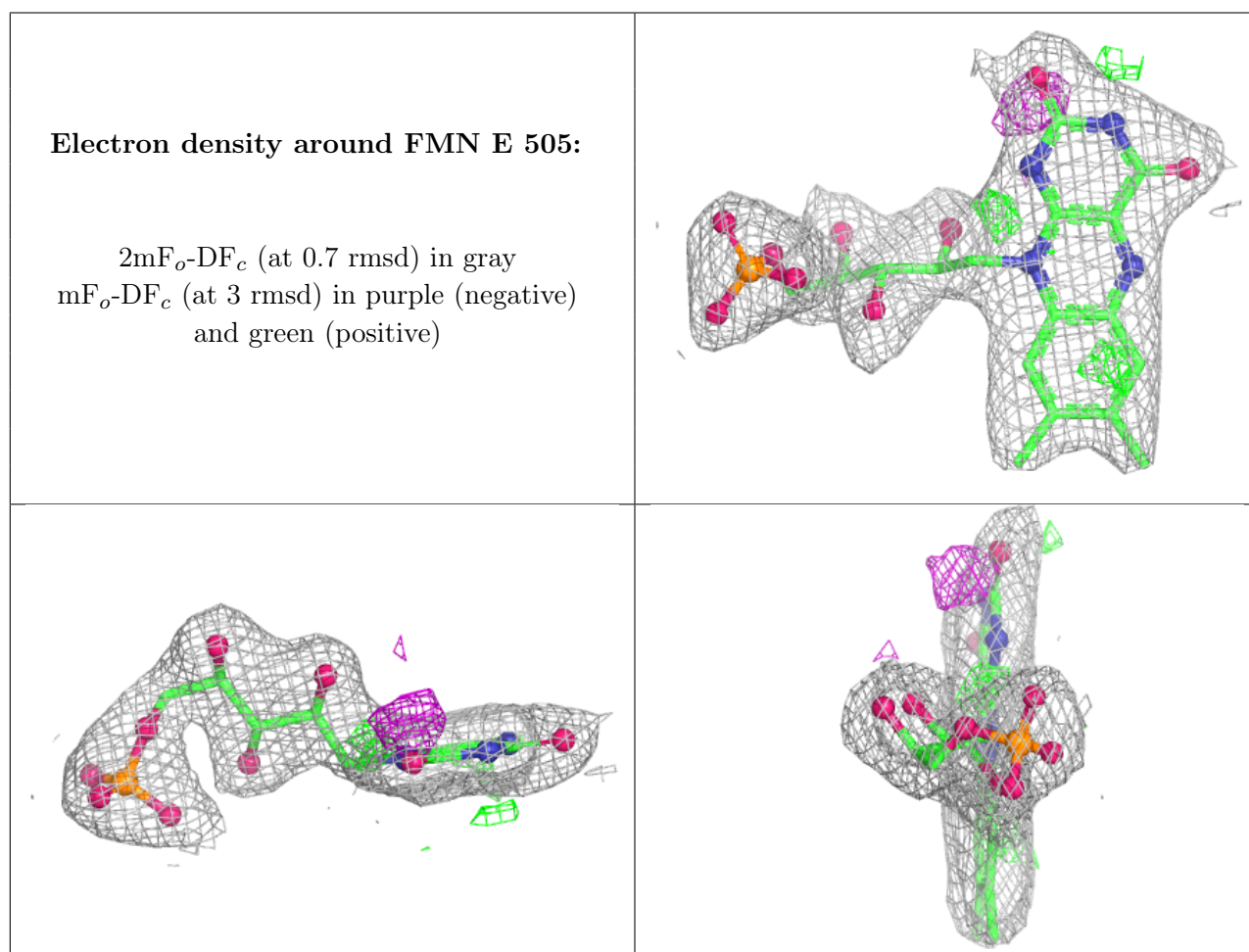

Electron density around FMN C 503:

$2mF_o-DF_c$ (at 0.7 rmsd) in gray
 mF_o-DF_c (at 3 rmsd) in purple (negative)
and green (positive)

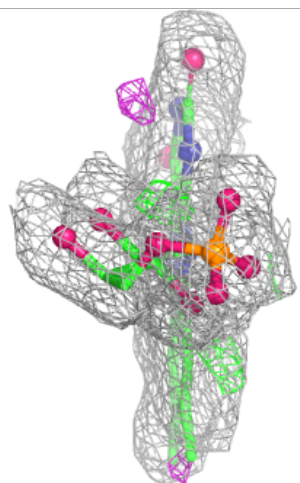
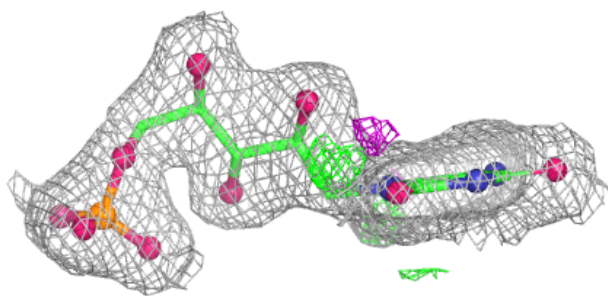
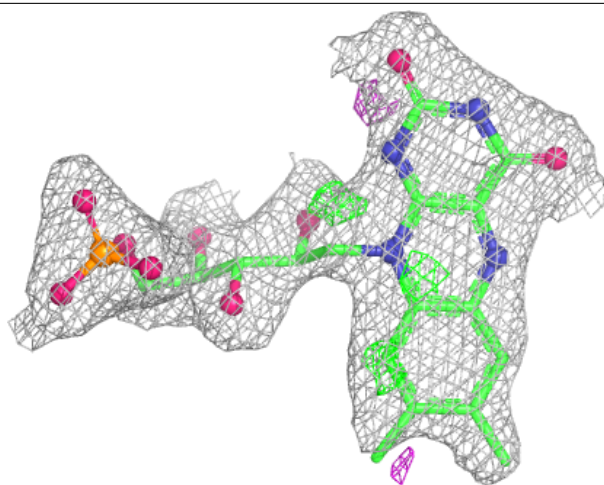

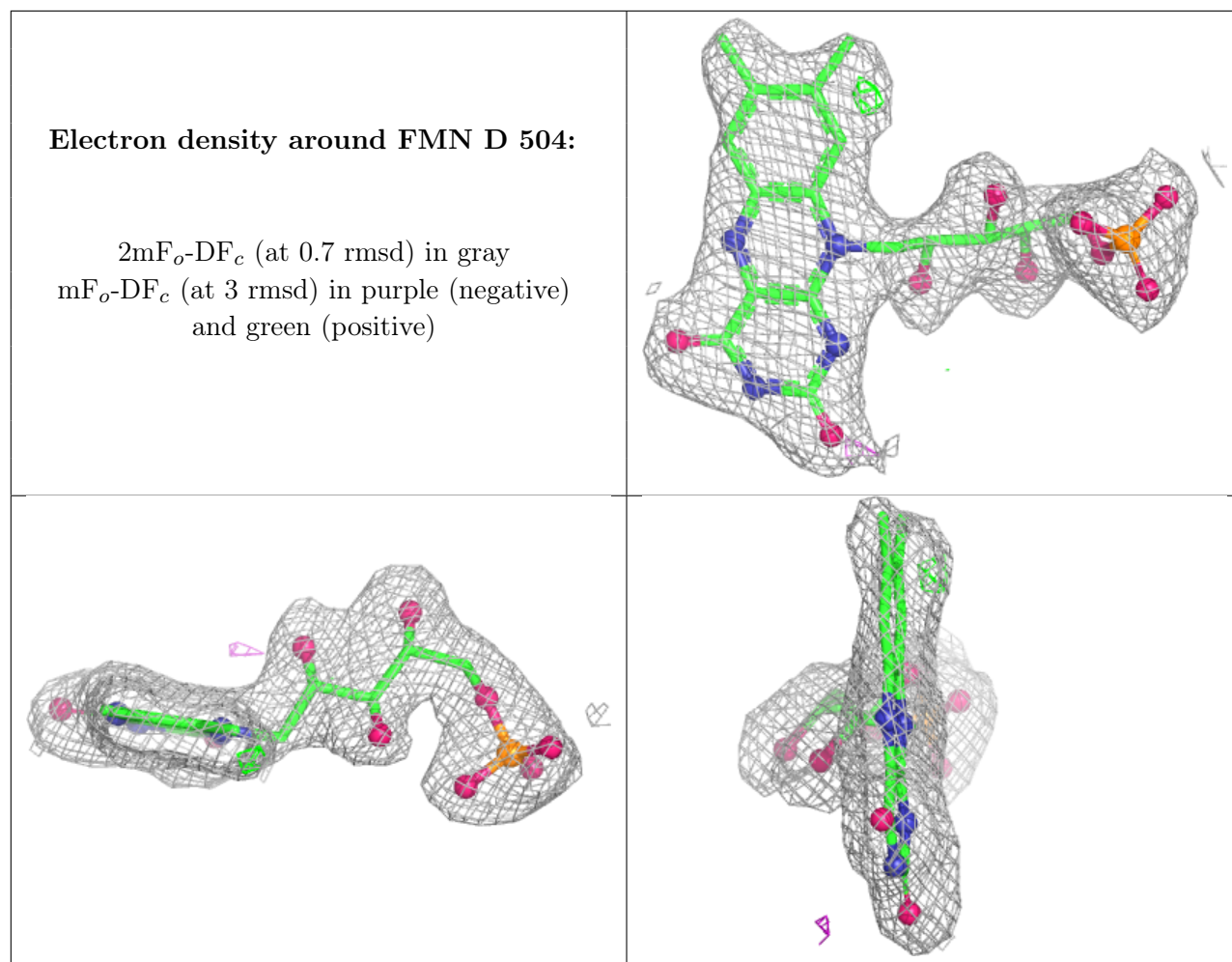

Electron density around FMN B 502:

$2mF_o-DF_c$ (at 0.7 rmsd) in gray
 mF_o-DF_c (at 3 rmsd) in purple (negative)
and green (positive)

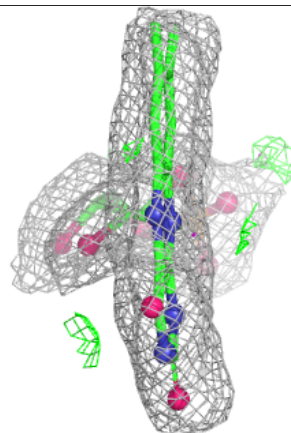
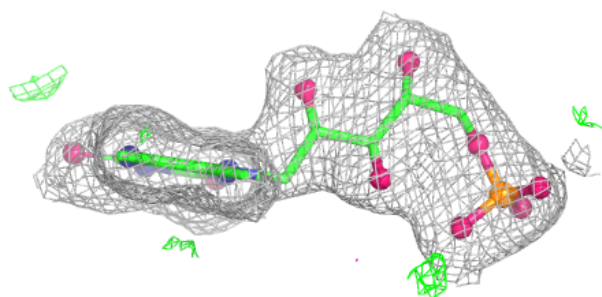
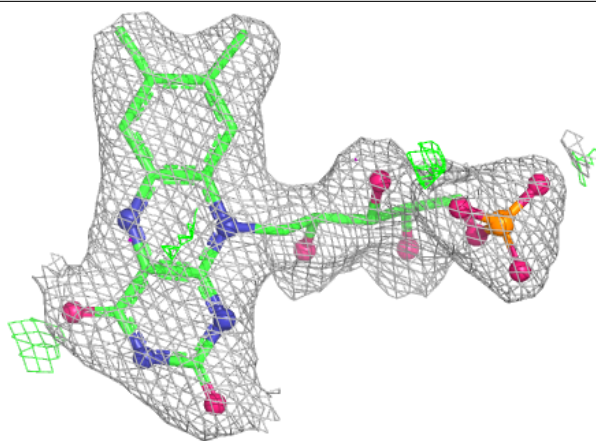

Electron density around FMN A 501:

$2mF_o-DF_c$ (at 0.7 rmsd) in gray
 mF_o-DF_c (at 3 rmsd) in purple (negative)
and green (positive)

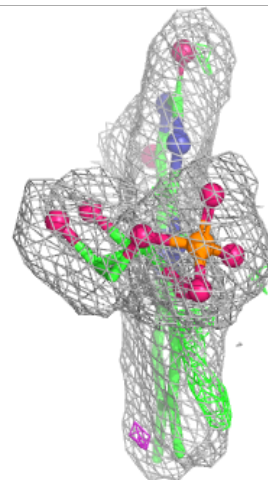
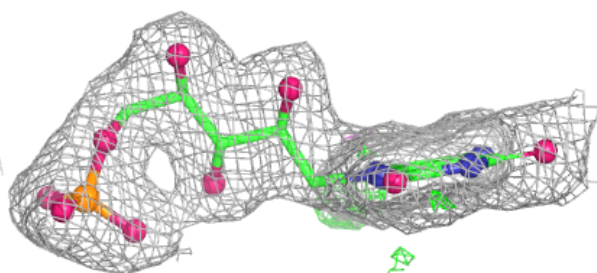
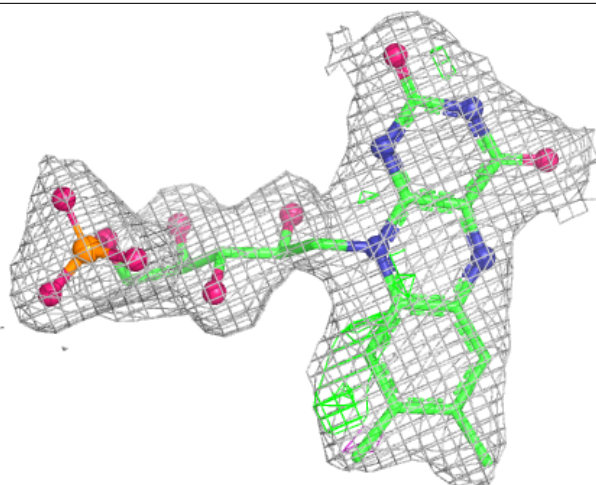

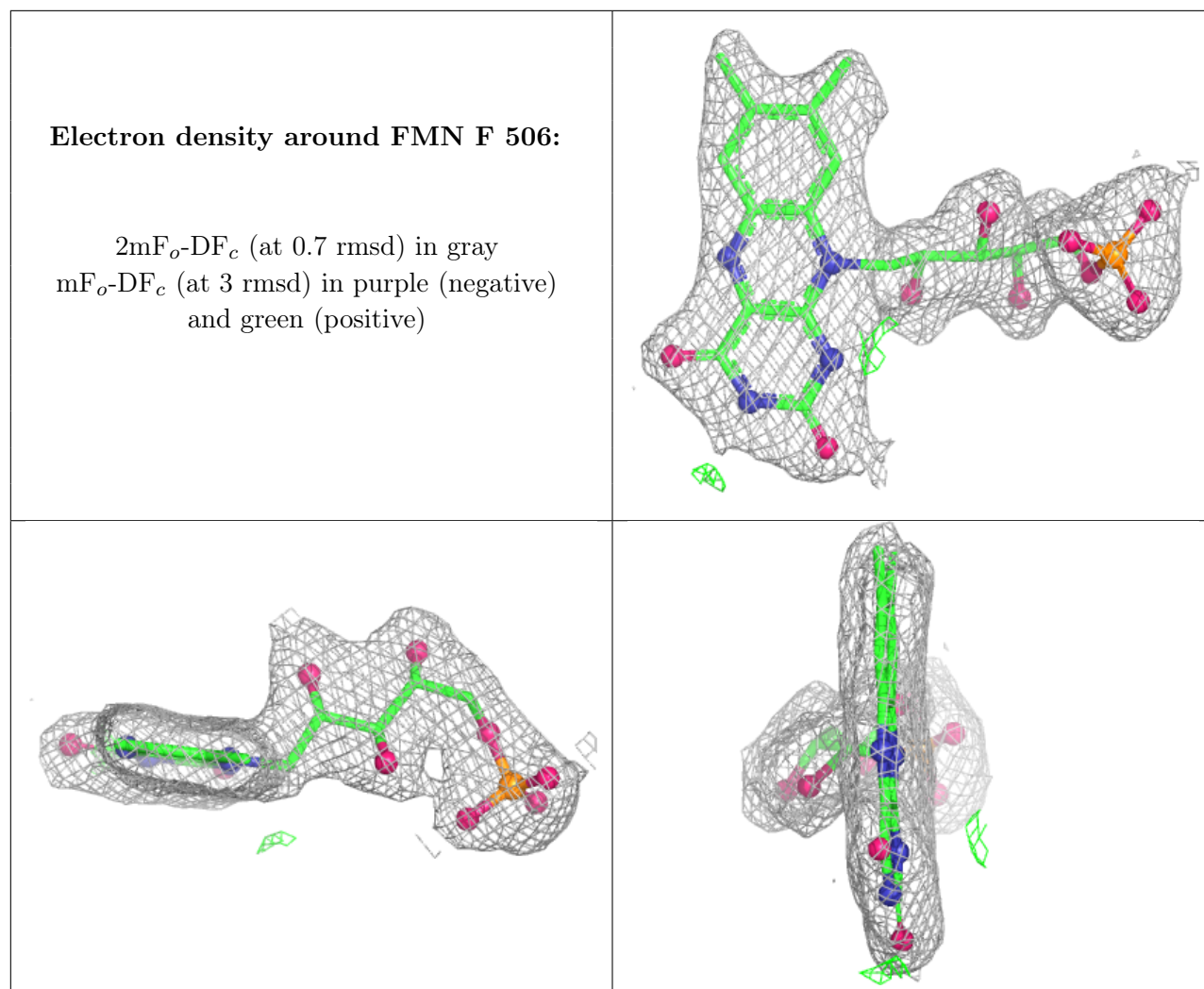

6.5 Other polymers [\(i\)](#)

There are no such residues in this entry.