



Full wwPDB X-ray Structure Validation Report ⓘ

Nov 6, 2023 – 09:20 AM EST

PDB ID : 3IF9
Title : Crystal structure of Glycine Oxidase G51S/A54R/H244A mutant in complex with inhibitor glycolate
Authors : Pedotti, M.; Rosini, E.; Molla, G.; Moschetti, T.; Vallone, B.; Savino, C.; Pollegioni, L.
Deposited on : 2009-07-24
Resolution : 2.60 Å(reported)

This is a Full wwPDB X-ray Structure Validation Report for a publicly released PDB entry.

We welcome your comments at validation@mail.wwpdb.org

A user guide is available at

<https://www.wwpdb.org/validation/2017/XrayValidationReportHelp>

with specific help available everywhere you see the ⓘ symbol.

The types of validation reports are described at

<http://www.wwpdb.org/validation/2017/FAQs#types>.

The following versions of software and data (see [references ⓘ](#)) were used in the production of this report:

MolProbity : 4.02b-467
Mogul : 1.8.5 (274361), CSD as541be (2020)
Xtriage (Phenix) : 1.13
EDS : 2.36
buster-report : 1.1.7 (2018)
Percentile statistics : 20191225.v01 (using entries in the PDB archive December 25th 2019)
Refmac : 5.8.0158
CCP4 : 7.0.044 (Gargrove)
Ideal geometry (proteins) : Engh & Huber (2001)
Ideal geometry (DNA, RNA) : Parkinson et al. (1996)
Validation Pipeline (wwPDB-VP) : 2.36

1 Overall quality at a glance

The following experimental techniques were used to determine the structure:

X-RAY DIFFRACTION

The reported resolution of this entry is 2.60 Å.

Percentile scores (ranging between 0-100) for global validation metrics of the entry are shown in the following graphic. The table shows the number of entries on which the scores are based.

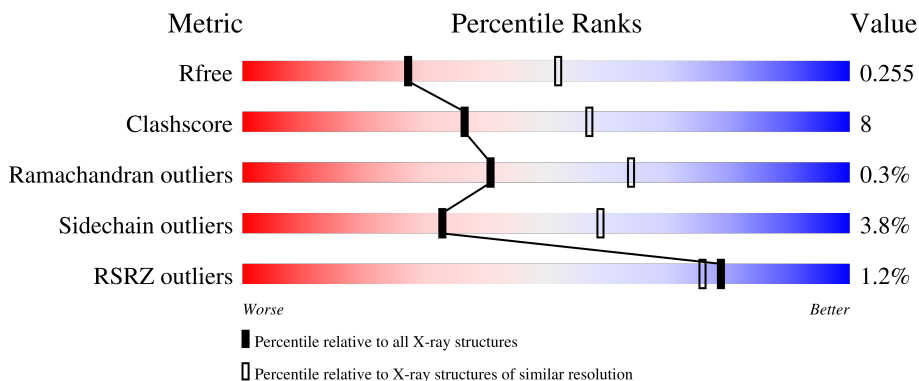

Metric	Whole archive (#Entries)	Similar resolution (#Entries, resolution range(Å))
R_{free}	130704	3163 (2.60-2.60)
Clashscore	141614	3518 (2.60-2.60)
Ramachandran outliers	138981	3455 (2.60-2.60)
Sidechain outliers	138945	3455 (2.60-2.60)
RSRZ outliers	127900	3104 (2.60-2.60)

The table below summarises the geometric issues observed across the polymeric chains and their fit to the electron density. The red, orange, yellow and green segments of the lower bar indicate the fraction of residues that contain outliers for ≥ 3 , 2, 1 and 0 types of geometric quality criteria respectively. A grey segment represents the fraction of residues that are not modelled. The numeric value for each fraction is indicated below the corresponding segment, with a dot representing fractions $\leq 5\%$. The upper red bar (where present) indicates the fraction of residues that have poor fit to the electron density. The numeric value is given above the bar.

Mol	Chain	Length	Quality of chain
1	A	382	 78% 15% • 5%
1	B	382	 80% 13% • 5%
1	C	382	 82% 12% • 5%
1	D	382	 78% 15% • 5%

The following table lists non-polymeric compounds, carbohydrate monomers and non-standard residues in protein, DNA, RNA chains that are outliers for geometric or electron-density-fit criteria:

Mol	Type	Chain	Res	Chirality	Geometry	Clashes	Electron density
2	GOA	B	370	-	X	X	-
2	GOA	C	370	-	X	X	-

2 Entry composition [i](#)

There are 4 unique types of molecules in this entry. The entry contains 11739 atoms, of which 0 are hydrogens and 0 are deuteriums.

In the tables below, the ZeroOcc column contains the number of atoms modelled with zero occupancy, the AltConf column contains the number of residues with at least one atom in alternate conformation and the Trace column contains the number of residues modelled with at most 2 atoms.

- Molecule 1 is a protein called Glycine oxidase.

Mol	Chain	Residues	Atoms					ZeroOcc	AltConf	Trace
			Total	C	N	O	S			
1	A	364	2855	1823	492	523	17	8	1	0
1	B	363	2852	1821	492	523	16	9	1	0
1	C	361	2823	1805	486	516	16	11	0	0
1	D	361	2821	1804	483	518	16	0	0	0

There are 64 discrepancies between the modelled and reference sequences:

Chain	Residue	Modelled	Actual	Comment	Reference
A	-12	MET	-	expression tag	UNP O31616
A	-11	HIS	-	expression tag	UNP O31616
A	-10	HIS	-	expression tag	UNP O31616
A	-9	HIS	-	expression tag	UNP O31616
A	-8	HIS	-	expression tag	UNP O31616
A	-7	HIS	-	expression tag	UNP O31616
A	-6	HIS	-	expression tag	UNP O31616
A	-5	MET	-	expression tag	UNP O31616
A	-4	ALA	-	expression tag	UNP O31616
A	-3	ARG	-	expression tag	UNP O31616
A	-2	ILE	-	expression tag	UNP O31616
A	-1	ARG	-	expression tag	UNP O31616
A	0	ALA	-	expression tag	UNP O31616
A	51	SER	GLY	engineered mutation	UNP O31616
A	54	ARG	ALA	engineered mutation	UNP O31616
A	244	ALA	HIS	engineered mutation	UNP O31616
B	-12	MET	-	expression tag	UNP O31616
B	-11	HIS	-	expression tag	UNP O31616
B	-10	HIS	-	expression tag	UNP O31616
B	-9	HIS	-	expression tag	UNP O31616
B	-8	HIS	-	expression tag	UNP O31616

Continued on next page...

Continued from previous page...

Chain	Residue	Modelled	Actual	Comment	Reference
B	-7	HIS	-	expression tag	UNP O31616
B	-6	HIS	-	expression tag	UNP O31616
B	-5	MET	-	expression tag	UNP O31616
B	-4	ALA	-	expression tag	UNP O31616
B	-3	ARG	-	expression tag	UNP O31616
B	-2	ILE	-	expression tag	UNP O31616
B	-1	ARG	-	expression tag	UNP O31616
B	0	ALA	-	expression tag	UNP O31616
B	51	SER	GLY	engineered mutation	UNP O31616
B	54	ARG	ALA	engineered mutation	UNP O31616
B	244	ALA	HIS	engineered mutation	UNP O31616
C	-12	MET	-	expression tag	UNP O31616
C	-11	HIS	-	expression tag	UNP O31616
C	-10	HIS	-	expression tag	UNP O31616
C	-9	HIS	-	expression tag	UNP O31616
C	-8	HIS	-	expression tag	UNP O31616
C	-7	HIS	-	expression tag	UNP O31616
C	-6	HIS	-	expression tag	UNP O31616
C	-5	MET	-	expression tag	UNP O31616
C	-4	ALA	-	expression tag	UNP O31616
C	-3	ARG	-	expression tag	UNP O31616
C	-2	ILE	-	expression tag	UNP O31616
C	-1	ARG	-	expression tag	UNP O31616
C	0	ALA	-	expression tag	UNP O31616
C	51	SER	GLY	engineered mutation	UNP O31616
C	54	ARG	ALA	engineered mutation	UNP O31616
C	244	ALA	HIS	engineered mutation	UNP O31616
D	-12	MET	-	expression tag	UNP O31616
D	-11	HIS	-	expression tag	UNP O31616
D	-10	HIS	-	expression tag	UNP O31616
D	-9	HIS	-	expression tag	UNP O31616
D	-8	HIS	-	expression tag	UNP O31616
D	-7	HIS	-	expression tag	UNP O31616
D	-6	HIS	-	expression tag	UNP O31616
D	-5	MET	-	expression tag	UNP O31616
D	-4	ALA	-	expression tag	UNP O31616
D	-3	ARG	-	expression tag	UNP O31616
D	-2	ILE	-	expression tag	UNP O31616
D	-1	ARG	-	expression tag	UNP O31616
D	0	ALA	-	expression tag	UNP O31616
D	51	SER	GLY	engineered mutation	UNP O31616
D	54	ARG	ALA	engineered mutation	UNP O31616

Continued on next page...

Continued from previous page...

Chain	Residue	Modelled	Actual	Comment	Reference
D	244	ALA	HIS	engineered mutation	UNP O31616

- Molecule 2 is GLYCOLIC ACID (three-letter code: GOA) (formula: C₂H₄O₃).

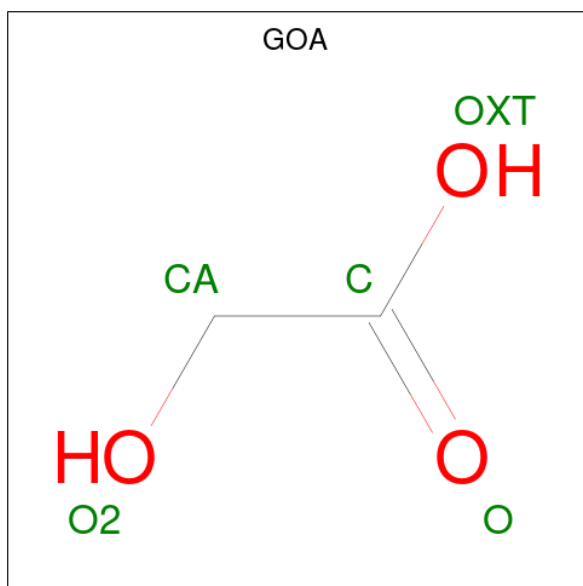

Mol	Chain	Residues	Atoms			ZeroOcc	AltConf
			Total	C	O		
2	A	1	5	2	3	0	0
2	B	1	5	2	3	0	0
2	C	1	5	2	3	0	0
2	D	1	5	2	3	0	0

- Molecule 3 is FLAVIN-ADENINE DINUCLEOTIDE (three-letter code: FAD) (formula: C₂₇H₃₃N₉O₁₅P₂).

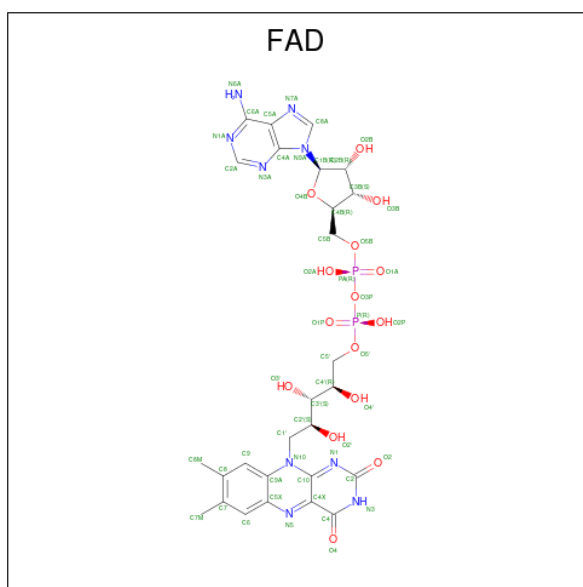

Mol	Chain	Residues	Atoms				ZeroOcc	AltConf	
			Total	C	N	O			P
3	A	1	53	27	9	15	2	0	0
3	B	1	53	27	9	15	2	0	0
3	C	1	53	27	9	15	2	0	0
3	D	1	53	27	9	15	2	0	0

- Molecule 4 is water.

Mol	Chain	Residues	Atoms		ZeroOcc	AltConf
4	A	41	Total	O	0	0
			41	41		
4	B	46	Total	O	0	0
			46	46		
4	C	47	Total	O	0	0
			47	47		
4	D	22	Total	O	0	0
			22	22		

ILE

- Molecule 1: Glycine oxidase

Chain D:  2% 78% 15% 5%

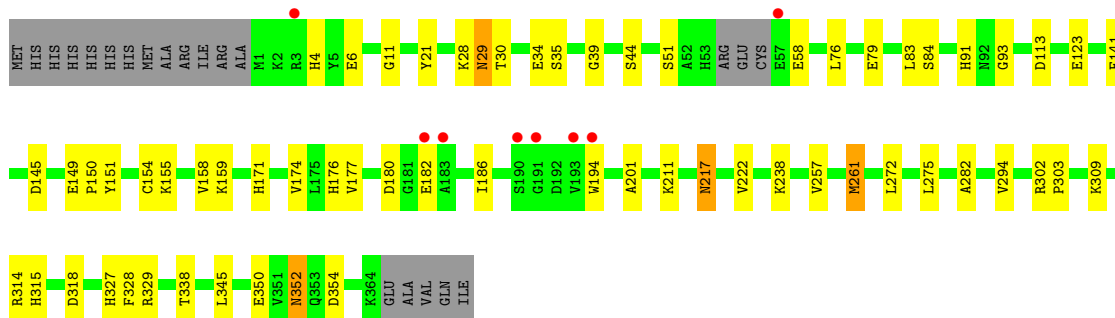

4 Data and refinement statistics

Property	Value	Source
Space group	C 2 2 21	Depositor
Cell constants a, b, c, α , β , γ	72.34Å 215.06Å 217.08Å 90.00° 90.00° 90.00°	Depositor
Resolution (Å)	76.25 – 2.60 68.57 – 2.60	Depositor EDS
% Data completeness (in resolution range)	98.8 (76.25-2.60) 98.7 (68.57-2.60)	Depositor EDS
R_{merge}	0.09	Depositor
R_{sym}	(Not available)	Depositor
$\langle I/\sigma(I) \rangle$ ¹	7.13 (at 2.62Å)	Xtrriage
Refinement program	REFMAC 5.2.0019	Depositor
R, R_{free}	0.196 , 0.257 0.195 , 0.255	Depositor DCC
R_{free} test set	2639 reflections (5.09%)	wwPDB-VP
Wilson B-factor (Å ²)	31.0	Xtrriage
Anisotropy	0.340	Xtrriage
Bulk solvent k_{sol} (e/Å ³), B_{sol} (Å ²)	0.34 , 34.2	EDS
L-test for twinning ²	$\langle L \rangle = 0.48$, $\langle L^2 \rangle = 0.31$	Xtrriage
Estimated twinning fraction	No twinning to report.	Xtrriage
F_o, F_c correlation	0.93	EDS
Total number of atoms	11739	wwPDB-VP
Average B, all atoms (Å ²)	31.0	wwPDB-VP

Xtrriage's analysis on translational NCS is as follows: *The largest off-origin peak in the Patterson function is 12.52% of the height of the origin peak. No significant pseudotranslation is detected.*

¹Intensities estimated from amplitudes.

²Theoretical values of $\langle |L| \rangle$, $\langle L^2 \rangle$ for acentric reflections are 0.5, 0.333 respectively for untwinned datasets, and 0.375, 0.2 for perfectly twinned datasets.

5 Model quality [i](#)

5.1 Standard geometry [i](#)

Bond lengths and bond angles in the following residue types are not validated in this section: GOA, FAD

The Z score for a bond length (or angle) is the number of standard deviations the observed value is removed from the expected value. A bond length (or angle) with $|Z| > 5$ is considered an outlier worth inspection. RMSZ is the root-mean-square of all Z scores of the bond lengths (or angles).

Mol	Chain	Bond lengths		Bond angles	
		RMSZ	# Z >5	RMSZ	# Z >5
1	A	0.57	1/2927 (0.0%)	0.65	2/3952 (0.1%)
1	B	0.51	0/2920	0.60	0/3941
1	C	0.51	1/2891 (0.0%)	0.60	0/3903
1	D	0.47	0/2889	0.58	0/3901
All	All	0.52	2/11627 (0.0%)	0.61	2/15697 (0.0%)

All (2) bond length outliers are listed below:

Mol	Chain	Res	Type	Atoms	Z	Observed(Å)	Ideal(Å)
1	A	74	LYS	CD-CE	-14.69	1.14	1.51
1	C	143	GLN	CB-CG	-6.12	1.36	1.52

All (2) bond angle outliers are listed below:

Mol	Chain	Res	Type	Atoms	Z	Observed(°)	Ideal(°)
1	A	74	LYS	CG-CD-CE	11.07	145.11	111.90
1	A	74	LYS	CD-CE-NZ	8.61	131.51	111.70

There are no chirality outliers.

There are no planarity outliers.

5.2 Too-close contacts [i](#)

In the following table, the Non-H and H(model) columns list the number of non-hydrogen atoms and hydrogen atoms in the chain respectively. The H(added) column lists the number of hydrogen atoms added and optimized by MolProbity. The Clashes column lists the number of clashes within the asymmetric unit, whereas Symm-Clashes lists symmetry-related clashes.

Mol	Chain	Non-H	H(model)	H(added)	Clashes	Symm-Clashes
1	A	2855	0	2816	54	0
1	B	2852	0	2809	50	0
1	C	2823	0	2785	34	0
1	D	2821	0	2778	43	0
2	A	5	0	0	1	0
2	B	5	0	0	3	0
2	C	5	0	0	2	0
2	D	5	0	0	1	0
3	A	53	0	31	2	0
3	B	53	0	31	12	0
3	C	53	0	31	8	0
3	D	53	0	31	5	0
4	A	41	0	0	4	0
4	B	46	0	0	4	0
4	C	47	0	0	6	0
4	D	22	0	0	4	0
All	All	11739	0	11312	180	0

The all-atom clashscore is defined as the number of clashes found per 1000 atoms (including hydrogen atoms). The all-atom clashscore for this structure is 8.

All (180) close contacts within the same asymmetric unit are listed below, sorted by their clash magnitude.

Atom-1	Atom-2	Interatomic distance (Å)	Clash overlap (Å)
1:B:49:MET:N	3:B:371:FAD:HM73	1.74	1.02
1:B:49:MET:H	3:B:371:FAD:HM73	1.23	0.99
1:C:302:ARG:HE	2:C:370:GOA:CA	1.76	0.97
1:A:178:GLU:HA	1:A:179:ARG:CB	1.96	0.96
1:A:302:ARG:HE	2:A:370:GOA:CA	1.77	0.96
1:B:49:MET:O	3:B:371:FAD:HM71	1.69	0.90
1:A:178:GLU:HA	1:A:179:ARG:HB2	1.52	0.89
1:A:91:HIS:HD2	1:A:93:GLY:H	1.23	0.87
3:C:371:FAD:H2A	4:C:390:HOH:O	1.74	0.86
1:A:54[B]:ARG:HG2	1:A:97:LYS:NZ	1.92	0.85
1:D:352:ASN:HD21	1:D:354:ASP:HB2	1.42	0.82
1:A:54[B]:ARG:HG2	1:A:97:LYS:HZ3	1.46	0.80
1:D:222:VAL:HG11	1:D:261:MET:HE3	1.65	0.79
1:B:302:ARG:HE	2:B:370:GOA:CA	2.00	0.75
1:D:176:HIS:CD2	4:D:383:HOH:O	2.38	0.75
1:B:49:MET:N	3:B:371:FAD:C7M	2.50	0.75
1:D:35:SER:O	1:D:171:HIS:HA	1.87	0.74
1:D:34:GLU:HA	3:D:371:FAD:H8A	1.71	0.73

Continued on next page...

Continued from previous page...

Atom-1	Atom-2	Interatomic distance (Å)	Clash overlap (Å)
1:C:174:VAL:H	3:C:371:FAD:H61A	1.36	0.72
1:D:91:HIS:HD2	1:D:93:GLY:H	1.38	0.72
1:A:91:HIS:CD2	1:A:93:GLY:H	2.07	0.70
1:C:217:ASN:HD22	1:C:217:ASN:H	1.38	0.69
1:A:54[B]:ARG:NH2	1:A:95:MET:HE1	2.06	0.69
1:A:122:LYS:HD2	1:A:136:ILE:O	1.93	0.69
1:A:54[B]:ARG:HH21	1:A:95:MET:HE1	1.57	0.68
1:D:174:VAL:H	3:D:371:FAD:H61A	1.42	0.68
1:C:279:MET:HG2	1:D:272:LEU:HG	1.75	0.67
1:D:327:HIS:HE1	1:D:338:THR:OG1	1.79	0.66
1:A:178:GLU:HA	1:A:179:ARG:HB3	1.77	0.65
1:B:222:VAL:HG11	1:B:261:MET:HE1	1.80	0.64
1:B:94:GLY:HA2	4:B:388:HOH:O	1.98	0.64
1:C:180:ASP:OD1	4:C:376:HOH:O	2.15	0.64
1:D:176:HIS:HD2	4:D:383:HOH:O	1.74	0.63
1:A:54[B]:ARG:HA	1:A:56:CYS:H	1.63	0.63
1:B:49:MET:HB2	3:B:371:FAD:HM72	1.79	0.62
3:C:371:FAD:C2A	4:C:390:HOH:O	2.37	0.62
1:B:41:ARG:NH1	1:B:268:GLU:OE2	2.35	0.59
1:A:217:ASN:HD22	1:A:217:ASN:H	1.49	0.59
1:A:62:PHE:HZ	1:A:330:ASN:HD21	1.50	0.58
1:B:53:HIS:O	1:B:97:LYS:HE3	2.04	0.58
1:C:34:GLU:HA	3:C:371:FAD:H8A	1.85	0.58
1:A:54[B]:ARG:HH21	1:A:95:MET:CE	2.17	0.57
3:B:371:FAD:O4'	3:B:371:FAD:O2'	1.98	0.57
1:A:57:GLU:HA	4:A:403:HOH:O	2.04	0.57
1:A:54[A]:ARG:HA	1:A:56:CYS:H	1.66	0.57
1:A:352:ASN:C	1:A:352:ASN:HD22	2.08	0.57
1:B:352:ASN:HD21	1:B:354:ASP:HB2	1.68	0.57
1:B:49:MET:H	3:B:371:FAD:C7M	2.08	0.56
1:D:177:VAL:HG22	1:D:186:ILE:HG22	1.87	0.56
1:B:181:GLY:HA3	1:C:180:ASP:CG	2.26	0.55
1:A:19:ILE:HD13	1:A:199:VAL:HG11	1.88	0.55
1:C:208:MET:CE	4:C:390:HOH:O	2.54	0.55
1:B:55:GLU:HA	1:B:57:GLU:HA	1.89	0.55
1:B:49:MET:HB2	3:B:371:FAD:C7M	2.36	0.55
1:B:112:ASP:O	4:B:384:HOH:O	2.18	0.55
1:C:34:GLU:OE1	3:C:371:FAD:H1B	2.07	0.55
1:A:54[B]:ARG:HG2	1:A:97:LYS:HZ1	1.71	0.54
1:A:84:SER:HB2	1:A:159:LYS:HB3	1.88	0.54
1:A:144:ASP:HB2	4:A:399:HOH:O	2.07	0.54

Continued on next page...

Continued from previous page...

Atom-1	Atom-2	Interatomic distance (Å)	Clash overlap (Å)
1:A:178:GLU:CA	1:A:179:ARG:CB	2.78	0.54
1:D:217:ASN:H	1:D:217:ASN:HD22	1.56	0.53
1:C:294:VAL:HG21	1:D:275:LEU:HD12	1.89	0.53
1:C:84:SER:HB2	1:C:159:LYS:HB3	1.90	0.53
1:D:6:GLU:HG3	1:D:29:ASN:HD22	1.74	0.53
1:C:96:PHE:CE1	1:C:238:LYS:HD3	2.43	0.53
1:C:91:HIS:O	1:C:146:VAL:HB	2.09	0.53
1:B:91:HIS:HD2	1:B:93:GLY:H	1.55	0.53
1:A:96:PHE:CE1	1:A:238:LYS:HD3	2.44	0.52
1:C:352:ASN:HD21	1:C:354:ASP:HB2	1.73	0.52
1:A:91:HIS:HD2	1:A:93:GLY:N	2.00	0.52
1:D:11:GLY:HA3	1:D:201:ALA:O	2.10	0.52
1:A:35:SER:O	1:A:171:HIS:HA	2.09	0.51
1:D:141:PHE:CE1	1:D:238:LYS:HE3	2.45	0.51
1:D:154:CYS:O	1:D:158:VAL:HG23	2.11	0.51
1:B:246:TYR:CE2	2:B:370:GOA:O	2.64	0.51
1:C:42:THR:HG22	3:C:371:FAD:O2'	2.10	0.51
1:D:84:SER:HB2	1:D:159:LYS:HB3	1.92	0.51
1:A:352:ASN:HB3	1:A:355:TRP:CE3	2.46	0.50
1:D:91:HIS:CD2	1:D:93:GLY:H	2.24	0.50
1:B:246:TYR:HE2	2:B:370:GOA:O	1.94	0.50
1:D:303:PRO:HG2	1:D:327:HIS:O	2.12	0.50
1:B:97:LYS:HD2	1:B:142:ILE:CD1	2.42	0.49
1:B:239:THR:HG23	1:B:248:VAL:HG22	1.93	0.49
1:A:116:SER:HB2	4:A:399:HOH:O	2.12	0.49
1:A:222:VAL:HG11	1:A:261:MET:HE1	1.95	0.49
1:C:51:SER:HB2	1:C:145:ASP:OD2	2.13	0.49
1:A:328:PHE:CD2	1:A:329:ARG:HG3	2.49	0.48
1:B:105:VAL:O	1:B:109:ARG:HG3	2.14	0.48
1:B:54[B]:ARG:NH2	1:B:330:ASN:HB3	2.29	0.48
1:B:184:LEU:HD23	1:B:198:VAL:HG23	1.95	0.47
1:D:217:ASN:HD22	1:D:217:ASN:N	2.12	0.47
1:B:88:ILE:HB	1:B:153:VAL:HG22	1.95	0.47
1:A:91:HIS:CD2	1:A:93:GLY:N	2.81	0.47
1:A:179:ARG:HD2	1:A:213:LEU:CD2	2.44	0.47
1:A:269:THR:CG2	1:A:270:PRO:HD2	2.45	0.47
1:D:123:GLU:H	1:D:123:GLU:CD	2.18	0.47
1:B:222:VAL:HG11	1:B:261:MET:CE	2.43	0.47
1:A:117:VAL:O	4:A:417:HOH:O	2.20	0.46
1:B:332:ILE:HB	3:B:371:FAD:HM83	1.97	0.46
1:C:275:LEU:HD12	1:D:294:VAL:HG21	1.97	0.46

Continued on next page...

Continued from previous page...

Atom-1	Atom-2	Interatomic distance (Å)	Clash overlap (Å)
1:B:107:GLN:HA	1:B:110:GLN:NE2	2.30	0.46
3:B:371:FAD:H1'2	3:B:371:FAD:H9	1.26	0.46
1:C:217:ASN:HD22	1:C:217:ASN:N	2.11	0.46
1:B:155:LYS:HE2	4:B:415:HOH:O	2.16	0.46
1:D:257:VAL:HG11	1:D:282:ALA:HB2	1.96	0.46
1:D:51:SER:HB2	4:D:387:HOH:O	2.15	0.46
1:A:335:ALA:HB3	1:A:336:PRO:HD3	1.98	0.46
1:C:330:ASN:HA	3:C:371:FAD:O2	2.15	0.46
1:C:302:ARG:NE	2:C:370:GOA:CA	2.60	0.46
1:A:184:LEU:HD21	1:A:321:ILE:HD11	1.97	0.45
1:C:315:HIS:HB3	1:C:318:ASP:O	2.16	0.45
1:A:58:GLU:HA	1:A:58:GLU:OE2	2.16	0.45
1:C:122:LYS:HG3	1:C:136:ILE:HG13	1.97	0.45
1:C:217:ASN:H	1:C:217:ASN:ND2	2.11	0.45
1:C:352:ASN:C	1:C:352:ASN:HD22	2.20	0.45
1:D:39:GLY:O	1:D:44:SER:OG	2.26	0.45
1:B:91:HIS:CD2	1:B:93:GLY:H	2.33	0.45
1:C:88:ILE:HG22	1:C:153:VAL:HA	1.98	0.45
1:A:97:LYS:HB2	1:A:140:SER:HB2	1.99	0.45
1:C:129:GLU:OE1	1:C:236:LEU:HA	2.17	0.45
1:B:186:ILE:CD1	1:B:193:VAL:HB	2.47	0.45
1:D:352:ASN:HD22	1:D:352:ASN:C	2.20	0.45
1:D:352:ASN:ND2	1:D:354:ASP:H	2.15	0.44
1:B:53:HIS:HB2	1:B:142:ILE:HD13	1.99	0.44
3:D:371:FAD:H9	3:D:371:FAD:H1'1	1.73	0.44
1:D:34:GLU:OE2	3:D:371:FAD:O2B	2.35	0.44
1:D:4:HIS:HB2	1:D:194:TRP:HB2	2.00	0.44
1:A:221:PRO:HG3	1:A:266:TRP:CE2	2.53	0.44
1:B:328:PHE:CD2	1:B:329:ARG:HG3	2.53	0.44
1:D:4:HIS:HD2	1:D:194:TRP:CB	2.31	0.44
1:C:328:PHE:CD2	1:C:329:ARG:HG3	2.52	0.44
1:B:251:LYS:HB3	1:B:251:LYS:HE2	1.79	0.43
1:A:223:LYS:HE3	1:A:267:SER:O	2.18	0.43
1:A:241:TYR:OH	1:A:244:ALA:HA	2.17	0.43
1:C:205:TRP:HB3	4:C:390:HOH:O	2.18	0.43
1:C:76:LEU:HD11	1:C:157:TYR:OH	2.18	0.43
1:D:51:SER:HA	1:D:145:ASP:CG	2.39	0.43
1:A:208:MET:HG3	1:B:175:LEU:HD13	1.99	0.43
1:B:5:TYR:O	1:B:195:ALA:HA	2.19	0.43
1:B:76:LEU:HD22	1:B:80:LEU:HG	2.00	0.43
1:D:34:GLU:OE1	3:D:371:FAD:H1B	2.19	0.43

Continued on next page...

Continued from previous page...

Atom-1	Atom-2	Interatomic distance (Å)	Clash overlap (Å)
1:B:149:GLU:HA	1:B:150:PRO:HD3	1.84	0.42
1:D:28:LYS:O	1:D:30:THR:OG1	2.36	0.42
1:D:302:ARG:HE	2:D:370:GOA:CA	2.32	0.42
1:B:352:ASN:ND2	1:B:354:ASP:H	2.18	0.42
1:D:328:PHE:HB3	4:D:385:HOH:O	2.18	0.42
1:A:76:LEU:HD22	1:A:80:LEU:HG	2.02	0.42
1:A:210:PHE:CD2	1:A:217:ASN:HB2	2.54	0.42
1:B:54[B]:ARG:HH22	1:B:330:ASN:HB3	1.84	0.42
1:B:179:ARG:HD2	4:B:394:HOH:O	2.20	0.42
1:C:306:LYS:HD3	4:C:403:HOH:O	2.19	0.42
1:D:315:HIS:HB3	1:D:318:ASP:O	2.20	0.42
1:D:328:PHE:CD2	1:D:329:ARG:HG3	2.54	0.42
1:C:330:ASN:HA	3:C:371:FAD:C2	2.49	0.42
1:A:352:ASN:ND2	1:A:355:TRP:H	2.18	0.42
1:B:210:PHE:CZ	1:B:323:PHE:CD2	3.08	0.42
1:B:34:GLU:OE2	3:B:371:FAD:O2B	2.35	0.41
1:B:352:ASN:C	1:B:352:ASN:HD22	2.23	0.41
1:A:88:ILE:HG22	1:A:153:VAL:HA	2.01	0.41
1:A:226:CYS:SG	3:A:371:FAD:HM72	2.60	0.41
1:C:327:HIS:O	1:C:328:PHE:C	2.59	0.41
1:A:217:ASN:HD22	1:A:217:ASN:N	2.15	0.41
1:B:97:LYS:HD2	1:B:142:ILE:HD12	2.03	0.41
1:A:38:MET:HG2	1:A:170:GLU:OE2	2.20	0.41
1:B:49:MET:CA	3:B:371:FAD:C7M	2.98	0.41
1:C:76:LEU:HD22	1:C:80:LEU:HG	2.02	0.41
1:D:21:TYR:OH	1:D:79:GLU:OE1	2.35	0.41
1:A:155:LYS:HA	1:A:158:VAL:HG12	2.01	0.41
1:B:101:SER:O	1:B:105:VAL:HG23	2.20	0.41
1:A:352:ASN:HD21	1:A:354:ASP:HB2	1.85	0.41
1:D:151:TYR:O	1:D:155:LYS:HG2	2.21	0.41
1:D:314:ARG:NH2	1:D:345:LEU:O	2.54	0.41
1:D:327:HIS:CD2	1:D:327:HIS:H	2.39	0.41
1:A:269:THR:HG23	1:A:270:PRO:HD2	2.02	0.40
1:A:330:ASN:HA	3:A:371:FAD:O2	2.22	0.40
1:B:101:SER:O	1:B:104:ASP:HB2	2.22	0.40
1:B:2:LYS:O	1:C:3:ARG:NH2	2.54	0.40
1:B:60:ASP:HB2	1:B:61:ALA:H	1.75	0.40
1:A:352:ASN:C	1:A:352:ASN:ND2	2.73	0.40
1:D:149:GLU:HA	1:D:150:PRO:HD3	1.81	0.40

There are no symmetry-related clashes.

5.3 Torsion angles [i](#)

5.3.1 Protein backbone [i](#)

In the following table, the Percentiles column shows the percent Ramachandran outliers of the chain as a percentile score with respect to all X-ray entries followed by that with respect to entries of similar resolution.

The Analysed column shows the number of residues for which the backbone conformation was analysed, and the total number of residues.

Mol	Chain	Analysed	Favoured	Allowed	Outliers	Percentiles	
1	A	363/382 (95%)	343 (94%)	18 (5%)	2 (1%)	25	47
1	B	360/382 (94%)	341 (95%)	18 (5%)	1 (0%)	41	64
1	C	357/382 (94%)	338 (95%)	18 (5%)	1 (0%)	41	64
1	D	357/382 (94%)	335 (94%)	22 (6%)	0	100	100
All	All	1437/1528 (94%)	1357 (94%)	76 (5%)	4 (0%)	41	64

All (4) Ramachandran outliers are listed below:

Mol	Chain	Res	Type
1	A	328	PHE
1	C	328	PHE
1	A	179	ARG
1	B	328	PHE

5.3.2 Protein sidechains [i](#)

In the following table, the Percentiles column shows the percent sidechain outliers of the chain as a percentile score with respect to all X-ray entries followed by that with respect to entries of similar resolution.

The Analysed column shows the number of residues for which the sidechain conformation was analysed, and the total number of residues.

Mol	Chain	Analysed	Rotameric	Outliers	Percentiles	
1	A	297/311 (96%)	287 (97%)	10 (3%)	37	63
1	B	296/311 (95%)	288 (97%)	8 (3%)	44	71
1	C	293/311 (94%)	279 (95%)	14 (5%)	25	49
1	D	293/311 (94%)	280 (96%)	13 (4%)	28	53
All	All	1179/1244 (95%)	1134 (96%)	45 (4%)	33	59

All (45) residues with a non-rotameric sidechain are listed below:

Mol	Chain	Res	Type
1	A	57	GLU
1	A	59	ARG
1	A	76	LEU
1	A	106	LEU
1	A	140	SER
1	A	157	TYR
1	A	261	MET
1	A	319	SER
1	A	350	GLU
1	A	352	ASN
1	B	76	LEU
1	B	107	GLN
1	B	184	LEU
1	B	186	ILE
1	B	216	ASN
1	B	251	LYS
1	B	262	LYS
1	B	352	ASN
1	C	3	ARG
1	C	29	ASN
1	C	35	SER
1	C	44	SER
1	C	76	LEU
1	C	118	SER
1	C	123	GLU
1	C	144	ASP
1	C	182	GLU
1	C	184	LEU
1	C	217	ASN
1	C	296	ARG
1	C	350	GLU
1	C	352	ASN
1	D	29	ASN
1	D	58	GLU
1	D	76	LEU
1	D	83	LEU
1	D	113	ASP
1	D	180	ASP
1	D	182	GLU
1	D	211	LYS
1	D	217	ASN
1	D	261	MET

Continued on next page...

Continued from previous page...

Mol	Chain	Res	Type
1	D	309	LYS
1	D	350	GLU
1	D	352	ASN

Sometimes sidechains can be flipped to improve hydrogen bonding and reduce clashes. All (23) such sidechains are listed below:

Mol	Chain	Res	Type
1	A	91	HIS
1	A	197	HIS
1	A	217	ASN
1	A	327	HIS
1	A	352	ASN
1	B	91	HIS
1	B	110	GLN
1	B	176	HIS
1	B	197	HIS
1	B	216	ASN
1	B	217	ASN
1	B	352	ASN
1	C	91	HIS
1	C	176	HIS
1	C	217	ASN
1	C	352	ASN
1	D	4	HIS
1	D	29	ASN
1	D	70	GLN
1	D	91	HIS
1	D	217	ASN
1	D	327	HIS
1	D	352	ASN

5.3.3 RNA [i](#)

There are no RNA molecules in this entry.

5.4 Non-standard residues in protein, DNA, RNA chains [i](#)

There are no non-standard protein/DNA/RNA residues in this entry.

5.5 Carbohydrates [i](#)

There are no monosaccharides in this entry.

5.6 Ligand geometry [i](#)

8 ligands are modelled in this entry.

In the following table, the Counts columns list the number of bonds (or angles) for which Mogul statistics could be retrieved, the number of bonds (or angles) that are observed in the model and the number of bonds (or angles) that are defined in the Chemical Component Dictionary. The Link column lists molecule types, if any, to which the group is linked. The Z score for a bond length (or angle) is the number of standard deviations the observed value is removed from the expected value. A bond length (or angle) with $|Z| > 2$ is considered an outlier worth inspection. RMSZ is the root-mean-square of all Z scores of the bond lengths (or angles).

Mol	Type	Chain	Res	Link	Bond lengths			Bond angles		
					Counts	RMSZ	# Z > 2	Counts	RMSZ	# Z > 2
2	GOA	D	370	-	4,4,4	2.89	2 (50%)	4,4,4	1.14	0
3	FAD	D	371	-	53,58,58	0.96	3 (5%)	68,89,89	1.35	9 (13%)
2	GOA	C	370	-	4,4,4	3.07	2 (50%)	4,4,4	1.81	2 (50%)
2	GOA	B	370	-	4,4,4	3.12	2 (50%)	4,4,4	1.76	2 (50%)
2	GOA	A	370	-	4,4,4	3.14	2 (50%)	4,4,4	1.64	1 (25%)
3	FAD	A	371	-	53,58,58	1.09	4 (7%)	68,89,89	1.51	10 (14%)
3	FAD	C	371	-	53,58,58	1.20	5 (9%)	68,89,89	1.77	16 (23%)
3	FAD	B	371	-	53,58,58	1.32	7 (13%)	68,89,89	2.17	22 (32%)

In the following table, the Chirals column lists the number of chiral outliers, the number of chiral centers analysed, the number of these observed in the model and the number defined in the Chemical Component Dictionary. Similar counts are reported in the Torsion and Rings columns. '-' means no outliers of that kind were identified.

Mol	Type	Chain	Res	Link	Chirals	Torsions	Rings
2	GOA	D	370	-	-	0/2/2/2	-
3	FAD	D	371	-	-	2/30/50/50	0/6/6/6
2	GOA	C	370	-	-	0/2/2/2	-
2	GOA	B	370	-	-	0/2/2/2	-
2	GOA	A	370	-	-	0/2/2/2	-
3	FAD	A	371	-	-	1/30/50/50	0/6/6/6
3	FAD	C	371	-	-	8/30/50/50	0/6/6/6
3	FAD	B	371	-	-	6/30/50/50	0/6/6/6

All (27) bond length outliers are listed below:

Mol	Chain	Res	Type	Atoms	Z	Observed(Å)	Ideal(Å)
2	A	370	GOA	CA-C	-5.44	1.32	1.51
2	B	370	GOA	CA-C	-5.33	1.32	1.51
2	C	370	GOA	CA-C	-5.27	1.32	1.51
2	D	370	GOA	CA-C	-4.97	1.34	1.51
3	B	371	FAD	C9A-N10	-4.75	1.32	1.41
3	C	371	FAD	C4X-N5	3.10	1.36	1.30
2	B	370	GOA	O2-CA	-2.89	1.31	1.41
3	D	371	FAD	C9A-N10	-2.87	1.36	1.41
3	C	371	FAD	C5'-C4'	2.82	1.55	1.51
2	A	370	GOA	O2-CA	-2.80	1.32	1.41
3	B	371	FAD	C5X-N5	-2.79	1.34	1.39
2	C	370	GOA	O2-CA	-2.78	1.32	1.41
3	D	371	FAD	C4X-N5	2.68	1.36	1.30
3	C	371	FAD	C5X-N5	-2.61	1.34	1.39
3	A	371	FAD	C10-N1	2.61	1.38	1.33
3	A	371	FAD	C9A-N10	-2.52	1.36	1.41
3	B	371	FAD	C6-C7	-2.41	1.36	1.39
3	B	371	FAD	C2A-N3A	2.37	1.35	1.32
3	B	371	FAD	C7M-C7	-2.36	1.46	1.51
2	D	370	GOA	O2-CA	-2.32	1.33	1.41
3	A	371	FAD	O4-C4	2.27	1.27	1.23
3	C	371	FAD	C1'-C2'	2.26	1.55	1.52
3	D	371	FAD	O4B-C1B	2.25	1.44	1.41
3	B	371	FAD	C4-N3	-2.25	1.34	1.38
3	C	371	FAD	C4A-N3A	-2.13	1.32	1.35
3	A	371	FAD	C4X-N5	2.03	1.34	1.30
3	B	371	FAD	C4X-C4	-2.01	1.37	1.44

All (62) bond angle outliers are listed below:

Mol	Chain	Res	Type	Atoms	Z	Observed(°)	Ideal(°)
3	B	371	FAD	C1'-N10-C9A	-6.55	109.58	120.51
3	C	371	FAD	C1'-C2'-C3'	5.97	126.47	109.79
3	B	371	FAD	C5'-C4'-C3'	5.62	123.06	112.20
3	B	371	FAD	N3A-C2A-N1A	-4.85	121.09	128.68
3	B	371	FAD	C7M-C7-C6	-4.72	110.76	119.49
3	A	371	FAD	N3A-C2A-N1A	-4.49	121.66	128.68
3	B	371	FAD	C4'-C3'-C2'	-3.90	105.26	113.36
3	D	371	FAD	N3A-C2A-N1A	-3.76	122.80	128.68
3	C	371	FAD	N3A-C2A-N1A	-3.67	122.95	128.68
3	A	371	FAD	C4X-C4-N3	3.65	122.45	113.19
3	B	371	FAD	O4'-C4'-C5'	-3.60	101.83	109.92

Continued on next page...

Continued from previous page...

Mol	Chain	Res	Type	Atoms	Z	Observed(°)	Ideal(°)
3	C	371	FAD	O5'-C5'-C4'	3.59	118.94	109.36
3	B	371	FAD	C4X-C10-N1	-3.58	116.42	124.73
3	C	371	FAD	C4-N3-C2	-3.47	119.24	125.64
3	B	371	FAD	C9-C9A-N10	-3.44	117.19	121.84
3	C	371	FAD	C4X-C10-N10	3.33	121.35	116.48
3	C	371	FAD	O4B-C1B-C2B	-3.31	102.09	106.93
3	A	371	FAD	C4-N3-C2	-3.25	119.63	125.64
3	B	371	FAD	C5X-C9A-N10	3.23	121.29	117.95
3	A	371	FAD	C4-C4X-N5	3.22	122.82	118.23
3	B	371	FAD	C6-C7-C8	3.14	124.17	119.67
3	A	371	FAD	C4X-C10-N1	-3.12	117.48	124.73
3	D	371	FAD	C4-N3-C2	-3.10	119.91	125.64
3	A	371	FAD	C4X-C10-N10	3.02	120.90	116.48
3	C	371	FAD	C4X-C10-N1	-3.00	117.77	124.73
3	B	371	FAD	C4-N3-C2	-2.99	120.12	125.64
3	A	371	FAD	C10-N1-C2	2.97	122.84	116.90
3	A	371	FAD	O4-C4-N3	-2.94	114.47	120.12
3	B	371	FAD	O3'-C3'-C2'	-2.89	101.83	108.81
3	B	371	FAD	O4-C4-C4X	-2.89	118.94	126.60
3	C	371	FAD	C4X-C4-N3	2.81	120.33	113.19
3	A	371	FAD	C10-C4X-N5	-2.81	118.89	124.86
3	B	371	FAD	C4-C4X-C10	2.79	121.47	116.79
3	C	371	FAD	C5X-C9A-N10	2.77	120.82	117.95
3	B	371	FAD	O3'-C3'-C4'	2.75	115.46	108.81
3	D	371	FAD	C4X-C10-N1	-2.69	118.49	124.73
3	B	371	FAD	C4X-C4-N3	2.68	119.99	113.19
3	C	371	FAD	C3B-C2B-C1B	-2.67	96.96	100.98
3	C	371	FAD	O3'-C3'-C4'	-2.66	102.39	108.81
3	A	371	FAD	C1'-N10-C9A	2.62	124.88	120.51
3	D	371	FAD	C4X-C10-N10	2.53	120.18	116.48
2	C	370	GOA	O2-CA-C	2.47	120.21	113.48
3	D	371	FAD	C4X-C4-N3	2.42	119.33	113.19
3	C	371	FAD	C10-N1-C2	2.40	121.70	116.90
3	D	371	FAD	C10-C4X-N5	-2.36	119.85	124.86
3	B	371	FAD	N10-C10-N1	2.33	125.06	118.35
3	B	371	FAD	C10-N1-C2	2.26	121.42	116.90
3	C	371	FAD	O4-C4-C4X	-2.26	120.61	126.60
2	A	370	GOA	O2-CA-C	2.23	119.56	113.48
3	C	371	FAD	C4'-C3'-C2'	2.23	117.99	113.36
3	D	371	FAD	O4-C4-C4X	-2.20	120.77	126.60
3	D	371	FAD	O4B-C1B-C2B	-2.19	103.73	106.93
3	B	371	FAD	C5X-C6-C7	-2.16	116.75	120.71

Continued on next page...

Continued from previous page...

Mol	Chain	Res	Type	Atoms	Z	Observed(°)	Ideal(°)
2	B	370	GOA	O-C-CA	-2.15	114.39	122.45
3	C	371	FAD	C6-C5X-C9A	2.12	121.94	118.94
2	B	370	GOA	O2-CA-C	2.12	119.25	113.48
3	B	371	FAD	C7M-C7-C8	2.11	125.06	120.74
3	B	371	FAD	C8M-C8-C7	2.10	125.05	120.74
3	D	371	FAD	C9A-C5X-N5	-2.08	120.17	122.43
3	C	371	FAD	C9A-N10-C10	-2.06	117.55	120.77
2	C	370	GOA	O-C-CA	-2.06	114.73	122.45
3	B	371	FAD	C4A-C5A-N7A	-2.00	107.31	109.40

There are no chirality outliers.

All (17) torsion outliers are listed below:

Mol	Chain	Res	Type	Atoms
3	B	371	FAD	C2'-C1'-N10-C10
3	B	371	FAD	O4'-C4'-C5'-O5'
3	C	371	FAD	C1'-C2'-C3'-O3'
3	C	371	FAD	C1'-C2'-C3'-C4'
3	C	371	FAD	O2'-C2'-C3'-O3'
3	C	371	FAD	O2'-C2'-C3'-C4'
3	C	371	FAD	C5'-O5'-P-O1P
3	C	371	FAD	C5'-O5'-P-O2P
3	D	371	FAD	O4B-C4B-C5B-O5B
3	D	371	FAD	C3B-C4B-C5B-O5B
3	B	371	FAD	O3'-C3'-C4'-C5'
3	B	371	FAD	C3'-C4'-C5'-O5'
3	C	371	FAD	C5'-O5'-P-O3P
3	B	371	FAD	O3'-C3'-C4'-O4'
3	C	371	FAD	O4B-C4B-C5B-O5B
3	A	371	FAD	O4B-C4B-C5B-O5B
3	B	371	FAD	O4B-C4B-C5B-O5B

There are no ring outliers.

8 monomers are involved in 34 short contacts:

Mol	Chain	Res	Type	Clashes	Symm-Clashes
2	D	370	GOA	1	0
3	D	371	FAD	5	0
2	C	370	GOA	2	0
2	B	370	GOA	3	0
2	A	370	GOA	1	0

Continued on next page...

Continued from previous page...

Mol	Chain	Res	Type	Clashes	Symm-Clashes
3	A	371	FAD	2	0
3	C	371	FAD	8	0
3	B	371	FAD	12	0

The following is a two-dimensional graphical depiction of Mogul quality analysis of bond lengths, bond angles, torsion angles, and ring geometry for all instances of the Ligand of Interest. In addition, ligands with molecular weight > 250 and outliers as shown on the validation Tables will also be included. For torsion angles, if less than 5% of the Mogul distribution of torsion angles is within 10 degrees of the torsion angle in question, then that torsion angle is considered an outlier. Any bond that is central to one or more torsion angles identified as an outlier by Mogul will be highlighted in the graph. For rings, the root-mean-square deviation (RMSD) between the ring in question and similar rings identified by Mogul is calculated over all ring torsion angles. If the average RMSD is greater than 60 degrees and the minimal RMSD between the ring in question and any Mogul-identified rings is also greater than 60 degrees, then that ring is considered an outlier. The outliers are highlighted in purple. The color gray indicates Mogul did not find sufficient equivalents in the CSD to analyse the geometry.

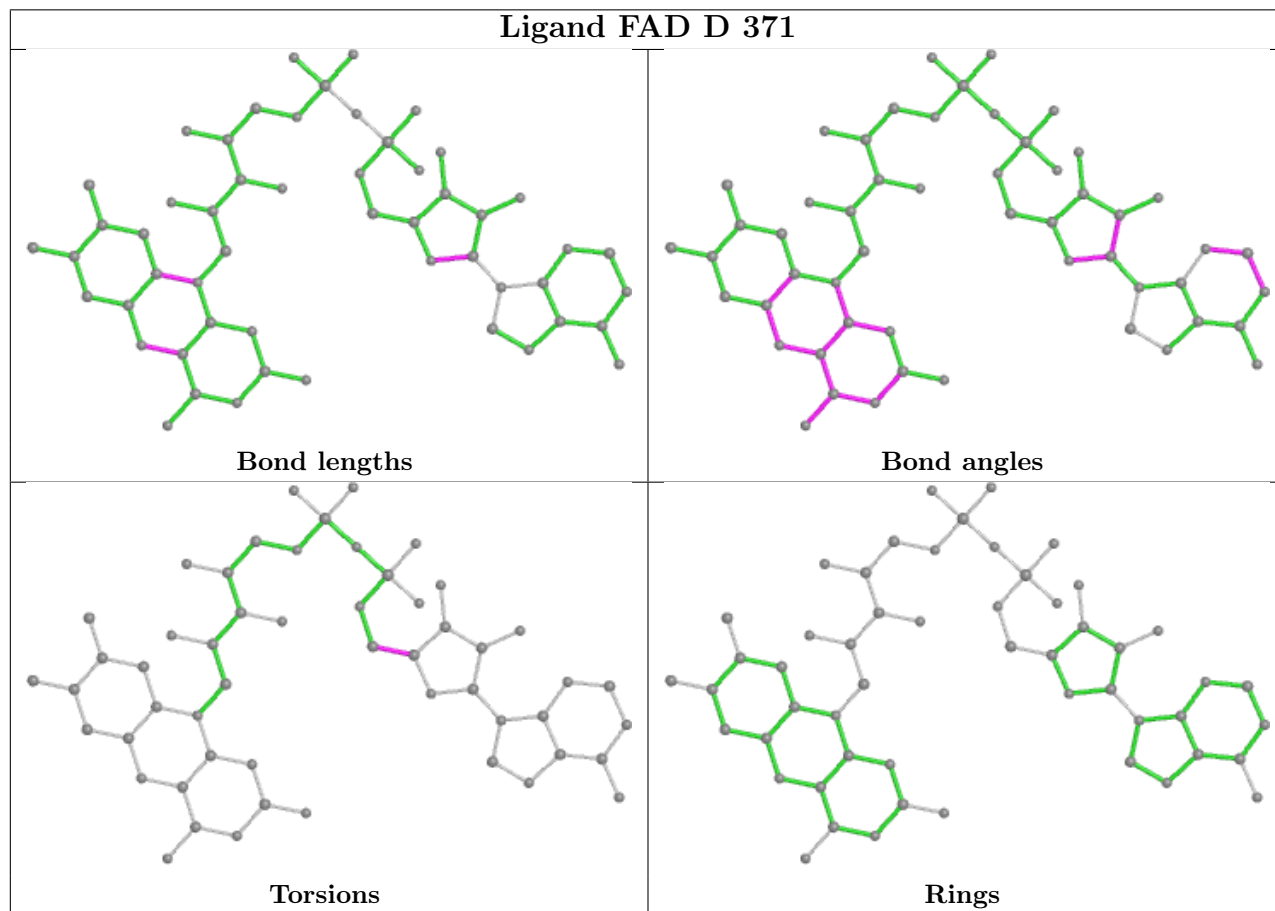

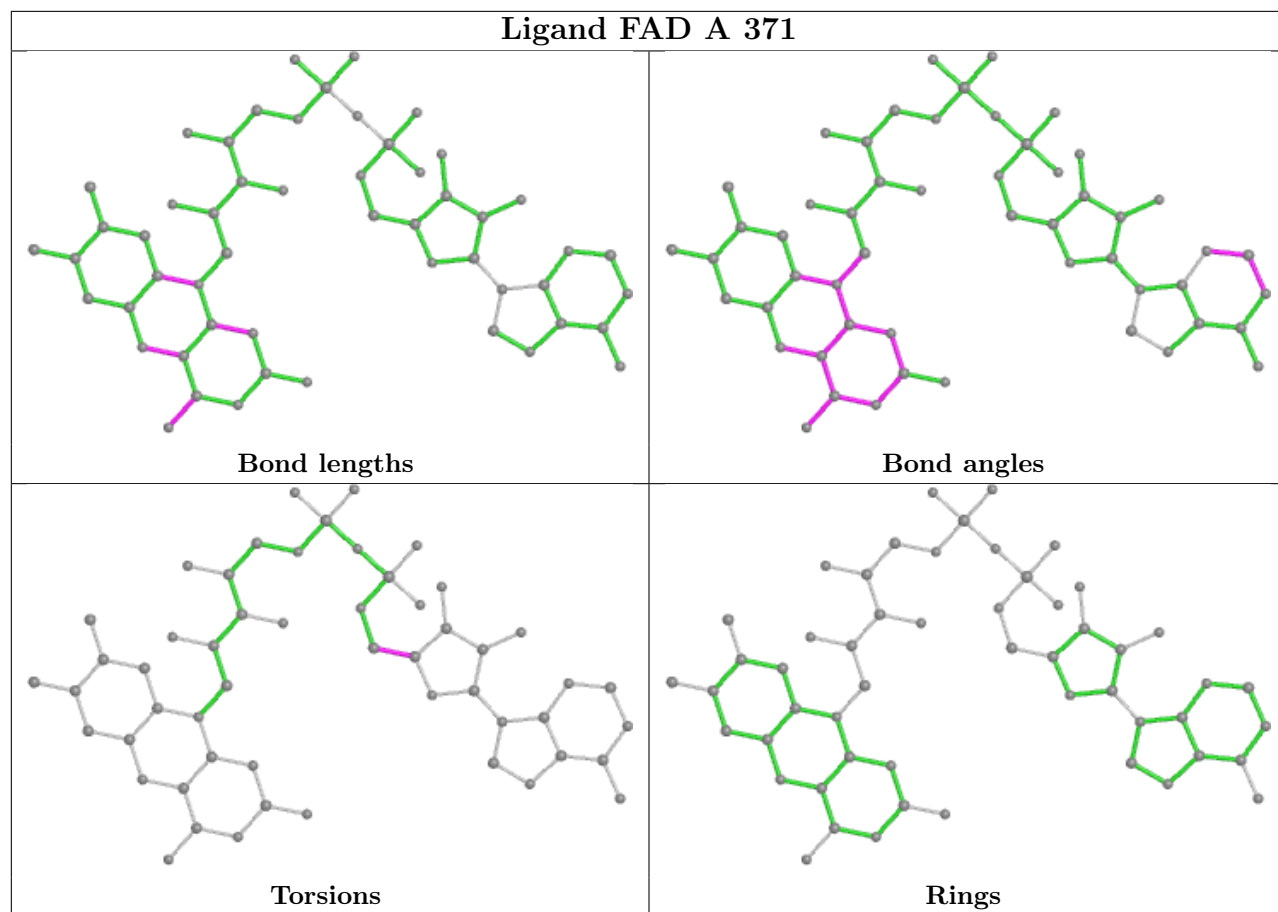

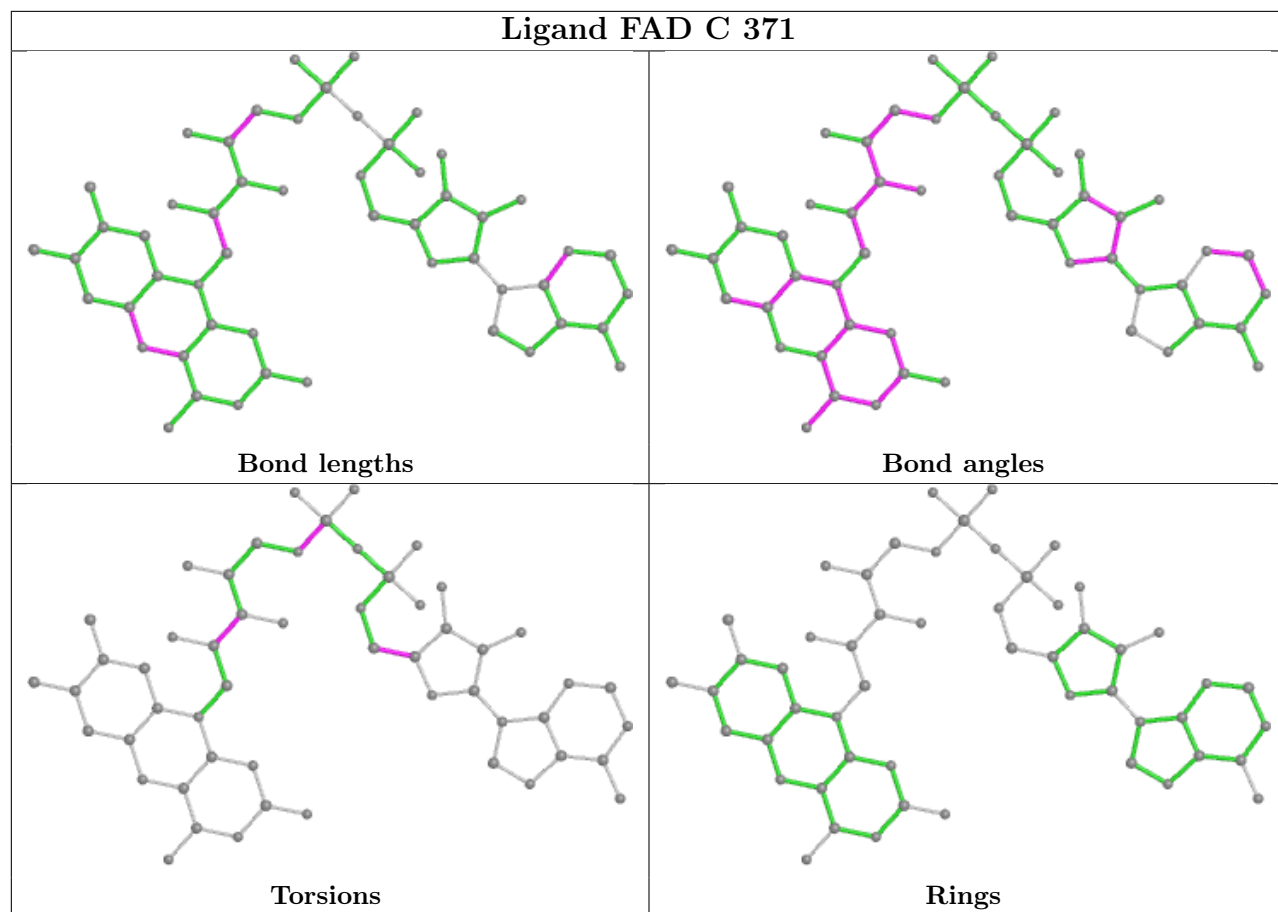

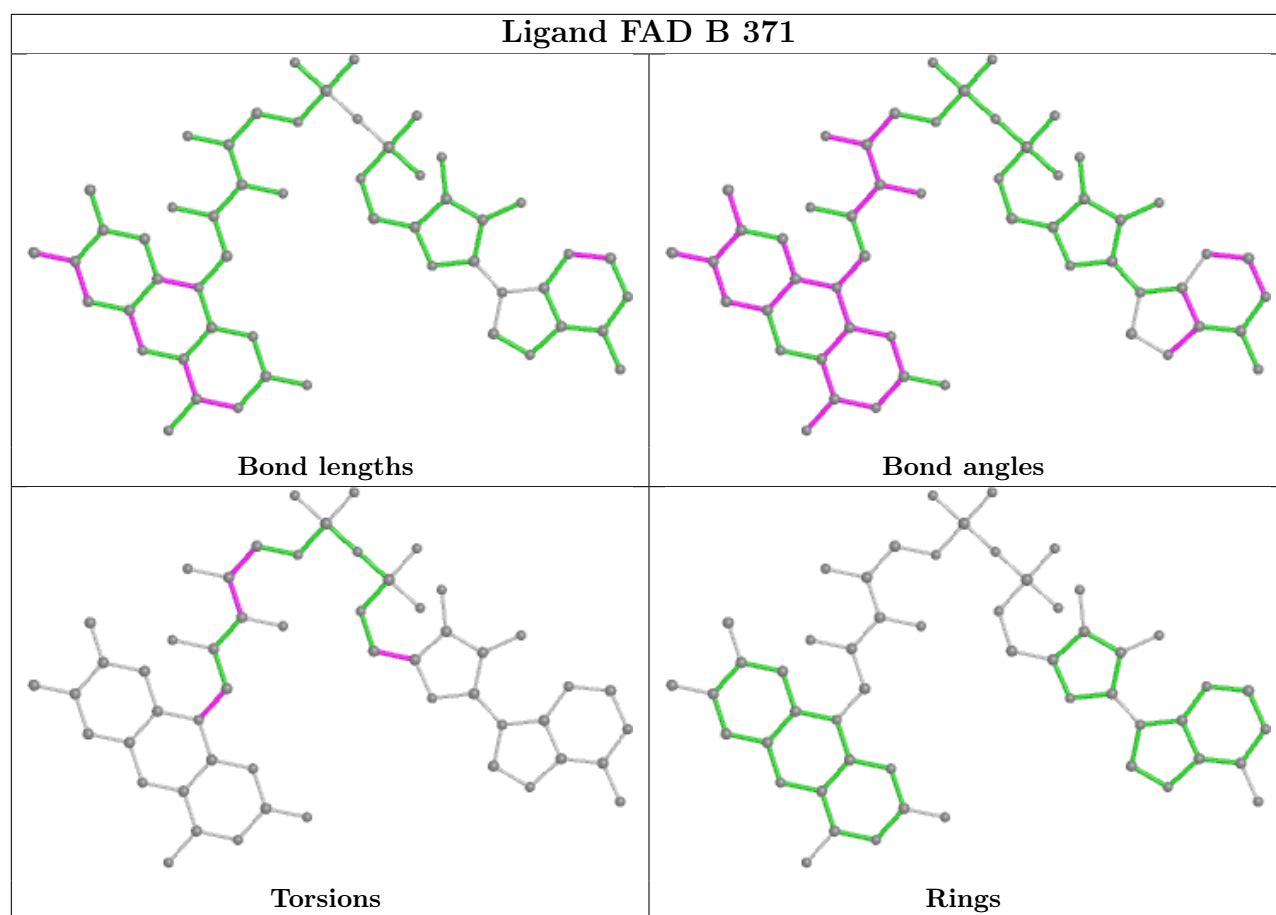

5.7 Other polymers [i](#)

There are no such residues in this entry.

5.8 Polymer linkage issues [i](#)

There are no chain breaks in this entry.

6 Fit of model and data [i](#)

6.1 Protein, DNA and RNA chains [i](#)

In the following table, the column labelled ‘#RSRZ > 2’ contains the number (and percentage) of RSRZ outliers, followed by percent RSRZ outliers for the chain as percentile scores relative to all X-ray entries and entries of similar resolution. The OWAB column contains the minimum, median, 95th percentile and maximum values of the occupancy-weighted average B-factor per residue. The column labelled ‘Q < 0.9’ lists the number of (and percentage) of residues with an average occupancy less than 0.9.

Mol	Chain	Analysed	<RSRZ>	#RSRZ>2	OWAB(Å ²)	Q<0.9
1	A	364/382 (95%)	-0.39	5 (1%) 75 71	14, 25, 49, 65	3 (0%)
1	B	363/382 (95%)	-0.41	2 (0%) 89 88	12, 23, 48, 62	2 (0%)
1	C	361/382 (94%)	-0.41	2 (0%) 89 88	9, 24, 58, 70	2 (0%)
1	D	361/382 (94%)	-0.02	8 (2%) 62 56	19, 39, 68, 77	0
All	All	1449/1528 (94%)	-0.31	17 (1%) 79 76	9, 27, 56, 77	7 (0%)

All (17) RSRZ outliers are listed below:

Mol	Chain	Res	Type	RSRZ
1	A	56	CYS	5.0
1	A	55	GLU	4.7
1	D	194	TRP	4.7
1	D	193	VAL	3.9
1	D	3	ARG	3.6
1	D	183	ALA	3.6
1	A	54[A]	ARG	3.5
1	D	191	GLY	2.9
1	D	190	SER	2.8
1	D	182	GLU	2.7
1	C	102	GLU	2.4
1	B	180	ASP	2.3
1	A	106	LEU	2.3
1	A	57	GLU	2.2
1	D	57	GLU	2.2
1	B	55	GLU	2.1
1	C	139	ALA	2.0

6.2 Non-standard residues in protein, DNA, RNA chains [i](#)

There are no non-standard protein/DNA/RNA residues in this entry.

6.3 Carbohydrates

There are no monosaccharides in this entry.

6.4 Ligands

In the following table, the Atoms column lists the number of modelled atoms in the group and the number defined in the chemical component dictionary. The B-factors column lists the minimum, median, 95th percentile and maximum values of B factors of atoms in the group. The column labelled 'Q< 0.9' lists the number of atoms with occupancy less than 0.9.

Mol	Type	Chain	Res	Atoms	RSCC	RSR	B-factors(Å ²)	Q<0.9
2	GOA	C	370	5/5	0.85	0.26	45,45,46,47	0
2	GOA	B	370	5/5	0.87	0.25	42,43,44,46	0
2	GOA	D	370	5/5	0.93	0.29	51,52,52,53	0
2	GOA	A	370	5/5	0.94	0.24	38,40,41,43	0
3	FAD	D	371	53/53	0.95	0.13	26,31,37,38	0
3	FAD	C	371	53/53	0.96	0.15	9,17,20,20	0
3	FAD	B	371	53/53	0.96	0.15	10,16,27,28	0
3	FAD	A	371	53/53	0.98	0.13	10,16,17,17	0

The following is a graphical depiction of the model fit to experimental electron density of all instances of the Ligand of Interest. In addition, ligands with molecular weight > 250 and outliers as shown on the geometry validation Tables will also be included. Each fit is shown from different orientation to approximate a three-dimensional view.

Electron density around FAD D 371:

$2mF_o-DF_c$ (at 0.7 rmsd) in gray
 mF_o-DF_c (at 3 rmsd) in purple (negative)
and green (positive)

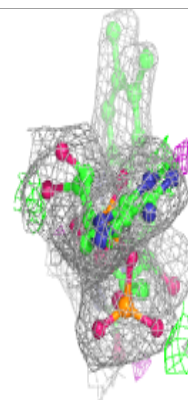
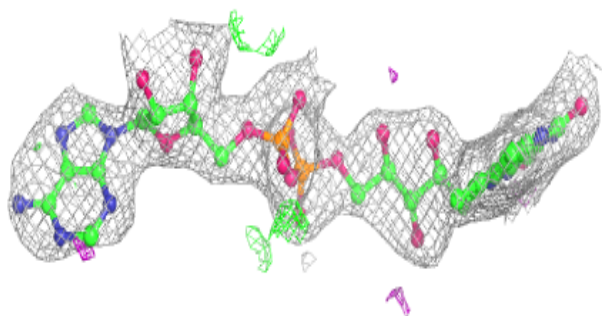
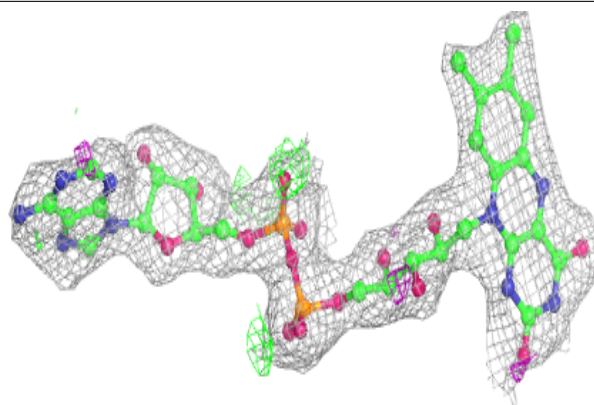
**Electron density around FAD C 371:**

$2mF_o-DF_c$ (at 0.7 rmsd) in gray
 mF_o-DF_c (at 3 rmsd) in purple (negative)
and green (positive)

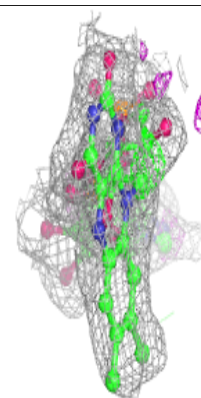
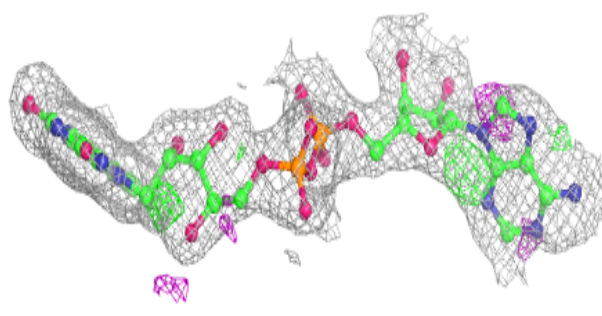
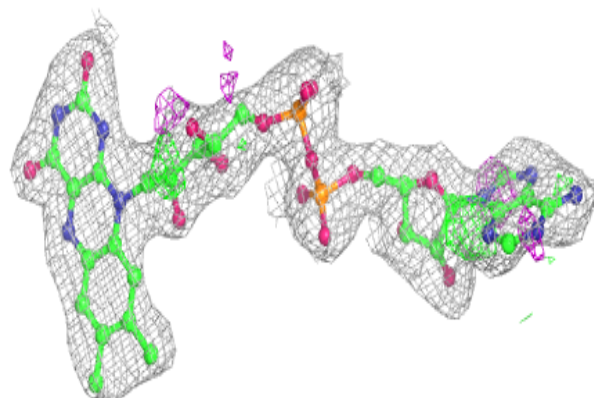

Electron density around FAD B 371:

$2mF_o-DF_c$ (at 0.7 rmsd) in gray
 mF_o-DF_c (at 3 rmsd) in purple (negative)
and green (positive)

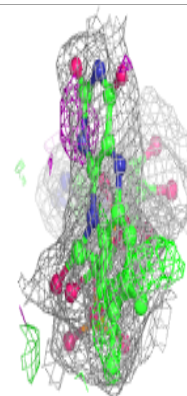
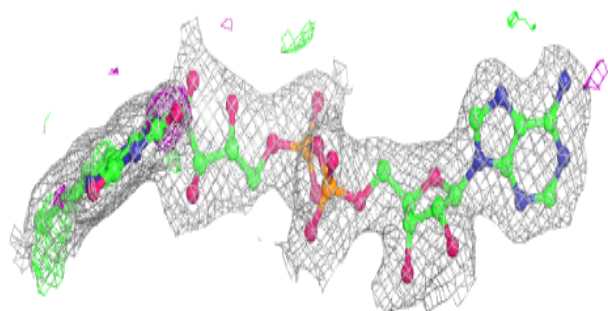
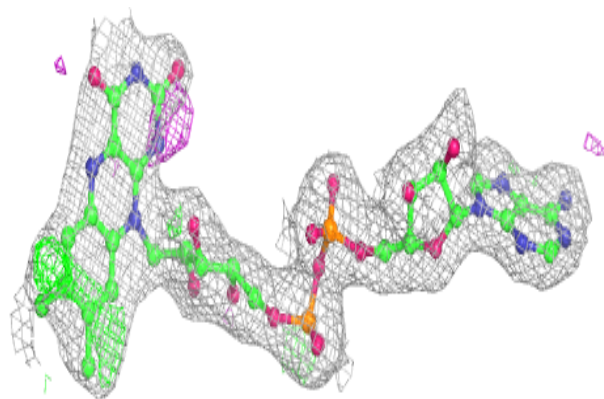
**Electron density around FAD A 371:**

$2mF_o-DF_c$ (at 0.7 rmsd) in gray
 mF_o-DF_c (at 3 rmsd) in purple (negative)
and green (positive)

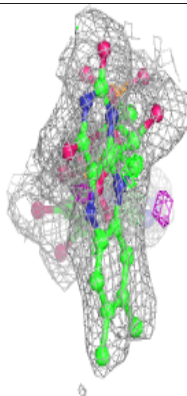
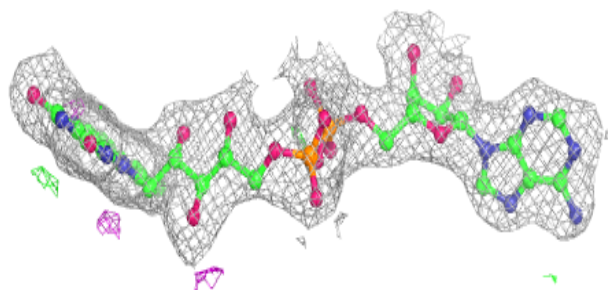
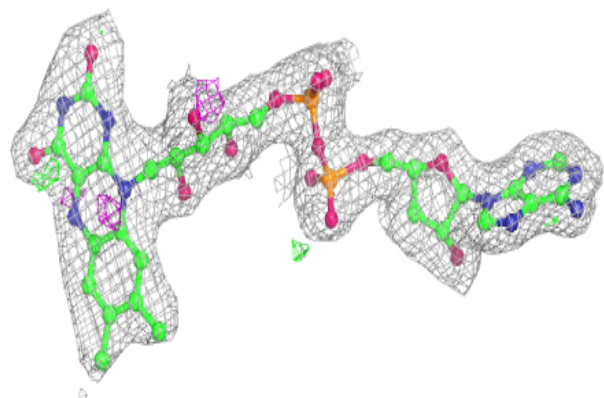

6.5 Other polymers [i](#)

There are no such residues in this entry.