



Full wwPDB EM Validation Report ⓘ

Mar 19, 2024 – 09:07 PM JST

PDB ID : 6J0N
EMDB ID : EMD-9765
Title : Cryo-EM Structure of an Extracellular Contractile Injection System, baseplate in extended state, refined in C6 symmetry
Authors : Jiang, F.; Li, N.; Wang, X.; Cheng, J.; Huang, Y.; Yang, Y.; Yang, J.; Cai, B.; Wang, Y.; Jin, Q.; Gao, N.
Deposited on : 2018-12-25
Resolution : 3.50 Å(reported)

This is a Full wwPDB EM Validation Report for a publicly released PDB entry.

We welcome your comments at validation@mail.wwpdb.org

A user guide is available at

<https://www.wwpdb.org/validation/2017/EMValidationReportHelp>

with specific help available everywhere you see the ⓘ symbol.

The types of validation reports are described at

<http://www.wwpdb.org/validation/2017/FAQs#types>.

The following versions of software and data (see [references ⓘ](#)) were used in the production of this report:

EMDB validation analysis : 0.0.1.dev70
MolProbity : 4.02b-467
Percentile statistics : 20191225.v01 (using entries in the PDB archive December 25th 2019)
MapQ : 1.9.13
Ideal geometry (proteins) : Engh & Huber (2001)
Ideal geometry (DNA, RNA) : Parkinson et al. (1996)
Validation Pipeline (wwPDB-VP) : 2.36

1 Overall quality at a glance

The following experimental techniques were used to determine the structure:
ELECTRON MICROSCOPY

The reported resolution of this entry is 3.50 Å.

Percentile scores (ranging between 0-100) for global validation metrics of the entry are shown in the following graphic. The table shows the number of entries on which the scores are based.

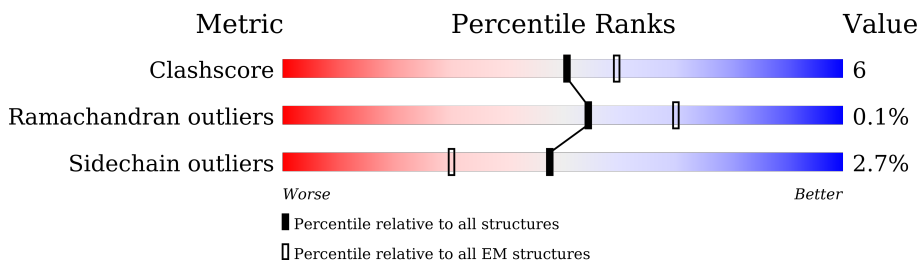

Metric	Whole archive (#Entries)	EM structures (#Entries)
Clashscore	158937	4297
Ramachandran outliers	154571	4023
Sidechain outliers	154315	3826

The table below summarises the geometric issues observed across the polymeric chains and their fit to the map. The red, orange, yellow and green segments of the bar indicate the fraction of residues that contain outliers for ≥ 3 , 2, 1 and 0 types of geometric quality criteria respectively. A grey segment represents the fraction of residues that are not modelled. The numeric value for each fraction is indicated below the corresponding segment, with a dot representing fractions $\leq 5\%$. The upper red bar (where present) indicates the fraction of residues that have poor fit to the EM map (all-atom inclusion $< 40\%$). The numeric value is given above the bar.

Mol	Chain	Length	Quality of chain
1	D	140	
1	E	140	
1	F	140	
1	G	140	
1	H	140	
1	I	140	
2	J	728	
2	K	728	

Continued on next page...

Continued from previous page...

Mol	Chain	Length	Quality of chain
2	L	728	27% 65% 17% 17%
2	M	728	26% 66% 17% 17%
2	N	728	26% 65% 17% 17%
2	O	728	27% 65% 17% 17%
3	P	950	28% 68% 13% 18%
3	Q	950	28% 67% 13% 18%
3	R	950	29% 68% 13% 18%
3	S	950	28% 67% 14% 18%
3	T	950	27% 67% 13% 18%
3	U	950	28% 68% 13% 18%
4	V	410	10% 83% 12% .
4	W	410	9% 85% 11% .
4	X	410	10% 84% 11% .
4	Y	410	10% 85% 10% .
4	Z	410	9% 85% 11% .
4	a	410	9% 94% . .
5	b	229	. 97% . .
5	c	229	. 97% . .
5	d	229	. 97% . .
5	e	229	. 97% . .
5	f	229	. 97% . .
5	g	229	. 97% . .
6	h	355	8% 96% . .
6	i	355	8% 96% . .
6	j	355	8% 96% . .

Continued on next page...

Continued from previous page...

Mol	Chain	Length	Quality of chain
6	k	355	10% 96%
6	l	355	8% 96%
6	m	355	8% 96%
7	n	152	95%
7	o	152	95%
7	p	152	95%
7	q	152	95%
7	r	152	95%
7	s	152	95%
8	1	149	83% 15%
8	2	149	83% 16%
8	3	149	85% 14%
8	4	149	83% 15%
8	5	149	83% 15%
8	z	149	98%
9	t	440	17% 89% 9%
9	u	440	16% 89% 9%
9	v	440	15% 89% 9%
9	w	440	17% 89% 9%
9	x	440	16% 89% 9%
9	y	440	16% 89% 9%

2 Entry composition [i](#)

There are 9 unique types of molecules in this entry. The entry contains 149886 atoms, of which 0 are hydrogens and 0 are deuteriums.

In the tables below, the AltConf column contains the number of residues with at least one atom in alternate conformation and the Trace column contains the number of residues modelled with at most 2 atoms.

- Molecule 1 is a protein called Pvc9.

Mol	Chain	Residues	Atoms					AltConf	Trace
			Total	C	N	O	S		
1	D	127	1022	635	182	198	7	0	0
1	E	127	1022	635	182	198	7	0	0
1	F	127	1022	635	182	198	7	0	0
1	G	127	1022	635	182	198	7	0	0
1	H	127	1022	635	182	198	7	0	0
1	I	127	1022	635	182	198	7	0	0

- Molecule 2 is a protein called Pvc11.

Mol	Chain	Residues	Atoms					AltConf	Trace
			Total	C	N	O	S		
2	J	602	4858	3113	814	920	11	0	0
2	K	602	4858	3113	814	920	11	0	0
2	L	602	4858	3113	814	920	11	0	0
2	M	602	4858	3113	814	920	11	0	0
2	N	602	4858	3113	814	920	11	0	0
2	O	602	4858	3113	814	920	11	0	0

- Molecule 3 is a protein called Pvc12.

Mol	Chain	Residues	Atoms					AltConf	Trace
			Total	C	N	O	S		
3	P	780	6064	3865	1037	1149	13	0	0

Continued on next page...

Continued from previous page...

Mol	Chain	Residues	Atoms					AltConf	Trace
3	Q	780	Total	C	N	O	S	0	0
			6064	3865	1037	1149	13		
3	R	780	Total	C	N	O	S	0	0
			6064	3865	1037	1149	13		
3	S	780	Total	C	N	O	S	0	0
			6064	3865	1037	1149	13		
3	T	780	Total	C	N	O	S	0	0
			6064	3865	1037	1149	13		
3	U	780	Total	C	N	O	S	0	0
			6064	3865	1037	1149	13		

- Molecule 4 is a protein called Pvc4.

Mol	Chain	Residues	Atoms					AltConf	Trace
4	V	393	Total	C	N	O	S	0	0
			3100	1971	525	589	15		
4	W	393	Total	C	N	O	S	0	0
			3100	1971	525	589	15		
4	X	393	Total	C	N	O	S	0	0
			3100	1971	525	589	15		
4	Y	393	Total	C	N	O	S	0	0
			3100	1971	525	589	15		
4	Z	393	Total	C	N	O	S	0	0
			3100	1971	525	589	15		
4	a	393	Total	C	N	O	S	0	0
			3100	1971	525	589	15		

- Molecule 5 is a protein called Pvc7.

Mol	Chain	Residues	Atoms					AltConf	Trace
5	b	223	Total	C	N	O	S	0	0
			1736	1091	301	338	6		
5	c	223	Total	C	N	O	S	0	0
			1736	1091	301	338	6		
5	d	223	Total	C	N	O	S	0	0
			1736	1091	301	338	6		
5	e	223	Total	C	N	O	S	0	0
			1736	1091	301	338	6		
5	f	223	Total	C	N	O	S	0	0
			1736	1091	301	338	6		
5	g	223	Total	C	N	O	S	0	0
			1736	1091	301	338	6		

- Molecule 6 is a protein called Pvc2.

Mol	Chain	Residues	Atoms					AltConf	Trace
6	h	352	Total	C	N	O	S	0	0
			2746	1752	453	532	9		
6	i	352	Total	C	N	O	S	0	0
			2746	1752	453	532	9		
6	j	352	Total	C	N	O	S	0	0
			2746	1752	453	532	9		
6	k	352	Total	C	N	O	S	0	0
			2746	1752	453	532	9		
6	l	352	Total	C	N	O	S	0	0
			2746	1752	453	532	9		
6	m	352	Total	C	N	O	S	0	0
			2746	1752	453	532	9		

- Molecule 7 is a protein called Pvc5.

Mol	Chain	Residues	Atoms					AltConf	Trace
7	n	148	Total	C	N	O	S	0	0
			1195	761	208	221	5		
7	o	148	Total	C	N	O	S	0	0
			1195	761	208	221	5		
7	p	148	Total	C	N	O	S	0	0
			1195	761	208	221	5		
7	q	148	Total	C	N	O	S	0	0
			1195	761	208	221	5		
7	r	148	Total	C	N	O	S	0	0
			1195	761	208	221	5		
7	s	148	Total	C	N	O	S	0	0
			1195	761	208	221	5		

- Molecule 8 is a protein called Pvc1.

Mol	Chain	Residues	Atoms					AltConf	Trace
8	1	148	Total	C	N	O	S	0	0
			1153	732	185	232	4		
8	2	148	Total	C	N	O	S	0	0
			1153	732	185	232	4		
8	3	148	Total	C	N	O	S	0	0
			1153	732	185	232	4		
8	4	148	Total	C	N	O	S	0	0
			1153	732	185	232	4		
8	5	148	Total	C	N	O	S	0	0
			1153	732	185	232	4		

Continued on next page...

Continued from previous page...

Mol	Chain	Residues	Atoms					AltConf	Trace
			Total	C	N	O	S		
8	z	148	1153	732	185	232	4	0	0

- Molecule 9 is a protein called Pvc3.

Mol	Chain	Residues	Atoms					AltConf	Trace
			Total	C	N	O	S		
9	t	401	3107	1979	522	595	11	0	0
9	u	401	3107	1979	522	595	11	0	0
9	v	401	3107	1979	522	595	11	0	0
9	w	401	3107	1979	522	595	11	0	0
9	x	401	3107	1979	522	595	11	0	0
9	y	401	3107	1979	522	595	11	0	0

3 Residue-property plots [i](#)

These plots are drawn for all protein, RNA, DNA and oligosaccharide chains in the entry. The first graphic for a chain summarises the proportions of the various outlier classes displayed in the second graphic. The second graphic shows the sequence view annotated by issues in geometry and atom inclusion in map density. Residues are color-coded according to the number of geometric quality criteria for which they contain at least one outlier: green = 0, yellow = 1, orange = 2 and red = 3 or more. A red diamond above a residue indicates a poor fit to the EM map for this residue (all-atom inclusion < 40%). Stretches of 2 or more consecutive residues without any outlier are shown as a green connector. Residues present in the sample, but not in the model, are shown in grey.

- Molecule 1: Pvc9

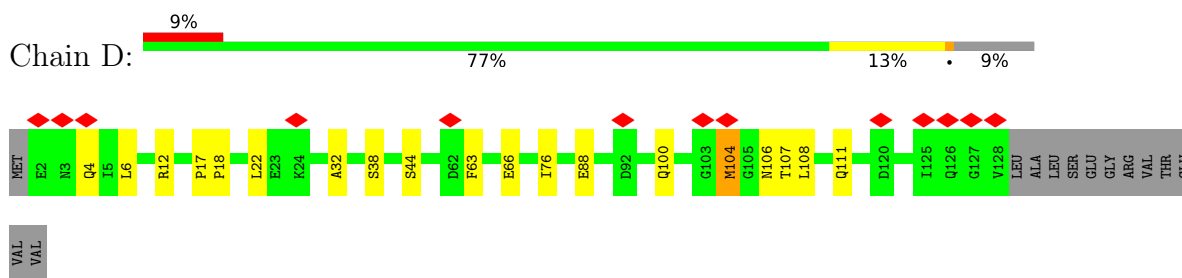

- Molecule 1: Pvc9

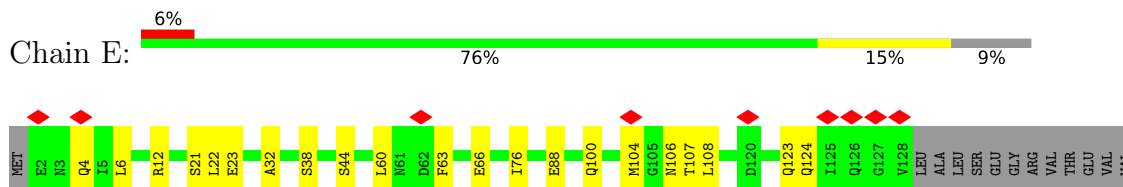

- Molecule 1: Pvc9

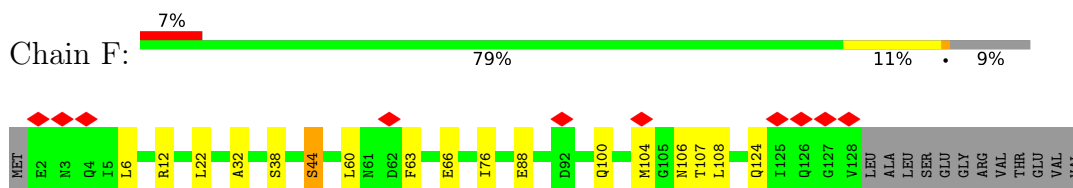

- Molecule 1: Pvc9

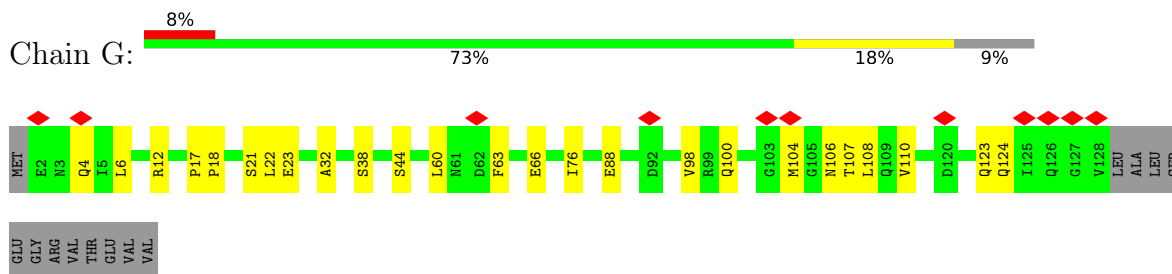

- Molecule 1: Pvc9

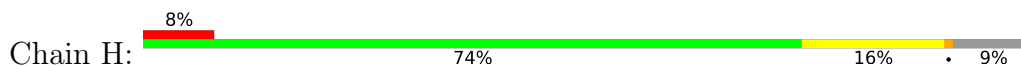

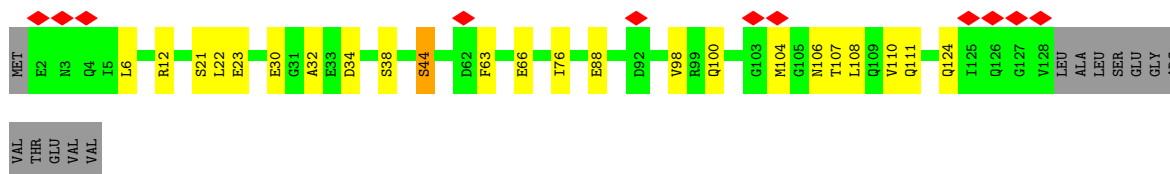

• Molecule 1: Pvc9

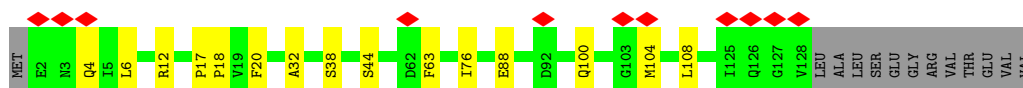
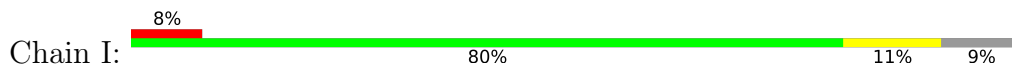

• Molecule 2: Pvc11

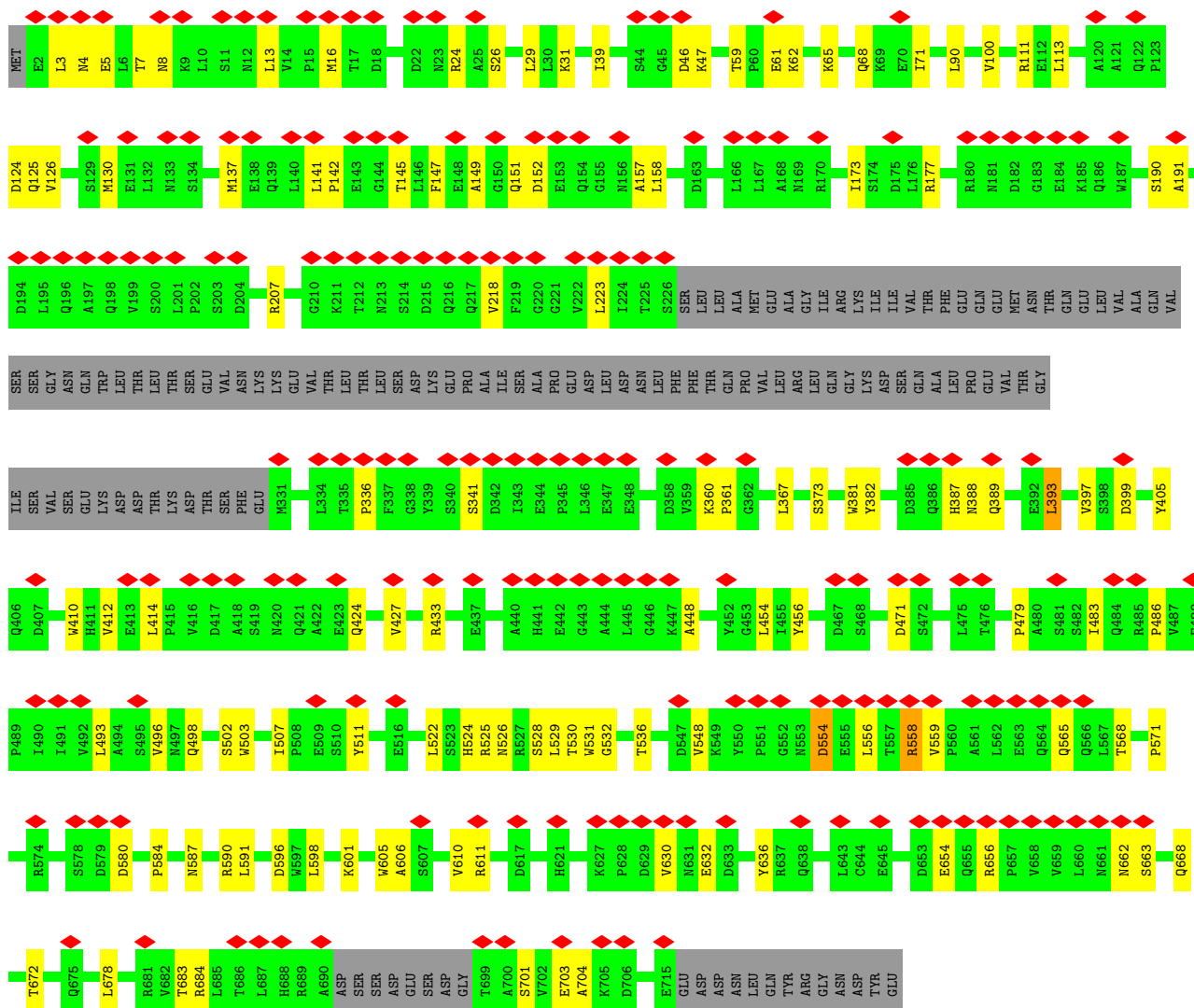

• Molecule 2: Pvc11

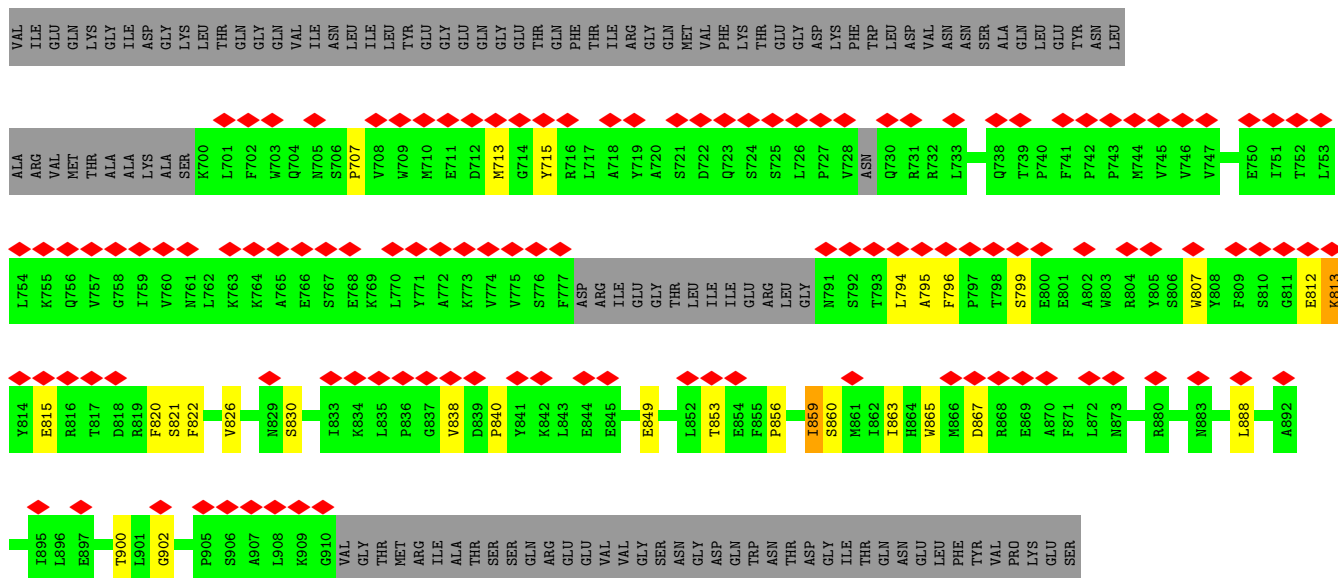

• Molecule 3: Pvc12

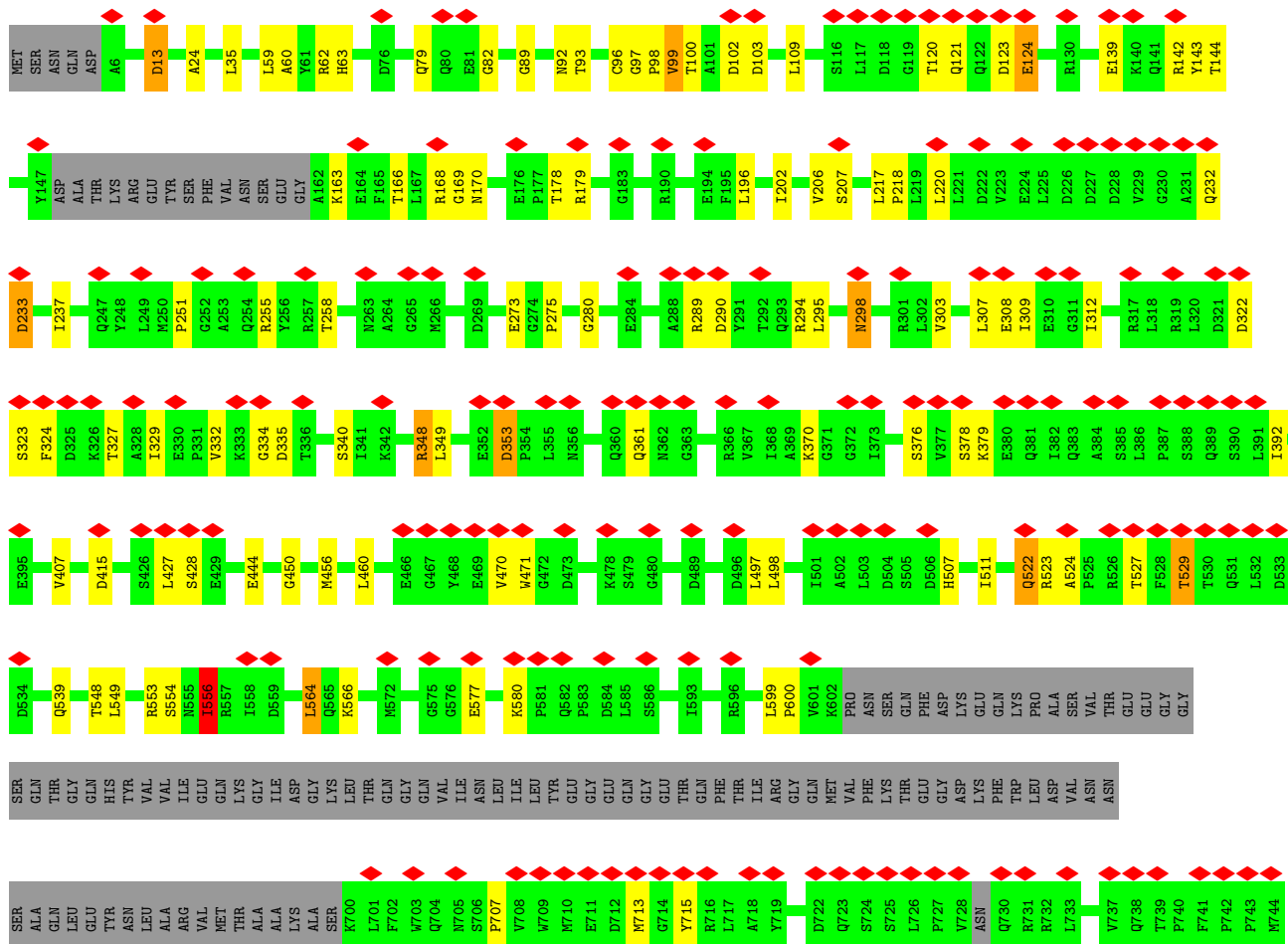

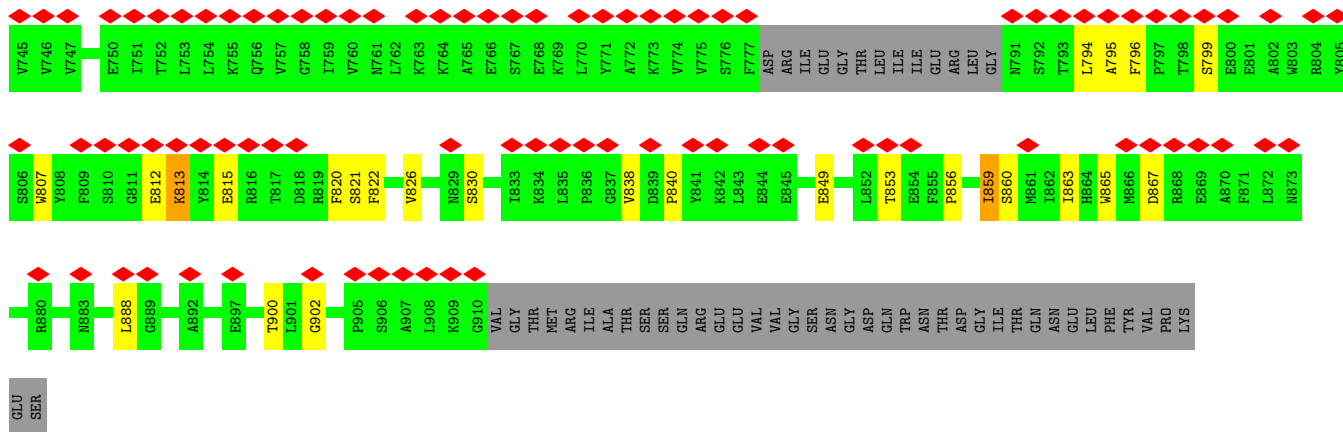

• Molecule 3: Pvc12

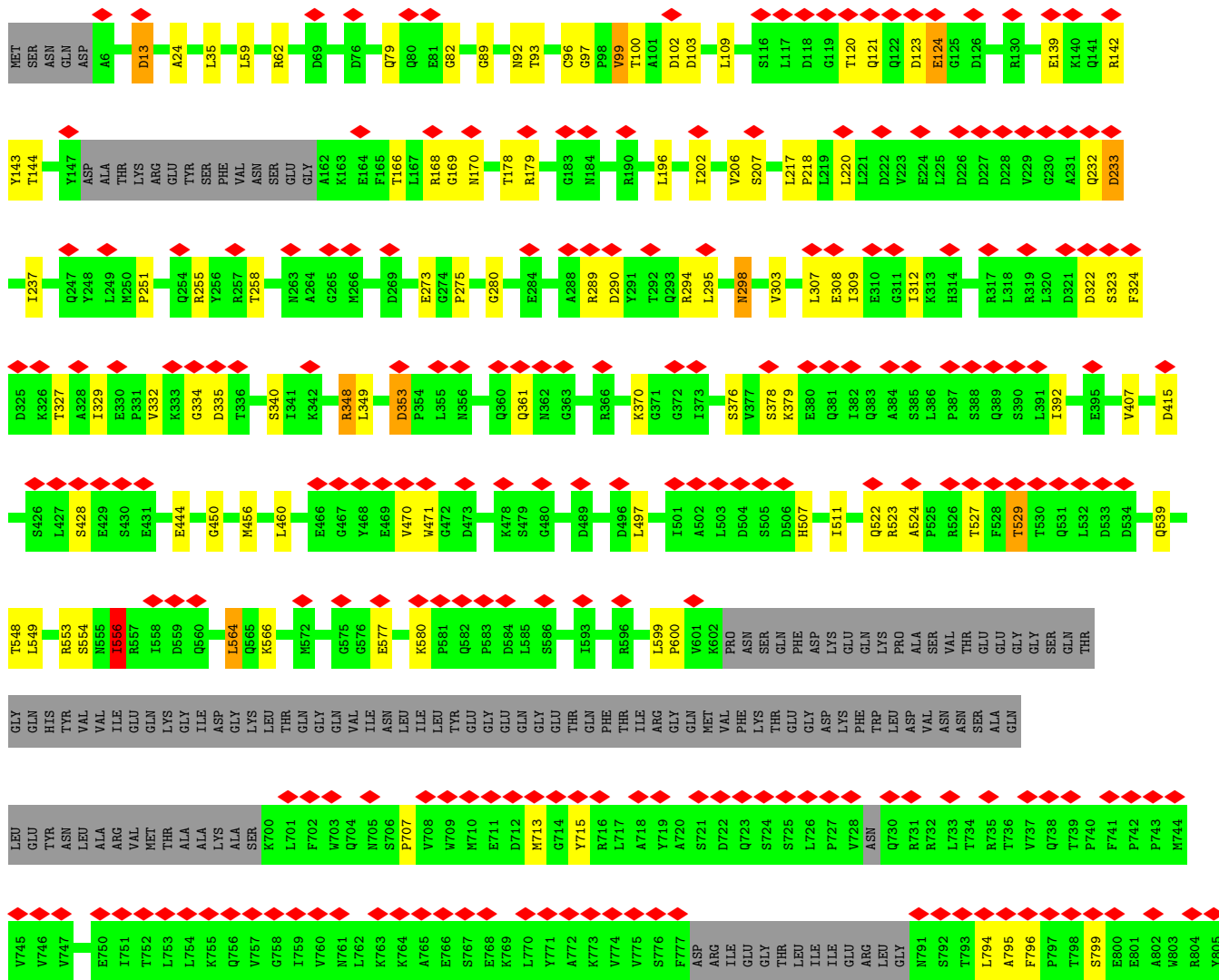

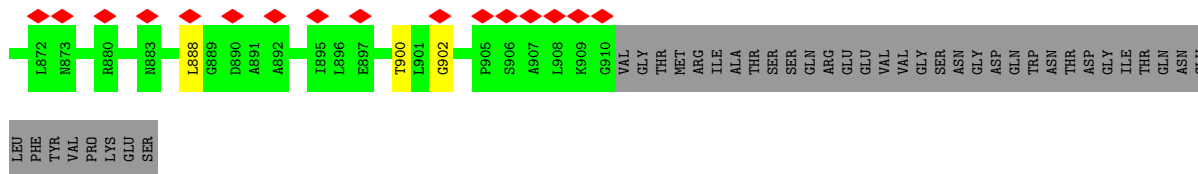

• Molecule 3: Pvc12

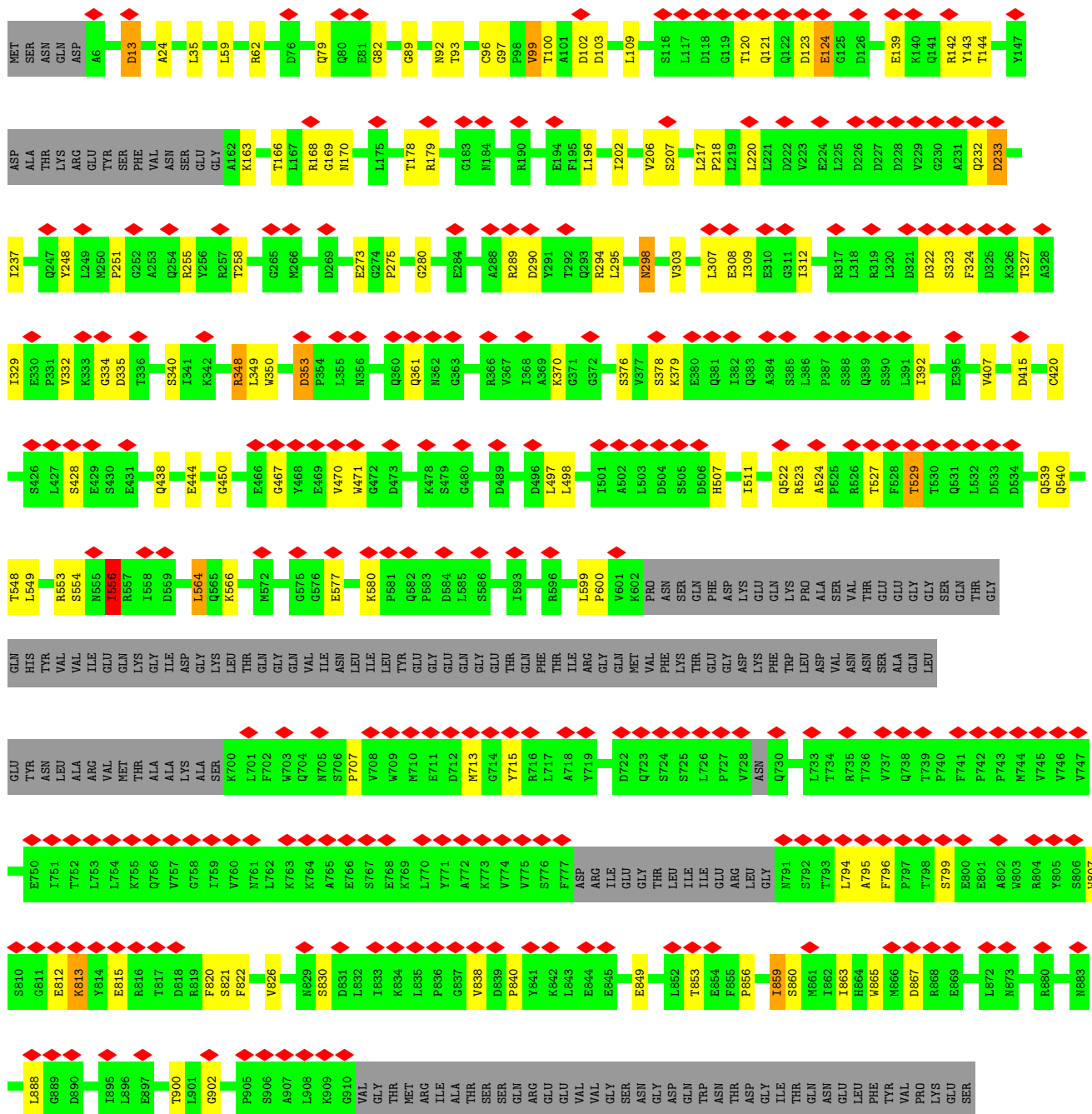

• Molecule 3: Pvc12

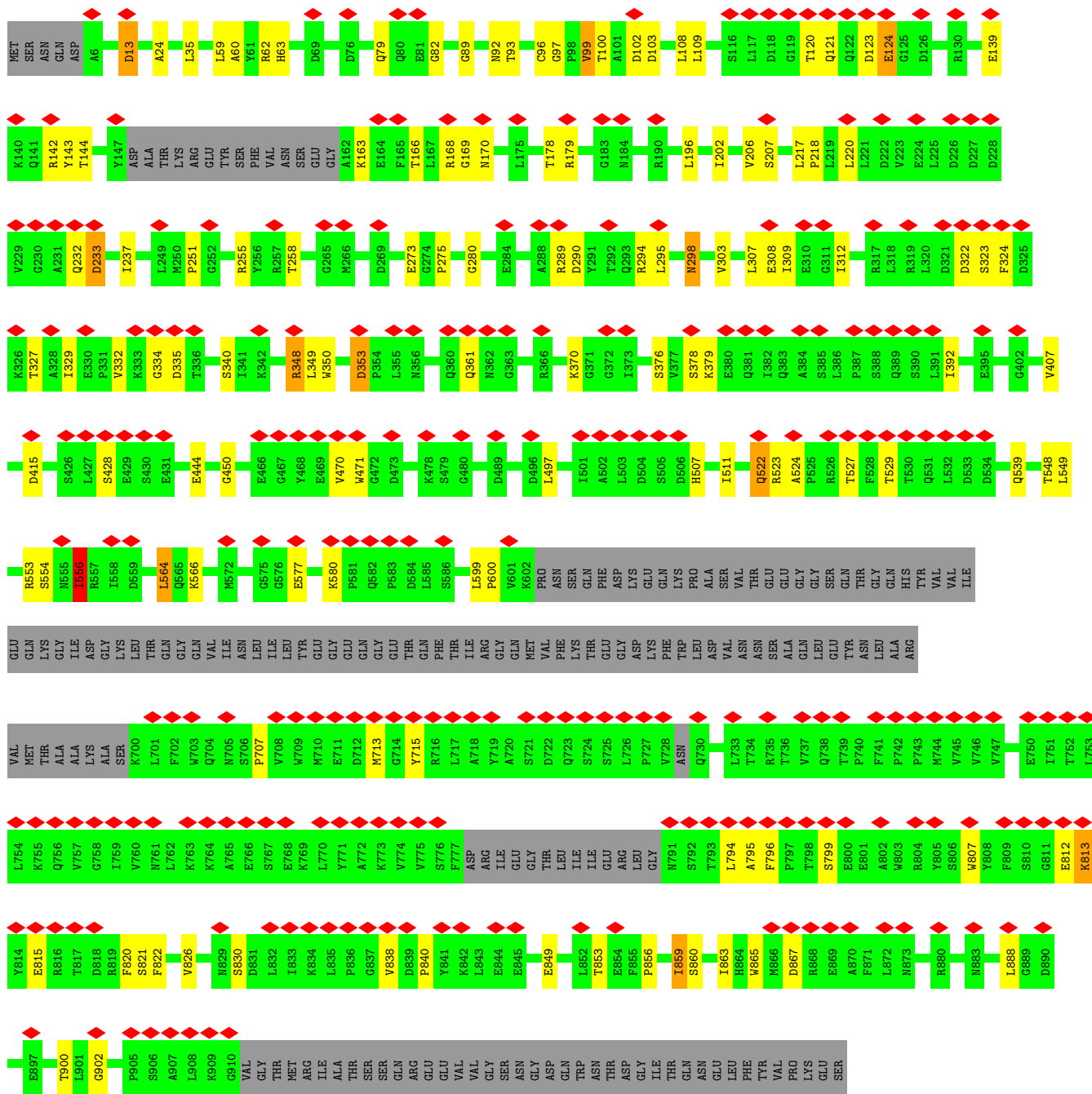

• Molecule 4: Pvc4

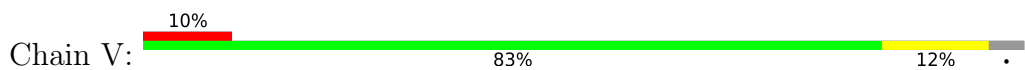

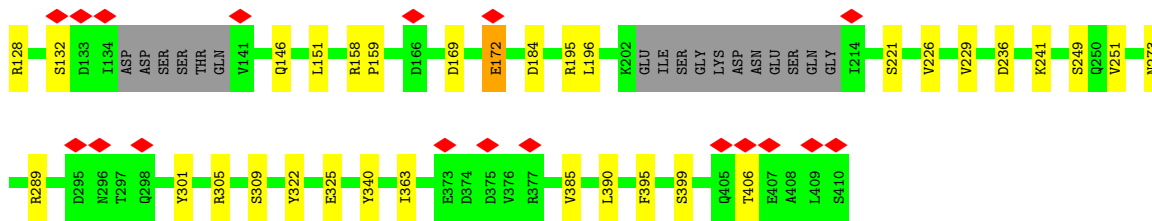

• Molecule 4: Pvc4

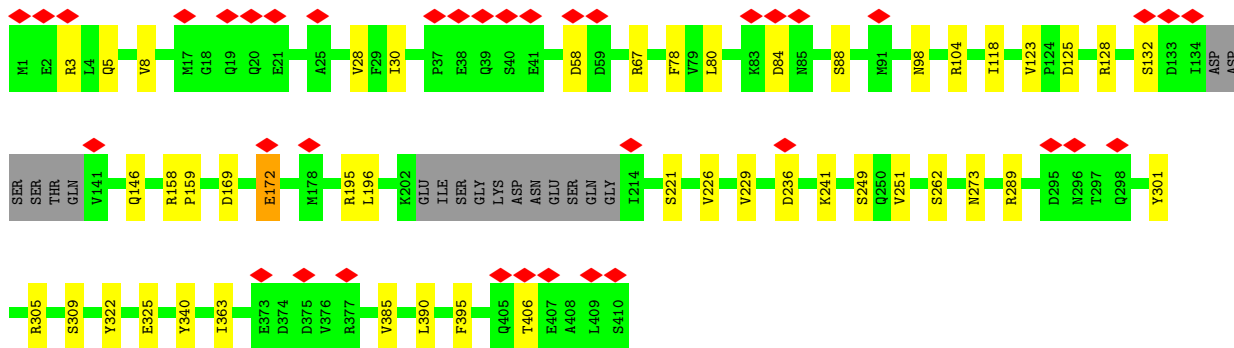
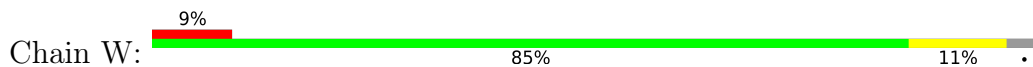

• Molecule 4: Pvc4

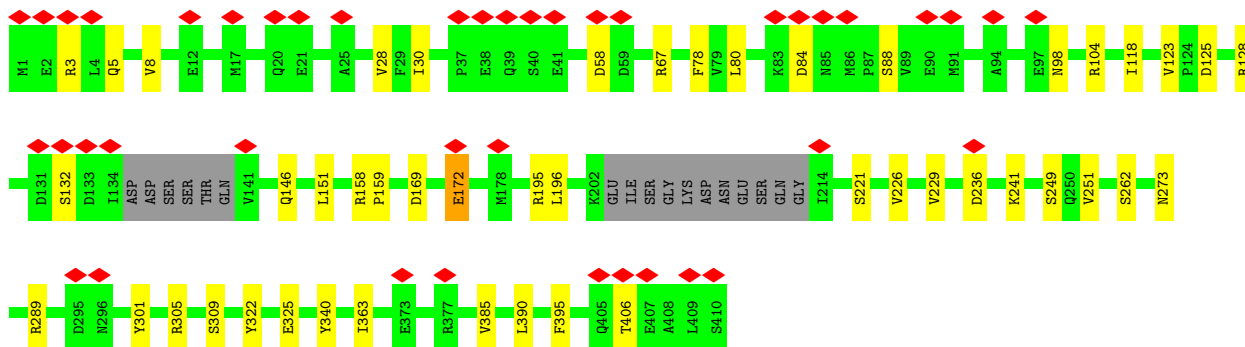
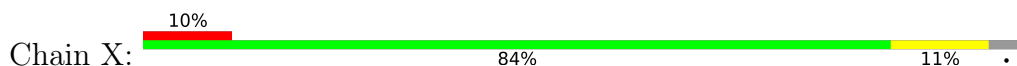

• Molecule 4: Pvc4

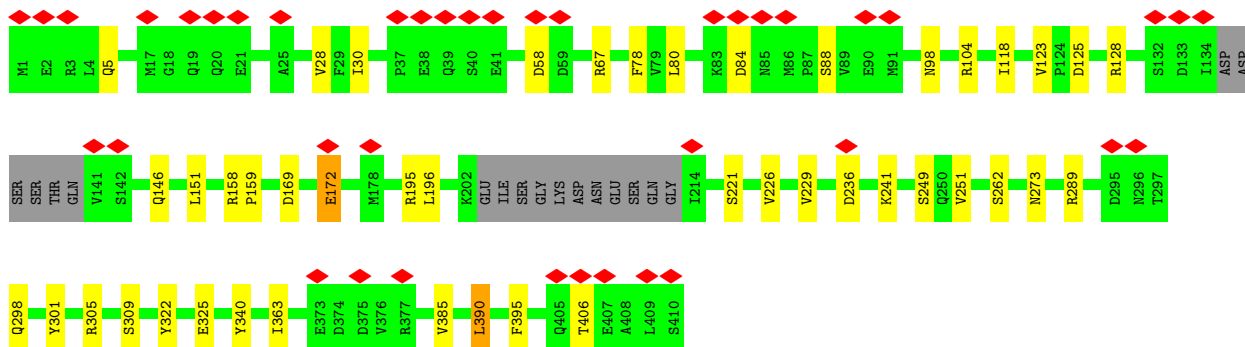
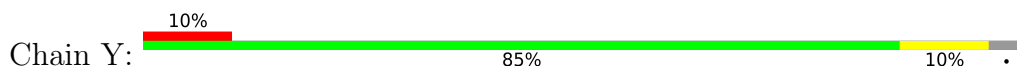

• Molecule 4: Pvc4

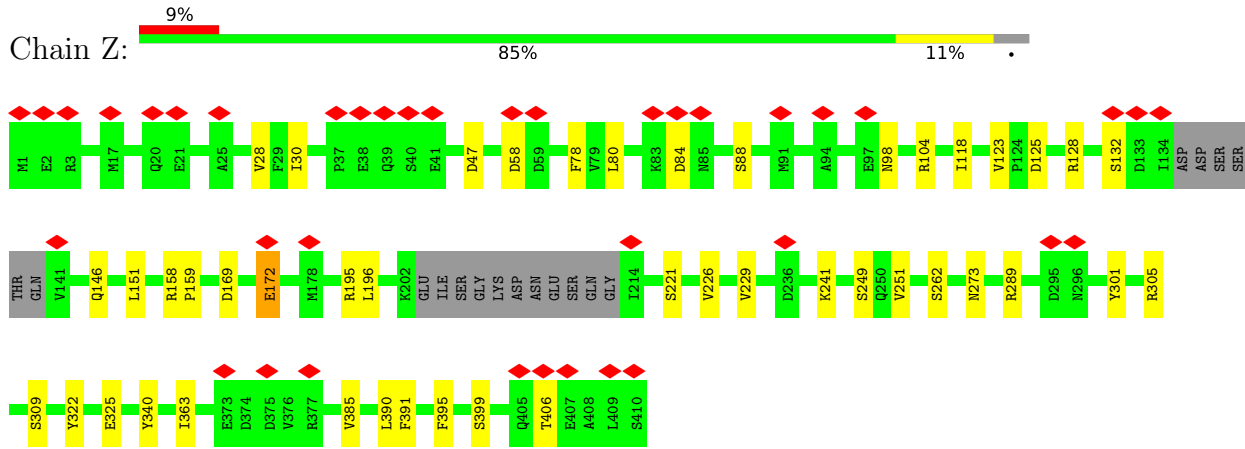

• Molecule 4: Pvc4

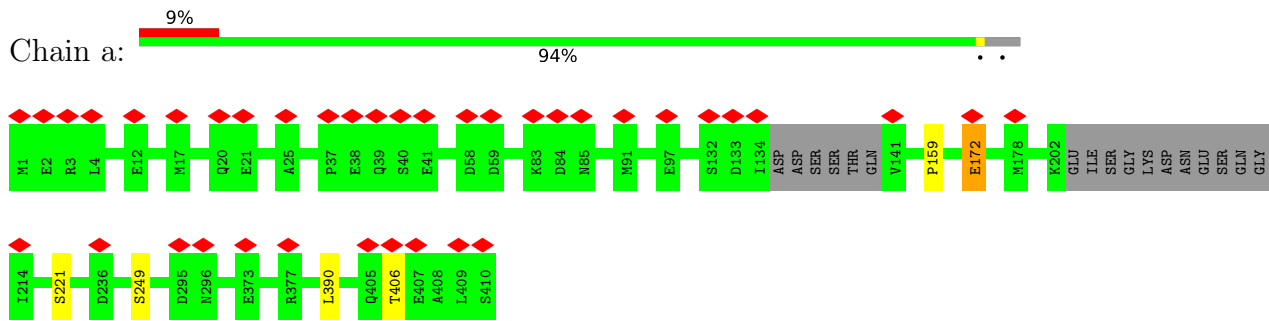

• Molecule 5: Pvc7

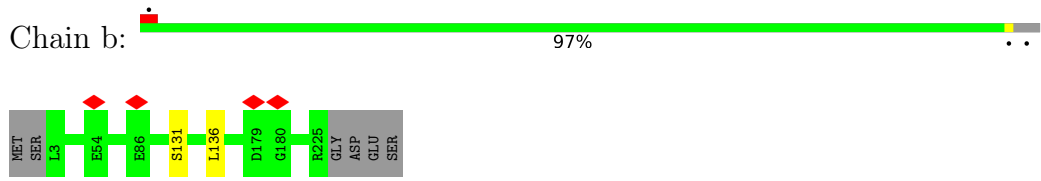

• Molecule 5: Pvc7

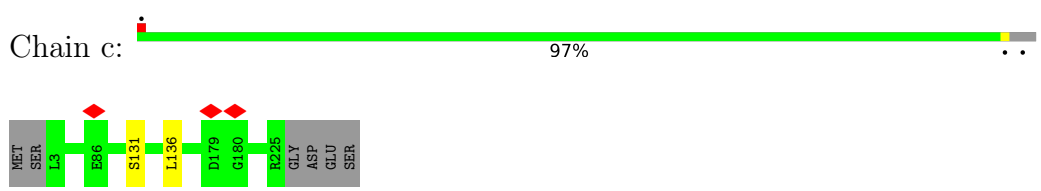

• Molecule 5: Pvc7

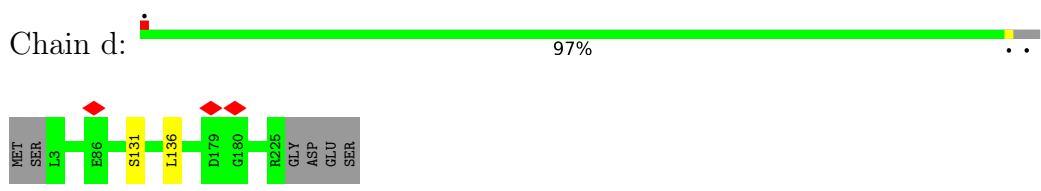

• Molecule 5: Pvc7

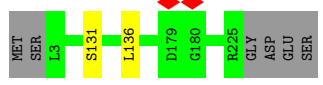

• Molecule 5: Pvc7

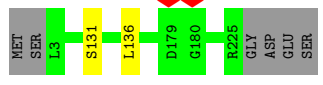
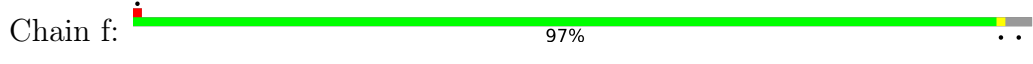

• Molecule 5: Pvc7

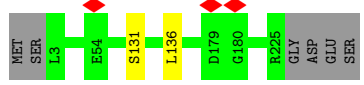

• Molecule 6: Pvc2

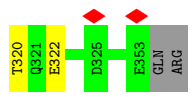
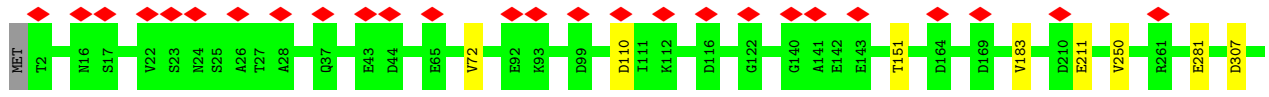

• Molecule 6: Pvc2

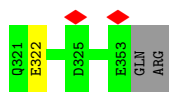
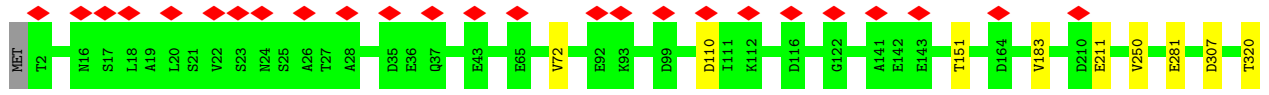

• Molecule 6: Pvc2

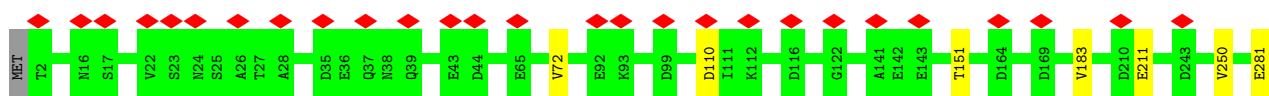
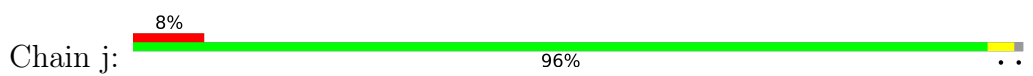

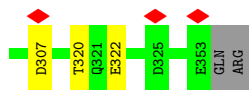

• Molecule 6: Pvc2

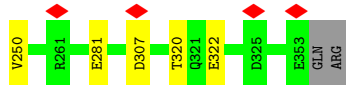
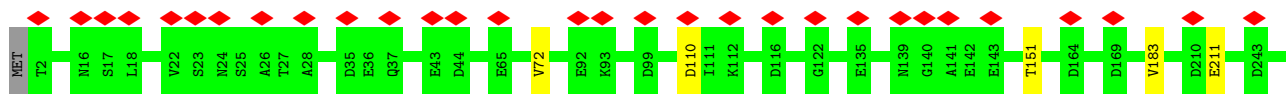

• Molecule 6: Pvc2

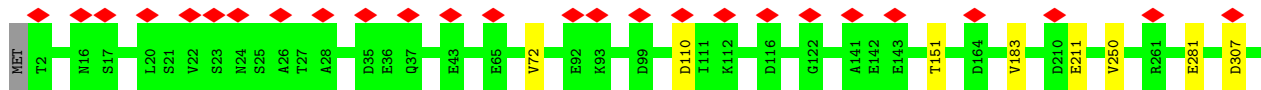

• Molecule 6: Pvc2

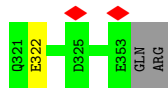
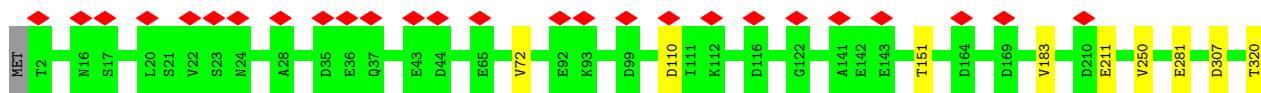

• Molecule 7: Pvc5



• Molecule 7: Pvc5



• Molecule 7: Pvc5

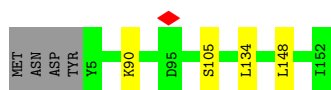

• Molecule 7: Pvc5

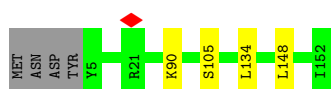

• Molecule 7: Pvc5

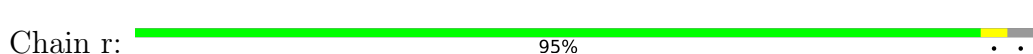

• Molecule 7: Pvc5

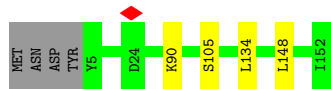
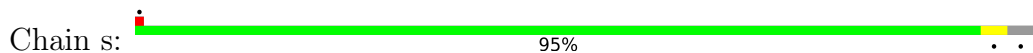

• Molecule 8: Pvc1

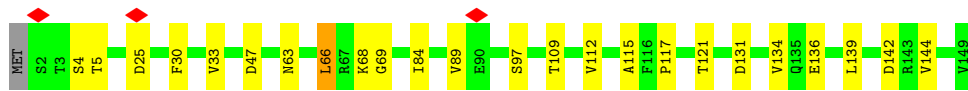
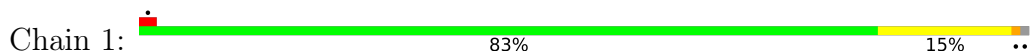

• Molecule 8: Pvc1

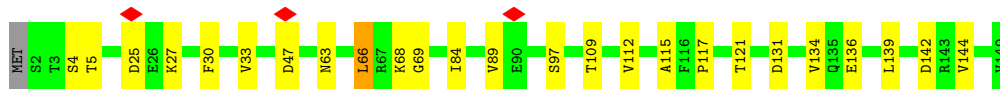
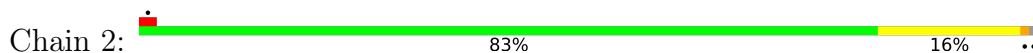

• Molecule 8: Pvc1

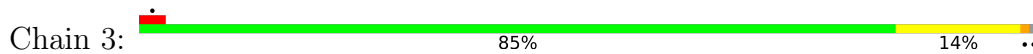

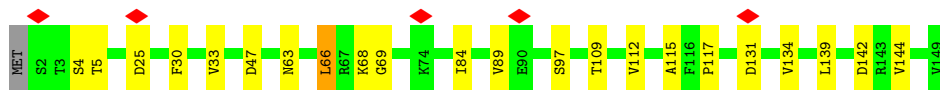

• Molecule 8: Pvc1

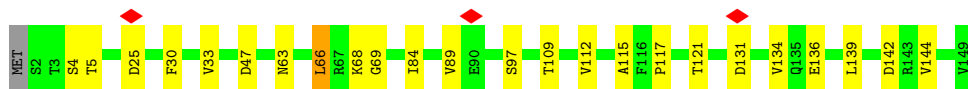
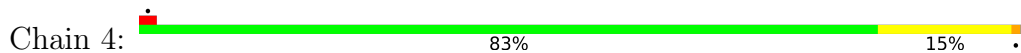

• Molecule 8: Pvc1

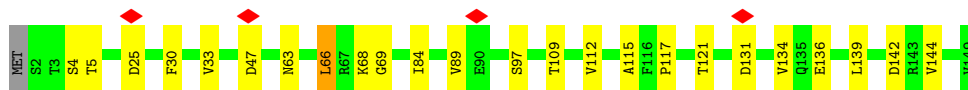
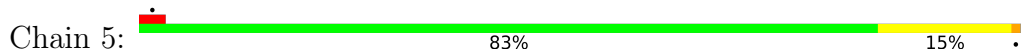

• Molecule 8: Pvc1

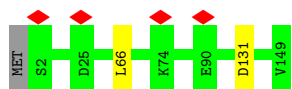

• Molecule 9: Pvc3

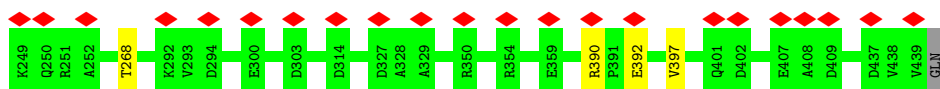
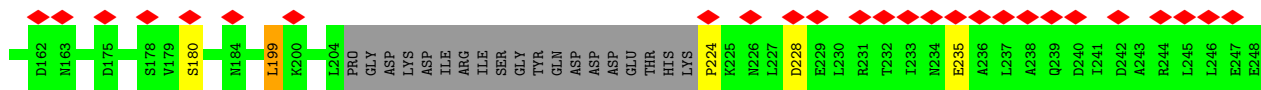
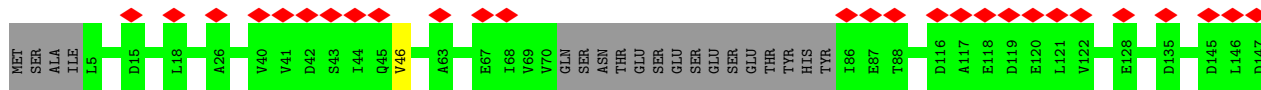
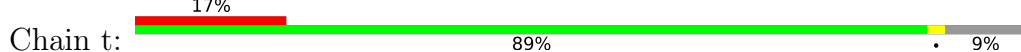

• Molecule 9: Pvc3

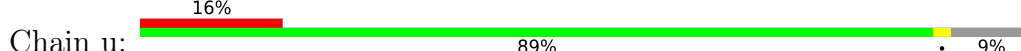

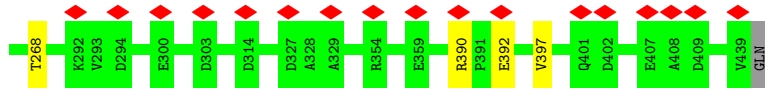
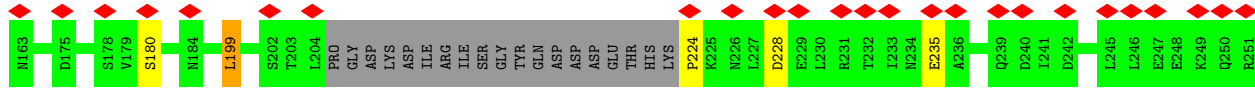

• Molecule 9: Pvc3

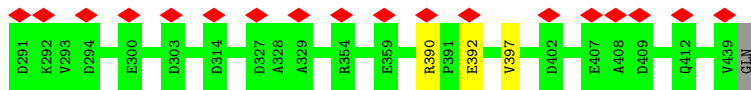
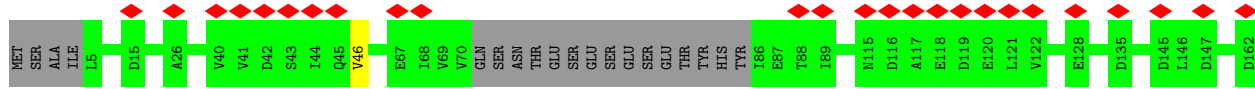
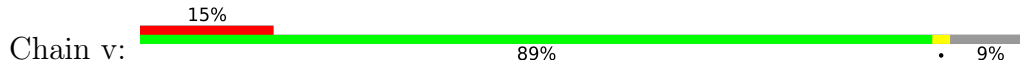

• Molecule 9: Pvc3

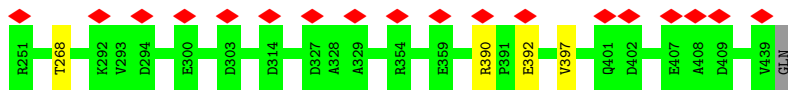
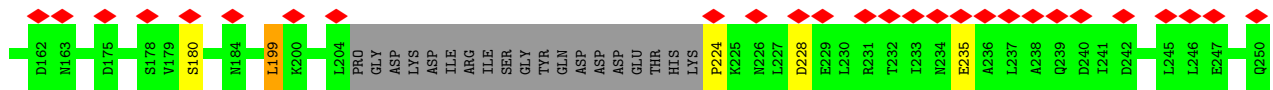
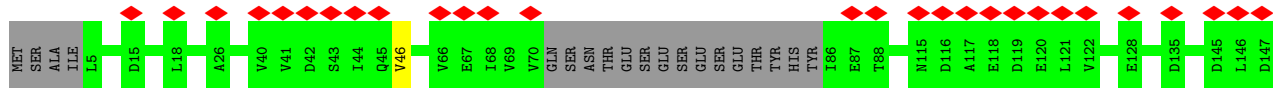
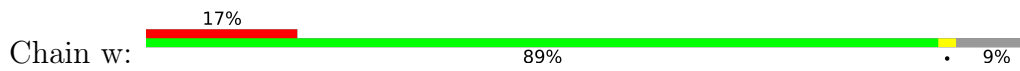

• Molecule 9: Pvc3

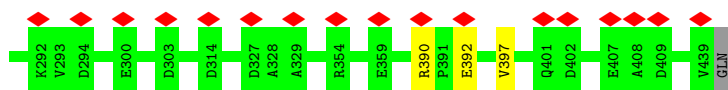
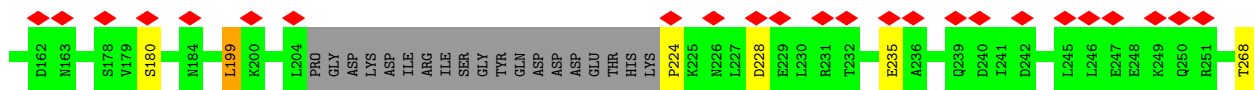
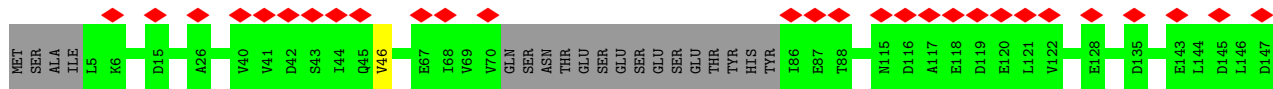
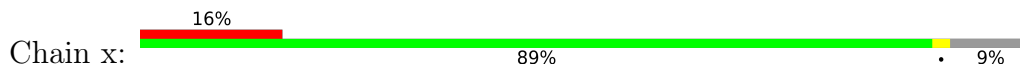

4 Experimental information

Property	Value	Source
EM reconstruction method	SINGLE PARTICLE	Depositor
Imposed symmetry	POINT, C6	Depositor
Number of particles used	63000	Depositor
Resolution determination method	FSC 0.143 CUT-OFF	Depositor
CTF correction method	PHASE FLIPPING AND AMPLITUDE CORRECTION	Depositor
Microscope	FEI TITAN KRIOS	Depositor
Voltage (kV)	300	Depositor
Electron dose ($e^-/\text{\AA}^2$)	46.4	Depositor
Minimum defocus (nm)	Not provided	
Maximum defocus (nm)	Not provided	
Magnification	Not provided	
Image detector	FEI FALCON II (4k x 4k)	Depositor
Maximum map value	0.810	Depositor
Minimum map value	-0.511	Depositor
Average map value	0.003	Depositor
Map value standard deviation	0.033	Depositor
Recommended contour level	0.12	Depositor
Map size (Å)	403.56003, 403.56003, 403.56003	wwPDB
Map dimensions	360, 360, 360	wwPDB
Map angles (°)	90.0, 90.0, 90.0	wwPDB
Pixel spacing (Å)	1.121, 1.121, 1.121	Depositor

5 Model quality [i](#)

5.1 Standard geometry [i](#)

The Z score for a bond length (or angle) is the number of standard deviations the observed value is removed from the expected value. A bond length (or angle) with $|Z| > 5$ is considered an outlier worth inspection. RMSZ is the root-mean-square of all Z scores of the bond lengths (or angles).

Mol	Chain	Bond lengths		Bond angles	
		RMSZ	# Z >5	RMSZ	# Z >5
1	D	0.41	0/1039	0.59	0/1401
1	E	0.41	0/1039	0.59	0/1401
1	F	0.41	0/1039	0.59	0/1401
1	G	0.41	0/1039	0.59	0/1401
1	H	0.41	0/1039	0.59	0/1401
1	I	0.41	0/1039	0.59	0/1401
2	J	0.32	0/4984	0.61	3/6806 (0.0%)
2	K	0.32	0/4984	0.61	3/6806 (0.0%)
2	L	0.32	0/4984	0.61	3/6806 (0.0%)
2	M	0.32	0/4984	0.61	3/6806 (0.0%)
2	N	0.32	0/4984	0.61	3/6806 (0.0%)
2	O	0.32	0/4984	0.61	3/6806 (0.0%)
3	P	0.33	0/6216	0.60	3/8476 (0.0%)
3	Q	0.33	0/6216	0.60	3/8476 (0.0%)
3	R	0.33	0/6216	0.60	3/8476 (0.0%)
3	S	0.33	0/6216	0.60	3/8476 (0.0%)
3	T	0.33	0/6216	0.60	3/8476 (0.0%)
3	U	0.33	0/6216	0.60	3/8476 (0.0%)
4	V	0.40	0/3164	0.61	1/4305 (0.0%)
4	W	0.40	0/3164	0.61	1/4305 (0.0%)
4	X	0.40	0/3164	0.61	1/4305 (0.0%)
4	Y	0.40	0/3164	0.61	1/4305 (0.0%)
4	Z	0.40	0/3164	0.61	1/4305 (0.0%)
4	a	0.40	0/3164	0.61	1/4305 (0.0%)
5	b	0.42	0/1761	0.58	1/2384 (0.0%)
5	c	0.42	0/1761	0.58	1/2384 (0.0%)
5	d	0.42	0/1761	0.58	1/2384 (0.0%)
5	e	0.42	0/1761	0.58	1/2384 (0.0%)
5	f	0.42	0/1761	0.58	1/2384 (0.0%)
5	g	0.42	0/1761	0.58	1/2384 (0.0%)
6	h	0.40	0/2806	0.60	0/3825
6	i	0.40	0/2806	0.60	0/3825
6	j	0.40	0/2806	0.60	0/3825
6	k	0.40	0/2806	0.60	0/3825

Mol	Chain	Bond lengths		Bond angles	
		RMSZ	# Z >5	RMSZ	# Z >5
6	l	0.40	0/2806	0.60	0/3825
6	m	0.40	0/2806	0.60	0/3825
7	n	0.47	0/1221	0.65	1/1660 (0.1%)
7	o	0.47	0/1221	0.65	1/1660 (0.1%)
7	p	0.47	0/1221	0.65	1/1660 (0.1%)
7	q	0.47	0/1221	0.65	1/1660 (0.1%)
7	r	0.47	0/1221	0.65	1/1660 (0.1%)
7	s	0.47	0/1221	0.65	1/1660 (0.1%)
8	1	0.44	0/1176	0.62	0/1603
8	2	0.44	0/1176	0.62	0/1603
8	3	0.44	0/1176	0.62	0/1603
8	4	0.44	0/1176	0.62	0/1603
8	5	0.44	0/1176	0.62	0/1603
8	z	0.44	0/1176	0.62	0/1603
9	t	0.36	0/3162	0.59	2/4302 (0.0%)
9	u	0.36	0/3162	0.59	2/4302 (0.0%)
9	v	0.36	0/3162	0.59	2/4302 (0.0%)
9	w	0.36	0/3162	0.59	2/4302 (0.0%)
9	x	0.36	0/3162	0.59	2/4302 (0.0%)
9	y	0.36	0/3162	0.59	2/4302 (0.0%)
All	All	0.37	0/153174	0.60	66/208572 (0.0%)

Chiral center outliers are detected by calculating the chiral volume of a chiral center and verifying if the center is modelled as a planar moiety or with the opposite hand. A planarity outlier is detected by checking planarity of atoms in a peptide group, atoms in a mainchain group or atoms of a sidechain that are expected to be planar.

Mol	Chain	#Chirality outliers	#Planarity outliers
3	P	0	6
3	Q	0	6
3	R	0	6
3	S	0	6
3	T	0	6
3	U	0	6
7	n	0	1
7	o	0	1
7	p	0	1
7	q	0	1
7	r	0	1
7	s	0	1
All	All	0	42

There are no bond length outliers.

All (66) bond angle outliers are listed below:

Mol	Chain	Res	Type	Atoms	Z	Observed(°)	Ideal(°)
2	N	46	ASP	CB-CG-OD2	9.21	126.59	118.30
2	K	46	ASP	CB-CG-OD2	9.18	126.56	118.30
2	M	46	ASP	CB-CG-OD2	9.17	126.56	118.30
2	J	46	ASP	CB-CG-OD2	9.16	126.55	118.30
2	O	46	ASP	CB-CG-OD2	9.14	126.53	118.30
2	L	46	ASP	CB-CG-OD2	9.11	126.50	118.30
4	X	172	GLU	CA-CB-CG	7.30	129.46	113.40
4	W	172	GLU	CA-CB-CG	7.29	129.43	113.40
4	Z	172	GLU	CA-CB-CG	7.28	129.41	113.40
4	V	172	GLU	CA-CB-CG	7.27	129.40	113.40
4	Y	172	GLU	CA-CB-CG	7.27	129.40	113.40
4	a	172	GLU	CA-CB-CG	7.26	129.38	113.40
2	O	558	ARG	NE-CZ-NH2	6.58	123.59	120.30
2	N	558	ARG	NE-CZ-NH2	6.55	123.58	120.30
2	K	558	ARG	NE-CZ-NH2	6.54	123.57	120.30
2	L	558	ARG	NE-CZ-NH2	6.49	123.55	120.30
2	M	558	ARG	NE-CZ-NH2	6.43	123.51	120.30
2	J	558	ARG	NE-CZ-NH2	6.41	123.51	120.30
9	y	224	PRO	N-CA-CB	6.04	110.54	103.30
9	u	224	PRO	N-CA-CB	6.03	110.54	103.30
9	w	224	PRO	N-CA-CB	6.03	110.54	103.30
9	x	224	PRO	N-CA-CB	6.03	110.54	103.30
9	t	224	PRO	N-CA-CB	6.03	110.53	103.30
9	v	224	PRO	N-CA-CB	6.00	110.50	103.30
5	c	136	LEU	CB-CG-CD1	-5.91	100.96	111.00
5	f	136	LEU	CB-CG-CD1	-5.91	100.96	111.00
5	d	136	LEU	CB-CG-CD1	-5.91	100.96	111.00
5	b	136	LEU	CB-CG-CD1	-5.89	100.98	111.00
5	e	136	LEU	CB-CG-CD1	-5.89	100.99	111.00
5	g	136	LEU	CB-CG-CD1	-5.87	101.02	111.00
3	S	415	ASP	CB-CG-OD1	5.55	123.29	118.30
3	T	415	ASP	CB-CG-OD1	5.52	123.27	118.30
3	R	415	ASP	CB-CG-OD1	5.51	123.26	118.30
3	P	415	ASP	CB-CG-OD1	5.51	123.26	118.30
3	U	415	ASP	CB-CG-OD1	5.48	123.23	118.30
3	Q	415	ASP	CB-CG-OD1	5.47	123.22	118.30
9	t	199	LEU	CA-CB-CG	5.42	127.76	115.30
9	u	199	LEU	CA-CB-CG	5.41	127.75	115.30
9	v	199	LEU	CA-CB-CG	5.41	127.73	115.30
9	y	199	LEU	CA-CB-CG	5.39	127.71	115.30
2	L	393	LEU	CA-CB-CG	5.39	127.69	115.30
9	w	199	LEU	CA-CB-CG	5.38	127.69	115.30

Continued on next page...

Continued from previous page...

Mol	Chain	Res	Type	Atoms	Z	Observed(°)	Ideal(°)
9	x	199	LEU	CA-CB-CG	5.38	127.68	115.30
2	O	393	LEU	CA-CB-CG	5.38	127.68	115.30
2	J	393	LEU	CA-CB-CG	5.37	127.64	115.30
2	K	393	LEU	CA-CB-CG	5.37	127.64	115.30
2	M	393	LEU	CA-CB-CG	5.36	127.64	115.30
2	N	393	LEU	CA-CB-CG	5.36	127.62	115.30
3	P	564	LEU	CA-CB-CG	5.28	127.44	115.30
3	T	564	LEU	CA-CB-CG	5.27	127.42	115.30
3	U	564	LEU	CA-CB-CG	5.26	127.41	115.30
3	R	564	LEU	CA-CB-CG	5.26	127.40	115.30
3	Q	564	LEU	CA-CB-CG	5.26	127.39	115.30
3	S	564	LEU	CA-CB-CG	5.25	127.37	115.30
7	o	134	LEU	CA-CB-CG	5.18	127.20	115.30
7	r	134	LEU	CA-CB-CG	5.18	127.20	115.30
7	q	134	LEU	CA-CB-CG	5.17	127.19	115.30
7	n	134	LEU	CA-CB-CG	5.17	127.19	115.30
7	p	134	LEU	CA-CB-CG	5.17	127.18	115.30
7	s	134	LEU	CA-CB-CG	5.15	127.15	115.30
3	P	867	ASP	CB-CG-OD2	5.15	122.93	118.30
3	U	867	ASP	CB-CG-OD2	5.11	122.90	118.30
3	T	867	ASP	CB-CG-OD2	5.11	122.90	118.30
3	Q	867	ASP	CB-CG-OD2	5.08	122.87	118.30
3	R	867	ASP	CB-CG-OD2	5.08	122.87	118.30
3	S	867	ASP	CB-CG-OD2	5.04	122.83	118.30

There are no chirality outliers.

All (42) planarity outliers are listed below:

Mol	Chain	Res	Type	Group
3	P	332	VAL	Peptide
3	P	348	ARG	Peptide
3	P	470	VAL	Peptide
3	P	794	LEU	Peptide
3	P	796	PHE	Peptide
3	P	799	SER	Peptide
3	Q	332	VAL	Peptide
3	Q	348	ARG	Peptide
3	Q	470	VAL	Peptide
3	Q	794	LEU	Peptide
3	Q	796	PHE	Peptide
3	Q	799	SER	Peptide
3	R	332	VAL	Peptide

Continued on next page...

Continued from previous page...

Mol	Chain	Res	Type	Group
3	R	348	ARG	Peptide
3	R	470	VAL	Peptide
3	R	794	LEU	Peptide
3	R	796	PHE	Peptide
3	R	799	SER	Peptide
3	S	332	VAL	Peptide
3	S	348	ARG	Peptide
3	S	470	VAL	Peptide
3	S	794	LEU	Peptide
3	S	796	PHE	Peptide
3	S	799	SER	Peptide
3	T	332	VAL	Peptide
3	T	348	ARG	Peptide
3	T	470	VAL	Peptide
3	T	794	LEU	Peptide
3	T	796	PHE	Peptide
3	T	799	SER	Peptide
3	U	332	VAL	Peptide
3	U	348	ARG	Peptide
3	U	470	VAL	Peptide
3	U	794	LEU	Peptide
3	U	796	PHE	Peptide
3	U	799	SER	Peptide
7	n	148	LEU	Mainchain
7	o	148	LEU	Mainchain
7	p	148	LEU	Mainchain
7	q	148	LEU	Mainchain
7	r	148	LEU	Mainchain
7	s	148	LEU	Mainchain

5.2 Too-close contacts [\(i\)](#)

In the following table, the Non-H and H(model) columns list the number of non-hydrogen atoms and hydrogen atoms in the chain respectively. The H(added) column lists the number of hydrogen atoms added and optimized by MolProbity. The Clashes column lists the number of clashes within the asymmetric unit, whereas Symm-Clashes lists symmetry-related clashes.

Mol	Chain	Non-H	H(model)	H(added)	Clashes	Symm-Clashes
1	D	1022	0	987	13	0
1	E	1022	0	987	14	0
1	F	1022	0	987	12	0
1	G	1022	0	987	16	0

Continued on next page...

Continued from previous page...

Mol	Chain	Non-H	H(model)	H(added)	Clashes	Symm-Clashes
1	H	1022	0	987	16	0
1	I	1022	0	987	8	0
2	J	4858	0	4735	70	0
2	K	4858	0	4735	70	0
2	L	4858	0	4735	71	0
2	M	4858	0	4735	70	0
2	N	4858	0	4735	75	0
2	O	4858	0	4735	70	0
3	P	6064	0	5649	81	0
3	Q	6064	0	5649	82	0
3	R	6064	0	5649	77	0
3	S	6064	0	5649	84	0
3	T	6064	0	5649	82	0
3	U	6064	0	5649	80	0
4	V	3100	0	3068	32	0
4	W	3100	0	3068	27	0
4	X	3100	0	3068	29	0
4	Y	3100	0	3068	27	0
4	Z	3100	0	3068	27	0
4	a	3100	0	3068	0	0
5	b	1736	0	1753	0	0
5	c	1736	0	1753	0	0
5	d	1736	0	1753	0	0
5	e	1736	0	1753	0	0
5	f	1736	0	1753	0	0
5	g	1736	0	1753	0	0
6	h	2746	0	2686	0	0
6	i	2746	0	2686	0	0
6	j	2746	0	2686	0	0
6	k	2746	0	2686	0	0
6	l	2746	0	2686	0	0
6	m	2746	0	2686	0	0
7	n	1195	0	1188	0	0
7	o	1195	0	1188	0	0
7	p	1195	0	1188	0	0
7	q	1195	0	1188	0	0
7	r	1195	0	1188	0	0
7	s	1195	0	1188	0	0
8	1	1153	0	1133	15	0
8	2	1153	0	1133	16	0
8	3	1153	0	1133	14	0
8	4	1153	0	1133	15	0

Continued on next page...

Continued from previous page...

Mol	Chain	Non-H	H(model)	H(added)	Clashes	Symm-Clashes
8	5	1153	0	1133	15	0
8	z	1153	0	1133	0	0
9	t	3107	0	3099	0	0
9	u	3107	0	3099	0	0
9	v	3107	0	3099	0	0
9	w	3107	0	3099	0	0
9	x	3107	0	3099	0	0
9	y	3107	0	3099	0	0
All	All	149886	0	145788	1079	0

The all-atom clashscore is defined as the number of clashes found per 1000 atoms (including hydrogen atoms). The all-atom clashscore for this structure is 6.

All (1079) close contacts within the same asymmetric unit are listed below, sorted by their clash magnitude.

Atom-1	Atom-2	Interatomic distance (Å)	Clash overlap (Å)
2:K:524:HIS:HD2	2:K:526:ASN:H	1.43	0.66
3:Q:353:ASP:N	3:Q:353:ASP:OD1	2.29	0.66
3:U:353:ASP:OD1	3:U:353:ASP:N	2.29	0.66
2:J:524:HIS:HD2	2:J:526:ASN:H	1.43	0.66
3:R:353:ASP:OD1	3:R:353:ASP:N	2.29	0.66
2:L:524:HIS:HD2	2:L:526:ASN:H	1.43	0.66
3:S:353:ASP:OD1	3:S:353:ASP:N	2.29	0.65
2:O:524:HIS:HD2	2:O:526:ASN:H	1.43	0.65
2:N:524:HIS:HD2	2:N:526:ASN:H	1.43	0.65
3:P:353:ASP:OD1	3:P:353:ASP:N	2.29	0.65
2:K:130:MET:HG3	2:K:496:VAL:HG12	1.80	0.64
2:M:524:HIS:HD2	2:M:526:ASN:H	1.43	0.64
3:T:353:ASP:N	3:T:353:ASP:OD1	2.29	0.64
2:J:130:MET:HG3	2:J:496:VAL:HG12	1.80	0.63
2:O:4:ASN:O	2:O:8:ASN:ND2	2.32	0.63
3:U:59:LEU:HD21	3:U:450:GLY:HA3	1.81	0.63
2:O:130:MET:HG3	2:O:496:VAL:HG12	1.80	0.63
2:K:4:ASN:O	2:K:8:ASN:ND2	2.32	0.63
2:N:4:ASN:O	2:N:8:ASN:ND2	2.32	0.63
2:N:130:MET:HG3	2:N:496:VAL:HG12	1.80	0.63
2:M:4:ASN:O	2:M:8:ASN:ND2	2.32	0.62
3:P:59:LEU:HD21	3:P:450:GLY:HA3	1.81	0.62
2:L:4:ASN:O	2:L:8:ASN:ND2	2.32	0.62
2:M:130:MET:HG3	2:M:496:VAL:HG12	1.80	0.62
2:L:130:MET:HG3	2:L:496:VAL:HG12	1.80	0.62

Continued on next page...

Continued from previous page...

Atom-1	Atom-2	Interatomic distance (Å)	Clash overlap (Å)
2:J:4:ASN:O	2:J:8:ASN:ND2	2.32	0.62
3:R:59:LEU:HD21	3:R:450:GLY:HA3	1.81	0.62
1:H:106:ASN:ND2	4:Z:301:TYR:OH	2.33	0.62
3:Q:59:LEU:HD21	3:Q:450:GLY:HA3	1.81	0.62
2:O:554:ASP:OD2	2:O:554:ASP:N	2.32	0.62
3:S:59:LEU:HD21	3:S:450:GLY:HA3	1.81	0.62
2:J:554:ASP:OD2	2:J:554:ASP:N	2.32	0.61
3:T:79:GLN:NE2	3:T:82:GLY:O	2.33	0.61
2:K:554:ASP:OD2	2:K:554:ASP:N	2.32	0.61
3:R:79:GLN:NE2	3:R:82:GLY:O	2.33	0.61
1:E:63:PHE:HE2	1:E:76:ILE:HG12	1.66	0.61
3:P:79:GLN:NE2	3:P:82:GLY:O	2.33	0.61
8:1:115:ALA:HB1	8:1:139:LEU:HD13	1.83	0.61
1:F:63:PHE:HE2	1:F:76:ILE:HG12	1.66	0.61
3:T:59:LEU:HD21	3:T:450:GLY:HA3	1.81	0.61
8:2:115:ALA:HB1	8:2:139:LEU:HD13	1.83	0.61
1:H:63:PHE:HE2	1:H:76:ILE:HG12	1.65	0.61
1:I:63:PHE:HE2	1:I:76:ILE:HG12	1.65	0.61
3:U:96:CYS:SG	3:U:553:ARG:NH1	2.74	0.61
3:P:96:CYS:SG	3:P:553:ARG:NH1	2.74	0.61
3:Q:96:CYS:SG	3:Q:553:ARG:NH1	2.74	0.60
1:G:63:PHE:HE2	1:G:76:ILE:HG12	1.66	0.60
3:T:96:CYS:SG	3:T:553:ARG:NH1	2.74	0.60
8:4:115:ALA:HB1	8:4:139:LEU:HD13	1.83	0.60
3:Q:96:CYS:SG	3:Q:97:GLY:N	2.75	0.60
3:U:79:GLN:NE2	3:U:82:GLY:O	2.33	0.60
2:M:571:PRO:HG2	2:M:584:PRO:HB2	1.84	0.60
3:P:96:CYS:SG	3:P:97:GLY:N	2.75	0.60
2:N:382:TYR:HB2	2:N:433:ARG:HB3	1.84	0.60
3:S:96:CYS:SG	3:S:553:ARG:NH1	2.74	0.60
1:D:63:PHE:HE2	1:D:76:ILE:HG12	1.65	0.60
2:O:571:PRO:HG2	2:O:584:PRO:HB2	1.84	0.60
3:P:529:THR:O	3:P:529:THR:OG1	2.20	0.60
3:U:96:CYS:SG	3:U:97:GLY:N	2.75	0.60
2:O:382:TYR:HB2	2:O:433:ARG:HB3	1.84	0.60
3:S:96:CYS:SG	3:S:97:GLY:N	2.75	0.60
2:L:382:TYR:HB2	2:L:433:ARG:HB3	1.84	0.60
2:M:218:VAL:HG11	2:M:336:PRO:HG3	1.84	0.60
2:M:382:TYR:HB2	2:M:433:ARG:HB3	1.84	0.60
2:N:218:VAL:HG11	2:N:336:PRO:HG3	1.84	0.60
3:R:96:CYS:SG	3:R:553:ARG:NH1	2.74	0.60

Continued on next page...

Continued from previous page...

Atom-1	Atom-2	Interatomic distance (Å)	Clash overlap (Å)
3:R:324:PHE:HB2	3:R:329:ILE:HB	1.84	0.60
2:L:571:PRO:HG2	2:L:584:PRO:HB2	1.84	0.60
3:R:96:CYS:SG	3:R:97:GLY:N	2.75	0.60
2:L:554:ASP:OD2	2:L:554:ASP:N	2.32	0.59
2:N:571:PRO:HG2	2:N:584:PRO:HB2	1.84	0.59
3:Q:324:PHE:HB2	3:Q:329:ILE:HB	1.84	0.59
3:R:529:THR:O	3:R:529:THR:OG1	2.20	0.59
8:5:115:ALA:HB1	8:5:139:LEU:HD13	1.83	0.59
2:K:382:TYR:HB2	2:K:433:ARG:HB3	1.84	0.59
2:K:526:ASN:ND2	3:Q:273:GLU:OE2	2.35	0.59
1:I:12:ARG:NH2	3:S:35:LEU:O	2.35	0.59
2:L:218:VAL:HG11	2:L:336:PRO:HG3	1.84	0.59
8:3:115:ALA:HB1	8:3:139:LEU:HD13	1.83	0.59
2:J:39:ILE:HD11	3:P:497:LEU:HD13	1.83	0.59
2:J:382:TYR:HB2	2:J:433:ARG:HB3	1.84	0.59
2:N:90:LEU:HD21	3:T:24:ALA:HB2	1.84	0.59
2:O:218:VAL:HG11	2:O:336:PRO:HG3	1.84	0.59
3:S:79:GLN:NE2	3:S:82:GLY:O	2.33	0.59
2:L:90:LEU:HD21	3:R:24:ALA:HB2	1.85	0.59
2:N:39:ILE:HD11	3:T:497:LEU:HD13	1.83	0.59
2:O:90:LEU:HD21	3:U:24:ALA:HB2	1.85	0.59
3:Q:255:ARG:HB3	3:Q:280:GLY:HA3	1.85	0.59
3:U:324:PHE:HB2	3:U:329:ILE:HB	1.84	0.59
3:T:96:CYS:SG	3:T:97:GLY:N	2.75	0.59
2:J:218:VAL:HG11	2:J:336:PRO:HG3	1.84	0.59
3:P:324:PHE:HB2	3:P:329:ILE:HB	1.84	0.59
2:J:571:PRO:HG2	2:J:584:PRO:HB2	1.84	0.58
2:K:218:VAL:HG11	2:K:336:PRO:HG3	1.84	0.58
2:L:39:ILE:HD11	3:R:497:LEU:HD13	1.85	0.58
3:Q:79:GLN:NE2	3:Q:82:GLY:O	2.33	0.58
2:O:39:ILE:HD11	3:U:497:LEU:HD13	1.85	0.58
3:T:324:PHE:HB2	3:T:329:ILE:HB	1.84	0.58
2:J:90:LEU:HD21	3:P:24:ALA:HB2	1.86	0.58
3:Q:202:ILE:HA	3:Q:556:ILE:HD11	1.86	0.58
3:S:255:ARG:HB3	3:S:280:GLY:HA3	1.85	0.58
3:S:324:PHE:HB2	3:S:329:ILE:HB	1.84	0.58
3:T:202:ILE:HA	3:T:556:ILE:HD11	1.86	0.58
3:P:255:ARG:HB3	3:P:280:GLY:HA3	1.85	0.58
2:J:526:ASN:ND2	3:P:273:GLU:OE2	2.37	0.58
2:K:571:PRO:HG2	2:K:584:PRO:HB2	1.84	0.57
3:U:139:GLU:HG2	3:U:142:ARG:HE	1.69	0.57

Continued on next page...

Continued from previous page...

Atom-1	Atom-2	Interatomic distance (Å)	Clash overlap (Å)
2:M:39:ILE:HD11	3:S:497:LEU:HD13	1.84	0.57
2:O:526:ASN:ND2	3:U:273:GLU:OE2	2.35	0.57
3:Q:139:GLU:HG2	3:Q:142:ARG:HE	1.69	0.57
3:R:255:ARG:HB3	3:R:280:GLY:HA3	1.85	0.57
3:S:139:GLU:HG2	3:S:142:ARG:HE	1.69	0.57
3:R:139:GLU:HG2	3:R:142:ARG:HE	1.69	0.57
3:R:826:VAL:HB	3:R:863:ILE:HG22	1.87	0.57
2:M:662:ASN:HB2	2:M:704:ALA:HB3	1.86	0.57
3:P:378:SER:OG	3:P:379:LYS:N	2.38	0.57
3:Q:826:VAL:HB	3:Q:863:ILE:HG22	1.87	0.57
3:S:202:ILE:HA	3:S:556:ILE:HD11	1.86	0.57
2:K:90:LEU:HD21	3:Q:24:ALA:HB2	1.86	0.57
2:L:526:ASN:ND2	3:R:273:GLU:OE2	2.36	0.57
3:P:826:VAL:HB	3:P:863:ILE:HG22	1.87	0.57
3:T:378:SER:OG	3:T:379:LYS:N	2.38	0.57
2:M:90:LEU:HD21	3:S:24:ALA:HB2	1.86	0.57
3:R:202:ILE:HA	3:R:556:ILE:HD11	1.86	0.57
3:S:378:SER:OG	3:S:379:LYS:N	2.38	0.57
2:K:662:ASN:HB2	2:K:704:ALA:HB3	1.86	0.57
2:M:565:GLN:HE22	2:M:606:ALA:HB1	1.70	0.57
2:N:565:GLN:HE22	2:N:606:ALA:HB1	1.70	0.57
3:Q:378:SER:OG	3:Q:379:LYS:N	2.38	0.57
3:T:255:ARG:HB3	3:T:280:GLY:HA3	1.85	0.57
3:U:202:ILE:HA	3:U:556:ILE:HD11	1.86	0.57
2:K:565:GLN:HE22	2:K:606:ALA:HB1	1.70	0.57
3:T:103:ASP:HB2	3:T:275:PRO:HD3	1.87	0.57
3:U:255:ARG:HB3	3:U:280:GLY:HA3	1.85	0.57
2:J:662:ASN:HB2	2:J:704:ALA:HB3	1.86	0.57
2:O:565:GLN:HE22	2:O:606:ALA:HB1	1.70	0.57
3:P:202:ILE:HA	3:P:556:ILE:HD11	1.86	0.57
2:L:662:ASN:HB2	2:L:704:ALA:HB3	1.86	0.57
3:S:826:VAL:HB	3:S:863:ILE:HG22	1.87	0.57
2:K:39:ILE:HD11	3:Q:497:LEU:HD13	1.86	0.56
3:Q:103:ASP:HB2	3:Q:275:PRO:HD3	1.87	0.56
2:J:565:GLN:HE22	2:J:606:ALA:HB1	1.70	0.56
2:K:137:MET:HG2	2:K:360:LYS:HE2	1.87	0.56
3:R:103:ASP:HB2	3:R:275:PRO:HD3	1.87	0.56
3:R:378:SER:OG	3:R:379:LYS:N	2.38	0.56
2:N:662:ASN:HB2	2:N:704:ALA:HB3	1.86	0.56
3:T:139:GLU:HG2	3:T:142:ARG:HE	1.69	0.56
3:U:826:VAL:HB	3:U:863:ILE:HG22	1.87	0.56

Continued on next page...

Continued from previous page...

Atom-1	Atom-2	Interatomic distance (Å)	Clash overlap (Å)
2:M:554:ASP:OD2	2:M:554:ASP:N	2.32	0.56
3:P:139:GLU:HG2	3:P:142:ARG:HE	1.69	0.56
3:T:600:PRO:HB3	3:T:888:LEU:HG	1.88	0.56
3:T:826:VAL:HB	3:T:863:ILE:HG22	1.87	0.56
8:5:112:VAL:HG22	8:5:144:VAL:HG22	1.88	0.56
3:U:103:ASP:HB2	3:U:275:PRO:HD3	1.87	0.56
8:3:112:VAL:HG22	8:3:144:VAL:HG22	1.88	0.56
3:S:103:ASP:HB2	3:S:275:PRO:HD3	1.87	0.56
8:4:112:VAL:HG22	8:4:144:VAL:HG22	1.88	0.56
3:S:600:PRO:HB3	3:S:888:LEU:HG	1.88	0.56
2:N:526:ASN:ND2	3:T:273:GLU:OE2	2.36	0.56
2:O:529:LEU:HD21	3:U:99:VAL:HG21	1.87	0.56
3:U:600:PRO:HB3	3:U:888:LEU:HG	1.88	0.56
4:V:84:ASP:OD2	4:V:98:ASN:ND2	2.38	0.56
8:1:112:VAL:HG22	8:1:144:VAL:HG22	1.88	0.56
8:2:112:VAL:HG22	8:2:144:VAL:HG22	1.88	0.56
1:E:12:ARG:NH2	3:Q:35:LEU:O	2.39	0.56
2:J:137:MET:HG2	2:J:360:LYS:HE2	1.87	0.56
2:L:565:GLN:HE22	2:L:606:ALA:HB1	1.70	0.56
2:N:137:MET:HG2	2:N:360:LYS:HE2	1.87	0.56
3:S:529:THR:O	3:S:529:THR:OG1	2.20	0.56
2:O:26:SER:OG	2:O:68:GLN:NE2	2.39	0.55
3:S:109:LEU:O	3:S:255:ARG:NH2	2.39	0.55
2:J:16:MET:HG3	2:J:100:VAL:HG23	1.88	0.55
2:L:26:SER:OG	2:L:68:GLN:NE2	2.39	0.55
2:M:137:MET:HG2	2:M:360:LYS:HE2	1.87	0.55
2:O:662:ASN:HB2	2:O:704:ALA:HB3	1.86	0.55
2:K:16:MET:HG3	2:K:100:VAL:HG23	1.88	0.55
3:P:103:ASP:HB2	3:P:275:PRO:HD3	1.87	0.55
2:O:137:MET:HG2	2:O:360:LYS:HE2	1.87	0.55
3:P:109:LEU:O	3:P:255:ARG:NH2	2.39	0.55
3:U:143:TYR:OH	3:U:600:PRO:O	2.25	0.55
1:G:12:ARG:NH2	3:U:35:LEU:O	2.40	0.55
3:Q:600:PRO:HB3	3:Q:888:LEU:HG	1.88	0.55
2:N:26:SER:OG	2:N:68:GLN:NE2	2.39	0.55
2:N:529:LEU:HD21	3:T:99:VAL:HG21	1.89	0.55
3:R:600:PRO:HB3	3:R:888:LEU:HG	1.88	0.55
3:T:813:LYS:HD2	3:T:815:GLU:H	1.72	0.55
1:E:22:LEU:HD21	2:K:47:LYS:HD3	1.89	0.55
2:M:528:SER:H	2:M:601:LYS:HB3	1.72	0.55
3:P:600:PRO:HB3	3:P:888:LEU:HG	1.88	0.55

Continued on next page...

Continued from previous page...

Atom-1	Atom-2	Interatomic distance (Å)	Clash overlap (Å)
3:T:524:ALA:H	3:T:539:GLN:HE22	1.55	0.55
3:U:378:SER:OG	3:U:379:LYS:N	2.38	0.55
3:U:813:LYS:HD2	3:U:815:GLU:H	1.72	0.55
2:J:529:LEU:HD21	3:P:99:VAL:HG21	1.89	0.55
2:L:137:MET:HG2	2:L:360:LYS:HE2	1.87	0.55
2:L:528:SER:H	2:L:601:LYS:HB3	1.72	0.55
2:M:387:HIS:HB2	2:M:389:GLN:HG2	1.90	0.55
2:J:26:SER:OG	2:J:68:GLN:NE2	2.39	0.54
2:K:471:ASP:HB3	2:K:507:ILE:HD11	1.89	0.54
2:O:16:MET:HG3	2:O:100:VAL:HG23	1.88	0.54
3:P:813:LYS:HD2	3:P:815:GLU:H	1.72	0.54
3:S:524:ALA:H	3:S:539:GLN:HE22	1.55	0.54
2:K:26:SER:OG	2:K:68:GLN:NE2	2.39	0.54
2:L:16:MET:HG3	2:L:100:VAL:HG23	1.88	0.54
3:S:813:LYS:HD2	3:S:815:GLU:H	1.72	0.54
2:J:387:HIS:HB2	2:J:389:GLN:HG2	1.89	0.54
2:K:387:HIS:HB2	2:K:389:GLN:HG2	1.90	0.54
2:K:528:SER:H	2:K:601:LYS:HB3	1.72	0.54
2:N:471:ASP:HB3	2:N:507:ILE:HD11	1.89	0.54
2:J:528:SER:H	2:J:601:LYS:HB3	1.72	0.54
2:L:387:HIS:HB2	2:L:389:GLN:HG2	1.89	0.54
2:M:526:ASN:ND2	3:S:273:GLU:OE2	2.37	0.54
2:N:528:SER:H	2:N:601:LYS:HB3	1.72	0.54
2:O:471:ASP:HB3	2:O:507:ILE:HD11	1.89	0.54
3:Q:109:LEU:O	3:Q:255:ARG:NH2	2.39	0.54
3:T:143:TYR:OH	3:T:600:PRO:O	2.25	0.54
4:W:84:ASP:OD2	4:W:98:ASN:ND2	2.38	0.54
1:F:22:LEU:HD21	2:J:47:LYS:HD3	1.90	0.54
2:K:529:LEU:HD21	3:Q:99:VAL:HG21	1.88	0.54
2:L:471:ASP:HB3	2:L:507:ILE:HD11	1.90	0.54
2:M:471:ASP:HB3	2:M:507:ILE:HD11	1.89	0.54
2:M:529:LEU:HD21	3:S:99:VAL:HG21	1.89	0.54
2:N:387:HIS:HB2	2:N:389:GLN:HG2	1.90	0.54
3:Q:120:THR:HB	3:Q:124:GLU:HG3	1.89	0.54
3:R:232:GLN:NE2	3:R:233:ASP:OD1	2.41	0.54
3:P:232:GLN:NE2	3:P:233:ASP:OD1	2.41	0.54
3:R:120:THR:HB	3:R:124:GLU:HG3	1.89	0.54
3:U:232:GLN:NE2	3:U:233:ASP:OD1	2.40	0.54
3:U:524:ALA:H	3:U:539:GLN:HE22	1.55	0.54
2:L:529:LEU:HD21	3:R:99:VAL:HG21	1.88	0.54
2:N:16:MET:HG3	2:N:100:VAL:HG23	1.88	0.54

Continued on next page...

Continued from previous page...

Atom-1	Atom-2	Interatomic distance (Å)	Clash overlap (Å)
2:O:528:SER:H	2:O:601:LYS:HB3	1.72	0.54
3:R:289:ARG:HG3	3:R:295:LEU:HD13	1.90	0.54
3:T:120:THR:HB	3:T:124:GLU:HG3	1.89	0.54
3:T:289:ARG:HG3	3:T:295:LEU:HD13	1.90	0.54
2:J:177:ARG:HG2	2:J:191:ALA:HA	1.90	0.54
2:L:177:ARG:HG2	2:L:191:ALA:HA	1.90	0.54
3:R:524:ALA:H	3:R:539:GLN:HE22	1.55	0.54
3:U:120:THR:HB	3:U:124:GLU:HG3	1.89	0.54
1:D:106:ASN:ND2	4:V:301:TYR:OH	2.40	0.54
2:J:471:ASP:HB3	2:J:507:ILE:HD11	1.89	0.54
2:O:387:HIS:HB2	2:O:389:GLN:HG2	1.90	0.54
2:M:26:SER:OG	2:M:68:GLN:NE2	2.39	0.54
3:S:120:THR:HB	3:S:124:GLU:HG3	1.89	0.54
3:S:232:GLN:NE2	3:S:233:ASP:OD1	2.41	0.54
3:S:289:ARG:HG3	3:S:295:LEU:HD13	1.90	0.54
3:T:109:LEU:O	3:T:255:ARG:NH2	2.39	0.54
2:M:177:ARG:HG2	2:M:191:ALA:HA	1.90	0.53
2:J:31:LYS:NZ	2:J:61:GLU:OE2	2.41	0.53
2:K:177:ARG:HG2	2:K:191:ALA:HA	1.90	0.53
2:M:16:MET:HG3	2:M:100:VAL:HG23	1.89	0.53
3:S:838:VAL:HG13	3:S:840:PRO:HD3	1.91	0.53
3:T:838:VAL:HG13	3:T:840:PRO:HD3	1.91	0.53
2:O:177:ARG:HG2	2:O:191:ALA:HA	1.90	0.53
1:H:100:GLN:HA	1:H:108:LEU:HA	1.91	0.53
2:N:554:ASP:OD2	2:N:554:ASP:N	2.32	0.53
3:P:120:THR:HB	3:P:124:GLU:HG3	1.89	0.53
3:Q:232:GLN:NE2	3:Q:233:ASP:OD1	2.41	0.53
3:U:838:VAL:HG13	3:U:840:PRO:HD3	1.91	0.53
3:P:524:ALA:H	3:P:539:GLN:HE22	1.55	0.53
1:D:100:GLN:HA	1:D:108:LEU:HA	1.91	0.53
2:L:173:ILE:HG12	2:L:456:TYR:HB2	1.90	0.53
3:Q:813:LYS:HD2	3:Q:815:GLU:H	1.72	0.53
3:R:813:LYS:HD2	3:R:815:GLU:H	1.72	0.53
3:R:838:VAL:HG13	3:R:840:PRO:HD3	1.91	0.53
3:U:289:ARG:HG3	3:U:295:LEU:HD13	1.90	0.53
1:I:100:GLN:HA	1:I:108:LEU:HA	1.91	0.53
3:Q:289:ARG:HG3	3:Q:295:LEU:HD13	1.90	0.53
3:Q:524:ALA:H	3:Q:539:GLN:HE22	1.55	0.53
3:T:232:GLN:NE2	3:T:233:ASP:OD1	2.41	0.53
1:G:100:GLN:HA	1:G:108:LEU:HA	1.91	0.53
3:P:838:VAL:HG13	3:P:840:PRO:HD3	1.91	0.53

Continued on next page...

Continued from previous page...

Atom-1	Atom-2	Interatomic distance (Å)	Clash overlap (Å)
3:Q:838:VAL:HG13	3:Q:840:PRO:HD3	1.91	0.53
3:R:361:GLN:OE1	3:R:376:SER:OG	2.24	0.53
1:F:100:GLN:HA	1:F:108:LEU:HA	1.91	0.53
2:N:177:ARG:HG2	2:N:191:ALA:HA	1.90	0.53
3:Q:523:ARG:NH1	3:Q:524:ALA:O	2.42	0.53
3:S:523:ARG:NH1	3:S:524:ALA:O	2.42	0.53
1:E:100:GLN:HA	1:E:108:LEU:HA	1.91	0.52
2:N:173:ILE:HG12	2:N:456:TYR:HB2	1.90	0.52
3:R:523:ARG:NH1	3:R:524:ALA:O	2.42	0.52
3:T:523:ARG:NH1	3:T:524:ALA:O	2.42	0.52
2:L:111:ARG:NH1	2:L:511:TYR:OH	2.42	0.52
2:N:31:LYS:NZ	2:N:61:GLU:OE2	2.41	0.52
2:N:111:ARG:NH1	2:N:511:TYR:OH	2.42	0.52
2:O:173:ILE:HG12	2:O:456:TYR:HB2	1.90	0.52
3:T:361:GLN:OE1	3:T:376:SER:OG	2.24	0.52
4:V:305:ARG:HH11	4:V:309:SER:HB2	1.75	0.52
4:W:305:ARG:HH11	4:W:309:SER:HB2	1.75	0.52
4:X:84:ASP:OD2	4:X:98:ASN:ND2	2.38	0.52
4:X:118:ILE:O	4:X:158:ARG:NH2	2.33	0.52
2:K:31:LYS:NZ	2:K:61:GLU:OE2	2.41	0.52
2:K:173:ILE:HG12	2:K:456:TYR:HB2	1.90	0.52
3:P:523:ARG:NH1	3:P:524:ALA:O	2.42	0.52
4:X:305:ARG:HH11	4:X:309:SER:HB2	1.75	0.52
2:M:111:ARG:NH1	2:M:511:TYR:OH	2.42	0.52
2:M:173:ILE:HG12	2:M:456:TYR:HB2	1.90	0.52
3:U:62:ARG:NH1	3:U:407:VAL:O	2.43	0.52
3:P:289:ARG:HG3	3:P:295:LEU:HD13	1.90	0.52
3:R:62:ARG:NH1	3:R:407:VAL:O	2.43	0.52
3:T:715:TYR:HB2	3:T:807:TRP:CD1	2.45	0.52
3:U:523:ARG:NH1	3:U:524:ALA:O	2.42	0.52
4:Y:305:ARG:HH11	4:Y:309:SER:HB2	1.75	0.52
4:Z:305:ARG:HH11	4:Z:309:SER:HB2	1.75	0.52
2:J:173:ILE:HG12	2:J:456:TYR:HB2	1.91	0.52
3:S:361:GLN:OE1	3:S:376:SER:OG	2.24	0.52
4:X:132:SER:O	4:X:132:SER:OG	2.28	0.52
4:Y:5:GLN:NE2	4:Z:262:SER:O	2.43	0.52
8:5:97:SER:HB3	8:5:109:THR:HG23	1.92	0.52
3:Q:62:ARG:NH1	3:Q:407:VAL:O	2.43	0.52
3:P:715:TYR:HB2	3:P:807:TRP:CD1	2.45	0.51
3:S:143:TYR:OH	3:S:600:PRO:O	2.25	0.51
3:S:715:TYR:HB2	3:S:807:TRP:CD1	2.45	0.51

Continued on next page...

Continued from previous page...

Atom-1	Atom-2	Interatomic distance (Å)	Clash overlap (Å)
3:U:109:LEU:O	3:U:255:ARG:NH2	2.39	0.51
3:U:715:TYR:HB2	3:U:807:TRP:CD1	2.45	0.51
4:W:132:SER:O	4:W:132:SER:OG	2.28	0.51
3:R:109:LEU:O	3:R:255:ARG:NH2	2.39	0.51
3:R:715:TYR:HB2	3:R:807:TRP:CD1	2.45	0.51
4:Z:84:ASP:OD2	4:Z:98:ASN:ND2	2.38	0.51
4:Z:118:ILE:O	4:Z:158:ARG:NH2	2.33	0.51
8:4:97:SER:HB3	8:4:109:THR:HG23	1.92	0.51
2:K:149:ALA:HB2	2:K:483:ILE:HA	1.93	0.51
3:P:218:PRO:HG3	3:P:323:SER:HB2	1.93	0.51
2:M:388:ASN:HD21	2:M:424:GLN:HB3	1.76	0.51
2:N:388:ASN:HD21	2:N:424:GLN:HB3	1.76	0.51
1:D:22:LEU:HD21	2:L:47:LYS:HD3	1.93	0.51
2:J:149:ALA:HB2	2:J:483:ILE:HA	1.93	0.51
2:O:388:ASN:HD21	2:O:424:GLN:HB3	1.76	0.51
1:G:22:LEU:HD21	2:O:47:LYS:HD3	1.92	0.51
2:K:111:ARG:NH1	2:K:511:TYR:OH	2.42	0.51
2:L:149:ALA:HB2	2:L:483:ILE:HA	1.93	0.51
3:Q:715:TYR:HB2	3:Q:807:TRP:CD1	2.45	0.51
2:J:388:ASN:HD21	2:J:424:GLN:HB3	1.76	0.51
2:J:684:ARG:HH11	3:Q:334:GLY:HA3	1.75	0.51
2:L:388:ASN:HD21	2:L:424:GLN:HB3	1.76	0.51
3:T:62:ARG:NH1	3:T:407:VAL:O	2.43	0.51
1:E:124:GLN:O	4:V:67:ARG:NH2	2.44	0.51
3:P:179:ARG:HG2	3:P:348:ARG:HH21	1.76	0.51
3:Q:179:ARG:HG2	3:Q:348:ARG:HH21	1.76	0.51
3:R:143:TYR:OH	3:R:600:PRO:O	2.25	0.51
2:K:388:ASN:HD21	2:K:424:GLN:HB3	1.76	0.51
2:K:522:LEU:HD22	3:Q:93:THR:HG22	1.93	0.51
3:T:218:PRO:HG3	3:T:323:SER:HB2	1.92	0.51
3:U:218:PRO:HG3	3:U:323:SER:HB2	1.93	0.51
4:Y:84:ASP:OD2	4:Y:98:ASN:ND2	2.38	0.51
2:M:149:ALA:HB2	2:M:483:ILE:HA	1.93	0.51
3:R:179:ARG:HG2	3:R:348:ARG:HH21	1.76	0.51
1:F:12:ARG:NH2	3:P:35:LEU:O	2.43	0.50
1:G:124:GLN:O	4:X:67:ARG:NH2	2.44	0.50
2:J:111:ARG:NH1	2:J:511:TYR:OH	2.42	0.50
2:O:361:PRO:HA	2:O:414:LEU:HD23	1.93	0.50
3:P:62:ARG:NH1	3:P:407:VAL:O	2.43	0.50
2:N:361:PRO:HA	2:N:414:LEU:HD23	1.93	0.50
2:O:149:ALA:HB2	2:O:483:ILE:HA	1.93	0.50

Continued on next page...

Continued from previous page...

Atom-1	Atom-2	Interatomic distance (Å)	Clash overlap (Å)
3:Q:298:ASN:OD1	3:Q:298:ASN:N	2.45	0.50
3:U:179:ARG:HG2	3:U:348:ARG:HH21	1.76	0.50
8:1:97:SER:HB3	8:1:109:THR:HG23	1.92	0.50
1:F:6:LEU:HD13	1:F:32:ALA:HB2	1.94	0.50
2:J:207:ARG:NH2	2:J:448:ALA:O	2.45	0.50
2:M:31:LYS:NZ	2:M:61:GLU:OE2	2.41	0.50
3:P:309:ILE:HB	3:P:312:ILE:HD13	1.93	0.50
3:Q:218:PRO:HG3	3:Q:323:SER:HB2	1.93	0.50
3:R:298:ASN:OD1	3:R:298:ASN:N	2.45	0.50
8:3:97:SER:HB3	8:3:109:THR:HG23	1.92	0.50
3:T:179:ARG:HG2	3:T:348:ARG:HH21	1.76	0.50
3:T:294:ARG:NH2	3:T:340:SER:O	2.41	0.50
3:T:309:ILE:HB	3:T:312:ILE:HD13	1.93	0.50
1:E:6:LEU:HD13	1:E:32:ALA:HB2	1.93	0.50
2:O:31:LYS:NZ	2:O:61:GLU:OE2	2.41	0.50
3:R:218:PRO:HG3	3:R:323:SER:HB2	1.93	0.50
3:S:179:ARG:HG2	3:S:348:ARG:HH21	1.76	0.50
2:K:207:ARG:NH2	2:K:448:ALA:O	2.45	0.50
3:R:168:ARG:HB2	3:R:821:SER:HB2	1.94	0.50
1:F:124:GLN:O	4:W:67:ARG:NH2	2.45	0.50
2:L:31:LYS:NZ	2:L:61:GLU:OE2	2.41	0.50
2:N:149:ALA:HB2	2:N:483:ILE:HA	1.93	0.50
3:T:202:ILE:HG12	3:T:859:ILE:HG13	1.94	0.50
3:T:529:THR:O	3:T:529:THR:OG1	2.20	0.50
8:2:97:SER:HB3	8:2:109:THR:HG23	1.92	0.50
1:F:38:SER:OG	1:F:88:GLU:OE2	2.28	0.50
2:M:361:PRO:HA	2:M:414:LEU:HD23	1.93	0.50
2:N:207:ARG:NH2	2:N:448:ALA:O	2.45	0.50
3:P:298:ASN:N	3:P:298:ASN:OD1	2.45	0.50
3:S:168:ARG:HB2	3:S:821:SER:HB2	1.94	0.50
3:S:309:ILE:HB	3:S:312:ILE:HD13	1.93	0.50
2:J:361:PRO:HA	2:J:414:LEU:HD23	1.93	0.50
2:N:522:LEU:HD22	3:T:93:THR:HG22	1.92	0.50
2:O:111:ARG:NH1	2:O:511:TYR:OH	2.42	0.50
3:Q:168:ARG:HB2	3:Q:821:SER:HB2	1.94	0.50
3:R:309:ILE:HB	3:R:312:ILE:HD13	1.93	0.50
3:R:527:THR:HA	3:S:370:LYS:HE3	1.94	0.50
3:S:202:ILE:HG12	3:S:859:ILE:HG13	1.94	0.50
2:J:530:THR:HA	3:P:856:PRO:HA	1.93	0.49
2:K:125:GLN:HE21	2:K:503:TRP:HE1	1.60	0.49
2:M:522:LEU:HD22	3:S:93:THR:HG22	1.94	0.49

Continued on next page...

Continued from previous page...

Atom-1	Atom-2	Interatomic distance (Å)	Clash overlap (Å)
3:U:309:ILE:HB	3:U:312:ILE:HD13	1.93	0.49
2:M:207:ARG:NH2	2:M:448:ALA:O	2.45	0.49
2:O:207:ARG:NH2	2:O:448:ALA:O	2.45	0.49
3:Q:309:ILE:HB	3:Q:312:ILE:HD13	1.93	0.49
3:S:218:PRO:HG3	3:S:323:SER:HB2	1.93	0.49
3:S:298:ASN:N	3:S:298:ASN:OD1	2.45	0.49
3:U:335:ASP:OD1	3:U:335:ASP:N	2.44	0.49
2:J:126:VAL:HG23	2:J:502:SER:H	1.78	0.49
2:K:587:ASN:OD1	2:K:590:ARG:NE	2.40	0.49
2:N:524:HIS:CD2	2:N:526:ASN:H	2.28	0.49
3:T:577:GLU:HB2	3:T:580:LYS:HE3	1.94	0.49
2:J:587:ASN:OD1	2:J:590:ARG:NE	2.40	0.49
2:L:361:PRO:HA	2:L:414:LEU:HD23	1.93	0.49
2:M:524:HIS:CD2	2:M:526:ASN:H	2.28	0.49
3:U:577:GLU:HB2	3:U:580:LYS:HE3	1.94	0.49
2:L:125:GLN:HE21	2:L:503:TRP:HE1	1.60	0.49
2:O:126:VAL:HG23	2:O:502:SER:H	1.78	0.49
3:P:168:ARG:HB2	3:P:821:SER:HB2	1.94	0.49
3:U:298:ASN:N	3:U:298:ASN:OD1	2.45	0.49
8:2:47:ASP:OD1	8:2:47:ASP:N	2.46	0.49
8:4:69:GLY:HA2	8:4:134:VAL:HA	1.94	0.49
2:L:207:ARG:NH2	2:L:448:ALA:O	2.45	0.49
2:M:530:THR:HA	3:S:856:PRO:HA	1.94	0.49
3:P:143:TYR:OH	3:P:600:PRO:O	2.25	0.49
3:Q:527:THR:HA	3:R:370:LYS:HE3	1.95	0.49
3:U:202:ILE:HG12	3:U:859:ILE:HG13	1.94	0.49
8:4:142:ASP:N	8:4:142:ASP:OD1	2.46	0.49
3:R:202:ILE:HG12	3:R:859:ILE:HG13	1.94	0.49
3:S:577:GLU:HB2	3:S:580:LYS:HE3	1.94	0.49
3:T:298:ASN:OD1	3:T:298:ASN:N	2.45	0.49
4:Y:28:VAL:HG12	4:Y:78:PHE:HB2	1.95	0.49
8:3:142:ASP:OD1	8:3:142:ASP:N	2.46	0.49
8:5:142:ASP:OD1	8:5:142:ASP:N	2.46	0.49
4:Z:28:VAL:HG12	4:Z:78:PHE:HB2	1.95	0.49
8:4:30:PHE:HD1	8:4:68:LYS:HB2	1.78	0.49
8:5:30:PHE:HD1	8:5:68:LYS:HB2	1.78	0.49
1:G:6:LEU:HD13	1:G:32:ALA:HB2	1.93	0.49
1:I:6:LEU:HD13	1:I:32:ALA:HB2	1.94	0.49
2:K:361:PRO:HA	2:K:414:LEU:HD23	1.93	0.49
2:L:522:LEU:HD22	3:R:93:THR:HG22	1.94	0.49
2:L:587:ASN:OD1	2:L:590:ARG:NE	2.40	0.49

Continued on next page...

Continued from previous page...

Atom-1	Atom-2	Interatomic distance (Å)	Clash overlap (Å)
3:P:370:LYS:HE3	3:U:527:THR:HA	1.94	0.49
4:X:340:TYR:HB2	4:X:363:ILE:HD11	1.95	0.49
2:J:125:GLN:HE21	2:J:503:TRP:HE1	1.60	0.49
2:J:522:LEU:HD22	3:P:93:THR:HG22	1.94	0.49
2:K:126:VAL:HG23	2:K:502:SER:H	1.78	0.49
3:T:168:ARG:HB2	3:T:821:SER:HB2	1.94	0.49
4:V:104:ARG:HH22	4:V:146:GLN:HG3	1.78	0.49
4:X:104:ARG:HH22	4:X:146:GLN:HG3	1.78	0.49
4:Y:340:TYR:HB2	4:Y:363:ILE:HD11	1.95	0.49
8:3:30:PHE:HD1	8:3:68:LYS:HB2	1.78	0.49
4:Z:340:TYR:HB2	4:Z:363:ILE:HD11	1.95	0.48
8:1:30:PHE:HD1	8:1:68:LYS:HB2	1.78	0.48
8:2:30:PHE:HD1	8:2:68:LYS:HB2	1.78	0.48
8:2:142:ASP:OD1	8:2:142:ASP:N	2.46	0.48
8:3:69:GLY:HA2	8:3:134:VAL:HA	1.94	0.48
1:H:6:LEU:HD13	1:H:32:ALA:HB2	1.94	0.48
2:O:522:LEU:HD22	3:U:93:THR:HG22	1.94	0.48
8:1:69:GLY:HA2	8:1:134:VAL:HA	1.94	0.48
8:2:69:GLY:HA2	8:2:134:VAL:HA	1.94	0.48
1:G:38:SER:OG	1:G:88:GLU:OE2	2.28	0.48
2:N:125:GLN:HE21	2:N:503:TRP:HE1	1.60	0.48
8:1:47:ASP:N	8:1:47:ASP:OD1	2.46	0.48
2:J:683:THR:HB	3:Q:335:ASP:HB3	1.96	0.48
2:L:530:THR:HA	3:R:856:PRO:HA	1.95	0.48
2:L:684:ARG:HH11	3:S:334:GLY:HA3	1.78	0.48
2:N:530:THR:HA	3:T:856:PRO:HA	1.94	0.48
3:Q:202:ILE:HG12	3:Q:859:ILE:HG13	1.94	0.48
3:Q:294:ARG:NH2	3:Q:340:SER:O	2.41	0.48
4:Y:104:ARG:HH22	4:Y:146:GLN:HG3	1.78	0.48
8:3:47:ASP:N	8:3:47:ASP:OD1	2.46	0.48
1:D:6:LEU:HD13	1:D:32:ALA:HB2	1.94	0.48
1:I:38:SER:OG	1:I:88:GLU:OE2	2.28	0.48
2:L:524:HIS:CD2	2:L:526:ASN:H	2.28	0.48
2:N:126:VAL:HG23	2:N:502:SER:H	1.78	0.48
3:P:202:ILE:HG12	3:P:859:ILE:HG13	1.94	0.48
3:S:62:ARG:NH1	3:S:407:VAL:O	2.43	0.48
3:U:168:ARG:HB2	3:U:821:SER:HB2	1.94	0.48
1:H:38:SER:OG	1:H:88:GLU:OE2	2.28	0.48
1:H:107:THR:HB	4:Z:395:PHE:HB2	1.96	0.48
2:K:530:THR:HA	3:Q:856:PRO:HA	1.95	0.48
2:M:125:GLN:HE21	2:M:503:TRP:HE1	1.60	0.48

Continued on next page...

Continued from previous page...

Atom-1	Atom-2	Interatomic distance (Å)	Clash overlap (Å)
2:N:381:TRP:HB3	2:N:393:LEU:HD23	1.95	0.48
4:W:118:ILE:O	4:W:158:ARG:NH2	2.33	0.48
2:J:381:TRP:HB3	2:J:393:LEU:HD23	1.95	0.48
2:M:382:TYR:HD2	2:M:433:ARG:HD3	1.79	0.48
2:N:382:TYR:HD2	2:N:433:ARG:HD3	1.79	0.48
2:N:632:GLU:O	2:N:636:TYR:N	2.45	0.48
2:O:125:GLN:HE21	2:O:503:TRP:HE1	1.60	0.48
2:O:381:TRP:HB3	2:O:393:LEU:HD23	1.95	0.48
4:W:104:ARG:HH22	4:W:146:GLN:HG3	1.78	0.48
8:5:69:GLY:HA2	8:5:134:VAL:HA	1.94	0.48
2:M:630:VAL:HG21	2:M:678:LEU:HD11	1.96	0.48
2:N:630:VAL:HG21	2:N:678:LEU:HD11	1.96	0.48
2:O:524:HIS:CD2	2:O:526:ASN:H	2.28	0.48
3:R:577:GLU:HB2	3:R:580:LYS:HE3	1.94	0.48
4:W:28:VAL:HG12	4:W:78:PHE:HB2	1.95	0.48
4:X:5:GLN:NE2	4:Y:262:SER:O	2.47	0.48
4:Z:169:ASP:OD2	4:Z:195:ARG:NE	2.47	0.48
2:L:126:VAL:HG23	2:L:502:SER:H	1.78	0.48
2:N:531:TRP:HE1	2:N:556:LEU:HD11	1.79	0.48
3:P:577:GLU:HB2	3:P:580:LYS:HE3	1.94	0.48
4:V:28:VAL:HG12	4:V:78:PHE:HB2	1.95	0.48
4:Y:30:ILE:HG22	4:Y:80:LEU:HB3	1.96	0.48
8:5:47:ASP:OD1	8:5:47:ASP:N	2.46	0.48
1:D:12:ARG:NH2	3:R:35:LEU:O	2.45	0.48
1:D:66:GLU:HG2	4:V:241:LYS:HE2	1.96	0.48
2:K:531:TRP:HE1	2:K:556:LEU:HD11	1.79	0.48
2:L:381:TRP:HB3	2:L:393:LEU:HD23	1.95	0.48
2:O:382:TYR:HD2	2:O:433:ARG:HD3	1.79	0.48
3:Q:577:GLU:HB2	3:Q:580:LYS:HE3	1.94	0.48
4:Y:169:ASP:OD2	4:Y:195:ARG:NE	2.47	0.48
4:Z:47:ASP:OD1	4:Z:47:ASP:N	4.64	0.48
3:P:294:ARG:NH2	3:P:340:SER:O	2.41	0.47
3:P:527:THR:HA	3:Q:370:LYS:HE3	1.96	0.47
3:S:294:ARG:NH2	3:S:340:SER:O	2.41	0.47
1:F:44:SER:OG	3:P:420:CYS:SG	2.72	0.47
2:L:531:TRP:HE1	2:L:556:LEU:HD11	1.79	0.47
3:T:335:ASP:OD1	3:T:335:ASP:N	2.44	0.47
4:W:340:TYR:HB2	4:W:363:ILE:HD11	1.95	0.47
4:X:28:VAL:HG12	4:X:78:PHE:HB2	1.95	0.47
2:M:126:VAL:HG23	2:M:502:SER:H	1.78	0.47
2:O:530:THR:HA	3:U:856:PRO:HA	1.95	0.47

Continued on next page...

Continued from previous page...

Atom-1	Atom-2	Interatomic distance (Å)	Clash overlap (Å)
4:W:169:ASP:OD2	4:W:195:ARG:NE	2.47	0.47
4:Z:104:ARG:HH22	4:Z:146:GLN:HG3	1.78	0.47
8:4:47:ASP:N	8:4:47:ASP:OD1	2.46	0.47
2:J:531:TRP:HE1	2:J:556:LEU:HD11	1.79	0.47
2:J:630:VAL:HG21	2:J:678:LEU:HD11	1.96	0.47
2:L:382:TYR:HD2	2:L:433:ARG:HD3	1.79	0.47
4:V:340:TYR:HB2	4:V:363:ILE:HD11	1.95	0.47
4:W:5:GLN:NE2	4:X:262:SER:O	2.48	0.47
8:1:25:ASP:OD1	8:1:25:ASP:N	2.48	0.47
8:3:25:ASP:OD1	8:3:25:ASP:N	2.48	0.47
2:K:630:VAL:HG21	2:K:678:LEU:HD11	1.96	0.47
2:M:531:TRP:HE1	2:M:556:LEU:HD11	1.79	0.47
3:Q:289:ARG:H	3:Q:289:ARG:HG2	1.53	0.47
4:V:5:GLN:NE2	4:W:262:SER:O	2.47	0.47
4:X:88:SER:O	4:X:128:ARG:NH1	2.44	0.47
4:X:236:ASP:OD1	4:X:236:ASP:N	2.42	0.47
4:Y:88:SER:O	4:Y:128:ARG:NH1	2.44	0.47
2:O:684:ARG:HH11	3:P:334:GLY:HA3	1.79	0.47
3:Q:143:TYR:OH	3:Q:600:PRO:O	2.25	0.47
3:Q:529:THR:O	3:Q:529:THR:OG1	2.20	0.47
3:R:294:ARG:NH2	3:R:340:SER:O	2.41	0.47
3:T:527:THR:HA	3:U:370:LYS:HE3	1.95	0.47
2:J:382:TYR:HD2	2:J:433:ARG:HD3	1.79	0.47
2:K:381:TRP:HB3	2:K:393:LEU:HD23	1.95	0.47
2:K:524:HIS:CD2	2:K:526:ASN:H	2.28	0.47
2:L:630:VAL:HG21	2:L:678:LEU:HD11	1.96	0.47
2:O:531:TRP:HE1	2:O:556:LEU:HD11	1.79	0.47
2:O:587:ASN:OD1	2:O:590:ARG:NE	2.40	0.47
3:P:599:LEU:HD11	3:P:820:PHE:HB3	1.97	0.47
4:X:3:ARG:H	4:X:3:ARG:HG2	1.58	0.47
8:5:25:ASP:OD1	8:5:25:ASP:N	2.48	0.47
2:K:632:GLU:O	2:K:636:TYR:N	2.45	0.47
2:M:381:TRP:HB3	2:M:393:LEU:HD23	1.95	0.47
2:N:684:ARG:HH11	3:U:334:GLY:HA3	1.80	0.47
4:Z:30:ILE:HG22	4:Z:80:LEU:HB3	1.96	0.47
2:O:630:VAL:HG21	2:O:678:LEU:HD11	1.96	0.47
3:P:522:GLN:H	3:P:522:GLN:HG3	1.55	0.47
4:V:169:ASP:OD2	4:V:195:ARG:NE	2.47	0.47
4:W:3:ARG:H	4:W:3:ARG:HG2	1.58	0.47
8:1:33:VAL:HG13	8:1:66:LEU:HB3	1.97	0.47
8:4:33:VAL:HG13	8:4:66:LEU:HB3	1.97	0.47

Continued on next page...

Continued from previous page...

Atom-1	Atom-2	Interatomic distance (Å)	Clash overlap (Å)
1:D:38:SER:OG	1:D:88:GLU:OE2	2.28	0.47
2:J:524:HIS:CD2	2:J:526:ASN:H	2.28	0.47
3:P:361:GLN:OE1	3:P:376:SER:OG	2.24	0.47
3:Q:599:LEU:HD11	3:Q:820:PHE:HB3	1.97	0.47
4:X:169:ASP:OD2	4:X:195:ARG:NE	2.47	0.47
4:Y:236:ASP:OD1	4:Y:236:ASP:N	2.42	0.47
1:H:21:SER:OG	1:H:23:GLU:O	2.27	0.46
2:K:113:LEU:HD21	3:Q:89:GLY:HA2	1.97	0.46
3:P:289:ARG:H	3:P:289:ARG:HG2	1.53	0.46
4:V:30:ILE:HG22	4:V:80:LEU:HB3	1.96	0.46
8:1:84:ILE:HB	8:1:89:VAL:HG22	1.97	0.46
8:1:142:ASP:N	8:1:142:ASP:OD1	2.46	0.46
4:Z:88:SER:O	4:Z:128:ARG:NH1	2.44	0.46
2:J:632:GLU:O	2:J:636:TYR:N	2.45	0.46
8:1:89:VAL:HG11	8:1:117:PRO:HD2	1.98	0.46
8:4:84:ILE:HB	8:4:89:VAL:HG22	1.97	0.46
1:G:106:ASN:ND2	4:Y:301:TYR:OH	2.49	0.46
2:M:587:ASN:OD1	2:M:590:ARG:NE	2.41	0.46
3:Q:196:LEU:HD13	3:Q:206:VAL:HG11	1.98	0.46
4:V:226:VAL:HA	4:V:229:VAL:HG22	1.98	0.46
8:2:89:VAL:HG11	8:2:117:PRO:HD2	1.98	0.46
3:R:327:THR:HG23	3:R:329:ILE:HG13	1.98	0.46
4:W:30:ILE:HG22	4:W:80:LEU:HB3	1.96	0.46
4:X:30:ILE:HG22	4:X:80:LEU:HB3	1.96	0.46
8:2:25:ASP:OD1	8:2:25:ASP:N	2.48	0.46
8:3:33:VAL:HG13	8:3:66:LEU:HB3	1.97	0.46
8:5:84:ILE:HB	8:5:89:VAL:HG22	1.97	0.46
1:H:111:GLN:HG3	4:Z:399:SER:HB2	1.97	0.46
2:J:668:GLN:O	2:J:672:THR:OG1	2.27	0.46
2:K:382:TYR:HD2	2:K:433:ARG:HD3	1.79	0.46
3:P:196:LEU:HD13	3:P:206:VAL:HG11	1.98	0.46
3:S:335:ASP:OD1	3:S:335:ASP:N	2.44	0.46
4:Z:226:VAL:HA	4:Z:229:VAL:HG22	1.98	0.46
8:2:33:VAL:HG13	8:2:66:LEU:HB3	1.97	0.46
2:N:367:LEU:HD13	2:N:454:LEU:HD11	1.98	0.46
3:U:327:THR:HG23	3:U:329:ILE:HG13	1.98	0.46
4:W:226:VAL:HA	4:W:229:VAL:HG22	1.98	0.46
2:L:558:ARG:HG3	2:L:559:VAL:H	1.81	0.46
8:3:63:ASN:OD1	8:3:63:ASN:N	2.49	0.46
8:3:89:VAL:HG11	8:3:117:PRO:HD2	1.98	0.46
2:O:367:LEU:HD13	2:O:454:LEU:HD11	1.98	0.46

Continued on next page...

Continued from previous page...

Atom-1	Atom-2	Interatomic distance (Å)	Clash overlap (Å)
3:P:327:THR:HG23	3:P:329:ILE:HG13	1.98	0.46
3:S:327:THR:HG23	3:S:329:ILE:HG13	1.98	0.46
4:W:58:ASP:N	4:W:58:ASP:OD1	2.49	0.46
2:J:558:ARG:HG3	2:J:559:VAL:H	1.81	0.45
2:N:558:ARG:HG3	2:N:559:VAL:H	1.81	0.45
3:R:196:LEU:HD13	3:R:206:VAL:HG11	1.98	0.45
3:T:92:ASN:HD21	3:T:548:THR:HG22	1.81	0.45
3:T:599:LEU:HD11	3:T:820:PHE:HB3	1.97	0.45
3:U:599:LEU:HD11	3:U:820:PHE:HB3	1.97	0.45
4:V:3:ARG:H	4:V:3:ARG:HG2	1.58	0.45
4:Y:226:VAL:HA	4:Y:229:VAL:HG22	1.98	0.45
8:2:84:ILE:HB	8:2:89:VAL:HG22	1.97	0.45
8:5:33:VAL:HG13	8:5:66:LEU:HB3	1.97	0.45
2:J:367:LEU:HD13	2:J:454:LEU:HD11	1.98	0.45
2:M:367:LEU:HD13	2:M:454:LEU:HD11	1.98	0.45
3:S:599:LEU:HD11	3:S:820:PHE:HB3	1.97	0.45
3:U:92:ASN:HD21	3:U:548:THR:HG22	1.82	0.45
4:V:236:ASP:OD1	4:V:236:ASP:N	2.42	0.45
3:S:821:SER:OG	3:S:822:PHE:N	2.50	0.45
3:T:327:THR:HG23	3:T:329:ILE:HG13	1.98	0.45
2:L:367:LEU:HD13	2:L:454:LEU:HD11	1.98	0.45
3:U:218:PRO:O	3:U:350:TRP:NE1	2.42	0.45
8:1:63:ASN:N	8:1:63:ASN:OD1	2.49	0.45
1:E:106:ASN:ND2	4:W:301:TYR:OH	2.48	0.45
1:G:21:SER:OG	1:G:23:GLU:O	2.27	0.45
2:K:684:ARG:HH11	3:R:334:GLY:HA3	1.81	0.45
2:M:38:LYS:HB2	2:M:38:LYS:HE3	1.84	0.45
3:R:170:ASN:ND2	3:R:207:SER:OG	2.50	0.45
3:R:821:SER:OG	3:R:822:PHE:N	2.50	0.45
4:X:226:VAL:HA	4:X:229:VAL:HG22	1.98	0.45
1:H:44:SER:OG	3:T:420:CYS:SG	2.68	0.45
2:K:367:LEU:HD13	2:K:454:LEU:HD11	1.98	0.45
2:M:65:LYS:HB3	2:M:71:ILE:HG13	1.99	0.45
2:M:632:GLU:O	2:M:636:TYR:N	2.45	0.45
2:N:163:ASP:OD1	2:N:163:ASP:N	2.50	0.45
3:Q:361:GLN:OE1	3:Q:376:SER:OG	2.24	0.45
4:X:273:ASN:HD21	4:X:289:ARG:H	1.65	0.45
4:Z:273:ASN:HD21	4:Z:289:ARG:H	1.65	0.45
2:L:683:THR:HB	3:S:335:ASP:HB3	1.98	0.45
2:N:683:THR:HB	3:U:335:ASP:HB3	1.99	0.45
2:O:558:ARG:HG3	2:O:559:VAL:H	1.81	0.45

Continued on next page...

Continued from previous page...

Atom-1	Atom-2	Interatomic distance (Å)	Clash overlap (Å)
2:O:559:VAL:HG21	3:U:860:SER:HB3	1.99	0.45
3:T:821:SER:OG	3:T:822:PHE:N	2.50	0.45
3:U:217:LEU:H	3:U:349:LEU:HA	1.82	0.45
4:V:118:ILE:O	4:V:158:ARG:NH2	2.33	0.45
4:W:30:ILE:HG13	4:W:123:VAL:HG22	1.99	0.45
8:2:63:ASN:OD1	8:2:63:ASN:N	2.49	0.45
2:L:632:GLU:O	2:L:636:TYR:N	2.45	0.45
2:N:24:ARG:HD3	2:N:29:LEU:HD13	1.99	0.45
3:P:830:SER:O	3:P:830:SER:OG	2.35	0.45
3:Q:471:TRP:HE1	3:Q:507:HIS:CE1	2.35	0.45
3:Q:713:MET:HA	3:Q:902:GLY:HA3	1.99	0.45
3:S:92:ASN:HD21	3:S:548:THR:HG22	1.81	0.45
3:S:196:LEU:HD13	3:S:206:VAL:HG11	1.98	0.45
3:U:196:LEU:HD13	3:U:206:VAL:HG11	1.98	0.45
4:W:88:SER:O	4:W:128:ARG:NH1	2.44	0.45
4:X:30:ILE:HG13	4:X:123:VAL:HG22	1.99	0.45
4:X:58:ASP:OD1	4:X:58:ASP:N	2.49	0.45
4:Z:196:LEU:HD13	4:Z:251:VAL:HG11	1.99	0.45
2:L:65:LYS:HB3	2:L:71:ILE:HG13	1.99	0.45
2:N:587:ASN:OD1	2:N:590:ARG:NE	2.40	0.45
3:P:92:ASN:HD21	3:P:548:THR:HG22	1.81	0.45
3:P:217:LEU:H	3:P:349:LEU:HA	1.82	0.45
3:Q:170:ASN:ND2	3:Q:207:SER:OG	2.50	0.45
3:R:471:TRP:HE1	3:R:507:HIS:CE1	2.35	0.45
3:R:599:LEU:HD11	3:R:820:PHE:HB3	1.97	0.45
3:S:170:ASN:ND2	3:S:207:SER:OG	2.50	0.45
3:T:170:ASN:ND2	3:T:207:SER:OG	2.50	0.45
3:U:170:ASN:ND2	3:U:207:SER:OG	2.50	0.45
4:W:196:LEU:HD13	4:W:251:VAL:HG11	1.99	0.45
4:X:196:LEU:HD13	4:X:251:VAL:HG11	1.99	0.45
8:4:89:VAL:HG11	8:4:117:PRO:HD2	1.98	0.45
2:N:65:LYS:HB3	2:N:71:ILE:HG13	1.99	0.45
2:O:59:THR:HG23	2:O:62:LYS:H	1.82	0.45
3:Q:217:LEU:H	3:Q:349:LEU:HA	1.82	0.45
3:Q:327:THR:HG23	3:Q:329:ILE:HG13	1.98	0.45
3:S:178:THR:OG1	3:S:179:ARG:N	2.50	0.45
3:S:217:LEU:H	3:S:349:LEU:HA	1.82	0.45
3:S:218:PRO:O	3:S:350:TRP:NE1	2.42	0.45
3:T:196:LEU:HD13	3:T:206:VAL:HG11	1.98	0.45
4:W:273:ASN:HD21	4:W:289:ARG:H	1.65	0.45
2:L:24:ARG:HD3	2:L:29:LEU:HD13	1.99	0.44

Continued on next page...

Continued from previous page...

Atom-1	Atom-2	Interatomic distance (Å)	Clash overlap (Å)
2:M:558:ARG:HG3	2:M:559:VAL:H	1.81	0.44
2:N:59:THR:HG23	2:N:62:LYS:H	1.83	0.44
3:P:178:THR:OG1	3:P:179:ARG:N	2.50	0.44
3:P:713:MET:HA	3:P:902:GLY:HA3	1.99	0.44
3:R:713:MET:HA	3:R:902:GLY:HA3	1.99	0.44
3:U:830:SER:O	3:U:830:SER:OG	2.35	0.44
4:V:196:LEU:HD13	4:V:251:VAL:HG11	1.99	0.44
4:Y:196:LEU:HD13	4:Y:251:VAL:HG11	1.99	0.44
4:Y:273:ASN:HD21	4:Y:289:ARG:H	1.65	0.44
8:3:84:ILE:HB	8:3:89:VAL:HG22	1.97	0.44
8:5:89:VAL:HG11	8:5:117:PRO:HD2	1.98	0.44
2:K:683:THR:HB	3:R:335:ASP:HB3	1.99	0.44
2:L:399:ASP:HA	2:L:410:TRP:HB3	2.00	0.44
2:O:24:ARG:HD3	2:O:29:LEU:HD13	1.99	0.44
2:O:683:THR:HB	3:P:335:ASP:HB3	1.99	0.44
3:P:170:ASN:ND2	3:P:207:SER:OG	2.50	0.44
3:R:217:LEU:H	3:R:349:LEU:HA	1.82	0.44
8:5:63:ASN:OD1	8:5:63:ASN:N	2.49	0.44
2:M:397:VAL:HA	2:M:412:VAL:HG22	1.99	0.44
2:O:65:LYS:HB3	2:O:71:ILE:HG13	1.99	0.44
2:O:525:ARG:NE	3:U:93:THR:O	2.51	0.44
3:S:471:TRP:HE1	3:S:507:HIS:CE1	2.35	0.44
3:U:471:TRP:HE1	3:U:507:HIS:CE1	2.35	0.44
3:U:821:SER:OG	3:U:822:PHE:N	2.50	0.44
1:D:107:THR:HB	4:V:395:PHE:HB2	1.98	0.44
1:H:66:GLU:HG2	4:Z:241:LYS:HE2	1.97	0.44
1:H:106:ASN:HA	4:Z:391:PHE:HB3	1.99	0.44
2:M:59:THR:HG23	2:M:62:LYS:H	1.82	0.44
2:M:124:ASP:OD2	2:M:502:SER:OG	2.35	0.44
2:M:399:ASP:HA	2:M:410:TRP:HB3	2.00	0.44
2:N:399:ASP:HA	2:N:410:TRP:HB3	2.00	0.44
3:R:289:ARG:H	3:R:289:ARG:HG2	1.53	0.44
3:R:830:SER:HB2	3:R:865:TRP:HD1	1.83	0.44
4:V:273:ASN:HD21	4:V:289:ARG:H	1.65	0.44
8:4:63:ASN:N	8:4:63:ASN:OD1	2.49	0.44
2:K:662:ASN:ND2	2:K:703:GLU:OE2	2.51	0.44
2:L:397:VAL:HA	2:L:412:VAL:HG22	1.99	0.44
2:O:399:ASP:HA	2:O:410:TRP:HB3	2.00	0.44
2:O:632:GLU:O	2:O:636:TYR:N	2.45	0.44
3:Q:821:SER:OG	3:Q:822:PHE:N	2.50	0.44
3:S:527:THR:HA	3:T:370:LYS:HE3	1.99	0.44

Continued on next page...

Continued from previous page...

Atom-1	Atom-2	Interatomic distance (Å)	Clash overlap (Å)
3:U:294:ARG:NH2	3:U:340:SER:O	2.41	0.44
3:U:361:GLN:OE1	3:U:376:SER:OG	2.24	0.44
1:F:106:ASN:ND2	4:X:301:TYR:OH	2.50	0.44
2:J:24:ARG:HD3	2:J:29:LEU:HD13	1.99	0.44
2:K:65:LYS:HB3	2:K:71:ILE:HG13	1.99	0.44
2:L:662:ASN:ND2	2:L:703:GLU:OE2	2.51	0.44
2:M:113:LEU:HD21	3:S:89:GLY:HA2	1.99	0.44
2:N:113:LEU:HD21	3:T:89:GLY:HA2	2.00	0.44
3:P:471:TRP:HE1	3:P:507:HIS:CE1	2.35	0.44
3:Q:178:THR:OG1	3:Q:179:ARG:N	2.50	0.44
3:S:830:SER:HB2	3:S:865:TRP:HD1	1.83	0.44
3:U:830:SER:HB2	3:U:865:TRP:HD1	1.83	0.44
4:V:30:ILE:HG13	4:V:123:VAL:HG22	1.99	0.44
2:L:568:THR:O	2:L:568:THR:OG1	2.35	0.44
3:S:713:MET:HA	3:S:902:GLY:HA3	1.99	0.44
2:J:59:THR:HG23	2:J:62:LYS:H	1.82	0.44
2:J:65:LYS:HB3	2:J:71:ILE:HG13	1.99	0.44
2:J:113:LEU:HD21	3:P:89:GLY:HA2	1.99	0.44
2:K:24:ARG:HD3	2:K:29:LEU:HD13	1.99	0.44
2:K:141:LEU:HD12	2:K:145:THR:HG21	2.00	0.44
2:K:558:ARG:HG3	2:K:559:VAL:H	1.81	0.44
2:M:24:ARG:HD3	2:M:29:LEU:HD13	1.99	0.44
2:M:141:LEU:HD12	2:M:145:THR:HG21	2.00	0.44
2:O:113:LEU:HD21	3:U:89:GLY:HA2	2.00	0.44
3:P:821:SER:OG	3:P:822:PHE:N	2.50	0.44
3:P:830:SER:HB2	3:P:865:TRP:HD1	1.83	0.44
3:T:290:ASP:OD1	3:T:290:ASP:N	2.51	0.44
3:T:471:TRP:HE1	3:T:507:HIS:CE1	2.35	0.44
3:U:713:MET:HA	3:U:902:GLY:HA3	1.99	0.44
4:V:363:ILE:HG22	4:V:385:VAL:HG22	2.00	0.44
2:J:373:SER:OG	2:J:405:TYR:O	2.36	0.44
2:J:663:SER:HB2	2:J:703:GLU:HG2	2.00	0.44
2:L:141:LEU:HD12	2:L:145:THR:HG21	2.00	0.44
2:L:525:ARG:NE	3:R:93:THR:O	2.51	0.44
2:N:141:LEU:HD12	2:N:145:THR:HG21	2.00	0.44
2:N:663:SER:HB2	2:N:703:GLU:HG2	2.00	0.44
2:O:124:ASP:OD2	2:O:502:SER:OG	2.35	0.44
3:R:121:GLN:HE21	3:R:124:GLU:HG2	1.83	0.44
3:T:303:VAL:O	3:T:307:LEU:N	2.51	0.44
8:4:25:ASP:OD1	8:4:25:ASP:N	2.48	0.44
2:J:397:VAL:HA	2:J:412:VAL:HG22	1.99	0.43

Continued on next page...

Continued from previous page...

Atom-1	Atom-2	Interatomic distance (Å)	Clash overlap (Å)
2:J:399:ASP:HA	2:J:410:TRP:HB3	2.00	0.43
2:K:399:ASP:HA	2:K:410:TRP:HB3	2.00	0.43
2:L:113:LEU:HD21	3:R:89:GLY:HA2	2.00	0.43
2:O:141:LEU:HD12	2:O:145:THR:HG21	2.00	0.43
3:P:124:GLU:H	3:P:124:GLU:HG2	1.62	0.43
3:S:303:VAL:O	3:S:307:LEU:N	2.51	0.43
3:T:217:LEU:H	3:T:349:LEU:HA	1.82	0.43
3:T:713:MET:HA	3:T:902:GLY:HA3	1.99	0.43
3:U:121:GLN:HE21	3:U:124:GLU:HG2	1.83	0.43
4:Z:30:ILE:HG13	4:Z:123:VAL:HG22	1.99	0.43
2:K:663:SER:HB2	2:K:703:GLU:HG2	2.00	0.43
2:L:668:GLN:O	2:L:672:THR:OG1	2.27	0.43
3:R:92:ASN:HD21	3:R:548:THR:HG22	1.81	0.43
3:R:178:THR:OG1	3:R:179:ARG:N	2.50	0.43
3:S:290:ASP:OD1	3:S:290:ASP:N	2.51	0.43
3:T:178:THR:OG1	3:T:179:ARG:N	2.50	0.43
3:T:218:PRO:O	3:T:350:TRP:NE1	2.42	0.43
3:U:290:ASP:N	3:U:290:ASP:OD1	2.51	0.43
4:V:58:ASP:N	4:V:58:ASP:OD1	2.49	0.43
4:Z:58:ASP:OD1	4:Z:58:ASP:N	2.49	0.43
1:E:107:THR:HB	4:W:395:PHE:HB2	2.01	0.43
2:L:663:SER:HB2	2:L:703:GLU:HG2	2.00	0.43
2:M:662:ASN:ND2	2:M:703:GLU:OE2	2.51	0.43
3:P:121:GLN:HE21	3:P:124:GLU:HG2	1.83	0.43
3:S:121:GLN:HE21	3:S:124:GLU:HG2	1.83	0.43
3:T:830:SER:HB2	3:T:865:TRP:HD1	1.83	0.43
4:W:123:VAL:HG12	4:W:125:ASP:H	1.83	0.43
1:G:66:GLU:HG2	4:Y:241:LYS:HE2	2.00	0.43
2:J:141:LEU:HD12	2:J:145:THR:HG21	2.00	0.43
2:N:397:VAL:HA	2:N:412:VAL:HG22	1.99	0.43
2:N:559:VAL:HG21	3:T:860:SER:HB3	2.00	0.43
2:O:663:SER:HB2	2:O:703:GLU:HG2	2.00	0.43
3:Q:124:GLU:H	3:Q:124:GLU:HG2	1.62	0.43
3:Q:163:LYS:HA	3:Q:163:LYS:HD2	1.73	0.43
4:Z:363:ILE:HG22	4:Z:385:VAL:HG22	2.00	0.43
8:3:30:PHE:CD1	8:3:68:LYS:HB2	2.54	0.43
2:K:373:SER:OG	2:K:405:TYR:O	2.36	0.43
2:K:568:THR:O	2:K:568:THR:OG1	2.35	0.43
2:L:124:ASP:OD2	2:L:502:SER:OG	2.35	0.43
3:T:121:GLN:HE21	3:T:124:GLU:HG2	1.83	0.43
4:Y:118:ILE:O	4:Y:158:ARG:NH2	2.33	0.43

Continued on next page...

Continued from previous page...

Atom-1	Atom-2	Interatomic distance (Å)	Clash overlap (Å)
4:Y:363:ILE:HG22	4:Y:385:VAL:HG22	2.00	0.43
8:4:30:PHE:CD1	8:4:68:LYS:HB2	2.54	0.43
1:D:4:GLN:H	1:D:4:GLN:HG3	1.65	0.43
1:E:60:LEU:HB2	4:V:8:VAL:HG21	2.01	0.43
2:J:662:ASN:ND2	2:J:703:GLU:OE2	2.51	0.43
2:L:59:THR:HG23	2:L:62:LYS:H	1.82	0.43
2:M:163:ASP:OD1	2:M:163:ASP:N	2.50	0.43
2:M:663:SER:HB2	2:M:703:GLU:HG2	2.00	0.43
3:T:163:LYS:HA	3:T:163:LYS:HD2	1.73	0.43
3:U:178:THR:OG1	3:U:179:ARG:N	2.50	0.43
4:Y:58:ASP:N	4:Y:58:ASP:OD1	2.49	0.43
1:D:17:PRO:HA	1:D:18:PRO:HD3	1.89	0.43
1:F:60:LEU:HB2	4:W:8:VAL:HG21	2.01	0.43
3:P:121:GLN:HE22	3:P:123:ASP:HB2	1.84	0.43
4:V:123:VAL:HG12	4:V:125:ASP:H	1.84	0.43
1:F:107:THR:HB	4:X:395:PHE:HB2	2.01	0.43
2:J:591:LEU:HD21	2:J:611:ARG:HA	2.01	0.43
2:K:397:VAL:HA	2:K:412:VAL:HG22	1.99	0.43
2:N:124:ASP:OD2	2:N:502:SER:OG	2.35	0.43
2:N:662:ASN:ND2	2:N:703:GLU:OE2	2.51	0.43
3:Q:121:GLN:HE21	3:Q:124:GLU:HG2	1.83	0.43
3:R:121:GLN:HE22	3:R:123:ASP:HB2	1.84	0.43
3:R:290:ASP:N	3:R:290:ASP:OD1	2.51	0.43
3:T:100:THR:HG22	3:T:102:ASP:H	1.84	0.43
4:V:88:SER:O	4:V:128:ARG:NH1	2.44	0.43
4:W:363:ILE:HG22	4:W:385:VAL:HG22	2.00	0.43
1:I:4:GLN:H	1:I:4:GLN:HG3	1.65	0.43
2:M:559:VAL:HG21	3:S:860:SER:HB3	2.01	0.43
2:O:373:SER:OG	2:O:405:TYR:O	2.36	0.43
2:O:479:PRO:O	2:O:498:GLN:NE2	2.52	0.43
2:O:591:LEU:HD21	2:O:611:ARG:HA	2.01	0.43
2:O:662:ASN:ND2	2:O:703:GLU:OE2	2.51	0.43
3:P:100:THR:HG22	3:P:102:ASP:H	1.84	0.43
3:P:290:ASP:N	3:P:290:ASP:OD1	2.51	0.43
3:Q:92:ASN:HD21	3:Q:548:THR:HG22	1.82	0.43
4:Y:30:ILE:HG13	4:Y:123:VAL:HG22	1.99	0.43
8:2:30:PHE:CD1	8:2:68:LYS:HB2	2.54	0.43
1:I:20:PHE:HE1	3:S:436:LEU:HA	1.84	0.43
2:K:163:ASP:N	2:K:163:ASP:OD1	2.50	0.43
2:K:605:TRP:CE2	3:Q:169:GLY:HA2	2.53	0.43
2:O:568:THR:O	2:O:568:THR:OG1	2.35	0.43

Continued on next page...

Continued from previous page...

Atom-1	Atom-2	Interatomic distance (Å)	Clash overlap (Å)
3:Q:830:SER:HB2	3:Q:865:TRP:HD1	1.83	0.43
3:S:100:THR:HG22	3:S:102:ASP:H	1.84	0.43
3:S:121:GLN:HE22	3:S:123:ASP:HB2	1.84	0.43
3:T:13:ASP:OD2	3:T:13:ASP:N	2.52	0.43
3:T:121:GLN:HE22	3:T:123:ASP:HB2	1.84	0.43
3:T:507:HIS:CE1	3:T:511:ILE:HD11	2.54	0.43
4:X:363:ILE:HG22	4:X:385:VAL:HG22	2.00	0.43
8:1:30:PHE:CD1	8:1:68:LYS:HB2	2.54	0.43
2:N:479:PRO:O	2:N:498:GLN:NE2	2.52	0.42
2:N:532:GLY:HA3	3:T:853:THR:HG23	2.01	0.42
3:Q:290:ASP:OD1	3:Q:290:ASP:N	2.51	0.42
3:R:507:HIS:CE1	3:R:511:ILE:HD11	2.54	0.42
3:U:303:VAL:O	3:U:307:LEU:N	2.51	0.42
4:W:236:ASP:OD1	4:W:236:ASP:N	2.42	0.42
8:2:27:LYS:HB3	8:2:27:LYS:HE3	1.89	0.42
1:G:17:PRO:HA	1:G:18:PRO:HD3	1.89	0.42
2:J:124:ASP:OD2	2:J:502:SER:OG	2.35	0.42
2:K:151:GLN:HA	2:K:157:ALA:HA	2.01	0.42
2:M:525:ARG:NE	3:S:93:THR:O	2.52	0.42
2:M:591:LEU:HD21	2:M:611:ARG:HA	2.01	0.42
2:O:397:VAL:HA	2:O:412:VAL:HG22	1.99	0.42
3:P:13:ASP:OD2	3:P:13:ASP:N	2.52	0.42
3:P:549:LEU:HD21	3:P:566:LYS:HD2	2.01	0.42
3:Q:100:THR:HG22	3:Q:102:ASP:H	1.84	0.42
3:Q:121:GLN:HE22	3:Q:123:ASP:HB2	1.84	0.42
3:T:124:GLU:HG2	3:T:124:GLU:H	1.62	0.42
3:U:121:GLN:HE22	3:U:123:ASP:HB2	1.84	0.42
3:U:507:HIS:CE1	3:U:511:ILE:HD11	2.54	0.42
4:V:132:SER:O	4:V:132:SER:OG	2.28	0.42
1:G:4:GLN:H	1:G:4:GLN:HG3	1.65	0.42
2:J:605:TRP:CE2	3:P:169:GLY:HA2	2.54	0.42
2:K:59:THR:HG23	2:K:62:LYS:H	1.83	0.42
2:N:525:ARG:NE	3:T:93:THR:O	2.52	0.42
3:S:507:HIS:CE1	3:S:511:ILE:HD11	2.54	0.42
3:U:100:THR:HG22	3:U:102:ASP:H	1.84	0.42
4:Z:123:VAL:HG12	4:Z:125:ASP:H	1.83	0.42
2:J:151:GLN:HA	2:J:157:ALA:HA	2.01	0.42
2:K:525:ARG:NE	3:Q:93:THR:O	2.52	0.42
2:L:591:LEU:HD21	2:L:611:ARG:HA	2.01	0.42
3:P:507:HIS:CE1	3:P:511:ILE:HD11	2.54	0.42
3:Q:456:MET:O	3:Q:460:LEU:N	2.51	0.42

Continued on next page...

Continued from previous page...

Atom-1	Atom-2	Interatomic distance (Å)	Clash overlap (Å)
3:R:303:VAL:O	3:R:307:LEU:N	2.51	0.42
3:U:549:LEU:HD21	3:U:566:LYS:HD2	2.01	0.42
4:W:322:TYR:HB2	4:W:325:GLU:HG3	2.01	0.42
4:X:123:VAL:HG12	4:X:125:ASP:H	1.84	0.42
2:K:151:GLN:NE2	2:K:155:GLY:O	2.45	0.42
2:K:532:GLY:HA3	3:Q:853:THR:HG23	2.02	0.42
2:L:559:VAL:HG21	3:R:860:SER:HB3	2.00	0.42
3:R:13:ASP:N	3:R:13:ASP:OD2	2.52	0.42
3:T:549:LEU:HD21	3:T:566:LYS:HD2	2.01	0.42
4:V:322:TYR:HB2	4:V:325:GLU:HG3	2.01	0.42
4:X:322:TYR:HB2	4:X:325:GLU:HG3	2.01	0.42
1:E:66:GLU:HG2	4:W:241:LYS:HE2	2.01	0.42
2:N:398:SER:O	2:N:398:SER:OG	2.37	0.42
2:N:568:THR:O	2:N:568:THR:OG1	2.35	0.42
3:Q:13:ASP:OD2	3:Q:13:ASP:N	2.52	0.42
4:Y:390:LEU:H	4:Y:390:LEU:HG	1.57	0.42
8:5:30:PHE:CD1	8:5:68:LYS:HB2	2.54	0.42
1:E:38:SER:OG	1:E:88:GLU:OE2	2.28	0.42
2:J:4:ASN:HA	2:J:7:THR:HG22	2.02	0.42
2:J:479:PRO:O	2:J:498:GLN:NE2	2.52	0.42
2:J:559:VAL:HG21	3:P:860:SER:HB3	2.01	0.42
2:K:124:ASP:OD2	2:K:502:SER:OG	2.35	0.42
3:P:108:LEU:HD23	3:P:108:LEU:HA	1.92	0.42
3:R:100:THR:HG22	3:R:102:ASP:H	1.84	0.42
3:U:13:ASP:OD2	3:U:13:ASP:N	2.52	0.42
3:U:289:ARG:H	3:U:289:ARG:HG2	1.53	0.42
2:L:4:ASN:HA	2:L:7:THR:HG22	2.02	0.42
2:L:151:GLN:HA	2:L:157:ALA:HA	2.01	0.42
2:L:373:SER:OG	2:L:405:TYR:O	2.36	0.42
2:M:43:ASN:OD1	2:M:43:ASN:N	2.53	0.42
2:N:591:LEU:HD21	2:N:611:ARG:HA	2.01	0.42
2:O:4:ASN:HA	2:O:7:THR:HG22	2.02	0.42
3:Q:507:HIS:CE1	3:Q:511:ILE:HD11	2.54	0.42
2:N:141:LEU:HA	2:N:142:PRO:HD3	1.89	0.42
3:S:13:ASP:OD2	3:S:13:ASP:N	2.52	0.42
4:Y:123:VAL:HG12	4:Y:125:ASP:H	1.84	0.42
4:Y:151:LEU:HA	4:Y:151:LEU:HD23	1.84	0.42
4:Y:298:GLN:H	4:Y:298:GLN:HG2	1.74	0.42
4:Y:322:TYR:HB2	4:Y:325:GLU:HG3	2.01	0.42
4:Z:132:SER:O	4:Z:132:SER:OG	2.28	0.42
2:K:591:LEU:HD21	2:K:611:ARG:HA	2.01	0.42

Continued on next page...

Continued from previous page...

Atom-1	Atom-2	Interatomic distance (Å)	Clash overlap (Å)
2:O:203:SER:O	2:O:203:SER:OG	2.38	0.42
1:H:22:LEU:HD21	2:N:47:LYS:HD3	2.01	0.41
2:K:4:ASN:HA	2:K:7:THR:HG22	2.02	0.41
2:L:43:ASN:OD1	2:L:43:ASN:N	2.53	0.41
2:M:4:ASN:HA	2:M:7:THR:HG22	2.02	0.41
2:M:605:TRP:CE2	3:S:169:GLY:HA2	2.55	0.41
2:N:49:TRP:NE1	3:T:438:GLN:OE1	2.49	0.41
2:N:151:GLN:HA	2:N:157:ALA:HA	2.01	0.41
2:N:373:SER:OG	2:N:405:TYR:O	2.36	0.41
3:R:124:GLU:HG2	3:R:124:GLU:H	1.62	0.41
4:V:184:ASP:OD1	4:V:184:ASP:N	2.52	0.41
1:G:123:GLN:H	1:G:123:GLN:HG2	1.66	0.41
2:J:568:THR:O	2:J:568:THR:OG1	2.35	0.41
2:N:4:ASN:HA	2:N:7:THR:HG22	2.02	0.41
2:N:130:MET:HG2	2:N:493:LEU:HD11	2.03	0.41
2:O:151:GLN:HA	2:O:157:ALA:HA	2.01	0.41
3:R:830:SER:O	3:R:830:SER:OG	2.35	0.41
2:J:130:MET:HG2	2:J:493:LEU:HD11	2.03	0.41
2:K:479:PRO:O	2:K:498:GLN:NE2	2.52	0.41
2:M:479:PRO:O	2:M:498:GLN:NE2	2.52	0.41
2:M:568:THR:O	2:M:568:THR:OG1	2.35	0.41
2:M:670:LEU:HD23	3:T:303:VAL:HG11	2.01	0.41
2:N:152:ASP:HB2	2:N:158:LEU:HD21	2.03	0.41
3:P:163:LYS:HD2	3:P:163:LYS:HA	1.73	0.41
3:P:303:VAL:O	3:P:307:LEU:N	2.51	0.41
3:R:237:ILE:HG23	3:R:312:ILE:HD11	2.03	0.41
3:R:549:LEU:HD21	3:R:566:LYS:HD2	2.01	0.41
3:T:237:ILE:HG23	3:T:312:ILE:HD11	2.03	0.41
1:G:107:THR:HB	4:Y:395:PHE:HB2	2.02	0.41
2:K:130:MET:HG2	2:K:493:LEU:HD11	2.03	0.41
2:L:479:PRO:O	2:L:498:GLN:NE2	2.52	0.41
2:L:532:GLY:HA3	3:R:853:THR:HG23	2.02	0.41
2:M:130:MET:HG2	2:M:493:LEU:HD11	2.02	0.41
2:M:152:ASP:HB2	2:M:158:LEU:HD21	2.03	0.41
2:M:532:GLY:HA3	3:S:853:THR:HG23	2.02	0.41
2:O:152:ASP:HB2	2:O:158:LEU:HD21	2.03	0.41
2:O:605:TRP:CE2	3:U:169:GLY:HA2	2.56	0.41
3:Q:303:VAL:O	3:Q:307:LEU:N	2.51	0.41
3:Q:522:GLN:H	3:Q:522:GLN:HG3	1.55	0.41
3:Q:549:LEU:HD21	3:Q:566:LYS:HD2	2.01	0.41
3:T:248:TYR:OH	3:T:298:ASN:O	2.34	0.41

Continued on next page...

Continued from previous page...

Atom-1	Atom-2	Interatomic distance (Å)	Clash overlap (Å)
4:X:151:LEU:HD23	4:X:151:LEU:HA	1.84	0.41
1:H:30:GLU:O	1:H:34:ASP:N	2.52	0.41
2:J:124:ASP:OD1	2:J:124:ASP:N	2.49	0.41
2:M:373:SER:OG	2:M:405:TYR:O	2.36	0.41
2:N:43:ASN:OD1	2:N:43:ASN:N	2.53	0.41
3:T:856:PRO:HB2	3:T:859:ILE:HB	2.03	0.41
3:U:856:PRO:HB2	3:U:859:ILE:HB	2.03	0.41
4:V:22:ILE:HD13	4:V:22:ILE:HA	1.90	0.41
8:4:4:SER:OG	8:4:5:THR:N	2.53	0.41
2:J:532:GLY:HA3	3:P:853:THR:HG23	2.01	0.41
2:L:152:ASP:HB2	2:L:158:LEU:HD21	2.03	0.41
2:L:605:TRP:CE2	3:R:169:GLY:HA2	2.55	0.41
2:O:124:ASP:HB3	2:O:505:GLY:HA3	2.03	0.41
2:O:130:MET:HG2	2:O:493:LEU:HD11	2.03	0.41
3:P:201:ASN:HB3	3:P:202:ILE:H	1.75	0.41
3:S:285:LEU:HD23	3:S:285:LEU:HA	1.92	0.41
8:5:4:SER:OG	8:5:5:THR:N	2.53	0.41
1:D:104:MET:HE3	1:D:104:MET:HB2	1.98	0.41
1:I:17:PRO:HA	1:I:18:PRO:HD3	1.89	0.41
2:J:141:LEU:HA	2:J:142:PRO:HD3	1.89	0.41
2:J:525:ARG:NE	3:P:93:THR:O	2.53	0.41
2:L:130:MET:HG2	2:L:493:LEU:HD11	2.03	0.41
2:M:684:ARG:HH11	3:T:334:GLY:HA3	1.86	0.41
2:N:598:LEU:HD12	2:N:598:LEU:HA	1.91	0.41
2:N:605:TRP:CE2	3:T:169:GLY:HA2	2.56	0.41
3:P:856:PRO:HB2	3:P:859:ILE:HB	2.03	0.41
3:Q:856:PRO:HB2	3:Q:859:ILE:HB	2.03	0.41
3:U:251:PRO:HG3	3:U:289:ARG:HH12	1.86	0.41
8:1:4:SER:OG	8:1:5:THR:N	2.53	0.41
8:2:4:SER:OG	8:2:5:THR:N	2.53	0.41
8:4:121:THR:HB	8:4:136:GLU:HG3	2.03	0.41
1:H:12:ARG:NH2	3:T:35:LEU:O	2.52	0.41
2:K:559:VAL:HG21	3:Q:860:SER:HB3	2.02	0.41
2:M:546:PHE:H	2:M:571:PRO:HA	1.86	0.41
2:N:124:ASP:HB3	2:N:505:GLY:HA3	2.03	0.41
3:P:251:PRO:HG3	3:P:289:ARG:HH12	1.86	0.41
3:Q:251:PRO:HG3	3:Q:289:ARG:HH12	1.86	0.41
3:Q:524:ALA:H	3:Q:539:GLN:NE2	2.19	0.41
3:R:456:MET:O	3:R:460:LEU:N	2.51	0.41
3:S:549:LEU:HD21	3:S:566:LYS:HD2	2.01	0.41
3:S:830:SER:O	3:S:830:SER:OG	2.35	0.41

Continued on next page...

Continued from previous page...

Atom-1	Atom-2	Interatomic distance (Å)	Clash overlap (Å)
3:T:251:PRO:HG3	3:T:289:ARG:HH12	1.86	0.41
3:U:108:LEU:HD23	3:U:108:LEU:HA	1.92	0.41
3:U:237:ILE:HG23	3:U:312:ILE:HD11	2.03	0.41
4:Z:322:TYR:HB2	4:Z:325:GLU:HG3	2.01	0.41
8:1:121:THR:HB	8:1:136:GLU:HG3	2.03	0.41
2:K:152:ASP:HB2	2:K:158:LEU:HD21	2.03	0.41
2:K:598:LEU:HD12	2:K:598:LEU:HA	1.91	0.41
2:M:683:THR:HB	3:T:335:ASP:HB3	2.02	0.41
3:P:524:ALA:H	3:P:539:GLN:NE2	2.19	0.41
3:S:456:MET:O	3:S:460:LEU:N	2.51	0.41
3:S:460:LEU:HD23	3:S:460:LEU:HA	1.92	0.41
3:U:163:LYS:HA	3:U:163:LYS:HD2	1.73	0.41
4:V:151:LEU:HD23	4:V:151:LEU:HA	1.83	0.41
4:X:28:VAL:HG13	4:X:118:ILE:HG12	2.03	0.41
4:Z:151:LEU:HA	4:Z:151:LEU:HD23	1.84	0.41
1:G:98:VAL:HG22	1:G:110:VAL:HG13	2.03	0.41
2:N:38:LYS:HB2	2:N:38:LYS:HE3	1.84	0.41
3:P:60:ALA:HA	3:P:63:HIS:HD2	1.86	0.41
3:Q:97:GLY:HA2	3:Q:98:PRO:HD3	1.91	0.41
3:R:251:PRO:HG3	3:R:289:ARG:HH12	1.86	0.41
3:S:60:ALA:HA	3:S:63:HIS:HD2	1.86	0.41
3:S:251:PRO:HG3	3:S:289:ARG:HH12	1.86	0.41
3:U:60:ALA:HA	3:U:63:HIS:HD2	1.87	0.41
4:V:47:ASP:N	4:V:51:GLU:OE2	2.46	0.41
8:3:4:SER:OG	8:3:5:THR:N	2.53	0.41
1:H:98:VAL:HG22	1:H:110:VAL:HG13	2.03	0.40
2:L:546:PHE:H	2:L:571:PRO:HA	1.86	0.40
2:M:151:GLN:HA	2:M:157:ALA:HA	2.01	0.40
2:N:546:PHE:H	2:N:571:PRO:HA	1.86	0.40
2:O:532:GLY:HA3	3:U:853:THR:HG23	2.02	0.40
3:Q:60:ALA:HA	3:Q:63:HIS:HD2	1.86	0.40
3:Q:427:LEU:HD12	3:Q:427:LEU:HA	1.97	0.40
3:Q:498:LEU:HD23	3:Q:498:LEU:HA	1.91	0.40
3:S:237:ILE:HG23	3:S:312:ILE:HD11	2.03	0.40
3:U:124:GLU:HG2	3:U:124:GLU:H	1.62	0.40
3:U:522:GLN:H	3:U:522:GLN:HG3	1.55	0.40
1:D:111:GLN:HG3	4:V:399:SER:HB2	2.03	0.40
1:E:123:GLN:H	1:E:123:GLN:HG2	1.66	0.40
1:F:66:GLU:HG2	4:X:241:LYS:HE2	2.02	0.40
1:G:60:LEU:HB2	4:X:8:VAL:HG21	2.04	0.40
2:J:152:ASP:HB2	2:J:158:LEU:HD21	2.03	0.40

Continued on next page...

Continued from previous page...

Atom-1	Atom-2	Interatomic distance (Å)	Clash overlap (Å)
2:L:124:ASP:HB3	2:L:505:GLY:HA3	2.03	0.40
2:N:607:SER:O	2:N:607:SER:OG	2.38	0.40
3:Q:237:ILE:HG23	3:Q:312:ILE:HD11	2.03	0.40
3:R:856:PRO:HB2	3:R:859:ILE:HB	2.03	0.40
3:S:83:ILE:H	3:S:83:ILE:HG13	1.62	0.40
3:S:856:PRO:HB2	3:S:859:ILE:HB	2.03	0.40
3:T:467:GLY:N	3:T:540:GLN:HE22	2.20	0.40
3:T:498:LEU:HD23	3:T:498:LEU:HA	1.91	0.40
4:Z:28:VAL:HG13	4:Z:118:ILE:HG12	2.03	0.40
8:5:121:THR:HB	8:5:136:GLU:HG3	2.03	0.40
1:E:4:GLN:H	1:E:4:GLN:HG3	1.65	0.40
2:J:147:PHE:HA	2:J:486:PRO:HA	2.03	0.40
2:J:598:LEU:HD12	2:J:598:LEU:HA	1.90	0.40
2:L:207:ARG:HE	2:L:207:ARG:HB3	1.71	0.40
2:M:124:ASP:HB3	2:M:505:GLY:HA3	2.02	0.40
1:H:124:GLN:O	4:Y:67:ARG:NH2	2.54	0.40
2:K:538:LEU:HD23	2:K:538:LEU:HA	1.94	0.40
2:L:172:TYR:CE1	2:L:195:LEU:HD22	2.57	0.40
3:S:124:GLU:HG2	3:S:124:GLU:H	1.62	0.40
3:S:289:ARG:H	3:S:289:ARG:HG2	1.53	0.40
3:S:467:GLY:N	3:S:540:GLN:HE22	2.20	0.40
4:V:28:VAL:HG13	4:V:118:ILE:HG12	2.03	0.40
8:2:121:THR:HB	8:2:136:GLU:HG3	2.03	0.40
1:E:21:SER:OG	1:E:23:GLU:O	2.27	0.40
2:K:43:ASN:OD1	2:K:43:ASN:N	2.53	0.40
2:O:147:PHE:HA	2:O:486:PRO:HA	2.03	0.40
2:O:172:TYR:CE1	2:O:195:LEU:HD22	2.57	0.40
2:O:542:TYR:CZ	2:O:594:MET:HG2	2.57	0.40
3:R:524:ALA:H	3:R:539:GLN:NE2	2.19	0.40

There are no symmetry-related clashes.

5.3 Torsion angles [i](#)

5.3.1 Protein backbone [i](#)

In the following table, the Percentiles column shows the percent Ramachandran outliers of the chain as a percentile score with respect to all PDB entries followed by that with respect to all EM entries.

The Analysed column shows the number of residues for which the backbone conformation was analysed, and the total number of residues.

Mol	Chain	Analysed	Favoured	Allowed	Outliers	Percentiles	
1	D	125/140 (89%)	119 (95%)	6 (5%)	0	100	100
1	E	125/140 (89%)	119 (95%)	6 (5%)	0	100	100
1	F	125/140 (89%)	119 (95%)	6 (5%)	0	100	100
1	G	125/140 (89%)	119 (95%)	6 (5%)	0	100	100
1	H	125/140 (89%)	119 (95%)	6 (5%)	0	100	100
1	I	125/140 (89%)	119 (95%)	6 (5%)	0	100	100
2	J	596/728 (82%)	571 (96%)	25 (4%)	0	100	100
2	K	596/728 (82%)	571 (96%)	25 (4%)	0	100	100
2	L	596/728 (82%)	571 (96%)	25 (4%)	0	100	100
2	M	596/728 (82%)	571 (96%)	25 (4%)	0	100	100
2	N	596/728 (82%)	571 (96%)	25 (4%)	0	100	100
2	O	596/728 (82%)	571 (96%)	25 (4%)	0	100	100
3	P	770/950 (81%)	693 (90%)	74 (10%)	3 (0%)	34	72
3	Q	770/950 (81%)	693 (90%)	74 (10%)	3 (0%)	34	72
3	R	770/950 (81%)	693 (90%)	74 (10%)	3 (0%)	34	72
3	S	770/950 (81%)	693 (90%)	74 (10%)	3 (0%)	34	72
3	T	770/950 (81%)	693 (90%)	74 (10%)	3 (0%)	34	72
3	U	770/950 (81%)	693 (90%)	74 (10%)	3 (0%)	34	72
4	V	387/410 (94%)	361 (93%)	25 (6%)	1 (0%)	41	75
4	W	387/410 (94%)	361 (93%)	25 (6%)	1 (0%)	41	75
4	X	387/410 (94%)	361 (93%)	25 (6%)	1 (0%)	41	75
4	Y	387/410 (94%)	362 (94%)	24 (6%)	1 (0%)	41	75
4	Z	387/410 (94%)	362 (94%)	24 (6%)	1 (0%)	41	75
4	a	387/410 (94%)	362 (94%)	24 (6%)	1 (0%)	41	75
5	b	221/229 (96%)	210 (95%)	11 (5%)	0	100	100
5	c	221/229 (96%)	210 (95%)	11 (5%)	0	100	100
5	d	221/229 (96%)	210 (95%)	11 (5%)	0	100	100
5	e	221/229 (96%)	210 (95%)	11 (5%)	0	100	100
5	f	221/229 (96%)	210 (95%)	11 (5%)	0	100	100
5	g	221/229 (96%)	211 (96%)	10 (4%)	0	100	100
6	h	350/355 (99%)	333 (95%)	17 (5%)	0	100	100
6	i	350/355 (99%)	333 (95%)	17 (5%)	0	100	100

Continued on next page...

Continued from previous page...

Mol	Chain	Analysed	Favoured	Allowed	Outliers	Percentiles	
6	j	350/355 (99%)	333 (95%)	17 (5%)	0	100	100
6	k	350/355 (99%)	333 (95%)	17 (5%)	0	100	100
6	l	350/355 (99%)	333 (95%)	17 (5%)	0	100	100
6	m	350/355 (99%)	334 (95%)	16 (5%)	0	100	100
7	n	146/152 (96%)	137 (94%)	9 (6%)	0	100	100
7	o	146/152 (96%)	137 (94%)	9 (6%)	0	100	100
7	p	146/152 (96%)	137 (94%)	9 (6%)	0	100	100
7	q	146/152 (96%)	137 (94%)	9 (6%)	0	100	100
7	r	146/152 (96%)	137 (94%)	9 (6%)	0	100	100
7	s	146/152 (96%)	137 (94%)	9 (6%)	0	100	100
8	1	146/149 (98%)	134 (92%)	12 (8%)	0	100	100
8	2	146/149 (98%)	134 (92%)	12 (8%)	0	100	100
8	3	146/149 (98%)	134 (92%)	12 (8%)	0	100	100
8	4	146/149 (98%)	134 (92%)	12 (8%)	0	100	100
8	5	146/149 (98%)	134 (92%)	12 (8%)	0	100	100
8	z	146/149 (98%)	134 (92%)	12 (8%)	0	100	100
9	t	395/440 (90%)	368 (93%)	27 (7%)	0	100	100
9	u	395/440 (90%)	369 (93%)	26 (7%)	0	100	100
9	v	395/440 (90%)	368 (93%)	27 (7%)	0	100	100
9	w	395/440 (90%)	368 (93%)	27 (7%)	0	100	100
9	x	395/440 (90%)	368 (93%)	27 (7%)	0	100	100
9	y	395/440 (90%)	368 (93%)	27 (7%)	0	100	100
All	All	18816/21318 (88%)	17562 (93%)	1230 (6%)	24 (0%)	54	84

All (24) Ramachandran outliers are listed below:

Mol	Chain	Res	Type
3	P	795	ALA
3	Q	795	ALA
3	R	795	ALA
3	S	795	ALA
3	T	795	ALA
3	U	795	ALA
3	P	707	PRO

Continued on next page...

Continued from previous page...

Mol	Chain	Res	Type
3	Q	707	PRO
3	R	707	PRO
3	S	707	PRO
3	T	707	PRO
3	U	707	PRO
4	V	159	PRO
4	W	159	PRO
4	X	159	PRO
4	Y	159	PRO
4	Z	159	PRO
4	a	159	PRO
3	P	556	ILE
3	Q	556	ILE
3	R	556	ILE
3	S	556	ILE
3	T	556	ILE
3	U	556	ILE

5.3.2 Protein sidechains [i](#)

In the following table, the Percentiles column shows the percent sidechain outliers of the chain as a percentile score with respect to all PDB entries followed by that with respect to all EM entries.

The Analysed column shows the number of residues for which the sidechain conformation was analysed, and the total number of residues.

Mol	Chain	Analysed	Rotameric	Outliers	Percentiles	
1	D	111/122 (91%)	109 (98%)	2 (2%)	59	81
1	E	111/122 (91%)	109 (98%)	2 (2%)	59	81
1	F	111/122 (91%)	109 (98%)	2 (2%)	59	81
1	G	111/122 (91%)	109 (98%)	2 (2%)	59	81
1	H	111/122 (91%)	109 (98%)	2 (2%)	59	81
1	I	111/122 (91%)	109 (98%)	2 (2%)	59	81
2	J	531/647 (82%)	515 (97%)	16 (3%)	41	71
2	K	531/647 (82%)	515 (97%)	16 (3%)	41	71
2	L	531/647 (82%)	515 (97%)	16 (3%)	41	71
2	M	531/647 (82%)	515 (97%)	16 (3%)	41	71
2	N	531/647 (82%)	515 (97%)	16 (3%)	41	71

Continued on next page...

Continued from previous page...

Mol	Chain	Analysed	Rotameric	Outliers	Percentiles	
2	O	531/647 (82%)	515 (97%)	16 (3%)	41	71
3	P	611/827 (74%)	586 (96%)	25 (4%)	30	63
3	Q	611/827 (74%)	586 (96%)	25 (4%)	30	63
3	R	611/827 (74%)	586 (96%)	25 (4%)	30	63
3	S	611/827 (74%)	586 (96%)	25 (4%)	30	63
3	T	611/827 (74%)	586 (96%)	25 (4%)	30	63
3	U	611/827 (74%)	586 (96%)	25 (4%)	30	63
4	V	338/353 (96%)	333 (98%)	5 (2%)	65	84
4	W	338/353 (96%)	333 (98%)	5 (2%)	65	84
4	X	338/353 (96%)	333 (98%)	5 (2%)	65	84
4	Y	338/353 (96%)	333 (98%)	5 (2%)	65	84
4	Z	338/353 (96%)	333 (98%)	5 (2%)	65	84
4	a	338/353 (96%)	333 (98%)	5 (2%)	65	84
5	b	187/192 (97%)	186 (100%)	1 (0%)	88	94
5	c	187/192 (97%)	186 (100%)	1 (0%)	88	94
5	d	187/192 (97%)	186 (100%)	1 (0%)	88	94
5	e	187/192 (97%)	186 (100%)	1 (0%)	88	94
5	f	187/192 (97%)	186 (100%)	1 (0%)	88	94
5	g	187/192 (97%)	186 (100%)	1 (0%)	88	94
6	h	291/294 (99%)	281 (97%)	10 (3%)	37	68
6	i	291/294 (99%)	281 (97%)	10 (3%)	37	68
6	j	291/294 (99%)	281 (97%)	10 (3%)	37	68
6	k	291/294 (99%)	281 (97%)	10 (3%)	37	68
6	l	291/294 (99%)	281 (97%)	10 (3%)	37	68
6	m	291/294 (99%)	281 (97%)	10 (3%)	37	68
7	n	133/137 (97%)	131 (98%)	2 (2%)	65	84
7	o	133/137 (97%)	131 (98%)	2 (2%)	65	84
7	p	133/137 (97%)	131 (98%)	2 (2%)	65	84
7	q	133/137 (97%)	131 (98%)	2 (2%)	65	84
7	r	133/137 (97%)	131 (98%)	2 (2%)	65	84
7	s	133/137 (97%)	131 (98%)	2 (2%)	65	84

Continued on next page...

Continued from previous page...

Mol	Chain	Analysed	Rotameric	Outliers	Percentiles	
8	1	133/134 (99%)	131 (98%)	2 (2%)	65	84
8	2	133/134 (99%)	131 (98%)	2 (2%)	65	84
8	3	133/134 (99%)	131 (98%)	2 (2%)	65	84
8	4	133/134 (99%)	131 (98%)	2 (2%)	65	84
8	5	133/134 (99%)	131 (98%)	2 (2%)	65	84
8	z	133/134 (99%)	131 (98%)	2 (2%)	65	84
9	t	332/372 (89%)	323 (97%)	9 (3%)	44	73
9	u	332/372 (89%)	323 (97%)	9 (3%)	44	73
9	v	332/372 (89%)	323 (97%)	9 (3%)	44	73
9	w	332/372 (89%)	323 (97%)	9 (3%)	44	73
9	x	332/372 (89%)	323 (97%)	9 (3%)	44	73
9	y	332/372 (89%)	323 (97%)	9 (3%)	44	73
All	All	16002/18468 (87%)	15570 (97%)	432 (3%)	48	73

All (432) residues with a non-rotameric sidechain are listed below:

Mol	Chain	Res	Type
1	D	44	SER
1	D	104	MET
1	E	44	SER
1	E	104	MET
1	F	44	SER
1	F	104	MET
1	G	44	SER
1	G	104	MET
1	H	44	SER
1	H	104	MET
1	I	44	SER
1	I	104	MET
2	J	3	LEU
2	J	5	GLU
2	J	13	LEU
2	J	190	SER
2	J	223	LEU
2	J	341	SER
2	J	427	VAL
2	J	536	THR
2	J	548	VAL

Continued on next page...

Continued from previous page...

Mol	Chain	Res	Type
2	J	554	ASP
2	J	580	ASP
2	J	596	ASP
2	J	610	VAL
2	J	654	GLU
2	J	656	ARG
2	J	701	SER
2	K	3	LEU
2	K	5	GLU
2	K	13	LEU
2	K	190	SER
2	K	223	LEU
2	K	341	SER
2	K	427	VAL
2	K	536	THR
2	K	548	VAL
2	K	554	ASP
2	K	580	ASP
2	K	596	ASP
2	K	610	VAL
2	K	654	GLU
2	K	656	ARG
2	K	701	SER
2	L	3	LEU
2	L	5	GLU
2	L	13	LEU
2	L	190	SER
2	L	223	LEU
2	L	341	SER
2	L	427	VAL
2	L	536	THR
2	L	548	VAL
2	L	554	ASP
2	L	580	ASP
2	L	596	ASP
2	L	610	VAL
2	L	654	GLU
2	L	656	ARG
2	L	701	SER
2	M	3	LEU
2	M	5	GLU
2	M	13	LEU

Continued on next page...

Continued from previous page...

Mol	Chain	Res	Type
2	M	190	SER
2	M	223	LEU
2	M	341	SER
2	M	427	VAL
2	M	536	THR
2	M	548	VAL
2	M	554	ASP
2	M	580	ASP
2	M	596	ASP
2	M	610	VAL
2	M	654	GLU
2	M	656	ARG
2	M	701	SER
2	N	3	LEU
2	N	5	GLU
2	N	13	LEU
2	N	190	SER
2	N	223	LEU
2	N	341	SER
2	N	427	VAL
2	N	536	THR
2	N	548	VAL
2	N	554	ASP
2	N	580	ASP
2	N	596	ASP
2	N	610	VAL
2	N	654	GLU
2	N	656	ARG
2	N	701	SER
2	O	3	LEU
2	O	5	GLU
2	O	13	LEU
2	O	190	SER
2	O	223	LEU
2	O	341	SER
2	O	427	VAL
2	O	536	THR
2	O	548	VAL
2	O	554	ASP
2	O	580	ASP
2	O	596	ASP
2	O	610	VAL

Continued on next page...

Continued from previous page...

Mol	Chain	Res	Type
2	O	654	GLU
2	O	656	ARG
2	O	701	SER
3	P	13	ASP
3	P	99	VAL
3	P	124	GLU
3	P	144	THR
3	P	166	THR
3	P	220	LEU
3	P	233	ASP
3	P	258	THR
3	P	298	ASN
3	P	308	GLU
3	P	322	ASP
3	P	353	ASP
3	P	392	ILE
3	P	428	SER
3	P	444	GLU
3	P	522	GLN
3	P	529	THR
3	P	554	SER
3	P	556	ILE
3	P	564	LEU
3	P	812	GLU
3	P	813	LYS
3	P	849	GLU
3	P	859	ILE
3	P	900	THR
3	Q	13	ASP
3	Q	99	VAL
3	Q	124	GLU
3	Q	144	THR
3	Q	166	THR
3	Q	220	LEU
3	Q	233	ASP
3	Q	258	THR
3	Q	298	ASN
3	Q	308	GLU
3	Q	322	ASP
3	Q	353	ASP
3	Q	392	ILE
3	Q	428	SER

Continued on next page...

Continued from previous page...

Mol	Chain	Res	Type
3	Q	444	GLU
3	Q	522	GLN
3	Q	529	THR
3	Q	554	SER
3	Q	556	ILE
3	Q	564	LEU
3	Q	812	GLU
3	Q	813	LYS
3	Q	849	GLU
3	Q	859	ILE
3	Q	900	THR
3	R	13	ASP
3	R	99	VAL
3	R	124	GLU
3	R	144	THR
3	R	166	THR
3	R	220	LEU
3	R	233	ASP
3	R	258	THR
3	R	298	ASN
3	R	308	GLU
3	R	322	ASP
3	R	353	ASP
3	R	392	ILE
3	R	428	SER
3	R	444	GLU
3	R	522	GLN
3	R	529	THR
3	R	554	SER
3	R	556	ILE
3	R	564	LEU
3	R	812	GLU
3	R	813	LYS
3	R	849	GLU
3	R	859	ILE
3	R	900	THR
3	S	13	ASP
3	S	99	VAL
3	S	124	GLU
3	S	144	THR
3	S	166	THR
3	S	220	LEU

Continued on next page...

Continued from previous page...

Mol	Chain	Res	Type
3	S	233	ASP
3	S	258	THR
3	S	298	ASN
3	S	308	GLU
3	S	322	ASP
3	S	353	ASP
3	S	392	ILE
3	S	428	SER
3	S	444	GLU
3	S	522	GLN
3	S	529	THR
3	S	554	SER
3	S	556	ILE
3	S	564	LEU
3	S	812	GLU
3	S	813	LYS
3	S	849	GLU
3	S	859	ILE
3	S	900	THR
3	T	13	ASP
3	T	99	VAL
3	T	124	GLU
3	T	144	THR
3	T	166	THR
3	T	220	LEU
3	T	233	ASP
3	T	258	THR
3	T	298	ASN
3	T	308	GLU
3	T	322	ASP
3	T	353	ASP
3	T	392	ILE
3	T	428	SER
3	T	444	GLU
3	T	522	GLN
3	T	529	THR
3	T	554	SER
3	T	556	ILE
3	T	564	LEU
3	T	812	GLU
3	T	813	LYS
3	T	849	GLU

Continued on next page...

Continued from previous page...

Mol	Chain	Res	Type
3	T	859	ILE
3	T	900	THR
3	U	13	ASP
3	U	99	VAL
3	U	124	GLU
3	U	144	THR
3	U	166	THR
3	U	220	LEU
3	U	233	ASP
3	U	258	THR
3	U	298	ASN
3	U	308	GLU
3	U	322	ASP
3	U	353	ASP
3	U	392	ILE
3	U	428	SER
3	U	444	GLU
3	U	522	GLN
3	U	529	THR
3	U	554	SER
3	U	556	ILE
3	U	564	LEU
3	U	812	GLU
3	U	813	LYS
3	U	849	GLU
3	U	859	ILE
3	U	900	THR
4	V	172	GLU
4	V	221	SER
4	V	249	SER
4	V	390	LEU
4	V	406	THR
4	W	172	GLU
4	W	221	SER
4	W	249	SER
4	W	390	LEU
4	W	406	THR
4	X	172	GLU
4	X	221	SER
4	X	249	SER
4	X	390	LEU
4	X	406	THR

Continued on next page...

Continued from previous page...

Mol	Chain	Res	Type
4	Y	172	GLU
4	Y	221	SER
4	Y	249	SER
4	Y	390	LEU
4	Y	406	THR
4	Z	172	GLU
4	Z	221	SER
4	Z	249	SER
4	Z	390	LEU
4	Z	406	THR
4	a	172	GLU
4	a	221	SER
4	a	249	SER
4	a	390	LEU
4	a	406	THR
5	b	131	SER
5	c	131	SER
5	d	131	SER
5	e	131	SER
5	f	131	SER
5	g	131	SER
6	h	72	VAL
6	h	110	ASP
6	h	151	THR
6	h	183	VAL
6	h	211	GLU
6	h	250	VAL
6	h	281	GLU
6	h	307	ASP
6	h	320	THR
6	h	322	GLU
6	i	72	VAL
6	i	110	ASP
6	i	151	THR
6	i	183	VAL
6	i	211	GLU
6	i	250	VAL
6	i	281	GLU
6	i	307	ASP
6	i	320	THR
6	i	322	GLU
6	j	72	VAL

Continued on next page...

Continued from previous page...

Mol	Chain	Res	Type
6	j	110	ASP
6	j	151	THR
6	j	183	VAL
6	j	211	GLU
6	j	250	VAL
6	j	281	GLU
6	j	307	ASP
6	j	320	THR
6	j	322	GLU
6	k	72	VAL
6	k	110	ASP
6	k	151	THR
6	k	183	VAL
6	k	211	GLU
6	k	250	VAL
6	k	281	GLU
6	k	307	ASP
6	k	320	THR
6	k	322	GLU
6	l	72	VAL
6	l	110	ASP
6	l	151	THR
6	l	183	VAL
6	l	211	GLU
6	l	250	VAL
6	l	281	GLU
6	l	307	ASP
6	l	320	THR
6	l	322	GLU
6	m	72	VAL
6	m	110	ASP
6	m	151	THR
6	m	183	VAL
6	m	211	GLU
6	m	250	VAL
6	m	281	GLU
6	m	307	ASP
6	m	320	THR
6	m	322	GLU
7	n	90	LYS
7	n	105	SER
7	o	90	LYS

Continued on next page...

Continued from previous page...

Mol	Chain	Res	Type
7	o	105	SER
7	p	90	LYS
7	p	105	SER
7	q	90	LYS
7	q	105	SER
7	r	90	LYS
7	r	105	SER
7	s	90	LYS
7	s	105	SER
8	1	66	LEU
8	1	131	ASP
8	2	66	LEU
8	2	131	ASP
8	3	66	LEU
8	3	131	ASP
8	4	66	LEU
8	4	131	ASP
8	5	66	LEU
8	5	131	ASP
9	t	46	VAL
9	t	180	SER
9	t	199	LEU
9	t	228	ASP
9	t	235	GLU
9	t	268	THR
9	t	390	ARG
9	t	392	GLU
9	t	397	VAL
9	u	46	VAL
9	u	180	SER
9	u	199	LEU
9	u	228	ASP
9	u	235	GLU
9	u	268	THR
9	u	390	ARG
9	u	392	GLU
9	u	397	VAL
9	v	46	VAL
9	v	180	SER
9	v	199	LEU
9	v	228	ASP
9	v	235	GLU

Continued on next page...

Continued from previous page...

Mol	Chain	Res	Type
9	v	268	THR
9	v	390	ARG
9	v	392	GLU
9	v	397	VAL
9	w	46	VAL
9	w	180	SER
9	w	199	LEU
9	w	228	ASP
9	w	235	GLU
9	w	268	THR
9	w	390	ARG
9	w	392	GLU
9	w	397	VAL
9	x	46	VAL
9	x	180	SER
9	x	199	LEU
9	x	228	ASP
9	x	235	GLU
9	x	268	THR
9	x	390	ARG
9	x	392	GLU
9	x	397	VAL
9	y	46	VAL
9	y	180	SER
9	y	199	LEU
9	y	228	ASP
9	y	235	GLU
9	y	268	THR
9	y	390	ARG
9	y	392	GLU
9	y	397	VAL
8	z	66	LEU
8	z	131	ASP

Sometimes sidechains can be flipped to improve hydrogen bonding and reduce clashes. All (245) such sidechains are listed below:

Mol	Chain	Res	Type
1	D	67	ASN
1	D	124	GLN
1	E	67	ASN
1	E	124	GLN
1	F	67	ASN

Continued on next page...

Continued from previous page...

Mol	Chain	Res	Type
1	F	124	GLN
1	G	67	ASN
1	G	124	GLN
1	H	67	ASN
1	H	124	GLN
1	I	67	ASN
1	I	124	GLN
2	J	58	ASN
2	J	81	GLN
2	J	125	GLN
2	J	169	ASN
2	J	498	GLN
2	J	521	ASN
2	J	524	HIS
2	J	553	ASN
2	J	688	HIS
2	K	125	GLN
2	K	498	GLN
2	K	521	ASN
2	K	524	HIS
2	K	553	ASN
2	K	688	HIS
2	L	58	ASN
2	L	81	GLN
2	L	125	GLN
2	L	169	ASN
2	L	498	GLN
2	L	521	ASN
2	L	524	HIS
2	L	553	ASN
2	L	688	HIS
2	M	125	GLN
2	M	169	ASN
2	M	498	GLN
2	M	521	ASN
2	M	524	HIS
2	M	553	ASN
2	M	688	HIS
2	N	125	GLN
2	N	169	ASN
2	N	498	GLN
2	N	521	ASN

Continued on next page...

Continued from previous page...

Mol	Chain	Res	Type
2	N	524	HIS
2	N	553	ASN
2	N	688	HIS
2	O	58	ASN
2	O	81	GLN
2	O	125	GLN
2	O	169	ASN
2	O	498	GLN
2	O	521	ASN
2	O	524	HIS
2	O	553	ASN
2	O	688	HIS
3	P	63	HIS
3	P	121	GLN
3	P	182	GLN
3	P	268	ASN
3	P	445	GLN
3	P	464	GLN
3	P	507	HIS
3	P	539	GLN
3	P	540	GLN
3	P	565	GLN
3	P	883	ASN
3	Q	63	HIS
3	Q	121	GLN
3	Q	182	GLN
3	Q	268	ASN
3	Q	445	GLN
3	Q	464	GLN
3	Q	507	HIS
3	Q	539	GLN
3	Q	540	GLN
3	Q	565	GLN
3	Q	883	ASN
3	R	63	HIS
3	R	121	GLN
3	R	182	GLN
3	R	268	ASN
3	R	445	GLN
3	R	464	GLN
3	R	507	HIS
3	R	539	GLN

Continued on next page...

Continued from previous page...

Mol	Chain	Res	Type
3	R	540	GLN
3	R	565	GLN
3	R	883	ASN
3	S	63	HIS
3	S	121	GLN
3	S	182	GLN
3	S	268	ASN
3	S	445	GLN
3	S	464	GLN
3	S	507	HIS
3	S	539	GLN
3	S	540	GLN
3	S	565	GLN
3	S	883	ASN
3	T	63	HIS
3	T	121	GLN
3	T	182	GLN
3	T	268	ASN
3	T	445	GLN
3	T	464	GLN
3	T	507	HIS
3	T	539	GLN
3	T	540	GLN
3	T	565	GLN
3	T	883	ASN
3	U	63	HIS
3	U	121	GLN
3	U	268	ASN
3	U	445	GLN
3	U	464	GLN
3	U	507	HIS
3	U	539	GLN
3	U	540	GLN
3	U	565	GLN
3	U	883	ASN
4	V	5	GLN
4	V	68	HIS
4	V	266	ASN
4	V	273	ASN
4	V	341	ASN
4	V	403	ASN
4	W	5	GLN

Continued on next page...

Continued from previous page...

Mol	Chain	Res	Type
4	W	68	HIS
4	W	266	ASN
4	W	273	ASN
4	W	341	ASN
4	W	403	ASN
4	X	5	GLN
4	X	68	HIS
4	X	266	ASN
4	X	273	ASN
4	X	403	ASN
4	Y	5	GLN
4	Y	68	HIS
4	Y	266	ASN
4	Y	273	ASN
4	Y	341	ASN
4	Y	403	ASN
4	Z	5	GLN
4	Z	68	HIS
4	Z	266	ASN
4	Z	273	ASN
4	Z	341	ASN
4	Z	403	ASN
4	a	5	GLN
4	a	68	HIS
4	a	266	ASN
4	a	273	ASN
4	a	403	ASN
5	b	29	GLN
5	c	29	GLN
5	d	29	GLN
5	e	29	GLN
5	f	29	GLN
5	g	29	GLN
6	h	16	ASN
6	h	24	ASN
6	i	16	ASN
6	i	24	ASN
6	i	217	ASN
6	j	16	ASN
6	j	24	ASN
6	j	217	ASN
6	k	16	ASN

Continued on next page...

Continued from previous page...

Mol	Chain	Res	Type
6	k	24	ASN
6	l	16	ASN
6	l	24	ASN
6	l	217	ASN
6	m	16	ASN
6	m	24	ASN
7	n	54	ASN
7	n	62	GLN
7	n	143	GLN
7	o	54	ASN
7	o	62	GLN
7	o	143	GLN
7	p	54	ASN
7	p	62	GLN
7	p	143	GLN
7	q	54	ASN
7	q	62	GLN
7	q	143	GLN
7	r	54	ASN
7	r	62	GLN
7	r	143	GLN
7	s	54	ASN
7	s	62	GLN
7	s	143	GLN
8	1	114	ASN
8	1	130	ASN
8	1	147	GLN
8	2	114	ASN
8	2	130	ASN
8	2	147	GLN
8	3	114	ASN
8	3	130	ASN
8	3	147	GLN
8	4	114	ASN
8	4	130	ASN
8	4	147	GLN
8	5	114	ASN
8	5	130	ASN
8	5	147	GLN
9	t	163	ASN
9	t	184	ASN
9	t	280	ASN

Continued on next page...

Continued from previous page...

Mol	Chain	Res	Type
9	t	298	GLN
9	t	307	ASN
9	u	163	ASN
9	u	184	ASN
9	u	280	ASN
9	u	298	GLN
9	u	307	ASN
9	v	163	ASN
9	v	184	ASN
9	v	280	ASN
9	v	298	GLN
9	v	307	ASN
9	w	163	ASN
9	w	184	ASN
9	w	280	ASN
9	w	298	GLN
9	w	307	ASN
9	x	163	ASN
9	x	184	ASN
9	x	280	ASN
9	x	298	GLN
9	x	307	ASN
9	y	163	ASN
9	y	184	ASN
9	y	280	ASN
9	y	298	GLN
9	y	307	ASN
8	z	114	ASN
8	z	130	ASN
8	z	147	GLN

5.3.3 RNA [i](#)

There are no RNA molecules in this entry.

5.4 Non-standard residues in protein, DNA, RNA chains [i](#)

There are no non-standard protein/DNA/RNA residues in this entry.

5.5 Carbohydrates [i](#)

There are no monosaccharides in this entry.

5.6 Ligand geometry [i](#)

There are no ligands in this entry.

5.7 Other polymers [i](#)

There are no such residues in this entry.

5.8 Polymer linkage issues [i](#)

There are no chain breaks in this entry.

6 Map visualisation [i](#)

This section contains visualisations of the EMDB entry EMD-9765. These allow visual inspection of the internal detail of the map and identification of artifacts.

No raw map or half-maps were deposited for this entry and therefore no images, graphs, etc. pertaining to the raw map can be shown.

6.1 Orthogonal projections [i](#)

6.1.1 Primary map

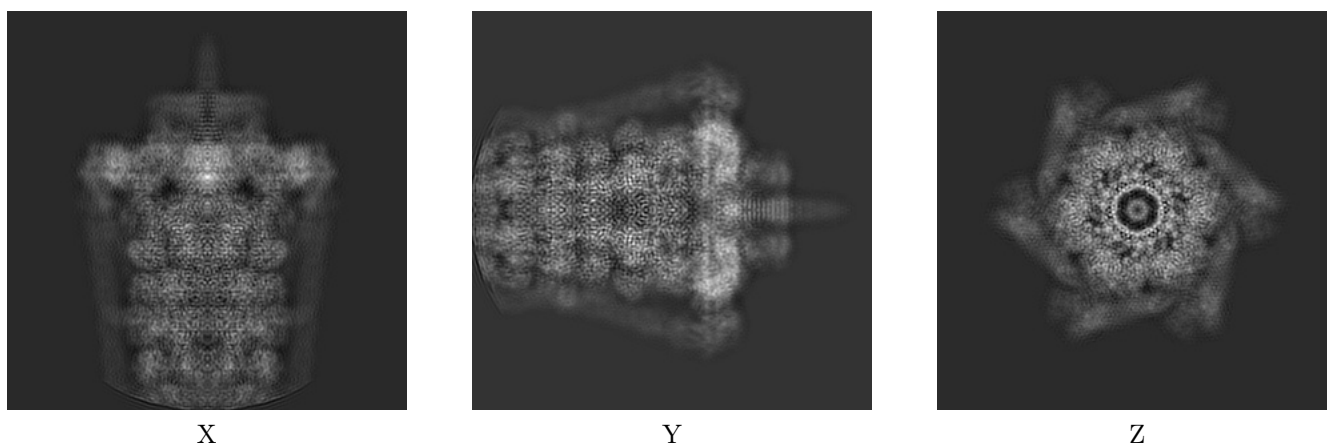

The images above show the map projected in three orthogonal directions.

6.2 Central slices [i](#)

6.2.1 Primary map

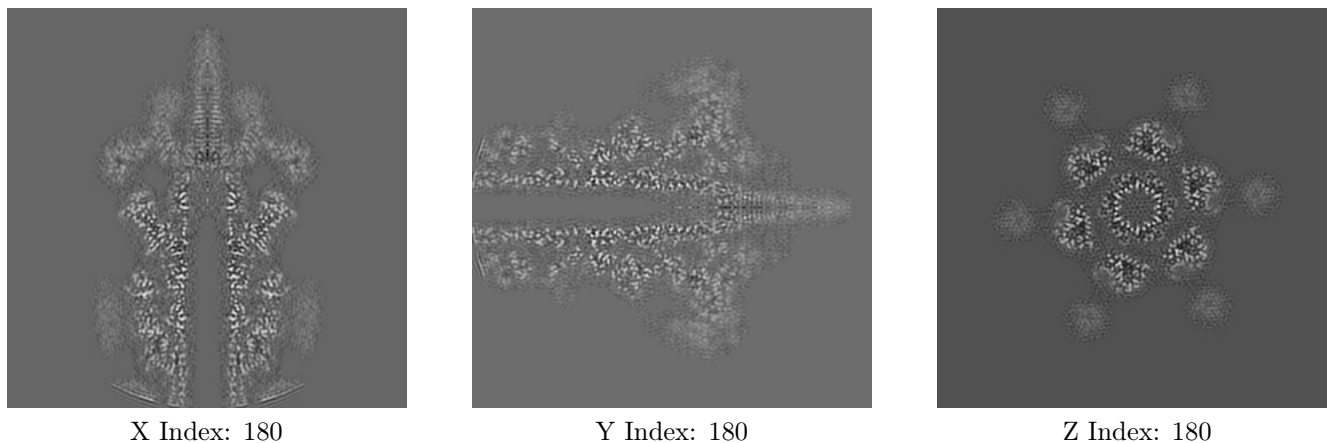

The images above show central slices of the map in three orthogonal directions.

6.3 Largest variance slices [i](#)

6.3.1 Primary map

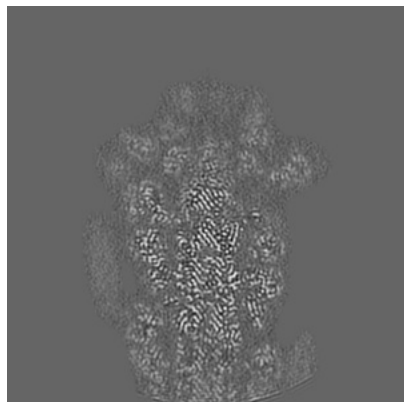

X Index: 160

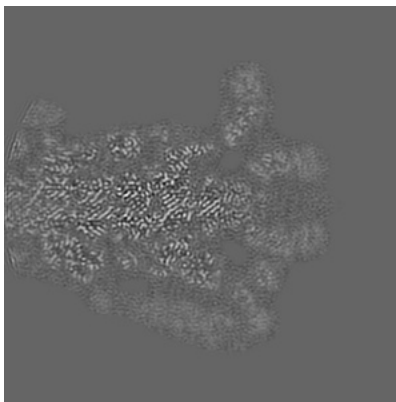

Y Index: 160

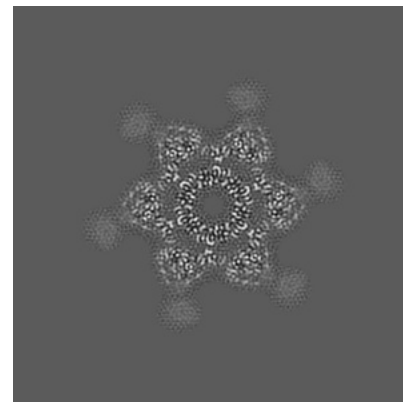

Z Index: 145

The images above show the largest variance slices of the map in three orthogonal directions.

6.4 Orthogonal standard-deviation projections (False-color) [i](#)

6.4.1 Primary map

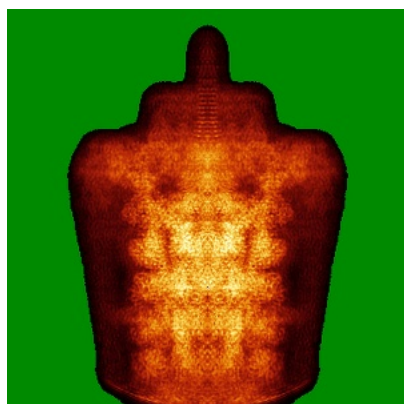

X

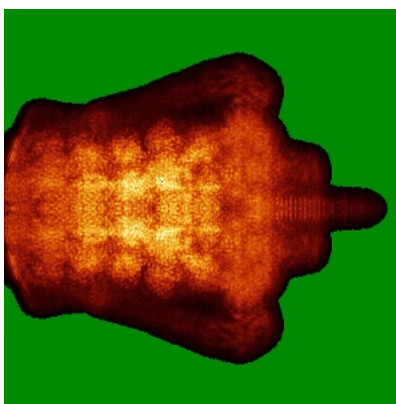

Y

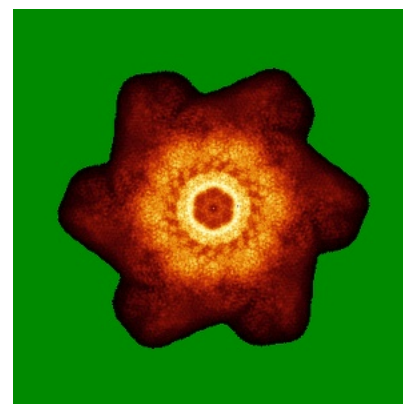

Z

The images above show the map standard deviation projections with false color in three orthogonal directions. Minimum values are shown in green, max in blue, and dark to light orange shades represent small to large values respectively.

6.5 Orthogonal surface views [i](#)

6.5.1 Primary map

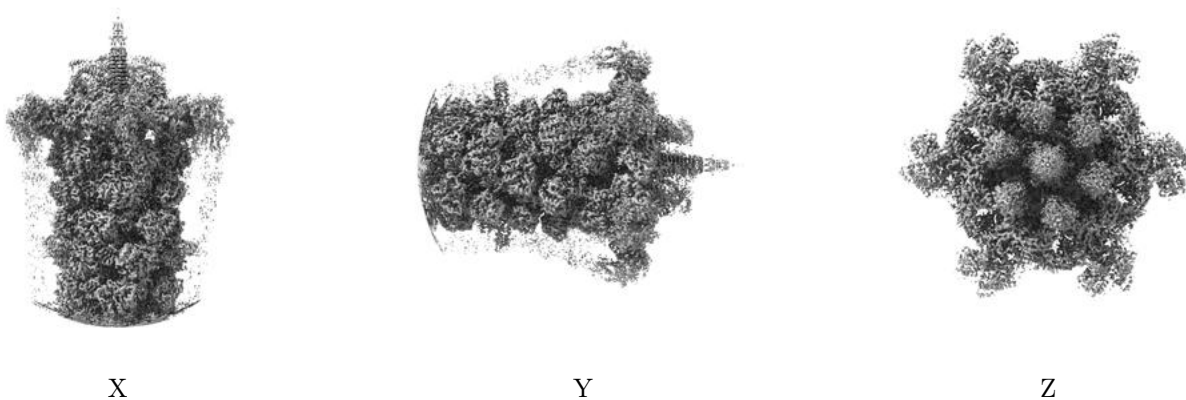

The images above show the 3D surface view of the map at the recommended contour level 0.12. These images, in conjunction with the slice images, may facilitate assessment of whether an appropriate contour level has been provided.

6.6 Mask visualisation [i](#)

This section was not generated. No masks/segmentation were deposited.

7 Map analysis [i](#)

This section contains the results of statistical analysis of the map.

7.1 Map-value distribution [i](#)

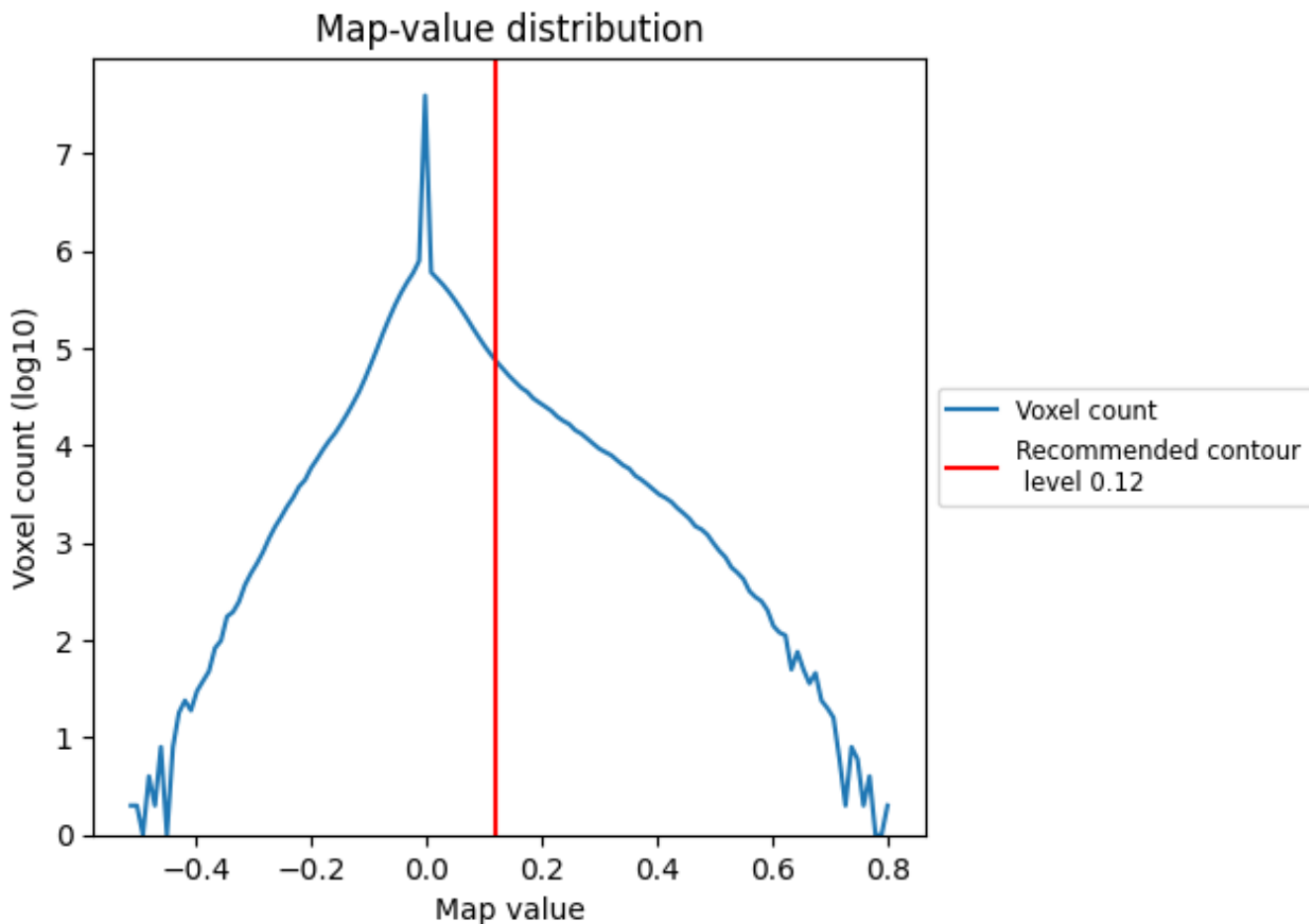

The map-value distribution is plotted in 128 intervals along the x-axis. The y-axis is logarithmic. A spike in this graph at zero usually indicates that the volume has been masked.

7.2 Volume estimate [i](#)

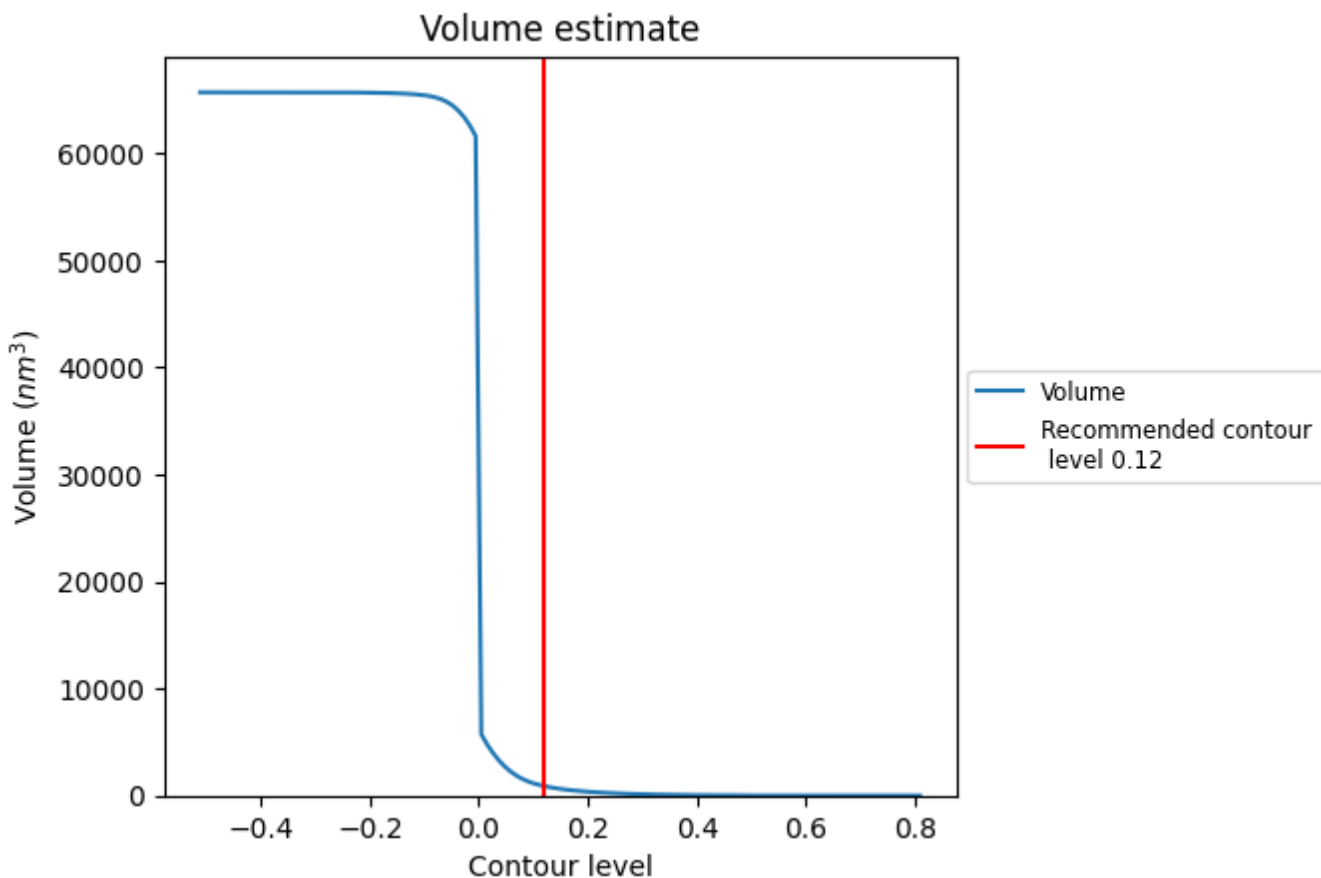

The volume at the recommended contour level is 885 nm³; this corresponds to an approximate mass of 799 kDa.

The volume estimate graph shows how the enclosed volume varies with the contour level. The recommended contour level is shown as a vertical line and the intersection between the line and the curve gives the volume of the enclosed surface at the given level.

7.3 Rotationally averaged power spectrum [i](#)

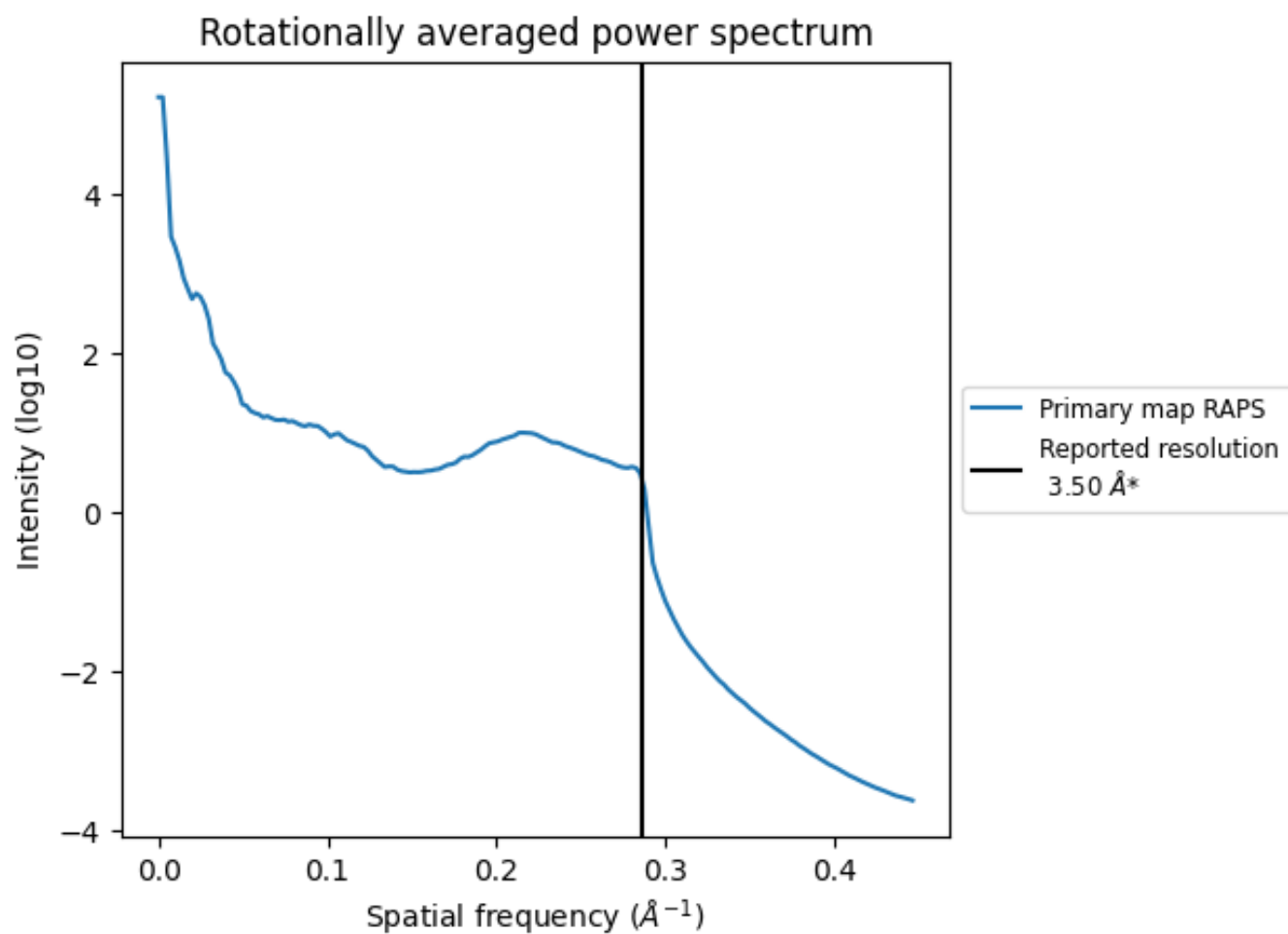

*Reported resolution corresponds to spatial frequency of 0.286\AA^{-1}

8 Fourier-Shell correlation

This section was not generated. No FSC curve or half-maps provided.

9 Map-model fit [i](#)

This section contains information regarding the fit between EMDB map EMD-9765 and PDB model 6J0N. Per-residue inclusion information can be found in section 3 on page 9.

9.1 Map-model overlay [i](#)

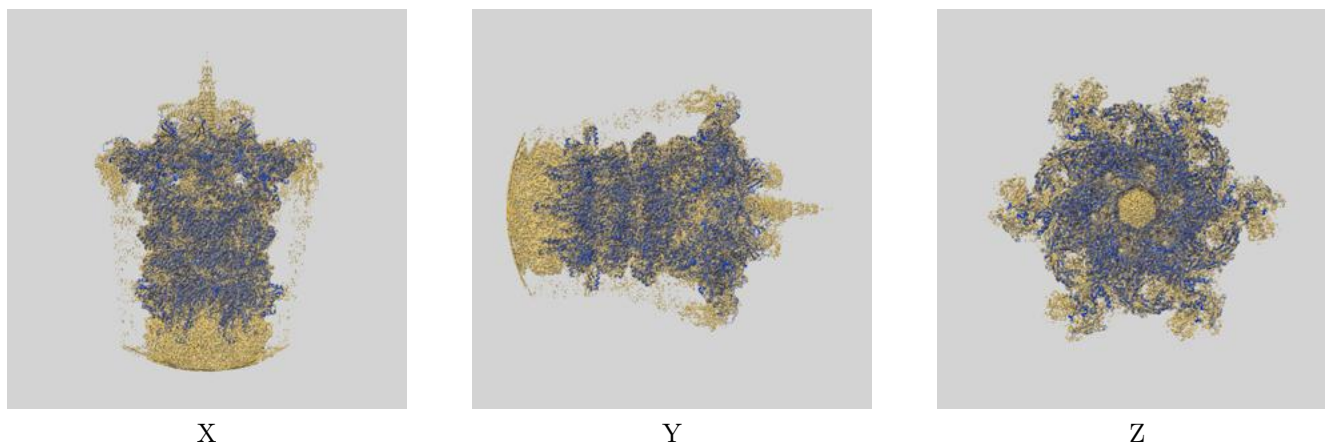

The images above show the 3D surface view of the map at the recommended contour level 0.12 at 50% transparency in yellow overlaid with a ribbon representation of the model coloured in blue. These images allow for the visual assessment of the quality of fit between the atomic model and the map.

9.2 Q-score mapped to coordinate model [i](#)

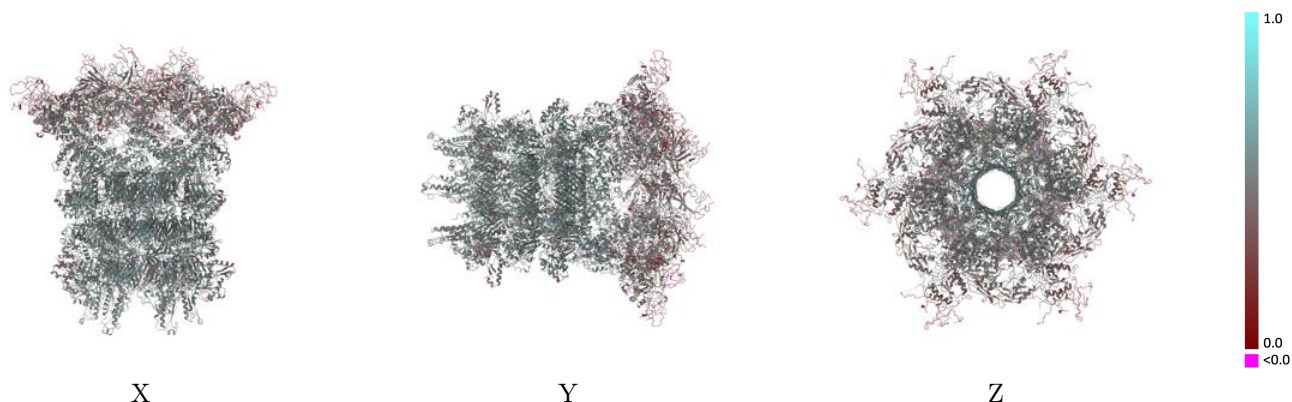

The images above show the model with each residue coloured according to its Q-score. This shows their resolvability in the map with higher Q-score values reflecting better resolvability. Please note: Q-score is calculating the resolvability of atoms, and thus high values are only expected at resolutions at which atoms can be resolved. Low Q-score values may therefore be expected for many entries.

9.3 Atom inclusion mapped to coordinate model [i](#)

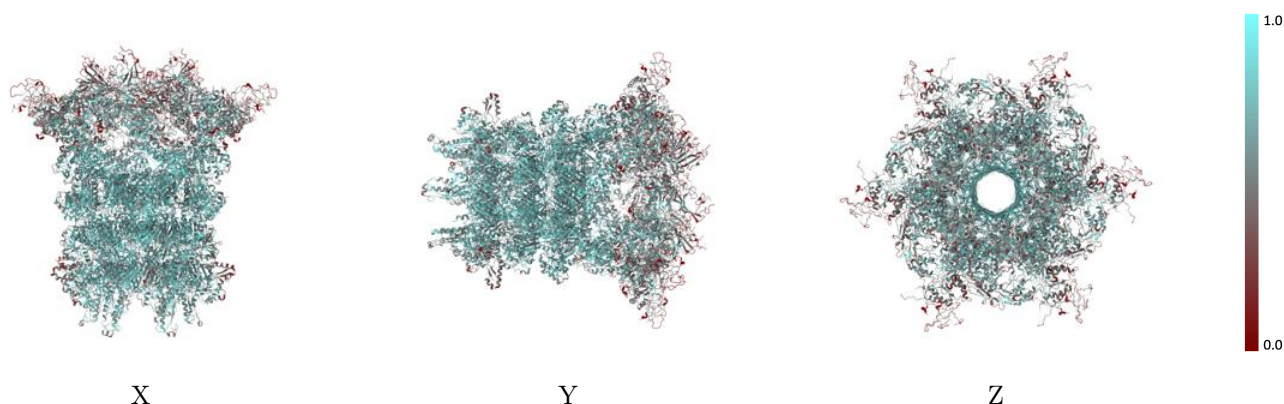

The images above show the model with each residue coloured according to its atom inclusion. This shows to what extent they are inside the map at the recommended contour level (0.12).



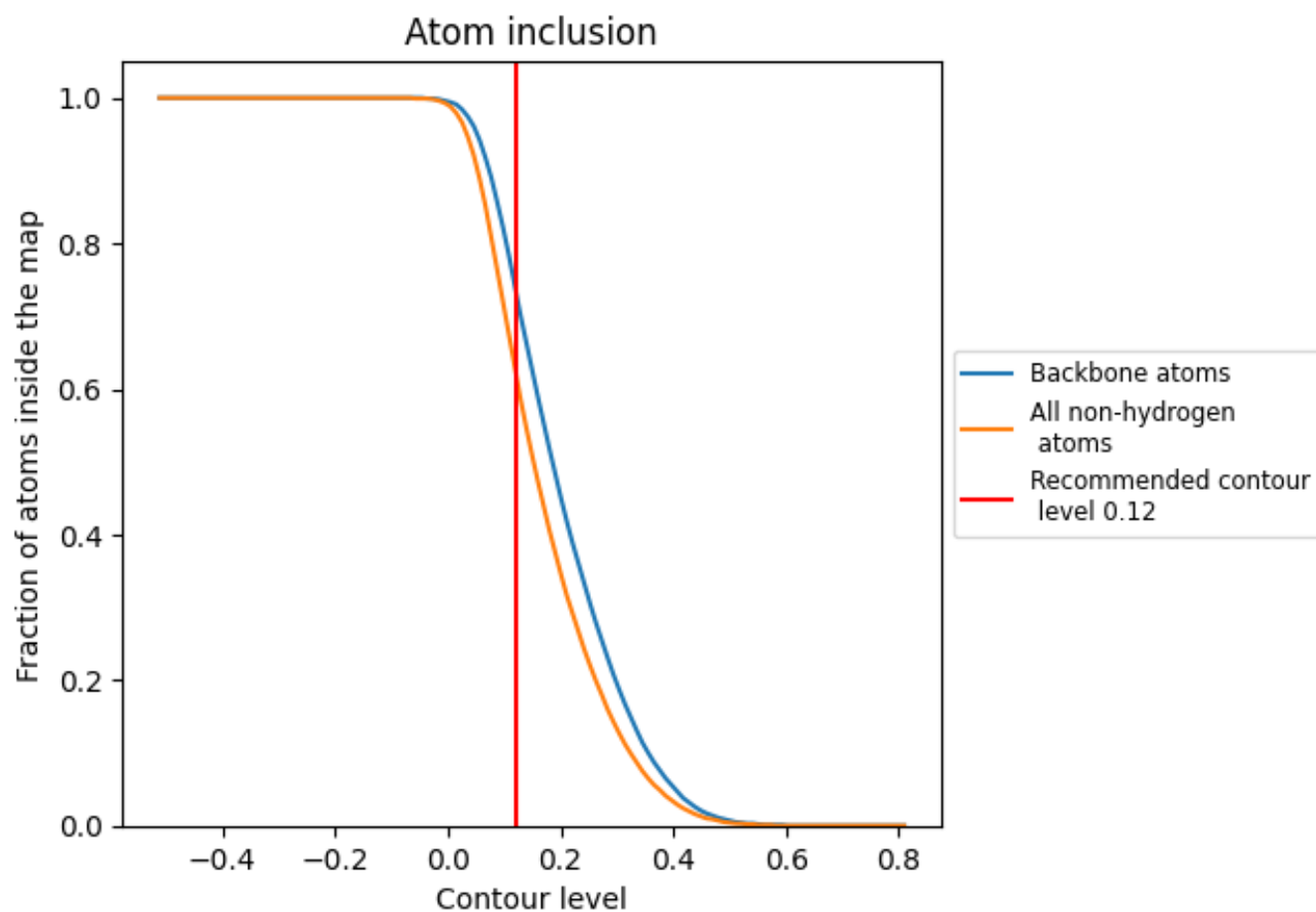



































































9.4 Atom inclusion [i](#)



At the recommended contour level, 74% of all backbone atoms, 62% of all non-hydrogen atoms, are inside the map.

9.5 Map-model fit summary









































The table lists the average atom inclusion at the recommended contour level (0.12) and Q-score for the entire model and for each chain.

Chain	Atom inclusion	Q-score
All	 0.6250	 0.4720
1	 0.7240	 0.5270
2	 0.7280	 0.5280
3	 0.7260	 0.5270
4	 0.7310	 0.5280
5	 0.7250	 0.5290
D	 0.7270	 0.5140
E	 0.7280	 0.5110
F	 0.7300	 0.5150
G	 0.7280	 0.5140
H	 0.7250	 0.5130
I	 0.7260	 0.5150
J	 0.5150	 0.4310
K	 0.5240	 0.4290
L	 0.5200	 0.4290
M	 0.5170	 0.4290
N	 0.5270	 0.4310
O	 0.5210	 0.4320
P	 0.5290	 0.4160
Q	 0.5340	 0.4170
R	 0.5240	 0.4160
S	 0.5290	 0.4150
T	 0.5320	 0.4160
U	 0.5220	 0.4160
V	 0.6990	 0.5030
W	 0.7060	 0.5040
X	 0.7030	 0.5010
Y	 0.7010	 0.5000
Z	 0.7090	 0.5020
a	 0.7070	 0.5030
b	 0.7640	 0.5480
c	 0.7620	 0.5460
d	 0.7620	 0.5450
e	 0.7560	 0.5440
f	 0.7670	 0.5450



Continued on next page...

Continued from previous page...

Chain	Atom inclusion	Q-score
g	 0.7590	 0.5460
h	 0.7010	 0.5070
i	 0.7010	 0.5070
j	 0.7010	 0.5070
k	 0.6960	 0.5070
l	 0.7010	 0.5070
m	 0.7000	 0.5070
n	 0.7930	 0.5350
o	 0.7910	 0.5350
p	 0.7930	 0.5330
q	 0.7900	 0.5320
r	 0.8010	 0.5350
s	 0.7950	 0.5360
t	 0.6200	 0.4860
u	 0.6240	 0.4860
v	 0.6250	 0.4850
w	 0.6200	 0.4860
x	 0.6210	 0.4850
y	 0.6220	 0.4870
z	 0.7220	 0.5280