



## Full wwPDB EM Validation Report ⓘ

Mar 13, 2024 – 02:25 PM JST

PDB ID : 3JCT  
EMDB ID : EMD-6615  
Title : Cryo-em structure of eukaryotic pre-60S ribosomal subunits  
Authors : Wu, S.; Kumcuoglu, B.; Yan, K.G.; Brown, H.; Zhang, Y.X.; Tan, D.; Gama-  
linda, M.; Yuan, Y.; Li, Z.F.; Jakovljevic, J.; Ma, C.Y.; Lei, J.L.; Dong, M.Q.;  
Woolford Jr., J.L.; Gao, N.  
Deposited on : 2016-03-09  
Resolution : 3.08 Å (reported)  
Based on initial model : 4V88

This is a Full wwPDB EM Validation Report for a publicly released PDB entry.

We welcome your comments at [validation@mail.wwpdb.org](mailto:validation@mail.wwpdb.org)

A user guide is available at

<https://www.wwpdb.org/validation/2017/EMValidationReportHelp>

with specific help available everywhere you see the ⓘ symbol.

The types of validation reports are described at

<http://www.wwpdb.org/validation/2017/FAQs#types>.

---

The following versions of software and data (see [references ⓘ](#)) were used in the production of this report:

EMDB validation analysis : 0.0.1.dev70  
Mogul : 1.8.5 (274361), CSD as541be (2020)  
MolProbity : 4.02b-467  
buster-report : 1.1.7 (2018)  
Percentile statistics : 20191225.v01 (using entries in the PDB archive December 25th 2019)  
MapQ : 1.9.13  
Ideal geometry (proteins) : Engh & Huber (2001)  
Ideal geometry (DNA, RNA) : Parkinson et al. (1996)  
Validation Pipeline (wwPDB-VP) : 2.36

# 1 Overall quality at a glance i

The following experimental techniques were used to determine the structure:  
*ELECTRON MICROSCOPY*

The reported resolution of this entry is 3.08 Å.

Percentile scores (ranging between 0-100) for global validation metrics of the entry are shown in the following graphic. The table shows the number of entries on which the scores are based.

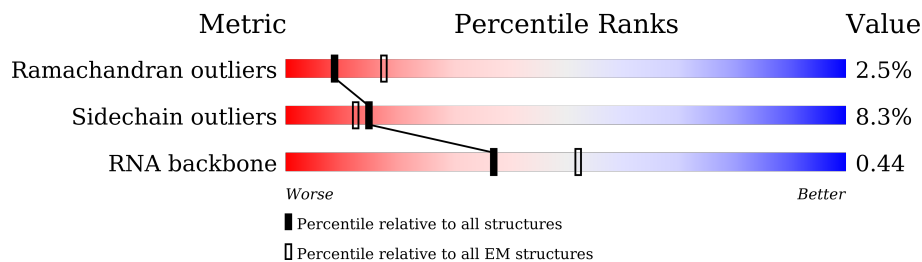

Metric	Whole archive (#Entries)	EM structures (#Entries)
Ramachandran outliers	154571	4023
Sidechain outliers	154315	3826
RNA backbone	4643	859

The table below summarises the geometric issues observed across the polymeric chains and their fit to the map. The red, orange, yellow and green segments of the bar indicate the fraction of residues that contain outliers for  $\geq 3$ , 2, 1 and 0 types of geometric quality criteria respectively. A grey segment represents the fraction of residues that are not modelled. The numeric value for each fraction is indicated below the corresponding segment, with a dot representing fractions  $\leq 5\%$ . The upper red bar (where present) indicates the fraction of residues that have poor fit to the EM map (all-atom inclusion  $< 40\%$ ). The numeric value is given above the bar.

Mol	Chain	Length	Quality of chain
1	A	254	
2	B	387	
3	C	362	
4	D	297	
5	E	176	
6	F	244	
7	G	256	
8	H	191	

Continued on next page...

Continued from previous page...

Mol	Chain	Length	Quality of chain
9	I	166	16% 74% 5% 21%
10	J	174	88% 76% 18% ..
11	K	376	41% 63% 5% 32%
12	L	199	13% 84% 9% 6%
13	M	138	. 96% ...
14	N	204	5% 93% 6%
15	O	199	. 87% 12% ..
16	P	184	14% 92% 7% .
17	Q	186	5% 69% 28%
18	R	189	6% 76% 6% 17%
19	S	172	12% 88% 11% .
20	T	160	27% 61% 12% 26%
21	U	121	8% 83% 12%
22	V	137	. 94% ...
23	W	236	28% 89% 10% .
24	X	142	6% 88% 11% .
25	Y	127	6% 94% ...
26	Z	136	6% 93% 7% .
27	a	149	10% 56% 7% 38%
28	b	647	19% 85% 13% ..
29	c	105	12% 85% 8% 8%
30	d	113	12% 83% 11% 5%
31	e	130	7% 92% 6% .
32	f	107	93% 5% ..
33	g	121	7% 87% 6% 7%

Continued on next page...

Continued from previous page...

Mol	Chain	Length	Quality of chain
34	h	120	88% 11% ..
35	i	100	90% 8% ..
36	j	88	91% 8% .
37	k	78	92% 6% .
38	l	51	82% 16% .
39	m	486	78% 17% ..
40	n	605	53% 8% . 39%
41	o	220	51% 9% 40%
42	p	92	96% ..
43	q	455	36% . 60%
44	r	261	77% 10% . 12%
45	s	520	87% .
46	t	322	78% 10% . 11%
47	u	199	69% 6% . 25%
48	v	344	81% .. 17%
49	w	203	81% 7% . 10%
50	x	515	87% 8% 5%
51	y	245	92% 8%
52	z	106	49% . 48%
53	1	3396	61% 28% 10%
54	2	158	75% 25% .
55	3	121	80% 19% .
56	4	593	77% 9% . 13%
57	5	120	49% 12% 39%
58	6	232	72%

## 2 Entry composition [i](#)

There are 61 unique types of molecules in this entry. The entry contains 156562 atoms, of which 0 are hydrogens and 0 are deuteriums.

In the tables below, the AltConf column contains the number of residues with at least one atom in alternate conformation and the Trace column contains the number of residues modelled with at most 2 atoms.

- Molecule 1 is a protein called 60S ribosomal protein L2-A.

Mol	Chain	Residues	Atoms					AltConf	Trace
			Total	C	N	O	S		
1	A	213	1634	1023	326	284	1	0	0

- Molecule 2 is a protein called 60S ribosomal protein L3.

Mol	Chain	Residues	Atoms					AltConf	Trace
			Total	C	N	O	S		
2	B	386	3081	1956	584	533	8	0	0

- Molecule 3 is a protein called 60S ribosomal protein L4-A.

Mol	Chain	Residues	Atoms					AltConf	Trace
			Total	C	N	O	S		
3	C	361	2749	1730	522	494	3	0	0

- Molecule 4 is a protein called 60S ribosomal protein L5.

Mol	Chain	Residues	Atoms					AltConf	Trace
			Total	C	N	O	S		
4	D	276	2211	1397	391	421	2	0	0

- Molecule 5 is a protein called 60S ribosomal protein L6-A.

Mol	Chain	Residues	Atoms					AltConf	Trace
			Total	C	N	O	S		
5	E	156	1239	800	222	216	1	0	0

- Molecule 6 is a protein called 60S ribosomal protein L7-A.

Mol	Chain	Residues	Atoms					AltConf	Trace
			Total	C	N	O	S		
6	F	222	1784	1151	324	308	1	0	0

- Molecule 7 is a protein called 60S ribosomal protein L8-A.

Mol	Chain	Residues	Atoms					AltConf	Trace
			Total	C	N	O	S		
7	G	233	1817	1159	326	329	3	0	0

- Molecule 8 is a protein called 60S ribosomal protein L9-A.

Mol	Chain	Residues	Atoms					AltConf	Trace
			Total	C	N	O	S		
8	H	191	1518	963	274	277	4	0	0

- Molecule 9 is a protein called Bud site selection protein 20.

Mol	Chain	Residues	Atoms					AltConf	Trace
			Total	C	N	O	S		
9	I	131	1059	662	195	198	4	0	0

- Molecule 10 is a protein called 60S ribosomal protein L11-A.

Mol	Chain	Residues	Atoms					AltConf	Trace
			Total	C	N	O	S		
10	J	169	1353	847	253	249	4	0	0

- Molecule 11 is a protein called Proteasome-interacting protein CIC1.

Mol	Chain	Residues	Atoms					AltConf	Trace
			Total	C	N	O	S		
11	K	256	2064	1332	342	387	3	0	0

- Molecule 12 is a protein called 60S ribosomal protein L13-A.

Mol	Chain	Residues	Atoms				AltConf	Trace
			Total	C	N	O		
12	L	187	1499	934	307	258	0	0

- Molecule 13 is a protein called 60S ribosomal protein L14-A.

Mol	Chain	Residues	Atoms					AltConf	Trace
			Total	C	N	O	S		
13	M	137	1059	678	200	179	2	0	0

- Molecule 14 is a protein called 60S ribosomal protein L15-A.

Mol	Chain	Residues	Atoms					AltConf	Trace
			Total	C	N	O	S		
14	N	203	1720	1077	361	281	1	0	0

- Molecule 15 is a protein called 60S ribosomal protein L16-A.

Mol	Chain	Residues	Atoms					AltConf	Trace
			Total	C	N	O	S		
15	O	197	1555	1003	289	262	1	0	0

- Molecule 16 is a protein called 60S ribosomal protein L17-A.

Mol	Chain	Residues	Atoms					AltConf	Trace
			Total	C	N	O	S		
16	P	183	1442	896	287	259		0	0

- Molecule 17 is a protein called 60S ribosomal protein L18-A.

Mol	Chain	Residues	Atoms					AltConf	Trace
			Total	C	N	O	S		
17	Q	134	1035	659	196	179	1	0	0

- Molecule 18 is a protein called 60S ribosomal protein L19-A.

Mol	Chain	Residues	Atoms					AltConf	Trace
			Total	C	N	O	S		
18	R	156	1258	781	265	212		0	0

- Molecule 19 is a protein called 60S ribosomal protein L20-A.

Mol	Chain	Residues	Atoms					AltConf	Trace
			Total	C	N	O	S		
19	S	171	1437	925	266	243	3	0	0

- Molecule 20 is a protein called 60S ribosomal protein L21-A.

Mol	Chain	Residues	Atoms					AltConf	Trace
			Total	C	N	O	S		
20	T	119	943	595	180	165	3	0	0

- Molecule 21 is a protein called 60S ribosomal protein L22-A.

Mol	Chain	Residues	Atoms				AltConf	Trace
21	U	106	Total	C	N	O	0	0
			844	545	138	161		

- Molecule 22 is a protein called 60S ribosomal protein L23-A.

Mol	Chain	Residues	Atoms					AltConf	Trace
22	V	136	Total	C	N	O	S	0	0
			1003	628	189	179	7		

- Molecule 23 is a protein called Ribosome assembly factor MRT4.

Mol	Chain	Residues	Atoms					AltConf	Trace
23	W	234	Total	C	N	O	S	0	0
			1885	1194	323	362	6		

- Molecule 24 is a protein called 60S ribosomal protein L25.

Mol	Chain	Residues	Atoms					AltConf	Trace
24	X	141	Total	C	N	O	S	0	0
			1100	705	196	197	2		

- Molecule 25 is a protein called 60S ribosomal protein L26-A.

Mol	Chain	Residues	Atoms				AltConf	Trace
25	Y	126	Total	C	N	O	0	0
			993	625	192	176		

- Molecule 26 is a protein called 60S ribosomal protein L27-A.

Mol	Chain	Residues	Atoms				AltConf	Trace
26	Z	135	Total	C	N	O	0	0
			1092	710	202	180		

- Molecule 27 is a protein called 60S ribosomal protein L28.

Mol	Chain	Residues	Atoms					AltConf	Trace
27	a	93	Total	C	N	O	S	0	0
			735	479	130	125	1		

- Molecule 28 is a protein called Nucleolar GTP-binding protein 1.



Mol	Chain	Residues	Atoms					AltConf	Trace
			Total	C	N	O	S		
28	b	642	5185	3251	938	970	26	0	0

- Molecule 29 is a protein called 60S ribosomal protein L30.

Mol	Chain	Residues	Atoms					AltConf	Trace
			Total	C	N	O	S		
29	c	97	743	479	124	139	1	0	0

- Molecule 30 is a protein called 60S ribosomal protein L31-A.

Mol	Chain	Residues	Atoms					AltConf	Trace
			Total	C	N	O	S		
30	d	107	873	553	165	154	1	0	0

- Molecule 31 is a protein called 60S ribosomal protein L32.

Mol	Chain	Residues	Atoms					AltConf	Trace
			Total	C	N	O	S		
31	e	127	1020	647	205	167	1	0	0

- Molecule 32 is a protein called 60S ribosomal protein L33-A.

Mol	Chain	Residues	Atoms					AltConf	Trace
			Total	C	N	O	S		
32	f	106	850	540	165	144	1	0	0

- Molecule 33 is a protein called 60S ribosomal protein L34-A.

Mol	Chain	Residues	Atoms					AltConf	Trace
			Total	C	N	O	S		
33	g	112	881	546	179	152	4	0	0

- Molecule 34 is a protein called 60S ribosomal protein L35-A.

Mol	Chain	Residues	Atoms					AltConf	Trace
			Total	C	N	O	S		
34	h	119	969	615	186	167	1	0	0

- Molecule 35 is a protein called 60S ribosomal protein L36-A.

Mol	Chain	Residues	Atoms					AltConf	Trace
35	i	99	Total	C	N	O	S	0	0
			771	481	156	132	2		

- Molecule 36 is a protein called 60S ribosomal protein L37-A.

Mol	Chain	Residues	Atoms					AltConf	Trace
36	j	87	Total	C	N	O	S	0	0
			681	414	148	114	5		

- Molecule 37 is a protein called 60S ribosomal protein L38.

Mol	Chain	Residues	Atoms				AltConf	Trace
37	k	77	Total	C	N	O	0	0
			612	391	115	106		

- Molecule 38 is a protein called 60S ribosomal protein L39.

Mol	Chain	Residues	Atoms					AltConf	Trace
38	l	50	Total	C	N	O	S	0	0
			436	272	97	65	2		

- Molecule 39 is a protein called Nucleolar GTP-binding protein 2.

Mol	Chain	Residues	Atoms					AltConf	Trace
39	m	469	Total	C	N	O	S	0	0
			3774	2381	685	699	9		

- Molecule 40 is a protein called Pescadillo homolog.

Mol	Chain	Residues	Atoms					AltConf	Trace
40	n	371	Total	C	N	O	S	0	0
			3030	1963	523	534	10		

- Molecule 41 is a protein called Ribosome biogenesis protein 15.

Mol	Chain	Residues	Atoms					AltConf	Trace
41	o	133	Total	C	N	O	S	0	0
			1107	716	198	189	4		

- Molecule 42 is a protein called 60S ribosomal protein L43-A.

Mol	Chain	Residues	Atoms					AltConf	Trace
42	p	91	Total	C	N	O	S	0	0
			694	429	138	121	6		

- Molecule 43 is a protein called Ribosome biogenesis protein NOP53.

Mol	Chain	Residues	Atoms					AltConf	Trace
43	q	183	Total	C	N	O	S	0	0
			1514	957	268	288	1		

- Molecule 44 is a protein called Ribosome biogenesis protein NSA2.

Mol	Chain	Residues	Atoms					AltConf	Trace
44	r	230	Total	C	N	O	S	0	0
			1860	1177	352	324	7		

- Molecule 45 is a protein called Nuclear GTP-binding protein NUG1.

Mol	Chain	Residues	Atoms					AltConf	Trace
45	s	69	Total	C	N	O	S	0	0
			573	359	113	98	3		

- Molecule 46 is a protein called Ribosome biogenesis protein RLP7.

Mol	Chain	Residues	Atoms					AltConf	Trace
46	t	287	Total	C	N	O	S	0	0
			2306	1459	427	417	3		

- Molecule 47 is a protein called Ribosome biogenesis protein RLP24.

Mol	Chain	Residues	Atoms					AltConf	Trace
47	u	150	Total	C	N	O	S	0	0
			1265	793	253	210	9		

- Molecule 48 is a protein called Ribosome biogenesis protein RPF2.

Mol	Chain	Residues	Atoms					AltConf	Trace
48	v	287	Total	C	N	O	S	0	0
			2318	1482	408	412	16		

- Molecule 49 is a protein called Regulator of ribosome biosynthesis.

Mol	Chain	Residues	Atoms					AltConf	Trace
49	w	182	Total	C	N	O	S	0	0
			1448	911	261	271	5		

- Molecule 50 is a protein called Ribosome assembly protein 4.

Mol	Chain	Residues	Atoms					AltConf	Trace
50	x	488	Total	C	N	O	S	0	0
			3807	2398	677	711	21		

- Molecule 51 is a protein called Eukaryotic translation initiation factor 6.

Mol	Chain	Residues	Atoms					AltConf	Trace
51	y	244	Total	C	N	O	S	0	0
			1849	1146	319	377	7		

- Molecule 52 is a protein called UPF0642 protein YBL028C.

Mol	Chain	Residues	Atoms				AltConf	Trace
52	z	55	Total	C	N	O	0	0
			444	273	88	83		

- Molecule 53 is a RNA chain called RDN25-1 rRNA.

Mol	Chain	Residues	Atoms					AltConf	Trace
53	1	3058	Total	C	N	O	P	0	0
			65427	29223	11807	21339	3058		

- Molecule 54 is a RNA chain called RDN58-1 rRNA.

Mol	Chain	Residues	Atoms					AltConf	Trace
54	2	158	Total	C	N	O	P	0	0
			3353	1500	586	1109	158		

- Molecule 55 is a RNA chain called RDN5-2 rRNA.

Mol	Chain	Residues	Atoms					AltConf	Trace
55	3	121	Total	C	N	O	P	0	0
			2579	1152	461	845	121		

- Molecule 56 is a protein called Probable metalloprotease ARX1.

Mol	Chain	Residues	Atoms					AltConf	Trace
			Total	C	N	O	S		
56	4	516	3999	2530	688	766	15	0	0

- Molecule 57 is a protein called rRNA-processing protein CGR1.

Mol	Chain	Residues	Atoms					AltConf	Trace
			Total	C	N	O	S		
57	5	73	645	395	133	114	3	0	0

- Molecule 58 is a RNA chain called ITS2-1 miscRNA.

Mol	Chain	Residues	Atoms					AltConf	Trace
			Total	C	N	O	P		
58	6	65	1370	614	228	463	65	0	0

- Molecule 59 is ZINC ION (three-letter code: ZN) (formula: Zn).

Mol	Chain	Residues	Atoms		AltConf
59	I	1	Total	Zn	0
			1	1	
59	j	1	Total	Zn	0
			1	1	
59	p	1	Total	Zn	0
			1	1	
59	u	1	Total	Zn	0
			1	1	

- Molecule 60 is GUANOSINE-5'-TRIPHOSPHATE (three-letter code: GTP) (formula: C<sub>10</sub>H<sub>16</sub>N<sub>5</sub>O<sub>14</sub>P<sub>3</sub>).

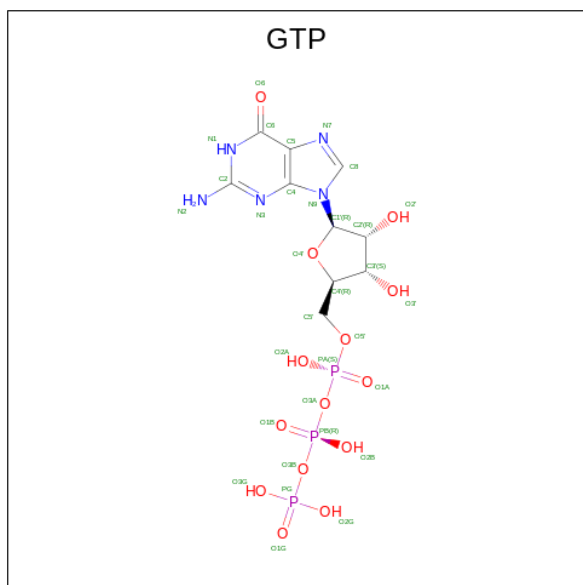

Mol	Chain	Residues	Atoms				AltConf	
60	b	1	Total	C	N	O	P	0
				32	10	5	14	
60	m	1	Total	C	N	O	P	0
				32	10	5	14	

- Molecule 61 is MAGNESIUM ION (three-letter code: MG) (formula: Mg).

Mol	Chain	Residues	Atoms		AltConf
61	b	1	Total	Mg	0
				1	
61	m	1	Total	Mg	0
				1	

### 3 Residue-property plots

These plots are drawn for all protein, RNA, DNA and oligosaccharide chains in the entry. The first graphic for a chain summarises the proportions of the various outlier classes displayed in the second graphic. The second graphic shows the sequence view annotated by issues in geometry and atom inclusion in map density. Residues are color-coded according to the number of geometric quality criteria for which they contain at least one outlier: green = 0, yellow = 1, orange = 2 and red = 3 or more. A red diamond above a residue indicates a poor fit to the EM map for this residue (all-atom inclusion < 40%). Stretches of 2 or more consecutive residues without any outlier are shown as a green connector. Residues present in the sample, but not in the model, are shown in grey.

- Molecule 1: 60S ribosomal protein L2-A

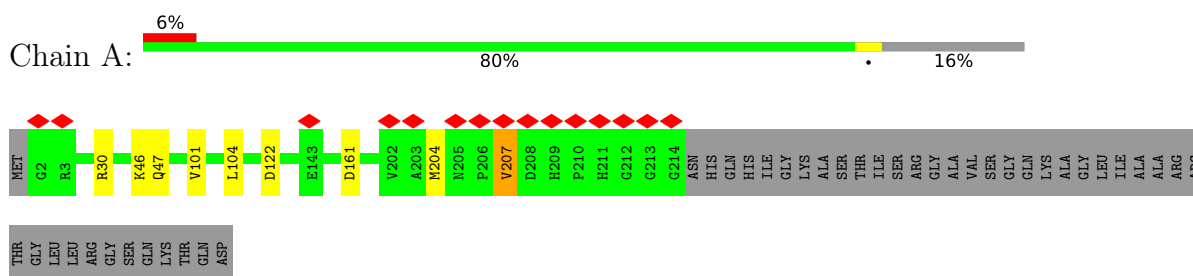

- Molecule 2: 60S ribosomal protein L3

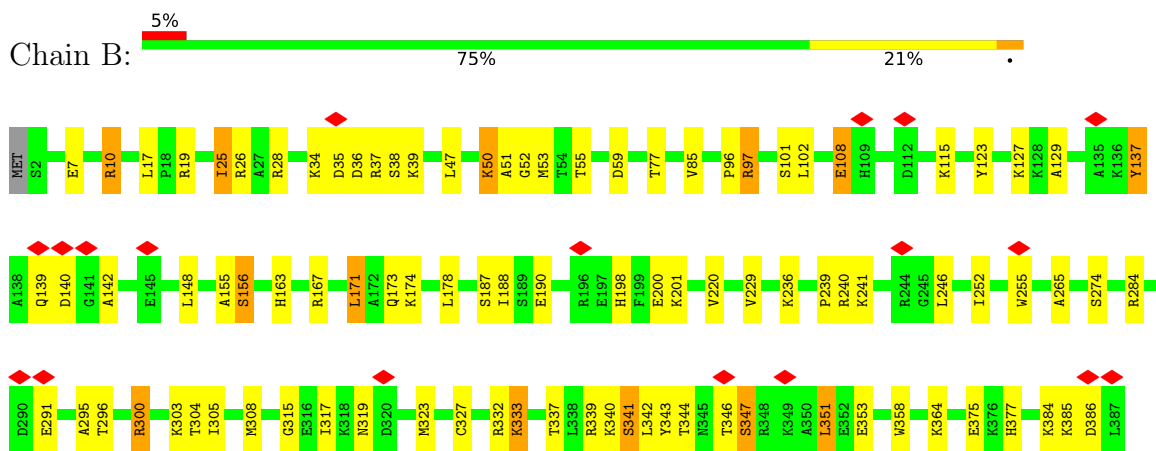

- Molecule 3: 60S ribosomal protein L4-A

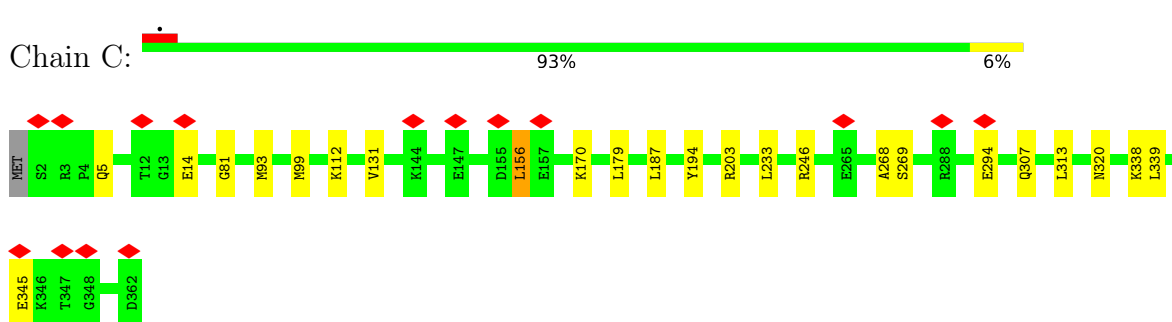

- Molecule 4: 60S ribosomal protein L5

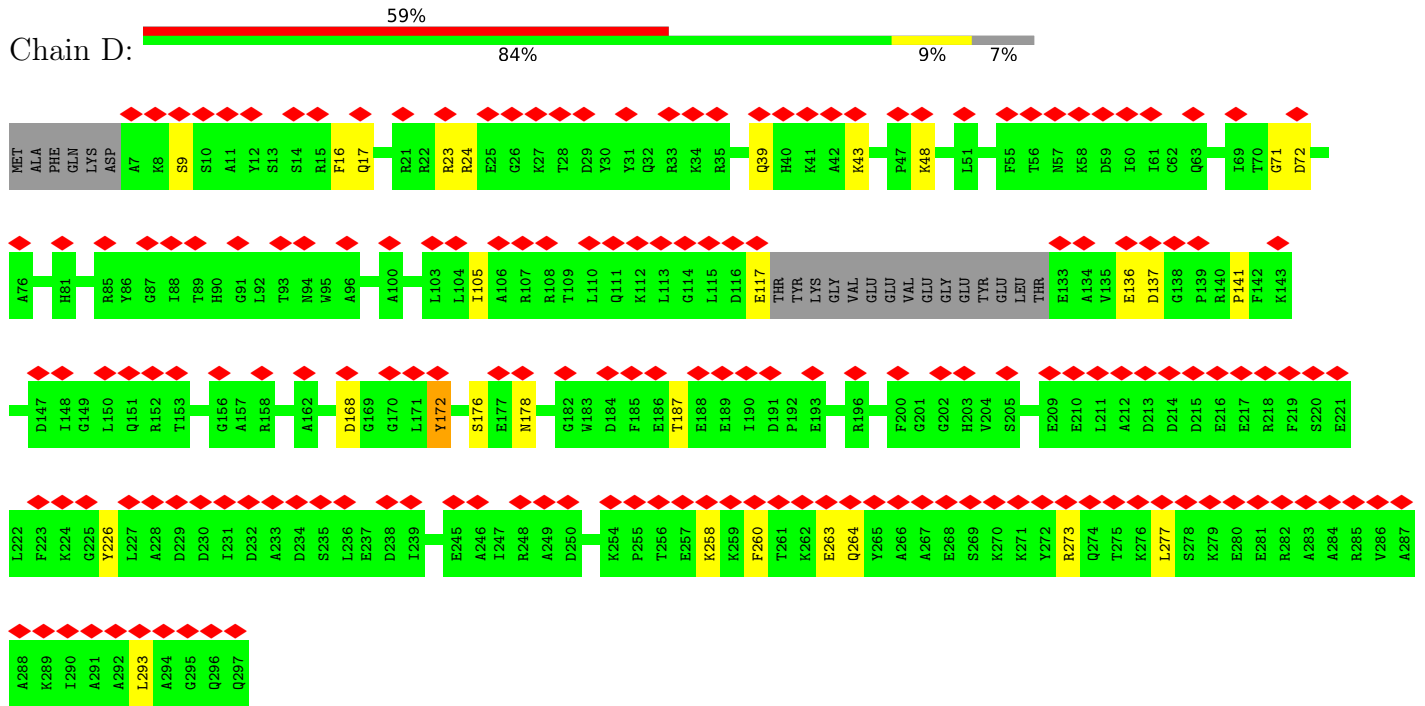

• Molecule 5: 60S ribosomal protein L6-A

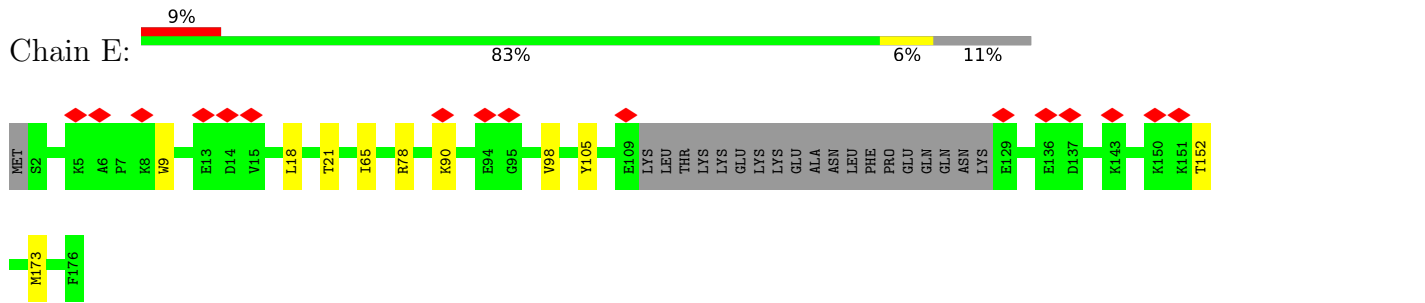

• Molecule 6: 60S ribosomal protein L7-A

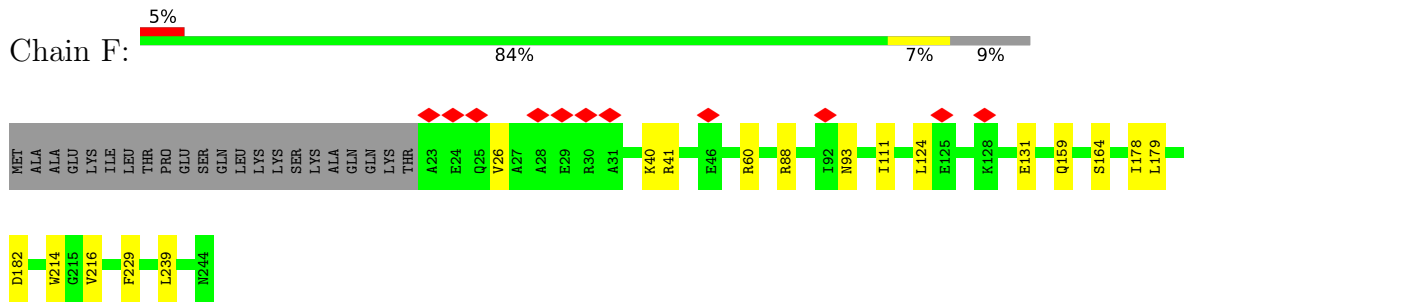

• Molecule 7: 60S ribosomal protein L8-A

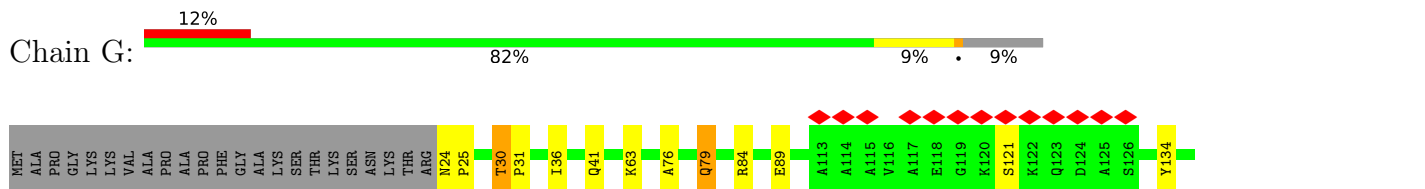



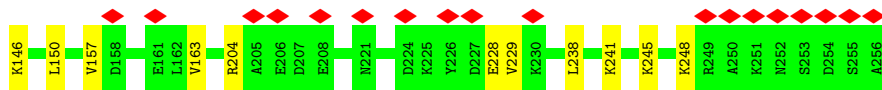

• Molecule 8: 60S ribosomal protein L9-A

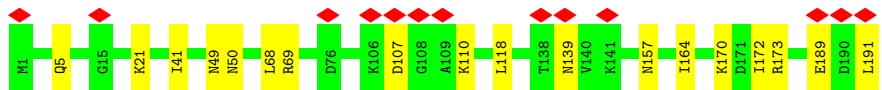
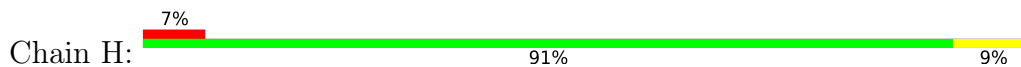

• Molecule 9: Bud site selection protein 20

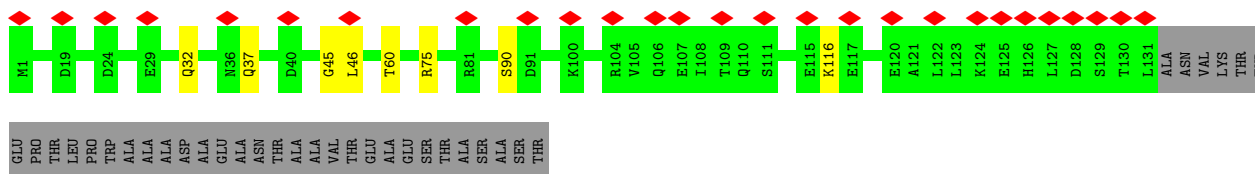
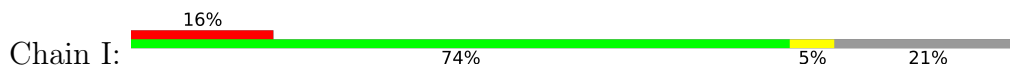

• Molecule 10: 60S ribosomal protein L11-A

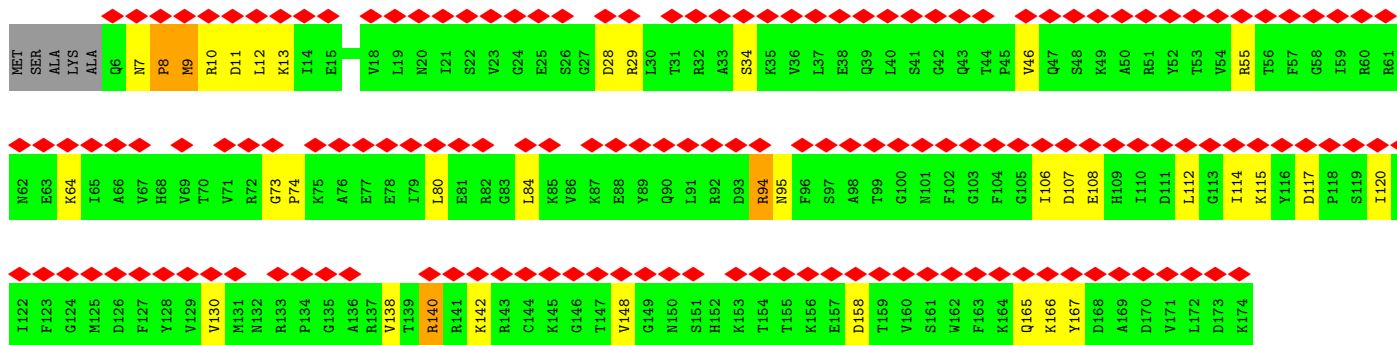
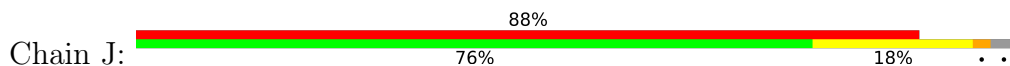

• Molecule 11: Proteasome-interacting protein CIC1

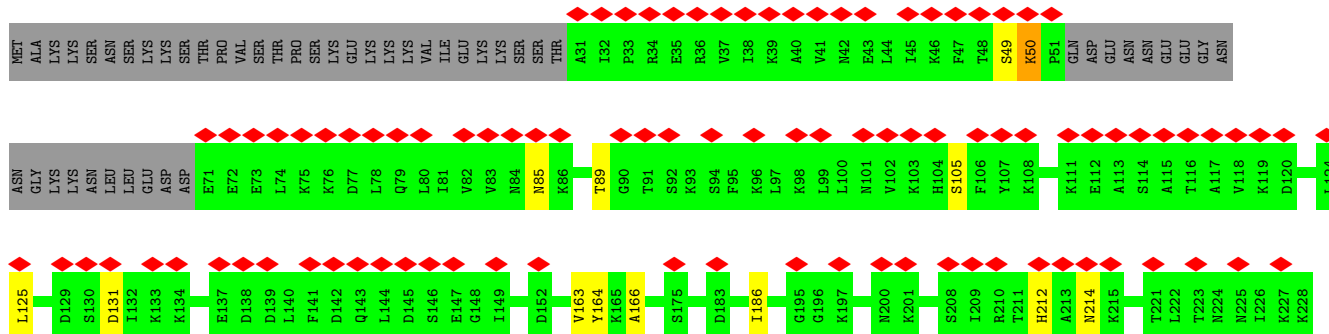
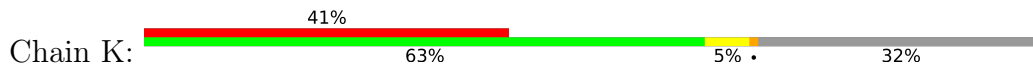

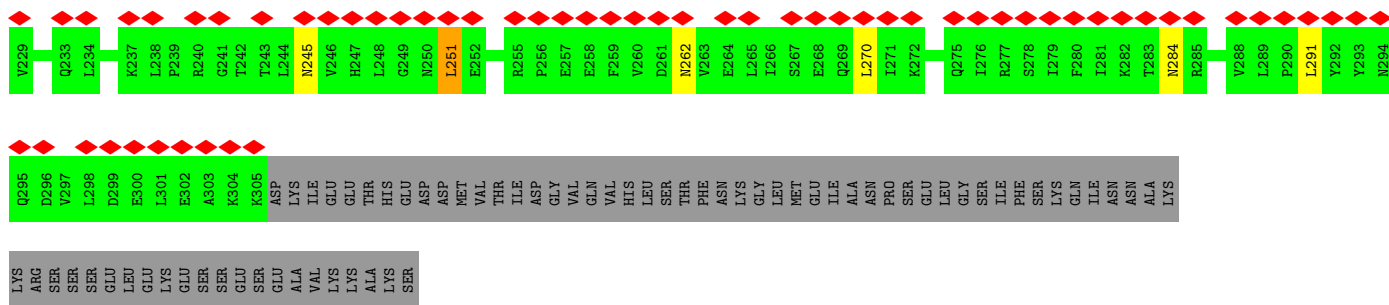

• Molecule 12: 60S ribosomal protein L13-A

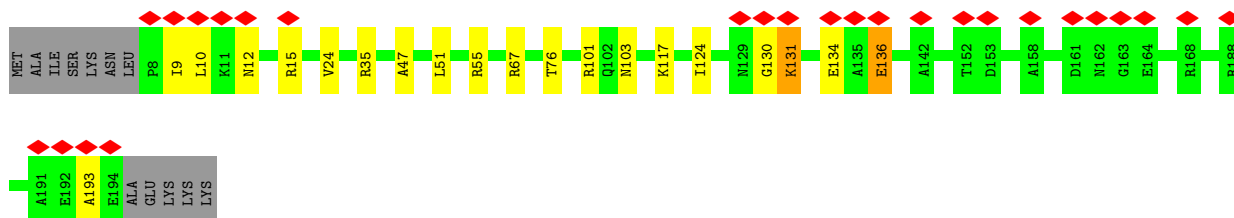
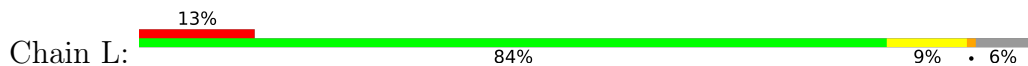

• Molecule 13: 60S ribosomal protein L14-A



• Molecule 14: 60S ribosomal protein L15-A

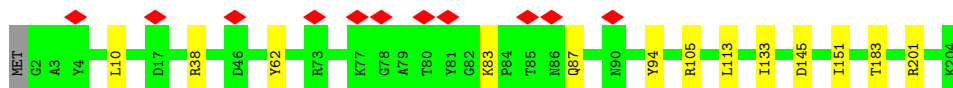

• Molecule 15: 60S ribosomal protein L16-A

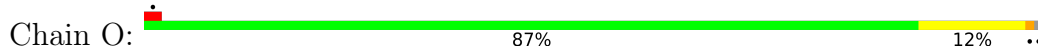

• Molecule 16: 60S ribosomal protein L17-A

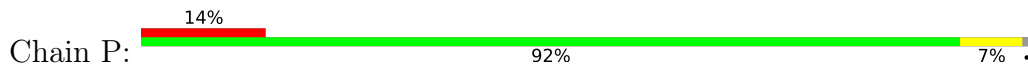

• Molecule 17: 60S ribosomal protein L18-A

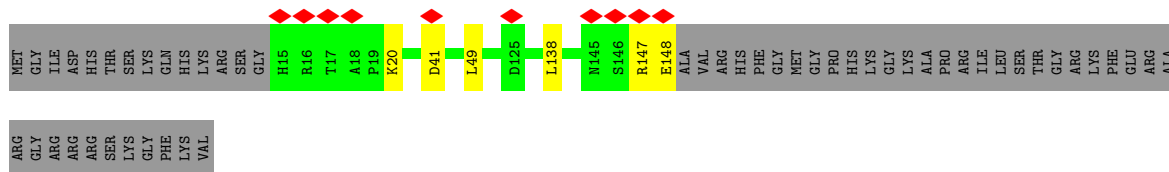

• Molecule 18: 60S ribosomal protein L19-A

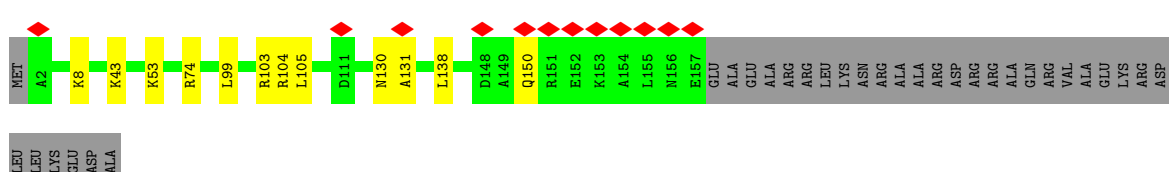
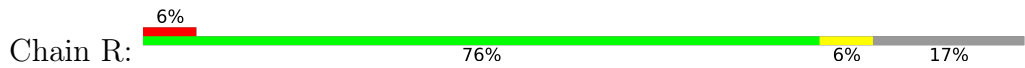

• Molecule 19: 60S ribosomal protein L20-A

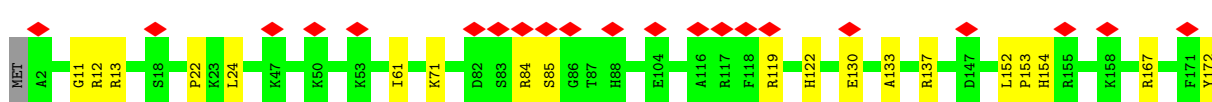
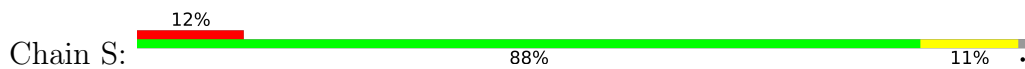

• Molecule 20: 60S ribosomal protein L21-A

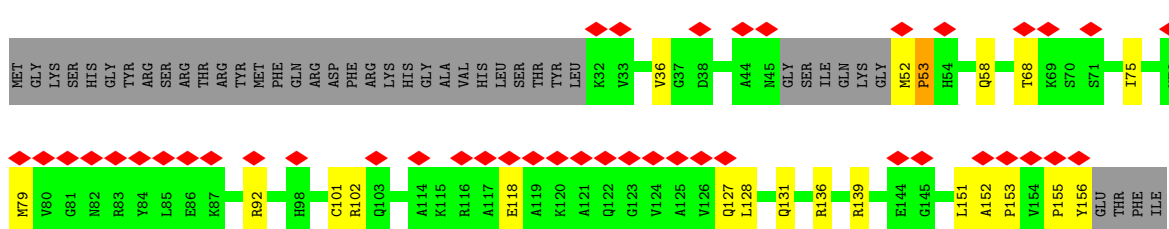

• Molecule 21: 60S ribosomal protein L22-A

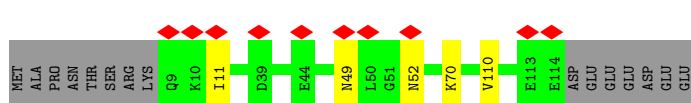
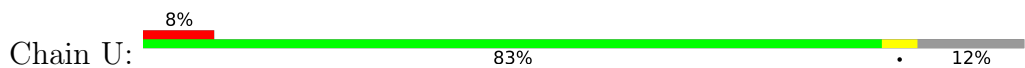

• Molecule 22: 60S ribosomal protein L23-A



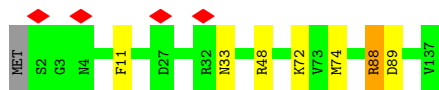

• Molecule 23: Ribosome assembly factor MRT4

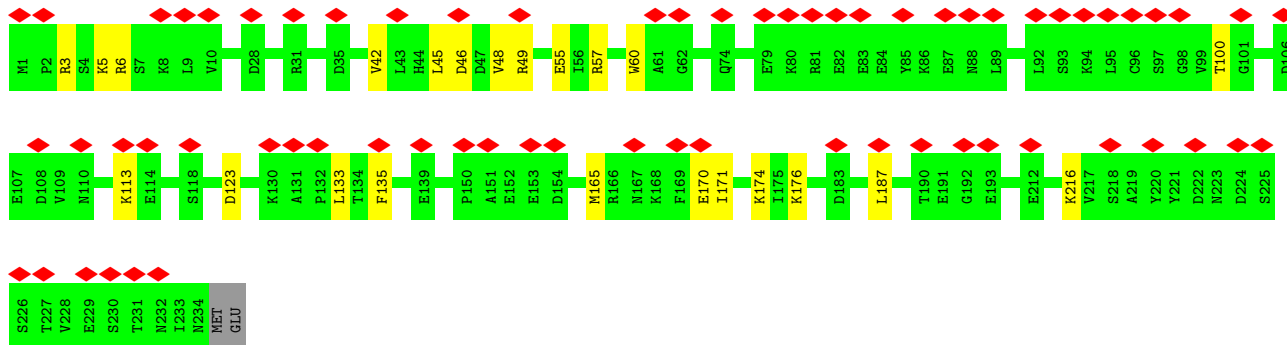
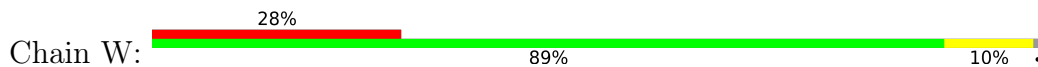

• Molecule 24: 60S ribosomal protein L25

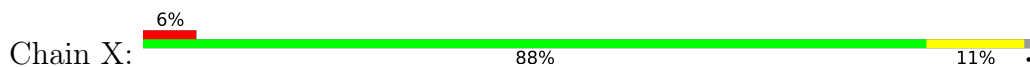

• Molecule 25: 60S ribosomal protein L26-A



• Molecule 26: 60S ribosomal protein L27-A

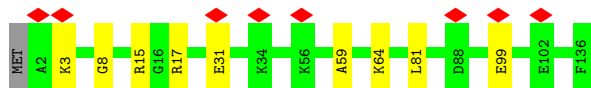

• Molecule 27: 60S ribosomal protein L28

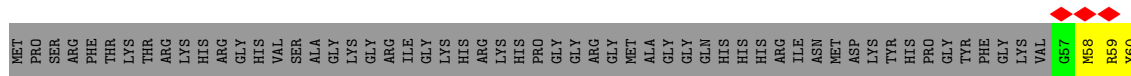



- Molecule 28: Nucleolar GTP-binding protein 1

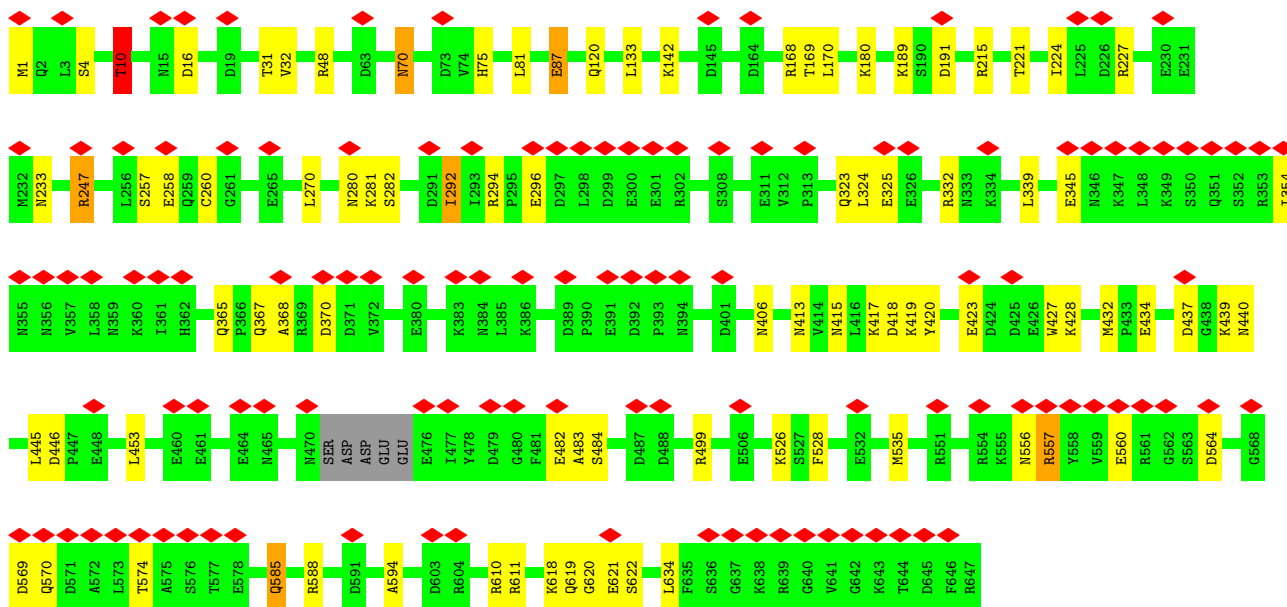
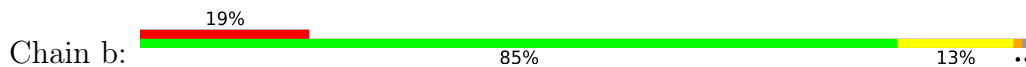

- Molecule 29: 60S ribosomal protein L30

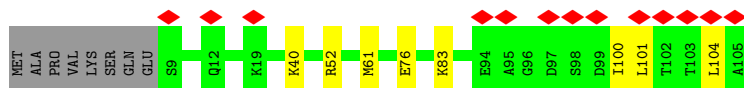
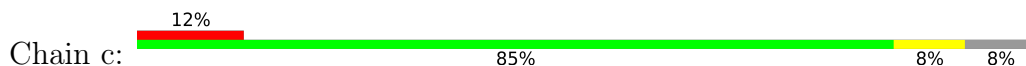

- Molecule 30: 60S ribosomal protein L31-A

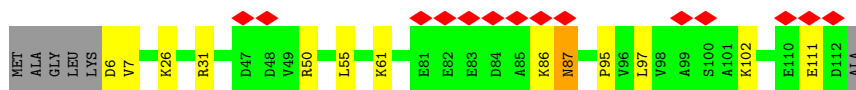
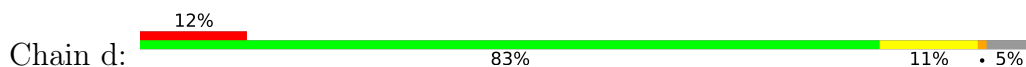

- Molecule 31: 60S ribosomal protein L32

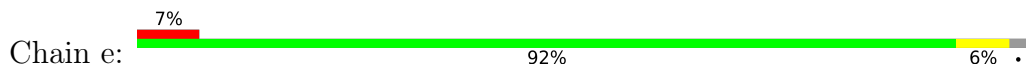

- Molecule 32: 60S ribosomal protein L33-A

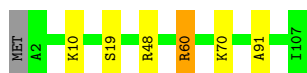

• Molecule 33: 60S ribosomal protein L34-A

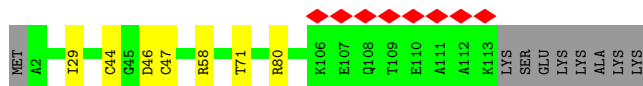
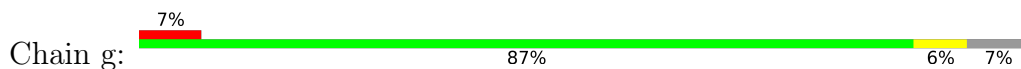

• Molecule 34: 60S ribosomal protein L35-A

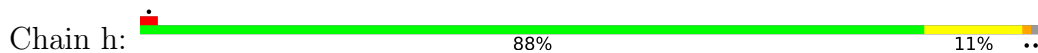

• Molecule 35: 60S ribosomal protein L36-A

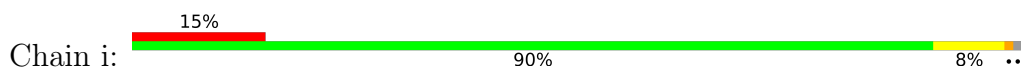

• Molecule 36: 60S ribosomal protein L37-A

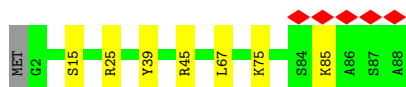
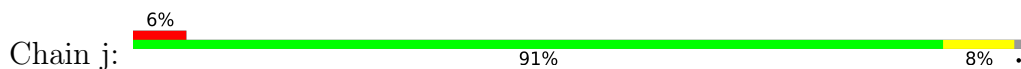

• Molecule 37: 60S ribosomal protein L38

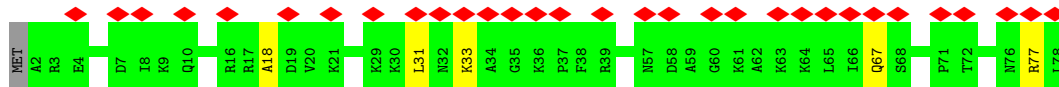
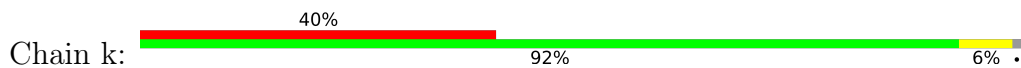

• Molecule 38: 60S ribosomal protein L39

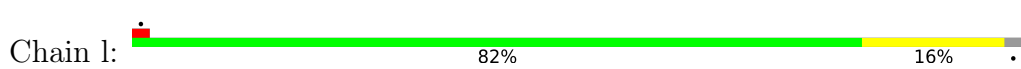

• Molecule 39: Nucleolar GTP-binding protein 2

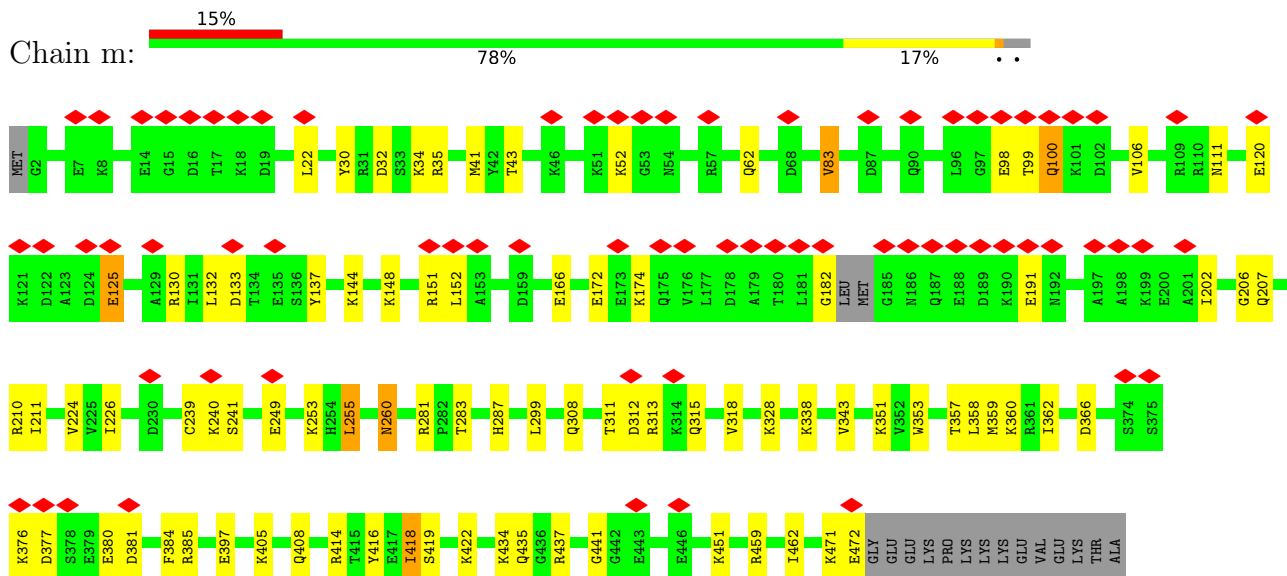







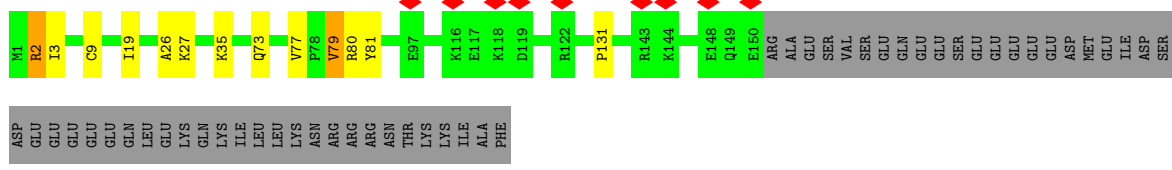

• Molecule 48: Ribosome biogenesis protein RPF2

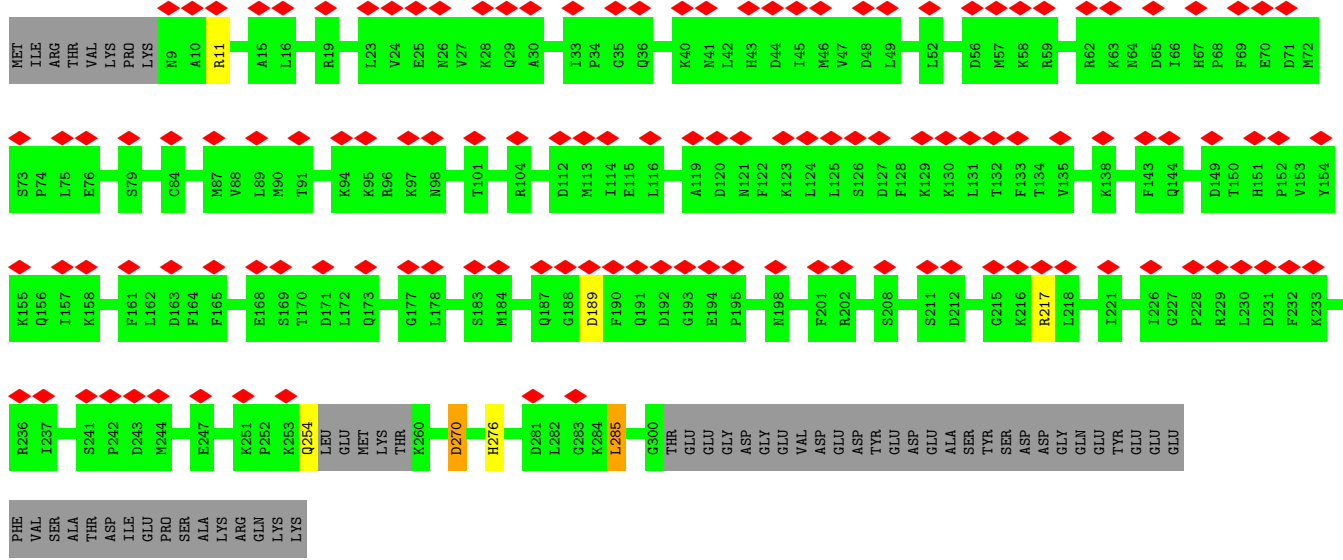
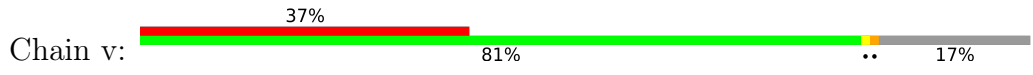

• Molecule 49: Regulator of ribosome biosynthesis

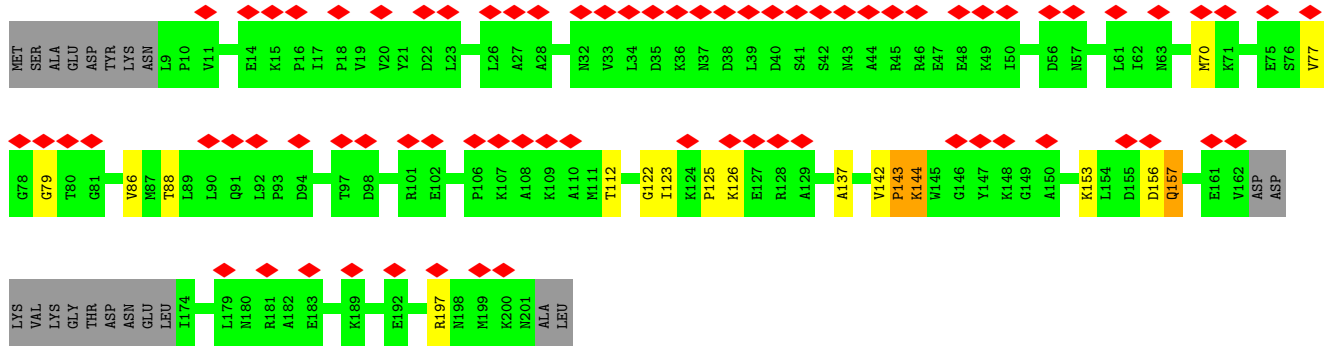
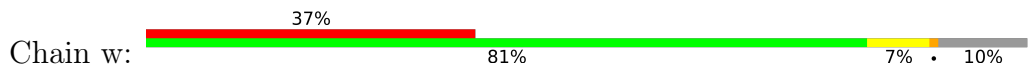

• Molecule 50: Ribosome assembly protein 4

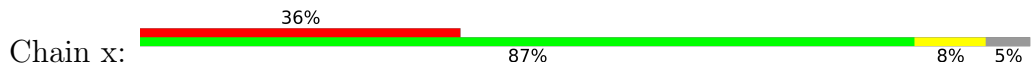

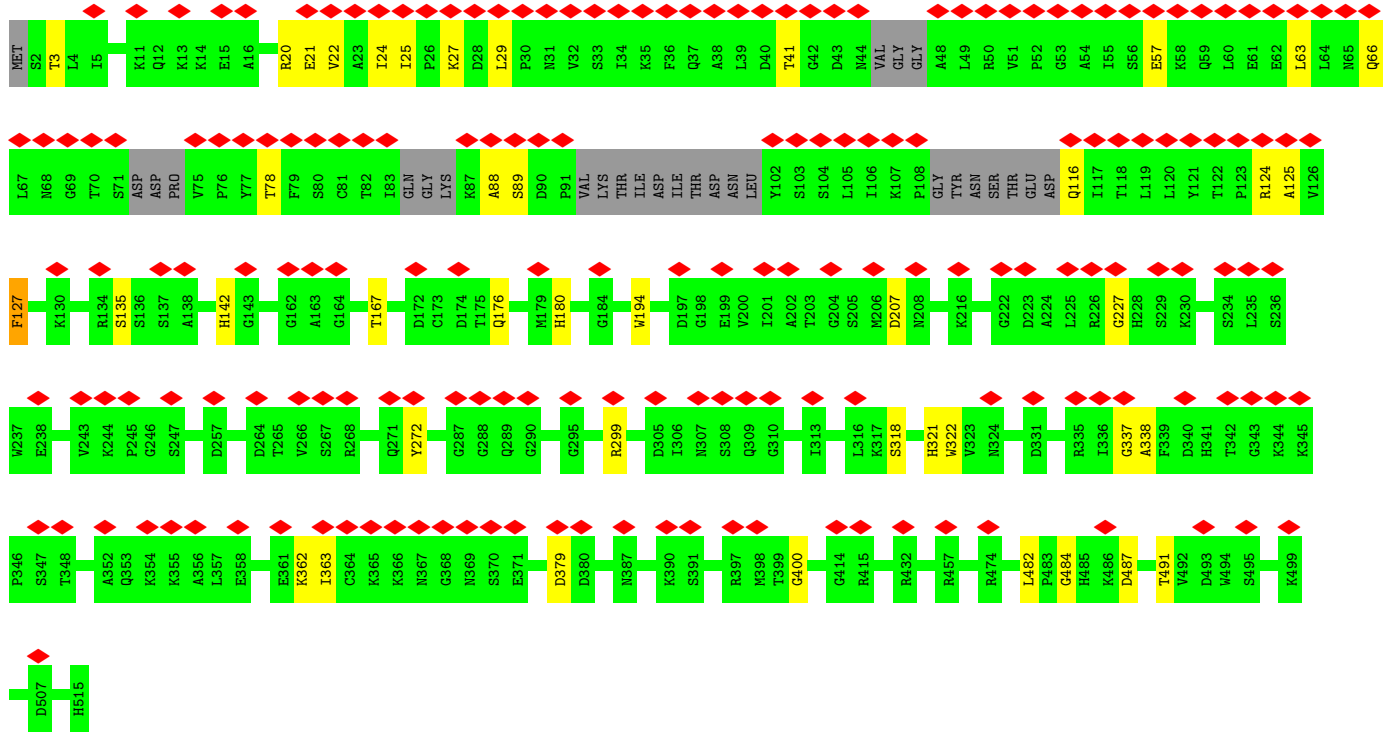

• Molecule 51: Eukaryotic translation initiation factor 6

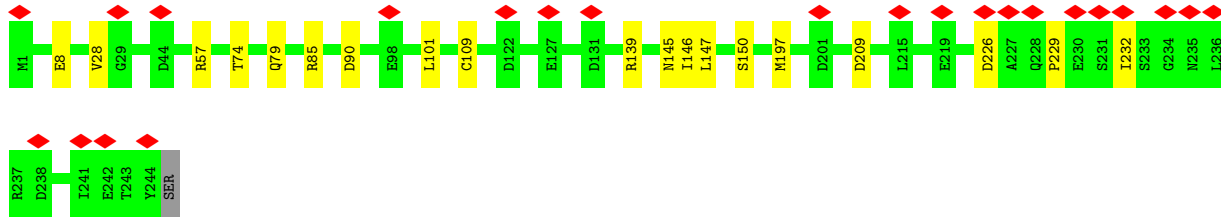
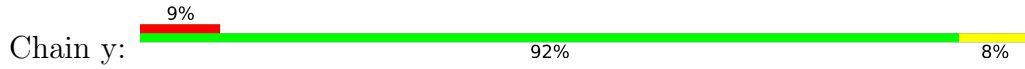

• Molecule 52: UPF0642 protein YBL028C

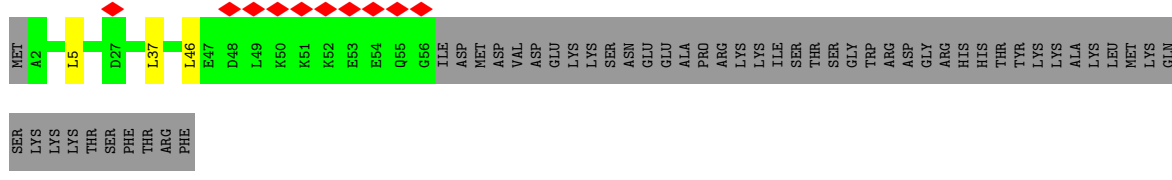

• Molecule 53: RDN25-1 rRNA

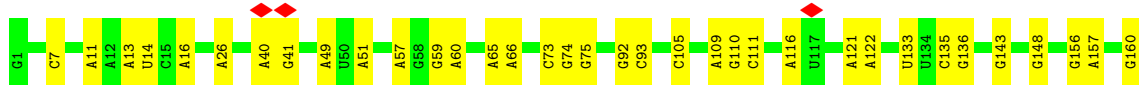

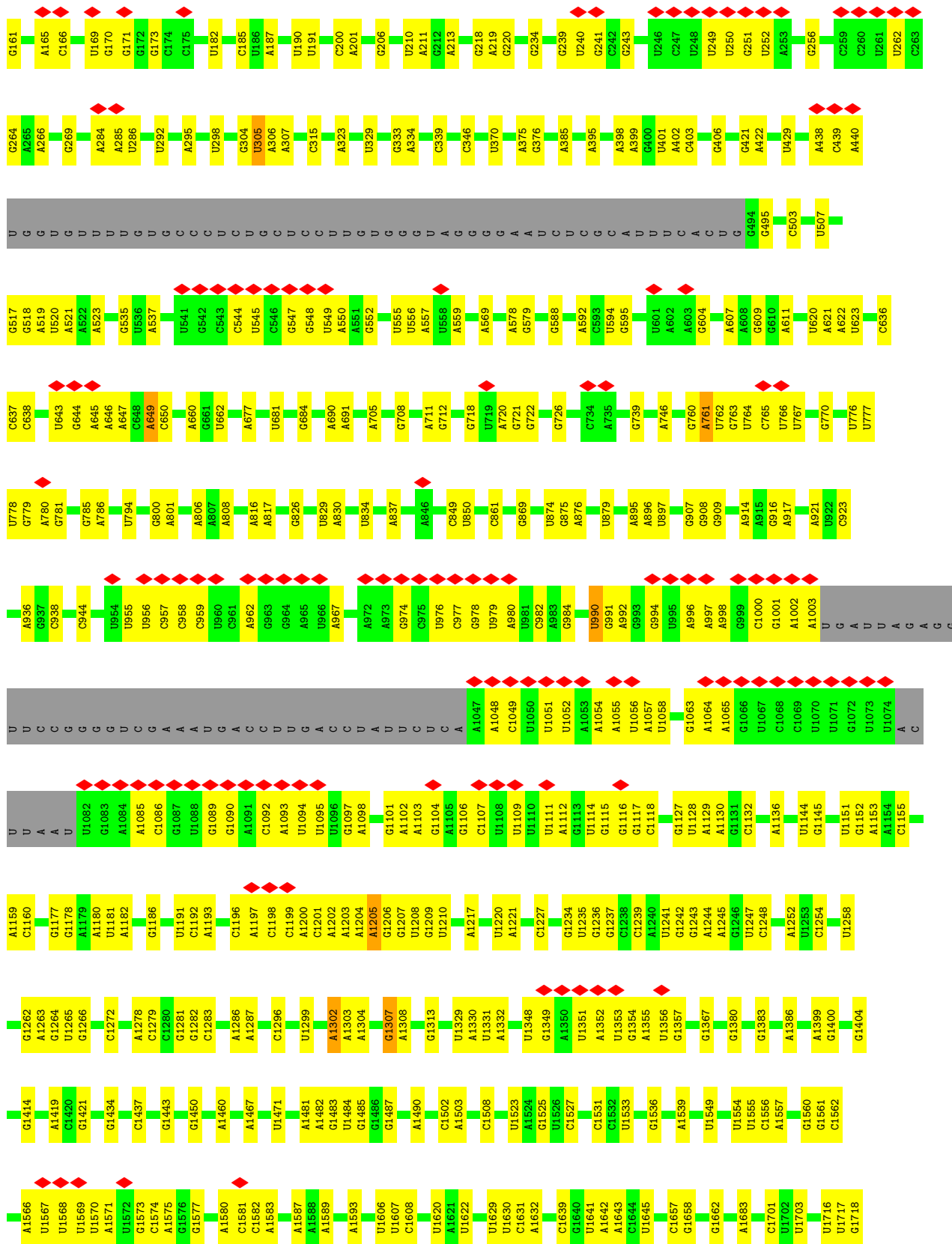



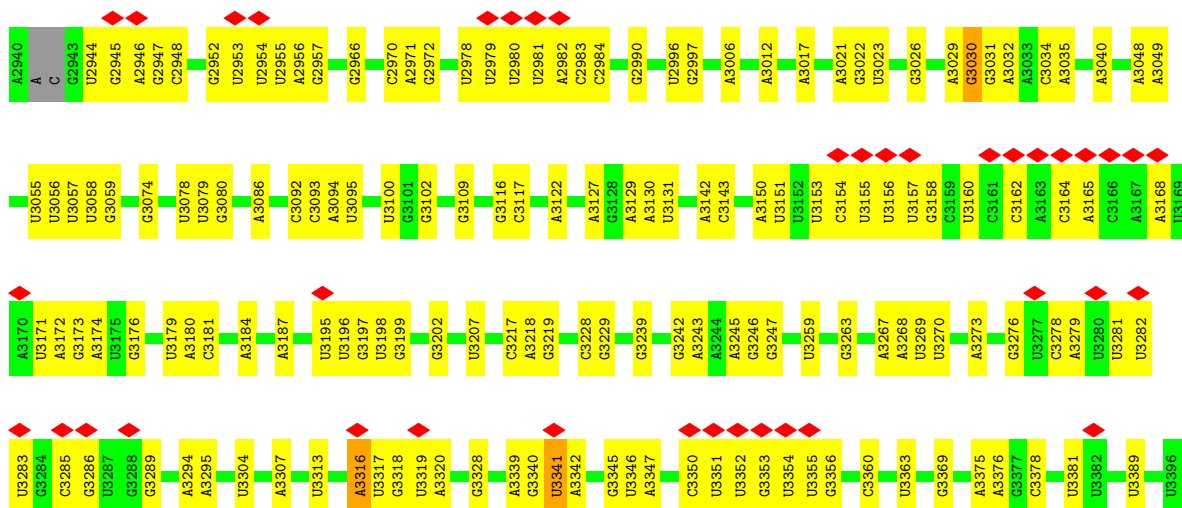

• Molecule 54: RDN58-1 rRNA

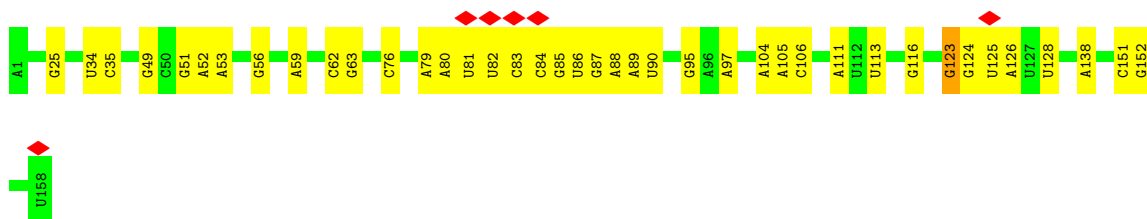

• Molecule 55: RDN5-2 rRNA

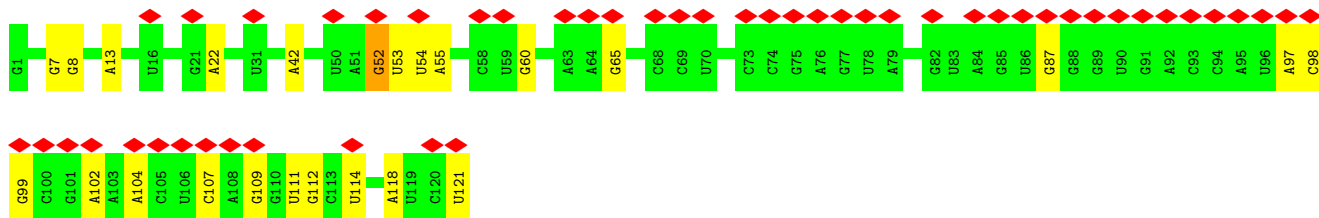
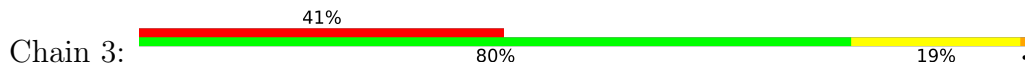

• Molecule 56: Probable metalloprotease ARX1

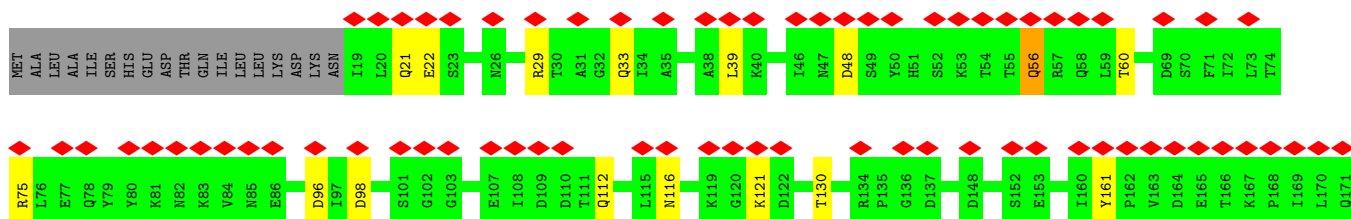
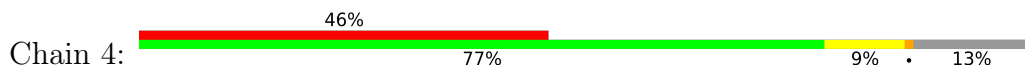

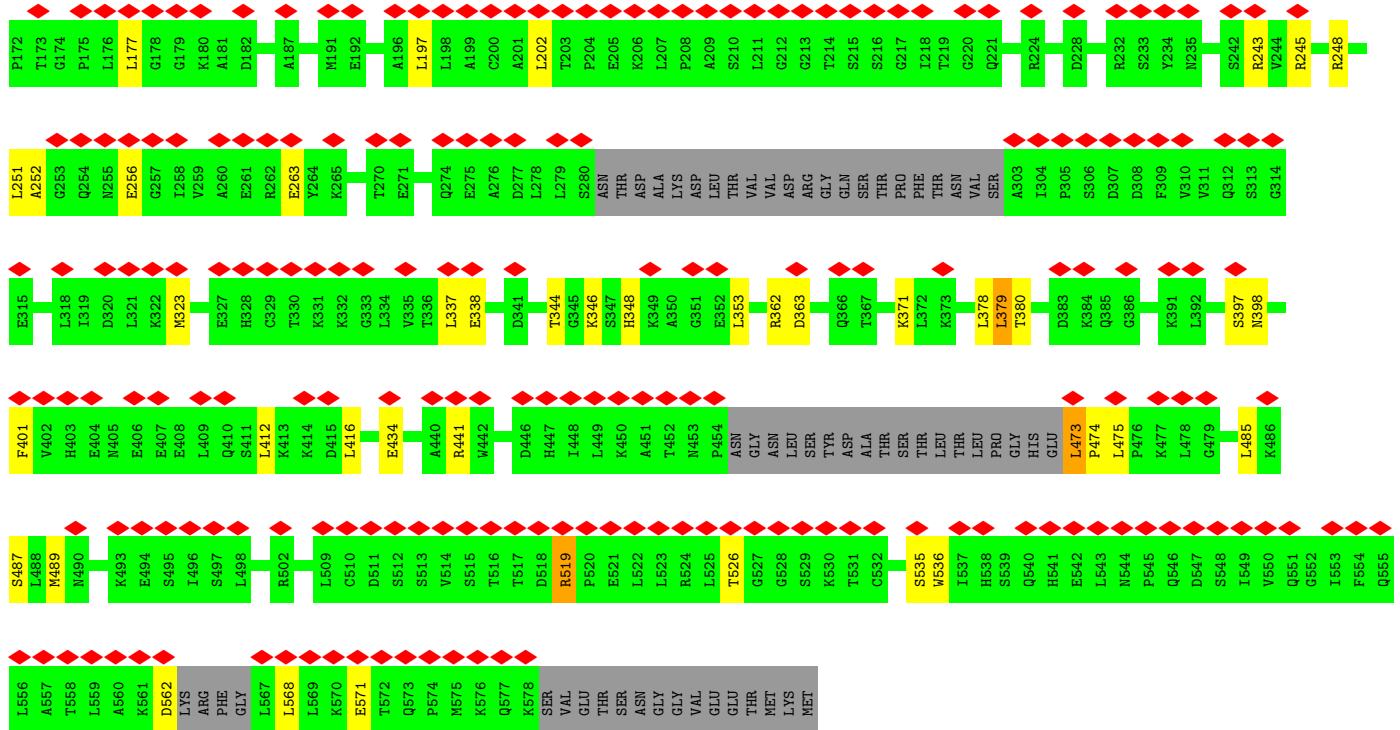

• Molecule 57: rRNA-processing protein CGR1

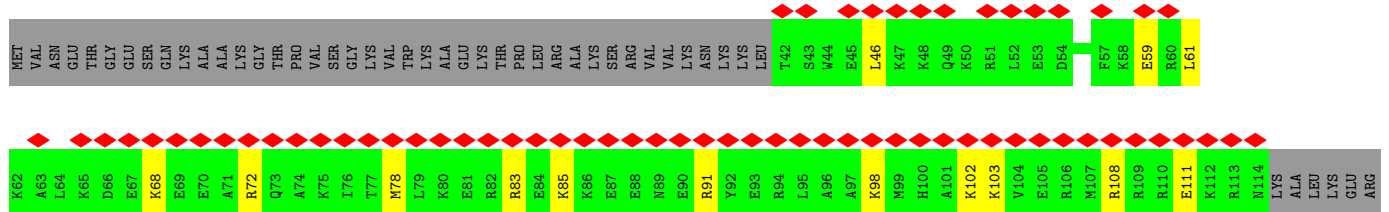

• Molecule 58: ITS2-1 miscRNA

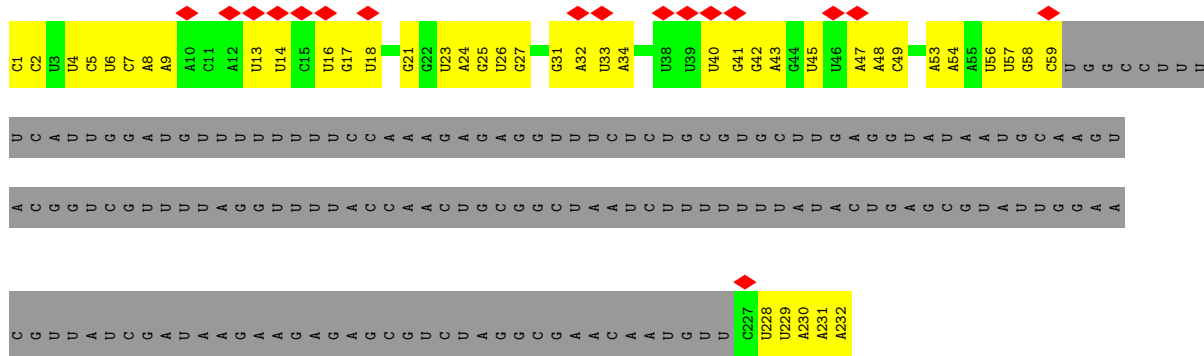

## 4 Experimental information

Property	Value	Source
EM reconstruction method	SINGLE PARTICLE	Depositor
Imposed symmetry	POINT, C1	Depositor
Number of particles used	191848	Depositor
Resolution determination method	Not provided	
CTF correction method	Not provided	
Microscope	FEI TITAN KRIOS	Depositor
Voltage (kV)	300	Depositor
Electron dose ( $e^-/\text{\AA}^2$ )	Not provided	
Minimum defocus (nm)	Not provided	
Maximum defocus (nm)	Not provided	
Magnification	Not provided	
Image detector	GATAN K2 SUMMIT (4k x 4k)	Depositor
Maximum map value	0.272	Depositor
Minimum map value	-0.177	Depositor
Average map value	-0.000	Depositor
Map value standard deviation	0.010	Depositor
Recommended contour level	0.029	Depositor
Map size ( $\text{\AA}$ )	422.40002, 422.40002, 422.40002	wwPDB
Map dimensions	320, 320, 320	wwPDB
Map angles ( $^\circ$ )	90.0, 90.0, 90.0	wwPDB
Pixel spacing ( $\text{\AA}$ )	1.32, 1.32, 1.32	Depositor



## 5 Model quality i

### 5.1 Standard geometry i

Bond lengths and bond angles in the following residue types are not validated in this section: ZN, MG, GTP

The Z score for a bond length (or angle) is the number of standard deviations the observed value is removed from the expected value. A bond length (or angle) with  $|Z| > 5$  is considered an outlier worth inspection. RMSZ is the root-mean-square of all Z scores of the bond lengths (or angles).

Mol	Chain	Bond lengths		Bond angles	
		RMSZ	# Z  >5	RMSZ	# Z  >5
1	A	0.37	0/1666	0.66	0/2241
2	B	0.41	0/3152	0.71	1/4239 (0.0%)
3	C	0.37	0/2801	0.62	0/3792
4	D	0.39	0/2257	0.63	0/3043
5	E	0.36	0/1260	0.61	0/1694
6	F	0.37	0/1821	0.60	0/2451
7	G	0.37	0/1849	0.60	0/2495
8	H	0.35	0/1539	0.61	0/2073
9	I	0.37	0/1075	0.52	0/1443
10	J	0.42	0/1374	0.68	0/1842
11	K	0.38	0/2098	0.49	0/2830
12	L	0.38	0/1524	0.71	1/2046 (0.0%)
13	M	0.33	0/1074	0.58	0/1446
14	N	0.38	0/1757	0.70	0/2354
15	O	0.34	0/1585	0.44	0/2128
16	P	0.35	0/1465	0.63	0/1968
17	Q	0.35	0/1050	0.57	0/1419
18	R	0.34	0/1275	0.60	0/1702
19	S	0.35	0/1473	0.57	0/1980
20	T	0.37	0/957	0.63	0/1285
21	U	0.36	0/861	0.49	0/1167
22	V	0.34	0/1018	0.55	0/1369
23	W	0.37	0/1918	0.53	0/2586
24	X	0.34	0/1116	0.54	0/1503
25	Y	0.33	0/1004	0.56	1/1341 (0.1%)
26	Z	0.35	0/1118	0.54	0/1497
27	a	0.36	0/751	0.57	0/1013
28	b	0.38	0/5270	0.59	0/7080
29	c	0.35	0/751	0.52	0/1008
30	d	0.32	0/887	0.53	0/1191
31	e	0.34	0/1041	0.58	0/1394
32	f	0.35	0/868	0.60	0/1168

Mol	Chain	Bond lengths		Bond angles	
		RMSZ	# Z  >5	RMSZ	# Z  >5
33	g	0.34	0/891	0.61	0/1191
34	h	0.34	0/978	0.57	0/1301
35	i	0.37	0/778	0.58	0/1034
36	j	0.39	0/696	0.69	1/923 (0.1%)
37	k	0.36	0/618	0.53	0/826
38	l	0.36	0/443	0.69	0/588
39	m	0.40	1/3848 (0.0%)	0.59	0/5181
40	n	0.39	0/3101	0.56	0/4187
41	o	0.38	0/1129	0.54	0/1502
42	p	0.35	0/701	0.60	0/934
43	q	0.38	0/1539	0.54	0/2059
44	r	0.38	0/1892	0.62	0/2528
45	s	0.35	0/577	0.53	0/752
46	t	0.40	1/2333 (0.0%)	0.54	0/3128
47	u	0.38	0/1287	0.62	0/1711
48	v	0.35	0/2361	0.47	0/3153
49	w	0.35	0/1471	0.52	0/1980
50	x	0.35	0/3897	0.50	0/5282
51	y	0.35	0/1872	0.57	1/2548 (0.0%)
52	z	0.39	0/445	0.63	0/585
53	1	0.23	0/73234	0.70	12/114167 (0.0%)
54	2	0.23	0/3746	0.69	1/5832 (0.0%)
55	3	0.20	0/2883	0.65	1/4491 (0.0%)
56	4	0.37	0/4069	0.52	0/5520
57	5	0.39	0/649	0.59	0/848
58	6	0.26	0/1527	0.77	0/2371
All	All	0.31	2/166620 (0.0%)	0.65	19/241410 (0.0%)

Chiral center outliers are detected by calculating the chiral volume of a chiral center and verifying if the center is modelled as a planar moiety or with the opposite hand. A planarity outlier is detected by checking planarity of atoms in a peptide group, atoms in a mainchain group or atoms of a sidechain that are expected to be planar.

Mol	Chain	#Chirality outliers	#Planarity outliers
2	B	0	10
3	C	0	1
4	D	0	3
6	F	0	1
7	G	0	4
9	I	0	1
10	J	0	3
11	K	0	3

*Continued on next page...*

Continued from previous page...

Mol	Chain	#Chirality outliers	#Planarity outliers
13	M	0	1
18	R	0	1
19	S	0	6
20	T	0	2
21	U	0	1
22	V	0	2
23	W	0	3
24	X	0	2
26	Z	0	2
28	b	0	18
30	d	0	3
31	e	0	1
32	f	0	1
33	g	0	1
34	h	0	2
36	j	0	1
37	k	0	2
38	l	0	1
39	m	0	16
40	n	0	18
41	o	0	4
43	q	0	8
44	r	0	6
46	t	0	7
47	u	0	3
49	w	0	9
50	x	0	8
51	y	0	3
56	4	0	11
All	All	0	169

All (2) bond length outliers are listed below:

Mol	Chain	Res	Type	Atoms	Z	Observed(Å)	Ideal(Å)
39	m	182	GLY	C-O	7.46	1.35	1.23
46	t	322	ASN	C-O	6.18	1.35	1.23

All (19) bond angle outliers are listed below:

Mol	Chain	Res	Type	Atoms	Z	Observed(°)	Ideal(°)
53	1	1307	G	C2'-C3'-O3'	7.51	126.02	109.50
53	1	649	A	C2'-C3'-O3'	7.47	125.94	109.50

Continued on next page...

*Continued from previous page...*

Mol	Chain	Res	Type	Atoms	Z	Observed(°)	Ideal(°)
53	1	2900	A	C2'-C3'-O3'	7.35	125.67	109.50
53	1	3030	G	C2'-C3'-O3'	6.33	123.82	113.70
53	1	3341	U	C2'-C3'-O3'	6.30	123.78	113.70
53	1	1816	A	C2'-C3'-O3'	6.17	123.57	113.70
53	1	305	U	C2'-C3'-O3'	5.60	122.67	113.70
54	2	123	G	C2'-C3'-O3'	5.54	122.57	113.70
2	B	139	GLN	C-N-CA	-5.54	107.86	121.70
53	1	990	U	C2'-C3'-O3'	5.52	122.53	113.70
36	j	45	ARG	NE-CZ-NH1	5.40	123.00	120.30
53	1	3316	A	C2'-C3'-O3'	5.34	122.24	113.70
53	1	1302	A	C2'-C3'-O3'	5.32	122.21	113.70
55	3	52	G	C2'-C3'-O3'	5.25	122.09	113.70
51	y	90	ASP	CB-CG-OD2	5.20	122.98	118.30
53	1	1205	A	C2'-C3'-O3'	5.17	121.97	113.70
53	1	761	A	C2'-C3'-O3'	5.16	121.95	113.70
12	L	101	ARG	NE-CZ-NH1	5.16	122.88	120.30
25	Y	126	LEU	CA-CB-CG	5.14	127.11	115.30

There are no chirality outliers.

All (169) planarity outliers are listed below:

Mol	Chain	Res	Type	Group
56	4	116	ASN	Peptide
56	4	252	ALA	Peptide
56	4	348	HIS	Peptide
56	4	362	ARG	Peptide
56	4	371	LYS	Peptide
56	4	379	LEU	Peptide
56	4	397	SER	Peptide
56	4	473	LEU	Peptide
56	4	526	THR	Peptide
56	4	535	SER	Peptide
56	4	56	GLN	Peptide
2	B	156	SER	Peptide
2	B	220	VAL	Peptide
2	B	315	GLY	Peptide
2	B	340	LYS	Peptide
2	B	346	THR	Peptide
2	B	347	SER	Peptide
2	B	384	LYS	Peptide
2	B	50	LYS	Peptide
2	B	52	GLY	Peptide

*Continued on next page...*

*Continued from previous page...*

<b>Mol</b>	<b>Chain</b>	<b>Res</b>	<b>Type</b>	<b>Group</b>
2	B	59	ASP	Peptide
3	C	81	GLY	Peptide
4	D	137	ASP	Peptide
4	D	172	TYR	Peptide
4	D	71	GLY	Peptide
6	F	214	TRP	Peptide
7	G	24	ASN	Peptide
7	G	30	THR	Peptide
7	G	76	ALA	Peptide
7	G	79	GLN	Peptide
9	I	45	GLY	Peptide
10	J	73	GLY	Peptide
10	J	8	PRO	Peptide
10	J	9	MET	Peptide
11	K	164	TYR	Peptide
11	K	212	HIS	Peptide
11	K	214	ASN	Peptide
13	M	8	LYS	Peptide
18	R	131	ALA	Peptide
19	S	11	GLY	Peptide
19	S	133	ALA	Peptide
19	S	152	LEU	Peptide
19	S	153	PRO	Peptide
19	S	22	PRO	Peptide
19	S	84	ARG	Peptide
20	T	52	MET	Peptide
20	T	53	PRO	Peptide
21	U	49	ASN	Peptide
22	V	88	ARG	Peptide
22	V	89	ASP	Peptide
23	W	100	THR	Peptide
23	W	135	PHE	Peptide
23	W	176	LYS	Peptide
24	X	17	GLY	Peptide
24	X	65	GLN	Peptide
26	Z	31	GLU	Peptide
26	Z	8	GLY	Peptide
28	b	10	THR	Peptide
28	b	221	THR	Peptide
28	b	247	ARG	Peptide
28	b	280	ASN	Peptide
28	b	292	ILE	Peptide

*Continued on next page...*

*Continued from previous page...*

<b>Mol</b>	<b>Chain</b>	<b>Res</b>	<b>Type</b>	<b>Group</b>
28	b	32	VAL	Peptide
28	b	370	ASP	Peptide
28	b	406	ASN	Peptide
28	b	419	LYS	Peptide
28	b	427	TRP	Peptide
28	b	437	ASP	Peptide
28	b	446	ASP	Peptide
28	b	483	ALA	Peptide
28	b	557	ARG	Peptide
28	b	594	ALA	Peptide
28	b	619	GLN	Peptide
28	b	620	GLY	Peptide
28	b	70	ASN	Peptide
30	d	87	ASN	Peptide
30	d	95	PRO	Peptide
30	d	97	LEU	Peptide
31	e	121	ASN	Peptide
32	f	91	ALA	Peptide
33	g	71	THR	Peptide
34	h	38	ARG	Peptide
34	h	91	ALA	Peptide
36	j	39	TYR	Peptide
37	k	18	ALA	Peptide
37	k	33	LYS	Peptide
38	l	2	ALA	Peptide
39	m	144	LYS	Peptide
39	m	151	ARG	Peptide
39	m	206	GLY	Peptide
39	m	240	LYS	Peptide
39	m	253	LYS	Peptide
39	m	260	ASN	Peptide
39	m	312	ASP	Peptide
39	m	357	THR	Peptide
39	m	376	LYS	Peptide
39	m	384	PHE	Peptide
39	m	416	TYR	Peptide
39	m	419	SER	Peptide
39	m	43	THR	Peptide
39	m	441	GLY	Peptide
39	m	52	LYS	Peptide
39	m	99	THR	Peptide
40	n	123	PRO	Peptide

*Continued on next page...*

*Continued from previous page...*

<b>Mol</b>	<b>Chain</b>	<b>Res</b>	<b>Type</b>	<b>Group</b>
40	n	124	SER	Peptide
40	n	148	THR	Peptide
40	n	207	GLU	Peptide
40	n	211	SER	Peptide
40	n	240	SER	Peptide
40	n	261	SER	Peptide
40	n	3	ILE	Peptide
40	n	358	SER	Peptide
40	n	383	CYS	Peptide
40	n	39	LYS	Peptide
40	n	418	LYS	Peptide
40	n	453	LEU	Peptide
40	n	454	PRO	Peptide
40	n	53	ASN	Peptide
40	n	54	LYS	Peptide
40	n	56	SER	Peptide
40	n	97	GLY	Peptide
41	o	101	GLY	Peptide
41	o	126	LYS	Peptide
41	o	127	LYS	Peptide
41	o	214	SER	Peptide
43	q	200	ALA	Peptide
43	q	223	ALA	Peptide
43	q	226	SER	Peptide
43	q	382	LYS	Peptide
43	q	384	GLY	Peptide
43	q	389	VAL	Peptide
43	q	401	GLU	Peptide
43	q	409	LEU	Peptide
44	r	141	LYS	Peptide
44	r	159	GLU	Peptide
44	r	160	GLY	Peptide
44	r	233	ALA	Peptide
44	r	260	LEU	Peptide
44	r	43	THR	Peptide
46	t	137	GLY	Peptide
46	t	146	ARG	Peptide
46	t	209	GLN	Peptide
46	t	222	ALA	Peptide
46	t	274	ASN	Peptide
46	t	277	VAL	Peptide
46	t	280	PHE	Peptide

*Continued on next page...*

*Continued from previous page...*

Mol	Chain	Res	Type	Group
47	u	2	ARG	Peptide
47	u	77	VAL	Peptide
47	u	79	VAL	Peptide
49	w	112	THR	Peptide
49	w	122	GLY	Peptide
49	w	125	PRO	Peptide
49	w	137	ALA	Peptide
49	w	143	PRO	Peptide
49	w	144	LYS	Peptide
49	w	157	GLN	Peptide
49	w	79	GLY	Peptide
49	w	86	VAL	Peptide
50	x	124	ARG	Peptide
50	x	127	PHE	Peptide
50	x	135	SER	Peptide
50	x	167	THR	Peptide
50	x	24	ILE	Peptide
50	x	27	LYS	Peptide
50	x	29	LEU	Peptide
50	x	318	SER	Peptide
51	y	145	ASN	Peptide
51	y	226	ASP	Peptide
51	y	28	VAL	Peptide

## 5.2 Too-close contacts [i](#)

Due to software issues we are unable to calculate clashes - this section is therefore empty.

## 5.3 Torsion angles [i](#)

### 5.3.1 Protein backbone [i](#)

In the following table, the Percentiles column shows the percent Ramachandran outliers of the chain as a percentile score with respect to all PDB entries followed by that with respect to all EM entries.

The Analysed column shows the number of residues for which the backbone conformation was analysed, and the total number of residues.

Mol	Chain	Analysed	Favoured	Allowed	Outliers	Percentiles
1	A	211/254 (83%)	205 (97%)	5 (2%)	1 (0%)	29 61

*Continued on next page...*



Continued from previous page...

Mol	Chain	Analysed	Favoured	Allowed	Outliers	Percentiles	
2	B	384/387 (99%)	281 (73%)	67 (17%)	36 (9%)	0	3
3	C	359/362 (99%)	330 (92%)	21 (6%)	8 (2%)	6	27
4	D	272/297 (92%)	246 (90%)	21 (8%)	5 (2%)	8	32
5	E	152/176 (86%)	145 (95%)	6 (4%)	1 (1%)	22	54
6	F	220/244 (90%)	207 (94%)	8 (4%)	5 (2%)	6	26
7	G	231/256 (90%)	213 (92%)	12 (5%)	6 (3%)	5	24
8	H	189/191 (99%)	181 (96%)	6 (3%)	2 (1%)	14	44
9	I	129/166 (78%)	110 (85%)	18 (14%)	1 (1%)	19	52
10	J	167/174 (96%)	137 (82%)	15 (9%)	15 (9%)	1	3
11	K	252/376 (67%)	226 (90%)	20 (8%)	6 (2%)	6	25
12	L	185/199 (93%)	170 (92%)	8 (4%)	7 (4%)	3	17
13	M	135/138 (98%)	128 (95%)	6 (4%)	1 (1%)	22	54
14	N	201/204 (98%)	190 (94%)	9 (4%)	2 (1%)	15	47
15	O	195/199 (98%)	150 (77%)	35 (18%)	10 (5%)	2	11
16	P	181/184 (98%)	169 (93%)	9 (5%)	3 (2%)	9	34
17	Q	132/186 (71%)	126 (96%)	6 (4%)	0	100	100
18	R	154/189 (82%)	149 (97%)	4 (3%)	1 (1%)	25	57
19	S	169/172 (98%)	156 (92%)	9 (5%)	4 (2%)	6	25
20	T	115/160 (72%)	102 (89%)	6 (5%)	7 (6%)	1	8
21	U	104/121 (86%)	94 (90%)	8 (8%)	2 (2%)	8	31
22	V	134/137 (98%)	126 (94%)	8 (6%)	0	100	100
23	W	232/236 (98%)	214 (92%)	17 (7%)	1 (0%)	34	66
24	X	139/142 (98%)	130 (94%)	9 (6%)	0	100	100
25	Y	124/127 (98%)	114 (92%)	10 (8%)	0	100	100
26	Z	133/136 (98%)	123 (92%)	9 (7%)	1 (1%)	19	52
27	a	91/149 (61%)	80 (88%)	9 (10%)	2 (2%)	6	27
28	b	638/647 (99%)	561 (88%)	59 (9%)	18 (3%)	5	23
29	c	95/105 (90%)	93 (98%)	1 (1%)	1 (1%)	14	44
30	d	105/113 (93%)	99 (94%)	4 (4%)	2 (2%)	8	31
31	e	125/130 (96%)	120 (96%)	5 (4%)	0	100	100
32	f	104/107 (97%)	99 (95%)	4 (4%)	1 (1%)	15	47

Continued on next page...

Continued from previous page...

Mol	Chain	Analysed	Favoured	Allowed	Outliers	Percentiles	
33	g	110/121 (91%)	107 (97%)	2 (2%)	1 (1%)	17	49
34	h	117/120 (98%)	109 (93%)	6 (5%)	2 (2%)	9	34
35	i	97/100 (97%)	87 (90%)	7 (7%)	3 (3%)	4	21
36	j	85/88 (97%)	75 (88%)	9 (11%)	1 (1%)	13	42
37	k	75/78 (96%)	72 (96%)	3 (4%)	0	100	100
38	l	48/51 (94%)	46 (96%)	2 (4%)	0	100	100
39	m	465/486 (96%)	399 (86%)	53 (11%)	13 (3%)	5	23
40	n	365/605 (60%)	321 (88%)	27 (7%)	17 (5%)	2	13
41	o	131/220 (60%)	116 (88%)	12 (9%)	3 (2%)	6	26
42	p	89/92 (97%)	81 (91%)	7 (8%)	1 (1%)	14	44
43	q	179/455 (39%)	155 (87%)	18 (10%)	6 (3%)	3	19
44	r	224/261 (86%)	194 (87%)	23 (10%)	7 (3%)	4	21
45	s	65/520 (12%)	59 (91%)	3 (5%)	3 (5%)	2	13
46	t	283/322 (88%)	249 (88%)	24 (8%)	10 (4%)	3	18
47	u	148/199 (74%)	134 (90%)	9 (6%)	5 (3%)	3	19
48	v	283/344 (82%)	269 (95%)	11 (4%)	3 (1%)	14	44
49	w	178/203 (88%)	152 (85%)	21 (12%)	5 (3%)	5	23
50	x	476/515 (92%)	433 (91%)	29 (6%)	14 (3%)	4	22
51	y	242/245 (99%)	222 (92%)	16 (7%)	4 (2%)	9	34
52	z	53/106 (50%)	51 (96%)	2 (4%)	0	100	100
56	4	508/593 (86%)	469 (92%)	31 (6%)	8 (2%)	9	35
57	5	71/120 (59%)	70 (99%)	1 (1%)	0	100	100
All	All	10349/12508 (83%)	9344 (90%)	750 (7%)	255 (2%)	9	25

All (255) Ramachandran outliers are listed below:

Mol	Chain	Res	Type
2	B	25	ILE
2	B	34	LYS
2	B	38	SER
2	B	140	ASP
2	B	142	ALA
2	B	229	VAL
2	B	300	ARG

Continued on next page...

*Continued from previous page...*

<b>Mol</b>	<b>Chain</b>	<b>Res</b>	<b>Type</b>
3	C	131	VAL
3	C	268	ALA
3	C	338	LYS
5	E	98	VAL
6	F	216	VAL
7	G	31	PRO
7	G	157	VAL
10	J	9	MET
10	J	28	ASP
10	J	74	PRO
10	J	94	ARG
10	J	165	GLN
12	L	47	ALA
12	L	131	LYS
12	L	136	GLU
12	L	193	ALA
15	O	16	VAL
15	O	122	GLN
15	O	186	ALA
16	P	160	ALA
19	S	85	SER
20	T	53	PRO
20	T	101	CYS
20	T	152	ALA
20	T	153	PRO
28	b	75	HIS
28	b	428	LYS
28	b	484	SER
28	b	621	GLU
29	c	100	ILE
39	m	83	VAL
39	m	100	GLN
39	m	207	GLN
39	m	418	ILE
40	n	98	GLU
41	o	128	THR
41	o	140	VAL
43	q	389	VAL
44	r	17	ARG
44	r	206	SER
46	t	147	VAL
46	t	223	GLU

*Continued on next page...*

*Continued from previous page...*

<b>Mol</b>	<b>Chain</b>	<b>Res</b>	<b>Type</b>
46	t	261	PHE
47	u	81	TYR
50	x	22	VAL
50	x	207	ASP
51	y	146	ILE
51	y	147	LEU
56	4	344	THR
2	B	51	ALA
2	B	53	MET
2	B	171	LEU
2	B	174	LYS
2	B	187	SER
2	B	265	ALA
2	B	351	LEU
3	C	156	LEU
3	C	269	SER
3	C	339	LEU
4	D	24	ARG
6	F	26	VAL
6	F	159	GLN
8	H	50	ASN
11	K	89	THR
12	L	51	LEU
15	O	47	PHE
15	O	129	LEU
19	S	154	HIS
20	T	36	VAL
20	T	58	GLN
27	a	66	ALA
27	a	77	LYS
28	b	260	CYS
28	b	622	SER
32	f	60	ARG
33	g	46	ASP
35	i	3	VAL
35	i	28	TYR
39	m	125	GLU
39	m	137	TYR
39	m	377	ASP
40	n	97	GLY
40	n	455	PRO
40	n	456	HIS

*Continued on next page...*

*Continued from previous page...*

<b>Mol</b>	<b>Chain</b>	<b>Res</b>	<b>Type</b>
41	o	171	ALA
43	q	201	SER
43	q	227	TYR
44	r	162	THR
44	r	237	VAL
46	t	136	ASP
47	u	26	ALA
49	w	144	LYS
56	4	98	ASP
56	4	401	PHE
56	4	519	ARG
2	B	26	ARG
2	B	35	ASP
2	B	36	ASP
2	B	97	ARG
2	B	108	GLU
2	B	127	LYS
2	B	200	GLU
2	B	239	PRO
2	B	342	LEU
3	C	233	LEU
3	C	320	ASN
4	D	72	ASP
6	F	164	SER
10	J	11	ASP
10	J	114	ILE
10	J	167	TYR
13	M	29	ALA
14	N	145	ASP
15	O	21	SER
18	R	53	LYS
26	Z	59	ALA
28	b	10	THR
28	b	368	ALA
28	b	417	LYS
28	b	418	ASP
28	b	528	PHE
34	h	75	TYR
34	h	97	ALA
39	m	111	ASN
39	m	120	GLU
40	n	73	HIS

*Continued on next page...*

*Continued from previous page...*

<b>Mol</b>	<b>Chain</b>	<b>Res</b>	<b>Type</b>
40	n	257	SER
40	n	376	LEU
40	n	457	LEU
43	q	435	VAL
44	r	3	GLN
46	t	151	LEU
46	t	260	SER
46	t	275	ARG
50	x	88	ALA
50	x	89	SER
50	x	125	ALA
51	y	8	GLU
51	y	229	PRO
56	4	474	PRO
2	B	155	ALA
2	B	188	ILE
2	B	295	ALA
2	B	333	LYS
2	B	341	SER
2	B	347	SER
2	B	358	TRP
4	D	260	PHE
7	G	121	SER
8	H	110	LYS
10	J	8	PRO
10	J	95	ASN
10	J	108	GLU
10	J	117	ASP
10	J	140	ARG
11	K	50	LYS
11	K	166	ALA
11	K	251	LEU
15	O	196	ALA
16	P	156	ALA
16	P	158	ALA
19	S	24	LEU
28	b	574	THR
39	m	241	SER
39	m	283	THR
39	m	360	LYS
40	n	54	LYS
40	n	64	TYR

*Continued on next page...*

*Continued from previous page...*

<b>Mol</b>	<b>Chain</b>	<b>Res</b>	<b>Type</b>
40	n	123	PRO
40	n	262	TYR
43	q	181	LYS
44	r	170	ARG
45	s	55	PRO
46	t	138	LYS
48	v	276	HIS
49	w	142	VAL
50	x	21	GLU
50	x	25	ILE
50	x	41	THR
50	x	180	HIS
50	x	338	ALA
56	4	256	GLU
56	4	380	THR
2	B	10	ARG
2	B	129	ALA
2	B	137	TYR
2	B	343	TYR
4	D	258	LYS
10	J	55	ARG
10	J	64	LYS
11	K	49	SER
11	K	284	ASN
12	L	76	THR
14	N	94	TYR
15	O	48	PHE
21	U	11	ILE
21	U	110	VAL
28	b	87	GLU
28	b	247	ARG
28	b	585	GLN
35	i	27	SER
36	j	85	LYS
40	n	74	GLU
44	r	86	ALA
45	s	3	VAL
45	s	12	SER
46	t	57	ARG
47	u	3	ILE
48	v	270	ASP
48	v	285	LEU

*Continued on next page...*

*Continued from previous page...*

<b>Mol</b>	<b>Chain</b>	<b>Res</b>	<b>Type</b>
50	x	337	GLY
56	4	363	ASP
2	B	317	ILE
4	D	141	PRO
6	F	178	ILE
28	b	4	SER
28	b	282	SER
30	d	7	VAL
39	m	255	LEU
40	n	5	LYS
40	n	441	LEU
42	p	61	LYS
43	q	405	SER
46	t	269	GLN
49	w	77	VAL
50	x	484	GLY
40	n	448	LEU
47	u	131	PRO
49	w	123	ILE
49	w	143	PRO
50	x	400	GLY
7	G	36	ILE
15	O	79	ILE
15	O	88	VAL
23	W	171	ILE
40	n	384	GLY
7	G	30	THR
9	I	37	GLN
12	L	130	GLY
19	S	167	ARG
47	u	79	VAL
2	B	96	PRO
28	b	227	ARG
50	x	227	GLY
1	A	207	VAL
7	G	25	PRO
30	d	87	ASN
20	T	155	PRO



### 5.3.2 Protein sidechains [i](#)

In the following table, the Percentiles column shows the percent sidechain outliers of the chain as a percentile score with respect to all PDB entries followed by that with respect to all EM entries.

The Analysed column shows the number of residues for which the sidechain conformation was analysed, and the total number of residues.

Mol	Chain	Analysed	Rotameric	Outliers	Percentiles	
1	A	166/196 (85%)	157 (95%)	9 (5%)	22	52
2	B	322/323 (100%)	261 (81%)	61 (19%)	1	6
3	C	288/289 (100%)	272 (94%)	16 (6%)	21	51
4	D	227/245 (93%)	206 (91%)	21 (9%)	9	31
5	E	134/153 (88%)	125 (93%)	9 (7%)	16	45
6	F	186/205 (91%)	174 (94%)	12 (6%)	17	46
7	G	191/208 (92%)	175 (92%)	16 (8%)	11	36
8	H	171/171 (100%)	155 (91%)	16 (9%)	8	30
9	I	117/141 (83%)	111 (95%)	6 (5%)	24	54
10	J	147/150 (98%)	125 (85%)	22 (15%)	3	11
11	K	236/346 (68%)	224 (95%)	12 (5%)	24	54
12	L	149/159 (94%)	135 (91%)	14 (9%)	8	30
13	M	108/109 (99%)	105 (97%)	3 (3%)	43	71
14	N	175/176 (99%)	164 (94%)	11 (6%)	18	47
15	O	160/162 (99%)	145 (91%)	15 (9%)	8	30
16	P	145/146 (99%)	135 (93%)	10 (7%)	15	44
17	Q	110/151 (73%)	104 (94%)	6 (6%)	21	52
18	R	129/154 (84%)	119 (92%)	10 (8%)	12	39
19	S	155/156 (99%)	146 (94%)	9 (6%)	20	50
20	T	102/137 (74%)	89 (87%)	13 (13%)	4	17
21	U	93/107 (87%)	91 (98%)	2 (2%)	52	76
22	V	104/105 (99%)	98 (94%)	6 (6%)	20	50
23	W	211/213 (99%)	192 (91%)	19 (9%)	9	32
24	X	117/118 (99%)	103 (88%)	14 (12%)	5	19
25	Y	109/110 (99%)	103 (94%)	6 (6%)	21	52
26	Z	115/116 (99%)	109 (95%)	6 (5%)	23	54

*Continued on next page...*

Continued from previous page...

Mol	Chain	Analysed	Rotameric	Outliers	Percentiles	
27	a	76/119 (64%)	68 (90%)	8 (10%)	7	25
28	b	568/573 (99%)	506 (89%)	62 (11%)	6	24
29	c	81/88 (92%)	74 (91%)	7 (9%)	10	36
30	d	94/97 (97%)	85 (90%)	9 (10%)	8	29
31	e	109/111 (98%)	102 (94%)	7 (6%)	17	46
32	f	90/91 (99%)	85 (94%)	5 (6%)	21	51
33	g	95/103 (92%)	90 (95%)	5 (5%)	22	53
34	h	104/105 (99%)	93 (89%)	11 (11%)	6	24
35	i	81/82 (99%)	74 (91%)	7 (9%)	10	36
36	j	70/71 (99%)	66 (94%)	4 (6%)	20	50
37	k	68/69 (99%)	65 (96%)	3 (4%)	28	59
38	l	45/46 (98%)	38 (84%)	7 (16%)	2	10
39	m	413/428 (96%)	349 (84%)	64 (16%)	2	11
40	n	334/548 (61%)	310 (93%)	24 (7%)	14	42
41	o	118/199 (59%)	103 (87%)	15 (13%)	4	17
42	p	71/72 (99%)	69 (97%)	2 (3%)	43	71
43	q	171/420 (41%)	163 (95%)	8 (5%)	26	58
44	r	203/229 (89%)	185 (91%)	18 (9%)	9	33
45	s	62/445 (14%)	60 (97%)	2 (3%)	39	68
46	t	256/287 (89%)	235 (92%)	21 (8%)	11	37
47	u	133/180 (74%)	126 (95%)	7 (5%)	22	53
48	v	258/309 (84%)	252 (98%)	6 (2%)	50	75
49	w	161/179 (90%)	154 (96%)	7 (4%)	29	60
50	x	428/451 (95%)	407 (95%)	21 (5%)	25	56
51	y	210/211 (100%)	199 (95%)	11 (5%)	23	54
52	z	48/95 (50%)	45 (94%)	3 (6%)	18	47
56	4	453/520 (87%)	409 (90%)	44 (10%)	8	28
57	5	67/106 (63%)	53 (79%)	14 (21%)	1	4
All	All	9034/10780 (84%)	8288 (92%)	746 (8%)	15	37

All (746) residues with a non-rotameric sidechain are listed below:

Mol	Chain	Res	Type
1	A	30	ARG
1	A	46	LYS
1	A	47	GLN
1	A	101	VAL
1	A	104	LEU
1	A	122	ASP
1	A	161	ASP
1	A	204	MET
1	A	207	VAL
2	B	7	GLU
2	B	10	ARG
2	B	17	LEU
2	B	19	ARG
2	B	25	ILE
2	B	28	ARG
2	B	37	ARG
2	B	39	LYS
2	B	47	LEU
2	B	50	LYS
2	B	55	THR
2	B	77	THR
2	B	85	VAL
2	B	97	ARG
2	B	101	SER
2	B	102	LEU
2	B	108	GLU
2	B	115	LYS
2	B	123	TYR
2	B	137	TYR
2	B	148	LEU
2	B	156	SER
2	B	163	HIS
2	B	167	ARG
2	B	171	LEU
2	B	173	GLN
2	B	178	LEU
2	B	190	GLU
2	B	198	HIS
2	B	201	LYS
2	B	236	LYS
2	B	240	ARG
2	B	241	LYS
2	B	246	LEU

*Continued on next page...*

*Continued from previous page...*

<b>Mol</b>	<b>Chain</b>	<b>Res</b>	<b>Type</b>
2	B	252	ILE
2	B	255	TRP
2	B	274	SER
2	B	284	ARG
2	B	291	GLU
2	B	296	THR
2	B	300	ARG
2	B	303	LYS
2	B	304	THR
2	B	305	ILE
2	B	308	MET
2	B	319	ASN
2	B	323	MET
2	B	327	CYS
2	B	332	ARG
2	B	333	LYS
2	B	337	THR
2	B	339	ARG
2	B	341	SER
2	B	344	THR
2	B	351	LEU
2	B	353	GLU
2	B	364	LYS
2	B	375	GLU
2	B	377	HIS
2	B	385	LYS
2	B	386	ASP
3	C	5	GLN
3	C	14	GLU
3	C	93	MET
3	C	99	MET
3	C	112	LYS
3	C	156	LEU
3	C	170	LYS
3	C	179	LEU
3	C	187	LEU
3	C	194	TYR
3	C	203	ARG
3	C	246	ARG
3	C	294	GLU
3	C	307	GLN
3	C	313	LEU

*Continued on next page...*

*Continued from previous page...*

<b>Mol</b>	<b>Chain</b>	<b>Res</b>	<b>Type</b>
3	C	345	GLU
4	D	9	SER
4	D	16	PHE
4	D	17	GLN
4	D	23	ARG
4	D	39	GLN
4	D	43	LYS
4	D	48	LYS
4	D	105	ILE
4	D	117	GLU
4	D	136	GLU
4	D	168	ASP
4	D	172	TYR
4	D	176	SER
4	D	178	ASN
4	D	187	THR
4	D	226	TYR
4	D	263	GLU
4	D	264	GLN
4	D	273	ARG
4	D	277	LEU
4	D	293	LEU
5	E	9	TRP
5	E	18	LEU
5	E	21	THR
5	E	65	ILE
5	E	78	ARG
5	E	90	LYS
5	E	105	TYR
5	E	152	THR
5	E	173	MET
6	F	40	LYS
6	F	41	ARG
6	F	60	ARG
6	F	88	ARG
6	F	93	ASN
6	F	111	ILE
6	F	124	LEU
6	F	131	GLU
6	F	179	LEU
6	F	182	ASP
6	F	229	PHE

*Continued on next page...*

*Continued from previous page...*

<b>Mol</b>	<b>Chain</b>	<b>Res</b>	<b>Type</b>
6	F	239	LEU
7	G	41	GLN
7	G	63	LYS
7	G	79	GLN
7	G	84	ARG
7	G	89	GLU
7	G	134	TYR
7	G	146	LYS
7	G	150	LEU
7	G	163	VAL
7	G	204	ARG
7	G	228	GLU
7	G	229	VAL
7	G	238	LEU
7	G	241	LYS
7	G	245	LYS
7	G	248	LYS
8	H	5	GLN
8	H	21	LYS
8	H	41	ILE
8	H	49	ASN
8	H	68	LEU
8	H	69	ARG
8	H	107	ASP
8	H	118	LEU
8	H	139	ASN
8	H	157	ASN
8	H	164	ILE
8	H	170	LYS
8	H	172	ILE
8	H	173	ARG
8	H	189	GLU
8	H	191	LEU
9	I	32	GLN
9	I	46	LEU
9	I	60	THR
9	I	75	ARG
9	I	90	SER
9	I	116	LYS
10	J	7	ASN
10	J	10	ARG
10	J	12	LEU

*Continued on next page...*

*Continued from previous page...*

<b>Mol</b>	<b>Chain</b>	<b>Res</b>	<b>Type</b>
10	J	13	LYS
10	J	29	ARG
10	J	34	SER
10	J	46	VAL
10	J	80	LEU
10	J	84	LEU
10	J	94	ARG
10	J	106	ILE
10	J	107	ASP
10	J	112	LEU
10	J	115	LYS
10	J	120	ILE
10	J	130	VAL
10	J	138	VAL
10	J	140	ARG
10	J	142	LYS
10	J	148	VAL
10	J	158	ASP
10	J	166	LYS
11	K	50	LYS
11	K	85	ASN
11	K	105	SER
11	K	125	LEU
11	K	131	ASP
11	K	163	VAL
11	K	186	ILE
11	K	245	ASN
11	K	251	LEU
11	K	262	ASN
11	K	270	LEU
11	K	291	LEU
12	L	9	ILE
12	L	10	LEU
12	L	12	ASN
12	L	15	ARG
12	L	24	VAL
12	L	35	ARG
12	L	55	ARG
12	L	67	ARG
12	L	103	ASN
12	L	117	LYS
12	L	124	ILE

*Continued on next page...*

*Continued from previous page...*

<b>Mol</b>	<b>Chain</b>	<b>Res</b>	<b>Type</b>
12	L	131	LYS
12	L	134	GLU
12	L	136	GLU
13	M	8	LYS
13	M	12	TRP
13	M	38	ILE
14	N	10	LEU
14	N	38	ARG
14	N	62	TYR
14	N	83	LYS
14	N	87	GLN
14	N	105	ARG
14	N	113	LEU
14	N	133	ILE
14	N	151	ILE
14	N	183	THR
14	N	201	ARG
15	O	25	LYS
15	O	31	GLN
15	O	52	LEU
15	O	56	ASP
15	O	78	ARG
15	O	106	GLU
15	O	116	LYS
15	O	117	ARG
15	O	124	LEU
15	O	129	LEU
15	O	134	LYS
15	O	142	SER
15	O	148	LYS
15	O	151	ASP
15	O	187	GLU
16	P	49	GLU
16	P	55	GLN
16	P	69	ARG
16	P	96	GLN
16	P	120	ASN
16	P	125	GLN
16	P	139	TYR
16	P	168	LEU
16	P	173	ARG
16	P	180	LYS

*Continued on next page...*



*Continued from previous page...*

<b>Mol</b>	<b>Chain</b>	<b>Res</b>	<b>Type</b>
17	Q	20	LYS
17	Q	41	ASP
17	Q	49	LEU
17	Q	138	LEU
17	Q	147	ARG
17	Q	148	GLU
18	R	8	LYS
18	R	43	LYS
18	R	74	ARG
18	R	99	LEU
18	R	103	ARG
18	R	104	ARG
18	R	105	LEU
18	R	130	ASN
18	R	138	LEU
18	R	150	GLN
19	S	12	ARG
19	S	13	ARG
19	S	61	ILE
19	S	71	LYS
19	S	119	ARG
19	S	122	HIS
19	S	130	GLU
19	S	137	ARG
19	S	172	TYR
20	T	68	THR
20	T	75	ILE
20	T	79	MET
20	T	92	ARG
20	T	102	ARG
20	T	118	GLU
20	T	127	GLN
20	T	128	LEU
20	T	131	GLN
20	T	136	ARG
20	T	139	ARG
20	T	151	LEU
20	T	156	TYR
21	U	52	ASN
21	U	70	LYS
22	V	11	PHE
22	V	33	ASN

*Continued on next page...*

*Continued from previous page...*

<b>Mol</b>	<b>Chain</b>	<b>Res</b>	<b>Type</b>
22	V	48	ARG
22	V	72	LYS
22	V	74	MET
22	V	88	ARG
23	W	3	ARG
23	W	5	LYS
23	W	6	ARG
23	W	42	VAL
23	W	45	LEU
23	W	46	ASP
23	W	48	VAL
23	W	49	ARG
23	W	55	GLU
23	W	57	ARG
23	W	60	TRP
23	W	113	LYS
23	W	123	ASP
23	W	133	LEU
23	W	165	MET
23	W	170	GLU
23	W	174	LYS
23	W	187	LEU
23	W	216	LYS
24	X	27	ARG
24	X	36	LYS
24	X	38	LEU
24	X	40	LEU
24	X	45	LYS
24	X	61	LYS
24	X	63	ILE
24	X	73	MET
24	X	74	LYS
24	X	78	ASP
24	X	115	ARG
24	X	133	LEU
24	X	135	ILE
24	X	142	ILE
25	Y	17	LYS
25	Y	37	LYS
25	Y	50	ILE
25	Y	59	VAL
25	Y	74	TYR

*Continued on next page...*

*Continued from previous page...*

<b>Mol</b>	<b>Chain</b>	<b>Res</b>	<b>Type</b>
25	Y	126	LEU
26	Z	3	LYS
26	Z	15	ARG
26	Z	17	ARG
26	Z	64	LYS
26	Z	81	LEU
26	Z	99	GLU
27	a	58	MET
27	a	59	ARG
27	a	60	TYR
27	a	64	GLN
27	a	67	HIS
27	a	115	LYS
27	a	117	ARG
27	a	120	ASN
28	b	1	MET
28	b	10	THR
28	b	16	ASP
28	b	31	THR
28	b	48	ARG
28	b	70	ASN
28	b	81	LEU
28	b	87	GLU
28	b	120	GLN
28	b	133	LEU
28	b	142	LYS
28	b	168	ARG
28	b	169	THR
28	b	170	LEU
28	b	180	LYS
28	b	189	LYS
28	b	191	ASP
28	b	215	ARG
28	b	224	ILE
28	b	233	ASN
28	b	257	SER
28	b	258	GLU
28	b	270	LEU
28	b	281	LYS
28	b	292	ILE
28	b	294	ARG
28	b	296	GLU

*Continued on next page...*

*Continued from previous page...*

<b>Mol</b>	<b>Chain</b>	<b>Res</b>	<b>Type</b>
28	b	323	GLN
28	b	324	LEU
28	b	325	GLU
28	b	332	ARG
28	b	339	LEU
28	b	345	GLU
28	b	354	ILE
28	b	365	GLN
28	b	367	GLN
28	b	413	ASN
28	b	415	ASN
28	b	420	TYR
28	b	423	GLU
28	b	432	MET
28	b	434	GLU
28	b	439	LYS
28	b	440	ASN
28	b	445	LEU
28	b	453	LEU
28	b	482	GLU
28	b	499	ARG
28	b	526	LYS
28	b	535	MET
28	b	556	ASN
28	b	557	ARG
28	b	560	GLU
28	b	564	ASP
28	b	569	ASP
28	b	570	GLN
28	b	585	GLN
28	b	588	ARG
28	b	610	ARG
28	b	611	ARG
28	b	618	LYS
28	b	634	LEU
29	c	40	LYS
29	c	52	ARG
29	c	61	MET
29	c	76	GLU
29	c	83	LYS
29	c	101	LEU
29	c	104	LEU

*Continued on next page...*

*Continued from previous page...*

<b>Mol</b>	<b>Chain</b>	<b>Res</b>	<b>Type</b>
30	d	6	ASP
30	d	26	LYS
30	d	31	ARG
30	d	50	ARG
30	d	55	LEU
30	d	61	LYS
30	d	86	LYS
30	d	102	LYS
30	d	111	GLU
31	e	19	ARG
31	e	21	HIS
31	e	33	ARG
31	e	82	LEU
31	e	87	MET
31	e	103	LYS
31	e	126	LEU
32	f	10	LYS
32	f	19	SER
32	f	48	ARG
32	f	60	ARG
32	f	70	LYS
33	g	29	ILE
33	g	44	CYS
33	g	47	CYS
33	g	58	ARG
33	g	80	ARG
34	h	20	GLN
34	h	21	LEU
34	h	27	GLU
34	h	28	LEU
34	h	38	ARG
34	h	48	ARG
34	h	49	LYS
34	h	71	LYS
34	h	85	THR
34	h	89	ARG
34	h	119	LYS
35	i	28	TYR
35	i	45	ARG
35	i	51	SER
35	i	57	LEU
35	i	58	ILE

*Continued on next page...*

*Continued from previous page...*

<b>Mol</b>	<b>Chain</b>	<b>Res</b>	<b>Type</b>
35	i	60	LEU
35	i	68	ARG
36	j	15	SER
36	j	25	ARG
36	j	67	LEU
36	j	75	LYS
37	k	31	LEU
37	k	67	GLN
37	k	77	ARG
38	l	4	GLN
38	l	6	SER
38	l	21	ARG
38	l	23	LEU
38	l	29	LEU
38	l	47	THR
38	l	48	LYS
39	m	22	LEU
39	m	30	TYR
39	m	32	ASP
39	m	34	LYS
39	m	35	ARG
39	m	41	MET
39	m	62	GLN
39	m	83	VAL
39	m	98	GLU
39	m	100	GLN
39	m	106	VAL
39	m	125	GLU
39	m	130	ARG
39	m	132	LEU
39	m	133	ASP
39	m	148	LYS
39	m	152	LEU
39	m	166	GLU
39	m	172	GLU
39	m	174	LYS
39	m	191	GLU
39	m	202	ILE
39	m	210	ARG
39	m	211	ILE
39	m	224	VAL
39	m	226	ILE

*Continued on next page...*

*Continued from previous page...*

<b>Mol</b>	<b>Chain</b>	<b>Res</b>	<b>Type</b>
39	m	239	CYS
39	m	249	GLU
39	m	255	LEU
39	m	260	ASN
39	m	281	ARG
39	m	287	HIS
39	m	299	LEU
39	m	308	GLN
39	m	311	THR
39	m	313	ARG
39	m	315	GLN
39	m	318	VAL
39	m	328	LYS
39	m	338	LYS
39	m	343	VAL
39	m	351	LYS
39	m	353	TRP
39	m	358	LEU
39	m	359	MET
39	m	362	ILE
39	m	366	ASP
39	m	380	GLU
39	m	381	ASP
39	m	385	ARG
39	m	397	GLU
39	m	405	LYS
39	m	408	GLN
39	m	414	ARG
39	m	418	ILE
39	m	422	LYS
39	m	434	LYS
39	m	435	GLN
39	m	437	ARG
39	m	451	LYS
39	m	459	ARG
39	m	462	ILE
39	m	471	LYS
39	m	472	GLU
40	n	16	ILE
40	n	18	ARG
40	n	31	ASP
40	n	39	LYS

*Continued on next page...*

*Continued from previous page...*

<b>Mol</b>	<b>Chain</b>	<b>Res</b>	<b>Type</b>
40	n	53	ASN
40	n	84	LYS
40	n	90	LEU
40	n	94	LEU
40	n	112	TYR
40	n	117	ILE
40	n	120	GLU
40	n	132	ILE
40	n	158	ASP
40	n	230	HIS
40	n	256	ILE
40	n	263	ILE
40	n	267	ARG
40	n	351	LYS
40	n	354	SER
40	n	363	PHE
40	n	375	ILE
40	n	417	LEU
40	n	427	ILE
40	n	448	LEU
41	o	102	PHE
41	o	117	LEU
41	o	118	LYS
41	o	130	ASN
41	o	137	LEU
41	o	140	VAL
41	o	144	ASP
41	o	146	MET
41	o	158	MET
41	o	163	GLN
41	o	184	LEU
41	o	190	THR
41	o	205	GLU
41	o	217	GLU
41	o	220	TRP
42	p	11	THR
42	p	39	CYS
43	q	219	GLU
43	q	227	TYR
43	q	228	ASN
43	q	240	LYS
43	q	270	ASP

*Continued on next page...*



*Continued from previous page...*

<b>Mol</b>	<b>Chain</b>	<b>Res</b>	<b>Type</b>
43	q	402	LEU
43	q	436	ARG
43	q	446	THR
44	r	3	GLN
44	r	23	ARG
44	r	37	GLU
44	r	131	GLU
44	r	133	MET
44	r	162	THR
44	r	164	ARG
44	r	168	MET
44	r	177	LEU
44	r	203	ASN
44	r	205	GLN
44	r	212	LEU
44	r	224	ASN
44	r	225	VAL
44	r	236	LYS
44	r	237	VAL
44	r	248	GLU
44	r	250	ASP
45	s	33	MET
45	s	71	ASP
46	t	15	ASN
46	t	74	ARG
46	t	77	ARG
46	t	91	GLN
46	t	97	LYS
46	t	141	LEU
46	t	155	ILE
46	t	170	GLU
46	t	210	LYS
46	t	215	ILE
46	t	216	TYR
46	t	223	GLU
46	t	241	ASP
46	t	246	CYS
46	t	248	GLU
46	t	257	MET
46	t	268	LEU
46	t	269	GLN
46	t	275	ARG

*Continued on next page...*

*Continued from previous page...*

<b>Mol</b>	<b>Chain</b>	<b>Res</b>	<b>Type</b>
46	t	283	LEU
46	t	288	LYS
47	u	2	ARG
47	u	9	CYS
47	u	19	ILE
47	u	27	LYS
47	u	35	LYS
47	u	73	GLN
47	u	80	ARG
48	v	11	ARG
48	v	189	ASP
48	v	217	ARG
48	v	254	GLN
48	v	270	ASP
48	v	285	LEU
49	w	70	MET
49	w	88	THR
49	w	126	LYS
49	w	153	LYS
49	w	156	ASP
49	w	157	GLN
49	w	197	ARG
50	x	3	THR
50	x	20	ARG
50	x	57	GLU
50	x	63	LEU
50	x	66	GLN
50	x	78	THR
50	x	116	GLN
50	x	127	PHE
50	x	142	HIS
50	x	176	GLN
50	x	194	TRP
50	x	272	TYR
50	x	299	ARG
50	x	321	HIS
50	x	322	TRP
50	x	362	LYS
50	x	363	ILE
50	x	379	ASP
50	x	482	LEU
50	x	487	ASP

*Continued on next page...*

*Continued from previous page...*

<b>Mol</b>	<b>Chain</b>	<b>Res</b>	<b>Type</b>
50	x	491	THR
51	y	57	ARG
51	y	74	THR
51	y	79	GLN
51	y	85	ARG
51	y	101	LEU
51	y	109	CYS
51	y	139	ARG
51	y	150	SER
51	y	197	MET
51	y	209	ASP
51	y	232	ILE
52	z	5	LEU
52	z	37	LEU
52	z	46	LEU
56	4	21	GLN
56	4	22	GLU
56	4	29	ARG
56	4	33	GLN
56	4	39	LEU
56	4	48	ASP
56	4	56	GLN
56	4	60	THR
56	4	75	ARG
56	4	96	ASP
56	4	112	GLN
56	4	121	LYS
56	4	130	THR
56	4	161	TYR
56	4	177	LEU
56	4	197	LEU
56	4	202	LEU
56	4	243	ARG
56	4	245	ARG
56	4	248	ARG
56	4	251	LEU
56	4	263	GLU
56	4	323	MET
56	4	337	LEU
56	4	338	GLU
56	4	346	LYS
56	4	353	LEU

*Continued on next page...*

*Continued from previous page...*

Mol	Chain	Res	Type
56	4	378	LEU
56	4	379	LEU
56	4	398	ASN
56	4	412	LEU
56	4	416	LEU
56	4	434	GLU
56	4	441	ARG
56	4	473	LEU
56	4	475	LEU
56	4	485	LEU
56	4	487	SER
56	4	489	MET
56	4	519	ARG
56	4	536	TRP
56	4	562	ASP
56	4	568	LEU
56	4	571	GLU
57	5	46	LEU
57	5	59	GLU
57	5	61	LEU
57	5	68	LYS
57	5	72	ARG
57	5	78	MET
57	5	83	ARG
57	5	85	LYS
57	5	91	ARG
57	5	98	LYS
57	5	102	LYS
57	5	103	LYS
57	5	108	ARG
57	5	111	GLU

Sometimes sidechains can be flipped to improve hydrogen bonding and reduce clashes. All (97) such sidechains are listed below:

Mol	Chain	Res	Type
1	A	8	GLN
1	A	97	ASN
1	A	209	HIS
2	B	139	GLN
2	B	319	ASN
3	C	48	GLN
3	C	114	ASN

*Continued on next page...*

*Continued from previous page...*

<b>Mol</b>	<b>Chain</b>	<b>Res</b>	<b>Type</b>
3	C	221	ASN
3	C	260	GLN
3	C	304	GLN
3	C	307	GLN
4	D	17	GLN
4	D	39	GLN
5	E	57	HIS
5	E	167	ASN
6	F	37	ASN
6	F	244	ASN
7	G	33	ASN
7	G	38	GLN
7	G	41	GLN
7	G	85	ASN
7	G	95	ASN
7	G	145	ASN
7	G	243	GLN
8	H	49	ASN
8	H	125	ASN
8	H	139	ASN
9	I	97	ASN
12	L	103	ASN
12	L	114	GLN
14	N	182	ASN
15	O	31	GLN
15	O	50	ASN
15	O	65	ASN
16	P	28	ASN
16	P	133	HIS
19	S	8	GLN
19	S	63	GLN
20	T	58	GLN
21	U	87	ASN
22	V	33	ASN
22	V	47	ASN
22	V	98	ASN
23	W	74	GLN
23	W	91	GLN
23	W	167	ASN
23	W	205	GLN
23	W	223	ASN
26	Z	57	HIS

*Continued on next page...*

*Continued from previous page...*

<b>Mol</b>	<b>Chain</b>	<b>Res</b>	<b>Type</b>
27	a	64	GLN
27	a	67	HIS
28	b	26	GLN
28	b	323	GLN
28	b	333	ASN
28	b	367	GLN
28	b	406	ASN
28	b	500	GLN
28	b	546	GLN
28	b	579	ASN
30	d	57	GLN
30	d	87	ASN
31	e	104	ASN
33	g	3	GLN
33	g	33	GLN
34	h	34	GLN
34	h	62	GLN
38	l	4	GLN
38	l	20	ASN
39	m	146	GLN
39	m	455	ASN
40	n	208	ASN
40	n	428	GLN
41	o	130	ASN
41	o	199	ASN
44	r	4	ASN
44	r	10	HIS
44	r	14	HIS
44	r	203	ASN
44	r	224	ASN
46	t	44	GLN
47	u	37	HIS
47	u	42	GLN
50	x	154	HIS
50	x	176	GLN
50	x	208	ASN
50	x	406	ASN
51	y	6	GLN
51	y	11	ASN
51	y	33	ASN
51	y	106	ASN
51	y	145	ASN

*Continued on next page...*

*Continued from previous page...*

Mol	Chain	Res	Type
56	4	21	GLN
56	4	33	GLN
56	4	51	HIS
56	4	118	ASN
56	4	447	HIS
56	4	577	GLN

### 5.3.3 RNA [i](#)

Mol	Chain	Analysed	Backbone Outliers	Pucker Outliers
53	1	3048/3396 (89%)	923 (30%)	216 (7%)
54	2	157/158 (99%)	38 (24%)	5 (3%)
55	3	120/121 (99%)	22 (18%)	4 (3%)
58	6	64/232 (27%)	41 (64%)	10 (15%)
All	All	3389/3907 (86%)	1024 (30%)	235 (6%)

All (1024) RNA backbone outliers are listed below:

Mol	Chain	Res	Type
53	1	7	C
53	1	11	A
53	1	13	A
53	1	14	U
53	1	16	A
53	1	26	A
53	1	40	A
53	1	41	G
53	1	49	A
53	1	51	A
53	1	57	A
53	1	59	G
53	1	60	A
53	1	65	A
53	1	66	A
53	1	74	G
53	1	75	G
53	1	92	G
53	1	93	C
53	1	105	C
53	1	109	A
53	1	110	G

*Continued on next page...*

*Continued from previous page...*

<b>Mol</b>	<b>Chain</b>	<b>Res</b>	<b>Type</b>
53	1	111	C
53	1	116	A
53	1	121	A
53	1	122	A
53	1	133	U
53	1	135	C
53	1	136	G
53	1	143	G
53	1	148	G
53	1	156	G
53	1	157	A
53	1	161	G
53	1	165	A
53	1	166	C
53	1	170	G
53	1	171	G
53	1	173	G
53	1	182	U
53	1	185	C
53	1	187	A
53	1	190	U
53	1	191	U
53	1	200	C
53	1	201	A
53	1	206	G
53	1	210	U
53	1	211	A
53	1	213	A
53	1	218	G
53	1	219	A
53	1	220	G
53	1	234	G
53	1	240	U
53	1	241	G
53	1	243	G
53	1	249	U
53	1	250	U
53	1	251	G
53	1	252	U
53	1	256	G
53	1	262	U
53	1	264	G

*Continued on next page...*



*Continued from previous page...*

<b>Mol</b>	<b>Chain</b>	<b>Res</b>	<b>Type</b>
53	1	266	A
53	1	269	G
53	1	284	A
53	1	285	A
53	1	286	U
53	1	292	U
53	1	295	A
53	1	298	U
53	1	304	G
53	1	305	U
53	1	306	A
53	1	307	A
53	1	315	C
53	1	323	A
53	1	329	U
53	1	333	G
53	1	334	A
53	1	339	C
53	1	346	C
53	1	370	U
53	1	375	A
53	1	376	G
53	1	385	A
53	1	395	A
53	1	398	A
53	1	399	A
53	1	401	U
53	1	402	A
53	1	403	C
53	1	421	G
53	1	422	A
53	1	429	U
53	1	438	A
53	1	439	C
53	1	440	A
53	1	495	G
53	1	503	C
53	1	507	U
53	1	517	G
53	1	518	G
53	1	519	A
53	1	520	U

*Continued on next page...*

*Continued from previous page...*

<b>Mol</b>	<b>Chain</b>	<b>Res</b>	<b>Type</b>
53	1	521	A
53	1	523	A
53	1	535	G
53	1	537	A
53	1	544	C
53	1	545	U
53	1	547	G
53	1	548	G
53	1	549	U
53	1	550	A
53	1	552	G
53	1	555	U
53	1	556	U
53	1	557	A
53	1	559	A
53	1	569	A
53	1	578	A
53	1	579	G
53	1	592	A
53	1	594	U
53	1	595	G
53	1	604	G
53	1	607	A
53	1	609	G
53	1	611	A
53	1	620	U
53	1	621	A
53	1	622	A
53	1	623	U
53	1	636	C
53	1	637	C
53	1	638	C
53	1	643	U
53	1	644	G
53	1	645	A
53	1	646	A
53	1	647	A
53	1	650	C
53	1	660	A
53	1	662	U
53	1	677	A
53	1	681	U

*Continued on next page...*

*Continued from previous page...*

<b>Mol</b>	<b>Chain</b>	<b>Res</b>	<b>Type</b>
53	1	684	G
53	1	690	A
53	1	691	A
53	1	705	A
53	1	708	G
53	1	711	A
53	1	712	G
53	1	721	G
53	1	722	G
53	1	726	G
53	1	739	G
53	1	746	A
53	1	762	U
53	1	763	G
53	1	764	U
53	1	765	C
53	1	766	U
53	1	767	U
53	1	776	U
53	1	777	U
53	1	778	U
53	1	779	G
53	1	780	A
53	1	781	G
53	1	785	G
53	1	786	A
53	1	794	U
53	1	800	G
53	1	801	A
53	1	806	A
53	1	808	A
53	1	817	A
53	1	826	G
53	1	829	U
53	1	830	A
53	1	834	U
53	1	837	A
53	1	849	C
53	1	850	U
53	1	861	C
53	1	869	G
53	1	874	U

*Continued on next page...*

*Continued from previous page...*

<b>Mol</b>	<b>Chain</b>	<b>Res</b>	<b>Type</b>
53	1	875	G
53	1	876	A
53	1	879	U
53	1	895	A
53	1	896	A
53	1	897	U
53	1	907	G
53	1	908	G
53	1	909	G
53	1	914	A
53	1	916	G
53	1	917	A
53	1	921	A
53	1	923	C
53	1	936	A
53	1	938	C
53	1	944	C
53	1	955	U
53	1	956	U
53	1	957	C
53	1	958	C
53	1	959	C
53	1	962	A
53	1	967	A
53	1	974	G
53	1	976	U
53	1	977	C
53	1	978	G
53	1	979	U
53	1	980	A
53	1	982	C
53	1	984	G
53	1	991	G
53	1	992	A
53	1	994	G
53	1	996	A
53	1	997	A
53	1	998	A
53	1	1000	C
53	1	1001	G
53	1	1002	A
53	1	1003	A

*Continued on next page...*

*Continued from previous page...*

<b>Mol</b>	<b>Chain</b>	<b>Res</b>	<b>Type</b>
53	1	1048	A
53	1	1049	C
53	1	1051	U
53	1	1052	U
53	1	1054	A
53	1	1055	A
53	1	1056	U
53	1	1057	A
53	1	1058	U
53	1	1063	G
53	1	1064	A
53	1	1065	A
53	1	1085	A
53	1	1086	C
53	1	1089	G
53	1	1090	G
53	1	1092	C
53	1	1093	A
53	1	1094	U
53	1	1095	U
53	1	1098	A
53	1	1101	G
53	1	1103	A
53	1	1104	G
53	1	1106	G
53	1	1107	C
53	1	1109	U
53	1	1111	U
53	1	1112	A
53	1	1114	U
53	1	1115	G
53	1	1116	G
53	1	1117	G
53	1	1118	C
53	1	1127	G
53	1	1129	A
53	1	1130	A
53	1	1132	C
53	1	1136	A
53	1	1145	G
53	1	1151	U
53	1	1153	A

*Continued on next page...*

*Continued from previous page...*

<b>Mol</b>	<b>Chain</b>	<b>Res</b>	<b>Type</b>
53	1	1155	C
53	1	1160	C
53	1	1177	G
53	1	1178	G
53	1	1180	A
53	1	1181	U
53	1	1182	A
53	1	1186	G
53	1	1191	U
53	1	1192	C
53	1	1193	A
53	1	1196	C
53	1	1197	A
53	1	1198	C
53	1	1199	C
53	1	1200	A
53	1	1201	C
53	1	1202	A
53	1	1203	A
53	1	1204	A
53	1	1206	G
53	1	1207	G
53	1	1208	U
53	1	1209	G
53	1	1210	U
53	1	1217	A
53	1	1220	U
53	1	1221	A
53	1	1227	C
53	1	1234	G
53	1	1235	U
53	1	1236	G
53	1	1237	G
53	1	1239	C
53	1	1241	U
53	1	1242	G
53	1	1243	G
53	1	1244	A
53	1	1245	A
53	1	1247	U
53	1	1248	C
53	1	1252	A

*Continued on next page...*

*Continued from previous page...*

<b>Mol</b>	<b>Chain</b>	<b>Res</b>	<b>Type</b>
53	1	1254	C
53	1	1258	U
53	1	1262	G
53	1	1263	A
53	1	1264	G
53	1	1265	U
53	1	1266	G
53	1	1272	C
53	1	1278	A
53	1	1279	C
53	1	1281	G
53	1	1282	G
53	1	1283	C
53	1	1286	A
53	1	1287	A
53	1	1296	C
53	1	1299	U
53	1	1302	A
53	1	1303	A
53	1	1304	A
53	1	1307	G
53	1	1308	A
53	1	1313	G
53	1	1330	A
53	1	1331	U
53	1	1332	A
53	1	1348	U
53	1	1349	G
53	1	1351	U
53	1	1352	A
53	1	1353	U
53	1	1354	G
53	1	1356	U
53	1	1357	G
53	1	1367	G
53	1	1380	G
53	1	1383	G
53	1	1386	A
53	1	1399	A
53	1	1400	G
53	1	1404	G
53	1	1414	G

*Continued on next page...*

*Continued from previous page...*

<b>Mol</b>	<b>Chain</b>	<b>Res</b>	<b>Type</b>
53	1	1419	A
53	1	1421	G
53	1	1434	G
53	1	1437	C
53	1	1443	G
53	1	1450	G
53	1	1460	A
53	1	1471	U
53	1	1481	A
53	1	1483	G
53	1	1485	G
53	1	1487	G
53	1	1490	A
53	1	1503	A
53	1	1508	C
53	1	1523	U
53	1	1527	C
53	1	1531	C
53	1	1533	U
53	1	1536	G
53	1	1539	A
53	1	1549	U
53	1	1555	U
53	1	1556	C
53	1	1557	A
53	1	1560	G
53	1	1561	G
53	1	1562	C
53	1	1566	A
53	1	1567	U
53	1	1568	U
53	1	1569	U
53	1	1570	U
53	1	1571	A
53	1	1573	G
53	1	1575	A
53	1	1577	G
53	1	1580	A
53	1	1581	C
53	1	1582	C
53	1	1583	A
53	1	1587	A

*Continued on next page...*



*Continued from previous page...*

<b>Mol</b>	<b>Chain</b>	<b>Res</b>	<b>Type</b>
53	1	1589	A
53	1	1593	A
53	1	1607	U
53	1	1608	C
53	1	1620	U
53	1	1622	U
53	1	1629	U
53	1	1631	C
53	1	1632	A
53	1	1639	C
53	1	1641	U
53	1	1642	A
53	1	1643	A
53	1	1645	U
53	1	1657	C
53	1	1658	G
53	1	1662	G
53	1	1683	A
53	1	1701	C
53	1	1703	U
53	1	1716	U
53	1	1717	U
53	1	1718	G
53	1	1724	U
53	1	1725	C
53	1	1741	A
53	1	1746	U
53	1	1750	A
53	1	1751	G
53	1	1759	C
53	1	1760	A
53	1	1762	C
53	1	1763	U
53	1	1765	U
53	1	1766	G
53	1	1770	G
53	1	1775	G
53	1	1780	G
53	1	1794	G
53	1	1797	A
53	1	1810	A
53	1	1813	A

*Continued on next page...*

*Continued from previous page...*

<b>Mol</b>	<b>Chain</b>	<b>Res</b>	<b>Type</b>
53	1	1814	A
53	1	1815	U
53	1	1816	A
53	1	1817	G
53	1	1820	U
53	1	1821	U
53	1	1822	C
53	1	1837	U
53	1	1839	A
53	1	1841	A
53	1	1842	A
53	1	1849	C
53	1	1850	A
53	1	1858	A
53	1	1859	A
53	1	1866	C
53	1	1867	A
53	1	1871	U
53	1	1880	U
53	1	1886	A
53	1	1893	A
53	1	1906	G
53	1	1926	C
53	1	1937	U
53	1	1951	C
53	1	1952	G
53	1	1953	G
53	1	2094	C
53	1	2099	A
53	1	2100	A
53	1	2101	C
53	1	2102	U
53	1	2112	U
53	1	2121	G
53	1	2122	G
53	1	2126	A
53	1	2131	A
53	1	2140	U
53	1	2144	A
53	1	2145	A
53	1	2158	A
53	1	2163	C

*Continued on next page...*

*Continued from previous page...*

<b>Mol</b>	<b>Chain</b>	<b>Res</b>	<b>Type</b>
53	1	2164	A
53	1	2169	G
53	1	2170	U
53	1	2184	U
53	1	2185	G
53	1	2191	U
53	1	2193	U
53	1	2194	G
53	1	2195	C
53	1	2196	C
53	1	2198	A
53	1	2201	G
53	1	2205	U
53	1	2207	A
53	1	2208	A
53	1	2209	U
53	1	2210	G
53	1	2211	U
53	1	2226	U
53	1	2227	C
53	1	2228	A
53	1	2229	A
53	1	2235	C
53	1	2236	G
53	1	2238	G
53	1	2239	G
53	1	2242	A
53	1	2243	A
53	1	2244	A
53	1	2245	C
53	1	2246	G
53	1	2247	G
53	1	2248	C
53	1	2249	G
53	1	2250	G
53	1	2252	A
53	1	2255	A
53	1	2256	A
53	1	2257	C
53	1	2259	A
53	1	2263	C
53	1	2264	U

*Continued on next page...*

*Continued from previous page...*

<b>Mol</b>	<b>Chain</b>	<b>Res</b>	<b>Type</b>
53	1	2268	U
53	1	2269	U
53	1	2270	A
53	1	2271	A
53	1	2272	G
53	1	2273	G
53	1	2274	U
53	1	2276	G
53	1	2277	C
53	1	2278	C
53	1	2279	A
53	1	2280	A
53	1	2316	G
53	1	2317	A
53	1	2318	U
53	1	2334	U
53	1	2335	G
53	1	2336	U
53	1	2370	G
53	1	2371	G
53	1	2385	G
53	1	2388	U
53	1	2393	G
53	1	2397	A
53	1	2398	A
53	1	2401	A
53	1	2402	A
53	1	2410	U
53	1	2411	U
53	1	2412	G
53	1	2414	G
53	1	2418	G
53	1	2419	A
53	1	2428	U
53	1	2429	G
53	1	2430	A
53	1	2435	G
53	1	2437	G
53	1	2444	C
53	1	2445	A
53	1	2502	A
53	1	2503	G

*Continued on next page...*

*Continued from previous page...*

<b>Mol</b>	<b>Chain</b>	<b>Res</b>	<b>Type</b>
53	1	2504	U
53	1	2505	U
53	1	2506	U
53	1	2508	U
53	1	2510	U
53	1	2511	A
53	1	2514	U
53	1	2515	A
53	1	2522	G
53	1	2523	A
53	1	2526	C
53	1	2527	G
53	1	2528	G
53	1	2529	A
53	1	2530	G
53	1	2531	C
53	1	2532	U
53	1	2533	G
53	1	2534	G
53	1	2538	U
53	1	2539	C
53	1	2540	A
53	1	2541	U
53	1	2542	U
53	1	2543	U
53	1	2544	U
53	1	2545	C
53	1	2546	C
53	1	2547	A
53	1	2548	C
53	1	2549	G
53	1	2552	C
53	1	2554	A
53	1	2555	G
53	1	2561	A
53	1	2569	A
53	1	2570	U
53	1	2571	U
53	1	2572	C
53	1	2573	G
53	1	2575	G
53	1	2578	U

*Continued on next page...*

*Continued from previous page...*

<b>Mol</b>	<b>Chain</b>	<b>Res</b>	<b>Type</b>
53	1	2583	C
53	1	2586	G
53	1	2593	A
53	1	2594	C
53	1	2598	G
53	1	2602	G
53	1	2606	G
53	1	2607	G
53	1	2614	G
53	1	2615	G
53	1	2620	G
53	1	2621	G
53	1	2623	G
53	1	2625	C
53	1	2626	A
53	1	2645	G
53	1	2650	U
53	1	2651	G
53	1	2652	U
53	1	2653	C
53	1	2654	C
53	1	2655	U
53	1	2656	A
53	1	2657	A
53	1	2659	G
53	1	2663	G
53	1	2667	A
53	1	2674	A
53	1	2677	G
53	1	2681	U
53	1	2685	C
53	1	2686	A
53	1	2688	U
53	1	2690	G
53	1	2691	A
53	1	2692	A
53	1	2693	C
53	1	2694	A
53	1	2696	A
53	1	2697	A
53	1	2698	G
53	1	2700	G

*Continued on next page...*

*Continued from previous page...*

<b>Mol</b>	<b>Chain</b>	<b>Res</b>	<b>Type</b>
53	1	2701	U
53	1	2702	A
53	1	2703	A
53	1	2704	A
53	1	2707	C
53	1	2712	U
53	1	2713	U
53	1	2714	G
53	1	2715	A
53	1	2716	U
53	1	2717	U
53	1	2718	U
53	1	2719	U
53	1	2720	G
53	1	2721	A
53	1	2724	U
53	1	2725	U
53	1	2726	C
53	1	2727	A
53	1	2728	G
53	1	2729	U
53	1	2730	G
53	1	2731	U
53	1	2732	G
53	1	2740	A
53	1	2747	A
53	1	2749	G
53	1	2752	U
53	1	2754	G
53	1	2756	C
53	1	2758	A
53	1	2759	U
53	1	2760	C
53	1	2761	G
53	1	2762	A
53	1	2763	U
53	1	2764	C
53	1	2765	C
53	1	2766	U
53	1	2767	U
53	1	2768	U
53	1	2769	A

*Continued on next page...*

*Continued from previous page...*

<b>Mol</b>	<b>Chain</b>	<b>Res</b>	<b>Type</b>
53	1	2770	G
53	1	2771	U
53	1	2772	C
53	1	2773	C
53	1	2774	C
53	1	2777	G
53	1	2778	G
53	1	2779	A
53	1	2785	A
53	1	2786	G
53	1	2787	G
53	1	2788	C
53	1	2790	A
53	1	2791	G
53	1	2793	G
53	1	2794	G
53	1	2795	U
53	1	2796	G
53	1	2797	C
53	1	2798	C
53	1	2799	A
53	1	2801	A
53	1	2802	A
53	1	2803	A
53	1	2804	A
53	1	2810	C
53	1	2814	G
53	1	2816	G
53	1	2817	A
53	1	2818	U
53	1	2819	A
53	1	2820	A
53	1	2821	C
53	1	2822	U
53	1	2824	G
53	1	2825	C
53	1	2826	U
53	1	2840	C
53	1	2842	U
53	1	2845	A
53	1	2847	A
53	1	2848	G

*Continued on next page...*



*Continued from previous page...*

<b>Mol</b>	<b>Chain</b>	<b>Res</b>	<b>Type</b>
53	1	2857	C
53	1	2858	U
53	1	2859	U
53	1	2861	U
53	1	2863	G
53	1	2864	A
53	1	2865	U
53	1	2866	U
53	1	2867	C
53	1	2868	U
53	1	2869	U
53	1	2870	C
53	1	2871	G
53	1	2872	A
53	1	2873	U
53	1	2874	G
53	1	2875	U
53	1	2876	C
53	1	2877	G
53	1	2878	G
53	1	2879	C
53	1	2887	A
53	1	2889	C
53	1	2891	U
53	1	2898	G
53	1	2899	C
53	1	2901	G
53	1	2902	A
53	1	2918	G
53	1	2923	U
53	1	2924	U
53	1	2925	C
53	1	2926	A
53	1	2927	C
53	1	2928	C
53	1	2930	A
53	1	2935	U
53	1	2936	A
53	1	2944	U
53	1	2945	G
53	1	2946	A
53	1	2947	G

*Continued on next page...*

*Continued from previous page...*

<b>Mol</b>	<b>Chain</b>	<b>Res</b>	<b>Type</b>
53	1	2948	C
53	1	2952	G
53	1	2953	U
53	1	2954	U
53	1	2955	U
53	1	2956	A
53	1	2957	G
53	1	2966	G
53	1	2970	C
53	1	2971	A
53	1	2972	G
53	1	2978	U
53	1	2979	U
53	1	2980	U
53	1	2981	U
53	1	2982	A
53	1	2983	C
53	1	2984	C
53	1	2990	G
53	1	2996	U
53	1	2997	G
53	1	3006	A
53	1	3012	A
53	1	3017	A
53	1	3021	A
53	1	3022	G
53	1	3023	U
53	1	3026	G
53	1	3029	A
53	1	3030	G
53	1	3031	G
53	1	3032	A
53	1	3034	C
53	1	3035	A
53	1	3040	A
53	1	3049	A
53	1	3056	U
53	1	3057	U
53	1	3058	U
53	1	3059	G
53	1	3074	G
53	1	3078	U

*Continued on next page...*

*Continued from previous page...*

<b>Mol</b>	<b>Chain</b>	<b>Res</b>	<b>Type</b>
53	1	3079	U
53	1	3080	G
53	1	3086	A
53	1	3092	C
53	1	3093	C
53	1	3094	A
53	1	3095	U
53	1	3100	U
53	1	3102	G
53	1	3109	G
53	1	3116	G
53	1	3117	C
53	1	3122	A
53	1	3127	A
53	1	3129	A
53	1	3130	A
53	1	3131	U
53	1	3142	A
53	1	3143	C
53	1	3150	A
53	1	3151	U
53	1	3153	U
53	1	3154	C
53	1	3155	U
53	1	3156	U
53	1	3157	U
53	1	3158	G
53	1	3160	U
53	1	3162	C
53	1	3164	C
53	1	3165	A
53	1	3168	A
53	1	3172	A
53	1	3173	G
53	1	3174	A
53	1	3176	G
53	1	3179	U
53	1	3180	A
53	1	3181	C
53	1	3184	A
53	1	3187	A
53	1	3196	U

*Continued on next page...*

*Continued from previous page...*

<b>Mol</b>	<b>Chain</b>	<b>Res</b>	<b>Type</b>
53	1	3197	G
53	1	3198	U
53	1	3199	G
53	1	3202	G
53	1	3207	U
53	1	3217	C
53	1	3218	A
53	1	3219	G
53	1	3229	G
53	1	3239	G
53	1	3242	G
53	1	3243	A
53	1	3245	A
53	1	3246	G
53	1	3247	G
53	1	3259	U
53	1	3263	G
53	1	3268	A
53	1	3270	U
53	1	3273	A
53	1	3276	G
53	1	3278	C
53	1	3279	A
53	1	3281	U
53	1	3282	U
53	1	3283	U
53	1	3285	C
53	1	3286	G
53	1	3289	G
53	1	3294	A
53	1	3295	A
53	1	3304	U
53	1	3307	A
53	1	3313	U
53	1	3316	A
53	1	3317	U
53	1	3318	G
53	1	3319	U
53	1	3320	A
53	1	3328	G
53	1	3339	A
53	1	3341	U

*Continued on next page...*

*Continued from previous page...*

<b>Mol</b>	<b>Chain</b>	<b>Res</b>	<b>Type</b>
53	1	3342	A
53	1	3345	G
53	1	3346	U
53	1	3347	A
53	1	3350	C
53	1	3351	U
53	1	3352	U
53	1	3353	G
53	1	3354	U
53	1	3355	U
53	1	3356	G
53	1	3360	C
53	1	3363	U
53	1	3369	G
53	1	3375	A
53	1	3376	A
53	1	3378	C
53	1	3381	U
53	1	3389	U
54	2	25	G
54	2	34	U
54	2	35	C
54	2	49	G
54	2	51	G
54	2	52	A
54	2	53	A
54	2	56	G
54	2	59	A
54	2	62	C
54	2	63	G
54	2	76	C
54	2	79	A
54	2	80	A
54	2	81	U
54	2	82	U
54	2	84	C
54	2	85	G
54	2	86	U
54	2	87	G
54	2	88	A
54	2	89	A
54	2	90	U

*Continued on next page...*

*Continued from previous page...*

<b>Mol</b>	<b>Chain</b>	<b>Res</b>	<b>Type</b>
54	2	95	G
54	2	97	A
54	2	104	A
54	2	105	A
54	2	106	C
54	2	111	A
54	2	113	U
54	2	116	G
54	2	124	G
54	2	125	U
54	2	126	A
54	2	128	U
54	2	138	A
54	2	151	C
54	2	152	G
55	3	7	G
55	3	8	G
55	3	13	A
55	3	22	A
55	3	42	A
55	3	53	U
55	3	54	U
55	3	55	A
55	3	60	G
55	3	65	G
55	3	87	G
55	3	97	A
55	3	98	C
55	3	99	G
55	3	102	A
55	3	104	A
55	3	107	C
55	3	109	G
55	3	112	G
55	3	114	U
55	3	118	A
55	3	121	U
58	6	2	C
58	6	4	U
58	6	5	C
58	6	6	U
58	6	7	C

*Continued on next page...*

*Continued from previous page...*

Mol	Chain	Res	Type
58	6	8	A
58	6	9	A
58	6	13	U
58	6	14	U
58	6	16	U
58	6	17	G
58	6	18	U
58	6	21	G
58	6	23	U
58	6	24	A
58	6	25	G
58	6	26	U
58	6	27	G
58	6	31	G
58	6	32	A
58	6	33	U
58	6	34	A
58	6	40	U
58	6	41	G
58	6	42	G
58	6	43	A
58	6	45	U
58	6	47	A
58	6	48	A
58	6	49	C
58	6	53	A
58	6	54	A
58	6	56	U
58	6	57	U
58	6	58	G
58	6	59	C
58	6	228	U
58	6	229	U
58	6	230	A
58	6	231	A
58	6	232	A

All (235) RNA pucker outliers are listed below:

Mol	Chain	Res	Type
53	1	13	A
53	1	40	A

*Continued on next page...*

*Continued from previous page...*

<b>Mol</b>	<b>Chain</b>	<b>Res</b>	<b>Type</b>
53	1	73	C
53	1	133	U
53	1	148	G
53	1	160	G
53	1	169	U
53	1	210	U
53	1	239	G
53	1	284	A
53	1	285	A
53	1	304	G
53	1	305	U
53	1	402	A
53	1	406	G
53	1	439	C
53	1	518	G
53	1	588	G
53	1	594	U
53	1	607	A
53	1	637	C
53	1	645	A
53	1	649	A
53	1	718	G
53	1	720	A
53	1	760	G
53	1	761	A
53	1	765	C
53	1	766	U
53	1	770	G
53	1	800	G
53	1	806	A
53	1	816	A
53	1	849	C
53	1	896	A
53	1	916	G
53	1	990	U
53	1	994	G
53	1	998	A
53	1	1056	U
53	1	1057	A
53	1	1064	A
53	1	1097	G
53	1	1102	A

*Continued on next page...*



*Continued from previous page...*

<b>Mol</b>	<b>Chain</b>	<b>Res</b>	<b>Type</b>
53	1	1103	A
53	1	1111	U
53	1	1128	U
53	1	1144	U
53	1	1152	G
53	1	1159	A
53	1	1191	U
53	1	1192	C
53	1	1201	C
53	1	1203	A
53	1	1205	A
53	1	1241	U
53	1	1244	A
53	1	1281	G
53	1	1282	G
53	1	1286	A
53	1	1302	A
53	1	1307	G
53	1	1329	U
53	1	1355	A
53	1	1467	A
53	1	1482	A
53	1	1484	U
53	1	1502	C
53	1	1525	G
53	1	1554	U
53	1	1556	C
53	1	1560	G
53	1	1567	U
53	1	1568	U
53	1	1569	U
53	1	1570	U
53	1	1573	G
53	1	1574	C
53	1	1580	A
53	1	1581	C
53	1	1582	C
53	1	1606	U
53	1	1607	U
53	1	1630	U
53	1	1641	U
53	1	1643	A

*Continued on next page...*

*Continued from previous page...*

<b>Mol</b>	<b>Chain</b>	<b>Res</b>	<b>Type</b>
53	1	1657	C
53	1	1716	U
53	1	1814	A
53	1	1816	A
53	1	1820	U
53	1	1841	A
53	1	1846	C
53	1	1858	A
53	1	2101	C
53	1	2113	A
53	1	2144	A
53	1	2209	U
53	1	2235	C
53	1	2238	G
53	1	2243	A
53	1	2244	A
53	1	2255	A
53	1	2256	A
53	1	2261	G
53	1	2263	C
53	1	2268	U
53	1	2269	U
53	1	2271	A
53	1	2272	G
53	1	2275	A
53	1	2277	C
53	1	2316	G
53	1	2317	A
53	1	2410	U
53	1	2411	U
53	1	2428	U
53	1	2429	G
53	1	2444	C
53	1	2510	U
53	1	2511	A
53	1	2513	U
53	1	2522	G
53	1	2525	G
53	1	2527	G
53	1	2528	G
53	1	2537	U
53	1	2541	U

*Continued on next page...*

*Continued from previous page...*

<b>Mol</b>	<b>Chain</b>	<b>Res</b>	<b>Type</b>
53	1	2547	A
53	1	2548	C
53	1	2554	A
53	1	2568	C
53	1	2570	U
53	1	2572	C
53	1	2593	A
53	1	2598	G
53	1	2624	G
53	1	2625	C
53	1	2650	U
53	1	2651	G
53	1	2652	U
53	1	2654	C
53	1	2655	U
53	1	2658	G
53	1	2680	A
53	1	2688	U
53	1	2691	A
53	1	2692	A
53	1	2695	A
53	1	2716	U
53	1	2719	U
53	1	2725	U
53	1	2726	C
53	1	2727	A
53	1	2728	G
53	1	2729	U
53	1	2753	G
53	1	2758	A
53	1	2761	G
53	1	2763	U
53	1	2770	G
53	1	2793	G
53	1	2795	U
53	1	2796	G
53	1	2797	C
53	1	2798	C
53	1	2802	A
53	1	2817	A
53	1	2818	U
53	1	2819	A

*Continued on next page...*

*Continued from previous page...*

<b>Mol</b>	<b>Chain</b>	<b>Res</b>	<b>Type</b>
53	1	2825	C
53	1	2857	C
53	1	2858	U
53	1	2865	U
53	1	2866	U
53	1	2868	U
53	1	2869	U
53	1	2870	C
53	1	2875	U
53	1	2900	A
53	1	2946	A
53	1	2954	U
53	1	2970	C
53	1	2983	C
53	1	3030	G
53	1	3048	A
53	1	3055	U
53	1	3056	U
53	1	3057	U
53	1	3078	U
53	1	3093	C
53	1	3116	G
53	1	3153	U
53	1	3154	C
53	1	3155	U
53	1	3156	U
53	1	3157	U
53	1	3158	G
53	1	3171	U
53	1	3195	U
53	1	3207	U
53	1	3218	A
53	1	3228	C
53	1	3242	G
53	1	3267	A
53	1	3269	U
53	1	3278	C
53	1	3279	A
53	1	3316	A
53	1	3340	G
53	1	3341	U
53	1	3350	C

*Continued on next page...*

*Continued from previous page...*

Mol	Chain	Res	Type
53	1	3351	U
53	1	3353	G
53	1	3375	A
53	1	3389	U
54	2	80	A
54	2	81	U
54	2	83	C
54	2	88	A
54	2	123	G
55	3	52	G
55	3	97	A
55	3	98	C
55	3	111	U
58	6	1	C
58	6	5	C
58	6	16	U
58	6	23	U
58	6	24	A
58	6	25	G
58	6	26	U
58	6	57	U
58	6	228	U
58	6	231	A

#### 5.4 Non-standard residues in protein, DNA, RNA chains [i](#)

There are no non-standard protein/DNA/RNA residues in this entry.

#### 5.5 Carbohydrates [i](#)

There are no monosaccharides in this entry.

#### 5.6 Ligand geometry [i](#)

Of 8 ligands modelled in this entry, 6 are monoatomic - leaving 2 for Mogul analysis.

In the following table, the Counts columns list the number of bonds (or angles) for which Mogul statistics could be retrieved, the number of bonds (or angles) that are observed in the model and the number of bonds (or angles) that are defined in the Chemical Component Dictionary. The Link column lists molecule types, if any, to which the group is linked. The Z score for a bond length (or angle) is the number of standard deviations the observed value is removed from the

expected value. A bond length (or angle) with  $|Z| > 2$  is considered an outlier worth inspection. RMSZ is the root-mean-square of all Z scores of the bond lengths (or angles).

Mol	Type	Chain	Res	Link	Bond lengths			Bond angles		
					Counts	RMSZ	$\# Z  > 2$	Counts	RMSZ	$\# Z  > 2$
60	GTP	m	501	61	26,34,34	0.98	1 (3%)	32,54,54	1.84	6 (18%)
60	GTP	b	701	61	26,34,34	0.92	1 (3%)	32,54,54	1.36	4 (12%)

In the following table, the Chirals column lists the number of chiral outliers, the number of chiral centers analysed, the number of these observed in the model and the number defined in the Chemical Component Dictionary. Similar counts are reported in the Torsion and Rings columns. '-' means no outliers of that kind were identified.

Mol	Type	Chain	Res	Link	Chirals	Torsions	Rings
60	GTP	m	501	61	-	1/18/38/38	0/3/3/3
60	GTP	b	701	61	-	2/18/38/38	0/3/3/3

All (2) bond length outliers are listed below:

Mol	Chain	Res	Type	Atoms	Z	Observed(Å)	Ideal(Å)
60	m	501	GTP	C6-N1	-2.86	1.33	1.37
60	b	701	GTP	C6-N1	-2.25	1.34	1.37

All (10) bond angle outliers are listed below:

Mol	Chain	Res	Type	Atoms	Z	Observed(°)	Ideal(°)
60	m	501	GTP	PA-O3A-PB	-5.63	113.52	132.83
60	m	501	GTP	PB-O3B-PG	-4.64	116.90	132.83
60	m	501	GTP	C3'-C2'-C1'	3.54	106.31	100.98
60	b	701	GTP	PA-O3A-PB	-3.31	121.48	132.83
60	b	701	GTP	PB-O3B-PG	-2.87	122.97	132.83
60	m	501	GTP	C5-C6-N1	2.80	118.89	113.95
60	b	701	GTP	C5-C6-N1	2.71	118.73	113.95
60	b	701	GTP	C8-N7-C5	2.56	107.86	102.99
60	m	501	GTP	C8-N7-C5	2.45	107.66	102.99
60	m	501	GTP	C2-N1-C6	-2.04	121.34	125.10

There are no chirality outliers.

All (3) torsion outliers are listed below:

Mol	Chain	Res	Type	Atoms
60	b	701	GTP	C3'-C4'-C5'-O5'
60	b	701	GTP	O4'-C4'-C5'-O5'

*Continued on next page...*

Continued from previous page...

Mol	Chain	Res	Type	Atoms
60	m	501	GTP	PA-O3A-PB-O2B

There are no ring outliers.

No monomer is involved in short contacts.

The following is a two-dimensional graphical depiction of Mogul quality analysis of bond lengths, bond angles, torsion angles, and ring geometry for all instances of the Ligand of Interest. In addition, ligands with molecular weight > 250 and outliers as shown on the validation Tables will also be included. For torsion angles, if less than 5% of the Mogul distribution of torsion angles is within 10 degrees of the torsion angle in question, then that torsion angle is considered an outlier. Any bond that is central to one or more torsion angles identified as an outlier by Mogul will be highlighted in the graph. For rings, the root-mean-square deviation (RMSD) between the ring in question and similar rings identified by Mogul is calculated over all ring torsion angles. If the average RMSD is greater than 60 degrees and the minimal RMSD between the ring in question and any Mogul-identified rings is also greater than 60 degrees, then that ring is considered an outlier. The outliers are highlighted in purple. The color gray indicates Mogul did not find sufficient equivalents in the CSD to analyse the geometry.

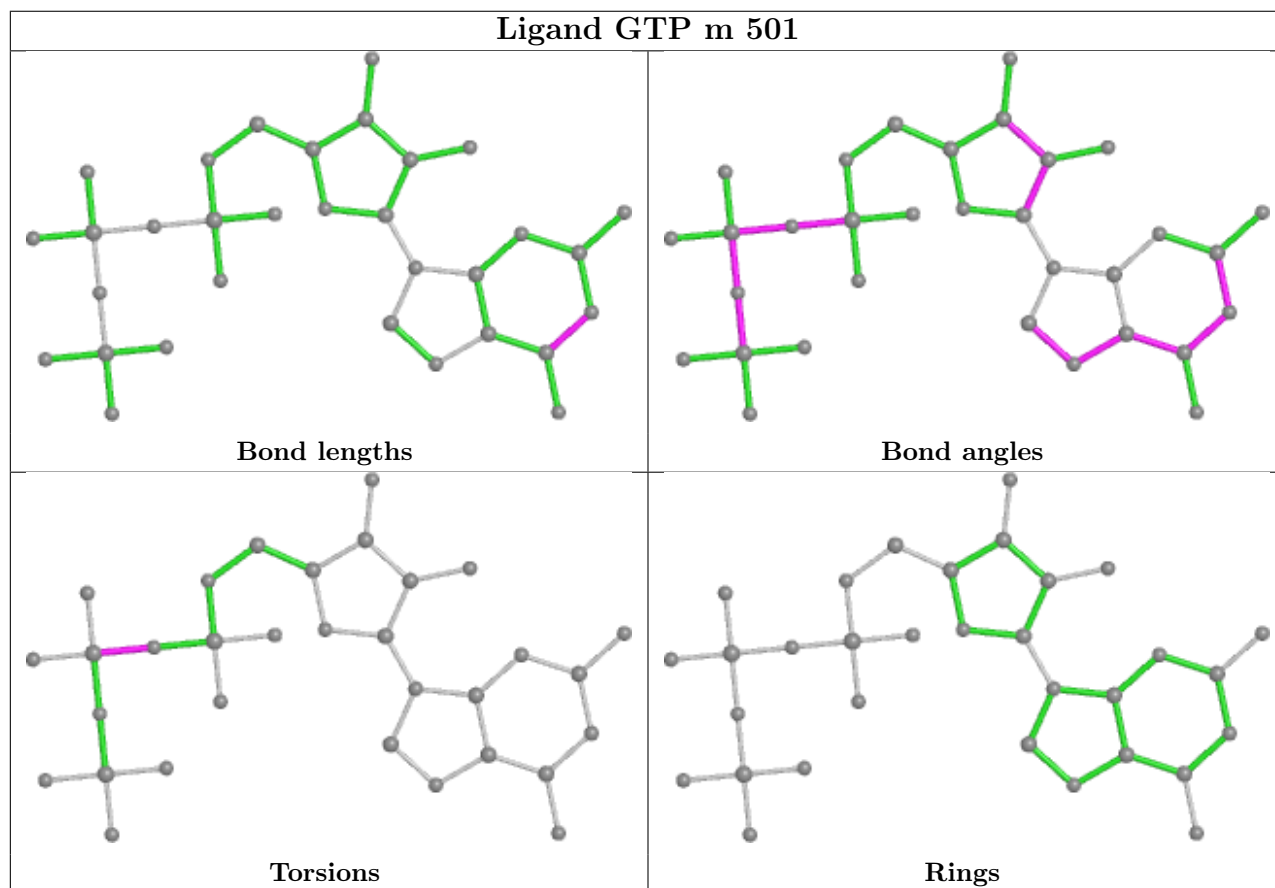

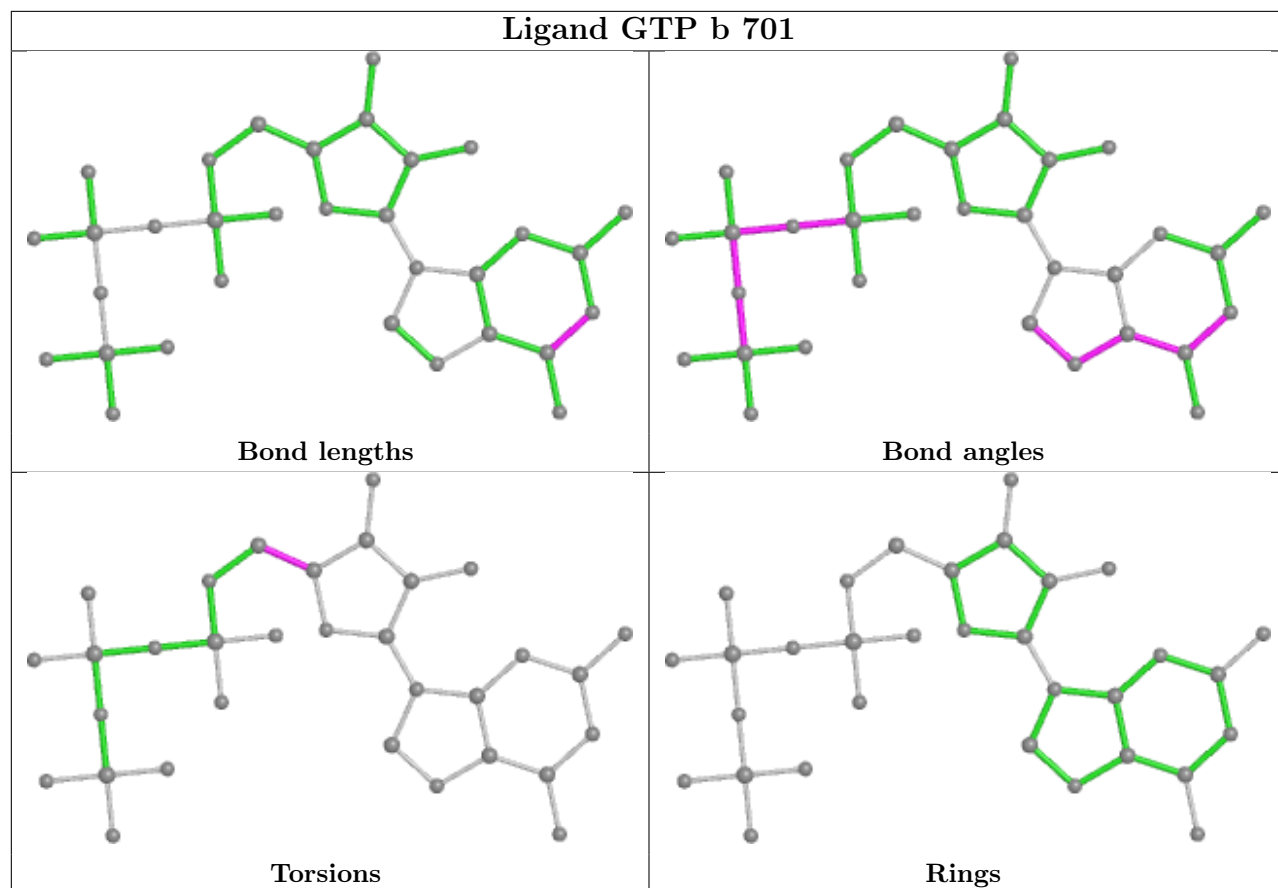

## 5.7 Other polymers [i](#)

There are no such residues in this entry.

## 5.8 Polymer linkage issues [i](#)

There are no chain breaks in this entry.



## 6 Map visualisation [i](#)

This section contains visualisations of the EMDB entry EMD-6615. These allow visual inspection of the internal detail of the map and identification of artifacts.

No raw map or half-maps were deposited for this entry and therefore no images, graphs, etc. pertaining to the raw map can be shown.

### 6.1 Orthogonal projections [i](#)

#### 6.1.1 Primary map

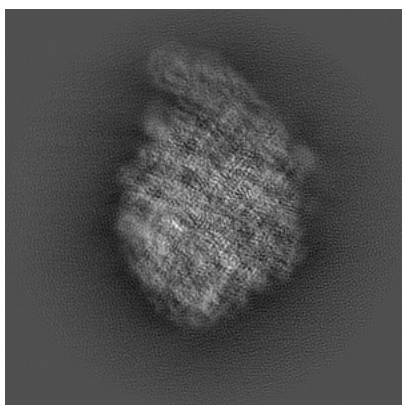

X

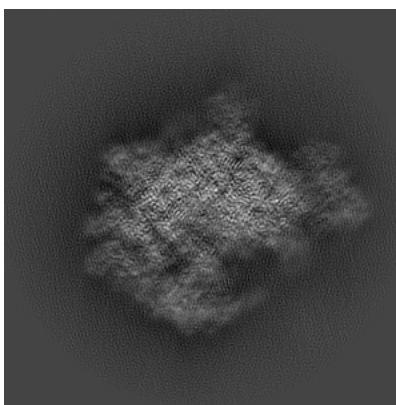

Y

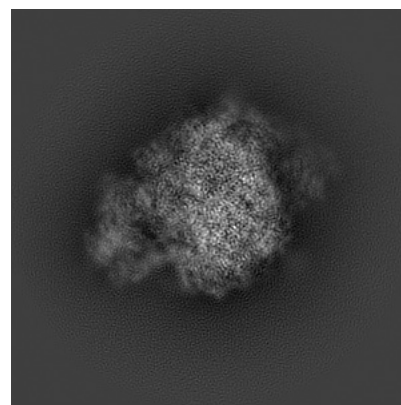

Z

The images above show the map projected in three orthogonal directions.

### 6.2 Central slices [i](#)

#### 6.2.1 Primary map

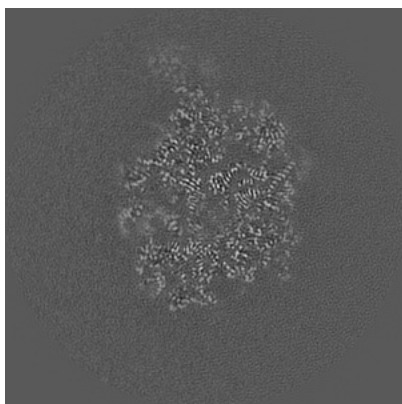

X Index: 160

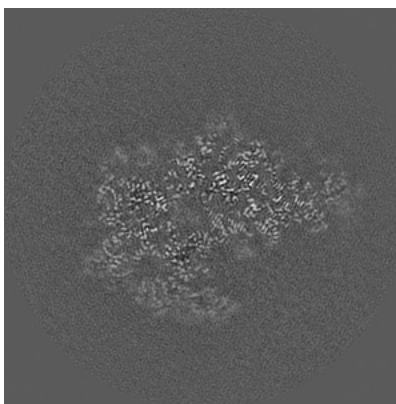

Y Index: 160

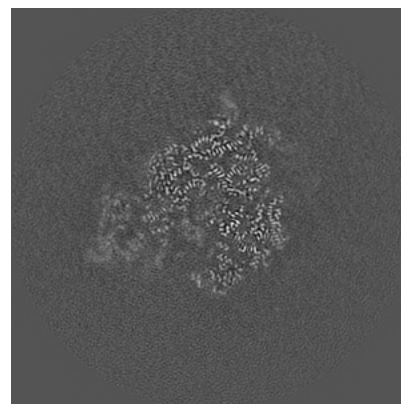

Z Index: 160

The images above show central slices of the map in three orthogonal directions.

## 6.3 Largest variance slices [i](#)

### 6.3.1 Primary map

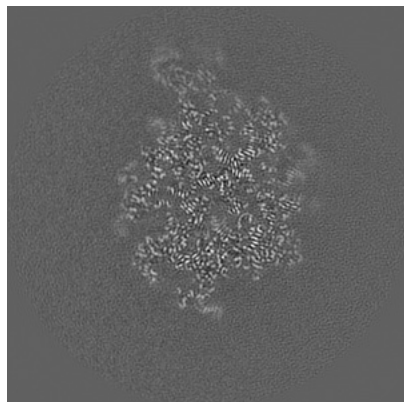

X Index: 168

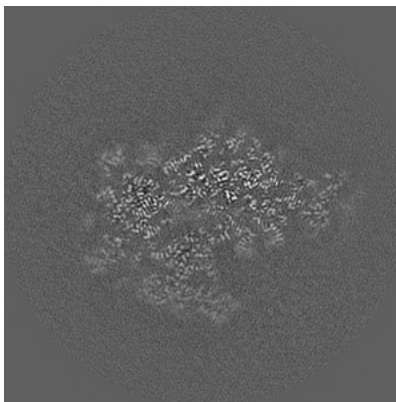

Y Index: 157

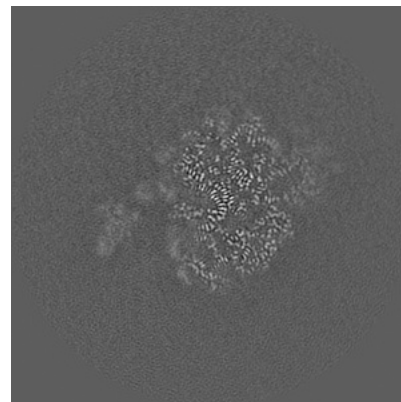

Z Index: 178

The images above show the largest variance slices of the map in three orthogonal directions.

## 6.4 Orthogonal standard-deviation projections (False-color) [i](#)

### 6.4.1 Primary map

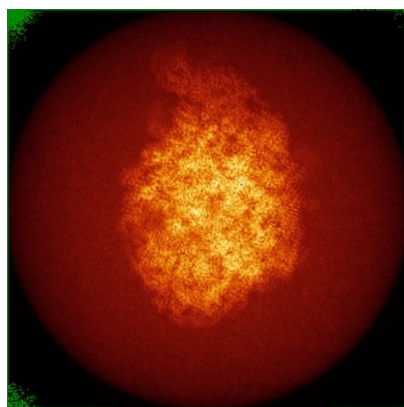

X

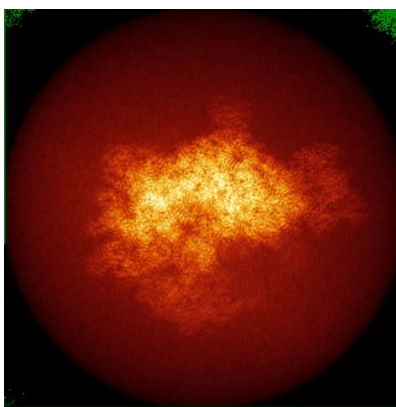

Y

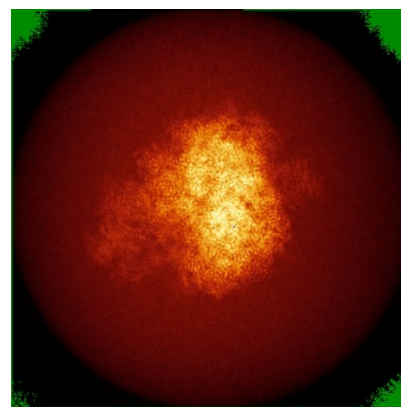

Z

The images above show the map standard deviation projections with false color in three orthogonal directions. Minimum values are shown in green, max in blue, and dark to light orange shades represent small to large values respectively.

## 6.5 Orthogonal surface views [i](#)

### 6.5.1 Primary map

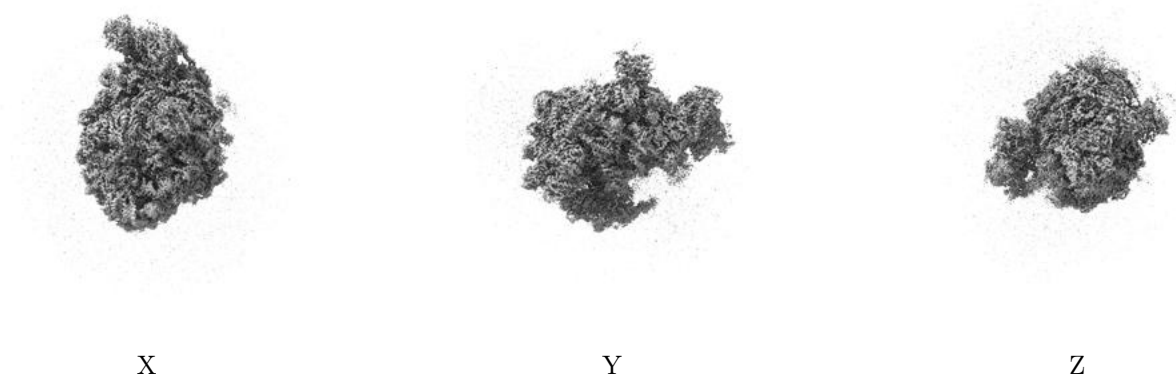

The images above show the 3D surface view of the map at the recommended contour level 0.029. These images, in conjunction with the slice images, may facilitate assessment of whether an appropriate contour level has been provided.

## 6.6 Mask visualisation [i](#)

This section was not generated. No masks/segmentation were deposited.

## 7 Map analysis [i](#)

This section contains the results of statistical analysis of the map.

### 7.1 Map-value distribution [i](#)

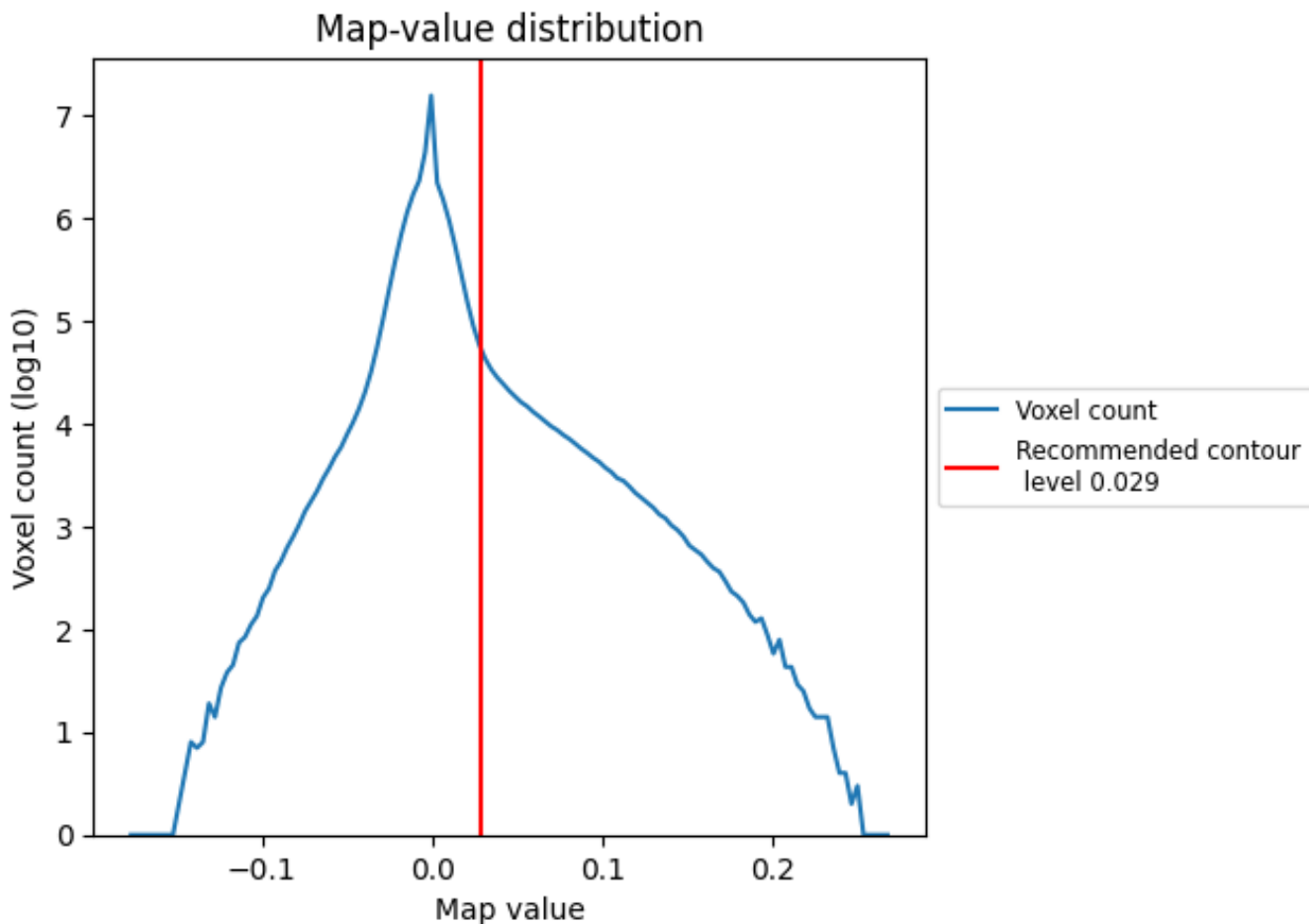

The map-value distribution is plotted in 128 intervals along the x-axis. The y-axis is logarithmic. A spike in this graph at zero usually indicates that the volume has been masked.

## 7.2 Volume estimate [i](#)

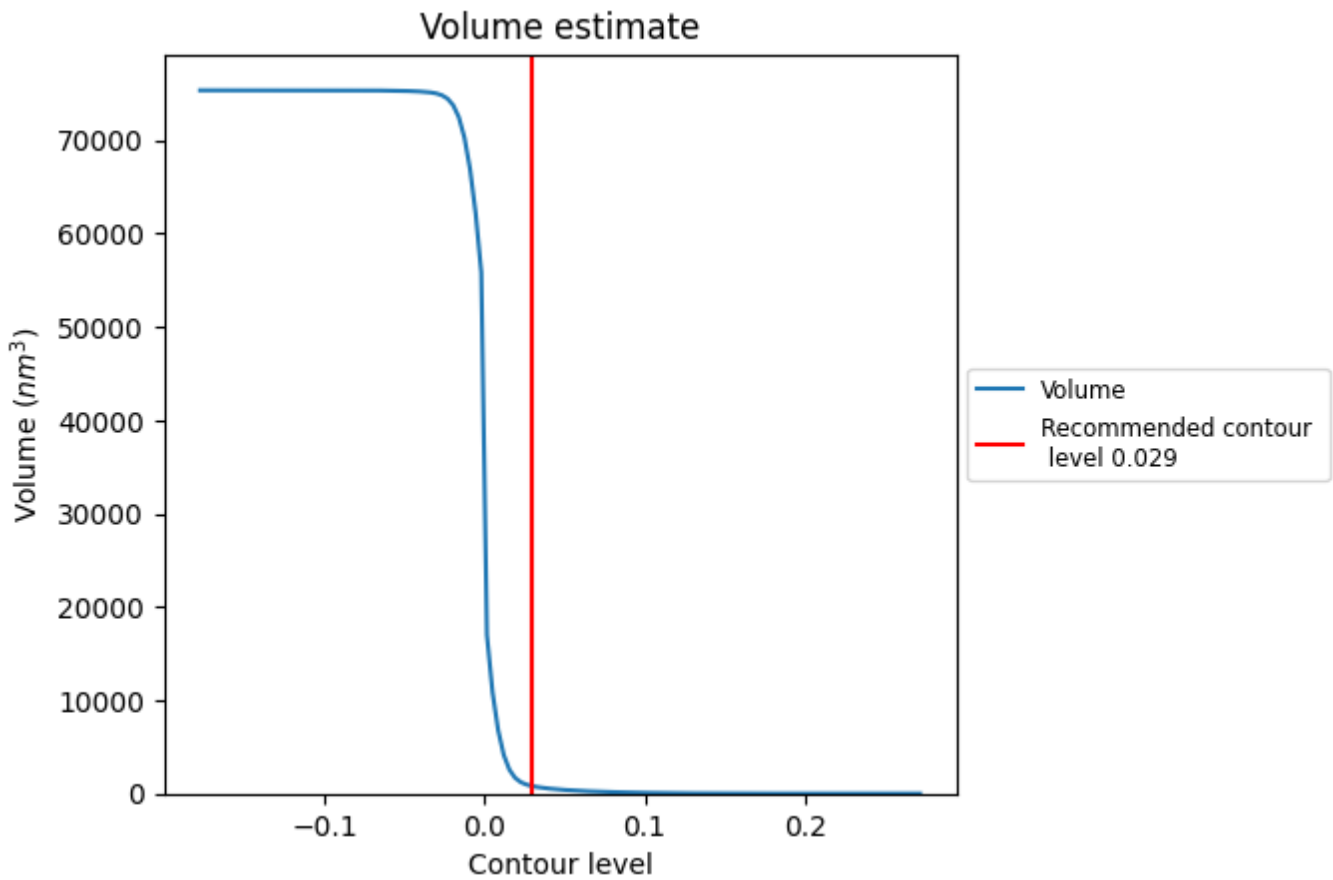

The volume at the recommended contour level is 835 nm<sup>3</sup>; this corresponds to an approximate mass of 754 kDa.

The volume estimate graph shows how the enclosed volume varies with the contour level. The recommended contour level is shown as a vertical line and the intersection between the line and the curve gives the volume of the enclosed surface at the given level.

### 7.3 Rotationally averaged power spectrum i

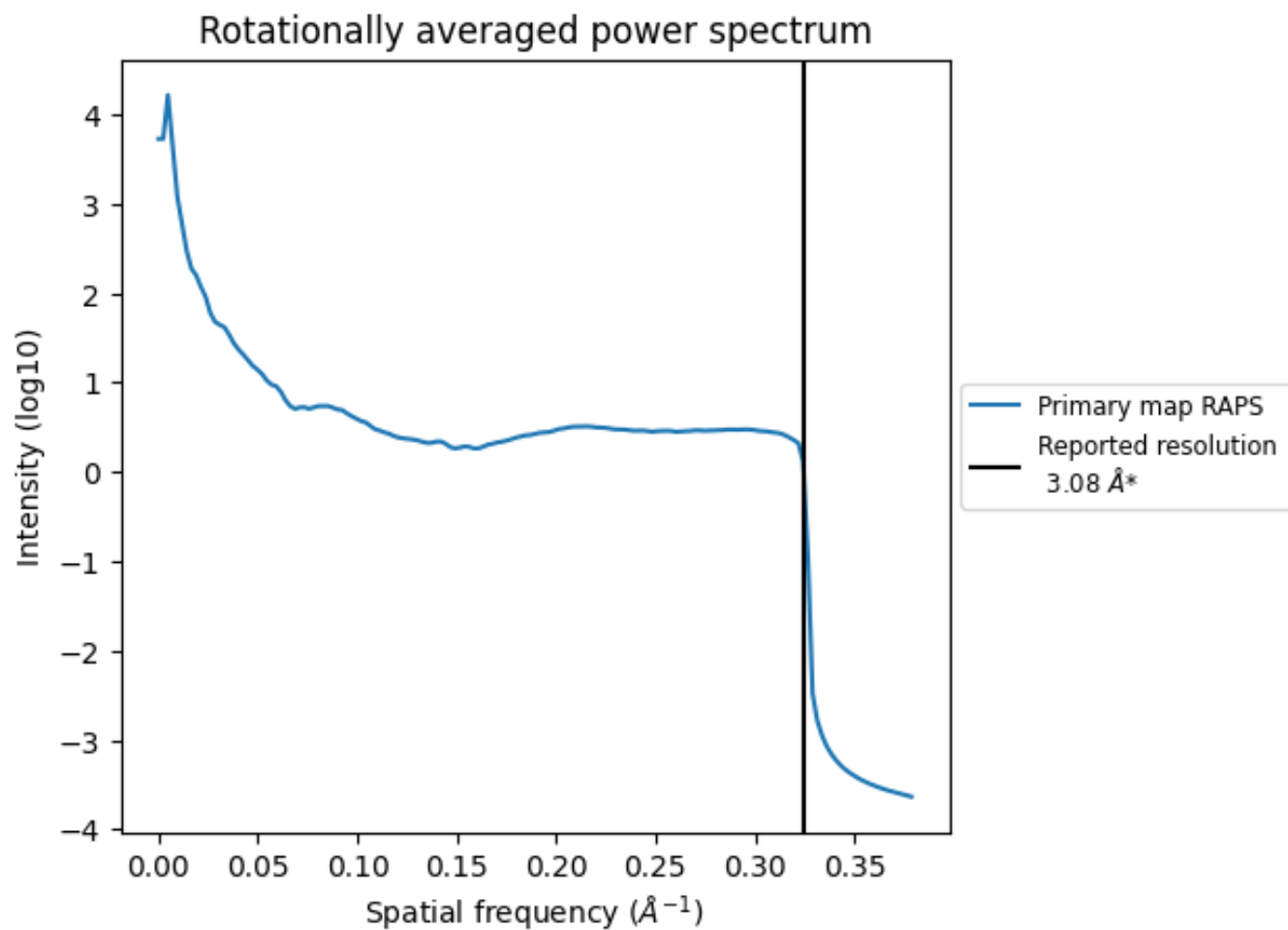

\*Reported resolution corresponds to spatial frequency of 0.325 Å<sup>-1</sup>

## 8 Fourier-Shell correlation [i](#)

Fourier-Shell Correlation (FSC) is the most commonly used method to estimate the resolution of single-particle and subtomogram-averaged maps. The shape of the curve depends on the imposed symmetry, mask and whether or not the two 3D reconstructions used were processed from a common reference. The reported resolution is shown as a black line. A curve is displayed for the half-bit criterion in addition to lines showing the 0.143 gold standard cut-off and 0.5 cut-off.

### 8.1 FSC [i](#)

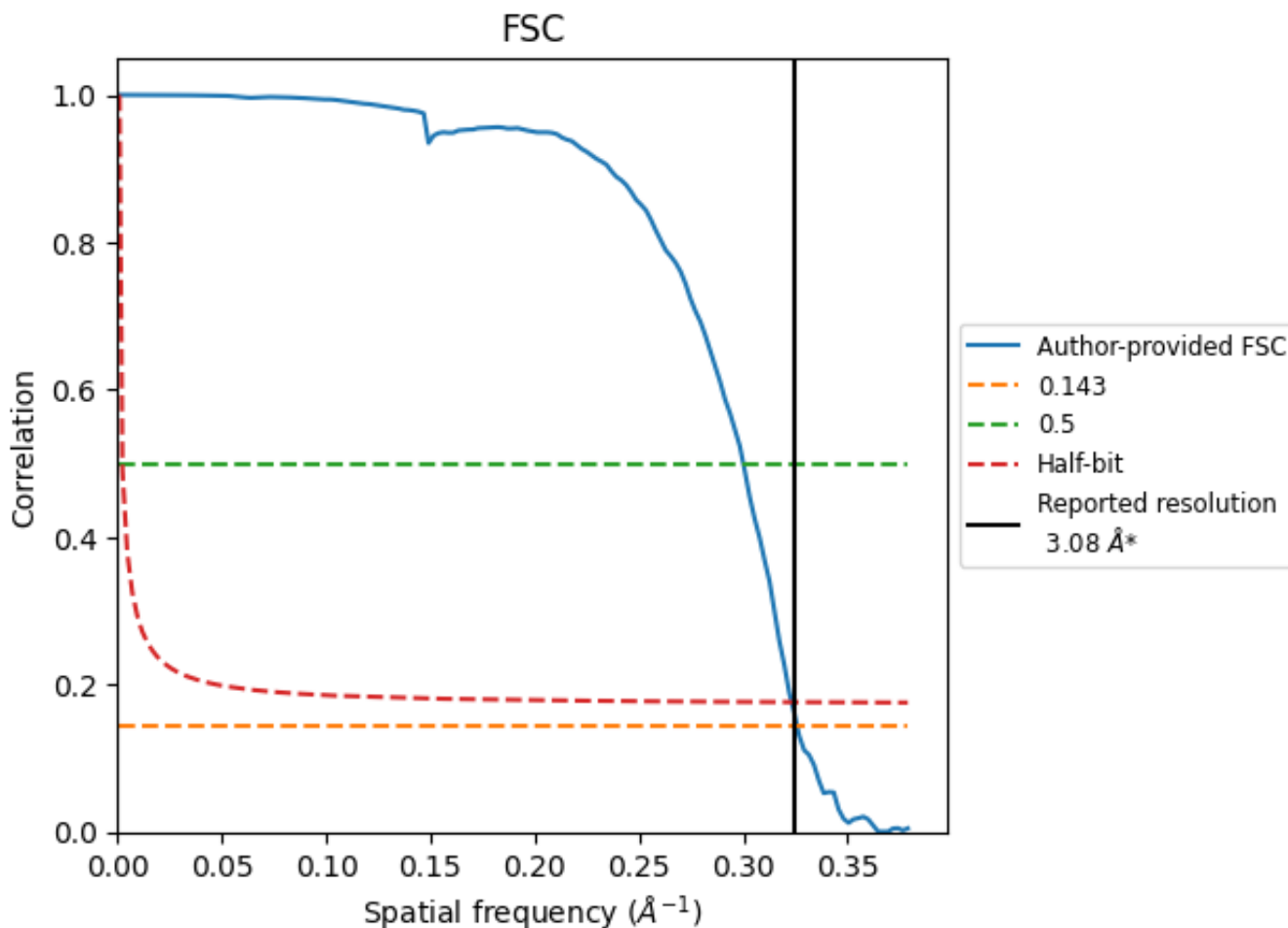

\*Reported resolution corresponds to spatial frequency of 0.325 Å<sup>-1</sup>

## 8.2 Resolution estimates [i](#)

Resolution estimate (Å)	Estimation criterion (FSC cut-off)		
	0.143	0.5	Half-bit
Reported by author	-	-	-
Author-provided FSC curve	3.07	3.33	3.10
Unmasked-calculated*	-	-	-

\*Resolution estimate based on FSC curve calculated by comparison of deposited half-maps.



## 9 Map-model fit [i](#)

This section contains information regarding the fit between EMDB map EMD-6615 and PDB model 3JCT. Per-residue inclusion information can be found in section 3 on page 15.

### 9.1 Map-model overlay [i](#)

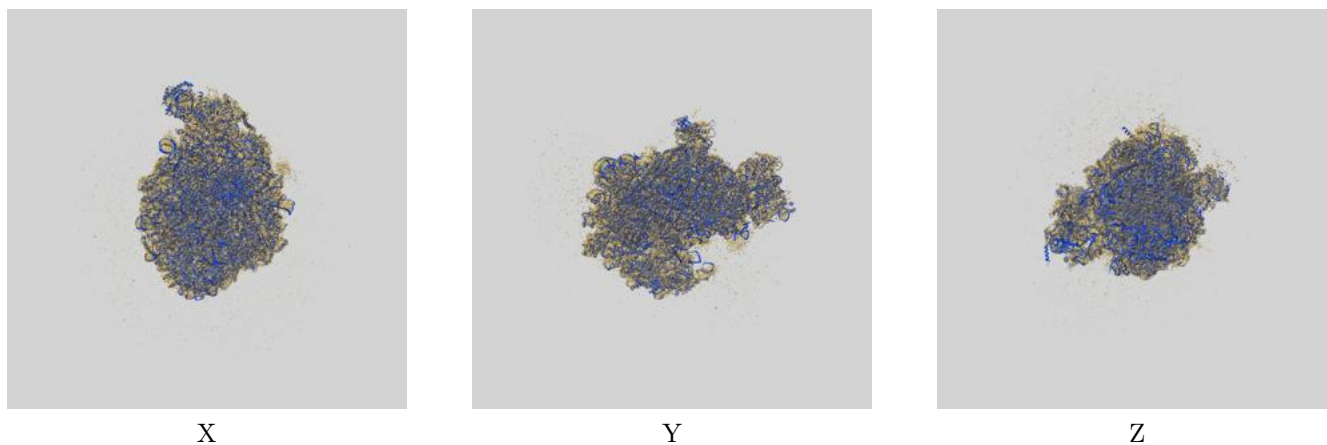

The images above show the 3D surface view of the map at the recommended contour level 0.029 at 50% transparency in yellow overlaid with a ribbon representation of the model coloured in blue. These images allow for the visual assessment of the quality of fit between the atomic model and the map.

## 9.2 Q-score mapped to coordinate model [i](#)

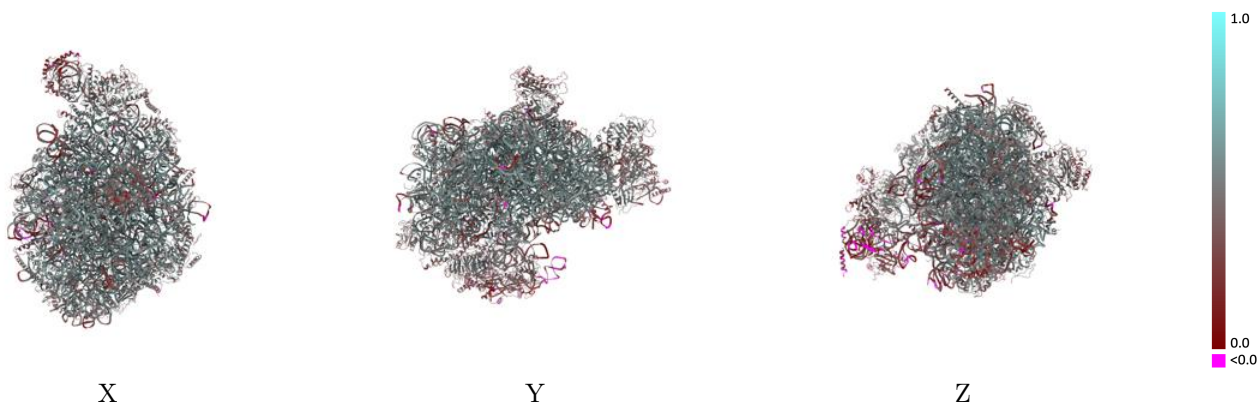

The images above show the model with each residue coloured according to its Q-score. This shows their resolvability in the map with higher Q-score values reflecting better resolvability. Please note: Q-score is calculating the resolvability of atoms, and thus high values are only expected at resolutions at which atoms can be resolved. Low Q-score values may therefore be expected for many entries.

## 9.3 Atom inclusion mapped to coordinate model [i](#)

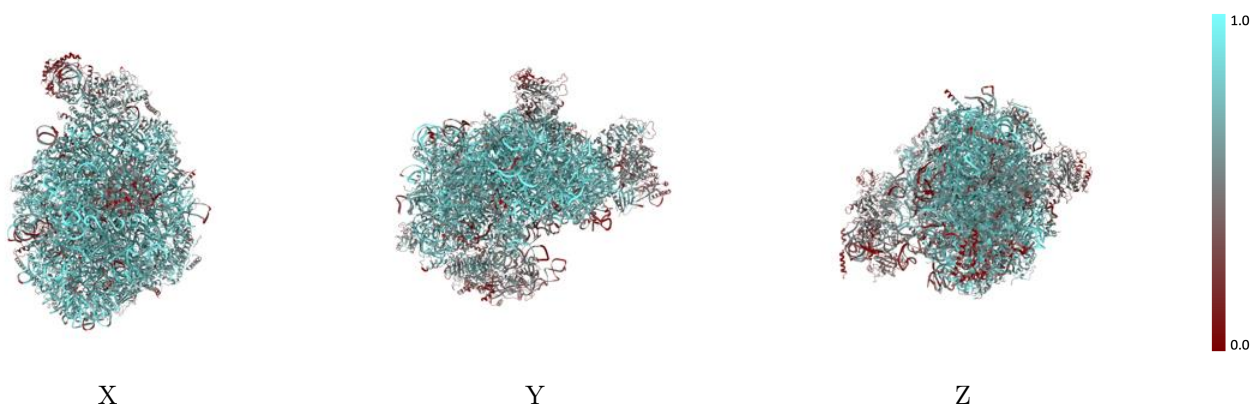

The images above show the model with each residue coloured according to its atom inclusion. This shows to what extent they are inside the map at the recommended contour level (0.029).



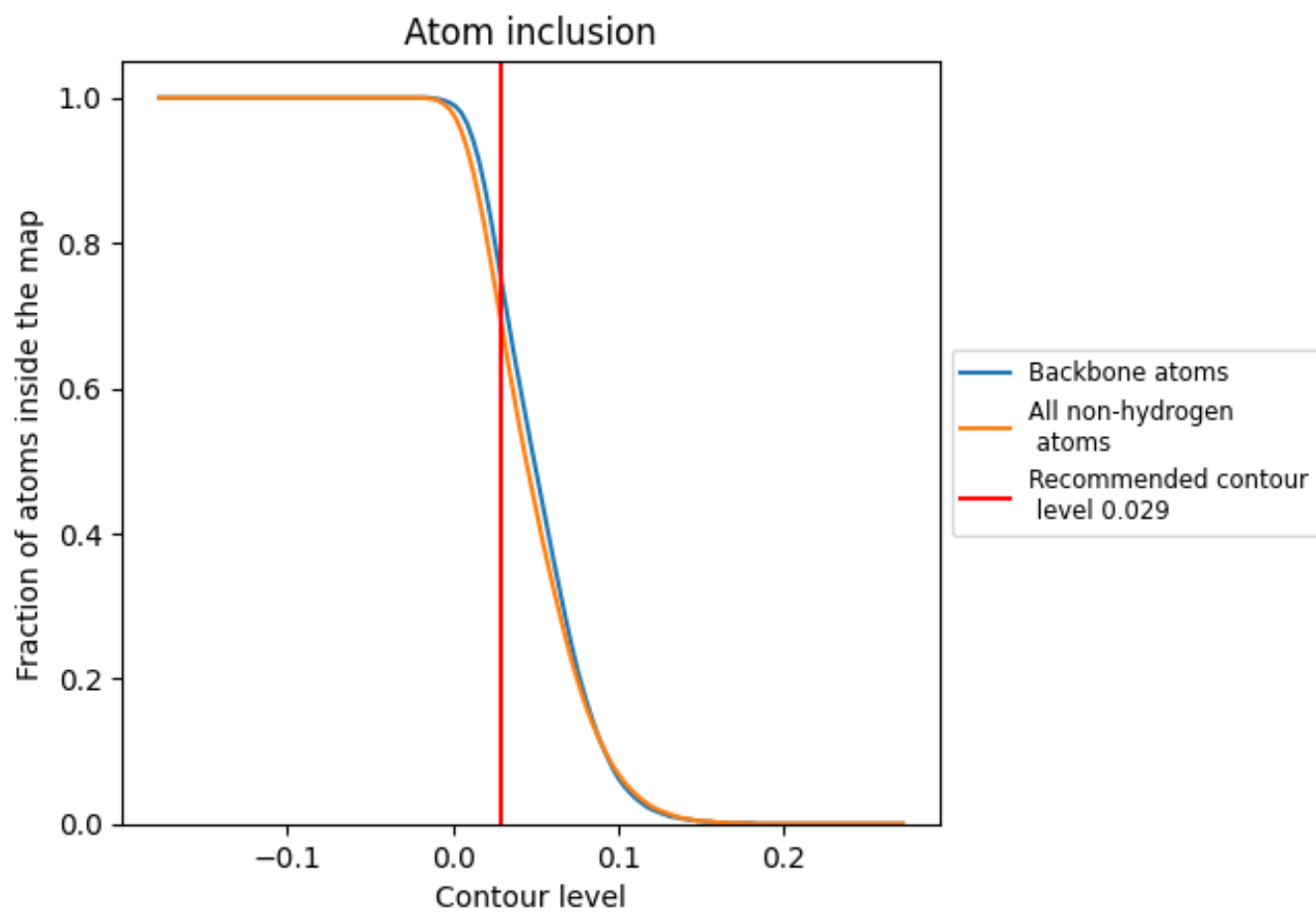



































































## 9.4 Atom inclusion [i](#)



At the recommended contour level, 75% of all backbone atoms, 69% of all non-hydrogen atoms, are inside the map.

## 9.5 Map-model fit summary

















































The table lists the average atom inclusion at the recommended contour level (0.029) and Q-score for the entire model and for each chain.

Chain	Atom inclusion	Q-score
All	 0.6910	 0.4680
1	 0.7970	 0.4940
2	 0.9070	 0.5580
3	 0.4460	 0.2050
4	 0.3710	 0.3860
5	 0.2000	 0.3230
6	 0.5340	 0.3660
A	 0.7480	 0.5390
B	 0.7620	 0.5080
C	 0.7380	 0.5110
D	 0.3330	 0.2520
E	 0.6760	 0.4580
F	 0.7460	 0.4940
G	 0.6600	 0.4580
H	 0.7270	 0.4970
I	 0.5960	 0.4790
J	 0.1700	 0.1600
K	 0.3440	 0.3450
L	 0.6760	 0.4820
M	 0.7120	 0.4920
N	 0.7820	 0.5370
O	 0.7890	 0.5340
P	 0.7060	 0.5020
Q	 0.6640	 0.4850
R	 0.7160	 0.5160
S	 0.6420	 0.4480
T	 0.4860	 0.3930
U	 0.6630	 0.4570
V	 0.7390	 0.5120
W	 0.5170	 0.4090
X	 0.7250	 0.5190
Y	 0.6850	 0.4930
Z	 0.7010	 0.4760
a	 0.6430	 0.4620
b	 0.6370	 0.4710



*Continued on next page...*

Continued from previous page...

Chain	Atom inclusion	Q-score
c	 0.6390	 0.4540
d	 0.6920	 0.4910
e	 0.7300	 0.5320
f	 0.7990	 0.5460
g	 0.7310	 0.5180
h	 0.7210	 0.5010
i	 0.6110	 0.4390
j	 0.8280	 0.5620
k	 0.4760	 0.4090
l	 0.7980	 0.5640
m	 0.6660	 0.4900
n	 0.5910	 0.4710
o	 0.4800	 0.3930
p	 0.7400	 0.5070
q	 0.5040	 0.4310
r	 0.7240	 0.5180
s	 0.4840	 0.4200
t	 0.4910	 0.4300
u	 0.7130	 0.4900
v	 0.4350	 0.3600
w	 0.4690	 0.3850
x	 0.4780	 0.3820
y	 0.6860	 0.4930
z	 0.5740	 0.4480