



wwPDB X-ray Structure Validation Summary Report ⓘ

Oct 11, 2023 – 07:30 AM EDT

PDB ID : 5JRQ
Title : BRAFV600E Kinase Domain In Complex with Chemically Linked Vemurafenib Inhibitor VEM-6-VEM
Authors : Grasso, M.J.; Marmorstein, R.
Deposited on : 2016-05-06
Resolution : 2.29 Å(reported)

This is a wwPDB X-ray Structure Validation Summary Report for a publicly released PDB entry.

We welcome your comments at validation@mail.wwpdb.org

A user guide is available at

<https://www.wwpdb.org/validation/2017/XrayValidationReportHelp>

with specific help available everywhere you see the ⓘ symbol.

The types of validation reports are described at

<http://www.wwpdb.org/validation/2017/FAQs#types>.

The following versions of software and data (see [references ⓘ](#)) were used in the production of this report:

MolProbity : 4.02b-467
Mogul : 1.8.5 (274361), CSD as541be (2020)
Xtriage (Phenix) : 1.13
EDS : 2.35.1
buster-report : 1.1.7 (2018)
Percentile statistics : 20191225.v01 (using entries in the PDB archive December 25th 2019)
Refmac : 5.8.0158
CCP4 : 7.0.044 (Gargrove)
Ideal geometry (proteins) : Engh & Huber (2001)
Ideal geometry (DNA, RNA) : Parkinson et al. (1996)
Validation Pipeline (wwPDB-VP) : 2.35.1

1 Overall quality at a glance

The following experimental techniques were used to determine the structure:

X-RAY DIFFRACTION

The reported resolution of this entry is 2.29 Å.

Percentile scores (ranging between 0-100) for global validation metrics of the entry are shown in the following graphic. The table shows the number of entries on which the scores are based.

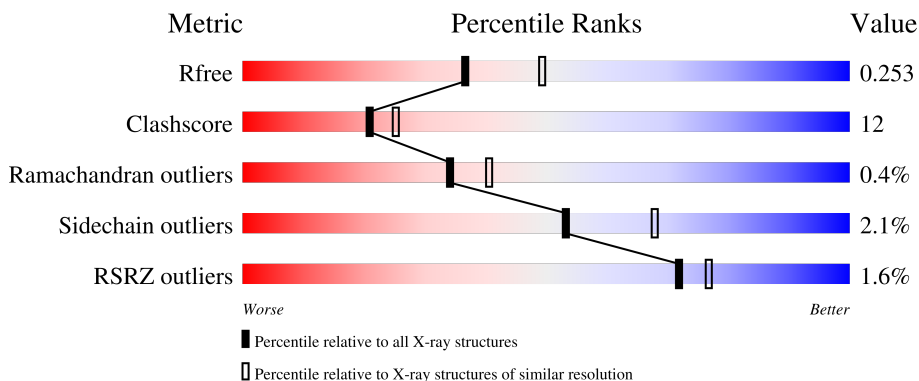

Metric	Whole archive (#Entries)	Similar resolution (#Entries, resolution range(Å))
R_{free}	130704	6980 (2.30-2.26)
Clashscore	141614	7711 (2.30-2.26)
Ramachandran outliers	138981	7597 (2.30-2.26)
Sidechain outliers	138945	7598 (2.30-2.26)
RSRZ outliers	127900	6849 (2.30-2.26)

The table below summarises the geometric issues observed across the polymeric chains and their fit to the electron density. The red, orange, yellow and green segments of the lower bar indicate the fraction of residues that contain outliers for ≥ 3 , 2, 1 and 0 types of geometric quality criteria respectively. A grey segment represents the fraction of residues that are not modelled. The numeric value for each fraction is indicated below the corresponding segment, with a dot representing fractions $\leq 5\%$. The upper red bar (where present) indicates the fraction of residues that have poor fit to the electron density. The numeric value is given above the bar.

Mol	Chain	Length	Quality of chain
1	A	280	
1	B	280	

2 Entry composition i

There are 6 unique types of molecules in this entry. The entry contains 4177 atoms, of which 82 are hydrogens and 0 are deuteriums.

In the tables below, the ZeroOcc column contains the number of atoms modelled with zero occupancy, the AltConf column contains the number of residues with at least one atom in alternate conformation and the Trace column contains the number of residues modelled with at most 2 atoms.

- Molecule 1 is a protein called Serine/threonine-protein kinase B-raf.

Mol	Chain	Residues	Atoms					ZeroOcc	AltConf	Trace
			Total	C	N	O	S			
1	A	258	1954	1245	342	354	13	0	0	0
1	B	246	1874	1196	323	342	13	0	0	0

There are 42 discrepancies between the modelled and reference sequences:

Chain	Residue	Modelled	Actual	Comment	Reference
A	444	GLY	-	expression tag	UNP P15056
A	445	SER	-	expression tag	UNP P15056
A	446	GLU	-	expression tag	UNP P15056
A	447	PHE	-	expression tag	UNP P15056
A	543	ALA	ILE	engineered mutation	UNP P15056
A	544	SER	ILE	engineered mutation	UNP P15056
A	551	LYS	ILE	engineered mutation	UNP P15056
A	562	ARG	GLN	engineered mutation	UNP P15056
A	588	ASN	LEU	engineered mutation	UNP P15056
A	600	GLU	VAL	engineered mutation	UNP P15056
A	630	SER	LYS	engineered mutation	UNP P15056
A	667	GLU	PHE	engineered mutation	UNP P15056
A	673	SER	TYR	engineered mutation	UNP P15056
A	688	ARG	ALA	engineered mutation	UNP P15056
A	706	SER	LEU	engineered mutation	UNP P15056
A	709	ARG	GLN	engineered mutation	UNP P15056
A	713	GLU	SER	engineered mutation	UNP P15056
A	716	GLU	LEU	engineered mutation	UNP P15056
A	720	GLU	SER	engineered mutation	UNP P15056
A	722	SER	PRO	engineered mutation	UNP P15056
A	723	GLY	LYS	engineered mutation	UNP P15056
B	444	GLY	-	expression tag	UNP P15056
B	445	SER	-	expression tag	UNP P15056
B	446	GLU	-	expression tag	UNP P15056
B	447	PHE	-	expression tag	UNP P15056

Continued on next page...

Continued from previous page...

Chain	Residue	Modelled	Actual	Comment	Reference
B	543	ALA	ILE	engineered mutation	UNP P15056
B	544	SER	ILE	engineered mutation	UNP P15056
B	551	LYS	ILE	engineered mutation	UNP P15056
B	562	ARG	GLN	engineered mutation	UNP P15056
B	588	ASN	LEU	engineered mutation	UNP P15056
B	600	GLU	VAL	engineered mutation	UNP P15056
B	630	SER	LYS	engineered mutation	UNP P15056
B	667	GLU	PHE	engineered mutation	UNP P15056
B	673	SER	TYR	engineered mutation	UNP P15056
B	688	ARG	ALA	engineered mutation	UNP P15056
B	706	SER	LEU	engineered mutation	UNP P15056
B	709	ARG	GLN	engineered mutation	UNP P15056
B	713	GLU	SER	engineered mutation	UNP P15056
B	716	GLU	LEU	engineered mutation	UNP P15056
B	720	GLU	SER	engineered mutation	UNP P15056
B	722	SER	PRO	engineered mutation	UNP P15056
B	723	GLY	LYS	engineered mutation	UNP P15056

- Molecule 2 is N-{2,4-difluoro-3-[5-(4-methoxyphenyl)-1H-pyrrolo[2,3-b]pyridine-3-carbonyl]phenyl}propane-1-sulfonamide (three-letter code: 6N9) (formula: C₂₄H₂₁F₂N₃O₄S).

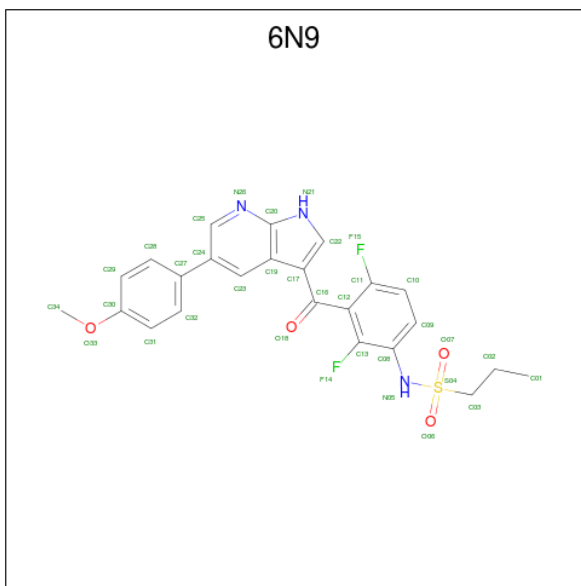

Mol	Chain	Residues	Atoms						ZeroOcc	AltConf	
			Total	C	F	H	N	O			S
2	A	1	Total	C	F	H	N	O	S	0	0
			53	24	2	19	3	4	1		
2	B	1	Total	C	F	H	N	O	S	0	0
			53	24	2	19	3	4	1		

- Molecule 3 is DIMETHYL SULFOXIDE (three-letter code: DMS) (formula: C₂H₆OS).

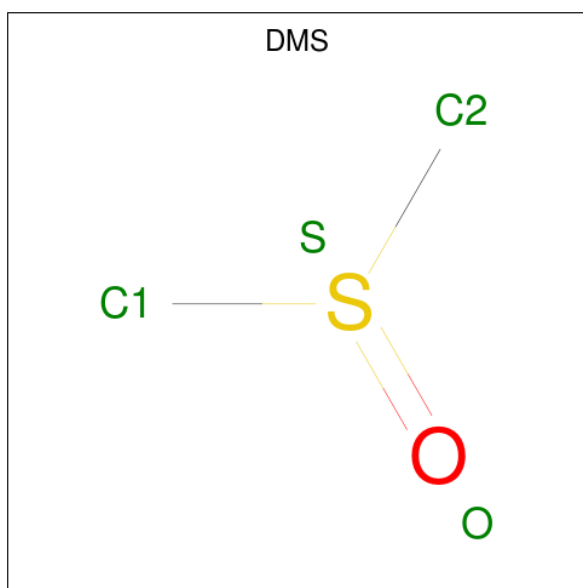

Mol	Chain	Residues	Atoms					ZeroOcc	AltConf
			Total	C	H	O	S		
3	A	1	10	2	6	1	1	0	0
3	B	1	10	2	6	1	1	0	0

- Molecule 4 is GLYCEROL (three-letter code: GOL) (formula: C₃H₈O₃).

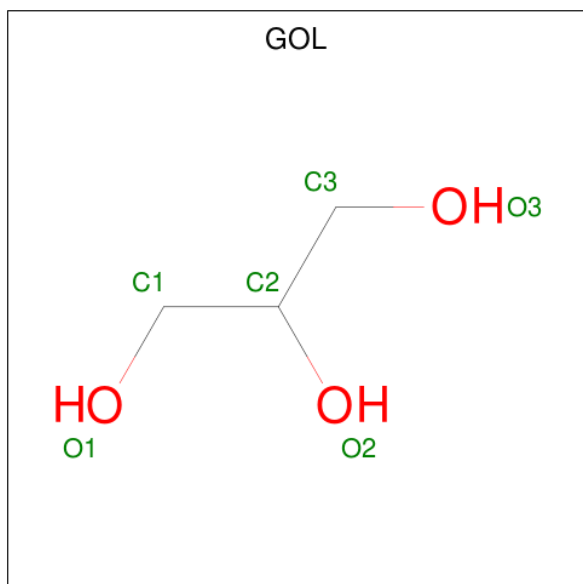

Mol	Chain	Residues	Atoms				ZeroOcc	AltConf
			Total	C	H	O		
4	A	1	14	3	8	3	0	0

- Molecule 5 is TETRAMETHYLAMMONIUM ION (three-letter code: TMA) (formula: $C_4H_{12}N$).

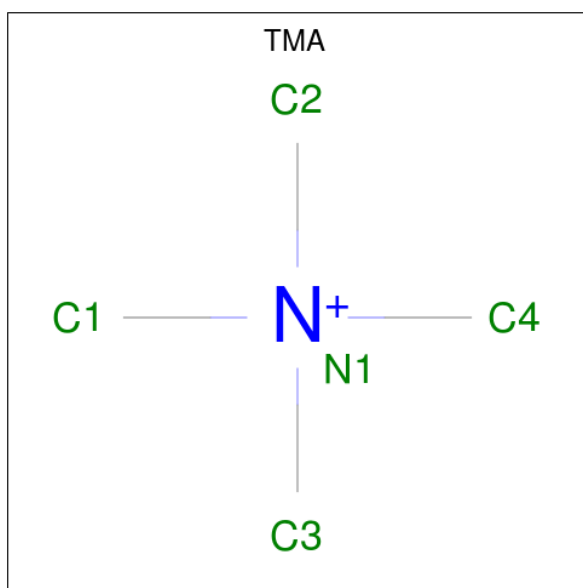

Mol	Chain	Residues	Atoms				ZeroOcc	AltConf
			Total	C	H	N		
5	A	1	17	4	12	1	0	0
5	B	1	17	4	12	1	0	0

- Molecule 6 is water.

Mol	Chain	Residues	Atoms		ZeroOcc	AltConf
			Total	O		
6	A	92	92	92	0	0
6	B	83	83	83	0	0

3 Residue-property plots [i](#)

These plots are drawn for all protein, RNA, DNA and oligosaccharide chains in the entry. The first graphic for a chain summarises the proportions of the various outlier classes displayed in the second graphic. The second graphic shows the sequence view annotated by issues in geometry and electron density. Residues are color-coded according to the number of geometric quality criteria for which they contain at least one outlier: green = 0, yellow = 1, orange = 2 and red = 3 or more. A red dot above a residue indicates a poor fit to the electron density ($RSRZ > 2$). Stretches of 2 or more consecutive residues without any outlier are shown as a green connector. Residues present in the sample, but not in the model, are shown in grey.

- Molecule 1: Serine/threonine-protein kinase B-raf

Chain A: 



- Molecule 1: Serine/threonine-protein kinase B-raf

Chain B: 

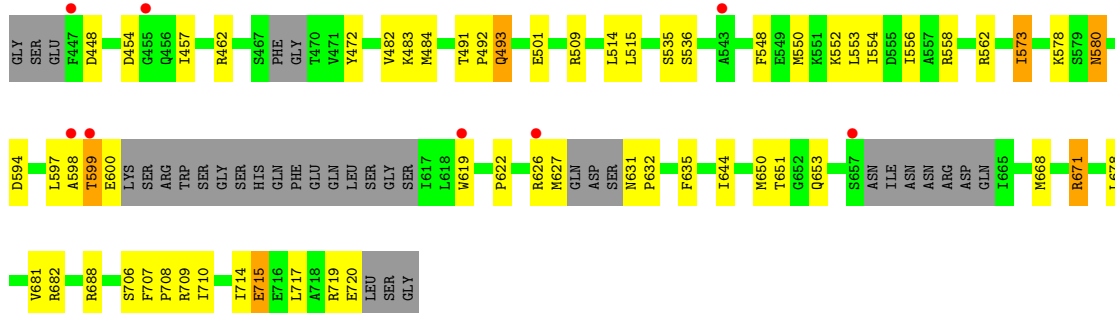

4 Data and refinement statistics i

Property	Value	Source
Space group	P 1 21 1	Depositor
Cell constants a, b, c, α , β , γ	56.84Å 67.75Å 67.88Å 90.00° 90.32° 90.00°	Depositor
Resolution (Å)	29.21 – 2.29 29.21 – 2.29	Depositor EDS
% Data completeness (in resolution range)	95.3 (29.21-2.29) 87.9 (29.21-2.29)	Depositor EDS
R_{merge}	0.10	Depositor
R_{sym}	(Not available)	Depositor
$\langle I/\sigma(I) \rangle$ ¹	2.22 (at 2.29Å)	Xtrriage
Refinement program	PHENIX 1.8.2_1309	Depositor
R, R_{free}	0.195 , 0.254 0.195 , 0.253	Depositor DCC
R_{free} test set	1997 reflections (8.93%)	wwPDB-VP
Wilson B-factor (Å ²)	29.9	Xtrriage
Anisotropy	0.219	Xtrriage
Bulk solvent k_{sol} (e/Å ³), B_{sol} (Å ²)	0.34 , 24.9	EDS
L-test for twinning ²	$\langle L \rangle = 0.49$, $\langle L^2 \rangle = 0.32$	Xtrriage
Estimated twinning fraction	0.001 for -h,l,k 0.020 for -h,-l,-k 0.418 for h,-k,-l	Xtrriage
F_o, F_c correlation	0.94	EDS
Total number of atoms	4177	wwPDB-VP
Average B, all atoms (Å ²)	27.0	wwPDB-VP

Xtrriage's analysis on translational NCS is as follows: *The largest off-origin peak in the Patterson function is 6.86% of the height of the origin peak. No significant pseudotranslation is detected.*

¹Intensities estimated from amplitudes.

²Theoretical values of $\langle |L| \rangle$, $\langle L^2 \rangle$ for acentric reflections are 0.5, 0.333 respectively for untwinned datasets, and 0.375, 0.2 for perfectly twinned datasets.

5 Model quality

5.1 Standard geometry

Bond lengths and bond angles in the following residue types are not validated in this section: GOL, 6N9, DMS, TMA

The Z score for a bond length (or angle) is the number of standard deviations the observed value is removed from the expected value. A bond length (or angle) with $|Z| > 5$ is considered an outlier worth inspection. RMSZ is the root-mean-square of all Z scores of the bond lengths (or angles).

Mol	Chain	Bond lengths		Bond angles	
		RMSZ	# Z >5	RMSZ	# Z >5
1	A	0.40	0/1994	0.56	0/2701
1	B	0.41	0/1912	0.59	0/2587
All	All	0.41	0/3906	0.57	0/5288

There are no bond length outliers.

There are no bond angle outliers.

There are no chirality outliers.

There are no planarity outliers.

5.2 Too-close contacts

In the following table, the Non-H and H(model) columns list the number of non-hydrogen atoms and hydrogen atoms in the chain respectively. The H(added) column lists the number of hydrogen atoms added and optimized by MolProbity. The Clashes column lists the number of clashes within the asymmetric unit, whereas Symm-Clashes lists symmetry-related clashes.

Mol	Chain	Non-H	H(model)	H(added)	Clashes	Symm-Clashes
1	A	1954	0	1863	41	0
1	B	1874	0	1792	52	0
2	A	34	19	0	0	0
2	B	34	19	0	1	0
3	A	4	6	6	0	0
3	B	4	6	6	0	0
4	A	6	8	8	0	0
5	A	5	12	12	3	0
5	B	5	12	12	3	0
6	A	92	0	0	5	0
6	B	83	0	0	2	0
All	All	4095	82	3699	93	0

The all-atom clashscore is defined as the number of clashes found per 1000 atoms (including hydrogen atoms). The all-atom clashscore for this structure is 12.

The worst 5 of 93 close contacts within the same asymmetric unit are listed below, sorted by their clash magnitude.

Atom-1	Atom-2	Interatomic distance (Å)	Clash overlap (Å)
1:A:501:GLU:HG3	1:A:597:LEU:HD13	1.44	0.99
1:A:454:ASP:HA	1:A:457:ILE:HD11	1.47	0.95
1:B:501:GLU:HG3	1:B:597:LEU:HD13	1.48	0.93
1:B:509:ARG:HB2	5:B:803:TMA:H22	1.60	0.83
1:B:548:PHE:HB2	1:B:553:LEU:CD1	2.16	0.76

There are no symmetry-related clashes.

5.3 Torsion angles [i](#)

5.3.1 Protein backbone [i](#)

In the following table, the Percentiles column shows the percent Ramachandran outliers of the chain as a percentile score with respect to all X-ray entries followed by that with respect to entries of similar resolution.

The Analysed column shows the number of residues for which the backbone conformation was analysed, and the total number of residues.

Mol	Chain	Analysed	Favoured	Allowed	Outliers	Percentiles	
1	A	252/280 (90%)	237 (94%)	15 (6%)	0	100	100
1	B	236/280 (84%)	227 (96%)	7 (3%)	2 (1%)	19	22
All	All	488/560 (87%)	464 (95%)	22 (4%)	2 (0%)	34	40

All (2) Ramachandran outliers are listed below:

Mol	Chain	Res	Type
1	B	448	ASP
1	B	599	THR

5.3.2 Protein sidechains [i](#)

In the following table, the Percentiles column shows the percent sidechain outliers of the chain as a percentile score with respect to all X-ray entries followed by that with respect to entries of similar resolution.

The Analysed column shows the number of residues for which the sidechain conformation was analysed, and the total number of residues.

Mol	Chain	Analysed	Rotameric	Outliers	Percentiles	
1	A	194/245 (79%)	192 (99%)	2 (1%)	76	86
1	B	188/245 (77%)	182 (97%)	6 (3%)	39	52
All	All	382/490 (78%)	374 (98%)	8 (2%)	53	68

5 of 8 residues with a non-rotameric sidechain are listed below:

Mol	Chain	Res	Type
1	B	715	GLU
1	B	671	ARG
1	B	573	ILE
1	B	493	GLN
1	B	580	ASN

Sometimes sidechains can be flipped to improve hydrogen bonding and reduce clashes. There are no such sidechains identified.

5.3.3 RNA [i](#)

There are no RNA molecules in this entry.

5.4 Non-standard residues in protein, DNA, RNA chains [i](#)

There are no non-standard protein/DNA/RNA residues in this entry.

5.5 Carbohydrates [i](#)

There are no monosaccharides in this entry.

5.6 Ligand geometry [i](#)

7 ligands are modelled in this entry.

In the following table, the Counts columns list the number of bonds (or angles) for which Mogul statistics could be retrieved, the number of bonds (or angles) that are observed in the model and the number of bonds (or angles) that are defined in the Chemical Component Dictionary. The Link column lists molecule types, if any, to which the group is linked. The Z score for a bond length (or angle) is the number of standard deviations the observed value is removed from the

expected value. A bond length (or angle) with $|Z| > 2$ is considered an outlier worth inspection. RMSZ is the root-mean-square of all Z scores of the bond lengths (or angles).

Mol	Type	Chain	Res	Link	Bond lengths			Bond angles		
					Counts	RMSZ	# $ Z > 2$	Counts	RMSZ	# $ Z > 2$
3	DMS	B	802	-	3,3,3	0.73	0	3,3,3	0.53	0
5	TMA	B	803	-	4,4,4	1.24	0	6,6,6	0.33	0
5	TMA	A	804	-	4,4,4	1.27	0	6,6,6	0.57	0
4	GOL	A	803	-	5,5,5	0.36	0	5,5,5	0.22	0
2	6N9	B	801	-	36,37,37	1.99	8 (22%)	44,54,54	3.00	13 (29%)
3	DMS	A	802	-	3,3,3	0.69	0	3,3,3	0.69	0
2	6N9	A	801	-	36,37,37	1.84	7 (19%)	44,54,54	2.99	14 (31%)

In the following table, the Chirals column lists the number of chiral outliers, the number of chiral centers analysed, the number of these observed in the model and the number defined in the Chemical Component Dictionary. Similar counts are reported in the Torsion and Rings columns. '-' means no outliers of that kind were identified.

Mol	Type	Chain	Res	Link	Chirals	Torsions	Rings
2	6N9	B	801	-	-	2/19/23/23	0/4/4/4
2	6N9	A	801	-	-	3/19/23/23	0/4/4/4
4	GOL	A	803	-	-	3/4/4/4	-

The worst 5 of 15 bond length outliers are listed below:

Mol	Chain	Res	Type	Atoms	Z	Observed(Å)	Ideal(Å)
2	B	801	6N9	C17-C16	6.28	1.57	1.50
2	A	801	6N9	C29-C30	-5.13	1.28	1.38
2	B	801	6N9	C29-C30	-4.59	1.29	1.38
2	A	801	6N9	C17-C16	4.40	1.55	1.50
2	B	801	6N9	C28-C27	4.03	1.47	1.39

The worst 5 of 27 bond angle outliers are listed below:

Mol	Chain	Res	Type	Atoms	Z	Observed(°)	Ideal(°)
2	A	801	6N9	O07-S04-O06	-11.87	102.15	119.35
2	B	801	6N9	O07-S04-O06	-11.06	103.33	119.35
2	B	801	6N9	C25-N26-C20	7.70	124.42	116.69
2	B	801	6N9	C24-C25-N26	-7.08	119.00	125.55
2	A	801	6N9	C25-N26-C20	6.90	123.62	116.69

There are no chirality outliers.

5 of 8 torsion outliers are listed below:

Mol	Chain	Res	Type	Atoms
4	A	803	GOL	O1-C1-C2-C3
2	B	801	6N9	C29-C30-O33-C34
2	B	801	6N9	C31-C30-O33-C34
2	A	801	6N9	C29-C30-O33-C34
2	A	801	6N9	C31-C30-O33-C34

There are no ring outliers.

3 monomers are involved in 7 short contacts:

Mol	Chain	Res	Type	Clashes	Symm-Clashes
5	B	803	TMA	3	0
5	A	804	TMA	3	0
2	B	801	6N9	1	0

The following is a two-dimensional graphical depiction of Mogul quality analysis of bond lengths, bond angles, torsion angles, and ring geometry for all instances of the Ligand of Interest. In addition, ligands with molecular weight > 250 and outliers as shown on the validation Tables will also be included. For torsion angles, if less than 5% of the Mogul distribution of torsion angles is within 10 degrees of the torsion angle in question, then that torsion angle is considered an outlier. Any bond that is central to one or more torsion angles identified as an outlier by Mogul will be highlighted in the graph. For rings, the root-mean-square deviation (RMSD) between the ring in question and similar rings identified by Mogul is calculated over all ring torsion angles. If the average RMSD is greater than 60 degrees and the minimal RMSD between the ring in question and any Mogul-identified rings is also greater than 60 degrees, then that ring is considered an outlier. The outliers are highlighted in purple. The color gray indicates Mogul did not find sufficient equivalents in the CSD to analyse the geometry.

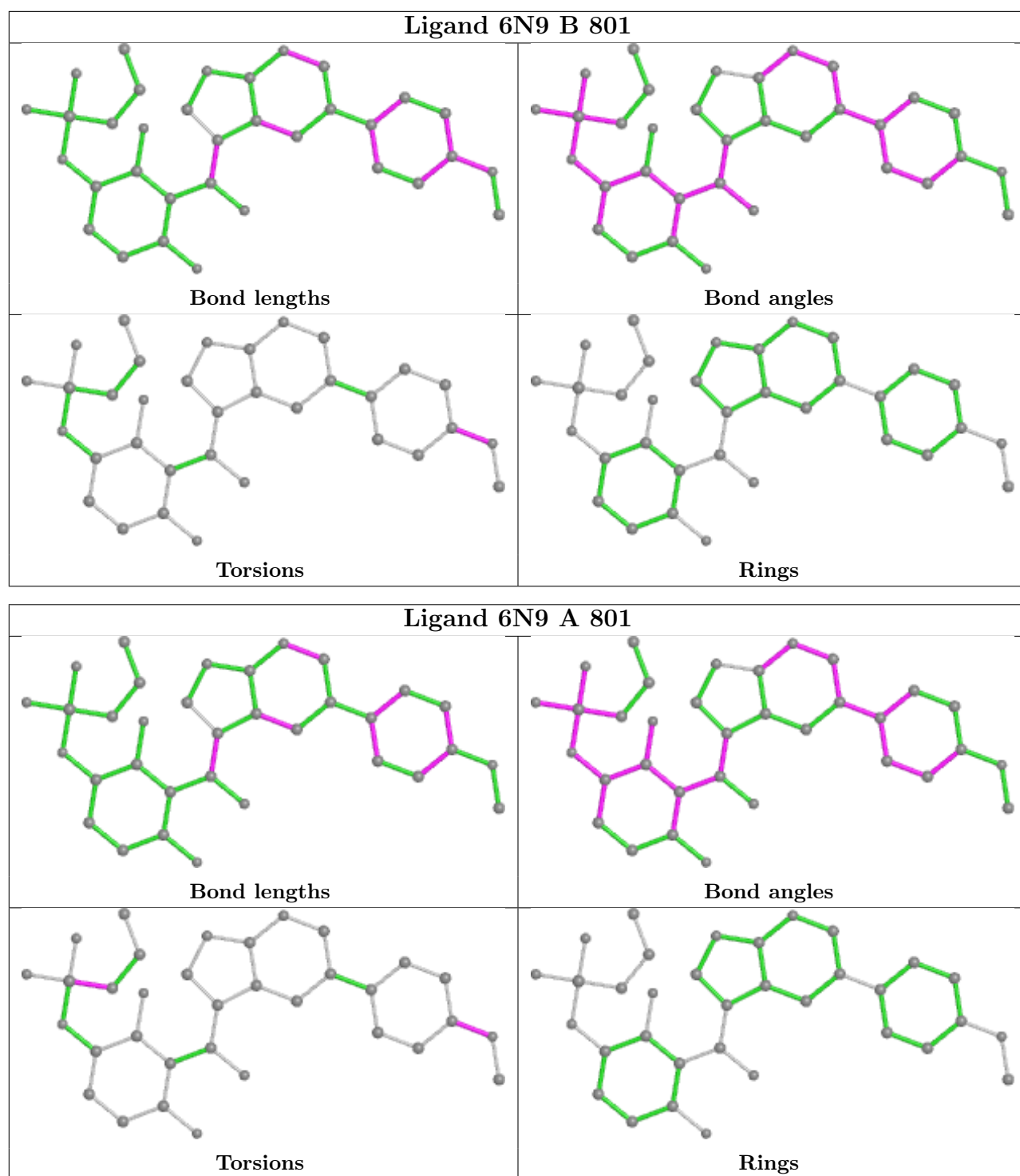

5.7 Other polymers [\(i\)](#)

There are no such residues in this entry.

5.8 Polymer linkage issues

There are no chain breaks in this entry.

6 Fit of model and data [i](#)

6.1 Protein, DNA and RNA chains [i](#)

In the following table, the column labelled ‘#RSRZ > 2’ contains the number (and percentage) of RSRZ outliers, followed by percent RSRZ outliers for the chain as percentile scores relative to all X-ray entries and entries of similar resolution. The OWAB column contains the minimum, median, 95th percentile and maximum values of the occupancy-weighted average B-factor per residue. The column labelled ‘Q < 0.9’ lists the number of (and percentage) of residues with an average occupancy less than 0.9.

Mol	Chain	Analysed	<RSRZ>	#RSRZ>2	OWAB(Å ²)	Q<0.9
1	A	258/280 (92%)	-0.12	0 100 100	13, 27, 43, 63	0
1	B	246/280 (87%)	-0.10	8 (3%) 46 52	16, 26, 40, 51	0
All	All	504/560 (90%)	-0.11	8 (1%) 72 77	13, 26, 42, 63	0

The worst 5 of 8 RSRZ outliers are listed below:

Mol	Chain	Res	Type	RSRZ
1	B	599	THR	3.7
1	B	626	ARG	3.2
1	B	455	GLY	2.6
1	B	447	PHE	2.4
1	B	598	ALA	2.3

6.2 Non-standard residues in protein, DNA, RNA chains [i](#)

There are no non-standard protein/DNA/RNA residues in this entry.

6.3 Carbohydrates [i](#)

There are no monosaccharides in this entry.

6.4 Ligands [i](#)

In the following table, the Atoms column lists the number of modelled atoms in the group and the number defined in the chemical component dictionary. The B-factors column lists the minimum, median, 95th percentile and maximum values of B factors of atoms in the group. The column labelled ‘Q < 0.9’ lists the number of atoms with occupancy less than 0.9.

Mol	Type	Chain	Res	Atoms	RSCC	RSR	B-factors(\AA^2)	Q<0.9
3	DMS	A	802	4/4	0.89	0.22	27,32,39,61	0
5	TMA	B	803	5/5	0.90	0.22	25,32,39,39	0
4	GOL	A	803	6/6	0.91	0.15	23,37,45,48	0
5	TMA	A	804	5/5	0.92	0.30	29,35,41,41	0
3	DMS	B	802	4/4	0.95	0.16	29,36,59,61	0
2	6N9	B	801	34/34	0.95	0.12	14,21,37,53	0
2	6N9	A	801	34/34	0.97	0.12	14,21,31,46	0

The following is a graphical depiction of the model fit to experimental electron density of all instances of the Ligand of Interest. In addition, ligands with molecular weight > 250 and outliers as shown on the geometry validation Tables will also be included. Each fit is shown from different orientation to approximate a three-dimensional view.

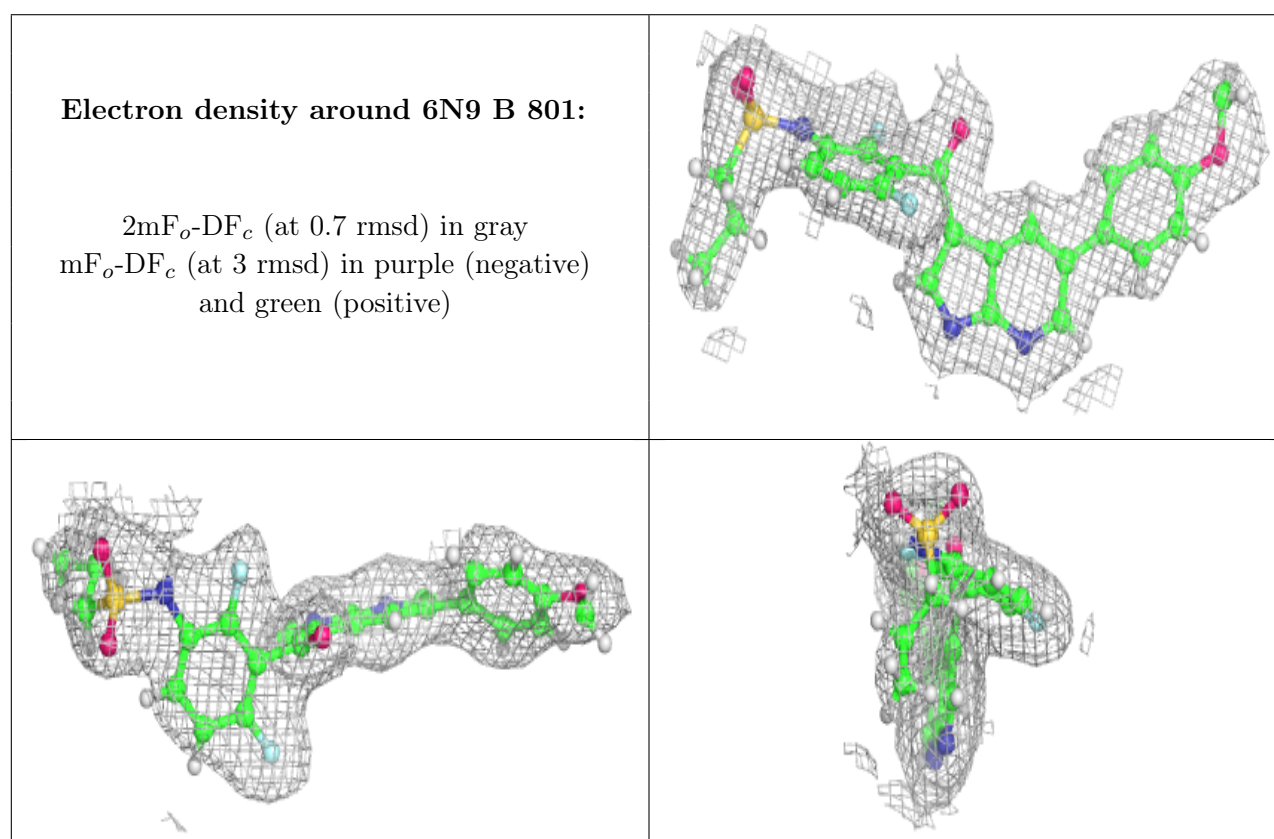

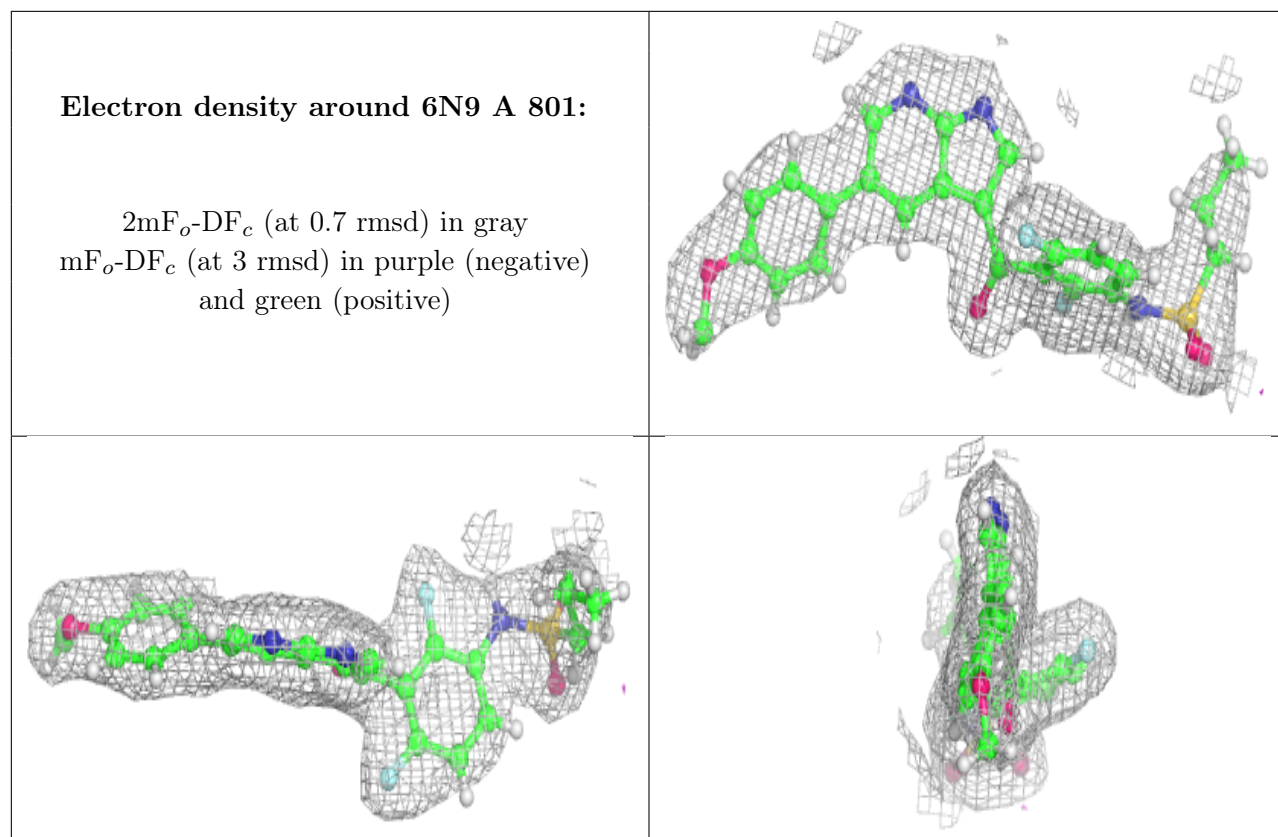

6.5 Other polymers [i](#)

There are no such residues in this entry.