



wwPDB X-ray Structure Validation Summary Report ⓘ

Oct 11, 2023 – 01:57 AM EDT

PDB ID : 7K6V
Title : Crystal Structure of Virus-like Particles of GII.4 Norovirus Houston virus (HOV)
Authors : Hu, L.; Prasad, B.V.V.
Deposited on : 2020-09-21
Resolution : 3.00 Å (reported)

This is a wwPDB X-ray Structure Validation Summary Report for a publicly released PDB entry.

We welcome your comments at validation@mail.wwpdb.org

A user guide is available at

<https://www.wwpdb.org/validation/2017/XrayValidationReportHelp>

with specific help available everywhere you see the ⓘ symbol.

The types of validation reports are described at

<http://www.wwpdb.org/validation/2017/FAQs#types>.

The following versions of software and data (see [references ⓘ](#)) were used in the production of this report:

MolProbity : 4.02b-467
Mogul : 1.8.5 (274361), CSD as541be (2020)
Xtriage (Phenix) : 1.13
EDS : 2.35.1
buster-report : 1.1.7 (2018)
Percentile statistics : 20191225.v01 (using entries in the PDB archive December 25th 2019)
Refmac : 5.8.0158
CCP4 : 7.0.044 (Gargrove)
Ideal geometry (proteins) : Engh & Huber (2001)
Ideal geometry (DNA, RNA) : Parkinson et al. (1996)
Validation Pipeline (wwPDB-VP) : 2.35.1

1 Overall quality at a glance

The following experimental techniques were used to determine the structure:

X-RAY DIFFRACTION

The reported resolution of this entry is 3.00 Å.

Percentile scores (ranging between 0-100) for global validation metrics of the entry are shown in the following graphic. The table shows the number of entries on which the scores are based.

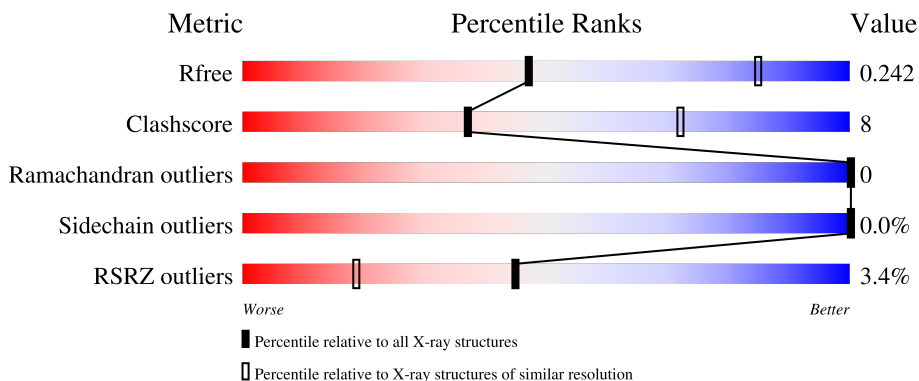

Metric	Whole archive (#Entries)	Similar resolution (#Entries, resolution range(Å))
R_{free}	130704	2092 (3.00-3.00)
Clashscore	141614	2416 (3.00-3.00)
Ramachandran outliers	138981	2333 (3.00-3.00)
Sidechain outliers	138945	2336 (3.00-3.00)
RSRZ outliers	127900	1990 (3.00-3.00)

The table below summarises the geometric issues observed across the polymeric chains and their fit to the electron density. The red, orange, yellow and green segments of the lower bar indicate the fraction of residues that contain outliers for ≥ 3 , 2, 1 and 0 types of geometric quality criteria respectively. A grey segment represents the fraction of residues that are not modelled. The numeric value for each fraction is indicated below the corresponding segment, with a dot representing fractions $\leq 5\%$. The upper red bar (where present) indicates the fraction of residues that have poor fit to the electron density. The numeric value is given above the bar.

Mol	Chain	Length	Quality of chain
1	AA	540	 2% 78% 15% 7%
1	AB	540	 2% 80% 17% 3%
1	AC	540	 2% 77% 17% 6%
1	BA	540	 3% 77% 16% 8%
1	BB	540	 2% 78% 19% 1%

Continued on next page...

Continued from previous page...

Mol	Chain	Length	Quality of chain
1	BC	540	 5% 77% 17% 6%
1	CA	540	 % 75% 18% 8%
1	CB	540	 3% 79% 18% .
1	CC	540	 % 79% 15% 6%
1	DA	540	 2% 71% 22% 8%
1	DB	540	 3% 79% 18% .
1	DC	540	 4% 76% 18% 6%
1	EA	540	 % 77% 16% 8%
1	EB	540	 2% 80% 17% .
1	EC	540	 11% 70% 21% 9%
1	FA	540	 2% 74% 19% 8%
1	FB	540	 2% 78% 19% .
1	FC	540	 5% 76% 18% 6%
1	GA	540	 2% 77% 16% 8%
1	GB	540	 2% 78% 19% .
1	GC	540	 3% 77% 17% 6%
1	HA	540	 2% 76% 16% 8%
1	HB	540	 % 81% 16% .
1	HC	540	 3% 79% 15% 6%
1	IA	540	 2% 79% 14% 8%
1	IB	540	 3% 78% 18% .
1	IC	540	 8% 76% 16% 7%
1	JA	540	 2% 77% 16% 8%
1	JB	540	 2% 81% 16% .
1	JC	540	 11% 74% 20% 6%

Continued on next page...

Continued from previous page...

Mol	Chain	Length	Quality of chain
1	KA	540	<p>2% 76% 17% 8%</p>
1	KB	540	<p>3% 80% 17% 8%</p>
1	KC	540	<p>3% 76% 17% 6%</p>
1	LA	540	<p>2% 77% 15% 8%</p>
1	LB	540	<p>3% 82% 15% 8%</p>
1	LC	540	<p>6% 73% 19% 7%</p>
1	MA	540	<p>2% 75% 17% 8%</p>
1	MB	540	<p>2% 81% 16% 8%</p>
1	MC	540	<p>4% 77% 16% 6%</p>
1	NA	540	<p>2% 76% 16% 8%</p>
1	NB	540	<p>3% 81% 16% 8%</p>
1	NC	540	<p>2% 78% 16% 6%</p>
1	OA	540	<p>3% 76% 16% 8%</p>
1	OB	540	<p>3% 77% 19% 8%</p>
1	OC	540	<p>11% 75% 17% 8%</p>

2 Entry composition

There are 5 unique types of molecules in this entry. The entry contains 176522 atoms, of which 0 are hydrogens and 0 are deuteriums.

In the tables below, the ZeroOcc column contains the number of atoms modelled with zero occupancy, the AltConf column contains the number of residues with at least one atom in alternate conformation and the Trace column contains the number of residues modelled with at most 2 atoms.

- Molecule 1 is a protein called Capsid protein VP1.

Mol	Chain	Residues	Atoms					ZeroOcc	AltConf	Trace
			Total	C	N	O	S			
1	AA	500	Total 3860	C 2474	N 656	O 715	S 15	0	0	0
1	AB	523	Total 4013	C 2560	N 681	O 757	S 15	0	0	0
1	AC	508	Total 3921	C 2506	N 668	O 732	S 15	0	0	0
1	BA	499	Total 3853	C 2469	N 655	O 714	S 15	0	0	0
1	BB	523	Total 4019	C 2563	N 684	O 757	S 15	0	0	0
1	BC	507	Total 3913	C 2502	N 666	O 730	S 15	0	0	0
1	CA	499	Total 3853	C 2469	N 655	O 714	S 15	0	0	0
1	CB	523	Total 4013	C 2560	N 681	O 757	S 15	0	0	0
1	CC	507	Total 3913	C 2502	N 666	O 730	S 15	0	0	0
1	DA	498	Total 3845	C 2464	N 654	O 713	S 14	0	0	0
1	DB	523	Total 4013	C 2560	N 681	O 757	S 15	0	0	0
1	DC	506	Total 3906	C 2497	N 665	O 730	S 14	0	0	0
1	EA	499	Total 3853	C 2469	N 655	O 714	S 15	0	0	0
1	EB	523	Total 4013	C 2560	N 681	O 757	S 15	0	0	0
1	EC	493	Total 3814	C 2442	N 651	O 709	S 12	0	0	0
1	FA	499	Total 3853	C 2469	N 655	O 714	S 15	0	0	0

Continued on next page...

Continued from previous page...

Mol	Chain	Residues	Atoms					ZeroOcc	AltConf	Trace
			Total	C	N	O	S			
1	FB	523	4019	2563	684	757	15	0	0	0
1	FC	509	3928	2511	669	733	15	0	0	0
1	GA	499	3853	2469	655	714	15	0	0	0
1	GB	523	4016	2562	684	755	15	0	0	0
1	GC	507	3913	2502	666	730	15	0	0	0
1	HA	499	3853	2469	655	714	15	0	0	0
1	HB	523	4015	2561	684	755	15	0	0	0
1	HC	507	3913	2502	666	730	15	0	0	0
1	IA	499	3853	2469	655	714	15	0	0	0
1	IB	523	4019	2564	685	755	15	0	0	0
1	IC	503	3885	2487	660	723	15	0	0	0
1	JA	499	3853	2469	655	714	15	0	0	0
1	JB	523	4007	2558	681	753	15	0	0	0
1	JC	506	3906	2497	665	730	14	0	0	0
1	KA	499	3853	2469	655	714	15	0	0	0
1	KB	523	4009	2558	681	755	15	0	0	0
1	KC	507	3913	2502	666	730	15	0	0	0
1	LA	499	3853	2469	655	714	15	0	0	0
1	LB	523	4003	2556	681	751	15	0	0	0
1	LC	502	3865	2474	657	719	15	0	0	0
1	MA	499	3853	2469	655	714	15	0	0	0

Continued on next page...

Continued from previous page...

Mol	Chain	Residues	Atoms					ZeroOcc	AltConf	Trace
1	MB	523	Total	C	N	O	S	0	0	0
			4010	2559	681	755	15			
1	MC	506	Total	C	N	O	S	0	0	0
			3906	2497	665	730	14			
1	NA	499	Total	C	N	O	S	0	0	0
			3853	2469	655	714	15			
1	NB	523	Total	C	N	O	S	0	0	0
			4017	2564	685	753	15			
1	NC	506	Total	C	N	O	S	0	0	0
			3899	2494	665	726	14			
1	OA	499	Total	C	N	O	S	0	0	0
			3853	2469	655	714	15			
1	OB	523	Total	C	N	O	S	0	0	0
			4017	2564	685	753	15			
1	OC	498	Total	C	N	O	S	0	0	0
			3851	2464	656	719	12			

- Molecule 2 is CHLORIDE ION (three-letter code: CL) (formula: Cl).

Mol	Chain	Residues	Atoms		ZeroOcc	AltConf
2	AA	3	Total	Cl	0	0
			3	3		
2	AB	1	Total	Cl	0	0
			1	1		
2	AC	1	Total	Cl	0	0
			1	1		
2	BA	2	Total	Cl	0	0
			2	2		
2	BC	1	Total	Cl	0	0
			1	1		
2	CA	2	Total	Cl	0	0
			2	2		
2	CC	3	Total	Cl	0	0
			3	3		
2	DA	1	Total	Cl	0	0
			1	1		
2	DB	1	Total	Cl	0	0
			1	1		
2	DC	2	Total	Cl	0	0
			2	2		
2	EA	3	Total	Cl	0	0
			3	3		

Continued on next page...

Continued from previous page...

Mol	Chain	Residues	Atoms	ZeroOcc	AltConf
2	FA	2	Total Cl 2 2	0	0
2	GA	1	Total Cl 1 1	0	0
2	GC	2	Total Cl 2 2	0	0
2	HA	1	Total Cl 1 1	0	0
2	HC	1	Total Cl 1 1	0	0
2	IA	3	Total Cl 3 3	0	0
2	JA	3	Total Cl 3 3	0	0
2	KA	2	Total Cl 2 2	0	0
2	KC	2	Total Cl 2 2	0	0
2	LA	1	Total Cl 1 1	0	0
2	LC	2	Total Cl 2 2	0	0
2	MA	3	Total Cl 3 3	0	0
2	MC	2	Total Cl 2 2	0	0
2	NA	2	Total Cl 2 2	0	0
2	NC	1	Total Cl 1 1	0	0
2	OA	2	Total Cl 2 2	0	0

- Molecule 3 is CADMIUM ION (three-letter code: CD) (formula: Cd) (labeled as "Ligand of Interest" by depositor).

Mol	Chain	Residues	Atoms	ZeroOcc	AltConf
3	AC	1	Total Cd 1 1	0	0
3	BA	1	Total Cd 1 1	0	0
3	BC	1	Total Cd 1 1	0	0

Continued on next page...

Continued from previous page...

Mol	Chain	Residues	Atoms	ZeroOcc	AltConf
3	CA	1	Total Cd 1 1	0	0
3	DA	1	Total Cd 1 1	0	0
3	EA	1	Total Cd 1 1	0	0
3	EB	1	Total Cd 1 1	0	0
3	EC	1	Total Cd 1 1	0	0
3	FA	1	Total Cd 1 1	0	0
3	FC	1	Total Cd 1 1	0	0
3	GA	1	Total Cd 1 1	0	0
3	GB	1	Total Cd 1 1	0	0
3	HC	1	Total Cd 1 1	0	0
3	IA	1	Total Cd 1 1	0	0
3	JA	1	Total Cd 1 1	0	0
3	JC	1	Total Cd 1 1	0	0
3	KA	1	Total Cd 1 1	0	0
3	KB	1	Total Cd 1 1	0	0
3	MA	1	Total Cd 1 1	0	0
3	MB	1	Total Cd 1 1	0	0
3	NC	1	Total Cd 1 1	0	0
3	OA	1	Total Cd 1 1	0	0

- Molecule 4 is 1,2-ETHANEDIOL (three-letter code: EDO) (formula: C₂H₆O₂).

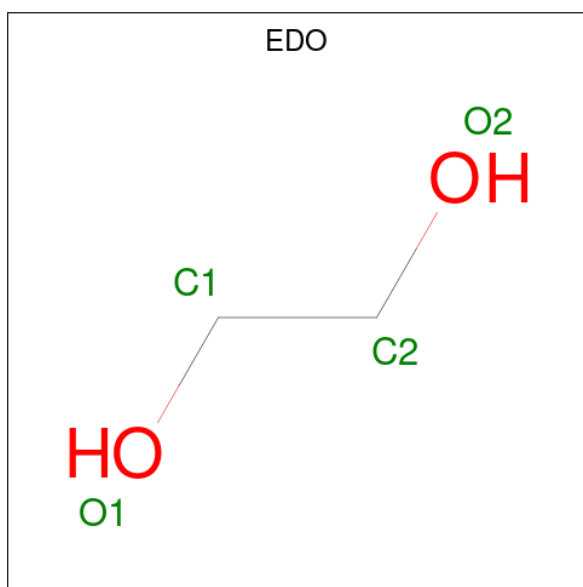

Mol	Chain	Residues	Atoms	ZeroOcc	AltConf
4	JA	1	Total C O 4 2 2	0	0

- Molecule 5 is water.

Mol	Chain	Residues	Atoms	ZeroOcc	AltConf
5	HC	1	Total O 1 1	0	0
5	OA	1	Total O 1 1	0	0
5	OB	1	Total O 1 1	0	0

3 Residue-property plots [i](#)

These plots are drawn for all protein, RNA, DNA and oligosaccharide chains in the entry. The first graphic for a chain summarises the proportions of the various outlier classes displayed in the second graphic. The second graphic shows the sequence view annotated by issues in geometry and electron density. Residues are color-coded according to the number of geometric quality criteria for which they contain at least one outlier: green = 0, yellow = 1, orange = 2 and red = 3 or more. A red dot above a residue indicates a poor fit to the electron density ($RSRZ > 2$). Stretches of 2 or more consecutive residues without any outlier are shown as a green connector. Residues present in the sample, but not in the model, are shown in grey.

- Molecule 1: Capsid protein VP1

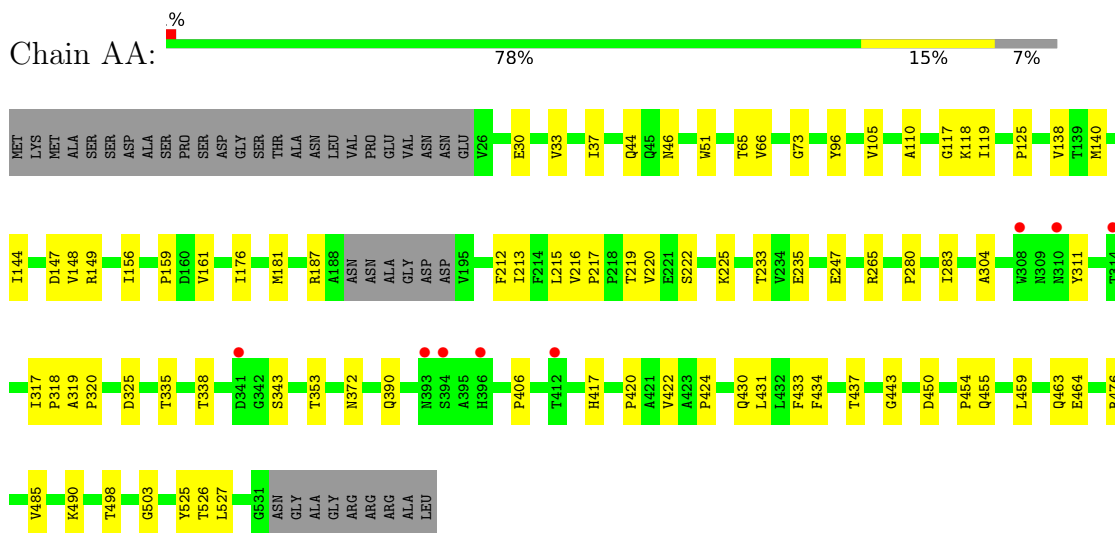

- Molecule 1: Capsid protein VP1

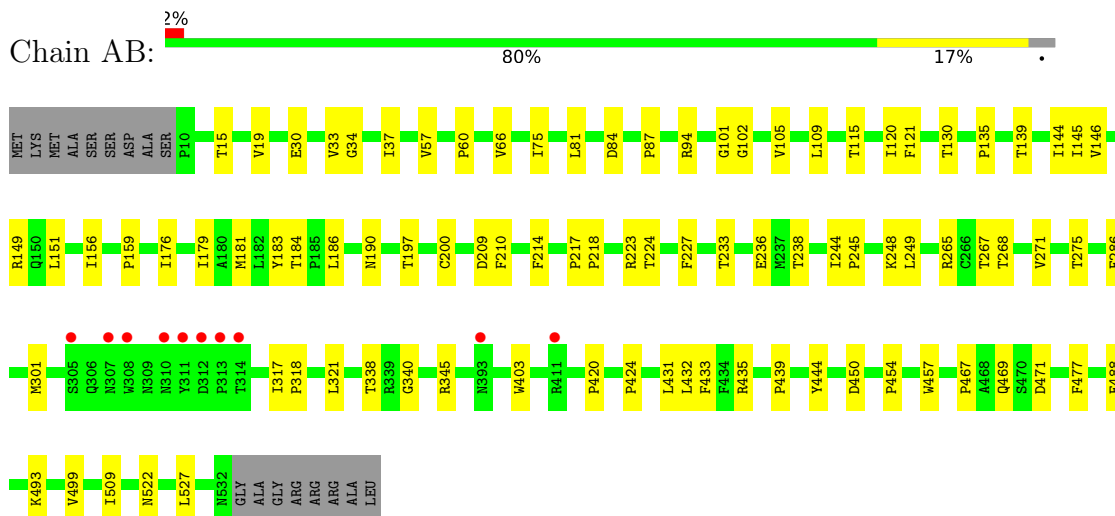

- Molecule 1: Capsid protein VP1

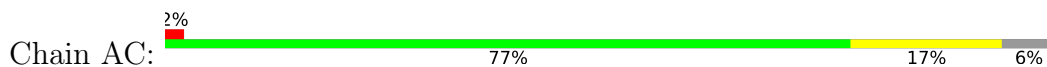

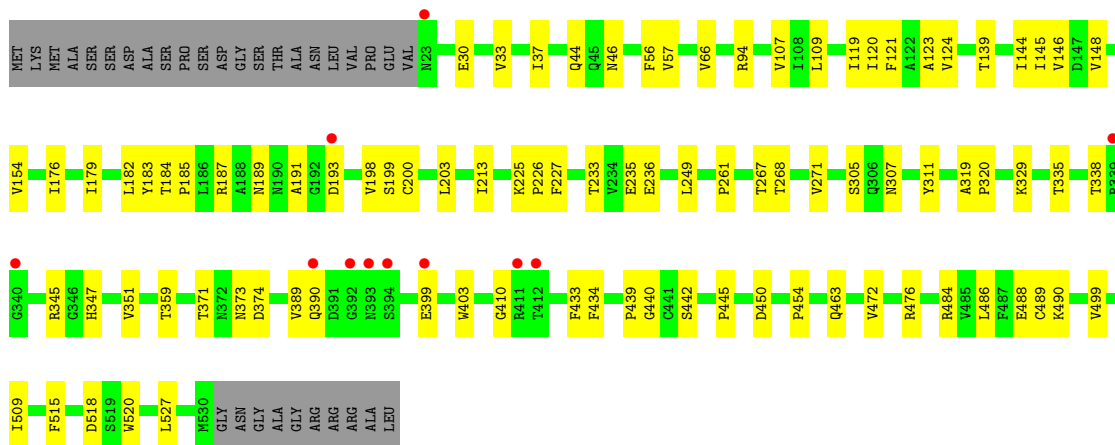

• Molecule 1: Capsid protein VP1

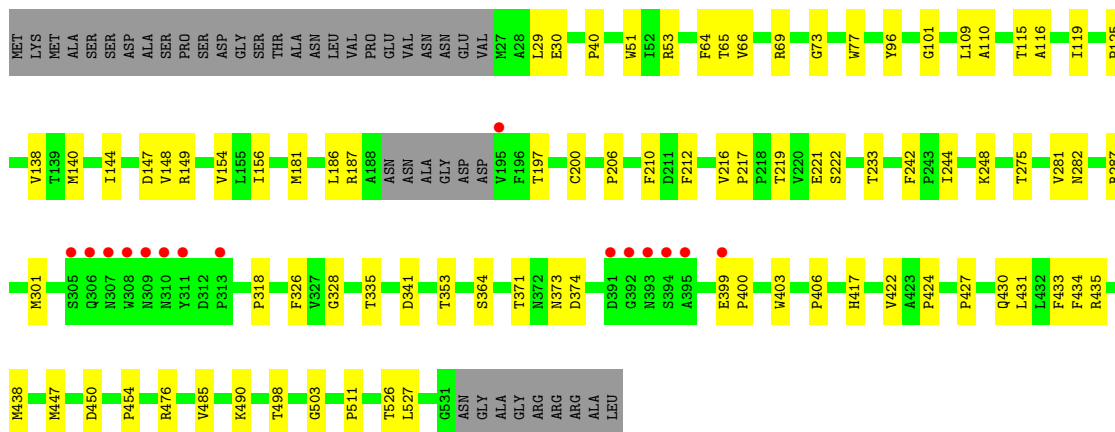
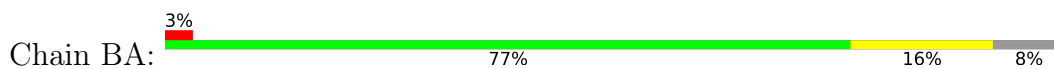

• Molecule 1: Capsid protein VP1

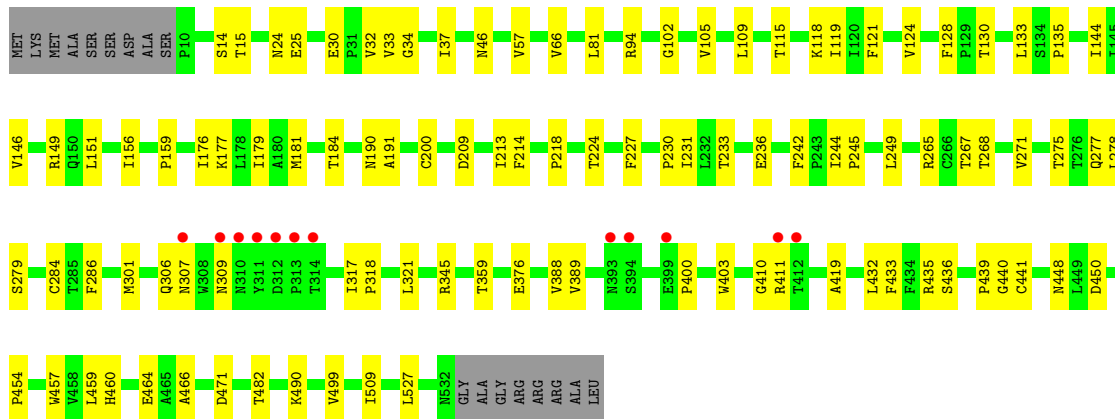
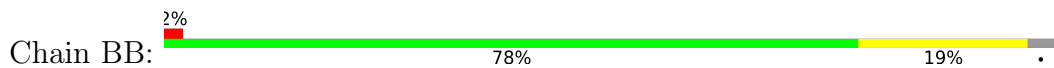

• Molecule 1: Capsid protein VP1

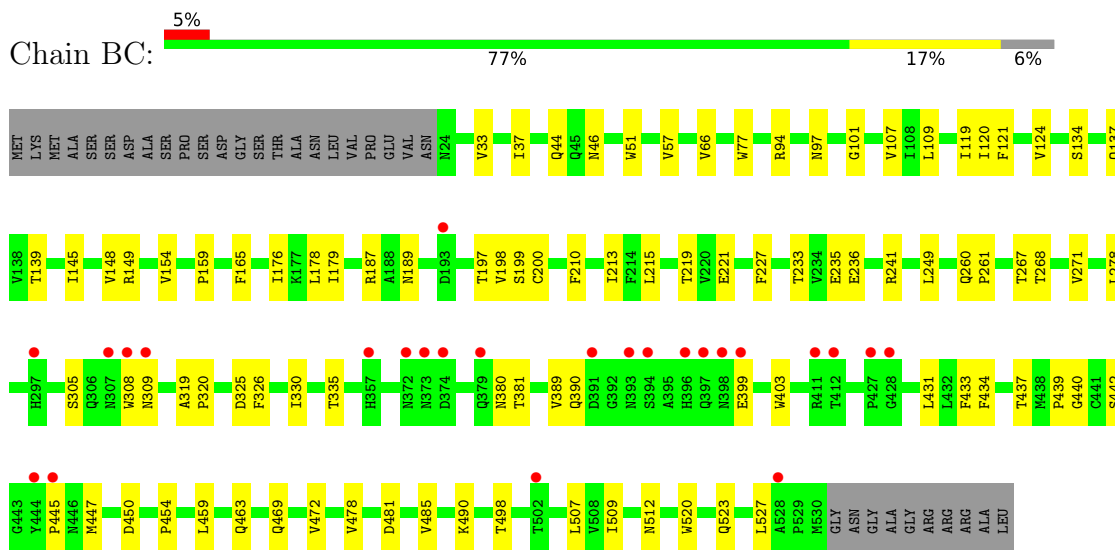

● Molecule 1: Capsid protein VP1

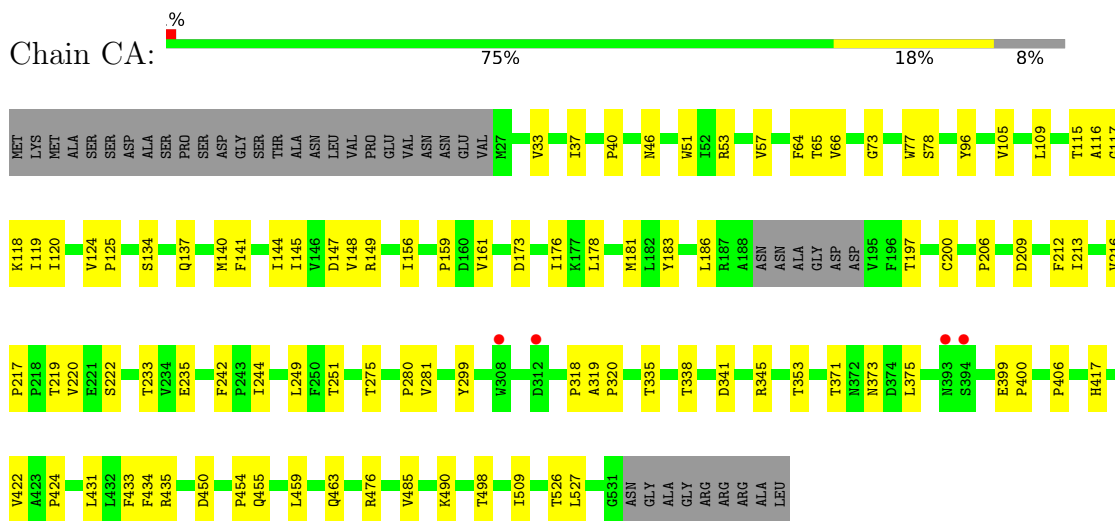

● Molecule 1: Capsid protein VP1



● Molecule 1: Capsid protein VP1

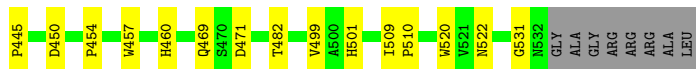

• Molecule 1: Capsid protein VP1

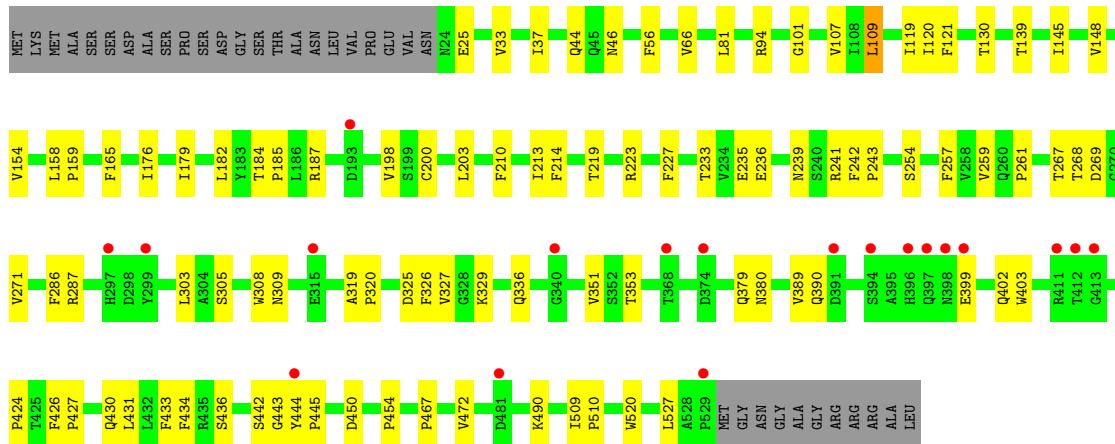
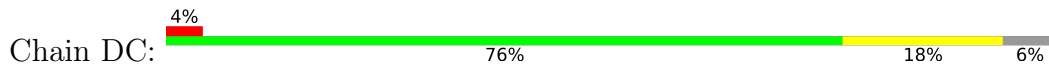

• Molecule 1: Capsid protein VP1

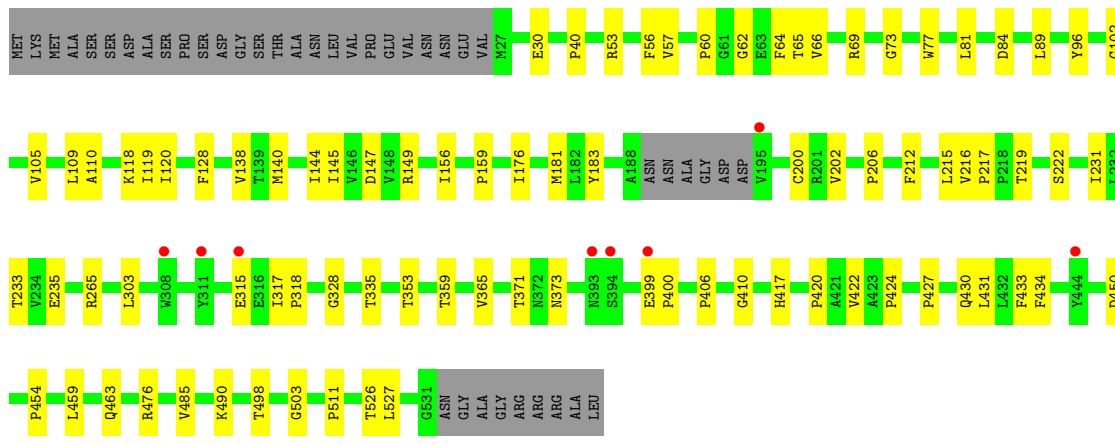
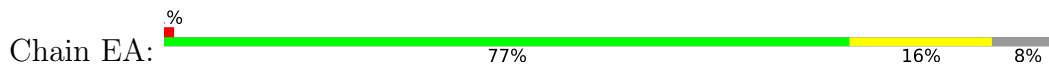

• Molecule 1: Capsid protein VP1

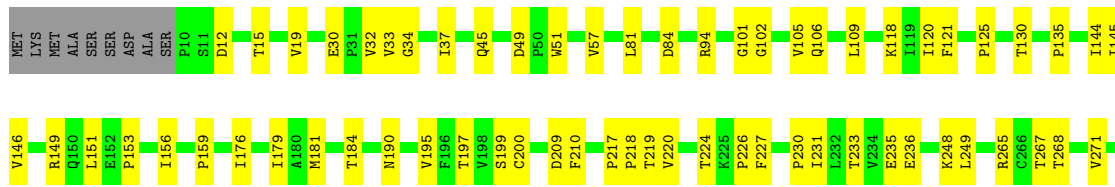
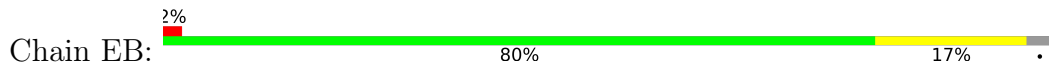

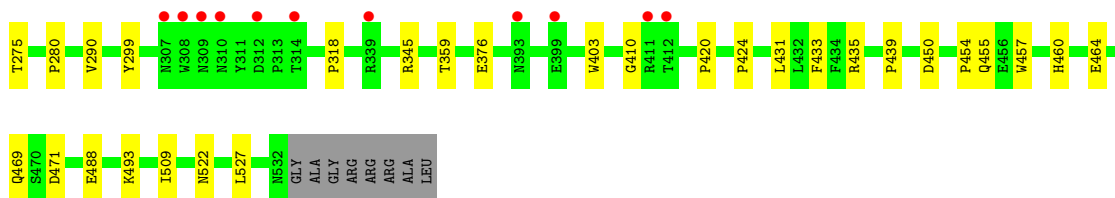

• Molecule 1: Capsid protein VP1

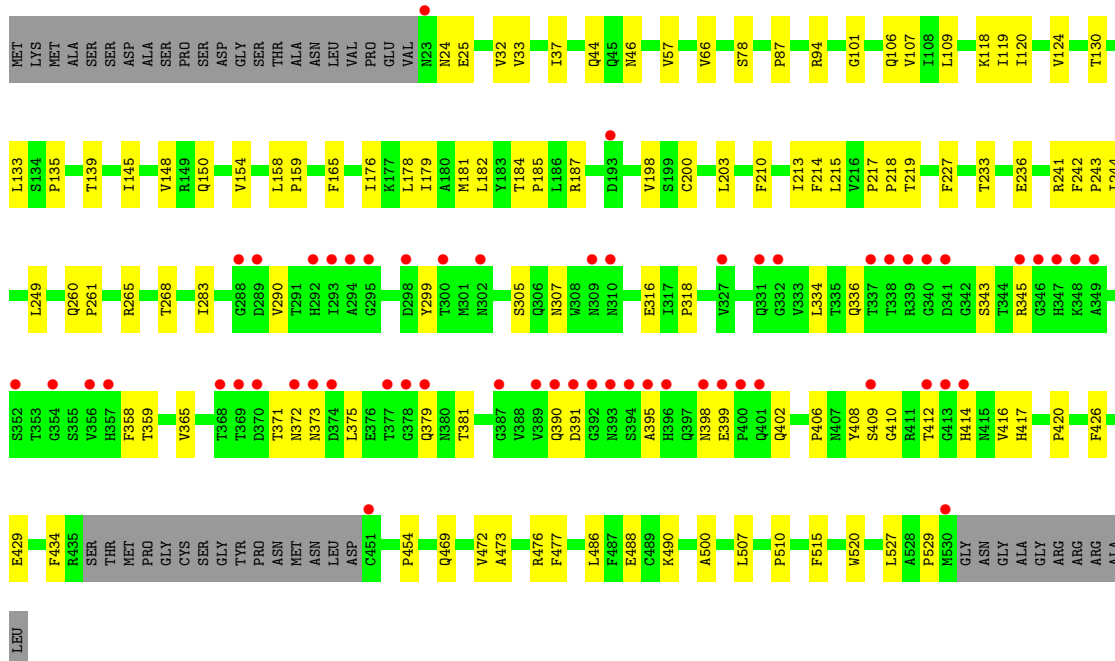

• Molecule 1: Capsid protein VP1

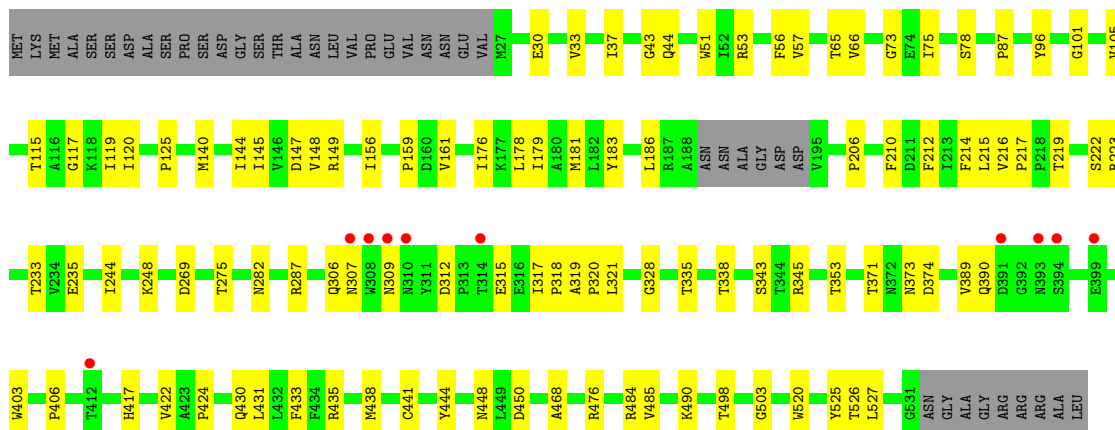
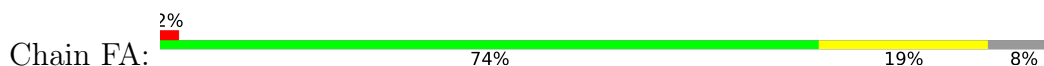

• Molecule 1: Capsid protein VP1

● Molecule 1: Capsid protein VP1

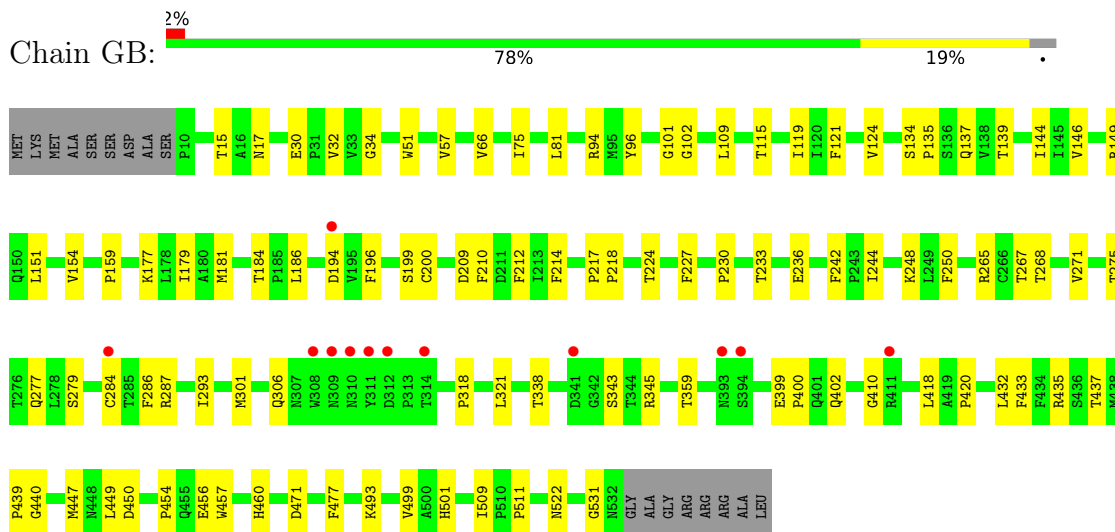

● Molecule 1: Capsid protein VP1

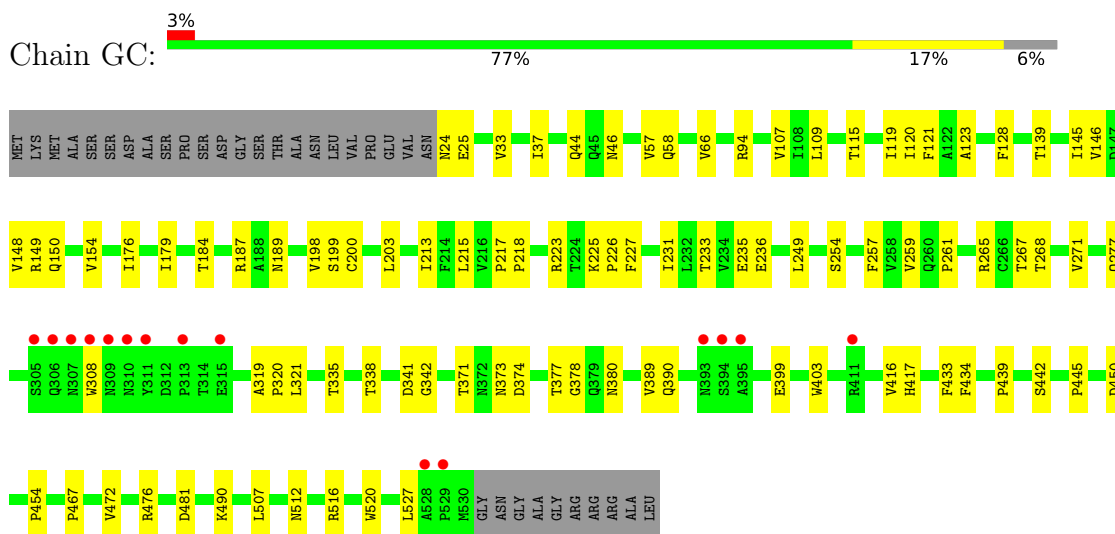

● Molecule 1: Capsid protein VP1

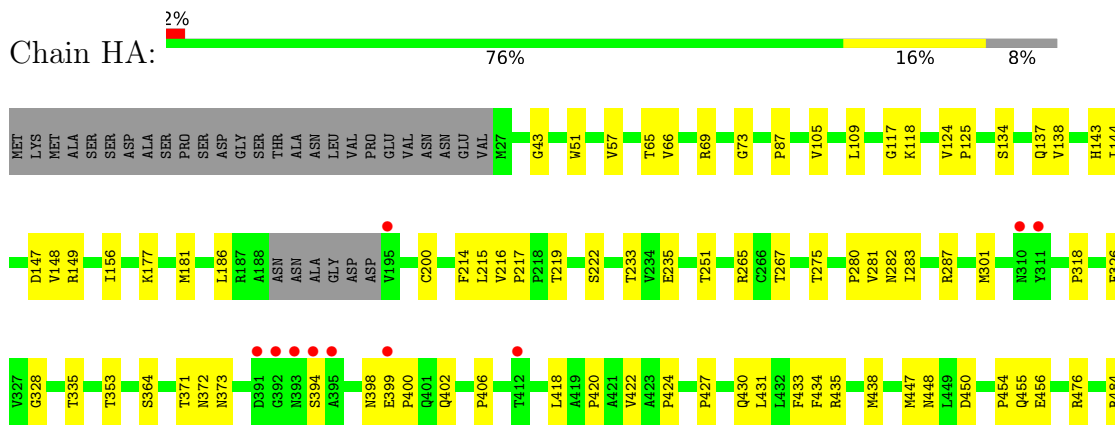



• Molecule 1: Capsid protein VP1

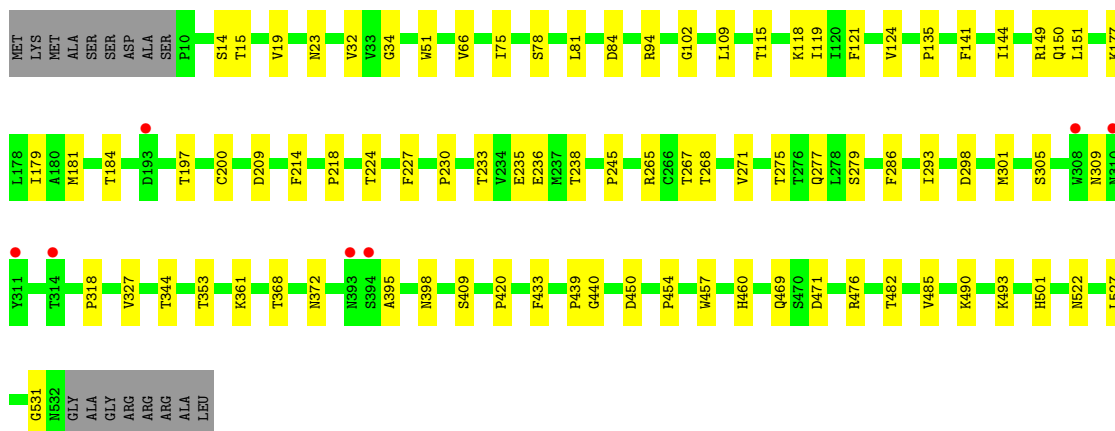
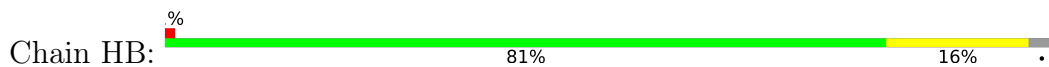

• Molecule 1: Capsid protein VP1

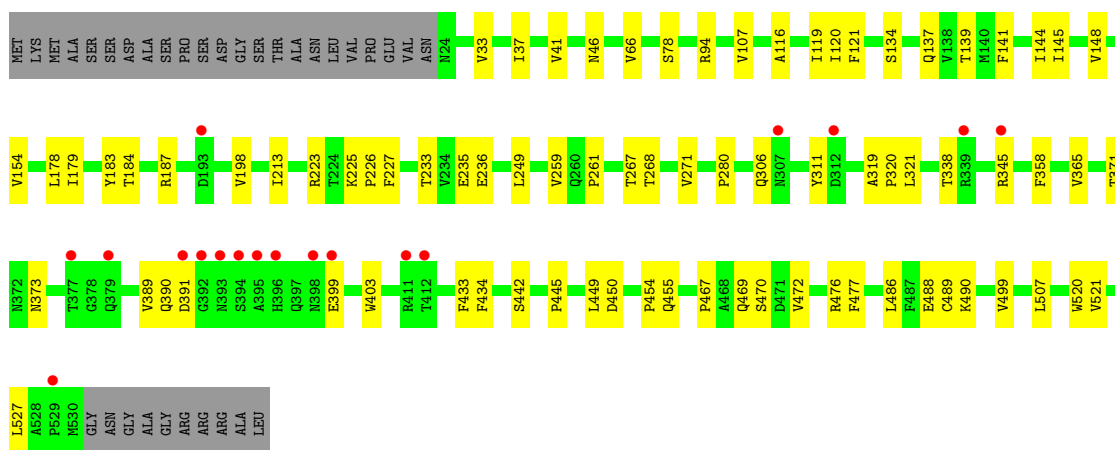
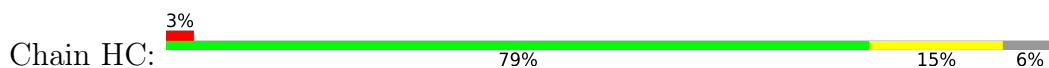

• Molecule 1: Capsid protein VP1

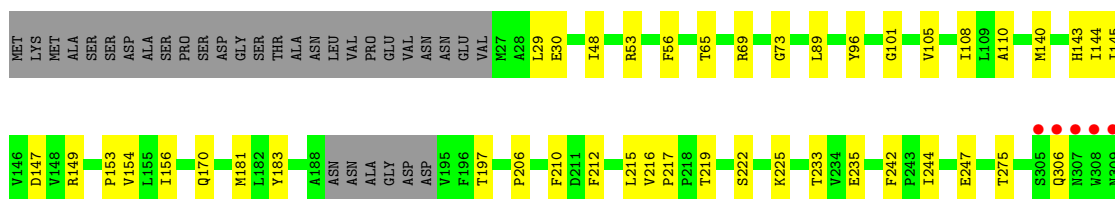
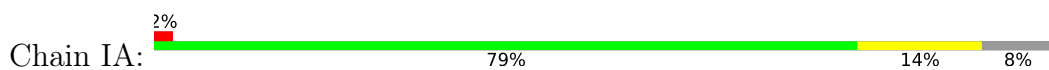

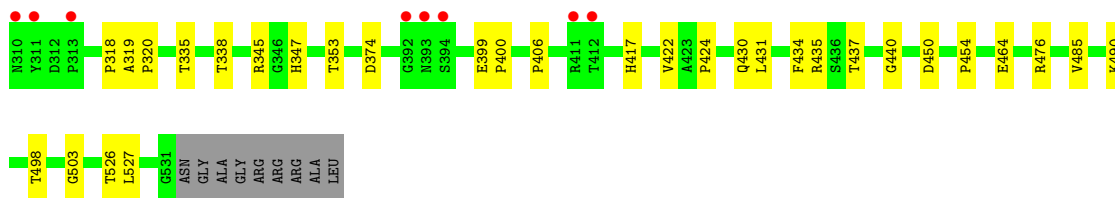

● Molecule 1: Capsid protein VP1

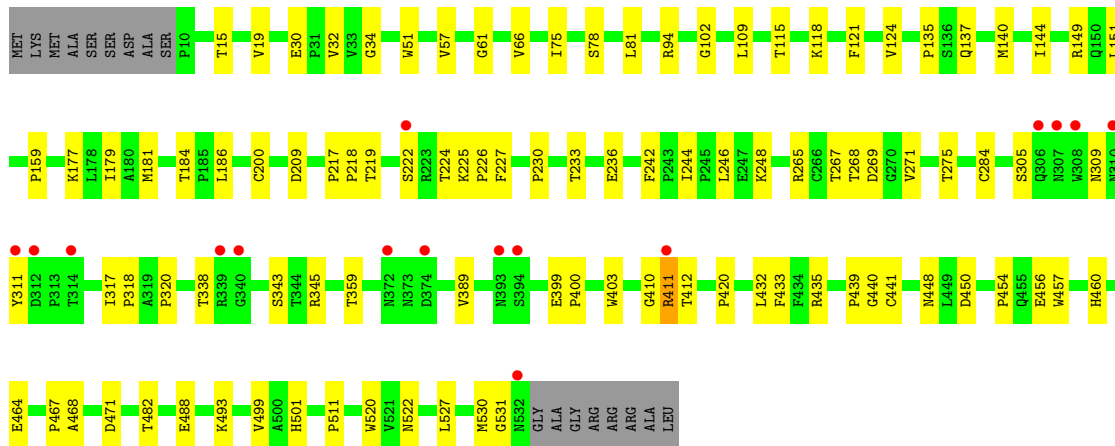
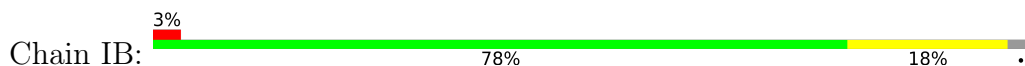

● Molecule 1: Capsid protein VP1

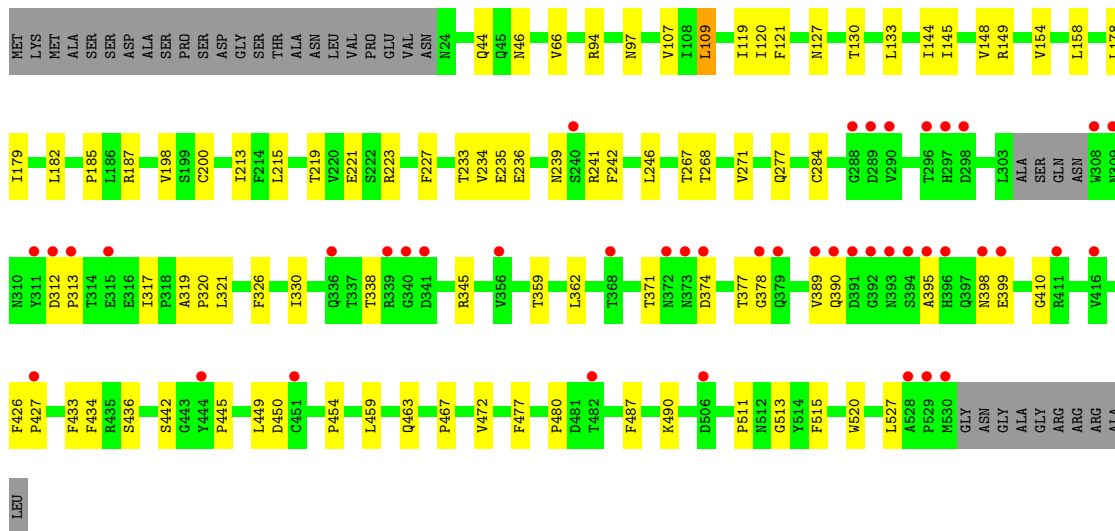
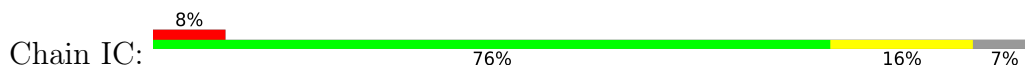

● Molecule 1: Capsid protein VP1

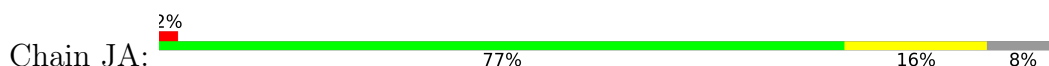

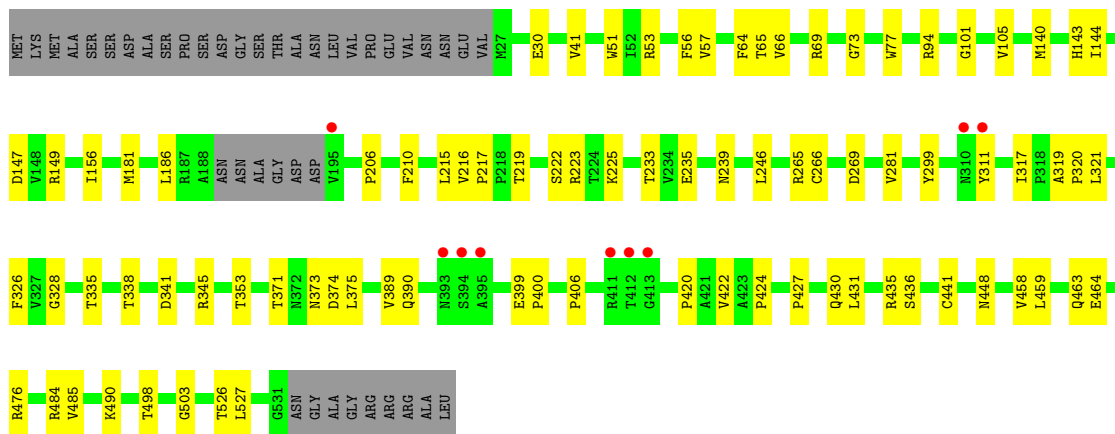

● Molecule 1: Capsid protein VP1

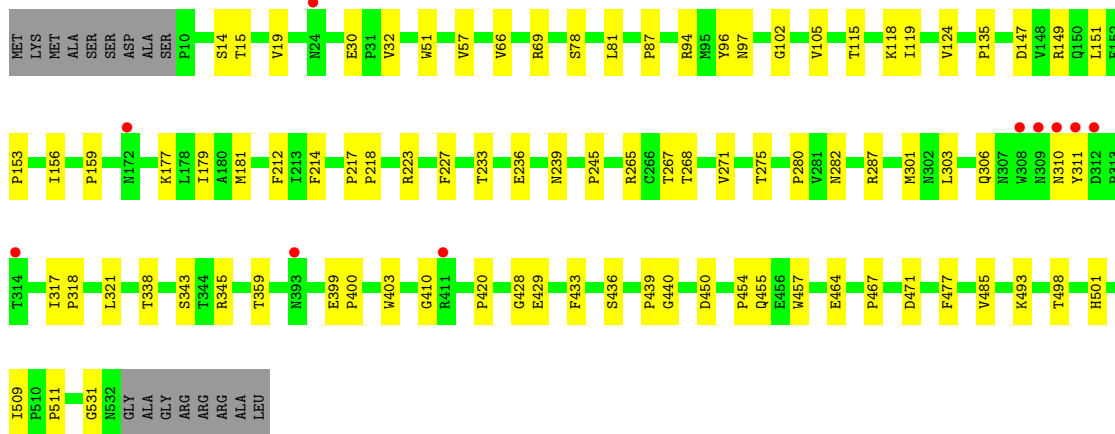
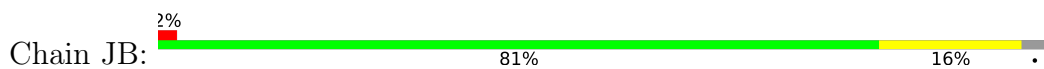

● Molecule 1: Capsid protein VP1

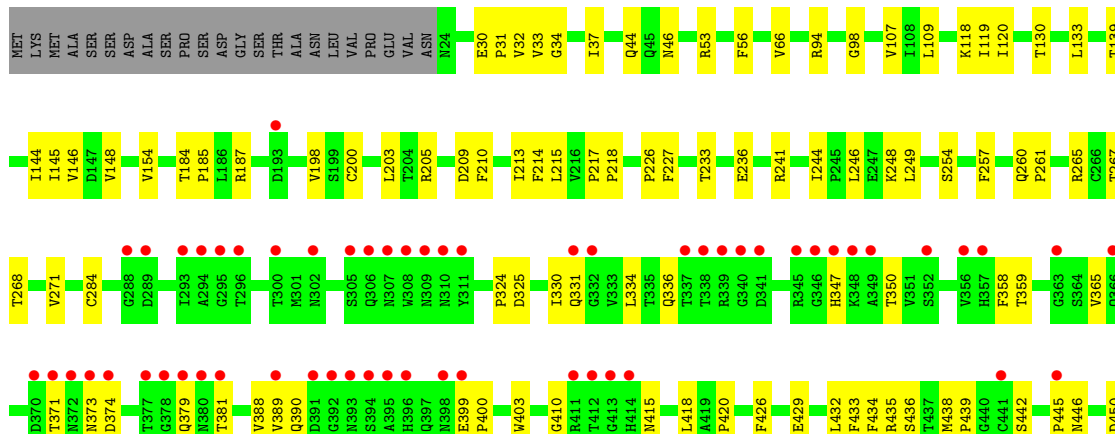
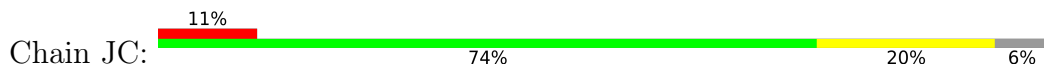

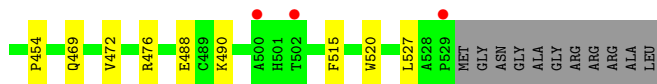

● Molecule 1: Capsid protein VP1

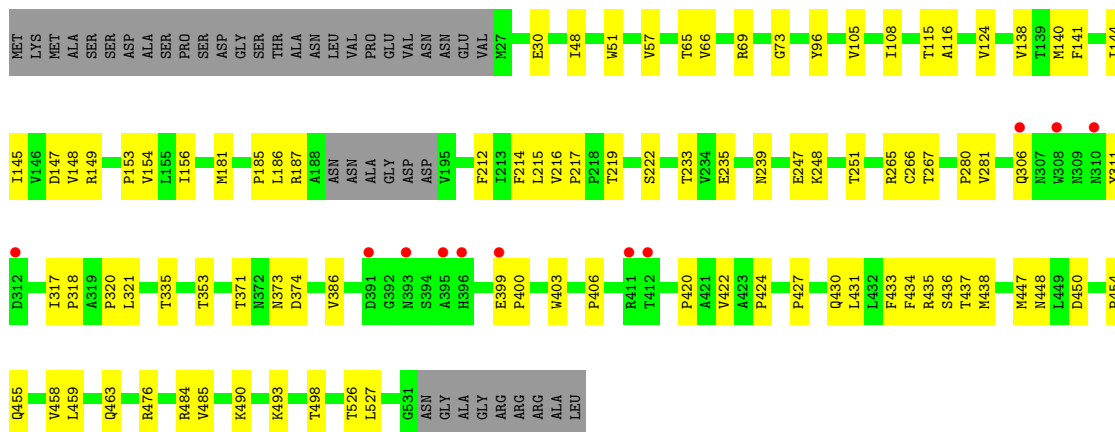
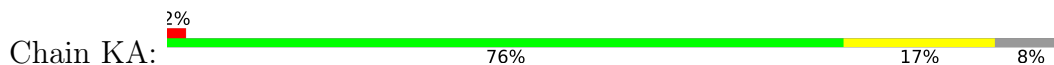

● Molecule 1: Capsid protein VP1

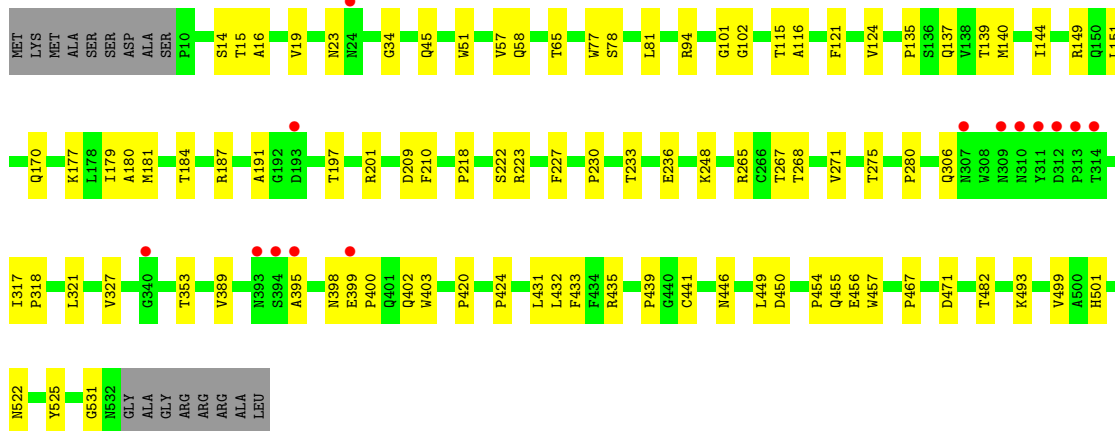
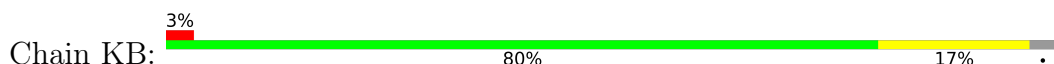

● Molecule 1: Capsid protein VP1

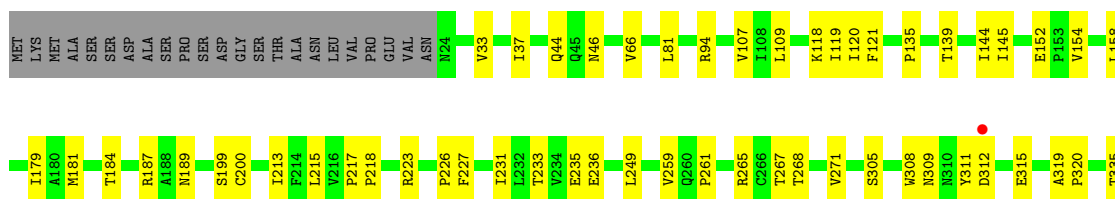
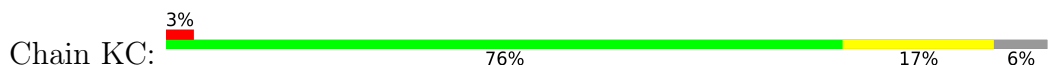

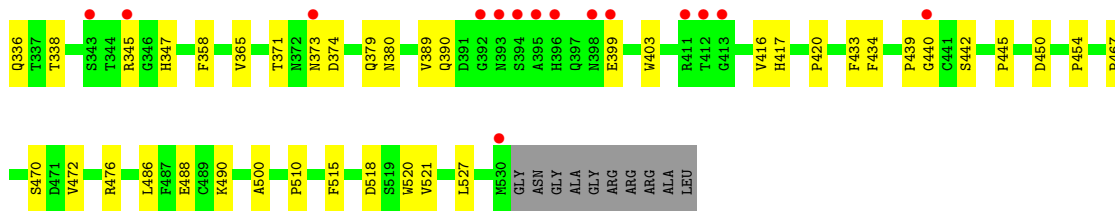

● Molecule 1: Capsid protein VP1

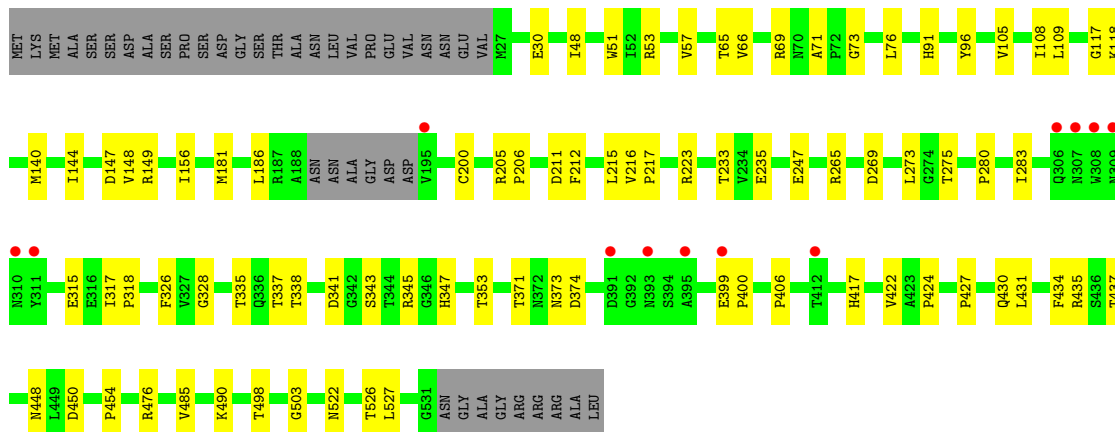
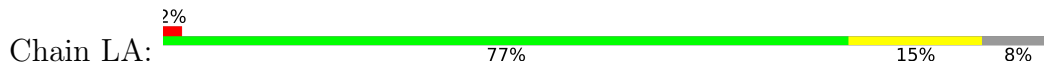

● Molecule 1: Capsid protein VP1

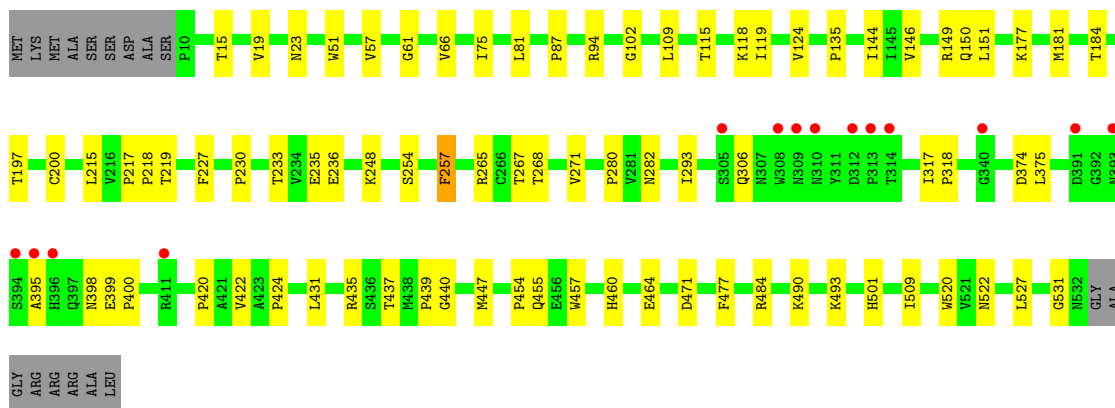
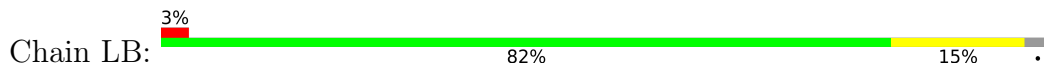

● Molecule 1: Capsid protein VP1

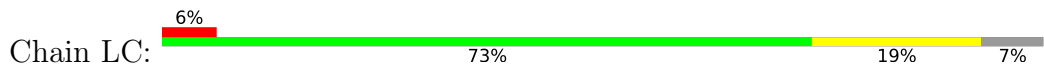

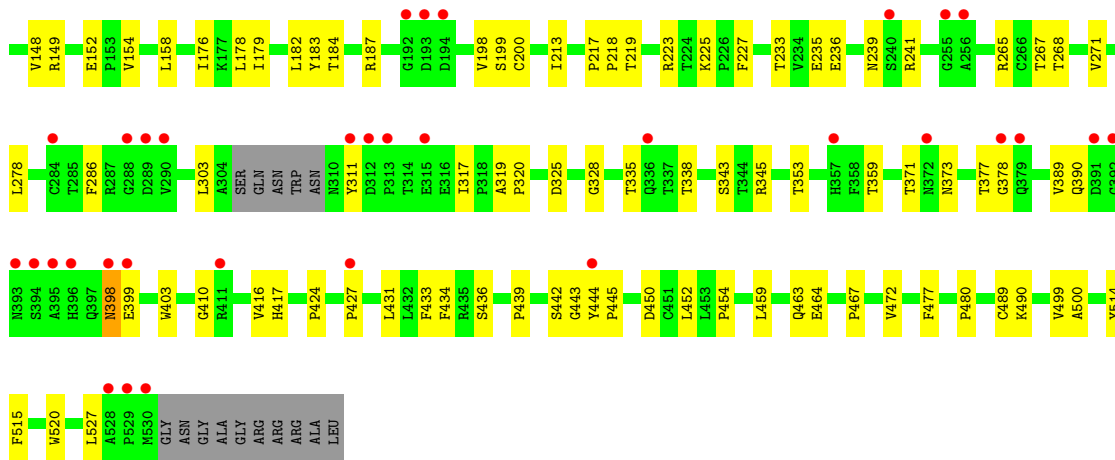

● Molecule 1: Capsid protein VP1

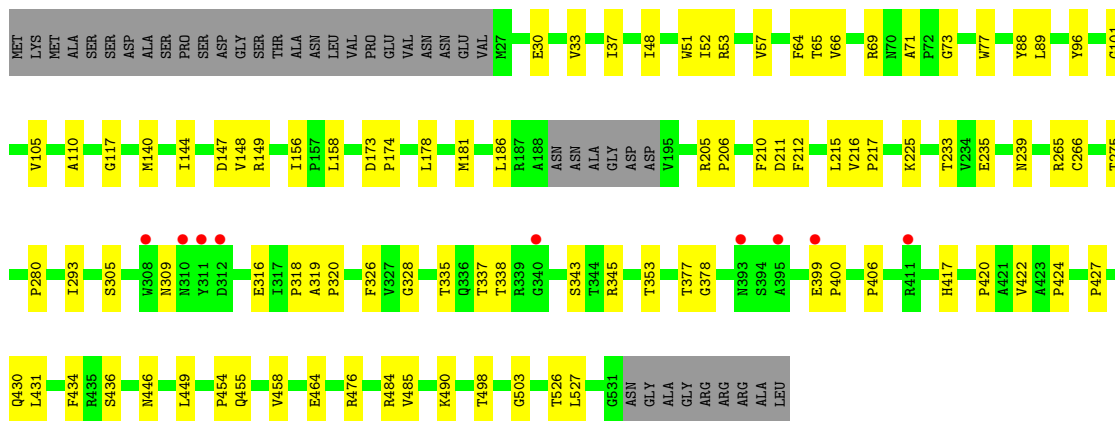
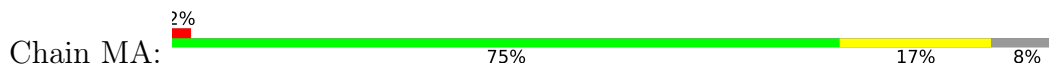

● Molecule 1: Capsid protein VP1

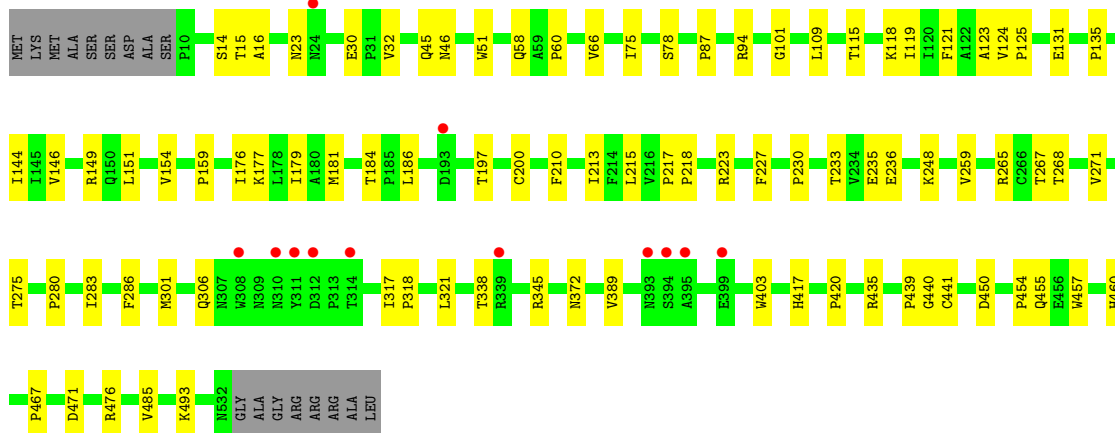
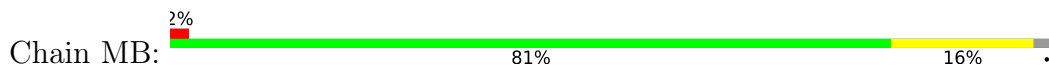

● Molecule 1: Capsid protein VP1

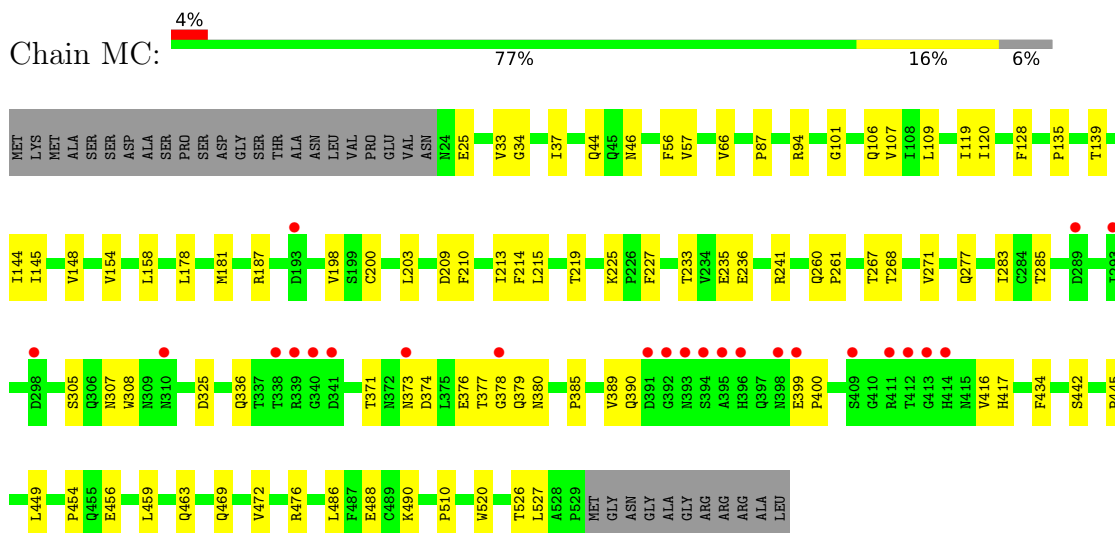

• Molecule 1: Capsid protein VP1

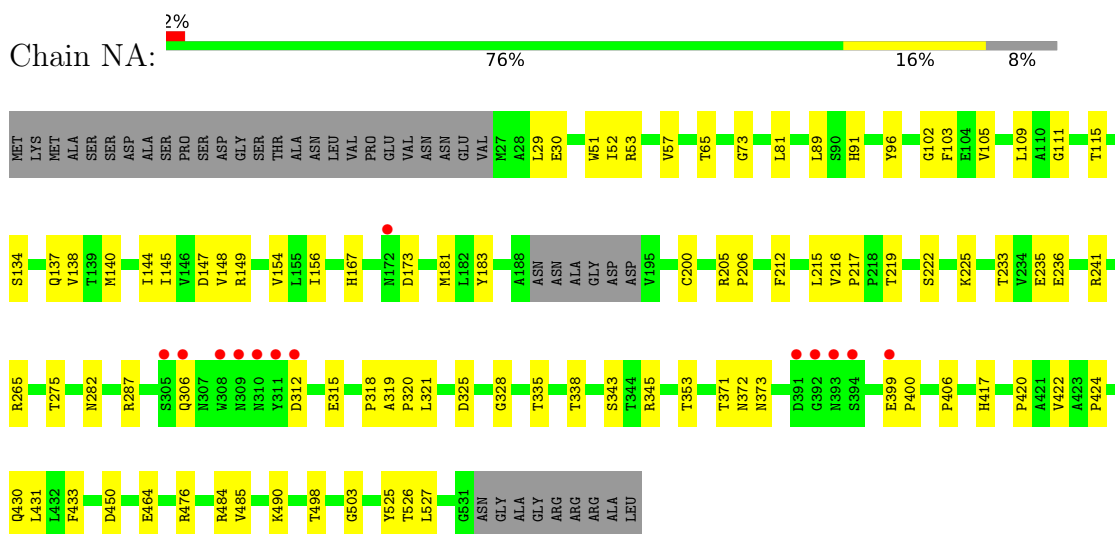

• Molecule 1: Capsid protein VP1

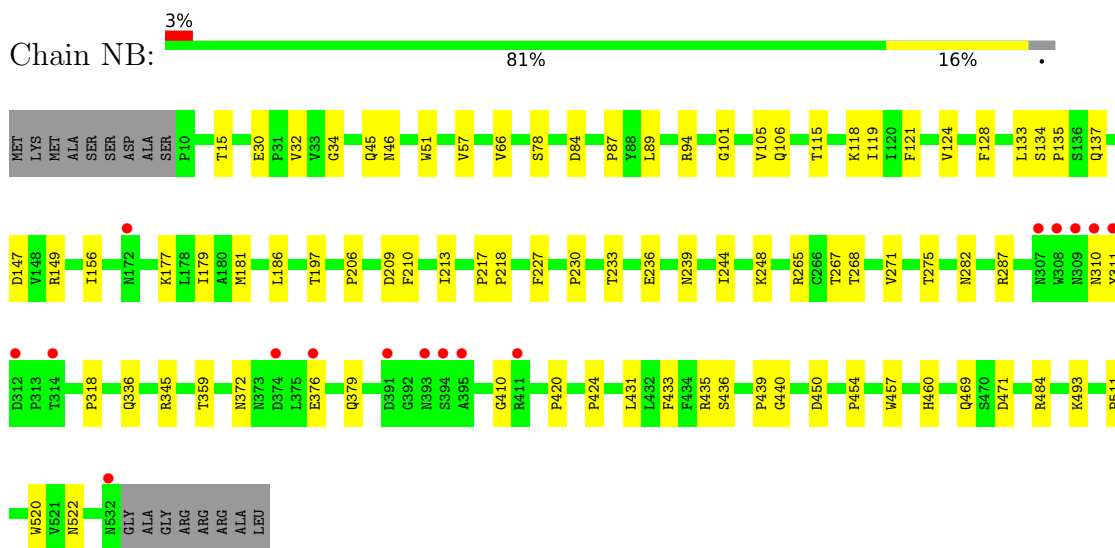

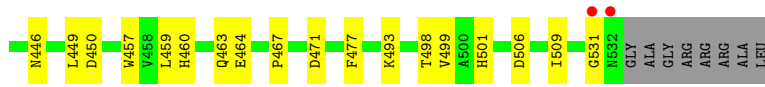

● Molecule 1: Capsid protein VP1

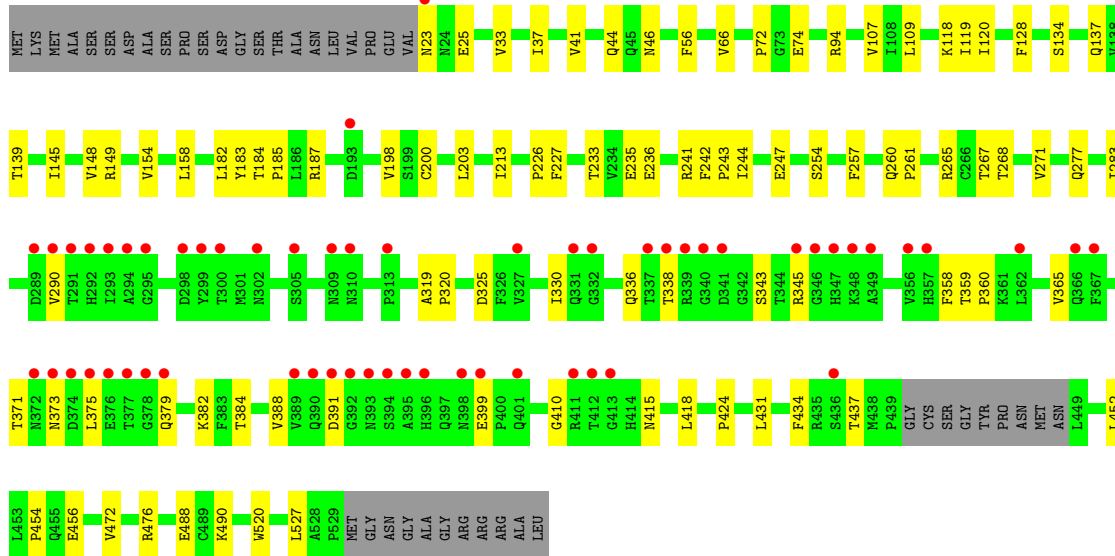
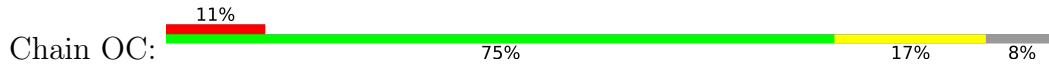

4 Data and refinement statistics i

Property	Value	Source
Space group	I 2 2 2	Depositor
Cell constants a, b, c, α , β , γ	420.17Å 446.60Å 463.95Å 90.00° 90.00° 90.00°	Depositor
Resolution (Å)	30.00 – 3.00 30.00 – 3.00	Depositor EDS
% Data completeness (in resolution range)	95.8 (30.00-3.00) 95.7 (30.00-3.00)	Depositor EDS
R_{merge}	0.14	Depositor
R_{sym}	(Not available)	Depositor
$\langle I/\sigma(I) \rangle$ ¹	1.79 (at 3.00Å)	Xtrriage
Refinement program	PHENIX 1.16_3549	Depositor
R, R_{free}	0.207 , 0.242 0.207 , 0.242	Depositor DCC
R_{free} test set	40708 reflections (4.97%)	wwPDB-VP
Wilson B-factor (Å ²)	68.0	Xtrriage
Anisotropy	0.109	Xtrriage
Bulk solvent k_{sol} (e/Å ³), B_{sol} (Å ²)	0.30 , 42.8	EDS
L-test for twinning ²	$\langle L \rangle = 0.53$, $\langle L^2 \rangle = 0.36$	Xtrriage
Estimated twinning fraction	0.000 for -h,-l,-k	Xtrriage
F_o, F_c correlation	0.93	EDS
Total number of atoms	176522	wwPDB-VP
Average B, all atoms (Å ²)	67.0	wwPDB-VP

Xtrriage's analysis on translational NCS is as follows: *The largest off-origin peak in the Patterson function is 1.48% of the height of the origin peak. No significant pseudotranslation is detected.*

¹Intensities estimated from amplitudes.

²Theoretical values of $\langle |L| \rangle$, $\langle L^2 \rangle$ for acentric reflections are 0.5, 0.333 respectively for untwinned datasets, and 0.375, 0.2 for perfectly twinned datasets.

5 Model quality i

5.1 Standard geometry i

Bond lengths and bond angles in the following residue types are not validated in this section: CL, EDO, CD

The Z score for a bond length (or angle) is the number of standard deviations the observed value is removed from the expected value. A bond length (or angle) with $|Z| > 5$ is considered an outlier worth inspection. RMSZ is the root-mean-square of all Z scores of the bond lengths (or angles).

Mol	Chain	Bond lengths		Bond angles	
		RMSZ	# Z >5	RMSZ	# Z >5
1	AA	0.27	0/3978	0.50	0/5458
1	AB	0.27	0/4134	0.50	0/5677
1	AC	0.27	0/4040	0.51	0/5545
1	BA	0.27	0/3971	0.49	0/5448
1	BB	0.27	0/4140	0.52	0/5684
1	BC	0.27	0/4032	0.51	0/5534
1	CA	0.27	0/3971	0.50	1/5448 (0.0%)
1	CB	0.28	0/4134	0.52	0/5677
1	CC	0.27	0/4032	0.51	0/5534
1	DA	0.27	0/3963	0.50	0/5438
1	DB	0.28	0/4134	0.52	0/5677
1	DC	0.27	0/4025	0.52	1/5525 (0.0%)
1	EA	0.27	0/3971	0.51	0/5448
1	EB	0.28	0/4134	0.51	0/5677
1	EC	0.27	0/3929	0.51	0/5392
1	FA	0.27	0/3971	0.49	0/5448
1	FB	0.27	0/4140	0.52	0/5684
1	FC	0.27	0/4047	0.52	0/5555
1	GA	0.27	0/3971	0.49	0/5448
1	GB	0.27	0/4137	0.52	0/5680
1	GC	0.27	0/4032	0.51	0/5534
1	HA	0.27	0/3971	0.50	0/5448
1	HB	0.27	0/4136	0.52	0/5679
1	HC	0.27	0/4032	0.51	0/5534
1	IA	0.27	0/3971	0.49	0/5448
1	IB	0.28	0/4140	0.52	0/5683
1	IC	0.27	0/4003	0.51	1/5493 (0.0%)
1	JA	0.27	0/3971	0.49	0/5448
1	JB	0.27	0/4128	0.51	0/5669
1	JC	0.26	0/4025	0.50	0/5525
1	KA	0.27	0/3971	0.49	0/5448
1	KB	0.27	0/4130	0.50	0/5672

Mol	Chain	Bond lengths		Bond angles	
		RMSZ	# Z >5	RMSZ	# Z >5
1	KC	0.26	0/4032	0.51	0/5534
1	LA	0.27	0/3971	0.50	0/5448
1	LB	0.27	0/4124	0.51	0/5664
1	LC	0.27	0/3981	0.51	1/5462 (0.0%)
1	MA	0.27	0/3971	0.49	0/5448
1	MB	0.36	1/4131 (0.0%)	0.52	0/5673
1	MC	0.27	0/4025	0.51	0/5525
1	NA	0.27	0/3971	0.49	0/5448
1	NB	0.27	0/4138	0.51	0/5680
1	NC	0.27	0/4018	0.51	0/5516
1	OA	0.27	0/3971	0.50	0/5448
1	OB	0.28	0/4138	0.52	0/5680
1	OC	0.27	0/3967	0.50	0/5445
All	All	0.27	1/181802 (0.0%)	0.51	4/249529 (0.0%)

All (1) bond length outliers are listed below:

Mol	Chain	Res	Type	Atoms	Z	Observed(Å)	Ideal(Å)
1	MB	217	PRO	N-CD	-15.17	1.26	1.47

All (4) bond angle outliers are listed below:

Mol	Chain	Res	Type	Atoms	Z	Observed(°)	Ideal(°)
1	DC	109	LEU	CA-CB-CG	5.13	127.10	115.30
1	IC	109	LEU	CA-CB-CG	5.09	127.02	115.30
1	CA	173	ASP	CB-CG-OD1	5.06	122.86	118.30
1	LC	109	LEU	CA-CB-CG	5.06	126.93	115.30

There are no chirality outliers.

There are no planarity outliers.

5.2 Too-close contacts [i](#)

In the following table, the Non-H and H(model) columns list the number of non-hydrogen atoms and hydrogen atoms in the chain respectively. The H(added) column lists the number of hydrogen atoms added and optimized by MolProbity. The Clashes column lists the number of clashes within the asymmetric unit, whereas Symm-Clashes lists symmetry-related clashes.

Mol	Chain	Non-H	H(model)	H(added)	Clashes	Symm-Clashes
1	AA	3860	0	3758	61	0

Continued on next page...

Continued from previous page...

Mol	Chain	Non-H	H(model)	H(added)	Clashes	Symm-Clashes
1	AB	4013	0	3874	62	0
1	AC	3921	0	3802	63	0
1	BA	3853	0	3749	60	0
1	BB	4019	0	3885	66	0
1	BC	3913	0	3796	68	0
1	CA	3853	0	3749	76	0
1	CB	4013	0	3874	63	0
1	CC	3913	0	3796	55	0
1	DA	3845	0	3740	82	0
1	DB	4013	0	3874	74	0
1	DC	3906	0	3787	67	0
1	EA	3853	0	3749	62	0
1	EB	4013	0	3874	63	0
1	EC	3814	0	3705	76	0
1	FA	3853	0	3749	81	0
1	FB	4019	0	3885	74	0
1	FC	3928	0	3811	67	0
1	GA	3853	0	3749	70	0
1	GB	4016	0	3883	72	0
1	GC	3913	0	3796	66	0
1	HA	3853	0	3749	64	0
1	HB	4015	0	3881	63	0
1	HC	3913	0	3796	57	0
1	IA	3853	0	3749	55	0
1	IB	4019	0	3892	71	0
1	IC	3885	0	3771	63	0
1	JA	3853	0	3749	68	0
1	JB	4007	0	3870	60	0
1	JC	3906	0	3787	72	0
1	KA	3853	0	3749	69	0
1	KB	4009	0	3870	69	0
1	KC	3913	0	3796	61	0
1	LA	3853	0	3749	64	0
1	LB	4003	0	3866	56	0
1	LC	3865	0	3758	79	0
1	MA	3853	0	3749	72	0
1	MB	4010	0	3872	68	0
1	MC	3906	0	3787	61	0
1	NA	3853	0	3749	67	0
1	NB	4017	0	3892	57	0
1	NC	3899	0	3781	62	0
1	OA	3853	0	3749	64	0

Continued on next page...

Continued from previous page...

Mol	Chain	Non-H	H(model)	H(added)	Clashes	Symm-Clashes
1	OB	4017	0	3892	71	0
1	OC	3851	0	3739	62	0
2	AA	3	0	0	0	0
2	AB	1	0	0	0	0
2	AC	1	0	0	0	0
2	BA	2	0	0	0	0
2	BC	1	0	0	0	0
2	CA	2	0	0	0	0
2	CC	3	0	0	1	0
2	DA	1	0	0	0	0
2	DB	1	0	0	0	0
2	DC	2	0	0	0	0
2	EA	3	0	0	0	0
2	FA	2	0	0	0	0
2	GA	1	0	0	0	0
2	GC	2	0	0	0	0
2	HA	1	0	0	0	0
2	HC	1	0	0	0	0
2	IA	3	0	0	0	0
2	JA	3	0	0	0	0
2	KA	2	0	0	0	0
2	KC	2	0	0	0	0
2	LA	1	0	0	0	0
2	LC	2	0	0	0	0
2	MA	3	0	0	0	0
2	MC	2	0	0	1	0
2	NA	2	0	0	0	0
2	NC	1	0	0	0	0
2	OA	2	0	0	0	0
3	AC	1	0	0	0	0
3	BA	1	0	0	0	0
3	BC	1	0	0	0	0
3	CA	1	0	0	0	0
3	DA	1	0	0	0	0
3	EA	1	0	0	0	0
3	EB	1	0	0	0	0
3	EC	1	0	0	0	0
3	FA	1	0	0	0	0
3	FC	1	0	0	0	0
3	GA	1	0	0	0	0
3	GB	1	0	0	0	0
3	HC	1	0	0	0	0

Continued on next page...

Continued from previous page...

Mol	Chain	Non-H	H(model)	H(added)	Clashes	Symm-Clashes
3	IA	1	0	0	0	0
3	JA	1	0	0	0	0
3	JC	1	0	0	0	0
3	KA	1	0	0	0	0
3	KB	1	0	0	0	0
3	MA	1	0	0	0	0
3	MB	1	0	0	0	0
3	NC	1	0	0	0	0
3	OA	1	0	0	0	0
4	JA	4	0	6	0	0
5	HC	1	0	0	0	0
5	OA	1	0	0	0	0
5	OB	1	0	0	0	0
All	All	176522	0	171133	2696	0

The all-atom clashscore is defined as the number of clashes found per 1000 atoms (including hydrogen atoms). The all-atom clashscore for this structure is 8.

The worst 5 of 2696 close contacts within the same asymmetric unit are listed below, sorted by their clash magnitude.

Atom-1	Atom-2	Interatomic distance (Å)	Clash overlap (Å)
1:NA:65:THR:HG21	1:NA:526:THR:H	1.25	1.01
1:GA:65:THR:HG21	1:GA:526:THR:H	1.25	1.01
1:AA:65:THR:HG21	1:AA:526:THR:H	1.23	1.00
1:MA:65:THR:HG21	1:MA:526:THR:H	1.28	0.98
1:CA:65:THR:HG21	1:CA:526:THR:H	1.30	0.96

There are no symmetry-related clashes.

5.3 Torsion angles [i](#)

5.3.1 Protein backbone [i](#)

In the following table, the Percentiles column shows the percent Ramachandran outliers of the chain as a percentile score with respect to all X-ray entries followed by that with respect to entries of similar resolution.

The Analysed column shows the number of residues for which the backbone conformation was analysed, and the total number of residues.

Mol	Chain	Analysed	Favoured	Allowed	Outliers	Percentiles	
1	AA	496/540 (92%)	482 (97%)	14 (3%)	0	100	100
1	AB	521/540 (96%)	505 (97%)	16 (3%)	0	100	100
1	AC	506/540 (94%)	489 (97%)	17 (3%)	0	100	100
1	BA	495/540 (92%)	480 (97%)	15 (3%)	0	100	100
1	BB	521/540 (96%)	502 (96%)	19 (4%)	0	100	100
1	BC	505/540 (94%)	488 (97%)	17 (3%)	0	100	100
1	CA	495/540 (92%)	481 (97%)	14 (3%)	0	100	100
1	CB	521/540 (96%)	501 (96%)	20 (4%)	0	100	100
1	CC	505/540 (94%)	488 (97%)	17 (3%)	0	100	100
1	DA	494/540 (92%)	480 (97%)	14 (3%)	0	100	100
1	DB	521/540 (96%)	501 (96%)	20 (4%)	0	100	100
1	DC	504/540 (93%)	489 (97%)	15 (3%)	0	100	100
1	EA	495/540 (92%)	484 (98%)	11 (2%)	0	100	100
1	EB	521/540 (96%)	505 (97%)	16 (3%)	0	100	100
1	EC	489/540 (91%)	475 (97%)	14 (3%)	0	100	100
1	FA	495/540 (92%)	473 (96%)	22 (4%)	0	100	100
1	FB	521/540 (96%)	502 (96%)	19 (4%)	0	100	100
1	FC	507/540 (94%)	491 (97%)	16 (3%)	0	100	100
1	GA	495/540 (92%)	478 (97%)	17 (3%)	0	100	100
1	GB	521/540 (96%)	500 (96%)	21 (4%)	0	100	100
1	GC	505/540 (94%)	488 (97%)	17 (3%)	0	100	100
1	HA	495/540 (92%)	481 (97%)	14 (3%)	0	100	100
1	HB	521/540 (96%)	499 (96%)	22 (4%)	0	100	100
1	HC	505/540 (94%)	491 (97%)	14 (3%)	0	100	100
1	IA	495/540 (92%)	481 (97%)	14 (3%)	0	100	100
1	IB	521/540 (96%)	497 (95%)	24 (5%)	0	100	100
1	IC	499/540 (92%)	485 (97%)	14 (3%)	0	100	100
1	JA	495/540 (92%)	479 (97%)	16 (3%)	0	100	100
1	JB	521/540 (96%)	501 (96%)	20 (4%)	0	100	100
1	JC	504/540 (93%)	487 (97%)	17 (3%)	0	100	100
1	KA	495/540 (92%)	479 (97%)	16 (3%)	0	100	100
1	KB	521/540 (96%)	505 (97%)	16 (3%)	0	100	100

Continued on next page...

Continued from previous page...

Mol	Chain	Analysed	Favoured	Allowed	Outliers	Percentiles	
1	KC	505/540 (94%)	491 (97%)	14 (3%)	0	100	100
1	LA	495/540 (92%)	477 (96%)	18 (4%)	0	100	100
1	LB	521/540 (96%)	503 (96%)	18 (4%)	0	100	100
1	LC	498/540 (92%)	480 (96%)	18 (4%)	0	100	100
1	MA	495/540 (92%)	483 (98%)	12 (2%)	0	100	100
1	MB	521/540 (96%)	506 (97%)	15 (3%)	0	100	100
1	MC	504/540 (93%)	490 (97%)	14 (3%)	0	100	100
1	NA	495/540 (92%)	480 (97%)	15 (3%)	0	100	100
1	NB	521/540 (96%)	505 (97%)	16 (3%)	0	100	100
1	NC	504/540 (93%)	486 (96%)	18 (4%)	0	100	100
1	OA	495/540 (92%)	482 (97%)	13 (3%)	0	100	100
1	OB	521/540 (96%)	502 (96%)	19 (4%)	0	100	100
1	OC	494/540 (92%)	476 (96%)	18 (4%)	0	100	100
All	All	22774/24300 (94%)	22028 (97%)	746 (3%)	0	100	100

There are no Ramachandran outliers to report.

5.3.2 Protein sidechains [i](#)

In the following table, the Percentiles column shows the percent sidechain outliers of the chain as a percentile score with respect to all X-ray entries followed by that with respect to entries of similar resolution.

The Analysed column shows the number of residues for which the sidechain conformation was analysed, and the total number of residues.

Mol	Chain	Analysed	Rotameric	Outliers	Percentiles	
1	AA	427/457 (93%)	427 (100%)	0	100	100
1	AB	444/457 (97%)	444 (100%)	0	100	100
1	AC	434/457 (95%)	434 (100%)	0	100	100
1	BA	426/457 (93%)	426 (100%)	0	100	100
1	BB	445/457 (97%)	445 (100%)	0	100	100
1	BC	433/457 (95%)	433 (100%)	0	100	100
1	CA	426/457 (93%)	426 (100%)	0	100	100
1	CB	444/457 (97%)	444 (100%)	0	100	100

Continued on next page...

Continued from previous page...

Mol	Chain	Analysed	Rotameric	Outliers	Percentiles	
1	CC	433/457 (95%)	432 (100%)	1 (0%)	93	98
1	DA	425/457 (93%)	425 (100%)	0	100	100
1	DB	444/457 (97%)	444 (100%)	0	100	100
1	DC	432/457 (94%)	432 (100%)	0	100	100
1	EA	426/457 (93%)	426 (100%)	0	100	100
1	EB	444/457 (97%)	444 (100%)	0	100	100
1	EC	421/457 (92%)	421 (100%)	0	100	100
1	FA	426/457 (93%)	426 (100%)	0	100	100
1	FB	445/457 (97%)	445 (100%)	0	100	100
1	FC	435/457 (95%)	435 (100%)	0	100	100
1	GA	426/457 (93%)	426 (100%)	0	100	100
1	GB	444/457 (97%)	444 (100%)	0	100	100
1	GC	433/457 (95%)	433 (100%)	0	100	100
1	HA	426/457 (93%)	426 (100%)	0	100	100
1	HB	444/457 (97%)	444 (100%)	0	100	100
1	HC	433/457 (95%)	433 (100%)	0	100	100
1	IA	426/457 (93%)	426 (100%)	0	100	100
1	IB	445/457 (97%)	444 (100%)	1 (0%)	93	98
1	IC	430/457 (94%)	430 (100%)	0	100	100
1	JA	426/457 (93%)	426 (100%)	0	100	100
1	JB	442/457 (97%)	442 (100%)	0	100	100
1	JC	432/457 (94%)	432 (100%)	0	100	100
1	KA	426/457 (93%)	426 (100%)	0	100	100
1	KB	443/457 (97%)	443 (100%)	0	100	100
1	KC	433/457 (95%)	433 (100%)	0	100	100
1	LA	426/457 (93%)	426 (100%)	0	100	100
1	LB	441/457 (96%)	440 (100%)	1 (0%)	93	98
1	LC	427/457 (93%)	426 (100%)	1 (0%)	93	98
1	MA	426/457 (93%)	426 (100%)	0	100	100
1	MB	443/457 (97%)	443 (100%)	0	100	100
1	MC	432/457 (94%)	432 (100%)	0	100	100

Continued on next page...

Continued from previous page...

Mol	Chain	Analysed	Rotameric	Outliers	Percentiles	
1	NA	426/457 (93%)	426 (100%)	0	100	100
1	NB	444/457 (97%)	444 (100%)	0	100	100
1	NC	430/457 (94%)	430 (100%)	0	100	100
1	OA	426/457 (93%)	425 (100%)	1 (0%)	93	98
1	OB	444/457 (97%)	444 (100%)	0	100	100
1	OC	426/457 (93%)	426 (100%)	0	100	100
All	All	19510/20565 (95%)	19505 (100%)	5 (0%)	100	100

All (5) residues with a non-rotameric sidechain are listed below:

Mol	Chain	Res	Type
1	CC	97	ASN
1	IB	411	ARG
1	LB	257	PHE
1	LC	398	ASN
1	OA	187	ARG

Sometimes sidechains can be flipped to improve hydrogen bonding and reduce clashes. 5 of 21 such sidechains are listed below:

Mol	Chain	Res	Type
1	JC	44	GLN
1	MC	44	GLN
1	OC	336	GLN
1	NC	44	GLN
1	MB	309	ASN

5.3.3 RNA [i](#)

There are no RNA molecules in this entry.

5.4 Non-standard residues in protein, DNA, RNA chains [i](#)

There are no non-standard protein/DNA/RNA residues in this entry.

5.5 Carbohydrates [i](#)

There are no monosaccharides in this entry.

5.6 Ligand geometry [i](#)

Of 73 ligands modelled in this entry, 72 are monoatomic - leaving 1 for Mogul analysis.

In the following table, the Counts columns list the number of bonds (or angles) for which Mogul statistics could be retrieved, the number of bonds (or angles) that are observed in the model and the number of bonds (or angles) that are defined in the Chemical Component Dictionary. The Link column lists molecule types, if any, to which the group is linked. The Z score for a bond length (or angle) is the number of standard deviations the observed value is removed from the expected value. A bond length (or angle) with $|Z| > 2$ is considered an outlier worth inspection. RMSZ is the root-mean-square of all Z scores of the bond lengths (or angles).

Mol	Type	Chain	Res	Link	Bond lengths			Bond angles		
					Counts	RMSZ	# Z > 2	Counts	RMSZ	# Z > 2
4	EDO	JA	601	-	3,3,3	0.49	0	2,2,2	0.29	0

In the following table, the Chirals column lists the number of chiral outliers, the number of chiral centers analysed, the number of these observed in the model and the number defined in the Chemical Component Dictionary. Similar counts are reported in the Torsion and Rings columns. '-' means no outliers of that kind were identified.

Mol	Type	Chain	Res	Link	Chirals	Torsions	Rings
4	EDO	JA	601	-	-	0/1/1/1	-

There are no bond length outliers.

There are no bond angle outliers.

There are no chirality outliers.

There are no torsion outliers.

There are no ring outliers.

No monomer is involved in short contacts.

5.7 Other polymers [i](#)

There are no such residues in this entry.

5.8 Polymer linkage issues [i](#)

There are no chain breaks in this entry.

6 Fit of model and data i

6.1 Protein, DNA and RNA chains i

In the following table, the column labelled ‘#RSRZ > 2’ contains the number (and percentage) of RSRZ outliers, followed by percent RSRZ outliers for the chain as percentile scores relative to all X-ray entries and entries of similar resolution. The OWAB column contains the minimum, median, 95th percentile and maximum values of the occupancy-weighted average B-factor per residue. The column labelled ‘Q < 0.9’ lists the number of (and percentage) of residues with an average occupancy less than 0.9.

Mol	Chain	Analysed	<RSRZ>	#RSRZ>2	OWAB(Å ²)	Q<0.9
1	AA	500/540 (92%)	-0.44	8 (1%) 72 44	34, 56, 104, 132	0
1	AB	523/540 (96%)	-0.45	10 (1%) 66 37	34, 58, 105, 138	0
1	AC	508/540 (94%)	-0.43	11 (2%) 62 33	33, 58, 104, 143	0
1	BA	499/540 (92%)	-0.38	15 (3%) 50 22	35, 56, 110, 140	0
1	BB	523/540 (96%)	-0.38	12 (2%) 60 31	33, 57, 107, 140	0
1	BC	507/540 (93%)	-0.17	25 (4%) 29 11	32, 68, 131, 159	0
1	CA	499/540 (92%)	-0.43	4 (0%) 86 65	36, 57, 105, 131	0
1	CB	523/540 (96%)	-0.43	15 (2%) 51 23	33, 57, 106, 141	0
1	CC	507/540 (93%)	-0.43	7 (1%) 75 49	33, 59, 105, 152	0
1	DA	498/540 (92%)	-0.36	13 (2%) 56 27	36, 57, 107, 152	0
1	DB	523/540 (96%)	-0.38	14 (2%) 54 26	35, 58, 115, 148	0
1	DC	506/540 (93%)	-0.20	19 (3%) 40 16	35, 69, 130, 168	0
1	EA	499/540 (92%)	-0.35	8 (1%) 72 44	35, 58, 113, 139	0
1	EB	523/540 (96%)	-0.43	11 (2%) 63 34	34, 56, 109, 148	0
1	EC	493/540 (91%)	0.16	58 (11%) 4 1	34, 81, 168, 194	0
1	FA	499/540 (92%)	-0.39	10 (2%) 65 36	36, 59, 111, 137	0
1	FB	523/540 (96%)	-0.46	13 (2%) 57 29	32, 54, 101, 132	0
1	FC	509/540 (94%)	-0.17	27 (5%) 26 10	34, 74, 127, 175	0
1	GA	499/540 (92%)	-0.43	13 (2%) 56 27	36, 53, 103, 138	0
1	GB	523/540 (96%)	-0.37	12 (2%) 60 31	34, 55, 110, 139	0
1	GC	507/540 (93%)	-0.35	15 (2%) 50 22	34, 59, 109, 148	0
1	HA	499/540 (92%)	-0.39	10 (2%) 65 36	36, 57, 109, 138	0
1	HB	523/540 (96%)	-0.43	7 (1%) 77 51	35, 55, 101, 145	0
1	HC	507/540 (93%)	-0.24	18 (3%) 42 17	33, 67, 124, 157	0

Continued on next page...

Continued from previous page...

Mol	Chain	Analysed	<RSRZ>	#RSRZ>2	OWAB(Å ²)	Q<0.9
1	IA	499/540 (92%)	-0.38	13 (2%) 56 27	35, 55, 104, 144	0
1	IB	523/540 (96%)	-0.35	16 (3%) 49 21	34, 58, 119, 149	0
1	IC	503/540 (93%)	0.07	44 (8%) 10 3	34, 81, 142, 174	0
1	JA	499/540 (92%)	-0.38	9 (1%) 68 40	35, 59, 117, 156	0
1	JB	523/540 (96%)	-0.39	10 (1%) 66 37	36, 58, 113, 145	0
1	JC	506/540 (93%)	0.21	61 (12%) 4 1	34, 85, 178, 204	0
1	KA	499/540 (92%)	-0.32	11 (2%) 62 33	36, 59, 111, 137	0
1	KB	523/540 (96%)	-0.42	14 (2%) 54 26	35, 55, 106, 144	0
1	KC	507/540 (93%)	-0.24	16 (3%) 47 20	34, 67, 123, 145	0
1	LA	499/540 (92%)	-0.38	12 (2%) 59 30	36, 56, 102, 151	0
1	LB	523/540 (96%)	-0.36	14 (2%) 54 26	31, 58, 118, 142	0
1	LC	502/540 (92%)	-0.03	33 (6%) 18 5	35, 81, 137, 167	0
1	MA	499/540 (92%)	-0.38	9 (1%) 68 40	34, 59, 111, 143	0
1	MB	523/540 (96%)	-0.46	12 (2%) 60 31	35, 53, 98, 142	0
1	MC	506/540 (93%)	-0.16	24 (4%) 31 11	33, 73, 128, 153	0
1	NA	499/540 (92%)	-0.44	13 (2%) 56 27	35, 53, 103, 144	0
1	NB	523/540 (96%)	-0.35	16 (3%) 49 21	34, 58, 114, 145	0
1	NC	506/540 (93%)	-0.36	12 (2%) 59 30	33, 60, 111, 171	0
1	OA	499/540 (92%)	-0.36	17 (3%) 45 19	35, 59, 116, 141	0
1	OB	523/540 (96%)	-0.35	16 (3%) 49 21	35, 58, 115, 147	0
1	OC	498/540 (92%)	0.21	58 (11%) 4 1	37, 83, 171, 191	0
All	All	22902/24300 (94%)	-0.31	785 (3%) 45 19	31, 59, 123, 204	0

The worst 5 of 785 RSRZ outliers are listed below:

Mol	Chain	Res	Type	RSRZ
1	OC	346	GLY	8.9
1	JC	349	ALA	7.9
1	OC	412	THR	7.9
1	JC	412	THR	6.6
1	NC	393	ASN	6.2

6.2 Non-standard residues in protein, DNA, RNA chains [i](#)

There are no non-standard protein/DNA/RNA residues in this entry.

6.3 Carbohydrates [i](#)

There are no monosaccharides in this entry.

6.4 Ligands [i](#)

In the following table, the Atoms column lists the number of modelled atoms in the group and the number defined in the chemical component dictionary. The B-factors column lists the minimum, median, 95th percentile and maximum values of B factors of atoms in the group. The column labelled 'Q< 0.9' lists the number of atoms with occupancy less than 0.9.

Mol	Type	Chain	Res	Atoms	RSCC	RSR	B-factors(Å ²)	Q<0.9
4	EDO	JA	601	4/4	0.72	0.29	69,69,69,69	0
3	CD	MB	601	1/1	0.79	0.07	140,140,140,140	0
2	CL	AA	603	1/1	0.82	0.16	77,77,77,77	0
3	CD	KA	601	1/1	0.82	0.07	142,142,142,142	0
2	CL	IA	603	1/1	0.85	0.18	78,78,78,78	0
2	CL	CC	603	1/1	0.85	0.09	79,79,79,79	0
2	CL	EA	603	1/1	0.86	0.27	80,80,80,80	0
3	CD	EA	601	1/1	0.88	0.07	144,144,144,144	0
2	CL	CC	602	1/1	0.89	0.15	95,95,95,95	0
3	CD	GB	601	1/1	0.90	0.08	149,149,149,149	0
3	CD	JC	601	1/1	0.90	0.09	176,176,176,176	0
2	CL	AB	601	1/1	0.90	0.21	67,67,67,67	0
2	CL	JA	604	1/1	0.90	0.28	82,82,82,82	0
2	CL	GC	601	1/1	0.90	0.32	63,63,63,63	0
3	CD	JA	602	1/1	0.91	0.06	136,136,136,136	0
2	CL	KC	602	1/1	0.91	0.15	74,74,74,74	0
2	CL	BC	602	1/1	0.91	0.25	55,55,55,55	0
3	CD	EC	601	1/1	0.91	0.17	195,195,195,195	0
2	CL	CC	601	1/1	0.91	0.22	56,56,56,56	0
3	CD	IA	601	1/1	0.92	0.05	135,135,135,135	0
3	CD	KB	601	1/1	0.92	0.07	138,138,138,138	0
3	CD	DA	601	1/1	0.92	0.08	136,136,136,136	0
2	CL	LC	601	1/1	0.92	0.21	59,59,59,59	0
3	CD	BA	601	1/1	0.93	0.07	142,142,142,142	0
3	CD	EB	601	1/1	0.93	0.06	133,133,133,133	0
3	CD	MA	601	1/1	0.93	0.05	138,138,138,138	0
2	CL	DB	601	1/1	0.93	0.11	65,65,65,65	0

Continued on next page...

Continued from previous page...

Mol	Type	Chain	Res	Atoms	RSCC	RSR	B-factors(\AA^2)	Q<0.9
3	CD	FA	601	1/1	0.93	0.05	134,134,134,134	0
2	CL	KA	603	1/1	0.94	0.18	76,76,76,76	0
2	CL	EA	604	1/1	0.94	0.31	46,46,46,46	0
3	CD	NC	601	1/1	0.94	0.08	128,128,128,128	0
2	CL	DC	601	1/1	0.94	0.31	56,56,56,56	0
2	CL	AC	602	1/1	0.95	0.18	76,76,76,76	0
3	CD	GA	601	1/1	0.95	0.06	127,127,127,127	0
3	CD	CA	601	1/1	0.95	0.04	136,136,136,136	0
2	CL	MC	602	1/1	0.95	0.22	58,58,58,58	0
3	CD	BC	601	1/1	0.96	0.07	127,127,127,127	0
3	CD	OA	601	1/1	0.96	0.05	139,139,139,139	0
2	CL	LA	601	1/1	0.96	0.17	49,49,49,49	0
2	CL	MA	604	1/1	0.97	0.26	76,76,76,76	0
2	CL	MC	601	1/1	0.97	0.21	54,54,54,54	0
3	CD	HC	601	1/1	0.97	0.05	127,127,127,127	0
2	CL	AA	602	1/1	0.97	0.29	43,43,43,43	0
2	CL	NC	602	1/1	0.97	0.06	68,68,68,68	0
2	CL	JA	603	1/1	0.97	0.21	51,51,51,51	0
2	CL	BA	602	1/1	0.97	0.21	45,45,45,45	0
2	CL	KA	602	1/1	0.97	0.24	48,48,48,48	0
2	CL	FA	603	1/1	0.97	0.22	47,47,47,47	0
2	CL	DC	602	1/1	0.97	0.30	44,44,44,44	0
2	CL	HA	601	1/1	0.97	0.25	48,48,48,48	0
2	CL	HC	602	1/1	0.97	0.41	45,45,45,45	0
2	CL	LC	602	1/1	0.97	0.25	40,40,40,40	0
2	CL	MA	603	1/1	0.98	0.25	50,50,50,50	0
3	CD	FC	601	1/1	0.98	0.04	127,127,127,127	0
2	CL	DA	602	1/1	0.98	0.26	48,48,48,48	0
2	CL	CA	603	1/1	0.98	0.19	44,44,44,44	0
2	CL	JA	605	1/1	0.98	0.30	44,44,44,44	0
2	CL	GA	602	1/1	0.98	0.27	41,41,41,41	0
2	CL	OA	602	1/1	0.98	0.24	50,50,50,50	0
3	CD	AC	601	1/1	0.98	0.07	121,121,121,121	0
2	CL	BA	603	1/1	0.98	0.34	48,48,48,48	0
2	CL	KC	601	1/1	0.98	0.30	42,42,42,42	0
2	CL	AA	601	1/1	0.98	0.24	49,49,49,49	0
2	CL	EA	602	1/1	0.98	0.19	50,50,50,50	0
2	CL	CA	602	1/1	0.98	0.28	42,42,42,42	0
2	CL	IA	604	1/1	0.98	0.33	41,41,41,41	0
2	CL	MA	602	1/1	0.98	0.32	41,41,41,41	0
2	CL	OA	603	1/1	0.99	0.30	47,47,47,47	0
2	CL	GC	602	1/1	0.99	0.41	46,46,46,46	0

Continued on next page...

Continued from previous page...

Mol	Type	Chain	Res	Atoms	RSCC	RSR	B-factors(\AA^2)	Q<0.9
2	CL	NA	601	1/1	0.99	0.31	37,37,37,37	0
2	CL	NA	602	1/1	0.99	0.25	42,42,42,42	0
2	CL	IA	602	1/1	0.99	0.25	47,47,47,47	0
2	CL	FA	602	1/1	0.99	0.30	42,42,42,42	0

The following is a graphical depiction of the model fit to experimental electron density of all instances of the Ligand of Interest. In addition, ligands with molecular weight > 250 and outliers as shown on the geometry validation Tables will also be included. Each fit is shown from different orientation to approximate a three-dimensional view.

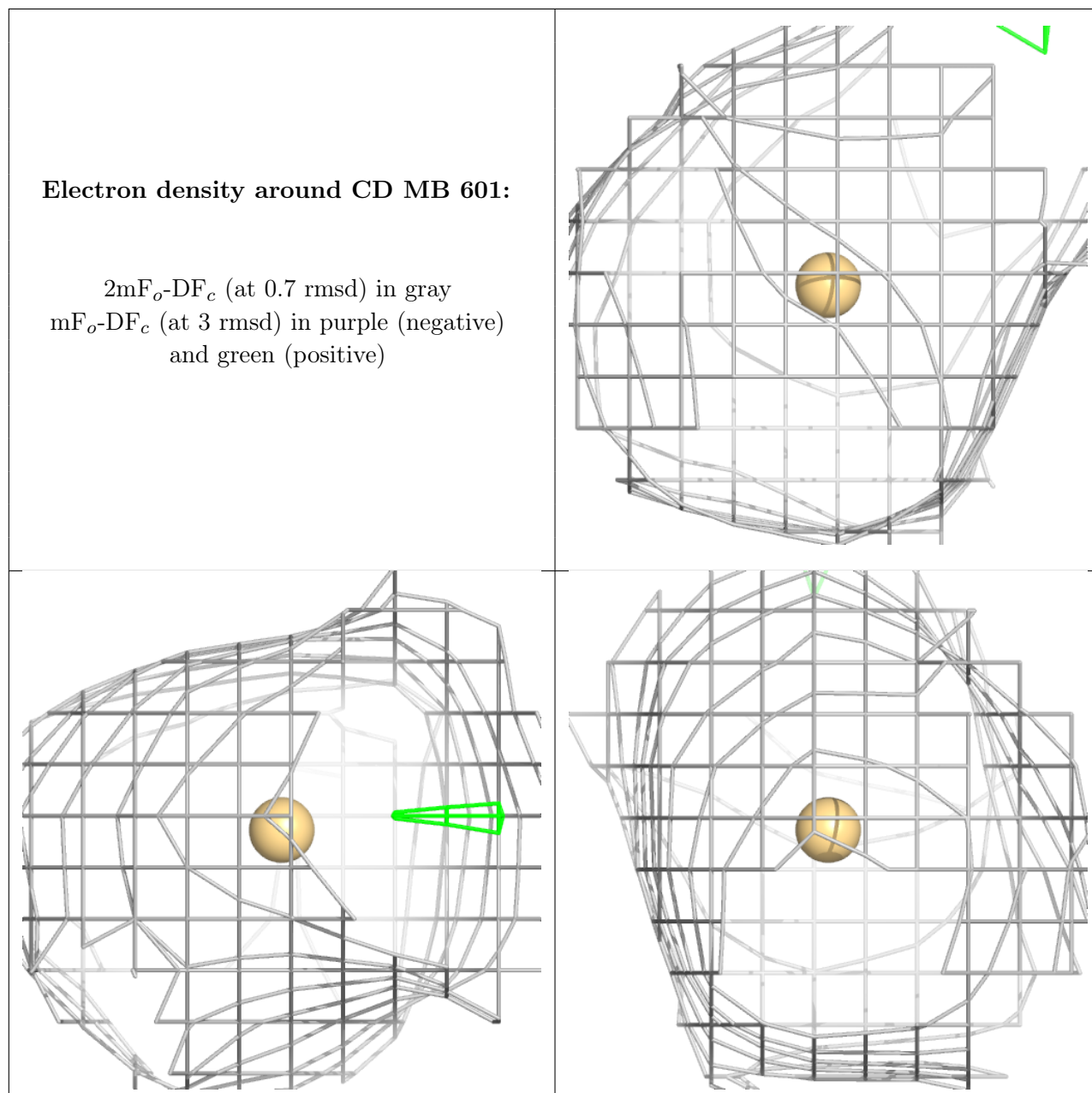

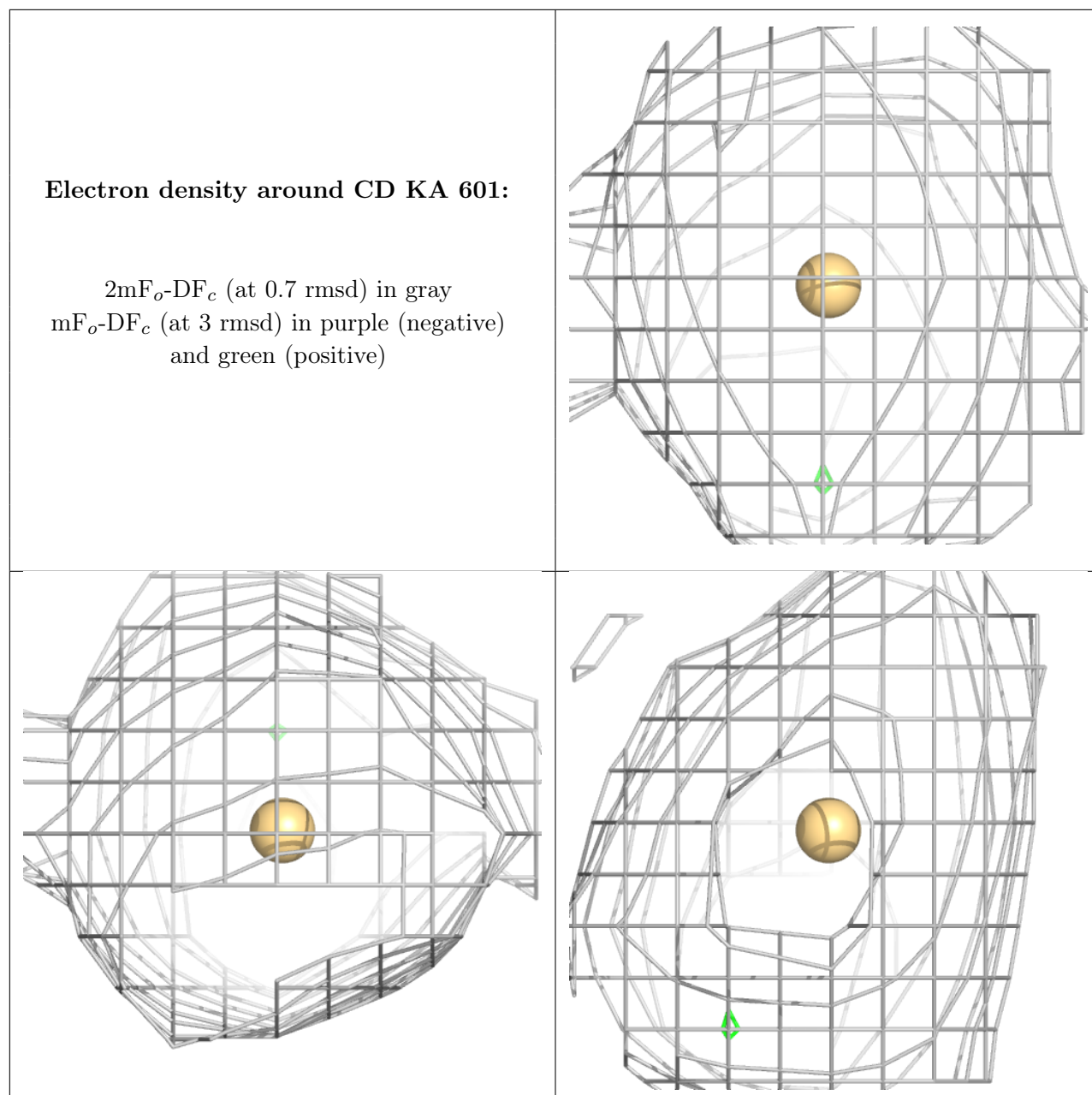

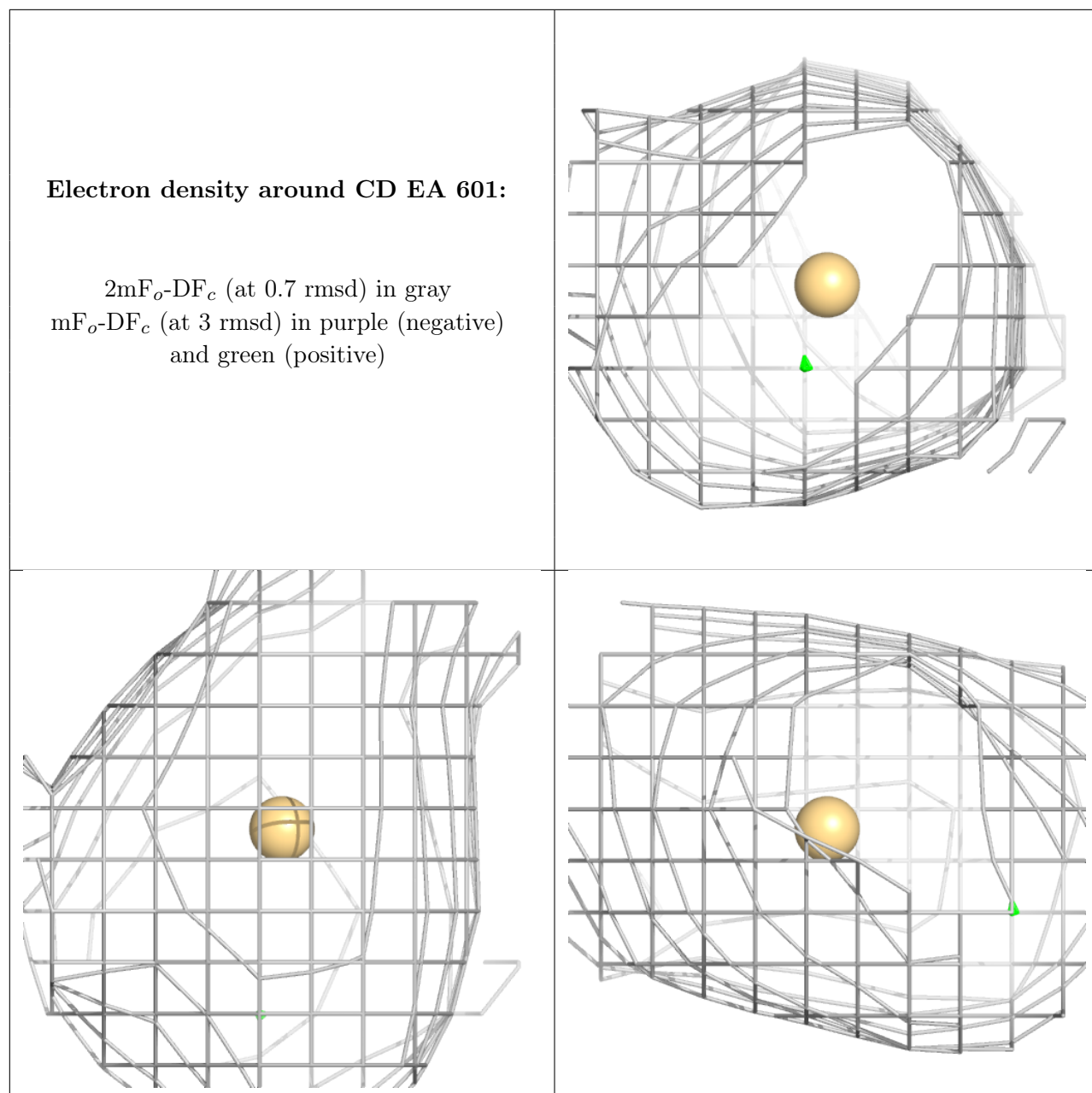

Electron density around CD GB 601:

$2mF_o-DF_c$ (at 0.7 rmsd) in gray
 mF_o-DF_c (at 3 rmsd) in purple (negative)
and green (positive)

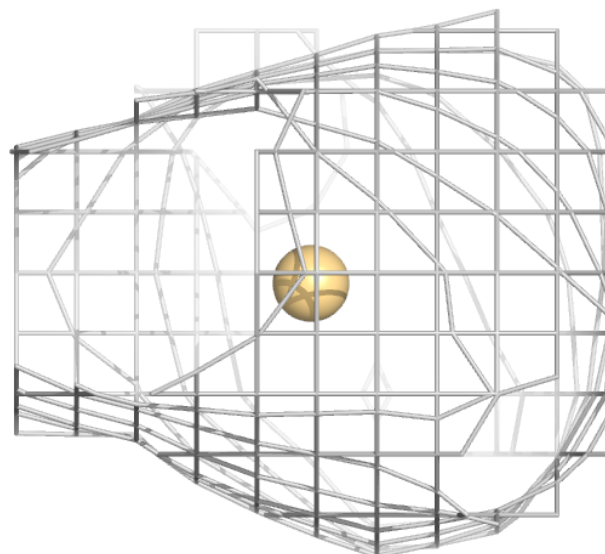
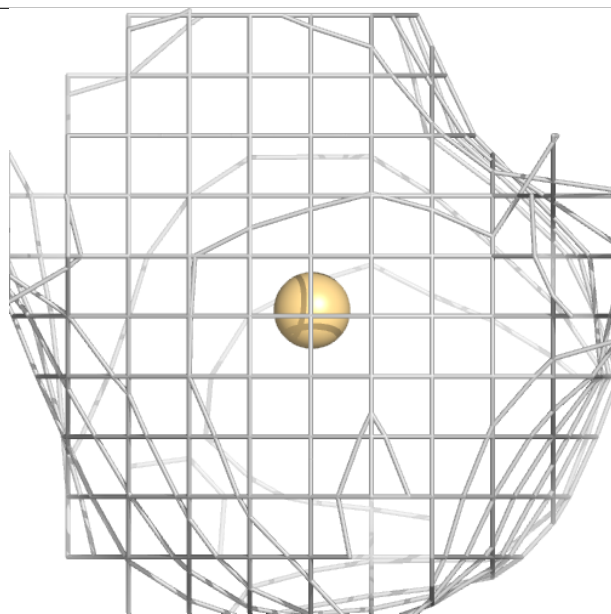
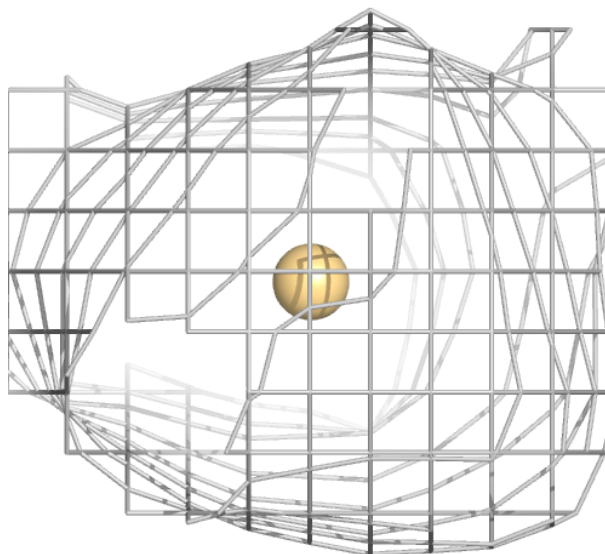

Electron density around CD JC 601:

$2mF_o-DF_c$ (at 0.7 rmsd) in gray
 mF_o-DF_c (at 3 rmsd) in purple (negative)
and green (positive)

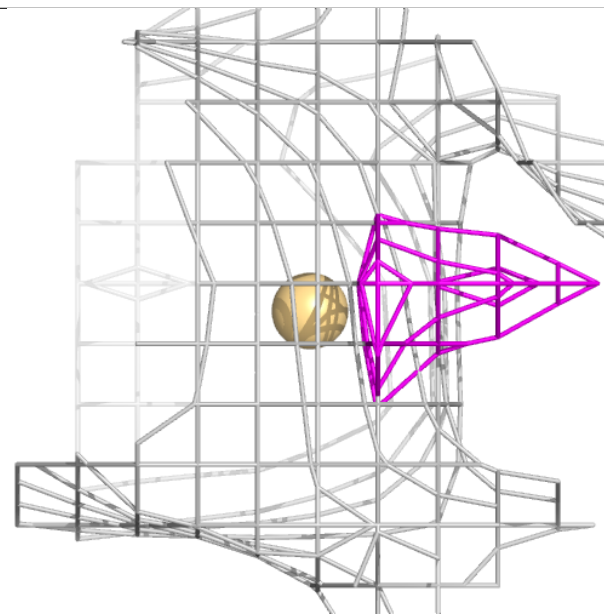
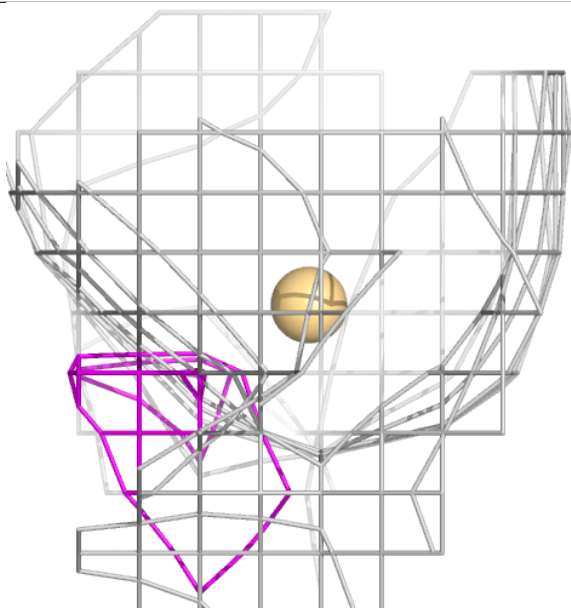
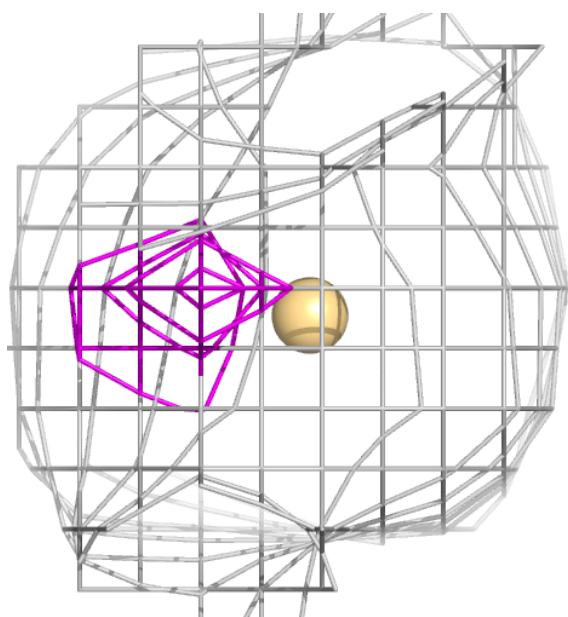

Electron density around CD JA 602:

$2mF_o-DF_c$ (at 0.7 rmsd) in gray
 mF_o-DF_c (at 3 rmsd) in purple (negative)
and green (positive)

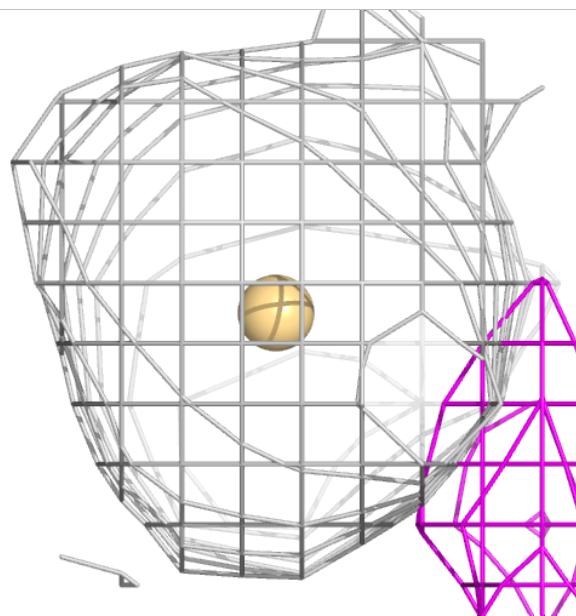
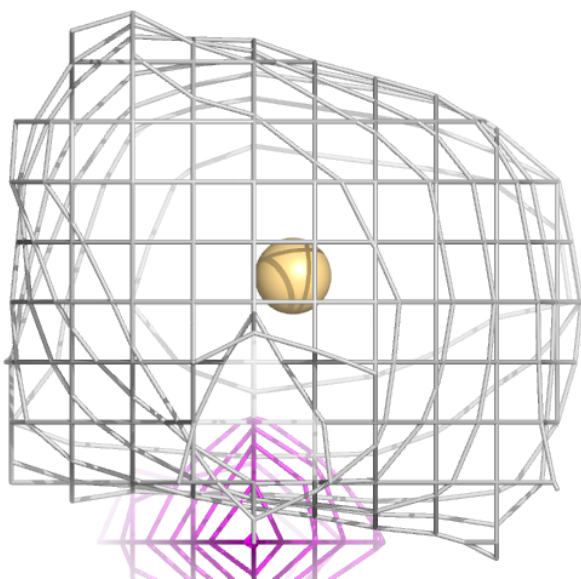
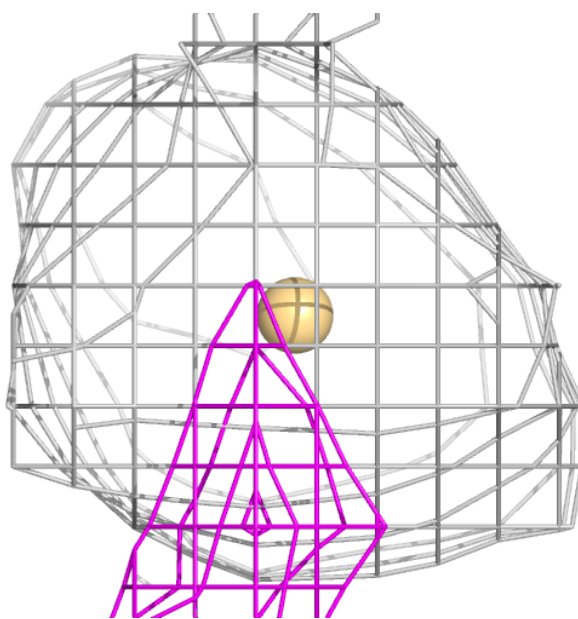

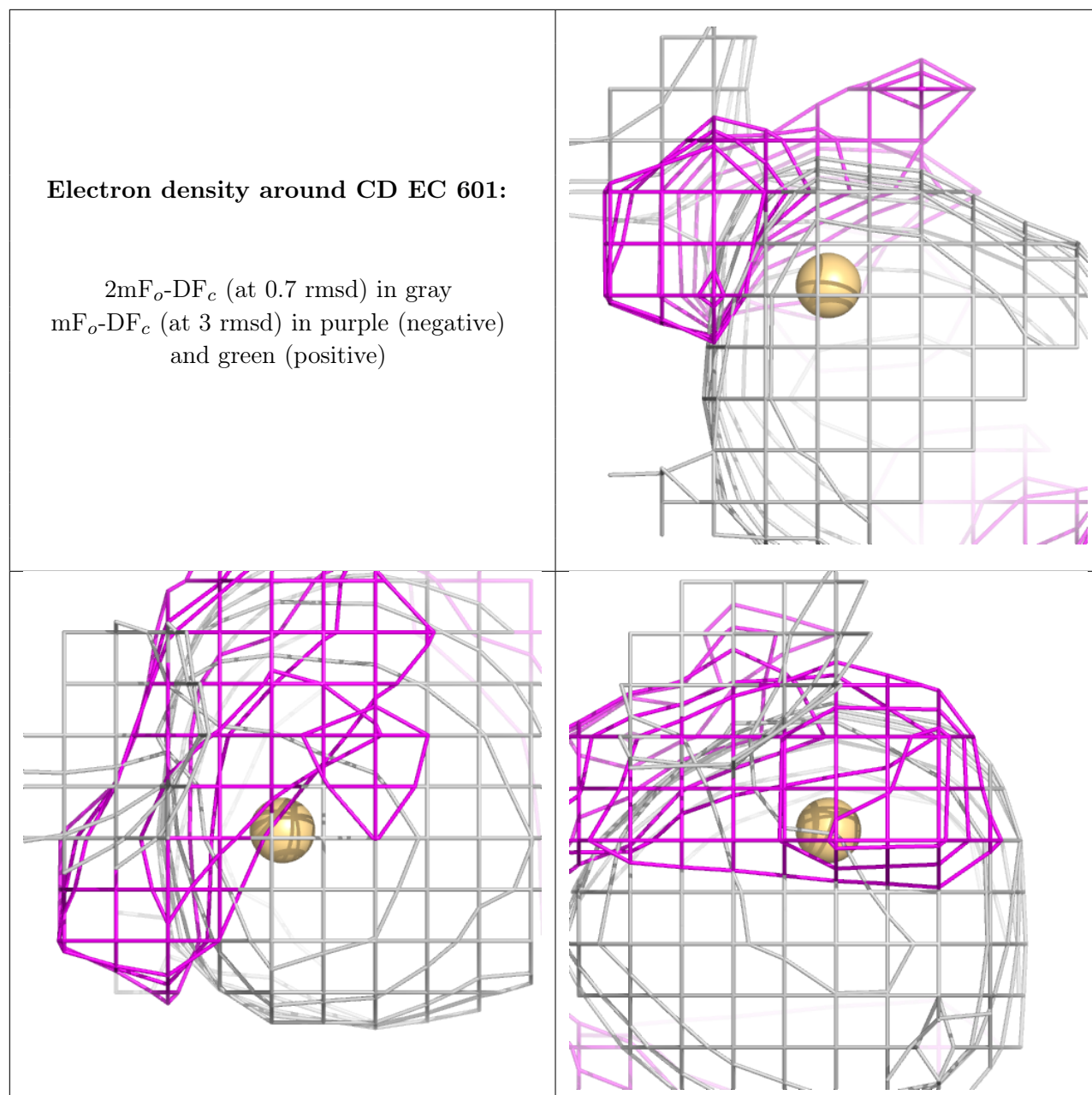

Electron density around CD IA 601:

$2mF_o-DF_c$ (at 0.7 rmsd) in gray
 mF_o-DF_c (at 3 rmsd) in purple (negative)
and green (positive)

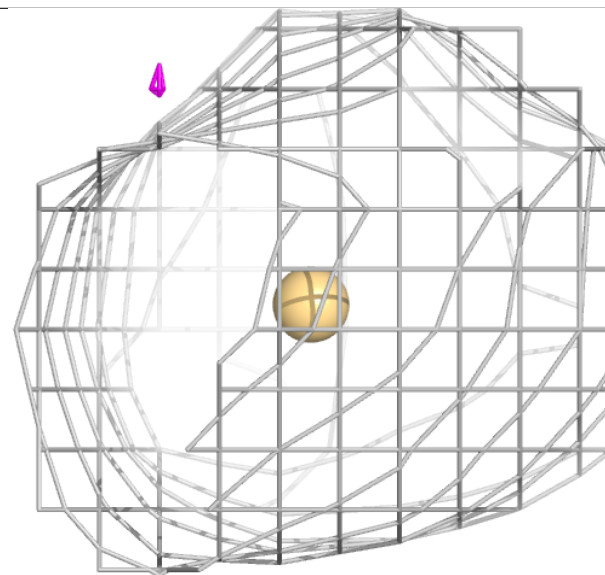
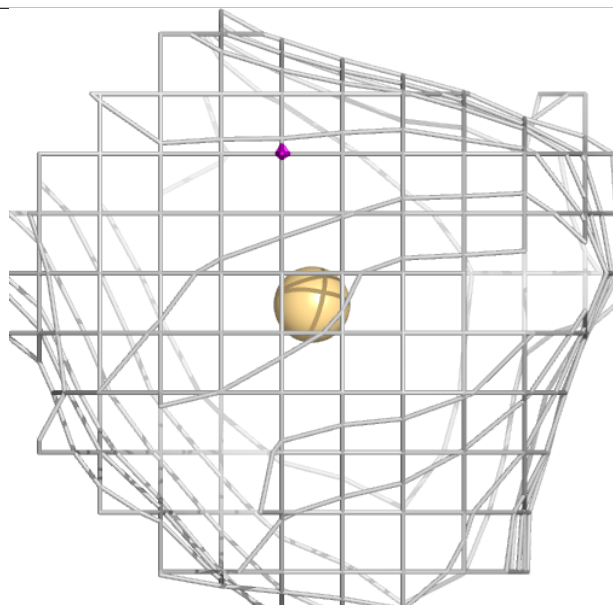
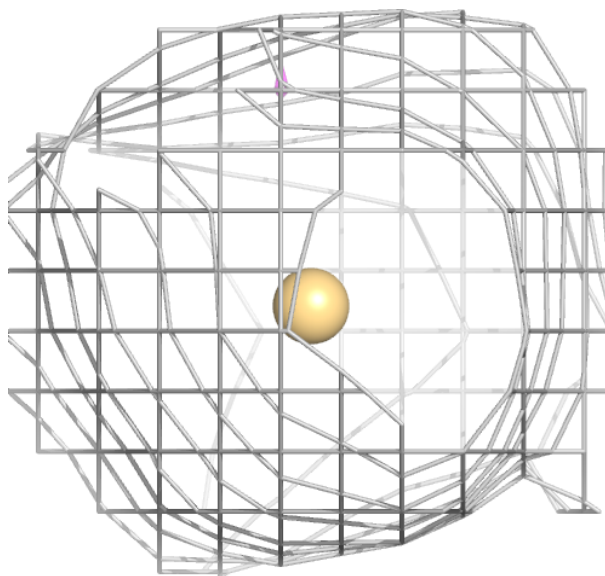

Electron density around CD KB 601:

$2mF_o-DF_c$ (at 0.7 rmsd) in gray
 mF_o-DF_c (at 3 rmsd) in purple (negative)
and green (positive)

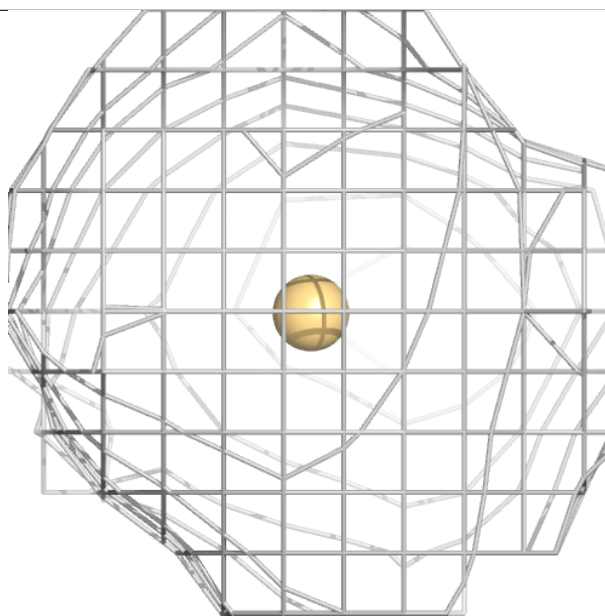
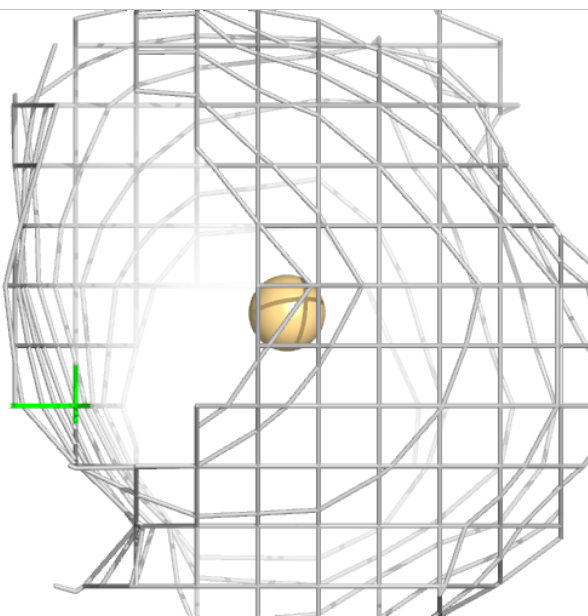
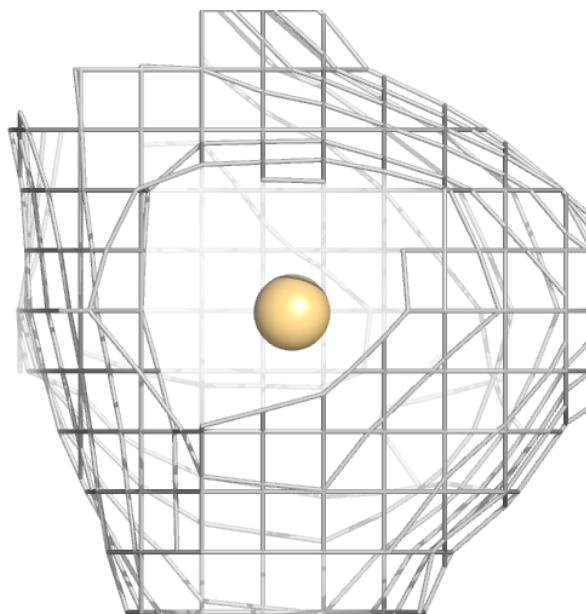

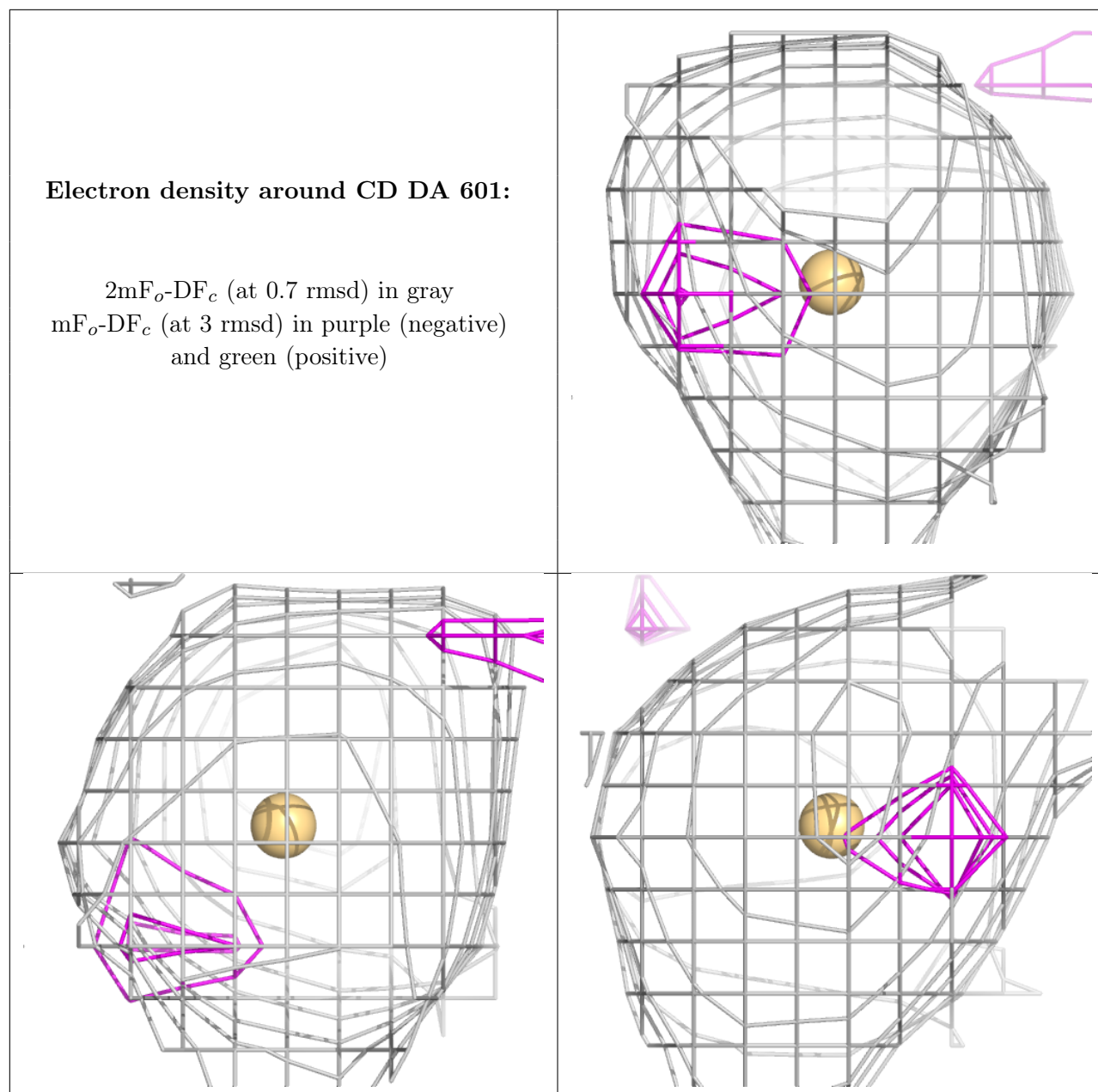

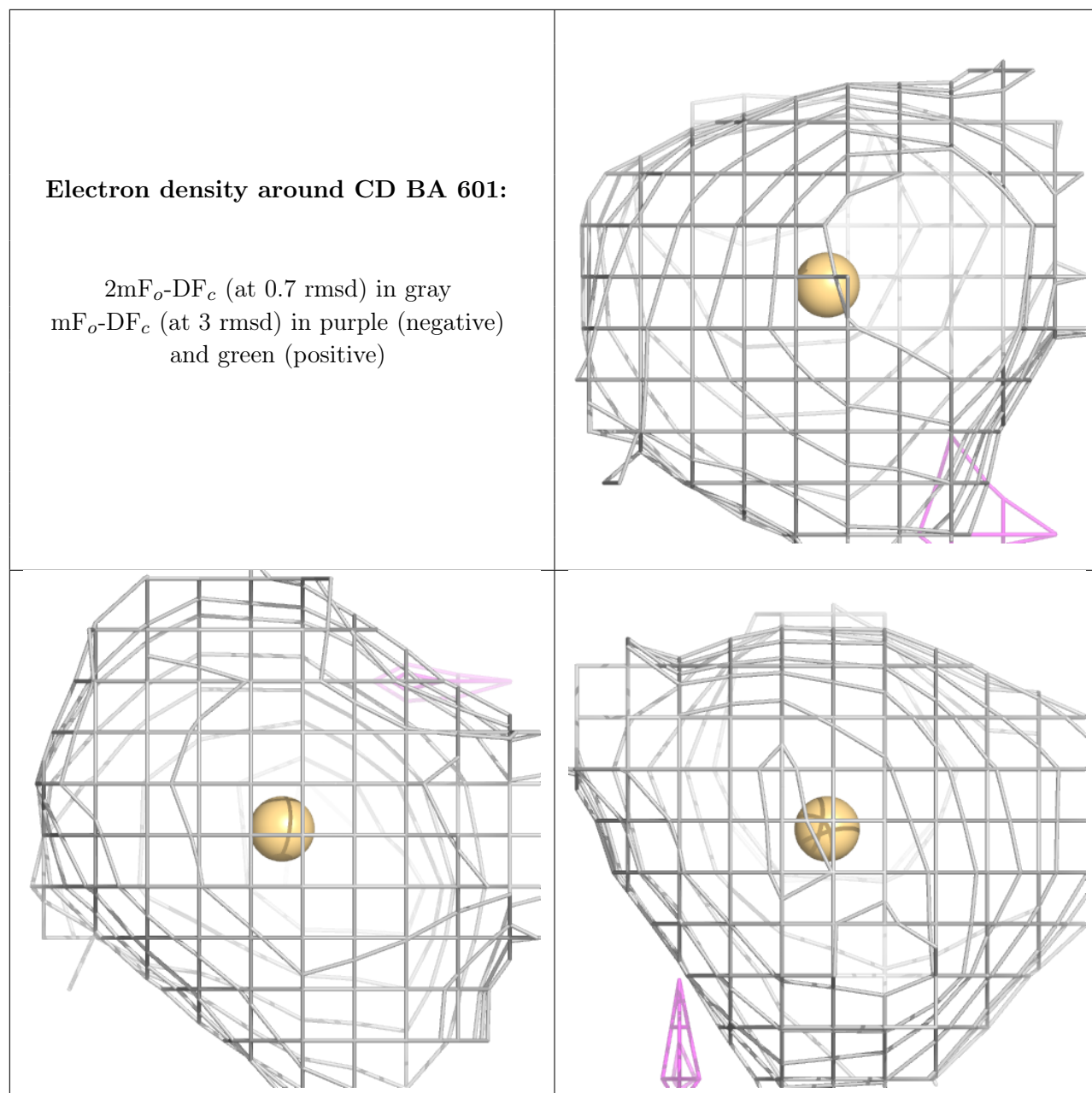

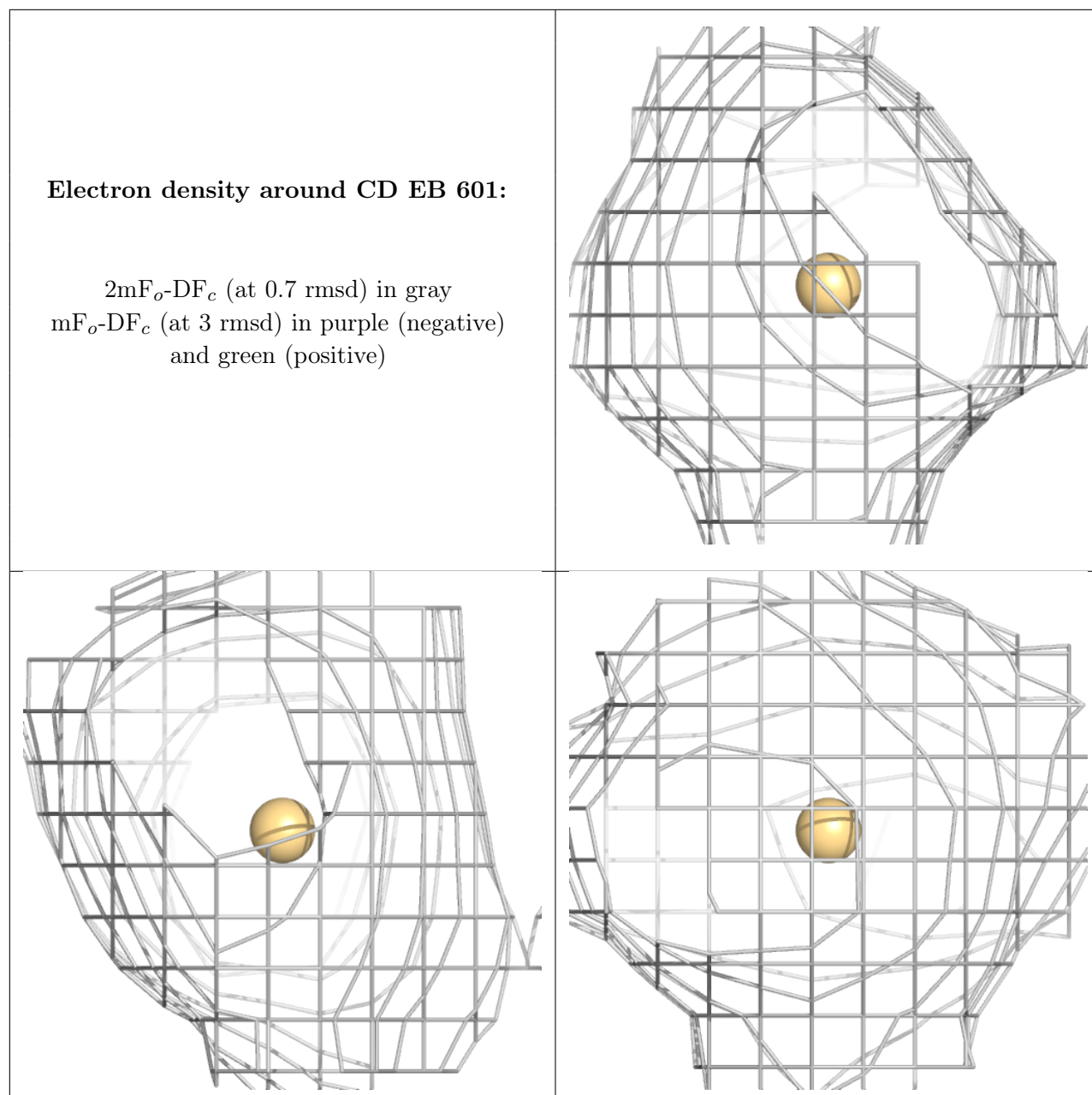

Electron density around CD MA 601:

$2mF_o-DF_c$ (at 0.7 rmsd) in gray
 mF_o-DF_c (at 3 rmsd) in purple (negative)
and green (positive)

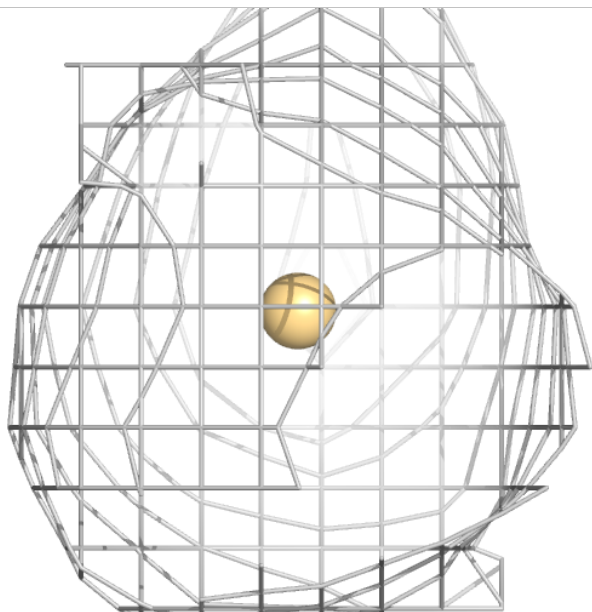
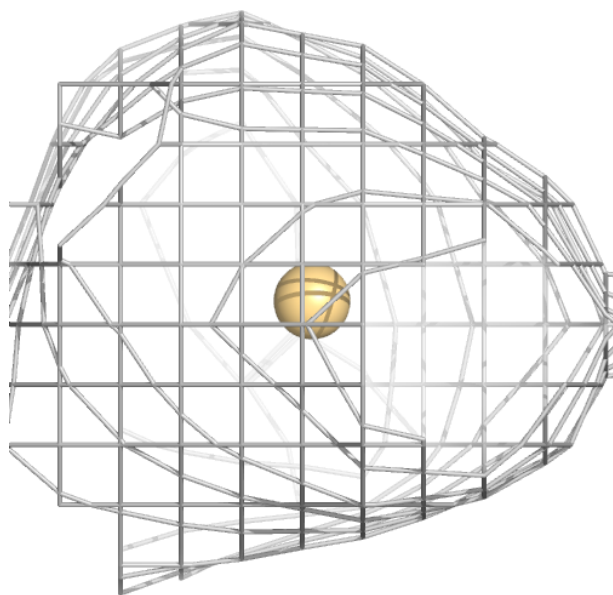
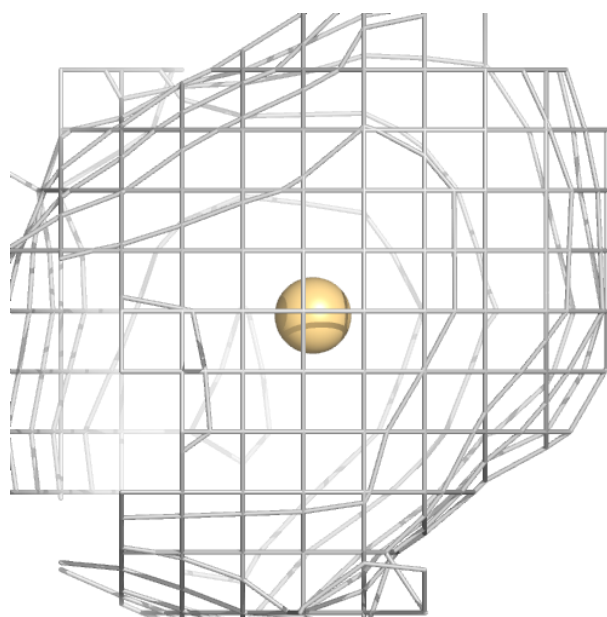

Electron density around CD FA 601:

$2mF_o-DF_c$ (at 0.7 rmsd) in gray
 mF_o-DF_c (at 3 rmsd) in purple (negative)
and green (positive)

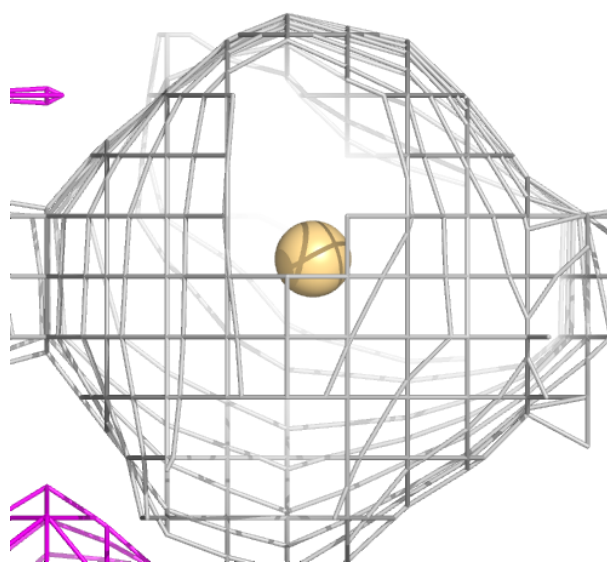
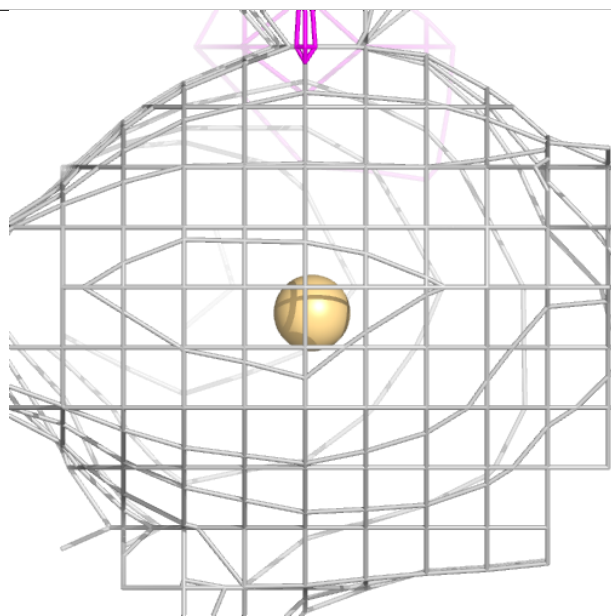
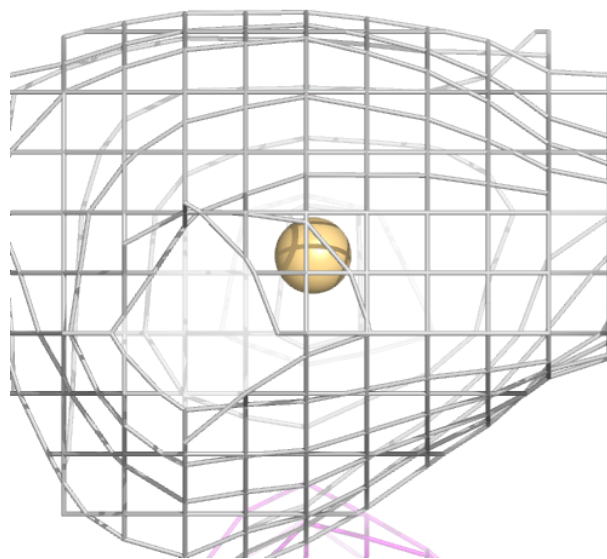

Electron density around CD NC 601:

$2mF_o-DF_c$ (at 0.7 rmsd) in gray
 mF_o-DF_c (at 3 rmsd) in purple (negative)
and green (positive)

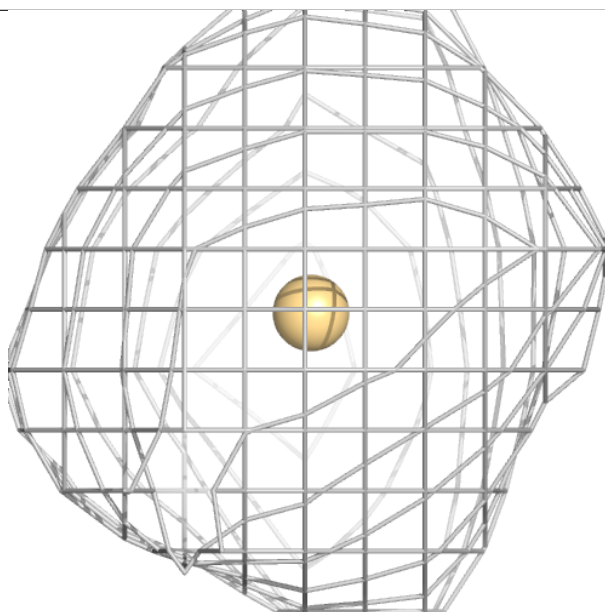
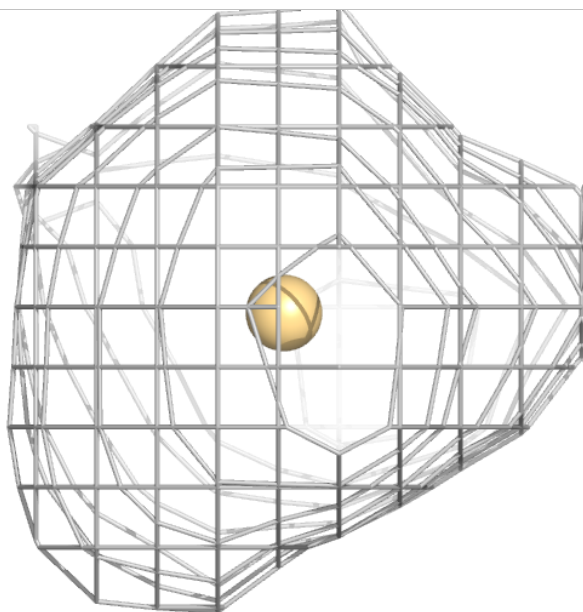
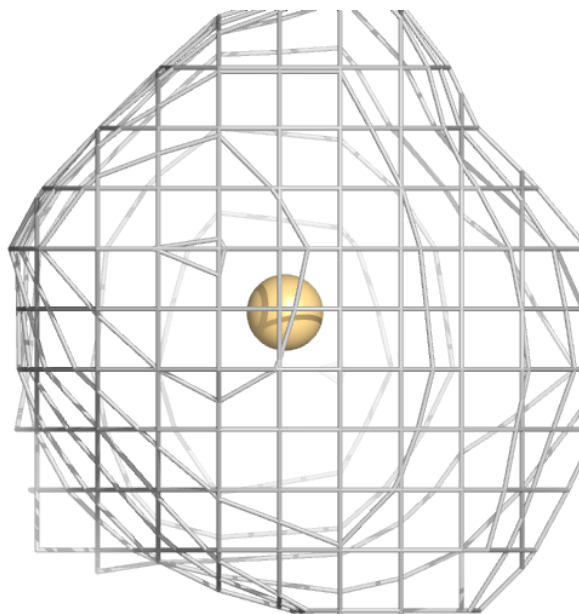

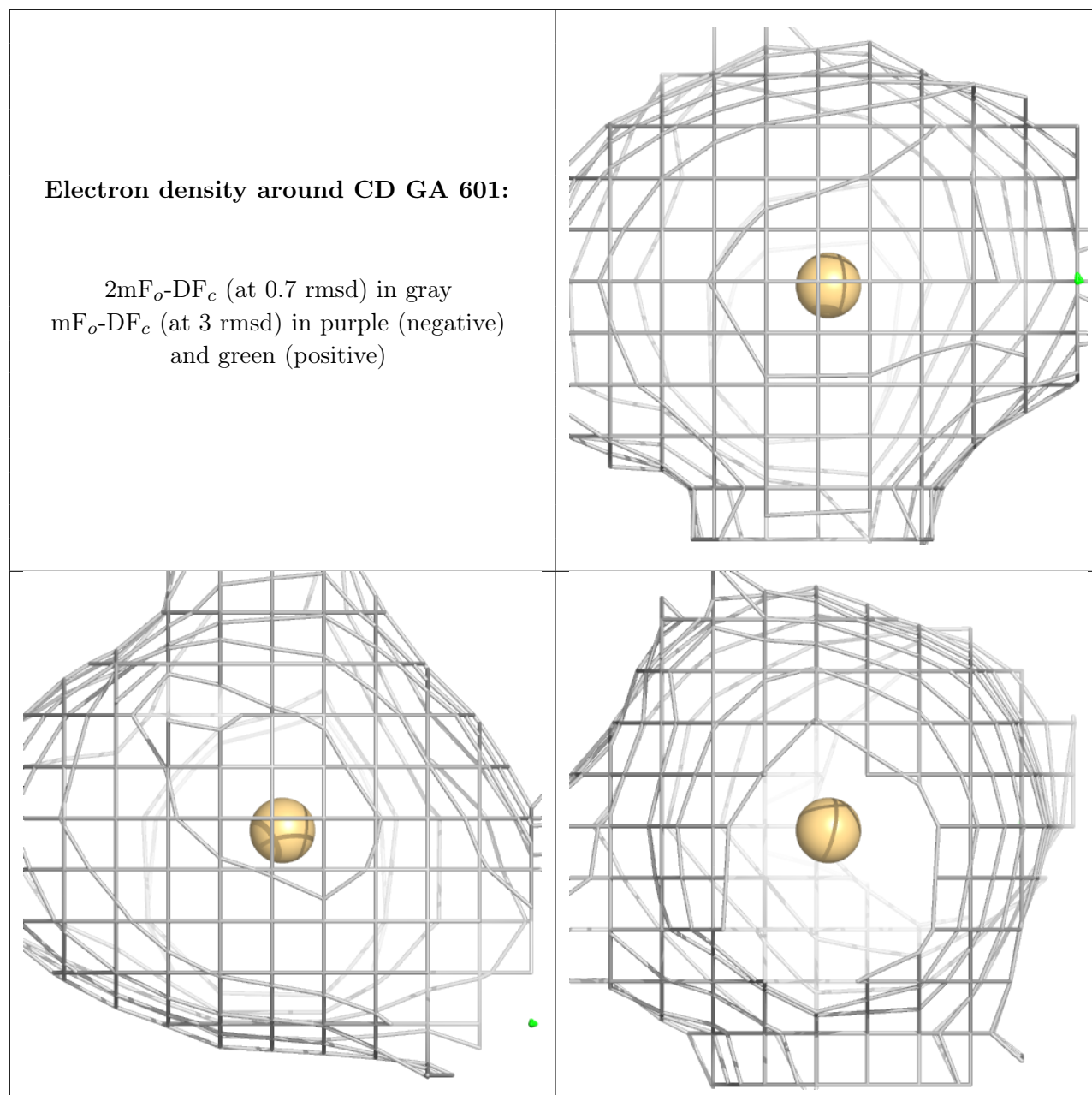

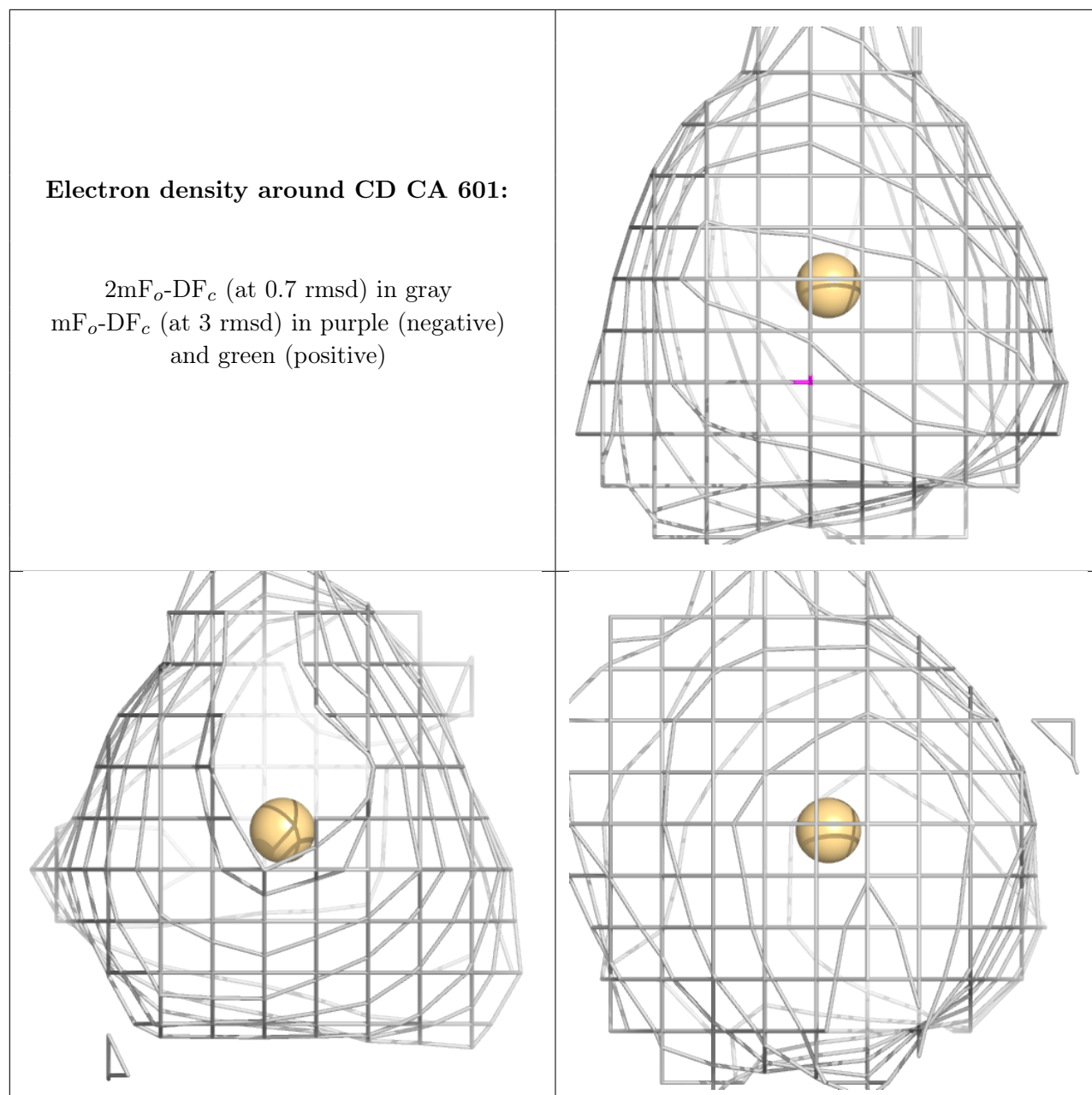

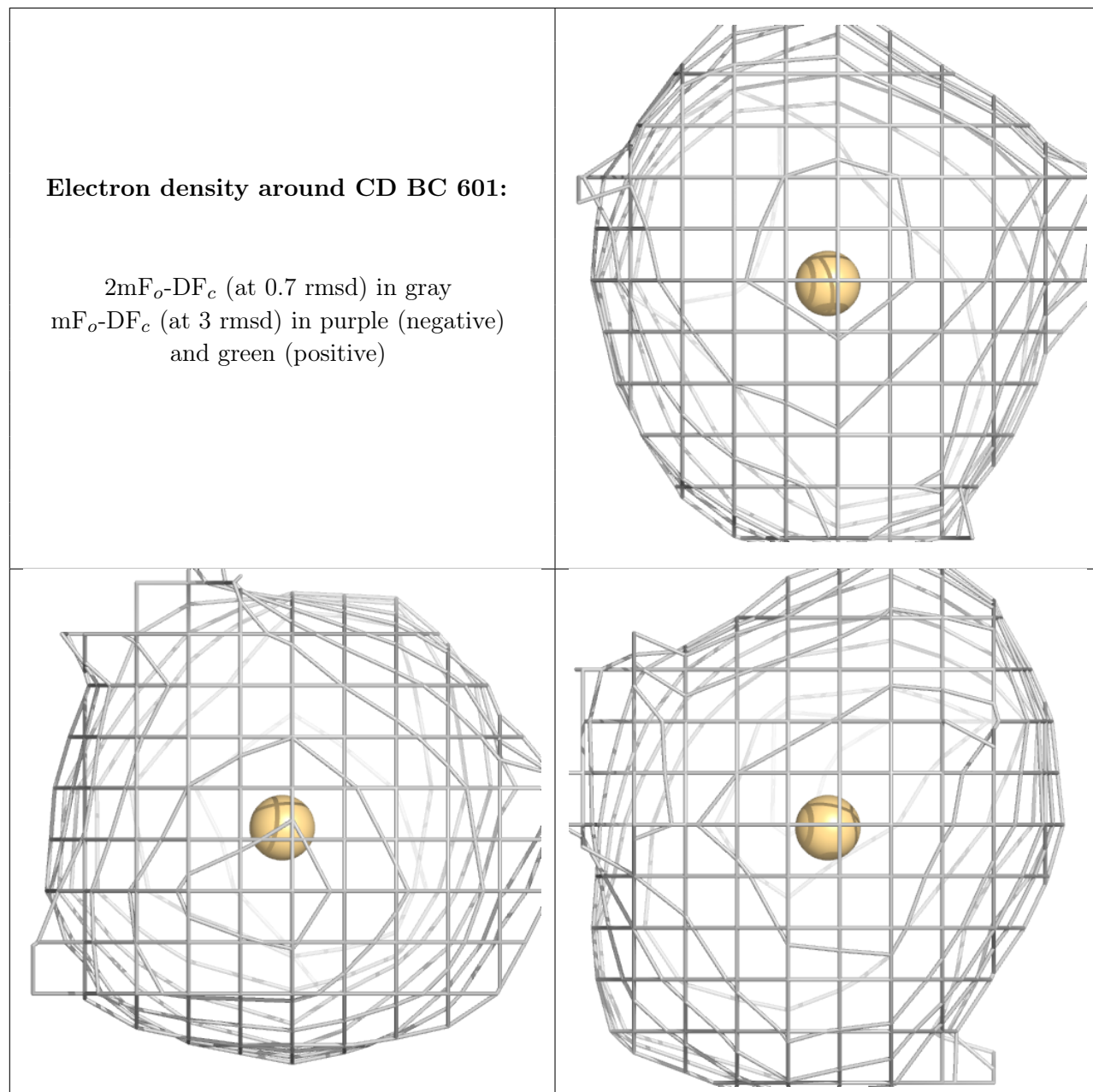

Electron density around CD OA 601:

$2mF_o-DF_c$ (at 0.7 rmsd) in gray
 mF_o-DF_c (at 3 rmsd) in purple (negative)
and green (positive)

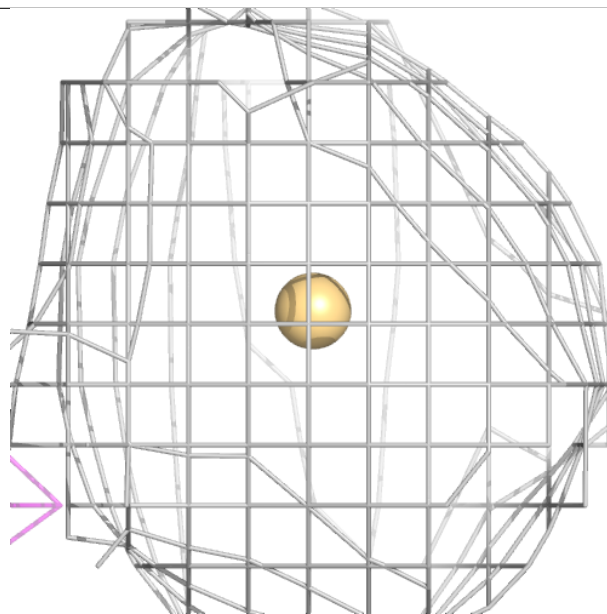
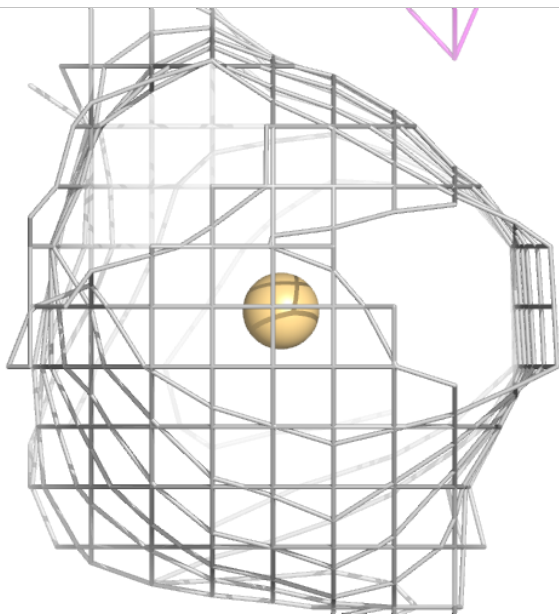
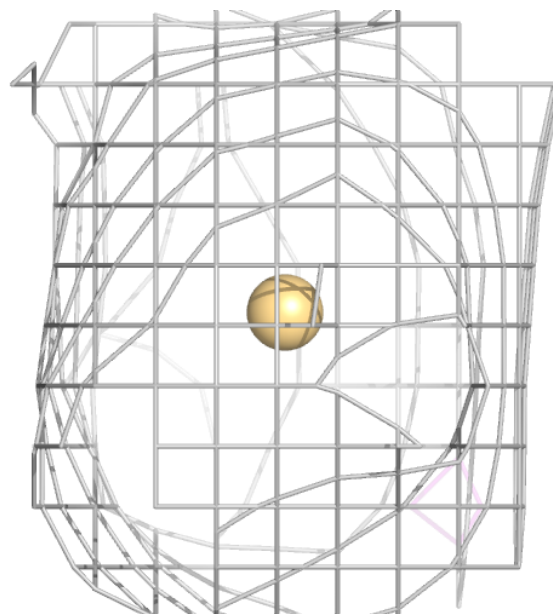

Electron density around CD HC 601:

$2mF_o-DF_c$ (at 0.7 rmsd) in gray
 mF_o-DF_c (at 3 rmsd) in purple (negative)
and green (positive)

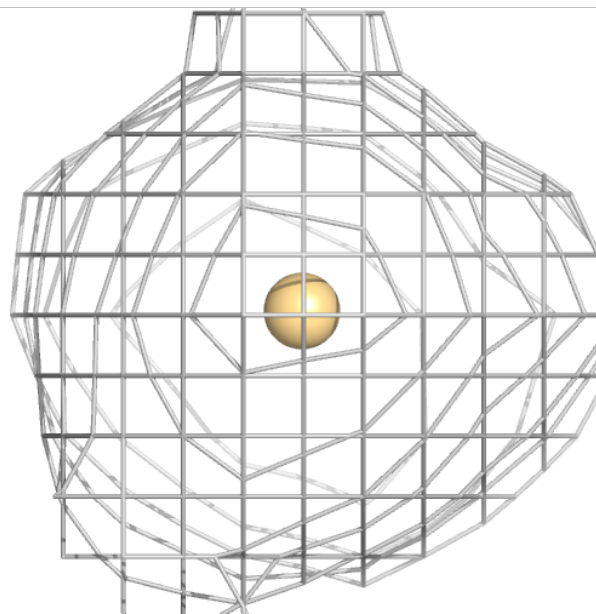
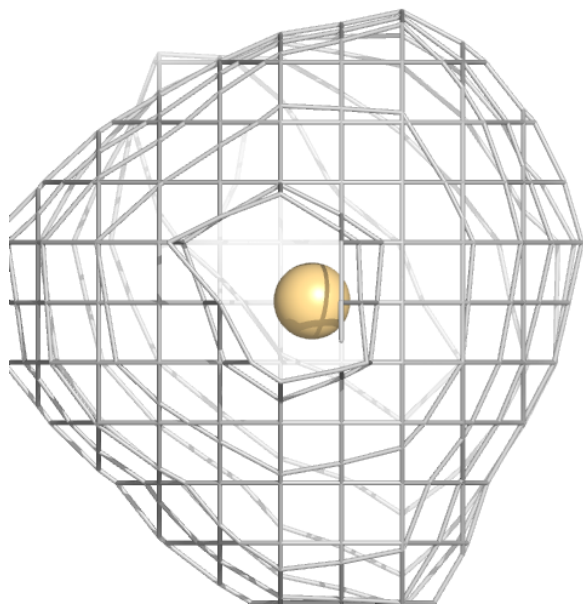
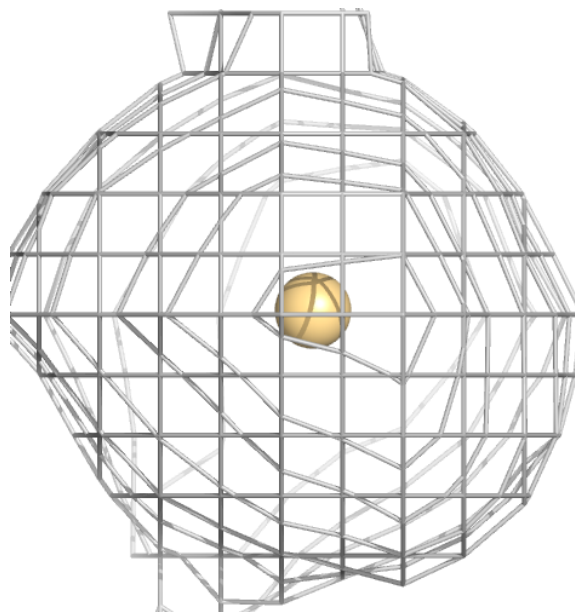

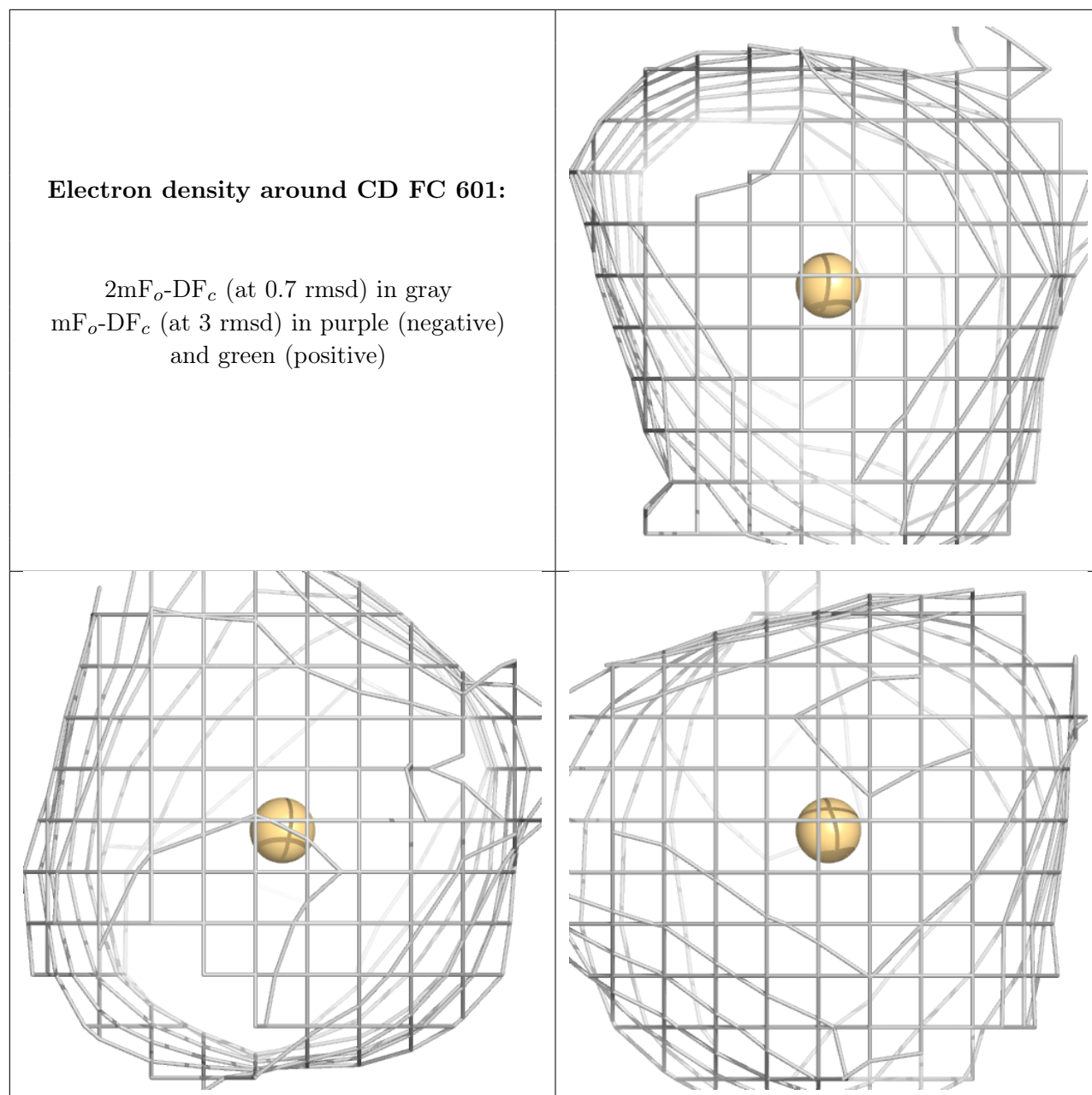

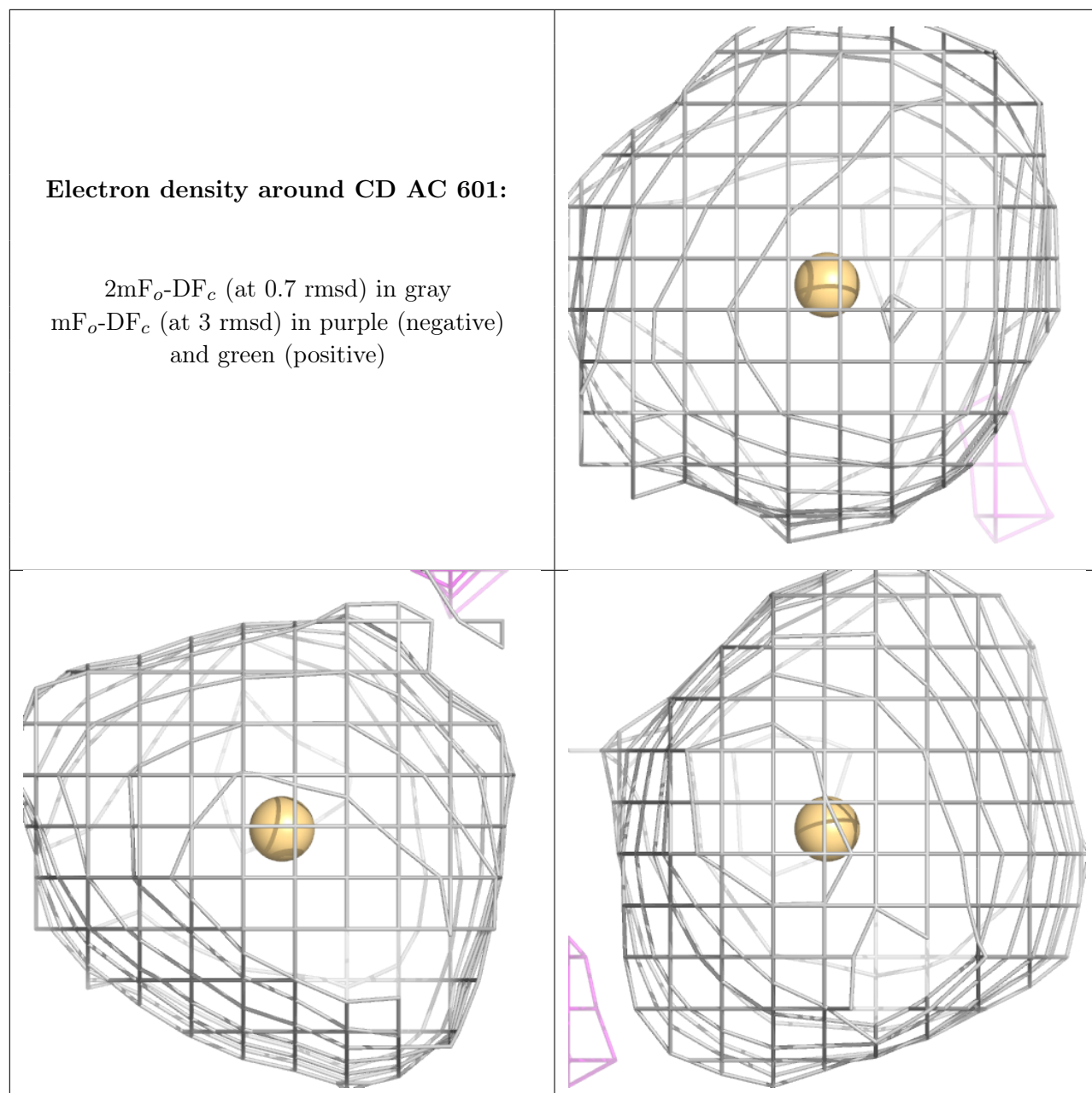

6.5 Other polymers [i](#)

There are no such residues in this entry.