



wwPDB X-ray Structure Validation Summary Report ⓘ

Feb 3, 2024 – 04:53 PM EST

PDB ID : 1KGK
Title : Direct Observation of a Cytosine Analog that Forms Five Hydrogen Bonds to Guanosine; Guanyl G-Clamp
Authors : Wilds, C.J.; Maier, M.A.; Tereshko, V.; Manoharan, M.; Egli, M.
Deposited on : 2001-11-27
Resolution : 1.00 Å(reported)

This is a wwPDB X-ray Structure Validation Summary Report for a publicly released PDB entry.

We welcome your comments at validation@mail.wwpdb.org

A user guide is available at

<https://www.wwpdb.org/validation/2017/XrayValidationReportHelp>

with specific help available everywhere you see the ⓘ symbol.

The types of validation reports are described at

<http://www.wwpdb.org/validation/2017/FAQs#types>.

The following versions of software and data (see [references ⓘ](#)) were used in the production of this report:

MolProbity : 4.02b-467
Mogul : 1.8.5 (274361), CSD as541be (2020)
Xtriage (Phenix) : 1.13
EDS : 2.36
Percentile statistics : 20191225.v01 (using entries in the PDB archive December 25th 2019)
Refmac : 5.8.0158
CCP4 : 7.0.044 (Gargrove)
Ideal geometry (proteins) : Engh & Huber (2001)
Ideal geometry (DNA, RNA) : Parkinson et al. (1996)
Validation Pipeline (wwPDB-VP) : 2.36

1 Overall quality at a glance

The following experimental techniques were used to determine the structure:

X-RAY DIFFRACTION

The reported resolution of this entry is 1.00 Å.

Percentile scores (ranging between 0-100) for global validation metrics of the entry are shown in the following graphic. The table shows the number of entries on which the scores are based.

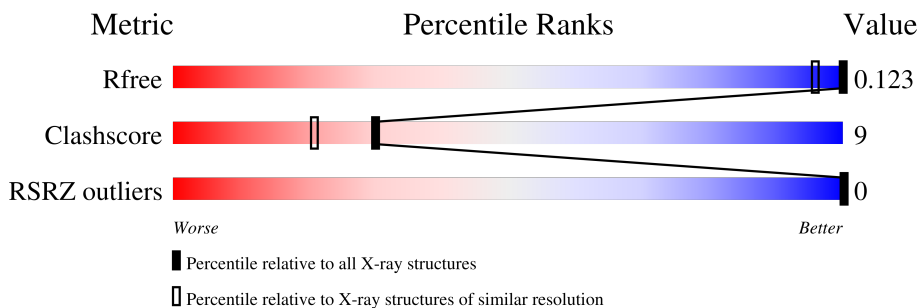

Metric	Whole archive (#Entries)	Similar resolution (#Entries, resolution range(Å))
R_{free}	130704	1050 (1.06-0.94)
Clashscore	141614	1117 (1.06-0.94)
RSRZ outliers	127900	1023 (1.06-0.94)

The table below summarises the geometric issues observed across the polymeric chains and their fit to the electron density. The red, orange, yellow and green segments of the lower bar indicate the fraction of residues that contain outliers for ≥ 3 , 2, 1 and 0 types of geometric quality criteria respectively. A grey segment represents the fraction of residues that are not modelled. The numeric value for each fraction is indicated below the corresponding segment, with a dot representing fractions $\leq 5\%$. The upper red bar (where present) indicates the fraction of residues that have poor fit to the electron density. The numeric value is given above the bar.

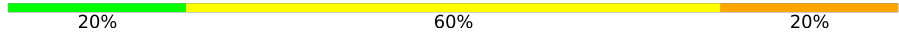
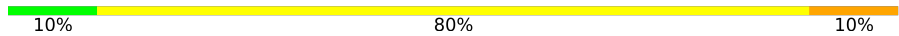
Mol	Chain	Length	Quality of chain
1	A	10	
1	B	10	

2 Entry composition [i](#)

There are 4 unique types of molecules in this entry. The entry contains 909 atoms, of which 296 are hydrogens and 0 are deuteriums.

In the tables below, the ZeroOcc column contains the number of atoms modelled with zero occupancy, the AltConf column contains the number of residues with at least one atom in alternate conformation and the Trace column contains the number of residues modelled with at most 2 atoms.

- Molecule 1 is a DNA chain called 5'-D(*GP*(GCK)P*GP*TP*AP*TP*AP*CP*GP*C)-3'.

Mol	Chain	Residues	Atoms						ZeroOcc	AltConf	Trace
			Total	C	H	N	O	P			
1	A	10	Total 343	C 106	H 126	N 41	O 61	P 9	0	1	0
1	B	10	Total 343	C 106	H 126	N 41	O 61	P 9	0	1	0

- Molecule 2 is METHOXY-ETHOXYL (three-letter code: MOE) (formula: C₃H₇O₂).

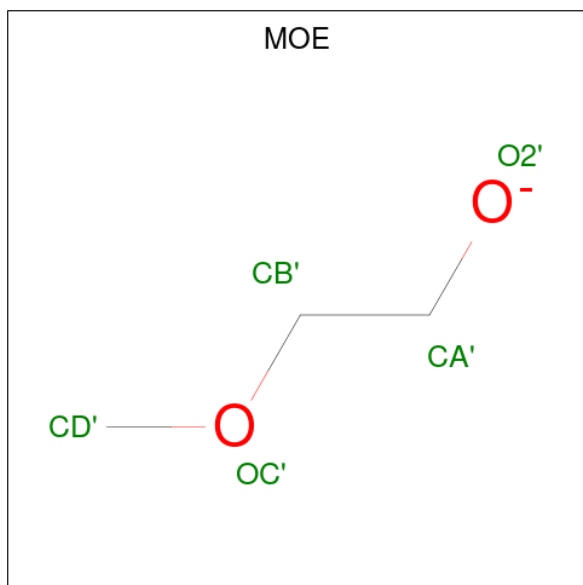

Mol	Chain	Residues	Atoms				ZeroOcc	AltConf
			Total	C	H	O		
2	A	1	Total 12	C 3	H 7	O 2	0	0
2	B	1	Total 12	C 3	H 7	O 2	0	0

- Molecule 3 is SPERMINE (FULLY PROTONATED FORM) (three-letter code: SPK) (formula: C₁₀H₃₀N₄).

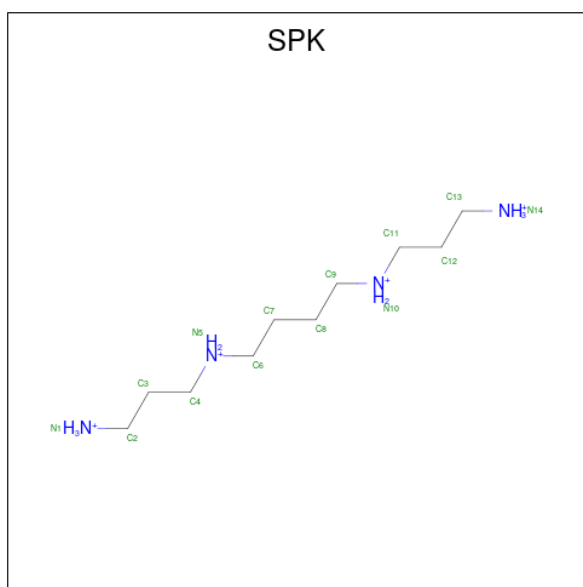

Mol	Chain	Residues	Atoms				ZeroOcc	AltConf
			Total	C	H	N		
3	A	1	44	10	30	4	0	0

- Molecule 4 is water.

Mol	Chain	Residues	Atoms		ZeroOcc	AltConf
4	A	78	Total	O	0	0
			78	78		
4	B	77	Total	O	0	0
			77	77		

3 Residue-property plots

These plots are drawn for all protein, RNA, DNA and oligosaccharide chains in the entry. The first graphic for a chain summarises the proportions of the various outlier classes displayed in the second graphic. The second graphic shows the sequence view annotated by issues in geometry and electron density. Residues are color-coded according to the number of geometric quality criteria for which they contain at least one outlier: green = 0, yellow = 1, orange = 2 and red = 3 or more. A red dot above a residue indicates a poor fit to the electron density ($RSRZ > 2$). Stretches of 2 or more consecutive residues without any outlier are shown as a green connector. Residues present in the sample, but not in the model, are shown in grey.

- Molecule 1: 5'-D(*GP*(GCK)P*GP*TP*AP*TP*AP*CP*GP*C)-3'

Chain A: 

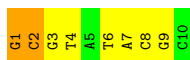

- Molecule 1: 5'-D(*GP*(GCK)P*GP*TP*AP*TP*AP*CP*GP*C)-3'

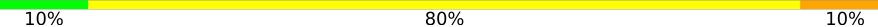
Chain B: 

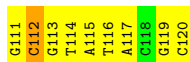

4 Data and refinement statistics

Property	Value	Source
Space group	P 21 21 21	Depositor
Cell constants a, b, c, α , β , γ	24.52Å 43.02Å 46.68Å 90.00° 90.00° 90.00°	Depositor
Resolution (Å)	10.00 – 1.00 19.38 – 1.00	Depositor EDS
% Data completeness (in resolution range)	99.6 (10.00-1.00) 98.9 (19.38-1.00)	Depositor EDS
R_{merge}	0.05	Depositor
R_{sym}	(Not available)	Depositor
$\langle I/\sigma(I) \rangle$ ¹	11.17 (at 1.00Å)	Xtrriage
Refinement program	SHELXL-97	Depositor
R, R_{free}	0.128 , (Not available) 0.120 , 0.123	Depositor DCC
R_{free} test set	2738 reflections (9.99%)	wwPDB-VP
Wilson B-factor (Å ²)	7.0	Xtrriage
Anisotropy	0.034	Xtrriage
Bulk solvent k_{sol} (e/Å ³), B_{sol} (Å ²)	0.36 , 46.5	EDS
L-test for twinning ²	$\langle L \rangle = 0.50$, $\langle L^2 \rangle = 0.33$	Xtrriage
Estimated twinning fraction	No twinning to report.	Xtrriage
F_o, F_c correlation	0.98	EDS
Total number of atoms	909	wwPDB-VP
Average B, all atoms (Å ²)	11.0	wwPDB-VP

Xtrriage's analysis on translational NCS is as follows: *The largest off-origin peak in the Patterson function is 11.88% of the height of the origin peak. No significant pseudotranslation is detected.*

¹Intensities estimated from amplitudes.

²Theoretical values of $\langle |L| \rangle$, $\langle L^2 \rangle$ for acentric reflections are 0.5, 0.333 respectively for untwinned datasets, and 0.375, 0.2 for perfectly twinned datasets.

5 Model quality [i](#)

5.1 Standard geometry [i](#)

Bond lengths and bond angles in the following residue types are not validated in this section: GCK, MOE, SPK

The Z score for a bond length (or angle) is the number of standard deviations the observed value is removed from the expected value. A bond length (or angle) with $|Z| > 5$ is considered an outlier worth inspection. RMSZ is the root-mean-square of all Z scores of the bond lengths (or angles).

Mol	Chain	Bond lengths		Bond angles	
		RMSZ	# $ Z > 5$	RMSZ	# $ Z > 5$
1	A	2.48	12/225 (5.3%)	2.24	17/342 (5.0%)
1	B	2.39	11/225 (4.9%)	2.16	12/342 (3.5%)
All	All	2.43	23/450 (5.1%)	2.20	29/684 (4.2%)

The worst 5 of 23 bond length outliers are listed below:

Mol	Chain	Res	Type	Atoms	Z	Observed(Å)	Ideal(Å)
1	A	3	DG	C2'-C1'	-10.90	1.41	1.52
1	B	111[A]	DG	C2'-C1'	-10.88	1.41	1.52
1	B	111[B]	DG	C2'-C1'	-10.88	1.41	1.52
1	A	4	DT	C2'-C1'	-10.37	1.41	1.52
1	A	1[A]	DG	C2'-C1'	-9.91	1.42	1.52

The worst 5 of 29 bond angle outliers are listed below:

Mol	Chain	Res	Type	Atoms	Z	Observed(°)	Ideal(°)
1	B	111[A]	DG	O4'-C1'-N9	-11.80	99.74	108.00
1	B	111[B]	DG	O4'-C1'-N9	-11.80	99.74	108.00
1	A	3	DG	O4'-C1'-N9	-10.20	100.86	108.00
1	A	8	DC	O5'-P-OP2	-9.50	97.15	105.70
1	A	1[A]	DG	O4'-C1'-N9	-9.40	101.42	108.00

There are no chirality outliers.

There are no planarity outliers.

5.2 Too-close contacts [i](#)

In the following table, the Non-H and H(model) columns list the number of non-hydrogen atoms and hydrogen atoms in the chain respectively. The H(added) column lists the number of hydrogen

atoms added and optimized by MolProbity. The Clashes column lists the number of clashes within the asymmetric unit, whereas Symm-Clashes lists symmetry-related clashes.

Mol	Chain	Non-H	H(model)	H(added)	Clashes	Symm-Clashes
1	A	217	126	117	5	0
1	B	217	126	117	2	0
2	A	5	7	7	0	0
2	B	5	7	7	0	0
3	A	14	30	30	0	1
4	A	78	0	0	2	3
4	B	77	0	0	0	2
All	All	613	296	278	7	3

The all-atom clashscore is defined as the number of clashes found per 1000 atoms (including hydrogen atoms). The all-atom clashscore for this structure is 9.

The worst 5 of 7 close contacts within the same asymmetric unit are listed below, sorted by their clash magnitude.

Atom-1	Atom-2	Interatomic distance (Å)	Clash overlap (Å)
1:A:2:GCK:C1'	1:A:2:GCK:O4'	1.71	1.12
1:A:2:GCK:O4'	1:A:2:GCK:N1	2.38	0.54
1:A:1[B]:DG:O5'	4:A:1317:HOH:O	2.10	0.51
1:A:1[B]:DG:H5''	4:A:1320:HOH:O	2.15	0.45
1:A:2:GCK:O4'	1:A:2:GCK:C6	2.70	0.40

All (3) symmetry-related close contacts are listed below. The label for Atom-2 includes the symmetry operator and encoded unit-cell translations to be applied.

Atom-1	Atom-2	Interatomic distance (Å)	Clash overlap (Å)
4:A:1316:HOH:O	4:B:1255:HOH:O[3_545]	2.11	0.09
4:A:1333:HOH:O	4:B:1276:HOH:O[3_555]	2.17	0.03
3:A:221:SPK:H1C	4:A:1329:HOH:O[1_455]	1.60	0.00

5.3 Torsion angles [i](#)

5.3.1 Protein backbone [i](#)

There are no protein molecules in this entry.

5.3.2 Protein sidechains [i](#)

There are no protein molecules in this entry.

5.3.3 RNA [i](#)

There are no RNA molecules in this entry.

5.4 Non-standard residues in protein, DNA, RNA chains [i](#)

2 non-standard protein/DNA/RNA residues are modelled in this entry.

In the following table, the Counts columns list the number of bonds (or angles) for which Mogul statistics could be retrieved, the number of bonds (or angles) that are observed in the model and the number of bonds (or angles) that are defined in the Chemical Component Dictionary. The Link column lists molecule types, if any, to which the group is linked. The Z score for a bond length (or angle) is the number of standard deviations the observed value is removed from the expected value. A bond length (or angle) with $|Z| > 2$ is considered an outlier worth inspection. RMSZ is the root-mean-square of all Z scores of the bond lengths (or angles).

Mol	Type	Chain	Res	Link	Bond lengths			Bond angles		
					Counts	RMSZ	# $ Z > 2$	Counts	RMSZ	# $ Z > 2$
1	GCK	B	112	1	33,36,37	1.92	7 (21%)	40,51,54	1.42	5 (12%)
1	GCK	A	2	1	33,36,37	3.08	7 (21%)	40,51,54	2.42	8 (20%)

In the following table, the Chirals column lists the number of chiral outliers, the number of chiral centers analysed, the number of these observed in the model and the number defined in the Chemical Component Dictionary. Similar counts are reported in the Torsion and Rings columns. '-' means no outliers of that kind were identified.

Mol	Type	Chain	Res	Link	Chirals	Torsions	Rings
1	GCK	B	112	1	-	3/14/28/29	0/4/4/4
1	GCK	A	2	1	-	2/14/28/29	0/4/4/4

The worst 5 of 14 bond length outliers are listed below:

Mol	Chain	Res	Type	Atoms	Z	Observed(Å)	Ideal(Å)
1	A	2	GCK	O4'-C1'	13.11	1.71	1.42
1	A	2	GCK	C2'-C1'	-8.62	1.28	1.52
1	B	112	GCK	O4'-C1'	6.22	1.56	1.42
1	B	112	GCK	C2'-C1'	-5.56	1.36	1.52
1	A	2	GCK	O15-C16	4.15	1.57	1.43

The worst 5 of 13 bond angle outliers are listed below:

Mol	Chain	Res	Type	Atoms	Z	Observed(°)	Ideal(°)
1	A	2	GCK	C2'-C1'-N1	8.12	132.47	113.77
1	A	2	GCK	O4'-C1'-N1	-8.06	93.45	107.86
1	A	2	GCK	C1'-N1-C2	-4.54	109.78	117.74
1	B	112	GCK	O4'-C1'-N1	-4.40	99.99	107.86
1	A	2	GCK	C1'-N1-C6	4.28	128.16	120.77

There are no chirality outliers.

All (5) torsion outliers are listed below:

Mol	Chain	Res	Type	Atoms
1	B	112	GCK	C17-C16-O15-C13
1	A	2	GCK	C14-C13-O15-C16
1	B	112	GCK	C14-C13-O15-C16
1	A	2	GCK	C12-C13-O15-C16
1	B	112	GCK	C12-C13-O15-C16

There are no ring outliers.

2 monomers are involved in 5 short contacts:

Mol	Chain	Res	Type	Clashes	Symm-Clashes
1	B	112	GCK	2	0
1	A	2	GCK	3	0

5.5 Carbohydrates [i](#)

There are no monosaccharides in this entry.

5.6 Ligand geometry [i](#)

3 ligands are modelled in this entry.

In the following table, the Counts columns list the number of bonds (or angles) for which Mogul statistics could be retrieved, the number of bonds (or angles) that are observed in the model and the number of bonds (or angles) that are defined in the Chemical Component Dictionary. The Link column lists molecule types, if any, to which the group is linked. The Z score for a bond length (or angle) is the number of standard deviations the observed value is removed from the expected value. A bond length (or angle) with $|Z| > 2$ is considered an outlier worth inspection. RMSZ is the root-mean-square of all Z scores of the bond lengths (or angles).

Mol	Type	Chain	Res	Link	Bond lengths			Bond angles		
					Counts	RMSZ	# Z > 2	Counts	RMSZ	# Z > 2
3	SPK	A	221	-	13,13,13	0.52	0	12,12,12	0.55	0
2	MOE	A	306	1	4,4,4	0.87	0	3,3,3	0.68	0
2	MOE	B	316	1	4,4,4	0.80	0	3,3,3	0.79	0

In the following table, the Chirals column lists the number of chiral outliers, the number of chiral centers analysed, the number of these observed in the model and the number defined in the Chemical Component Dictionary. Similar counts are reported in the Torsion and Rings columns. '-' means no outliers of that kind were identified.

Mol	Type	Chain	Res	Link	Chirals	Torsions	Rings
3	SPK	A	221	-	-	0/11/11/11	-
2	MOE	A	306	1	-	0/2/2/2	-
2	MOE	B	316	1	-	0/2/2/2	-

There are no bond length outliers.

There are no bond angle outliers.

There are no chirality outliers.

There are no torsion outliers.

There are no ring outliers.

1 monomer is involved in 1 short contact:

Mol	Chain	Res	Type	Clashes	Symm-Clashes
3	A	221	SPK	0	1

5.7 Other polymers [i](#)

There are no such residues in this entry.

5.8 Polymer linkage issues [i](#)

There are no chain breaks in this entry.

6 Fit of model and data [i](#)

6.1 Protein, DNA and RNA chains [i](#)

In the following table, the column labelled '#RSRZ > 2' contains the number (and percentage) of RSRZ outliers, followed by percent RSRZ outliers for the chain as percentile scores relative to all X-ray entries and entries of similar resolution. The OWAB column contains the minimum, median, 95th percentile and maximum values of the occupancy-weighted average B-factor per residue. The column labelled 'Q < 0.9' lists the number of (and percentage) of residues with an average occupancy less than 0.9.

Mol	Chain	Analysed	<RSRZ>	#RSRZ>2	OWAB(Å ²)	Q<0.9
1	A	9/10 (90%)	-0.44	0 100 100	7, 7, 8, 9	0
1	B	9/10 (90%)	-0.37	0 100 100	6, 7, 10, 11	0
All	All	18/20 (90%)	-0.41	0 100 100	6, 7, 10, 11	0

There are no RSRZ outliers to report.

6.2 Non-standard residues in protein, DNA, RNA chains [i](#)

In the following table, the Atoms column lists the number of modelled atoms in the group and the number defined in the chemical component dictionary. The B-factors column lists the minimum, median, 95th percentile and maximum values of B factors of atoms in the group. The column labelled 'Q < 0.9' lists the number of atoms with occupancy less than 0.9.

Mol	Type	Chain	Res	Atoms	RSCC	RSR	B-factors(Å ²)	Q<0.9
1	GCK	A	2	33/34	0.97	0.08	5,8,11,12	0
1	GCK	B	112	33/34	0.97	0.07	6,10,13,16	0

6.3 Carbohydrates [i](#)

There are no monosaccharides in this entry.

6.4 Ligands [i](#)

In the following table, the Atoms column lists the number of modelled atoms in the group and the number defined in the chemical component dictionary. The B-factors column lists the minimum, median, 95th percentile and maximum values of B factors of atoms in the group. The column labelled 'Q < 0.9' lists the number of atoms with occupancy less than 0.9.

Mol	Type	Chain	Res	Atoms	RSCC	RSR	B-factors(\AA^2)	Q<0.9
3	SPK	A	221	14/14	0.74	0.23	5,13,26,39	19
2	MOE	B	316	5/5	0.97	0.09	7,13,33,33	0
2	MOE	A	306	5/5	0.97	0.17	8,17,42,42	0

6.5 Other polymers [i](#)

There are no such residues in this entry.