



# Full wwPDB X-ray Structure Validation Report ⓘ

Oct 9, 2023 – 10:37 PM EDT

PDB ID : 7KLC  
Title : Crystal structure of M4H2K1 Fab bound to HIV-1 BG505 gp120 core and to 17b Fab  
Authors : Kumar, S.; Wilson, I.A.  
Deposited on : 2020-10-29  
Resolution : 4.30 Å(reported)

This is a Full wwPDB X-ray Structure Validation Report for a publicly released PDB entry.

We welcome your comments at [validation@mail.wwpdb.org](mailto:validation@mail.wwpdb.org)

A user guide is available at

<https://www.wwpdb.org/validation/2017/XrayValidationReportHelp>

with specific help available everywhere you see the ⓘ symbol.

The types of validation reports are described at

<http://www.wwpdb.org/validation/2017/FAQs#types>.

---

The following versions of software and data (see [references ⓘ](#)) were used in the production of this report:

MolProbity : 4.02b-467  
Mogul : 1.8.5 (274361), CSD as541be (2020)  
Xtriage (Phenix) : 1.13  
EDS : 2.35.1  
Percentile statistics : 20191225.v01 (using entries in the PDB archive December 25th 2019)  
Refmac : 5.8.0158  
CCP4 : 7.0.044 (Gargrove)  
Ideal geometry (proteins) : Engh & Huber (2001)  
Ideal geometry (DNA, RNA) : Parkinson et al. (1996)  
Validation Pipeline (wwPDB-VP) : 2.35.1

# 1 Overall quality at a glance

The following experimental techniques were used to determine the structure:

*X-RAY DIFFRACTION*

The reported resolution of this entry is 4.30 Å.

Percentile scores (ranging between 0-100) for global validation metrics of the entry are shown in the following graphic. The table shows the number of entries on which the scores are based.

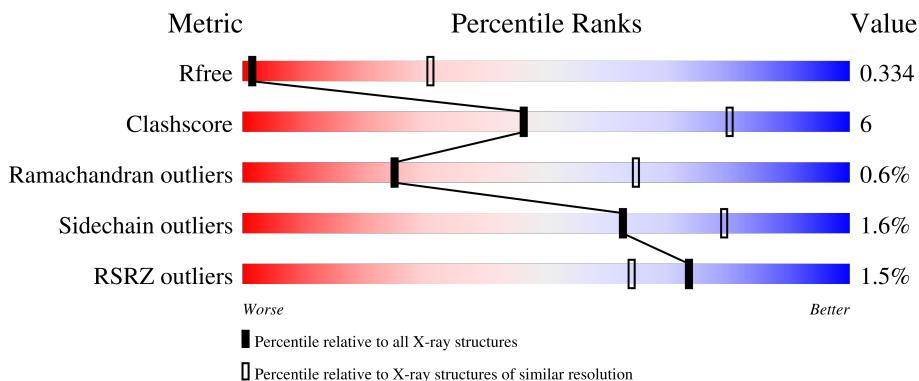

Metric	Whole archive (#Entries)	Similar resolution (#Entries, resolution range(Å))
$R_{free}$	130704	1014 (4.80-3.80)
Clashscore	141614	1077 (4.80-3.80)
Ramachandran outliers	138981	1029 (4.80-3.80)
Sidechain outliers	138945	1012 (4.80-3.80)
RSRZ outliers	127900	1075 (4.90-3.70)

The table below summarises the geometric issues observed across the polymeric chains and their fit to the electron density. The red, orange, yellow and green segments of the lower bar indicate the fraction of residues that contain outliers for  $\geq 3$ , 2, 1 and 0 types of geometric quality criteria respectively. A grey segment represents the fraction of residues that are not modelled. The numeric value for each fraction is indicated below the corresponding segment, with a dot representing fractions  $\leq 5\%$ . The upper red bar (where present) indicates the fraction of residues that have poor fit to the electron density. The numeric value is given above the bar.

Mol	Chain	Length	Quality of chain
1	H	226	83% 13% ..
2	L	218	89% 10% .
3	C	214	5% 88% 12%
4	D	229	2% 91% 8% .
5	A	383	% 72% 19% 9%

Continued on next page...

*Continued from previous page...*

Mol	Chain	Length	Quality of chain
6	B	2	 100%
6	G	2	 50% 50%
6	I	2	 50% 50%
7	E	5	 40% 60%
8	F	3	 100%

The following table lists non-polymeric compounds, carbohydrate monomers and non-standard residues in protein, DNA, RNA chains that are outliers for geometric or electron-density-fit criteria:

Mol	Type	Chain	Res	Chirality	Geometry	Clashes	Electron density
9	NAG	A	503	-	-	-	X
9	NAG	A	504	-	-	-	X

## 2 Entry composition [i](#)

There are 9 unique types of molecules in this entry. The entry contains 9705 atoms, of which 0 are hydrogens and 0 are deuteriums.

In the tables below, the ZeroOcc column contains the number of atoms modelled with zero occupancy, the AltConf column contains the number of residues with at least one atom in alternate conformation and the Trace column contains the number of residues modelled with at most 2 atoms.

- Molecule 1 is a protein called M4H2K1 Fab heavy chain.

Mol	Chain	Residues	Atoms					ZeroOcc	AltConf	Trace
			Total	C	N	O	S			
1	H	222	1670	1052	279	331	8	0	0	0

- Molecule 2 is a protein called M4H2K1 Fab light chain.

Mol	Chain	Residues	Atoms					ZeroOcc	AltConf	Trace
			Total	C	N	O	S			
2	L	218	1671	1045	284	334	8	0	0	0

- Molecule 3 is a protein called 17b Fab light chain.

Mol	Chain	Residues	Atoms					ZeroOcc	AltConf	Trace
			Total	C	N	O	S			
3	C	214	1646	1028	282	331	5	0	0	0

- Molecule 4 is a protein called 17b Fab heavy chain.

Mol	Chain	Residues	Atoms					ZeroOcc	AltConf	Trace
			Total	C	N	O	S			
4	D	227	1709	1078	287	339	5	0	1	0

- Molecule 5 is a protein called HIV-1 clade A BG505 gp120,HIV-1 clade A BG505 gp120.

Mol	Chain	Residues	Atoms					ZeroOcc	AltConf	Trace
			Total	C	N	O	S			
5	A	349	2727	1709	477	518	23	0	0	0

There are 4 discrepancies between the modelled and reference sequences:

Chain	Residue	Modelled	Actual	Comment	Reference
A	192	GLY	-	linker	UNP Q2N0S5
A	193	ALA	-	linker	UNP Q2N0S5

*Continued on next page...*

Continued from previous page...

Chain	Residue	Modelled	Actual	Comment	Reference
A	194	GLY	-	linker	UNP Q2N0S5
A	332	ASN	THR	conflict	UNP Q2N0S5

- Molecule 6 is an oligosaccharide called 2-acetamido-2-deoxy-beta-D-glucopyranose-(1-4)-2-acetamido-2-deoxy-beta-D-glucopyranose.



Mol	Chain	Residues	Atoms				ZeroOcc	AltConf	Trace
			Total	C	N	O			
6	B	2	28	16	2	10	0	0	0
6	G	2	28	16	2	10	0	0	0
6	I	2	28	16	2	10	0	0	0

- Molecule 7 is an oligosaccharide called alpha-D-mannopyranose-(1-3)-[alpha-D-mannopyranose-(1-6)]beta-D-mannopyranose-(1-4)-2-acetamido-2-deoxy-beta-D-glucopyranose-(1-4)-2-acetamido-2-deoxy-beta-D-glucopyranose.

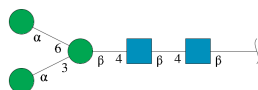

Mol	Chain	Residues	Atoms				ZeroOcc	AltConf	Trace
			Total	C	N	O			
7	E	5	61	34	2	25	0	0	0

- Molecule 8 is an oligosaccharide called beta-D-mannopyranose-(1-4)-2-acetamido-2-deoxy-beta-D-glucopyranose-(1-4)-2-acetamido-2-deoxy-beta-D-glucopyranose.

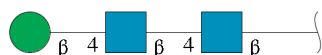

Mol	Chain	Residues	Atoms				ZeroOcc	AltConf	Trace
			Total	C	N	O			
8	F	3	39	22	2	15	0	0	0

- Molecule 9 is 2-acetamido-2-deoxy-beta-D-glucopyranose (three-letter code: NAG) (formula:  $C_8H_{15}NO_6$ ).

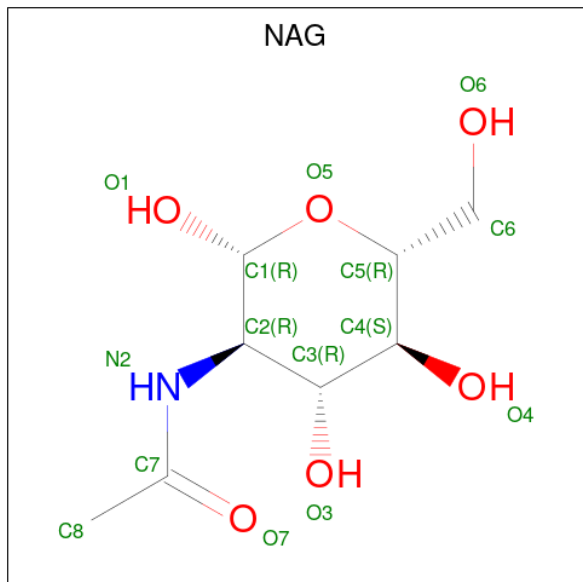

Mol	Chain	Residues	Atoms				ZeroOcc	AltConf
			Total	C	N	O		
9	A	1	Total	C	N	O	0	0
			14	8	1	5		
9	A	1	Total	C	N	O	0	0
			14	8	1	5		
9	A	1	Total	C	N	O	0	0
			14	8	1	5		
9	A	1	Total	C	N	O	0	0
			14	8	1	5		
9	A	1	Total	C	N	O	0	0
			14	8	1	5		
9	A	1	Total	C	N	O	0	0
			14	8	1	5		

### 3 Residue-property plots

These plots are drawn for all protein, RNA, DNA and oligosaccharide chains in the entry. The first graphic for a chain summarises the proportions of the various outlier classes displayed in the second graphic. The second graphic shows the sequence view annotated by issues in geometry and electron density. Residues are color-coded according to the number of geometric quality criteria for which they contain at least one outlier: green = 0, yellow = 1, orange = 2 and red = 3 or more. A red dot above a residue indicates a poor fit to the electron density ( $RSRZ > 2$ ). Stretches of 2 or more consecutive residues without any outlier are shown as a green connector. Residues present in the sample, but not in the model, are shown in grey.

- Molecule 1: M4H2K1 Fab heavy chain

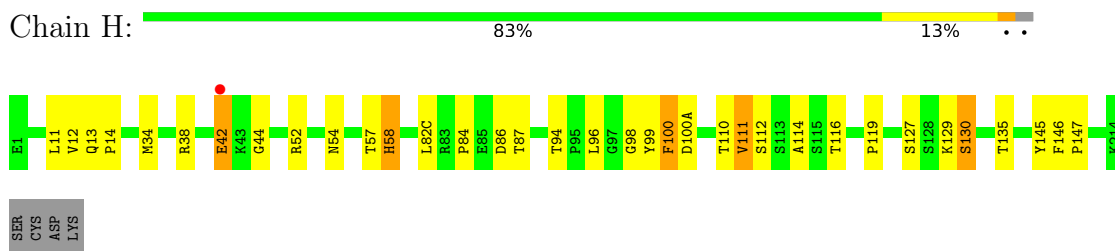

- Molecule 2: M4H2K1 Fab light chain

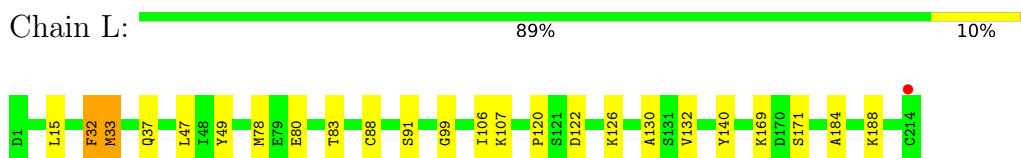

- Molecule 3: 17b Fab light chain

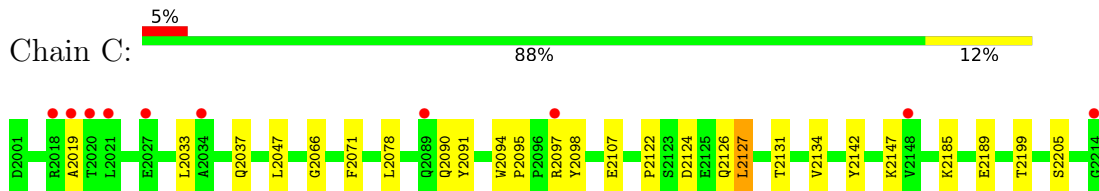

- Molecule 4: 17b Fab heavy chain

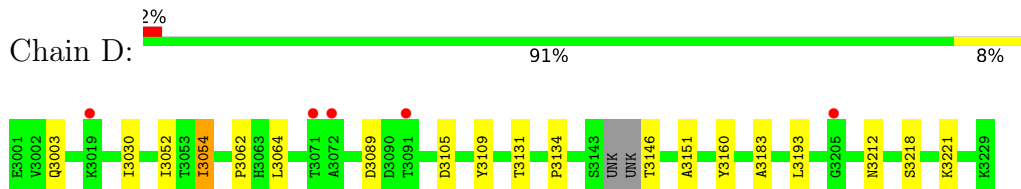

- Molecule 5: HIV-1 clade A BG505 gp120, HIV-1 clade A BG505 gp120



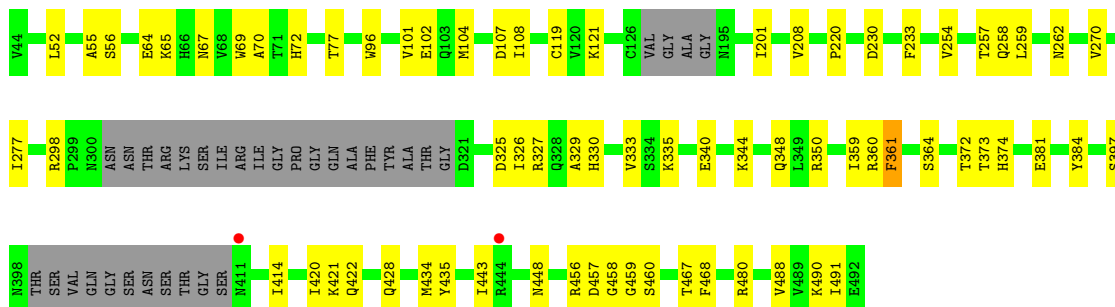

- Molecule 6: 2-acetamido-2-deoxy-beta-D-glucopyranose-(1-4)-2-acetamido-2-deoxy-beta-D-glucopyranose

Chain B: 100%

MAG1  
MAG2

- Molecule 6: 2-acetamido-2-deoxy-beta-D-glucopyranose-(1-4)-2-acetamido-2-deoxy-beta-D-glucopyranose

Chain G: 50% 50%

MAG1  
MAG2

- Molecule 6: 2-acetamido-2-deoxy-beta-D-glucopyranose-(1-4)-2-acetamido-2-deoxy-beta-D-glucopyranose

Chain I: 50% 50%

MAG1  
MAG2

- Molecule 7: alpha-D-mannopyranose-(1-3)-[alpha-D-mannopyranose-(1-6)]beta-D-mannopyranose-(1-4)-2-acetamido-2-deoxy-beta-D-glucopyranose-(1-4)-2-acetamido-2-deoxy-beta-D-glucopyranose

Chain E: 40% 60%

MAG1  
MAG2  
BMA3  
MAN4  
MAN5

- Molecule 8: beta-D-mannopyranose-(1-4)-2-acetamido-2-deoxy-beta-D-glucopyranose-(1-4)-2-acetamido-2-deoxy-beta-D-glucopyranose

Chain F: 100%

MAG1  
MAG2  
BMA3



## 4 Data and refinement statistics

Property	Value	Source
Space group	P 21 21 2	Depositor
Cell constants a, b, c, $\alpha$ , $\beta$ , $\gamma$	204.06Å 60.63Å 166.76Å 90.00° 90.00° 90.00°	Depositor
Resolution (Å)	43.04 – 4.30 43.04 – 4.30	Depositor EDS
% Data completeness (in resolution range)	84.0 (43.04-4.30) 84.0 (43.04-4.30)	Depositor EDS
$R_{merge}$	(Not available)	Depositor
$R_{sym}$	(Not available)	Depositor
$\langle I/\sigma(I) \rangle$ <sup>1</sup>	1.47 (at 4.28Å)	Xtrriage
Refinement program	PHENIX 1.16_3549	Depositor
R, $R_{free}$	0.302 , 0.334 0.302 , 0.334	Depositor DCC
$R_{free}$ test set	569 reflections (4.59%)	wwPDB-VP
Wilson B-factor (Å <sup>2</sup> )	138.7	Xtrriage
Anisotropy	0.366	Xtrriage
Bulk solvent $k_{sol}$ (e/Å <sup>3</sup> ), $B_{sol}$ (Å <sup>2</sup> )	0.23 , 103.9	EDS
L-test for twinning <sup>2</sup>	$\langle  L  \rangle = 0.44$ , $\langle L^2 \rangle = 0.26$	Xtrriage
Estimated twinning fraction	No twinning to report.	Xtrriage
$F_o, F_c$ correlation	0.83	EDS
Total number of atoms	9705	wwPDB-VP
Average B, all atoms (Å <sup>2</sup> )	169.0	wwPDB-VP

Xtrriage's analysis on translational NCS is as follows: *The largest off-origin peak in the Patterson function is 3.48% of the height of the origin peak. No significant pseudotranslation is detected.*

<sup>1</sup>Intensities estimated from amplitudes.

<sup>2</sup>Theoretical values of  $\langle |L| \rangle$ ,  $\langle L^2 \rangle$  for acentric reflections are 0.5, 0.333 respectively for untwinned datasets, and 0.375, 0.2 for perfectly twinned datasets.

## 5 Model quality [i](#)

### 5.1 Standard geometry [i](#)

Bond lengths and bond angles in the following residue types are not validated in this section: MAN, BMA, NAG

The Z score for a bond length (or angle) is the number of standard deviations the observed value is removed from the expected value. A bond length (or angle) with  $|Z| > 5$  is considered an outlier worth inspection. RMSZ is the root-mean-square of all Z scores of the bond lengths (or angles).

Mol	Chain	Bond lengths		Bond angles	
		RMSZ	# Z  >5	RMSZ	# Z  >5
1	H	0.36	0/1711	0.66	2/2328 (0.1%)
2	L	0.32	0/1708	0.56	0/2316
3	C	0.26	0/1683	0.52	1/2288 (0.0%)
4	D	0.28	0/1754	0.50	1/2389 (0.0%)
5	A	0.24	0/2785	0.43	0/3781
All	All	0.29	0/9641	0.53	4/13102 (0.0%)

There are no bond length outliers.

All (4) bond angle outliers are listed below:

Mol	Chain	Res	Type	Atoms	Z	Observed(°)	Ideal(°)
1	H	100	PHE	CB-CA-C	-5.57	99.27	110.40
3	C	2127	LEU	CA-CB-CG	5.37	127.65	115.30
4	D	3064	LEU	CB-CA-C	-5.11	100.49	110.20
1	H	58	HIS	CB-CA-C	5.09	120.58	110.40

There are no chirality outliers.

There are no planarity outliers.

### 5.2 Too-close contacts [i](#)

In the following table, the Non-H and H(model) columns list the number of non-hydrogen atoms and hydrogen atoms in the chain respectively. The H(added) column lists the number of hydrogen atoms added and optimized by MolProbity. The Clashes column lists the number of clashes within the asymmetric unit, whereas Symm-Clashes lists symmetry-related clashes.

Mol	Chain	Non-H	H(model)	H(added)	Clashes	Symm-Clashes
1	H	1670	0	1634	46	0
2	L	1671	0	1617	22	0

*Continued on next page...*

*Continued from previous page...*

Mol	Chain	Non-H	H(model)	H(added)	Clashes	Symm-Clashes
3	C	1646	0	1590	13	0
4	D	1709	0	1669	9	0
5	A	2727	0	2650	38	0
6	B	28	0	25	0	0
6	G	28	0	25	1	0
6	I	28	0	25	1	0
7	E	61	0	52	1	0
8	F	39	0	34	0	0
9	A	98	0	91	2	0
All	All	9705	0	9412	120	0

The all-atom clashscore is defined as the number of clashes found per 1000 atoms (including hydrogen atoms). The all-atom clashscore for this structure is 6.

All (120) close contacts within the same asymmetric unit are listed below, sorted by their clash magnitude.

Atom-1	Atom-2	Interatomic distance (Å)	Clash overlap (Å)
1:H:11:LEU:CD2	1:H:147:PRO:HG3	1.66	1.24
1:H:11:LEU:HD21	1:H:147:PRO:CG	1.71	1.20
1:H:11:LEU:HD11	1:H:147:PRO:HD3	1.22	1.08
1:H:84:PRO:HA	1:H:111:VAL:HG11	1.39	1.04
1:H:11:LEU:HD12	1:H:116:THR:HG22	1.39	1.02
1:H:11:LEU:HD11	1:H:147:PRO:CD	1.92	0.99
1:H:98:GLY:N	2:L:91:SER:HB2	1.79	0.97
1:H:98:GLY:H	2:L:91:SER:HB2	1.31	0.93
1:H:100:PHE:CE1	2:L:49:TYR:CD2	2.46	0.90
1:H:11:LEU:CD1	1:H:147:PRO:HD3	2.06	0.85
1:H:100:PHE:CE1	2:L:49:TYR:HD2	1.94	0.80
2:L:33:MET:HE2	2:L:88:CYS:HB2	1.69	0.72
1:H:14:PRO:HD3	1:H:112:SER:O	1.90	0.72
1:H:13:GLN:HA	1:H:112:SER:O	1.90	0.70
1:H:98:GLY:HA2	2:L:91:SER:O	1.92	0.69
2:L:37:GLN:HB2	2:L:47:LEU:HD11	1.74	0.67
1:H:11:LEU:CD1	1:H:116:THR:HG22	2.20	0.67
3:C:2037:GLN:HB2	3:C:2047:LEU:HD11	1.76	0.66
5:A:230:ASP:HB2	5:A:233:PHE:HB2	1.79	0.64
1:H:11:LEU:HD21	1:H:147:PRO:HG3	0.77	0.62
4:D:3030:ILE:HB	4:D:3054:ILE:HD12	1.81	0.62
1:H:130:SER:O	1:H:130:SER:OG	2.12	0.62
1:H:114:ALA:HB3	1:H:146:PHE:CE2	2.36	0.61
3:C:2097:ARG:HG2	4:D:3062:PRO:HD3	1.83	0.61

*Continued on next page...*

*Continued from previous page...*

Atom-1	Atom-2	Interatomic distance (Å)	Clash overlap (Å)
5:A:101:VAL:HG21	5:A:480:ARG:HG3	1.83	0.61
1:H:52:ARG:NH1	5:A:460:SER:O	2.33	0.60
1:H:98:GLY:H	2:L:91:SER:CB	2.09	0.59
9:A:505:NAG:H3	9:A:505:NAG:H83	1.84	0.58
1:H:98:GLY:CA	2:L:91:SER:O	2.50	0.58
1:H:11:LEU:HD12	1:H:116:THR:CG2	2.25	0.58
5:A:359:ILE:O	5:A:361:PHE:N	2.33	0.58
5:A:254:VAL:HG21	5:A:262:ASN:HB2	1.84	0.58
1:H:99:TYR:CD2	1:H:99:TYR:N	2.73	0.57
1:H:111:VAL:HG13	1:H:112:SER:H	1.70	0.57
2:L:15:LEU:HD21	2:L:106:ILE:HD13	1.87	0.56
1:H:98:GLY:N	2:L:91:SER:O	2.39	0.56
2:L:122:ASP:O	2:L:126:LYS:HG2	2.04	0.56
1:H:99:TYR:HD2	1:H:99:TYR:H	1.51	0.56
5:A:335:LYS:HB3	5:A:414:ILE:HG13	1.88	0.56
5:A:64:GLU:OE1	5:A:67:ASN:ND2	2.39	0.56
1:H:12:VAL:HG11	1:H:82(C):LEU:HD13	1.88	0.55
1:H:98:GLY:O	1:H:100:PHE:HD2	1.89	0.55
2:L:88:CYS:SG	2:L:99:GLY:HA3	2.47	0.55
1:H:114:ALA:HB3	1:H:146:PHE:CZ	2.43	0.54
1:H:111:VAL:HG13	1:H:112:SER:N	2.23	0.54
6:G:1:NAG:H83	6:G:1:NAG:H3	1.89	0.53
5:A:55:ALA:HB1	5:A:77:THR:HA	1.90	0.53
5:A:330:HIS:HE1	9:A:504:NAG:HN2	1.57	0.53
5:A:457:ASP:O	5:A:459:GLY:N	2.42	0.53
5:A:298:ARG:HG2	5:A:329:ALA:HB2	1.91	0.53
6:I:1:NAG:H3	6:I:1:NAG:H83	1.91	0.53
3:C:2122:PRO:HD3	3:C:2134:VAL:HG22	1.91	0.53
2:L:120:PRO:HD3	2:L:132:VAL:HG22	1.90	0.52
5:A:350:ARG:NH2	5:A:397:SER:HA	2.24	0.52
5:A:381:GLU:HG3	5:A:443:ILE:HD13	1.91	0.52
4:D:3134:PRO:HB3	4:D:3160:TYR:HB3	1.92	0.52
5:A:490:LYS:NZ	5:A:491:ILE:O	2.38	0.52
5:A:384:TYR:CG	5:A:421:LYS:HD3	2.46	0.51
5:A:64:GLU:HB3	5:A:67:ASN:HD22	1.75	0.51
5:A:270:VAL:HB	5:A:348:GLN:HG3	1.92	0.51
5:A:257:THR:O	5:A:259:LEU:N	2.44	0.51
2:L:184:ALA:O	2:L:188:LYS:HG2	2.12	0.50
1:H:11:LEU:CD2	1:H:110:THR:HB	2.42	0.50
5:A:333:VAL:HG13	5:A:414:ILE:HB	1.94	0.50
1:H:96:LEU:HG	1:H:96:LEU:O	2.11	0.50

*Continued on next page...*

*Continued from previous page...*

Atom-1	Atom-2	Interatomic distance (Å)	Clash overlap (Å)
2:L:32:PHE:CD2	2:L:32:PHE:N	2.80	0.50
5:A:361:PHE:CE2	5:A:468:PHE:HB2	2.46	0.49
5:A:65:LYS:HE2	5:A:208:VAL:HG11	1.94	0.49
5:A:119:CYS:N	5:A:434:MET:O	2.45	0.49
1:H:119:PRO:HB3	1:H:145:TYR:HB3	1.94	0.48
5:A:69:TRP:HA	5:A:72:HIS:CD2	2.49	0.48
1:H:57:THR:O	1:H:58:HIS:CG	2.67	0.48
5:A:121:LYS:HB2	5:A:201:ILE:HB	1.94	0.48
5:A:277:ILE:O	5:A:456:ARG:NH2	2.47	0.48
5:A:298:ARG:NH1	5:A:326:ILE:O	2.44	0.47
2:L:80:GLU:HB2	2:L:171:SER:OG	2.14	0.47
1:H:34:MET:SD	1:H:94:THR:HB	2.53	0.47
5:A:340:GLU:HG2	5:A:344:LYS:HE3	1.97	0.47
3:C:2124:ASP:O	3:C:2127:LEU:HG	2.14	0.47
4:D:3146:THR:HB	4:D:3151:ALA:HA	1.98	0.46
5:A:422:GLN:NE2	5:A:435:TYR:O	2.49	0.46
5:A:327:ARG:HB3	5:A:420:ILE:H	1.81	0.46
5:A:428:GLN:OE1	5:A:428:GLN:N	2.48	0.46
1:H:54:ASN:OD1	1:H:54:ASN:O	2.34	0.46
5:A:327:ARG:NH1	5:A:422:GLN:OE1	2.49	0.45
5:A:96:TRP:HA	5:A:480:ARG:HD3	1.99	0.45
5:A:364:SER:HB3	5:A:372:THR:HA	1.98	0.45
4:D:3105:ASP:OD1	4:D:3105:ASP:N	2.46	0.45
1:H:38:ARG:NH1	1:H:86:ASP:HA	2.32	0.44
3:C:2094:TRP:HA	3:C:2095:PRO:C	2.37	0.44
1:H:99:TYR:O	1:H:99:TYR:CG	2.70	0.44
3:C:2147:LYS:HB3	3:C:2199:THR:HB	1.99	0.44
3:C:2107:GLU:OE1	3:C:2142:TYR:OH	2.14	0.44
2:L:78:MET:HE2	2:L:106:ILE:HD11	2.00	0.44
4:D:3183:ALA:HA	4:D:3193:LEU:HB3	1.98	0.44
1:H:129:LYS:HG3	1:H:129:LYS:O	2.18	0.43
5:A:56:SER:OG	5:A:70:ALA:HB1	2.18	0.43
5:A:254:VAL:HG13	7:E:1:NAG:H82	2.01	0.43
2:L:83:THR:HG23	2:L:106:ILE:HD12	2.01	0.43
1:H:127:SER:HB3	1:H:130:SER:CB	2.49	0.42
5:A:52:LEU:HD11	5:A:488:VAL:HG21	2.01	0.42
4:D:3052:ILE:HG23	4:D:3109:TYR:CZ	2.54	0.42
4:D:3131:THR:HG22	4:D:3218:SER:HB3	2.01	0.42
1:H:127:SER:HB3	1:H:130:SER:HB3	2.00	0.42
3:C:2019:ALA:HB2	3:C:2078:LEU:HD11	2.01	0.42
3:C:2066:GLY:HA3	3:C:2071:PHE:HA	2.02	0.42

*Continued on next page...*

Continued from previous page...

Atom-1	Atom-2	Interatomic distance (Å)	Clash overlap (Å)
4:D:3212:ASN:HB3	4:D:3221:LYS:HE2	2.02	0.42
1:H:11:LEU:HD23	1:H:110:THR:HB	2.01	0.41
2:L:107:LYS:HA	2:L:140:TYR:OH	2.19	0.41
1:H:100:PHE:O	2:L:49:TYR:CD2	2.73	0.41
3:C:2126:GLN:HG2	3:C:2131:THR:O	2.21	0.41
5:A:104:MET:O	5:A:108:ILE:HG12	2.20	0.41
1:H:87:THR:OG1	1:H:111:VAL:HG12	2.20	0.41
3:C:2033:LEU:HG	3:C:2071:PHE:CD1	2.55	0.41
1:H:42:GLU:HG2	1:H:44:GLY:H	1.86	0.41
5:A:259:LEU:HB2	5:A:374:HIS:CE1	2.56	0.41
3:C:2091:TYR:HA	3:C:2098:TYR:CD1	2.56	0.41
1:H:100:PHE:CD2	1:H:100:PHE:N	2.89	0.41
3:C:2185:LYS:HE2	3:C:2189:GLU:OE2	2.20	0.40
2:L:120:PRO:HG3	2:L:130:ALA:HB1	2.04	0.40

There are no symmetry-related clashes.

## 5.3 Torsion angles [i](#)

### 5.3.1 Protein backbone [i](#)

In the following table, the Percentiles column shows the percent Ramachandran outliers of the chain as a percentile score with respect to all X-ray entries followed by that with respect to entries of similar resolution.

The Analysed column shows the number of residues for which the backbone conformation was analysed, and the total number of residues.

Mol	Chain	Analysed	Favoured	Allowed	Outliers	Percentiles	
1	H	220/226 (97%)	207 (94%)	10 (4%)	3 (1%)	11	47
2	L	216/218 (99%)	210 (97%)	6 (3%)	0	100	100
3	C	212/214 (99%)	203 (96%)	9 (4%)	0	100	100
4	D	224/229 (98%)	219 (98%)	5 (2%)	0	100	100
5	A	341/383 (89%)	312 (92%)	25 (7%)	4 (1%)	13	50
All	All	1213/1270 (96%)	1151 (95%)	55 (4%)	7 (1%)	25	65

All (7) Ramachandran outliers are listed below:

Mol	Chain	Res	Type
1	H	135	THR
1	H	100(A)	ASP
1	H	111	VAL
5	A	458	GLY
5	A	360	ARG
5	A	258	GLN
5	A	220	PRO

### 5.3.2 Protein sidechains [i](#)

In the following table, the Percentiles column shows the percent sidechain outliers of the chain as a percentile score with respect to all X-ray entries followed by that with respect to entries of similar resolution.

The Analysed column shows the number of residues for which the sidechain conformation was analysed, and the total number of residues.

Mol	Chain	Analysed	Rotameric	Outliers	Percentiles	
1	H	189/193 (98%)	187 (99%)	2 (1%)	73	85
2	L	188/188 (100%)	185 (98%)	3 (2%)	62	79
3	C	184/184 (100%)	182 (99%)	2 (1%)	73	85
4	D	192/191 (100%)	189 (98%)	3 (2%)	62	79
5	A	310/334 (93%)	303 (98%)	7 (2%)	50	70
All	All	1063/1090 (98%)	1046 (98%)	17 (2%)	62	79

All (17) residues with a non-rotameric sidechain are listed below:

Mol	Chain	Res	Type
1	H	42	GLU
1	H	130	SER
2	L	32	PHE
2	L	33	MET
2	L	169	LYS
3	C	2090	GLN
3	C	2205	SER
4	D	3003	GLN
4	D	3054	ILE
4	D	3089	ASP
5	A	102	GLU
5	A	107	ASP
5	A	325	ASP

*Continued on next page...*

*Continued from previous page...*

Mol	Chain	Res	Type
5	A	361	PHE
5	A	373	THR
5	A	448	ASN
5	A	467	THR

Sometimes sidechains can be flipped to improve hydrogen bonding and reduce clashes. There are no such sidechains identified.

### 5.3.3 RNA [i](#)

There are no RNA molecules in this entry.

## 5.4 Non-standard residues in protein, DNA, RNA chains [i](#)

There are no non-standard protein/DNA/RNA residues in this entry.

## 5.5 Carbohydrates [i](#)

14 monosaccharides are modelled in this entry.

In the following table, the Counts columns list the number of bonds (or angles) for which Mogul statistics could be retrieved, the number of bonds (or angles) that are observed in the model and the number of bonds (or angles) that are defined in the Chemical Component Dictionary. The Link column lists molecule types, if any, to which the group is linked. The Z score for a bond length (or angle) is the number of standard deviations the observed value is removed from the expected value. A bond length (or angle) with  $|Z| > 2$  is considered an outlier worth inspection. RMSZ is the root-mean-square of all Z scores of the bond lengths (or angles).

Mol	Type	Chain	Res	Link	Bond lengths			Bond angles		
					Counts	RMSZ	$\# Z  > 2$	Counts	RMSZ	$\# Z  > 2$
6	NAG	B	1	6,5	14,14,15	0.20	0	17,19,21	0.50	0
6	NAG	B	2	6	14,14,15	0.22	0	17,19,21	0.44	0
7	NAG	E	1	7,5	14,14,15	0.24	0	17,19,21	0.39	0
7	NAG	E	2	7	14,14,15	0.24	0	17,19,21	0.52	0
7	BMA	E	3	7	11,11,12	0.60	0	15,15,17	0.78	0
7	MAN	E	4	7	11,11,12	0.69	0	15,15,17	1.07	2 (13%)
7	MAN	E	5	7	11,11,12	0.68	0	15,15,17	1.07	2 (13%)
8	NAG	F	1	8,5	14,14,15	0.29	0	17,19,21	0.58	0
8	NAG	F	2	8	14,14,15	0.27	0	17,19,21	0.54	0
8	BMA	F	3	8	11,11,12	0.62	0	15,15,17	0.79	0
6	NAG	G	1	6,5	14,14,15	0.45	0	17,19,21	1.29	1 (5%)



Mol	Type	Chain	Res	Link	Bond lengths			Bond angles		
					Counts	RMSZ	# Z  > 2	Counts	RMSZ	# Z  > 2
6	NAG	G	2	6	14,14,15	0.25	0	17,19,21	0.41	0
6	NAG	I	1	6,5	14,14,15	0.38	0	17,19,21	1.33	2 (11%)
6	NAG	I	2	6	14,14,15	0.23	0	17,19,21	0.45	0

In the following table, the Chirals column lists the number of chiral outliers, the number of chiral centers analysed, the number of these observed in the model and the number defined in the Chemical Component Dictionary. Similar counts are reported in the Torsion and Rings columns. '-' means no outliers of that kind were identified.

Mol	Type	Chain	Res	Link	Chirals	Torsions	Rings
6	NAG	B	1	6,5	-	4/6/23/26	0/1/1/1
6	NAG	B	2	6	-	2/6/23/26	0/1/1/1
7	NAG	E	1	7,5	-	2/6/23/26	0/1/1/1
7	NAG	E	2	7	-	3/6/23/26	0/1/1/1
7	BMA	E	3	7	-	1/2/19/22	0/1/1/1
7	MAN	E	4	7	-	1/2/19/22	0/1/1/1
7	MAN	E	5	7	-	1/2/19/22	0/1/1/1
8	NAG	F	1	8,5	-	4/6/23/26	0/1/1/1
8	NAG	F	2	8	-	3/6/23/26	0/1/1/1
8	BMA	F	3	8	-	1/2/19/22	0/1/1/1
6	NAG	G	1	6,5	-	4/6/23/26	0/1/1/1
6	NAG	G	2	6	-	2/6/23/26	0/1/1/1
6	NAG	I	1	6,5	-	5/6/23/26	0/1/1/1
6	NAG	I	2	6	-	1/6/23/26	0/1/1/1

There are no bond length outliers.

All (7) bond angle outliers are listed below:

Mol	Chain	Res	Type	Atoms	Z	Observed(°)	Ideal(°)
6	I	1	NAG	C2-N2-C7	4.44	129.22	122.90
6	G	1	NAG	C2-N2-C7	4.28	129.00	122.90
7	E	5	MAN	C1-O5-C5	2.40	115.44	112.19
7	E	4	MAN	C1-O5-C5	2.36	115.38	112.19
6	I	1	NAG	C1-C2-N2	2.32	114.45	110.49
7	E	5	MAN	O2-C2-C3	-2.25	105.64	110.14
7	E	4	MAN	O2-C2-C3	-2.21	105.71	110.14

There are no chirality outliers.

All (34) torsion outliers are listed below:

Mol	Chain	Res	Type	Atoms
7	E	2	NAG	O5-C5-C6-O6
8	F	1	NAG	O5-C5-C6-O6
6	B	2	NAG	O5-C5-C6-O6
8	F	2	NAG	O5-C5-C6-O6
7	E	1	NAG	C4-C5-C6-O6
7	E	1	NAG	O5-C5-C6-O6
7	E	2	NAG	C4-C5-C6-O6
8	F	1	NAG	C4-C5-C6-O6
6	B	1	NAG	O5-C5-C6-O6
6	G	1	NAG	C8-C7-N2-C2
6	G	1	NAG	O7-C7-N2-C2
6	I	1	NAG	C8-C7-N2-C2
6	I	1	NAG	O7-C7-N2-C2
6	B	1	NAG	C4-C5-C6-O6
6	I	1	NAG	O5-C5-C6-O6
6	G	2	NAG	O5-C5-C6-O6
7	E	5	MAN	O5-C5-C6-O6
6	B	2	NAG	C4-C5-C6-O6
8	F	2	NAG	C4-C5-C6-O6
7	E	3	BMA	O5-C5-C6-O6
7	E	4	MAN	O5-C5-C6-O6
6	I	2	NAG	O5-C5-C6-O6
6	G	1	NAG	O5-C5-C6-O6
8	F	3	BMA	O5-C5-C6-O6
6	I	1	NAG	C4-C5-C6-O6
6	B	1	NAG	C3-C2-N2-C7
6	I	1	NAG	C3-C2-N2-C7
7	E	2	NAG	C3-C2-N2-C7
8	F	2	NAG	C3-C2-N2-C7
6	G	2	NAG	C4-C5-C6-O6
6	B	1	NAG	C1-C2-N2-C7
6	G	1	NAG	C3-C2-N2-C7
8	F	1	NAG	C3-C2-N2-C7
8	F	1	NAG	C1-C2-N2-C7

There are no ring outliers.

3 monomers are involved in 3 short contacts:

Mol	Chain	Res	Type	Clashes	Symm-Clashes
6	G	1	NAG	1	0
6	I	1	NAG	1	0
7	E	1	NAG	1	0

The following is a two-dimensional graphical depiction of Mogul quality analysis of bond lengths, bond angles, torsion angles, and ring geometry for oligosaccharide.

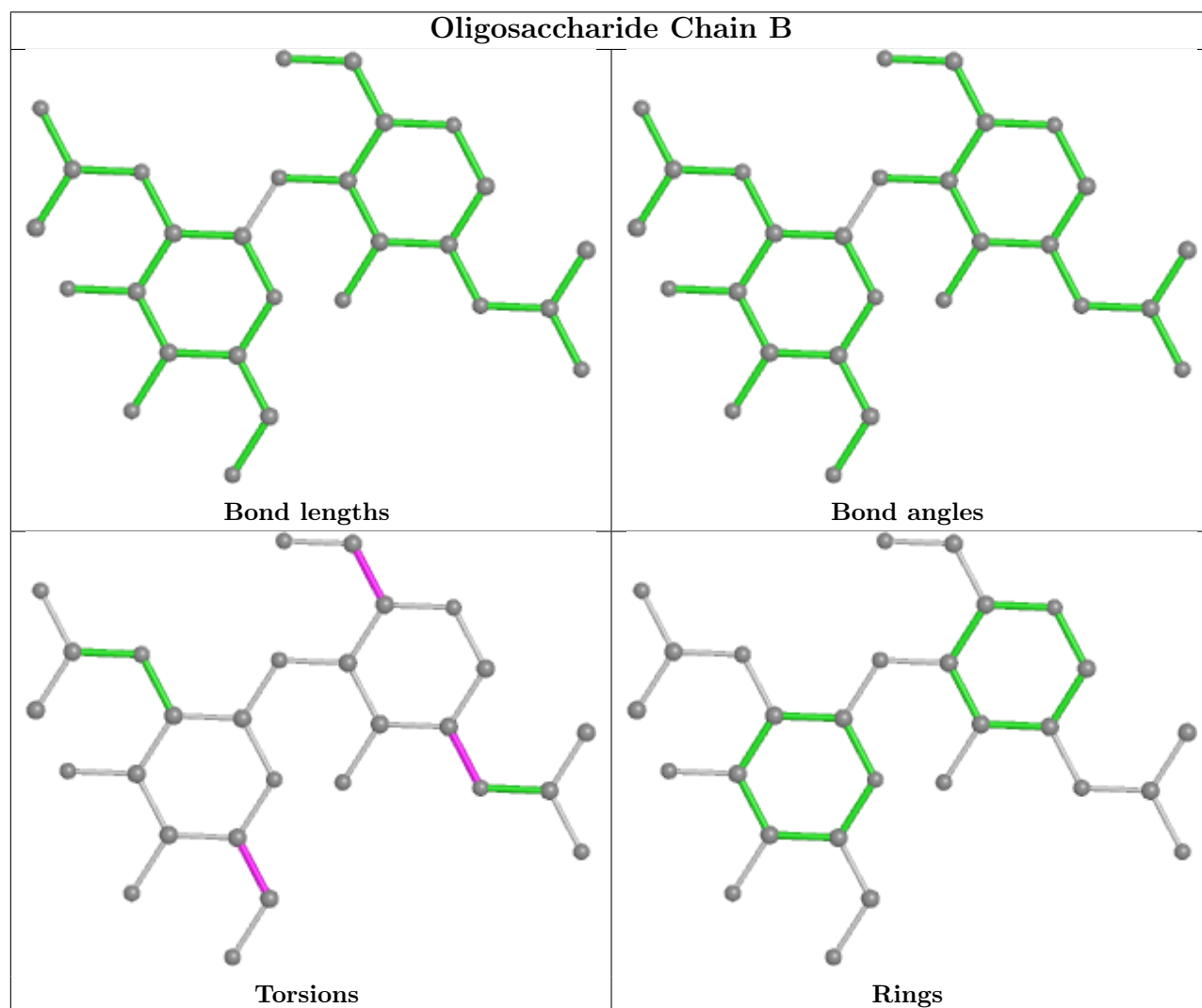

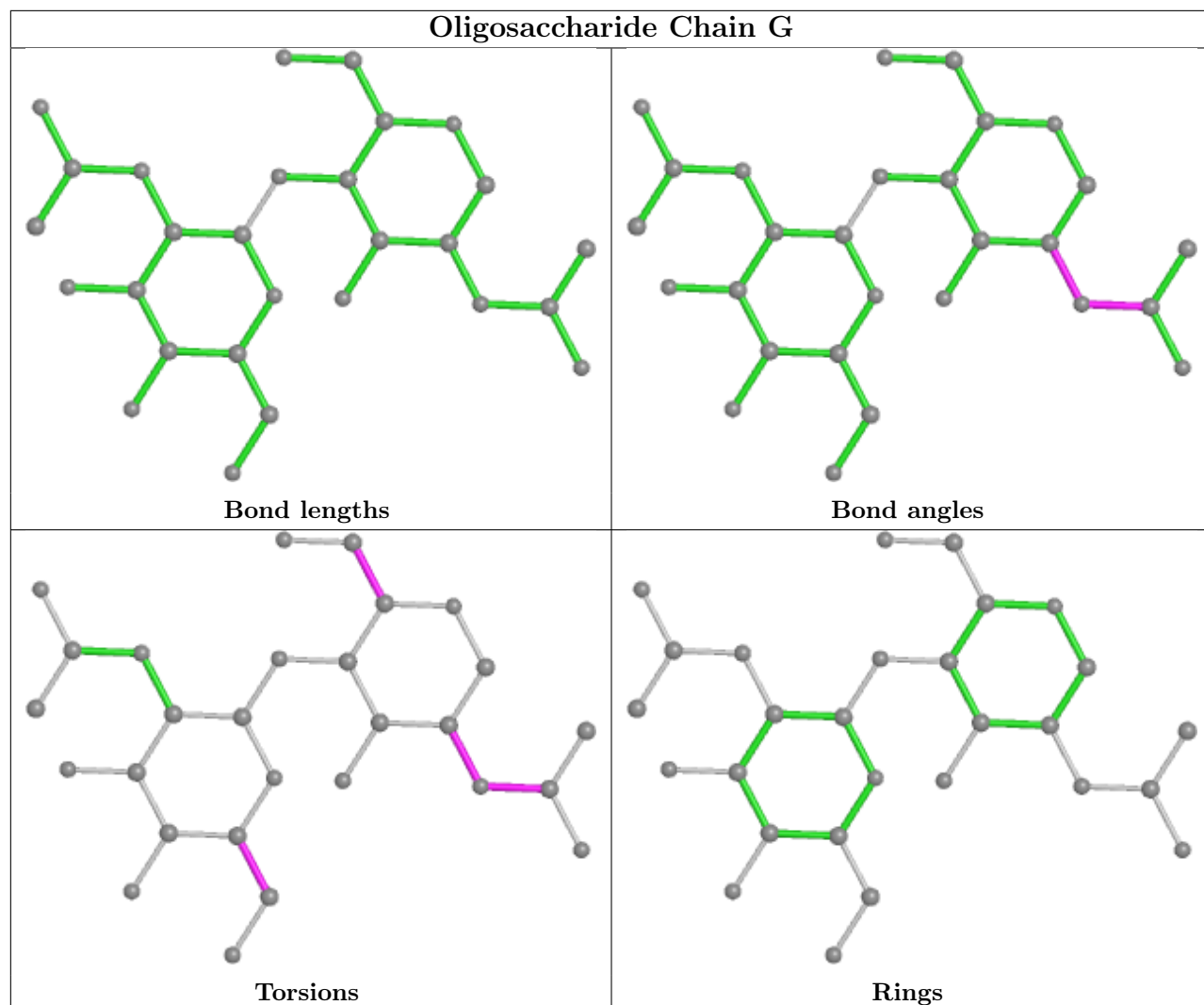

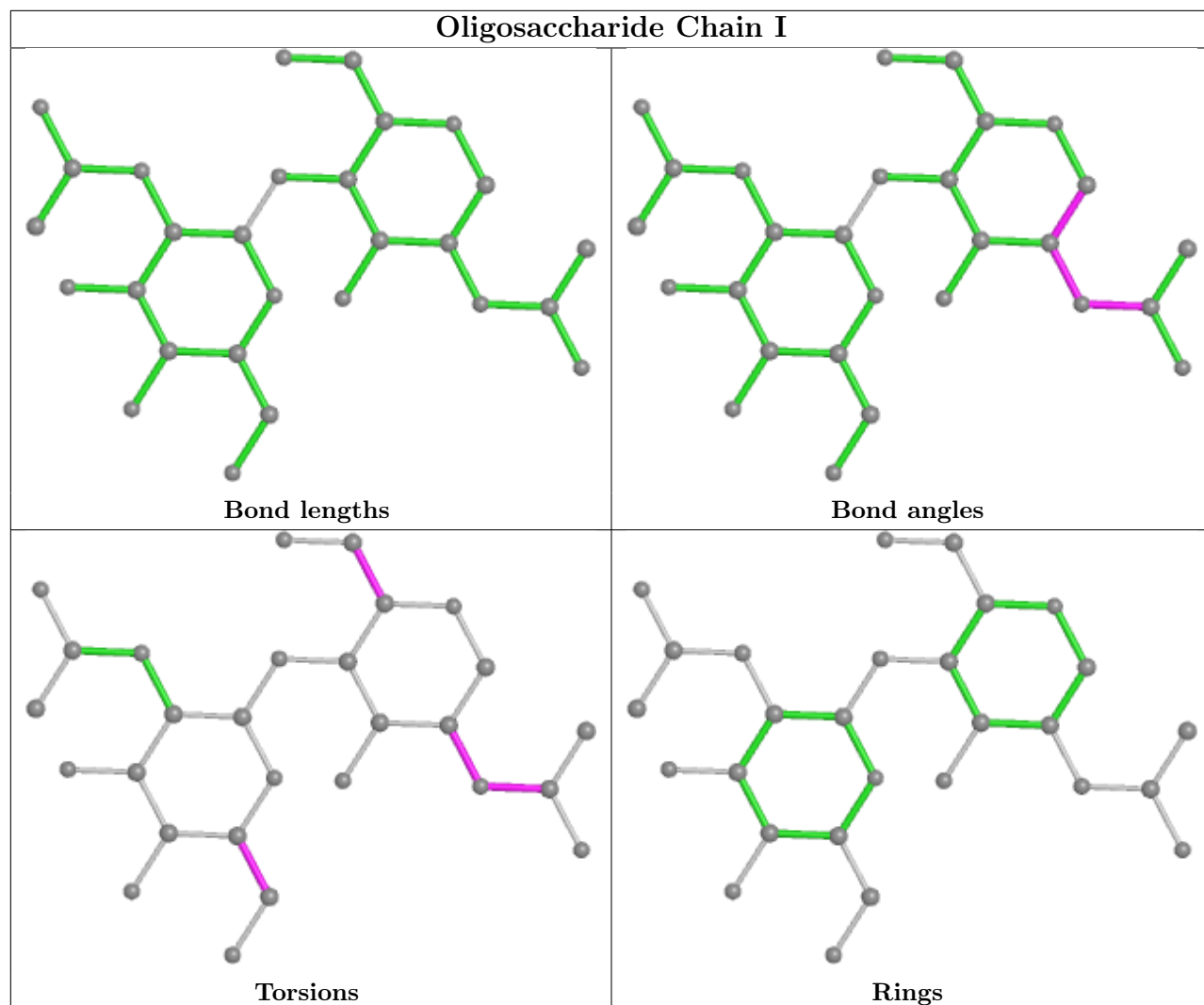

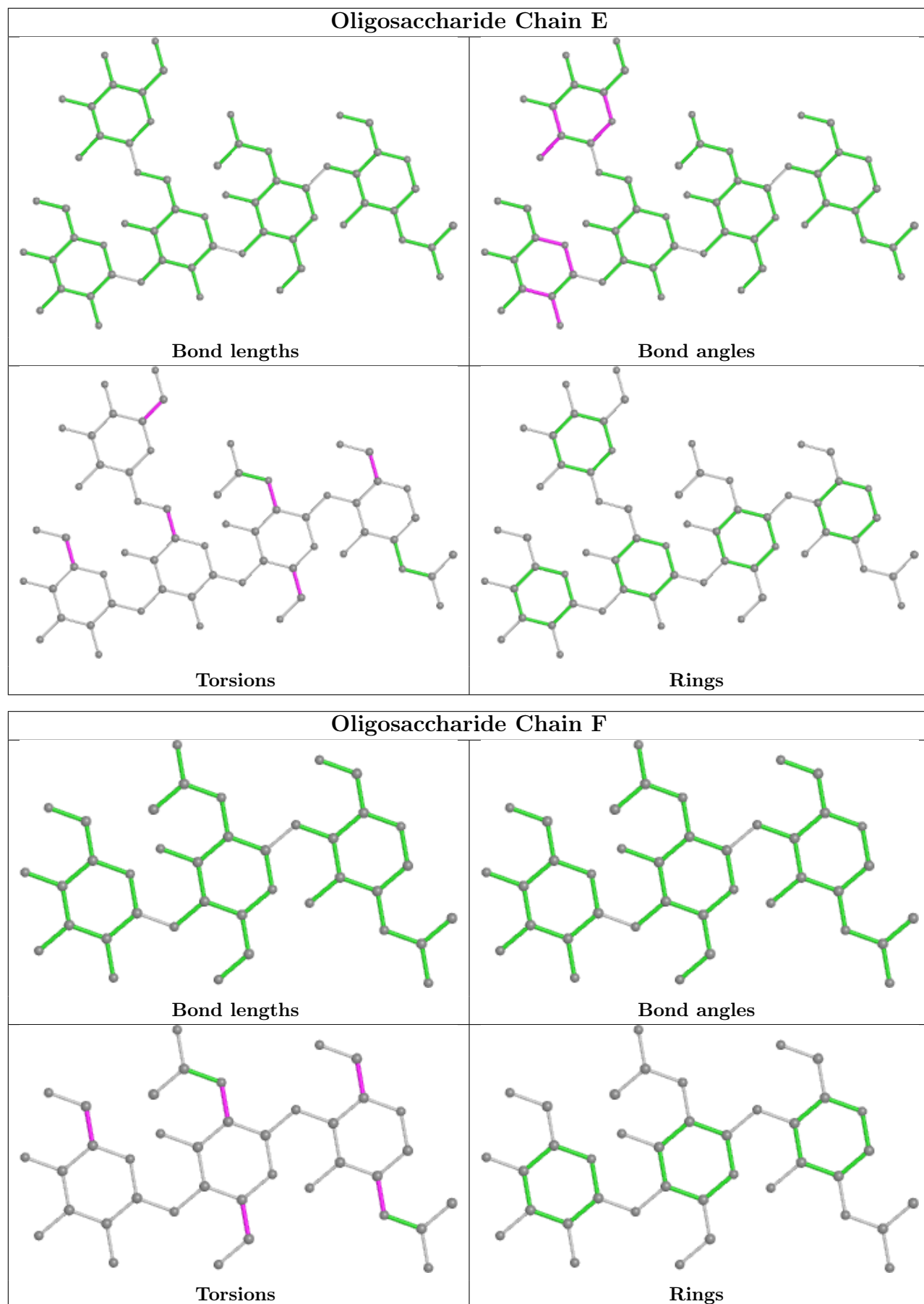

## 5.6 Ligand geometry

7 ligands are modelled in this entry.

In the following table, the Counts columns list the number of bonds (or angles) for which Mogul statistics could be retrieved, the number of bonds (or angles) that are observed in the model and the number of bonds (or angles) that are defined in the Chemical Component Dictionary. The Link column lists molecule types, if any, to which the group is linked. The Z score for a bond length (or angle) is the number of standard deviations the observed value is removed from the expected value. A bond length (or angle) with  $|Z| > 2$  is considered an outlier worth inspection. RMSZ is the root-mean-square of all Z scores of the bond lengths (or angles).

Mol	Type	Chain	Res	Link	Bond lengths			Bond angles		
					Counts	RMSZ	# Z  > 2	Counts	RMSZ	# Z  > 2
9	NAG	A	503	5	14,14,15	0.38	0	17,19,21	0.53	0
9	NAG	A	507	5	14,14,15	0.26	0	17,19,21	0.41	0
9	NAG	A	502	5	14,14,15	0.26	0	17,19,21	0.44	0
9	NAG	A	501	5	14,14,15	0.24	0	17,19,21	0.45	0
9	NAG	A	506	5	14,14,15	0.21	0	17,19,21	0.45	0
9	NAG	A	504	5	14,14,15	0.22	0	17,19,21	0.41	0
9	NAG	A	505	5	14,14,15	0.54	0	17,19,21	1.23	1 (5%)

In the following table, the Chirals column lists the number of chiral outliers, the number of chiral centers analysed, the number of these observed in the model and the number defined in the Chemical Component Dictionary. Similar counts are reported in the Torsion and Rings columns. '-' means no outliers of that kind were identified.

Mol	Type	Chain	Res	Link	Chirals	Torsions	Rings
9	NAG	A	503	5	-	3/6/23/26	0/1/1/1
9	NAG	A	507	5	-	2/6/23/26	0/1/1/1
9	NAG	A	502	5	-	2/6/23/26	0/1/1/1
9	NAG	A	501	5	-	0/6/23/26	0/1/1/1
9	NAG	A	506	5	-	0/6/23/26	0/1/1/1
9	NAG	A	504	5	-	0/6/23/26	0/1/1/1
9	NAG	A	505	5	-	5/6/23/26	0/1/1/1

There are no bond length outliers.

All (1) bond angle outliers are listed below:

Mol	Chain	Res	Type	Atoms	Z	Observed(°)	Ideal(°)
9	A	505	NAG	C2-N2-C7	4.24	128.94	122.90

There are no chirality outliers.

All (12) torsion outliers are listed below:

Mol	Chain	Res	Type	Atoms
9	A	505	NAG	C4-C5-C6-O6
9	A	505	NAG	C8-C7-N2-C2
9	A	505	NAG	O7-C7-N2-C2
9	A	505	NAG	O5-C5-C6-O6
9	A	502	NAG	O5-C5-C6-O6
9	A	503	NAG	C4-C5-C6-O6
9	A	502	NAG	C4-C5-C6-O6
9	A	503	NAG	O5-C5-C6-O6
9	A	507	NAG	C4-C5-C6-O6
9	A	507	NAG	O5-C5-C6-O6
9	A	503	NAG	C3-C2-N2-C7
9	A	505	NAG	C3-C2-N2-C7

There are no ring outliers.

2 monomers are involved in 2 short contacts:

Mol	Chain	Res	Type	Clashes	Symm-Clashes
9	A	504	NAG	1	0
9	A	505	NAG	1	0

## 5.7 Other polymers [i](#)

There are no such residues in this entry.

## 5.8 Polymer linkage issues [i](#)

There are no chain breaks in this entry.



## 6 Fit of model and data [i](#)

### 6.1 Protein, DNA and RNA chains [i](#)

In the following table, the column labelled ‘#RSRZ > 2’ contains the number (and percentage) of RSRZ outliers, followed by percent RSRZ outliers for the chain as percentile scores relative to all X-ray entries and entries of similar resolution. The OWAB column contains the minimum, median, 95<sup>th</sup> percentile and maximum values of the occupancy-weighted average B-factor per residue. The column labelled ‘Q < 0.9’ lists the number of (and percentage) of residues with an average occupancy less than 0.9.

Mol	Chain	Analysed	<RSRZ>	#RSRZ>2	OWAB(Å <sup>2</sup> )	Q<0.9
1	H	222/226 (98%)	-0.20	1 (0%) 91 86	100, 134, 157, 170	0
2	L	218/218 (100%)	-0.33	1 (0%) 91 86	95, 133, 159, 200	0
3	C	214/214 (100%)	0.12	10 (4%) 31 26	156, 198, 224, 234	0
4	D	227/229 (99%)	0.08	5 (2%) 62 52	181, 201, 217, 227	0
5	A	349/383 (91%)	-0.17	2 (0%) 89 84	142, 184, 205, 221	0
All	All	1230/1270 (96%)	-0.11	19 (1%) 73 64	95, 181, 214, 234	0

All (19) RSRZ outliers are listed below:

Mol	Chain	Res	Type	RSRZ
3	C	2097	ARG	4.2
3	C	2214	GLY	3.8
5	A	444	ARG	3.6
5	A	411	ASN	3.1
4	D	3072	ALA	3.0
2	L	214	CYS	3.0
4	D	3205	GLY	3.0
3	C	2027	GLU	2.9
3	C	2089	GLN	2.6
4	D	3071	THR	2.6
3	C	2034	ALA	2.5
3	C	2019	ALA	2.5
3	C	2148	VAL	2.4
3	C	2020	THR	2.3
3	C	2018	ARG	2.3
4	D	3019	LYS	2.2
4	D	3091	THR	2.1
1	H	42	GLU	2.0
3	C	2021	LEU	2.0

## 6.2 Non-standard residues in protein, DNA, RNA chains [i](#)

There are no non-standard protein/DNA/RNA residues in this entry.

## 6.3 Carbohydrates [i](#)

In the following table, the Atoms column lists the number of modelled atoms in the group and the number defined in the chemical component dictionary. The B-factors column lists the minimum, median, 95<sup>th</sup> percentile and maximum values of B factors of atoms in the group. The column labelled 'Q< 0.9' lists the number of atoms with occupancy less than 0.9.

Mol	Type	Chain	Res	Atoms	RSCC	RSR	B-factors(Å <sup>2</sup> )	Q<0.9
8	BMA	F	3	11/12	0.76	0.30	94,97,102,103	0
8	NAG	F	1	14/15	0.78	0.27	93,96,99,100	0
8	NAG	F	2	14/15	0.81	0.47	94,97,100,103	0
6	NAG	G	2	14/15	0.83	0.46	106,116,120,122	0
6	NAG	G	1	14/15	0.84	0.22	102,108,113,114	0
7	MAN	E	5	11/12	0.86	0.29	142,145,148,150	0
6	NAG	B	2	14/15	0.88	0.31	49,54,59,60	0
6	NAG	I	2	14/15	0.88	0.32	32,32,32,32	0
7	NAG	E	2	14/15	0.89	0.20	123,126,130,132	0
6	NAG	I	1	14/15	0.90	0.23	32,32,32,32	0
7	MAN	E	4	11/12	0.90	0.21	135,137,140,141	0
6	NAG	B	1	14/15	0.93	0.16	60,64,68,70	0
7	BMA	E	3	11/12	0.94	0.10	133,136,139,139	0
7	NAG	E	1	14/15	0.94	0.16	111,117,120,120	0

The following is a graphical depiction of the model fit to experimental electron density for oligosaccharide. Each fit is shown from different orientation to approximate a three-dimensional view.

**Electron density around Chain B:**

$2mF_o-DF_c$  (at 0.7 rmsd) in gray  
 $mF_o-DF_c$  (at 3 rmsd) in purple (negative)  
and green (positive)

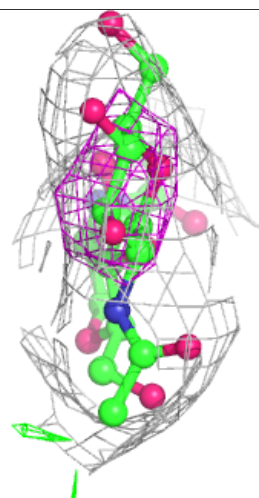
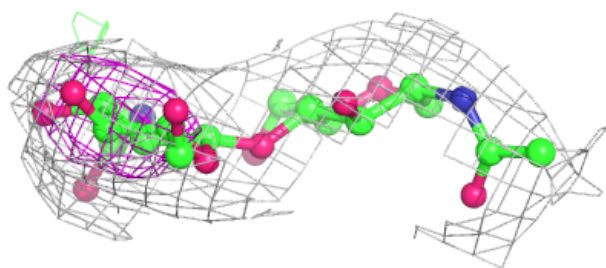
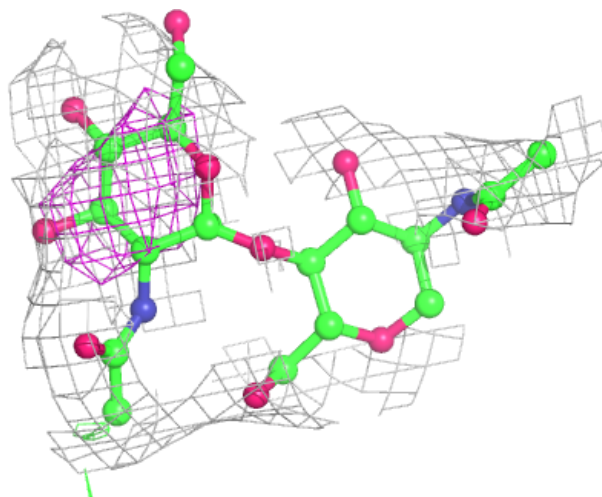

**Electron density around Chain G:**

$2mF_o-DF_c$  (at 0.7 rmsd) in gray  
 $mF_o-DF_c$  (at 3 rmsd) in purple (negative)  
and green (positive)

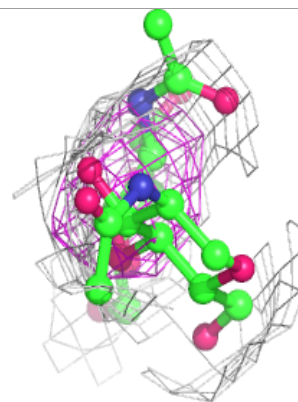
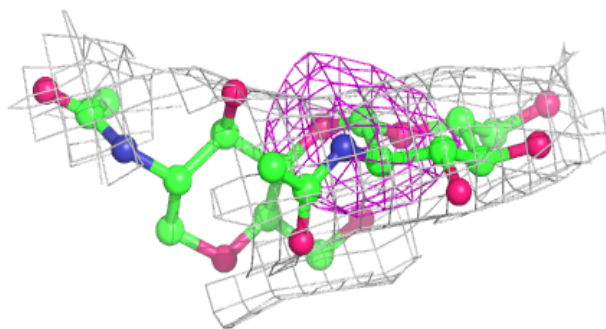
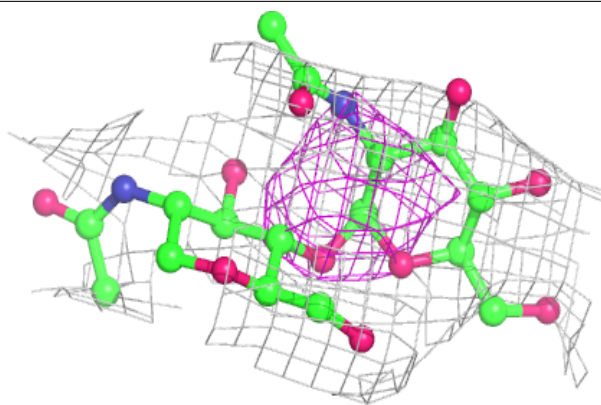

**Electron density around Chain I:**

$2mF_o-DF_c$  (at 0.7 rmsd) in gray  
 $mF_o-DF_c$  (at 3 rmsd) in purple (negative)  
and green (positive)

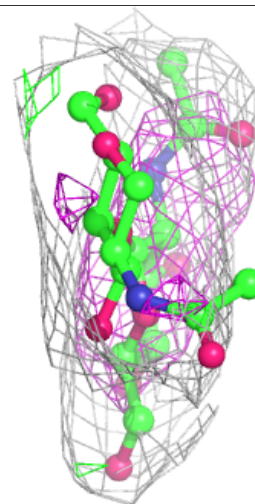
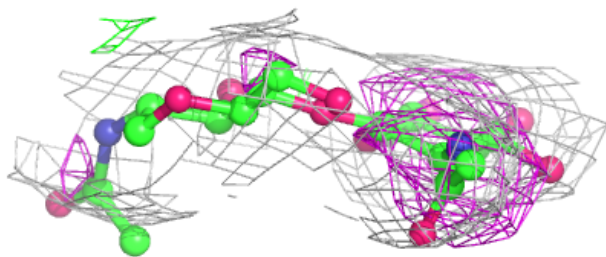
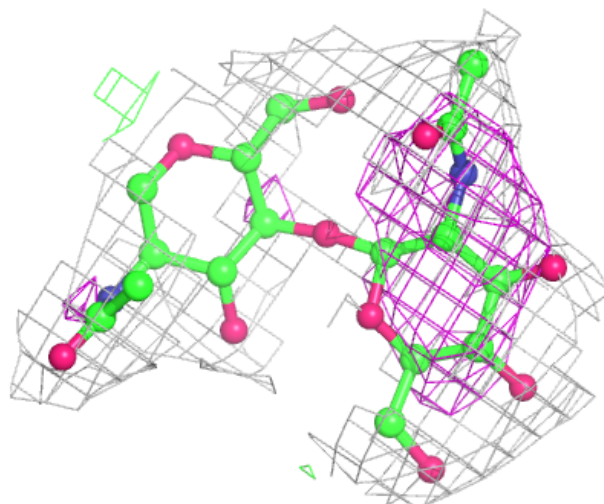

**Electron density around Chain E:**

$2mF_o-DF_c$  (at 0.7 rmsd) in gray  
 $mF_o-DF_c$  (at 3 rmsd) in purple (negative)  
and green (positive)

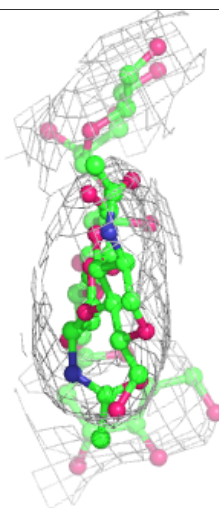
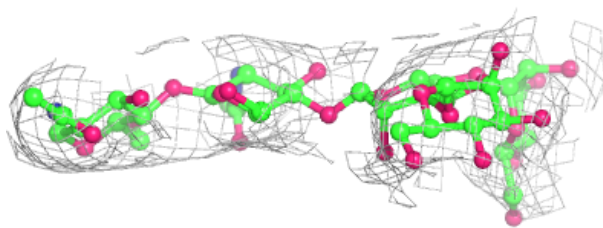
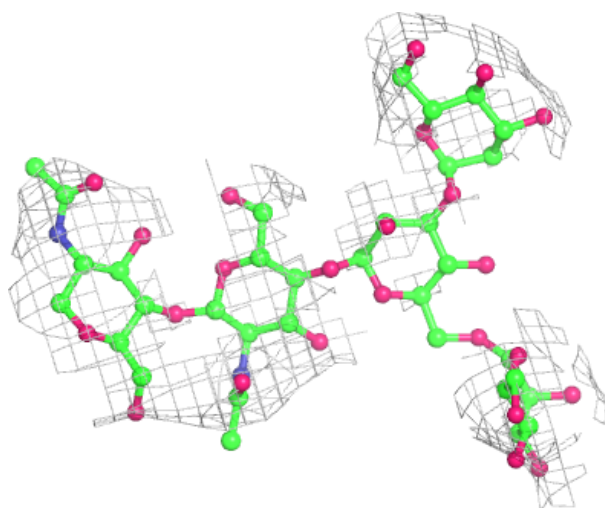

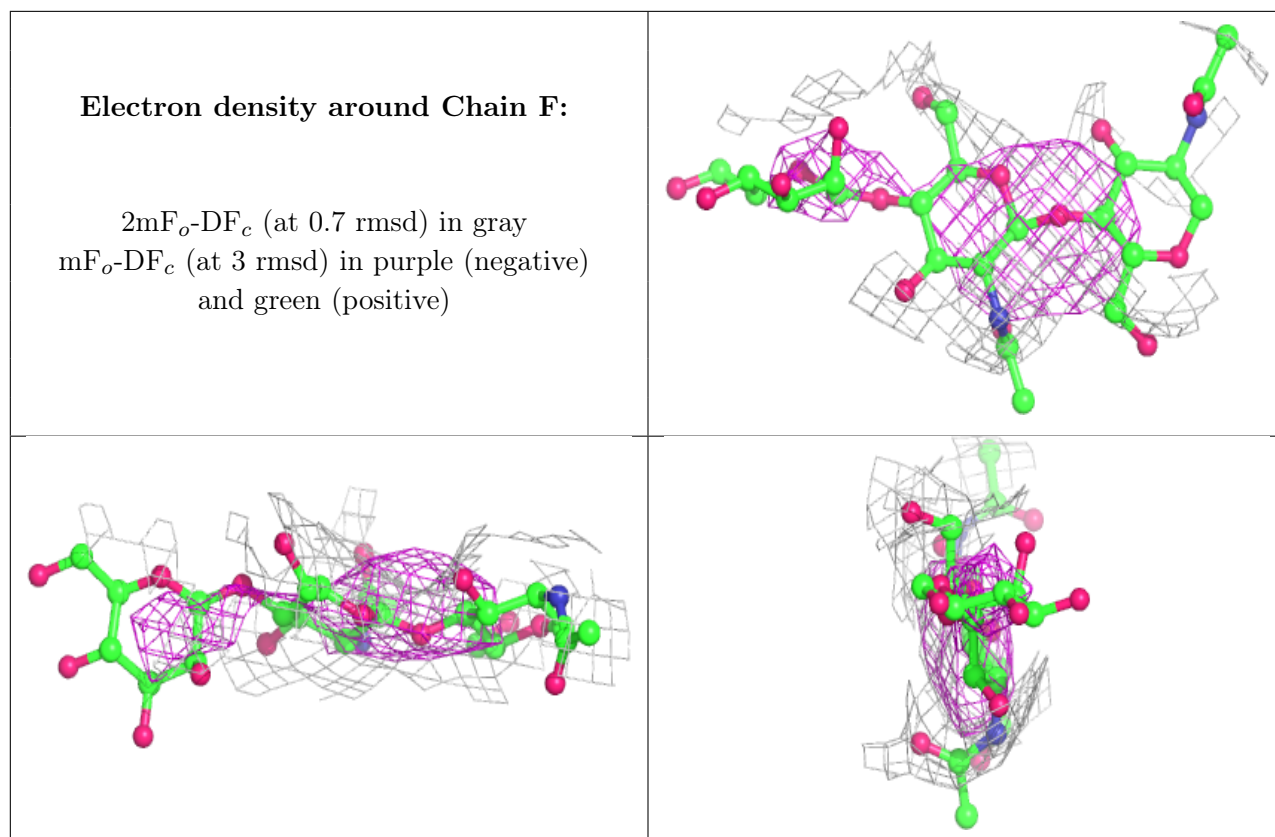

## 6.4 Ligands [i](#)

In the following table, the Atoms column lists the number of modelled atoms in the group and the number defined in the chemical component dictionary. The B-factors column lists the minimum, median, 95<sup>th</sup> percentile and maximum values of B factors of atoms in the group. The column labelled 'Q< 0.9' lists the number of atoms with occupancy less than 0.9.

Mol	Type	Chain	Res	Atoms	RSCC	RSR	B-factors(Å <sup>2</sup> )	Q<0.9
9	NAG	A	504	14/15	0.76	0.62	102,107,110,112	0
9	NAG	A	505	14/15	0.77	0.34	83,91,95,95	0
9	NAG	A	503	14/15	0.79	0.59	93,105,114,117	0
9	NAG	A	506	14/15	0.82	0.45	34,34,34,34	0
9	NAG	A	501	14/15	0.84	0.32	88,103,115,120	0
9	NAG	A	507	14/15	0.91	0.27	32,32,32,32	0
9	NAG	A	502	14/15	0.94	0.26	53,59,64,66	0

## 6.5 Other polymers [i](#)

There are no such residues in this entry.