



# Full wwPDB X-ray Structure Validation Report ⓘ

Nov 16, 2023 – 04:36 AM JST

PDB ID : 6KNZ  
Title : Crystal structure of T2R-TTL-KXO1 complex  
Authors : Chen, Q.; Yu, Y.  
Deposited on : 2019-08-07  
Resolution : 2.48 Å(reported)

This is a Full wwPDB X-ray Structure Validation Report for a publicly released PDB entry.

We welcome your comments at [validation@mail.wwpdb.org](mailto:validation@mail.wwpdb.org)

A user guide is available at

<https://www.wwpdb.org/validation/2017/XrayValidationReportHelp>

with specific help available everywhere you see the ⓘ symbol.

The types of validation reports are described at

<http://www.wwpdb.org/validation/2017/FAQs#types>.

---

The following versions of software and data (see [references ⓘ](#)) were used in the production of this report:

MolProbity : 4.02b-467  
Mogul : 1.8.5 (274361), CSD as541be (2020)  
Xtriage (Phenix) : 1.13  
EDS : 2.36  
buster-report : 1.1.7 (2018)  
Percentile statistics : 20191225.v01 (using entries in the PDB archive December 25th 2019)  
Refmac : 5.8.0158  
CCP4 : 7.0.044 (Gargrove)  
Ideal geometry (proteins) : Engh & Huber (2001)  
Ideal geometry (DNA, RNA) : Parkinson et al. (1996)  
Validation Pipeline (wwPDB-VP) : 2.36

# 1 Overall quality at a glance

The following experimental techniques were used to determine the structure:

*X-RAY DIFFRACTION*

The reported resolution of this entry is 2.48 Å.

Percentile scores (ranging between 0-100) for global validation metrics of the entry are shown in the following graphic. The table shows the number of entries on which the scores are based.

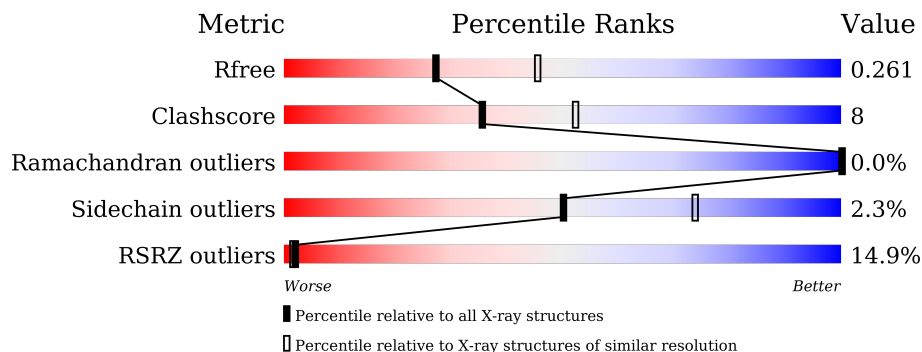

Metric	Whole archive (#Entries)	Similar resolution (#Entries, resolution range(Å))
$R_{free}$	130704	5857 (2.50-2.46)
Clashscore	141614	6594 (2.50-2.46)
Ramachandran outliers	138981	6469 (2.50-2.46)
Sidechain outliers	138945	6471 (2.50-2.46)
RSRZ outliers	127900	5738 (2.50-2.46)

The table below summarises the geometric issues observed across the polymeric chains and their fit to the electron density. The red, orange, yellow and green segments of the lower bar indicate the fraction of residues that contain outliers for  $\geq 3$ , 2, 1 and 0 types of geometric quality criteria respectively. A grey segment represents the fraction of residues that are not modelled. The numeric value for each fraction is indicated below the corresponding segment, with a dot representing fractions  $\leq 5\%$ . The upper red bar (where present) indicates the fraction of residues that have poor fit to the electron density. The numeric value is given above the bar.

Mol	Chain	Length	Quality of chain
1	A	450	 8% 82% 14% ..
1	C	450	 5% 86% 12% .
2	B	445	 10% 78% 16% ..
2	D	445	 21% 76% 20% .
3	E	143	 18% 73% 13% . 14%
4	F	384	 26% 68% 20% . 9%

The following table lists non-polymeric compounds, carbohydrate monomers and non-standard residues in protein, DNA, RNA chains that are outliers for geometric or electron-density-fit criteria:

<b>Mol</b>	<b>Type</b>	<b>Chain</b>	<b>Res</b>	<b>Chirality</b>	<b>Geometry</b>	<b>Clashes</b>	<b>Electron density</b>
7	CA	D	502	-	-	-	X
9	MES	B	507	-	-	X	-

## 2 Entry composition i

There are 12 unique types of molecules in this entry. The entry contains 35097 atoms, of which 17128 are hydrogens and 0 are deuteriums.

In the tables below, the ZeroOcc column contains the number of atoms modelled with zero occupancy, the AltConf column contains the number of residues with at least one atom in alternate conformation and the Trace column contains the number of residues modelled with at most 2 atoms.

- Molecule 1 is a protein called Tubulin alpha-1B chain.

Mol	Chain	Residues	Atoms						ZeroOcc	AltConf	Trace
			Total	C	H	N	O	S			
1	A	438	Total	C	H	N	O	S	0	3	0
			6779	2176	3339	584	656	24			
1	C	440	Total	C	H	N	O	S	0	6	0
			6825	2195	3362	586	659	23			

- Molecule 2 is a protein called Tubulin beta-2B chain.

Mol	Chain	Residues	Atoms						ZeroOcc	AltConf	Trace
			Total	C	H	N	O	S			
2	B	425	Total	C	H	N	O	S	0	3	0
			6592	2111	3233	574	647	27			
2	D	425	Total	C	H	N	O	S	0	1	0
			6543	2095	3205	569	648	26			

- Molecule 3 is a protein called Stathmin-4.

Mol	Chain	Residues	Atoms						ZeroOcc	AltConf	Trace
			Total	C	H	N	O	S			
3	E	123	Total	C	H	N	O	S	0	3	0
			2080	638	1044	188	205	5			

There are 2 discrepancies between the modelled and reference sequences:

Chain	Residue	Modelled	Actual	Comment	Reference
E	3	MET	-	expression tag	UNP P63043
E	4	ALA	-	expression tag	UNP P63043

- Molecule 4 is a protein called Tubulin tyrosine ligase.

Mol	Chain	Residues	Atoms						ZeroOcc	AltConf	Trace
			Total	C	H	N	O	S			
4	F	349	Total	C	H	N	O	S	0	1	0
			5665	1830	2808	489	523	15			

There are 6 discrepancies between the modelled and reference sequences:

Chain	Residue	Modelled	Actual	Comment	Reference
F	379	HIS	-	expression tag	UNP E1BQ43
F	380	HIS	-	expression tag	UNP E1BQ43
F	381	HIS	-	expression tag	UNP E1BQ43
F	382	HIS	-	expression tag	UNP E1BQ43
F	383	HIS	-	expression tag	UNP E1BQ43
F	384	HIS	-	expression tag	UNP E1BQ43

- Molecule 5 is GUANOSINE-5'-TRIPHOSPHATE (three-letter code: GTP) (formula:  $C_{10}H_{16}N_5O_{14}P_3$ ).

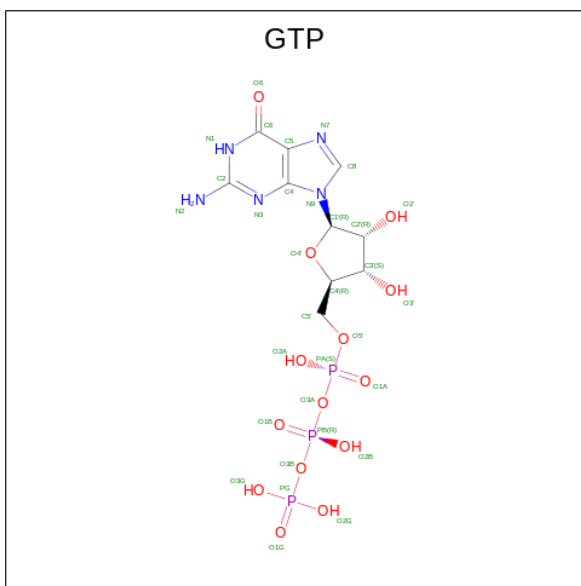

Mol	Chain	Residues	Atoms					ZeroOcc	AltConf	
			Total	C	H	N	O			P
5	A	1	Total	C	H	N	O	P	0	0
			42	10	10	5	14	3		
5	C	1	Total	C	H	N	O	P	0	0
			42	10	10	5	14	3		
5	D	1	Total	C	H	N	O	P	0	0
			42	10	10	5	14	3		

- Molecule 6 is MAGNESIUM ION (three-letter code: MG) (formula: Mg).

Mol	Chain	Residues	Atoms		ZeroOcc	AltConf
			Total	Mg		
6	A	1	Total	Mg	0	0
			1	1		
6	B	1	Total	Mg	0	0
			1	1		
6	C	1	Total	Mg	0	0
			1	1		

*Continued on next page...*

Continued from previous page...

Mol	Chain	Residues	Atoms	ZeroOcc	AltConf
6	D	1	Total Mg 1 1	0	0
6	F	1	Total Mg 1 1	0	0

- Molecule 7 is CALCIUM ION (three-letter code: CA) (formula: Ca).

Mol	Chain	Residues	Atoms	ZeroOcc	AltConf
7	A	1	Total Ca 1 1	0	0
7	B	2	Total Ca 2 2	0	0
7	C	1	Total Ca 1 1	0	0
7	D	1	Total Ca 1 1	0	0
7	E	1	Total Ca 1 1	0	0

- Molecule 8 is GUANOSINE-5'-DIPHOSPHATE (three-letter code: GDP) (formula: C<sub>10</sub>H<sub>15</sub>N<sub>5</sub>O<sub>11</sub>P<sub>2</sub>).

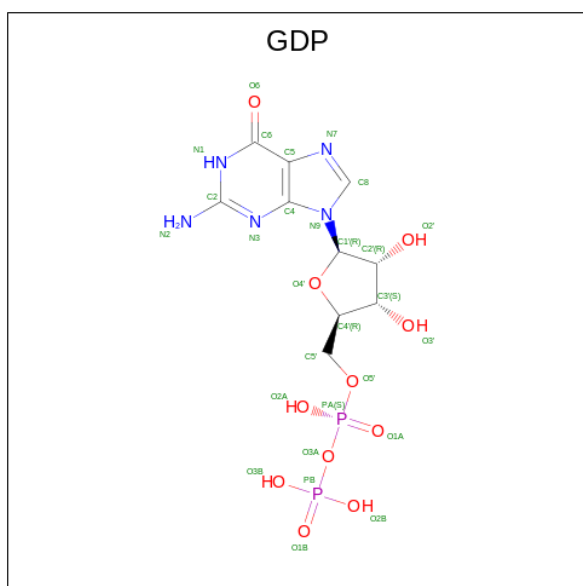

Mol	Chain	Residues	Atoms	ZeroOcc	AltConf
8	B	1	Total C H N O P 38 10 10 5 11 2	0	0

- Molecule 9 is 2-(N-MORPHOLINO)-ETHANESULFONIC ACID (three-letter code: MES) (formula: C<sub>6</sub>H<sub>13</sub>NO<sub>4</sub>S).

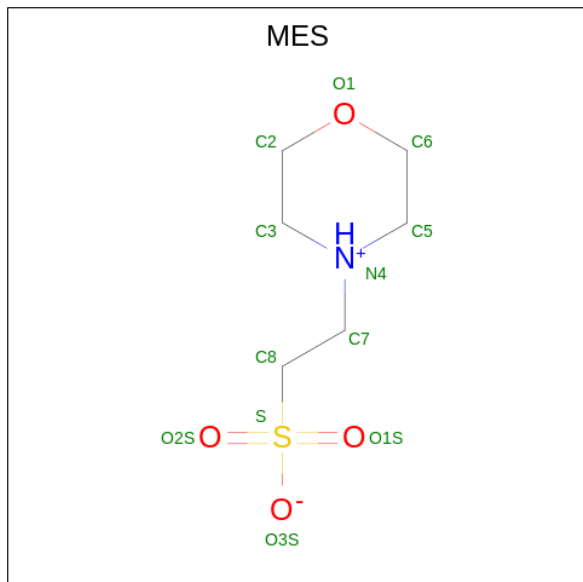

Mol	Chain	Residues	Atoms					ZeroOcc	AltConf		
			Total	C	H	N	O			S	
9	B	1	Total	24	6	12	1	4	1	0	0
9	B	1	Total	25	6	13	1	4	1	0	0

- Molecule 10 is 2-[5-[4-(2-morpholin-4-ylethoxy)phenyl]pyridin-2-yl]-{N}-(phenylmethyl)ethanamide (three-letter code: DN0) (formula: C<sub>26</sub>H<sub>29</sub>N<sub>3</sub>O<sub>3</sub>) (labeled as "Ligand of Interest" by depositor).

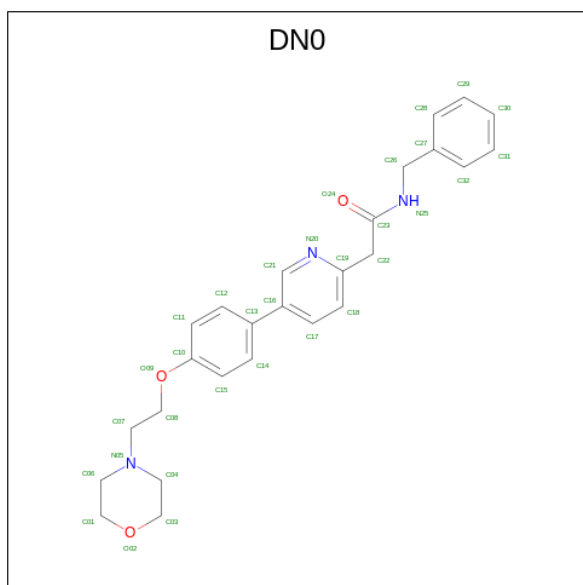

Mol	Chain	Residues	Atoms					ZeroOcc	AltConf
10	B	1	Total	C	H	N	O	0	0
			61	26	29	3	3		
10	D	1	Total	C	H	N	O	0	0
			61	26	29	3	3		

- Molecule 11 is PHOSPHOMETHYLPHOSPHONIC ACID ADENYLATE ESTER (three-letter code: ACP) (formula:  $C_{11}H_{18}N_5O_{12}P_3$ ).

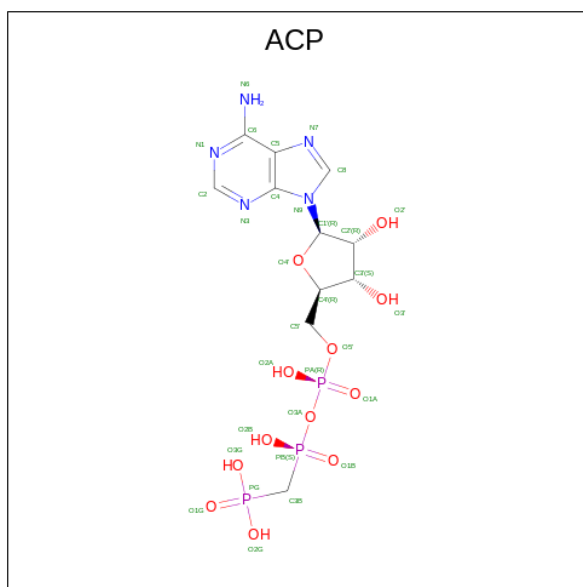

Mol	Chain	Residues	Atoms						ZeroOcc	AltConf
11	F	1	Total	C	H	N	O	P	0	0
			45	11	14	5	12	3		

- Molecule 12 is water.

Mol	Chain	Residues	Atoms		ZeroOcc	AltConf
12	A	54	Total	O	0	0
			54	54		
12	B	44	Total	O	0	0
			44	44		
12	C	96	Total	O	0	0
			96	96		
12	D	11	Total	O	0	0
			11	11		
12	E	3	Total	O	0	0
			3	3		
12	F	14	Total	O	0	0
			14	14		



### 3 Residue-property plots [i](#)

These plots are drawn for all protein, RNA, DNA and oligosaccharide chains in the entry. The first graphic for a chain summarises the proportions of the various outlier classes displayed in the second graphic. The second graphic shows the sequence view annotated by issues in geometry and electron density. Residues are color-coded according to the number of geometric quality criteria for which they contain at least one outlier: green = 0, yellow = 1, orange = 2 and red = 3 or more. A red dot above a residue indicates a poor fit to the electron density ( $RSRZ > 2$ ). Stretches of 2 or more consecutive residues without any outlier are shown as a green connector. Residues present in the sample, but not in the model, are shown in grey.

- Molecule 1: Tubulin alpha-1B chain

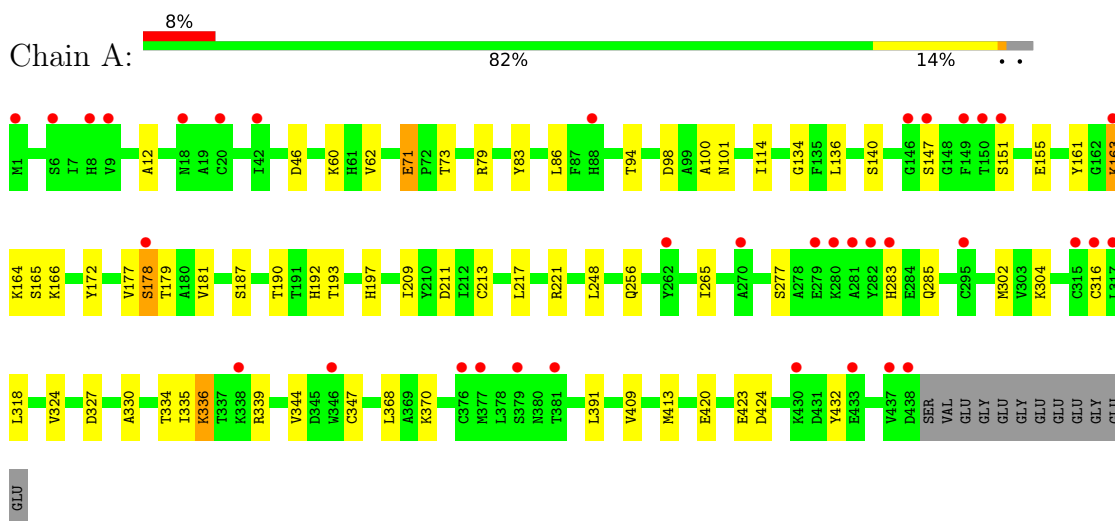

- Molecule 1: Tubulin alpha-1B chain

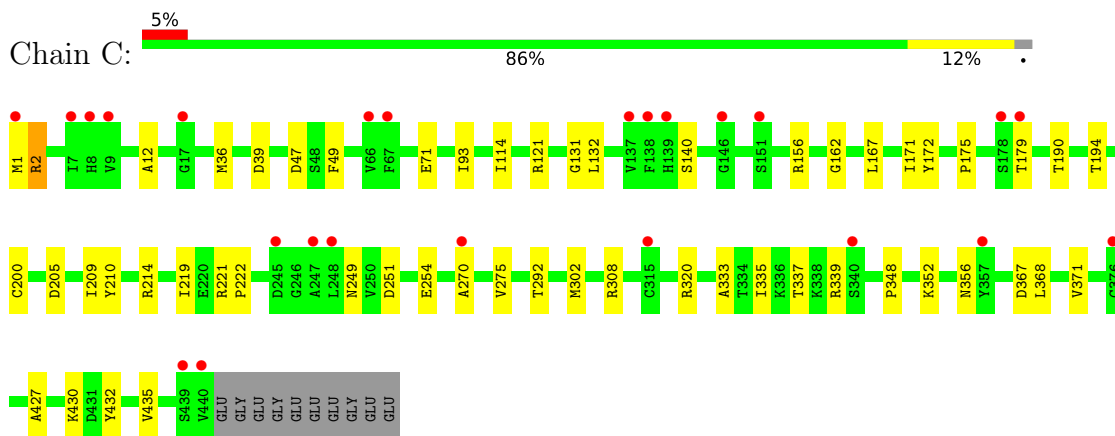

- Molecule 2: Tubulin beta-2B chain

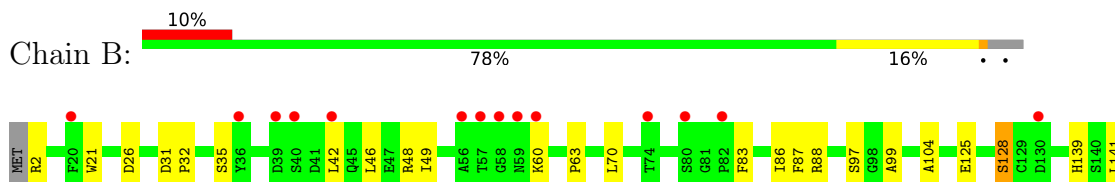

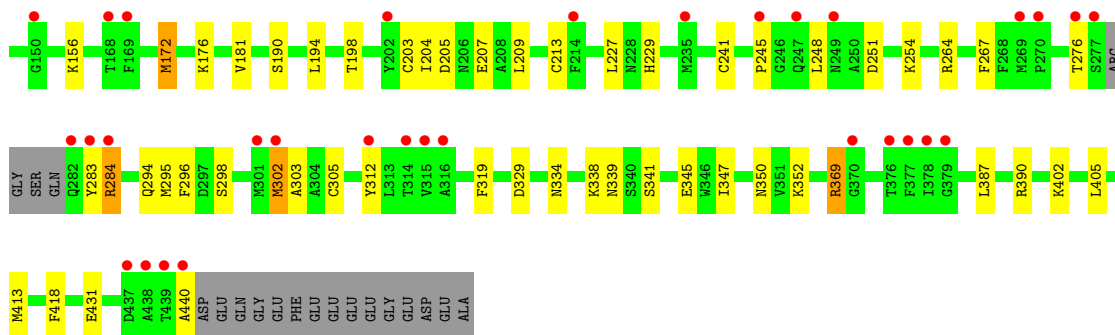

• Molecule 2: Tubulin beta-2B chain

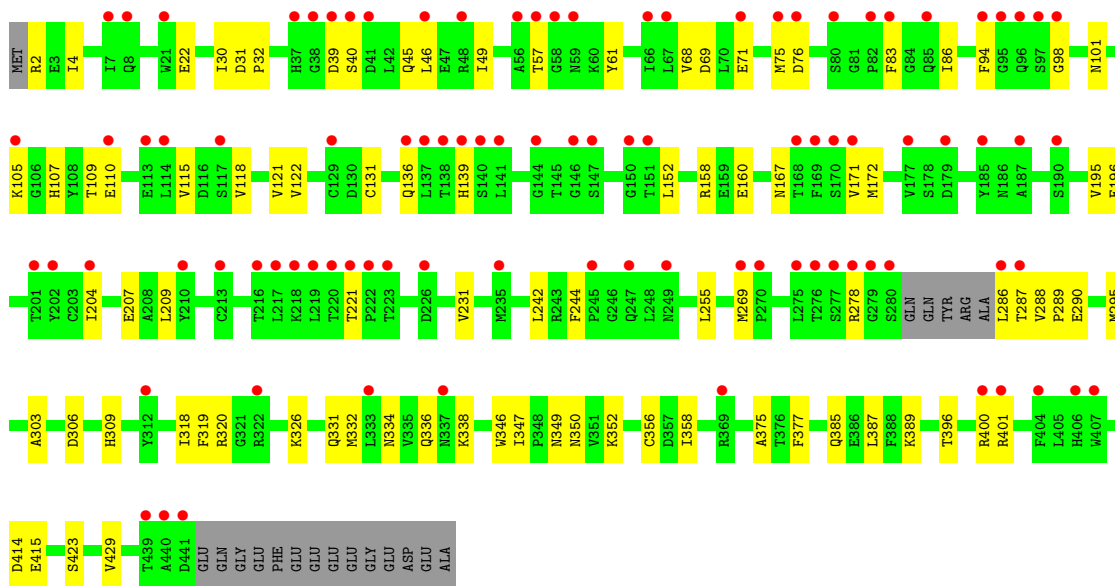
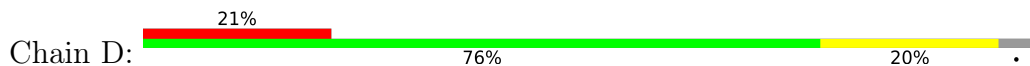

• Molecule 3: Stathmin-4

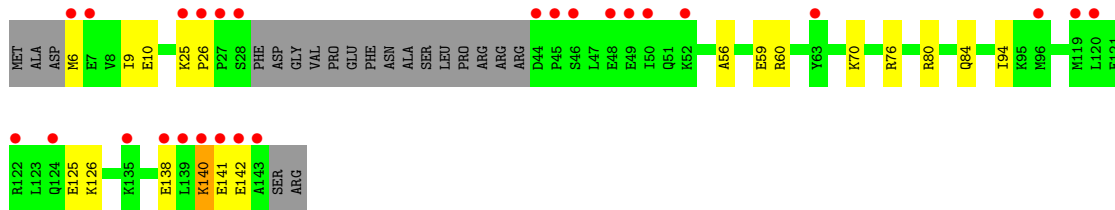

• Molecule 4: Tubulin tyrosine ligase

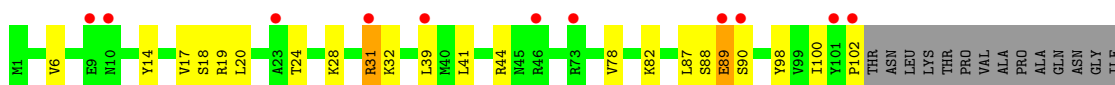

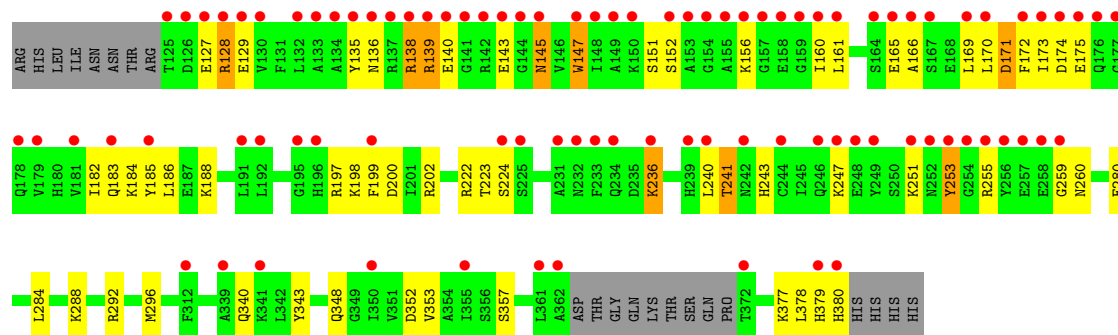

## 4 Data and refinement statistics

Property	Value	Source
Space group	P 21 21 21	Depositor
Cell constants a, b, c, $\alpha$ , $\beta$ , $\gamma$	104.93Å 157.06Å 182.21Å 90.00° 90.00° 90.00°	Depositor
Resolution (Å)	26.23 – 2.48 26.23 – 2.47	Depositor EDS
% Data completeness (in resolution range)	98.7 (26.23-2.48) 98.8 (26.23-2.47)	Depositor EDS
$R_{merge}$	(Not available)	Depositor
$R_{sym}$	(Not available)	Depositor
$\langle I/\sigma(I) \rangle$ <sup>1</sup>	1.60 (at 2.47Å)	Xtrriage
Refinement program	PHENIX 1.15.2_3472	Depositor
R, $R_{free}$	0.220 , 0.261 0.220 , 0.261	Depositor DCC
$R_{free}$ test set	1364 reflections (1.28%)	wwPDB-VP
Wilson B-factor (Å <sup>2</sup> )	52.7	Xtrriage
Anisotropy	0.223	Xtrriage
Bulk solvent $k_{sol}$ (e/Å <sup>3</sup> ), $B_{sol}$ (Å <sup>2</sup> )	0.39 , 51.3	EDS
L-test for twinning <sup>2</sup>	$\langle  L  \rangle = 0.50$ , $\langle L^2 \rangle = 0.33$	Xtrriage
Estimated twinning fraction	No twinning to report.	Xtrriage
$F_o, F_c$ correlation	0.94	EDS
Total number of atoms	35097	wwPDB-VP
Average B, all atoms (Å <sup>2</sup> )	73.0	wwPDB-VP

Xtrriage's analysis on translational NCS is as follows: *The largest off-origin peak in the Patterson function is 2.62% of the height of the origin peak. No significant pseudotranslation is detected.*

<sup>1</sup>Intensities estimated from amplitudes.

<sup>2</sup>Theoretical values of  $\langle |L| \rangle$ ,  $\langle L^2 \rangle$  for acentric reflections are 0.5, 0.333 respectively for untwinned datasets, and 0.375, 0.2 for perfectly twinned datasets.

## 5 Model quality i

### 5.1 Standard geometry i

Bond lengths and bond angles in the following residue types are not validated in this section: CA, DN0, ACP, MG, GTP, MES, GDP

The Z score for a bond length (or angle) is the number of standard deviations the observed value is removed from the expected value. A bond length (or angle) with  $|Z| > 5$  is considered an outlier worth inspection. RMSZ is the root-mean-square of all Z scores of the bond lengths (or angles).

Mol	Chain	Bond lengths		Bond angles	
		RMSZ	# Z  >5	RMSZ	# Z  >5
1	A	0.29	0/3521	0.47	0/4780
1	C	0.30	1/3560 (0.0%)	0.47	0/4835
2	B	0.34	2/3442 (0.1%)	0.53	2/4662 (0.0%)
2	D	0.46	4/3414 (0.1%)	0.56	2/4624 (0.0%)
3	E	0.31	0/1048	0.40	0/1391
4	F	0.58	10/2922 (0.3%)	0.62	3/3946 (0.1%)
All	All	0.40	17/17907 (0.1%)	0.52	7/24238 (0.0%)

Chiral center outliers are detected by calculating the chiral volume of a chiral center and verifying if the center is modelled as a planar moiety or with the opposite hand. A planarity outlier is detected by checking planarity of atoms in a peptide group, atoms in a mainchain group or atoms of a sidechain that are expected to be planar.

Mol	Chain	#Chirality outliers	#Planarity outliers
2	D	0	1
4	F	0	1
All	All	0	2

All (17) bond length outliers are listed below:

Mol	Chain	Res	Type	Atoms	Z	Observed(Å)	Ideal(Å)
2	D	160	GLU	CD-OE1	15.11	1.42	1.25
2	D	160	GLU	CD-OE2	10.23	1.36	1.25
4	F	147	TRP	CG-CD1	9.48	1.50	1.36
4	F	138	ARG	CB-CG	7.89	1.73	1.52
4	F	147	TRP	CD1-NE1	-7.15	1.25	1.38
2	B	284	ARG	CZ-NH2	7.07	1.42	1.33
4	F	138	ARG	CD-NE	6.58	1.57	1.46
4	F	145	ASN	CB-CG	6.42	1.65	1.51
4	F	147	TRP	CE3-CZ3	-6.30	1.27	1.38
1	C	430	LYS	CD-CE	6.19	1.66	1.51

*Continued on next page...*

Continued from previous page...

Mol	Chain	Res	Type	Atoms	Z	Observed(Å)	Ideal(Å)
4	F	145	ASN	CG-OD1	5.93	1.36	1.24
4	F	147	TRP	CZ3-CH2	5.90	1.49	1.40
4	F	138	ARG	CZ-NH2	5.87	1.40	1.33
2	B	284	ARG	CB-CG	5.51	1.67	1.52
2	D	160	GLU	CG-CD	5.48	1.60	1.51
2	D	160	GLU	CB-CG	5.47	1.62	1.52
4	F	145	ASN	CG-ND2	5.38	1.46	1.32

All (7) bond angle outliers are listed below:

Mol	Chain	Res	Type	Atoms	Z	Observed(°)	Ideal(°)
2	B	284	ARG	NE-CZ-NH1	-12.82	113.89	120.30
4	F	138	ARG	CD-NE-CZ	10.69	138.56	123.60
2	B	284	ARG	CG-CD-NE	-9.68	91.47	111.80
2	D	160	GLU	OE1-CD-OE2	9.39	134.56	123.30
2	D	76	ASP	CB-CG-OD1	7.93	125.43	118.30
4	F	138	ARG	CG-CD-NE	-6.52	98.10	111.80
4	F	128	ARG	NE-CZ-NH2	-5.48	117.56	120.30

There are no chirality outliers.

All (2) planarity outliers are listed below:

Mol	Chain	Res	Type	Group
2	D	57	THR	Peptide
4	F	241	THR	Peptide

## 5.2 Too-close contacts [i](#)

In the following table, the Non-H and H(model) columns list the number of non-hydrogen atoms and hydrogen atoms in the chain respectively. The H(added) column lists the number of hydrogen atoms added and optimized by MolProbity. The Clashes column lists the number of clashes within the asymmetric unit, whereas Symm-Clashes lists symmetry-related clashes.

Mol	Chain	Non-H	H(model)	H(added)	Clashes	Symm-Clashes
1	A	3440	3339	3350	49	0
1	C	3463	3362	3387	38	0
2	B	3359	3233	3244	55	0
2	D	3338	3205	3215	57	0
3	E	1036	1044	1047	10	0
4	F	2857	2808	2824	81	0
5	A	32	10	12	1	0

Continued on next page...

Continued from previous page...

Mol	Chain	Non-H	H(model)	H(added)	Clashes	Symm-Clashes
5	C	32	10	12	0	0
5	D	32	10	12	0	0
6	A	1	0	0	0	0
6	B	1	0	0	0	0
6	C	1	0	0	0	0
6	D	1	0	0	0	0
6	F	1	0	0	0	0
7	A	1	0	0	0	0
7	B	2	0	0	0	0
7	C	1	0	0	0	0
7	D	1	0	0	0	0
7	E	1	0	0	0	0
8	B	28	10	12	2	0
9	B	24	25	24	6	0
10	B	32	29	0	1	0
10	D	32	29	0	3	0
11	F	31	14	13	3	0
12	A	54	0	0	3	0
12	B	44	0	0	9	0
12	C	96	0	0	7	0
12	D	11	0	0	2	0
12	E	3	0	0	0	0
12	F	14	0	0	0	0
All	All	17969	17128	17152	283	0

The all-atom clashscore is defined as the number of clashes found per 1000 atoms (including hydrogen atoms). The all-atom clashscore for this structure is 8.

All (283) close contacts within the same asymmetric unit are listed below, sorted by their clash magnitude.

Atom-1	Atom-2	Interatomic distance (Å)	Clash overlap (Å)
2:B:312:TYR:OH	12:B:601:HOH:O	1.85	0.93
4:F:135:TYR:CE2	4:F:145:ASN:OD1	2.25	0.89
4:F:135:TYR:HD2	4:F:147:TRP:HE1	1.23	0.82
2:B:294:GLN:NE2	12:B:602:HOH:O	2.12	0.81
2:D:331:GLN:OE1	12:D:601:HOH:O	2.03	0.77
4:F:135:TYR:CD2	4:F:145:ASN:OD1	2.38	0.76
1:C:1:MET:HG2	1:C:131:GLY:HA3	1.68	0.76
4:F:100:ILE:HD12	4:F:128:ARG:HA	1.69	0.74
1:A:164:LYS:HE2	12:A:652:HOH:O	1.86	0.74
4:F:241:THR:HG23	11:F:402:ACP:O2'	1.87	0.73

Continued on next page...

*Continued from previous page...*

Atom-1	Atom-2	Interatomic distance (Å)	Clash overlap (Å)
2:B:172:MET:HG2	2:B:387:LEU:HD21	1.69	0.73
1:A:83:TYR:HB3	1:A:86:LEU:HD12	1.72	0.71
4:F:138:ARG:NH1	4:F:184:LYS:HE3	2.06	0.71
2:D:2:ARG:NH2	12:D:602:HOH:O	2.25	0.70
2:D:269:MET:HG3	2:D:303:ALA:HB3	1.74	0.70
1:C:427:ALA:HB1	12:C:619:HOH:O	1.93	0.69
1:C:175:PRO:HA	1:C:179:THR:HG22	1.74	0.69
4:F:160:ILE:HD12	4:F:160:ILE:O	1.92	0.69
1:C:339:ARG:O	12:C:602:HOH:O	2.10	0.68
2:D:83:PHE:O	2:D:86:ILE:HG22	1.94	0.68
1:C:371:VAL:O	12:C:601:HOH:O	2.10	0.68
1:C:367:ASP:O	12:C:603:HOH:O	2.12	0.67
1:A:79:ARG:HH12	1:A:94:THR:HG21	1.59	0.67
2:B:97:SER:O	1:C:2:ARG:NH2	2.28	0.67
1:A:60:LYS:HD3	1:A:62:VAL:HG22	1.76	0.67
4:F:280:GLU:HA	4:F:284:LEU:HB2	1.76	0.67
4:F:88:SER:O	4:F:90:SER:N	2.30	0.64
2:B:339:ASN:CB	9:B:507:MES:H21	2.27	0.64
1:A:100:ALA:HA	2:B:254:LYS:HG3	1.79	0.64
2:B:296:PHE:HB3	9:B:507:MES:H51	1.79	0.64
1:C:335:ILE:HG23	1:C:339:ARG:HG3	1.80	0.62
1:C:167:LEU:HG	1:C:200:CYS:HB3	1.82	0.62
1:C:249:ASN:OD1	1:C:356:ASN:ND2	2.32	0.62
1:C:156:ARG:NH1	12:C:607:HOH:O	2.30	0.61
2:B:87:PHE:O	12:B:603:HOH:O	2.16	0.61
3:E:25:LYS:HD3	3:E:26:PRO:O	2.00	0.60
4:F:166:ALA:O	4:F:169:LEU:HG	2.02	0.60
1:C:320:ARG:HA	1:C:356:ASN:O	2.01	0.60
2:D:349:ASN:O	2:D:352:LYS:NZ	2.35	0.60
4:F:202:ARG:HB2	4:F:222:ARG:HH12	1.65	0.60
4:F:340:GLN:HA	4:F:343:TYR:HD2	1.66	0.59
4:F:88:SER:O	4:F:89:GLU:C	2.40	0.59
2:D:295:MET:HG2	2:D:377:PHE:HB2	1.85	0.59
2:B:334:ASN:O	2:B:338:LYS:HD2	2.03	0.59
2:D:295:MET:CG	2:D:377:PHE:HB2	2.33	0.58
2:B:176:LYS:HE2	2:B:207:GLU:HG3	1.86	0.58
4:F:88:SER:C	4:F:90:SER:N	2.57	0.57
4:F:135:TYR:OH	4:F:165:GLU:HA	2.03	0.57
2:D:332:MET:O	2:D:336:GLN:HG3	2.04	0.57
2:D:172:MET:HG3	2:D:387:LEU:HD11	1.87	0.57
2:B:2:ARG:NH2	2:B:251:ASP:OD2	2.36	0.57

*Continued on next page...*



*Continued from previous page...*

Atom-1	Atom-2	Interatomic distance (Å)	Clash overlap (Å)
4:F:280:GLU:OE2	4:F:288:LYS:NZ	2.25	0.56
2:D:352:LYS:HB3	10:D:504:DN0:C10	2.35	0.56
4:F:160:ILE:O	4:F:161:LEU:HB2	2.05	0.56
1:A:166:LYS:HE2	1:A:197:HIS:O	2.05	0.56
1:A:217:LEU:HD21	1:A:368:LEU:HD23	1.87	0.56
4:F:138:ARG:NH2	4:F:145:ASN:HA	2.21	0.56
4:F:102:PRO:HB3	4:F:174:ASP:HA	1.87	0.55
4:F:184:LYS:HD2	4:F:185:TYR:N	2.21	0.55
4:F:169:LEU:HD12	4:F:170:LEU:N	2.22	0.55
1:A:344:VAL:HG23	1:A:347:CYS:HB2	1.89	0.54
1:C:190:THR:O	1:C:194:THR:HG23	2.07	0.54
2:B:352:LYS:NZ	12:B:610:HOH:O	2.37	0.54
1:C:179:THR:O	2:D:352:LYS:HE2	2.08	0.54
1:C:214:ARG:HG2	1:C:219:ILE:O	2.08	0.53
4:F:89:GLU:HG2	4:F:90:SER:N	2.23	0.53
8:B:501:GDP:H8	8:B:501:GDP:H5"	1.73	0.53
2:B:181:VAL:HG12	1:C:348:PRO:HG2	1.89	0.53
2:D:75:MET:CE	2:D:94:PHE:HB3	2.39	0.53
4:F:156:LYS:HE2	4:F:156:LYS:HA	1.91	0.53
2:B:334:ASN:HB3	2:B:338:LYS:HE3	1.91	0.53
4:F:170:LEU:HA	4:F:173:ILE:HG13	1.91	0.53
2:B:42:LEU:HD23	2:B:245:PRO:HG2	1.91	0.53
2:B:70:LEU:HD12	2:B:99:ALA:HB2	1.90	0.53
2:B:264:ARG:HD3	2:B:431:GLU:OE2	2.09	0.53
2:B:339:ASN:HB3	9:B:507:MES:H21	1.92	0.52
2:B:390:ARG:NE	12:B:609:HOH:O	2.35	0.52
4:F:139:ARG:HD3	4:F:140:GLU:HG3	1.91	0.52
1:A:187:SER:HB3	1:A:391:LEU:HD21	1.91	0.52
4:F:128:ARG:HG2	4:F:128:ARG:HH11	1.74	0.52
4:F:296[B]:MET:SD	4:F:380:HIS:ND1	2.83	0.52
2:D:320:ARG:HH21	2:D:358:ILE:HD12	1.75	0.52
2:D:347:ILE:HG22	2:D:350:ASN:HB3	1.92	0.51
2:D:115:VAL:HA	2:D:118:VAL:HG12	1.92	0.51
2:D:195:VAL:HG13	2:D:196:GLU:HG2	1.93	0.51
1:A:71:GLU:HG2	1:A:98:ASP:HB3	1.92	0.51
1:A:187:SER:CB	1:A:391:LEU:HD21	2.41	0.51
2:D:286:LEU:HD12	2:D:290:GLU:OE1	2.10	0.51
2:B:241[B]:CYS:HB2	2:B:248:LEU:HD23	1.93	0.50
4:F:156:LYS:H	4:F:156:LYS:HD2	1.76	0.50
4:F:139:ARG:HD3	4:F:140:GLU:N	2.27	0.50
1:A:192:HIS:ND1	1:A:424:ASP:OD2	2.36	0.50

*Continued on next page...*

*Continued from previous page...*

Atom-1	Atom-2	Interatomic distance (Å)	Clash overlap (Å)
1:A:335:ILE:HG23	1:A:339:ARG:HG3	1.94	0.50
4:F:135:TYR:CE2	4:F:145:ASN:CG	2.86	0.50
1:C:1:MET:HG2	1:C:2:ARG:H	1.75	0.49
1:A:164:LYS:CE	12:A:652:HOH:O	2.53	0.49
1:A:221:ARG:HD2	2:B:329:ASP:OD2	2.13	0.49
3:E:9:ILE:HG22	3:E:10:GLU:N	2.27	0.49
4:F:87:LEU:O	4:F:88:SER:CB	2.61	0.49
2:D:22:GLU:HG2	2:D:83:PHE:CD1	2.48	0.49
4:F:31:ARG:HE	4:F:31:ARG:HA	1.77	0.49
4:F:138:ARG:HG2	4:F:143:GLU:O	2.13	0.49
2:D:385:GLN:HB2	2:D:429:VAL:HG13	1.94	0.48
4:F:31:ARG:HD3	4:F:32:LYS:H	1.78	0.48
4:F:198:LYS:HG2	4:F:199:PHE:N	2.29	0.48
1:A:147:SER:HB2	1:A:190:THR:HB	1.95	0.48
2:B:347:ILE:HG22	2:B:350:ASN:HB3	1.96	0.48
2:D:109:THR:OG1	2:D:110:GLU:N	2.46	0.48
4:F:186:LEU:HD23	11:F:402:ACP:N1	2.28	0.48
1:C:93:ILE:HD11	1:C:121:ARG:HG3	1.96	0.48
1:C:172:TYR:HB3	1:C:205:ASP:HA	1.96	0.48
4:F:169:LEU:HD13	4:F:182:ILE:HD13	1.96	0.48
2:B:156:LYS:HD3	3:E:76:ARG:CZ	2.44	0.48
1:C:275:VAL:HA	1:C:368:LEU:HD21	1.94	0.47
1:A:324:VAL:HG23	1:A:327:ASP:H	1.78	0.47
3:E:138:GLU:O	3:E:142:GLU:HG3	2.14	0.47
4:F:20:LEU:O	4:F:24:THR:HG23	2.13	0.47
1:C:47:ASP:OD2	12:C:604:HOH:O	2.20	0.47
4:F:136:ASN:HA	4:F:139:ARG:HB3	1.96	0.47
1:A:161:TYR:HB3	1:A:164:LYS:HG2	1.97	0.47
1:A:114:ILE:HG13	1:A:114:ILE:O	2.15	0.47
9:B:507:MES:H52	12:B:601:HOH:O	2.14	0.47
1:C:270:ALA:HB3	1:C:302:MET:HG3	1.96	0.47
2:D:46:LEU:HA	2:D:49:ILE:HB	1.97	0.47
4:F:223:THR:OG1	4:F:260:ASN:HB3	2.15	0.47
1:A:71:GLU:OE1	1:A:73:THR:OG1	2.31	0.47
2:D:204:ILE:HG22	2:D:209:LEU:HD11	1.97	0.47
2:D:295:MET:SD	2:D:375:ALA:HB1	2.54	0.47
2:D:105:LYS:HB3	2:D:105:LYS:HE3	1.73	0.47
1:C:1:MET:CG	1:C:131:GLY:HA3	2.40	0.46
1:C:333:ALA:O	1:C:337:THR:HG23	2.15	0.46
4:F:129:GLU:HG2	4:F:129:GLU:O	2.15	0.46
1:A:265:ILE:HG23	1:A:432:TYR:CZ	2.50	0.46

*Continued on next page...*

*Continued from previous page...*

Atom-1	Atom-2	Interatomic distance (Å)	Clash overlap (Å)
1:A:283:HIS:NE2	1:A:285:GLN:OE1	2.47	0.46
2:B:35:SER:OG	2:B:60:LYS:HE2	2.15	0.46
4:F:6:VAL:HG22	4:F:41:LEU:HD12	1.96	0.46
1:A:181:VAL:HG21	2:B:347:ILE:CG2	2.45	0.46
2:B:42:LEU:H	2:B:42:LEU:HD12	1.81	0.46
2:D:31:ASP:HB2	2:D:32:PRO:HD2	1.97	0.46
4:F:223:THR:OG1	4:F:260:ASN:CB	2.64	0.46
1:A:217:LEU:HA	1:A:277:SER:HB2	1.98	0.46
2:B:2:ARG:HH21	2:B:251:ASP:CG	2.18	0.46
2:B:298:SER:N	9:B:507:MES:O2S	2.31	0.46
2:B:303:ALA:O	2:B:305:CYS:N	2.43	0.46
2:D:71:GLU:HG2	2:D:98:GLY:HA2	1.96	0.46
2:D:171:VAL:HA	2:D:204:ILE:O	2.15	0.46
1:C:1:MET:N	12:C:606:HOH:O	2.38	0.46
1:A:420:GLU:O	1:A:423:GLU:HG2	2.16	0.46
1:A:172:TYR:CZ	1:A:391:LEU:HD13	2.51	0.46
1:A:177:VAL:HG23	5:A:501:GTP:O2'	2.16	0.46
1:A:177:VAL:HG23	1:A:177:VAL:O	2.15	0.45
1:A:336:LYS:HD2	1:A:336:LYS:O	2.17	0.45
1:C:209:ILE:HD11	1:C:302:MET:SD	2.56	0.45
4:F:197:ARG:HB3	4:F:224:SER:O	2.16	0.45
4:F:172:PHE:HA	4:F:175:GLU:HG2	1.98	0.45
1:A:155:GLU:OE2	12:A:601:HOH:O	2.21	0.45
1:A:330:ALA:O	1:A:334:THR:HG23	2.17	0.45
1:C:36:MET:HE1	1:C:49:PHE:CE1	2.51	0.45
2:D:68:VAL:HG21	2:D:118:VAL:HG21	1.98	0.45
2:B:88:ARG:NH1	2:B:125:GLU:OE2	2.49	0.45
2:B:21:TRP:CZ3	2:B:63:PRO:HB3	2.52	0.45
2:B:128:SER:O	2:B:128:SER:OG	2.32	0.45
4:F:200:ASP:HB3	4:F:241:THR:HG21	1.97	0.45
2:B:229:HIS:NE2	2:B:276:THR:HG23	2.32	0.45
2:D:204:ILE:HG21	2:D:231:VAL:HG22	1.98	0.45
2:B:296:PHE:HB3	9:B:507:MES:C5	2.46	0.45
4:F:280:GLU:HA	4:F:284:LEU:CB	2.45	0.45
4:F:377:LYS:HE2	4:F:379:HIS:HD2	1.82	0.45
1:A:344:VAL:CG2	1:A:347:CYS:HB2	2.47	0.45
1:C:162:GLY:HA2	3:E:94:ILE:HD11	1.99	0.45
2:D:306:ASP:HB3	2:D:309:HIS:ND1	2.32	0.45
3:E:59:GLU:HG3	3:E:60:ARG:N	2.32	0.45
1:A:211:ASP:OD2	1:A:304:LYS:NZ	2.40	0.45
4:F:160:ILE:HG12	4:F:240:LEU:CD2	2.46	0.45

*Continued on next page...*

*Continued from previous page...*

Atom-1	Atom-2	Interatomic distance (Å)	Clash overlap (Å)
1:C:140:SER:HA	1:C:171:ILE:HB	2.00	0.44
1:A:316[B]:CYS:SG	1:A:318:LEU:HD21	2.57	0.44
1:A:409:VAL:HA	1:A:413:MET:O	2.17	0.44
4:F:31:ARG:HA	4:F:31:ARG:NE	2.32	0.44
4:F:139:ARG:HD3	4:F:139:ARG:C	2.37	0.44
1:A:101:ASN:OD1	2:B:254:LYS:HE2	2.18	0.44
2:B:156:LYS:NZ	12:B:613:HOH:O	2.43	0.44
1:C:12:ALA:HB3	1:C:140:SER:HB3	1.98	0.44
4:F:138:ARG:NH1	4:F:184:LYS:CE	2.80	0.44
4:F:139:ARG:CD	4:F:140:GLU:HG3	2.47	0.44
4:F:243:HIS:C	4:F:243:HIS:HD1	2.21	0.44
2:B:390:ARG:NH1	12:B:617:HOH:O	2.50	0.44
8:B:501:GDP:O3B	12:B:604:HOH:O	2.21	0.44
2:D:396:THR:O	2:D:400:ARG:HB2	2.17	0.44
1:C:292:THR:HG22	1:C:335:ILE:HD12	1.99	0.44
2:D:30:ILE:HD13	2:D:61:TYR:HB2	1.99	0.44
4:F:223:THR:OG1	4:F:260:ASN:ND2	2.50	0.44
2:D:287:THR:HG23	2:D:290:GLU:OE1	2.18	0.44
4:F:198:LYS:HE2	11:F:402:ACP:O2'	2.18	0.44
1:A:248:LEU:HD21	1:A:316[B]:CYS:SG	2.57	0.43
2:B:141:LEU:HD22	2:B:190:SER:HB3	2.00	0.43
1:A:209:ILE:HD11	1:A:302:MET:SD	2.59	0.43
3:E:56:ALA:HA	3:E:59:GLU:HG2	1.99	0.43
2:B:104:ALA:HB2	2:B:413:MET:SD	2.58	0.43
2:D:242:LEU:HD12	2:D:242:LEU:N	2.34	0.43
2:D:288:VAL:HB	2:D:289:PRO:HD3	2.01	0.43
3:E:140:LYS:HE3	3:E:141:GLU:HG3	2.00	0.43
4:F:39:LEU:HD21	4:F:41:LEU:HD21	1.99	0.43
1:A:79:ARG:HH22	1:A:94:THR:HG23	1.83	0.43
2:B:204:ILE:CG2	2:B:209:LEU:HD11	2.48	0.43
2:B:345:GLU:HG2	2:B:440:ALA:HB2	2.01	0.43
2:D:2:ARG:NH1	2:D:131:CYS:SG	2.88	0.43
2:D:320:ARG:HA	2:D:356:CYS:O	2.19	0.43
2:B:26:ASP:OD2	2:B:369:ARG:HD3	2.19	0.43
2:B:46:LEU:HA	2:B:49:ILE:HB	2.00	0.43
1:C:432:TYR:HA	1:C:435:VAL:HG22	2.01	0.43
2:D:244:PHE:CE2	2:D:358:ILE:HD11	2.53	0.43
2:B:241[B]:CYS:SG	10:B:506:DN0:C18	3.07	0.43
2:D:39:ASP:OD2	2:D:39:ASP:N	2.52	0.43
1:A:179:THR:O	2:B:352:LYS:NZ	2.42	0.43
2:B:205:ASP:OD2	2:B:390:ARG:NH1	2.35	0.43

*Continued on next page...*

*Continued from previous page...*

Atom-1	Atom-2	Interatomic distance (Å)	Clash overlap (Å)
2:D:40:SER:O	2:D:45:GLN:OE1	2.37	0.43
4:F:128:ARG:HG2	4:F:128:ARG:NH1	2.33	0.43
4:F:292:ARG:HD3	4:F:378:LEU:HB3	2.00	0.43
2:B:83:PHE:O	2:B:86:ILE:HG22	2.19	0.42
4:F:171:ASP:O	4:F:175:GLU:HG2	2.19	0.42
2:D:346:TRP:CE3	2:D:347:ILE:HG13	2.54	0.42
4:F:184:LYS:HD2	4:F:185:TYR:O	2.19	0.42
1:C:179:THR:O	1:C:179:THR:HG23	2.20	0.42
4:F:138:ARG:HH12	4:F:184:LYS:CD	2.32	0.42
1:C:210:TYR:CZ	1:C:222:PRO:HD2	2.54	0.42
2:D:118:VAL:O	2:D:122:VAL:HG23	2.19	0.42
1:A:177:VAL:O	1:A:178:SER:C	2.58	0.42
1:C:254:GLU:HG2	1:C:352:LYS:HE2	2.02	0.42
2:D:319:PHE:CD1	2:D:319:PHE:N	2.87	0.42
4:F:253:TYR:HD2	4:F:260:ASN:OD1	2.02	0.42
1:A:12:ALA:HB3	1:A:140:SER:HB3	2.00	0.42
1:A:136:LEU:HD12	1:A:136:LEU:N	2.35	0.42
4:F:14:TYR:HA	4:F:17:VAL:HB	2.01	0.42
2:B:213:CYS:SG	2:B:227:LEU:HD23	2.60	0.42
4:F:98:TYR:HB3	4:F:127:GLU:HG3	2.02	0.42
1:A:285:GLN:HA	1:A:285:GLN:NE2	2.33	0.42
1:C:36:MET:HE2	1:C:39:ASP:HB2	2.01	0.42
1:A:151:SER:HB2	1:A:193:THR:OG1	2.21	0.41
2:B:402:LYS:HB3	2:B:405:LEU:HD12	2.02	0.41
2:D:136:GLN:HA	2:D:167:ASN:O	2.21	0.41
4:F:28:LYS:HB3	4:F:28:LYS:HE3	1.81	0.41
4:F:340:GLN:HA	4:F:343:TYR:CD2	2.51	0.41
4:F:377:LYS:HE2	4:F:379:HIS:CD2	2.54	0.41
2:D:4:ILE:HD11	2:D:242:LEU:HD23	2.03	0.41
2:B:31:ASP:HB2	2:B:32:PRO:CD	2.51	0.41
2:B:203:CYS:SG	2:B:267:PHE:HB3	2.59	0.41
2:D:221:THR:O	2:D:221:THR:HG22	2.19	0.41
4:F:19:ARG:HG3	4:F:20:LEU:N	2.35	0.41
4:F:20:LEU:HD21	4:F:348:GLN:OE1	2.20	0.41
1:A:163:LYS:HB2	1:A:163:LYS:HE2	1.66	0.41
2:D:204:ILE:CG2	2:D:209:LEU:HD11	2.51	0.41
4:F:348:GLN:NE2	4:F:352:ASP:OD1	2.53	0.41
2:B:209:LEU:HD23	2:B:302:MET:HG3	2.02	0.41
1:C:93:ILE:HG22	1:C:114:ILE:HD11	2.03	0.41
2:D:118:VAL:O	2:D:121:VAL:HG12	2.20	0.41
2:D:318:ILE:N	2:D:318:ILE:HD12	2.34	0.41

*Continued on next page...*

Continued from previous page...

Atom-1	Atom-2	Interatomic distance (Å)	Clash overlap (Å)
4:F:236:LYS:H	4:F:236:LYS:CD	2.34	0.41
1:A:213:CYS:O	1:A:217:LEU:HB2	2.21	0.41
2:D:385:GLN:O	2:D:389:LYS:HG3	2.21	0.41
4:F:78:VAL:CG1	4:F:82:LYS:HE2	2.51	0.41
4:F:253:TYR:OH	4:F:259:GLY:HA2	2.21	0.41
4:F:353:VAL:O	4:F:357:SER:HB2	2.20	0.41
4:F:138:ARG:HH21	4:F:145:ASN:HA	1.83	0.41
4:F:147:TRP:HE3	4:F:184:LYS:N	2.19	0.41
4:F:151:SER:OG	4:F:152:SER:N	2.55	0.41
2:B:295:MET:HE1	2:B:319:PHE:CZ	2.56	0.40
2:B:413:MET:HE2	2:B:418:PHE:CE1	2.56	0.40
2:D:68:VAL:O	2:D:69:ASP:HB2	2.21	0.40
2:D:107:HIS:O	2:D:152:LEU:HD22	2.21	0.40
2:D:255:LEU:HD22	10:D:504:DN0:C16	2.52	0.40
3:E:70:LYS:HB2	3:E:70:LYS:HE3	1.88	0.40
1:A:134:GLY:HA3	1:A:165:SER:O	2.21	0.40
2:B:194:LEU:HD22	2:B:198:THR:HG21	2.03	0.40
2:D:158:ARG:HG3	2:D:158:ARG:HH11	1.87	0.40
2:D:352:LYS:HB3	10:D:504:DN0:O09	2.21	0.40
4:F:160:ILE:HD12	4:F:160:ILE:C	2.41	0.40
4:F:202:ARG:HB2	4:F:222:ARG:NH1	2.34	0.40
1:C:131:GLY:O	1:C:132:LEU:C	2.59	0.40
2:D:334:ASN:OD1	2:D:338:LYS:HE3	2.21	0.40
2:D:414:ASP:OD1	2:D:415:GLU:N	2.55	0.40
3:E:80:ARG:O	3:E:84[B]:GLN:HG2	2.21	0.40
1:A:265:ILE:HG23	1:A:432:TYR:CE1	2.57	0.40
4:F:247:LYS:HA	4:F:247:LYS:HD2	1.91	0.40

There are no symmetry-related clashes.

## 5.3 Torsion angles [i](#)

### 5.3.1 Protein backbone [i](#)

In the following table, the Percentiles column shows the percent Ramachandran outliers of the chain as a percentile score with respect to all X-ray entries followed by that with respect to entries of similar resolution.

The Analysed column shows the number of residues for which the backbone conformation was analysed, and the total number of residues.

Mol	Chain	Analysed	Favoured	Allowed	Outliers	Percentiles	
1	A	439/450 (98%)	428 (98%)	11 (2%)	0	100	100
1	C	444/450 (99%)	436 (98%)	8 (2%)	0	100	100
2	B	424/445 (95%)	413 (97%)	11 (3%)	0	100	100
2	D	422/445 (95%)	414 (98%)	8 (2%)	0	100	100
3	E	122/143 (85%)	121 (99%)	1 (1%)	0	100	100
4	F	344/384 (90%)	329 (96%)	14 (4%)	1 (0%)	41	59
All	All	2195/2317 (95%)	2141 (98%)	53 (2%)	1 (0%)	100	100

All (1) Ramachandran outliers are listed below:

Mol	Chain	Res	Type
4	F	89	GLU

### 5.3.2 Protein sidechains [i](#)

In the following table, the Percentiles column shows the percent sidechain outliers of the chain as a percentile score with respect to all X-ray entries followed by that with respect to entries of similar resolution.

The Analysed column shows the number of residues for which the sidechain conformation was analysed, and the total number of residues.

Mol	Chain	Analysed	Rotameric	Outliers	Percentiles	
1	A	372/378 (98%)	365 (98%)	7 (2%)	57	78
1	C	377/378 (100%)	372 (99%)	5 (1%)	69	86
2	B	370/383 (97%)	361 (98%)	9 (2%)	49	72
2	D	368/383 (96%)	361 (98%)	7 (2%)	57	78
3	E	113/127 (89%)	109 (96%)	4 (4%)	36	59
4	F	312/342 (91%)	301 (96%)	11 (4%)	36	59
All	All	1912/1991 (96%)	1869 (98%)	43 (2%)	50	75

All (43) residues with a non-rotameric sidechain are listed below:

Mol	Chain	Res	Type
1	A	46	ASP
1	A	71	GLU
1	A	163	LYS
1	A	178	SER

*Continued on next page...*

*Continued from previous page...*

<b>Mol</b>	<b>Chain</b>	<b>Res</b>	<b>Type</b>
1	A	256	GLN
1	A	336	LYS
1	A	370	LYS
2	B	48	ARG
2	B	128	SER
2	B	139	HIS
2	B	172	MET
2	B	283	TYR
2	B	284	ARG
2	B	302	MET
2	B	341	SER
2	B	369	ARG
1	C	2	ARG
1	C	71	GLU
1	C	221	ARG
1	C	251	ASP
1	C	308	ARG
2	D	101	ASN
2	D	139	HIS
2	D	207	GLU
2	D	278	ARG
2	D	326	LYS
2	D	401	ARG
2	D	423	SER
3	E	6	MET
3	E	125	GLU
3	E	126	LYS
3	E	140	LYS
4	F	18	SER
4	F	31	ARG
4	F	44	ARG
4	F	139	ARG
4	F	171	ASP
4	F	183	GLN
4	F	188	LYS
4	F	236	LYS
4	F	251	LYS
4	F	253	TYR
4	F	255	ARG

Sometimes sidechains can be flipped to improve hydrogen bonding and reduce clashes. All (9) such sidechains are listed below:



Mol	Chain	Res	Type
1	A	28	HIS
1	A	128	GLN
2	B	15	GLN
2	B	37	HIS
2	B	91	ASN
4	F	145	ASN
4	F	239	HIS
4	F	260	ASN
4	F	379	HIS

### 5.3.3 RNA [i](#)

There are no RNA molecules in this entry.

### 5.4 Non-standard residues in protein, DNA, RNA chains [i](#)

There are no non-standard protein/DNA/RNA residues in this entry.

### 5.5 Carbohydrates [i](#)

There are no monosaccharides in this entry.

### 5.6 Ligand geometry [i](#)

Of 20 ligands modelled in this entry, 11 are monoatomic - leaving 9 for Mogul analysis.

In the following table, the Counts columns list the number of bonds (or angles) for which Mogul statistics could be retrieved, the number of bonds (or angles) that are observed in the model and the number of bonds (or angles) that are defined in the Chemical Component Dictionary. The Link column lists molecule types, if any, to which the group is linked. The Z score for a bond length (or angle) is the number of standard deviations the observed value is removed from the expected value. A bond length (or angle) with  $|Z| > 2$  is considered an outlier worth inspection. RMSZ is the root-mean-square of all Z scores of the bond lengths (or angles).

Mol	Type	Chain	Res	Link	Bond lengths			Bond angles		
					Counts	RMSZ	# $ Z  > 2$	Counts	RMSZ	# $ Z  > 2$
5	GTP	D	503	6	26,34,34	1.15	3 (11%)	32,54,54	1.58	9 (28%)
11	ACP	F	402	6	27,33,33	4.92	11 (40%)	32,52,52	2.31	13 (40%)
10	DN0	D	504	-	35,35,35	2.57	10 (28%)	44,45,45	1.86	12 (27%)
8	GDP	B	501	6	24,30,30	1.19	2 (8%)	30,47,47	1.36	5 (16%)
5	GTP	A	501	6	26,34,34	1.18	3 (11%)	32,54,54	1.52	6 (18%)

Mol	Type	Chain	Res	Link	Bond lengths			Bond angles		
					Counts	RMSZ	# Z  > 2	Counts	RMSZ	# Z  > 2
5	GTP	C	501	6	26,34,34	1.16	3 (11%)	32,54,54	1.55	7 (21%)
10	DN0	B	506	-	35,35,35	2.55	9 (25%)	44,45,45	2.02	12 (27%)
9	MES	B	503	-	12,12,12	2.12	1 (8%)	14,16,16	2.00	4 (28%)
9	MES	B	507	-	12,12,12	2.27	1 (8%)	14,16,16	2.66	6 (42%)

In the following table, the Chirals column lists the number of chiral outliers, the number of chiral centers analysed, the number of these observed in the model and the number defined in the Chemical Component Dictionary. Similar counts are reported in the Torsion and Rings columns. '-' means no outliers of that kind were identified.

Mol	Type	Chain	Res	Link	Chirals	Torsions	Rings
5	GTP	D	503	6	-	3/18/38/38	0/3/3/3
11	ACP	F	402	6	-	10/15/38/38	0/3/3/3
10	DN0	D	504	-	-	7/19/27/27	0/4/4/4
8	GDP	B	501	6	-	3/12/32/32	0/3/3/3
5	GTP	A	501	6	-	5/18/38/38	0/3/3/3
5	GTP	C	501	6	-	8/18/38/38	0/3/3/3
10	DN0	B	506	-	-	5/19/27/27	0/4/4/4
9	MES	B	503	-	-	5/6/14/14	0/1/1/1
9	MES	B	507	-	-	3/6/14/14	0/1/1/1

All (43) bond length outliers are listed below:

Mol	Chain	Res	Type	Atoms	Z	Observed(Å)	Ideal(Å)
11	F	402	ACP	PB-O3A	21.67	1.82	1.58
10	B	506	DN0	C22-C19	8.99	1.60	1.51
11	F	402	ACP	PA-O5'	8.54	1.93	1.59
10	D	504	DN0	C22-C19	8.25	1.59	1.51
9	B	507	MES	C8-S	-7.55	1.66	1.77
9	B	503	MES	C8-S	-7.02	1.67	1.77
10	D	504	DN0	C04-N05	5.90	1.63	1.46
10	B	506	DN0	C04-N05	5.64	1.62	1.46
11	F	402	ACP	O4'-C4'	-5.21	1.33	1.45
10	D	504	DN0	C07-N05	4.98	1.58	1.47
10	D	504	DN0	C23-N25	4.63	1.43	1.33
10	B	506	DN0	C07-N05	4.40	1.57	1.47
10	B	506	DN0	C23-N25	4.36	1.43	1.33
5	D	503	GTP	C5-C6	-4.01	1.39	1.47
5	A	501	GTP	C5-C6	-3.98	1.39	1.47

Continued on next page...

Continued from previous page...

Mol	Chain	Res	Type	Atoms	Z	Observed(Å)	Ideal(Å)
11	F	402	ACP	O2'-C2'	-3.86	1.33	1.43
5	C	501	GTP	C5-C6	-3.85	1.39	1.47
8	B	501	GDP	O4'-C1'	3.73	1.46	1.41
10	D	504	DN0	C06-N05	3.62	1.56	1.46
10	B	506	DN0	C06-N05	3.60	1.56	1.46
10	B	506	DN0	C26-C27	3.46	1.58	1.51
11	F	402	ACP	O4'-C1'	-3.46	1.36	1.41
10	D	504	DN0	C26-C27	3.43	1.58	1.51
11	F	402	ACP	C3'-C4'	3.18	1.61	1.53
10	D	504	DN0	C22-C23	3.16	1.58	1.51
10	B	506	DN0	C22-C23	3.14	1.58	1.51
10	D	504	DN0	C07-C08	3.12	1.60	1.50
11	F	402	ACP	C5'-C4'	2.83	1.60	1.51
10	B	506	DN0	C07-C08	2.83	1.59	1.50
11	F	402	ACP	C2'-C3'	-2.81	1.45	1.53
8	B	501	GDP	C6-N1	-2.62	1.34	1.37
11	F	402	ACP	O5'-C5'	-2.54	1.35	1.44
5	C	501	GTP	O4'-C1'	2.45	1.44	1.41
10	B	506	DN0	O24-C23	-2.42	1.18	1.23
10	D	504	DN0	C18-C17	2.31	1.43	1.38
10	D	504	DN0	O24-C23	-2.27	1.18	1.23
5	A	501	GTP	O4'-C1'	2.26	1.44	1.41
11	F	402	ACP	O3'-C3'	-2.22	1.37	1.43
5	D	503	GTP	O4'-C1'	2.11	1.44	1.41
5	D	503	GTP	C2-N3	2.09	1.38	1.33
5	C	501	GTP	C2-N3	2.06	1.38	1.33
11	F	402	ACP	C2-N1	2.04	1.37	1.33
5	A	501	GTP	C2-N3	2.03	1.38	1.33

All (74) bond angle outliers are listed below:

Mol	Chain	Res	Type	Atoms	Z	Observed(°)	Ideal(°)
10	B	506	DN0	C22-C23-N25	7.03	125.69	116.19
9	B	507	MES	C6-C5-N4	-6.34	100.50	110.10
11	F	402	ACP	O4'-C1'-C2'	5.57	115.06	106.93
10	D	504	DN0	C22-C23-N25	5.56	123.70	116.19
9	B	503	MES	C5-N4-C3	5.16	120.43	108.83
11	F	402	ACP	C5'-C4'-C3'	-4.68	97.66	115.18
11	F	402	ACP	C5-C6-N6	4.09	126.56	120.35
9	B	507	MES	O1S-S-C8	3.88	111.59	106.92
5	D	503	GTP	PB-O3B-PG	-3.83	119.68	132.83
10	B	506	DN0	C18-C19-N20	-3.77	116.74	122.17

Continued on next page...

*Continued from previous page...*

Mol	Chain	Res	Type	Atoms	Z	Observed(°)	Ideal(°)
11	F	402	ACP	O1B-PB-C3B	3.68	118.80	109.07
10	D	504	DN0	O09-C08-C07	3.63	116.61	107.68
11	F	402	ACP	PB-O3A-PA	-3.50	121.47	132.56
8	B	501	GDP	C2'-C3'-C4'	3.46	109.37	102.64
10	B	506	DN0	C01-C06-N05	-3.45	104.88	110.10
10	D	504	DN0	C18-C19-N20	-3.41	117.26	122.17
10	D	504	DN0	C01-C06-N05	-3.37	105.00	110.10
10	B	506	DN0	O09-C08-C07	3.37	115.97	107.68
5	A	501	GTP	C5-C6-N1	3.36	119.89	113.95
5	C	501	GTP	C5-C6-N1	3.31	119.79	113.95
11	F	402	ACP	O5'-PA-O1A	-3.30	96.19	109.07
10	B	506	DN0	C08-C07-N05	-3.29	104.36	113.31
5	C	501	GTP	C8-N7-C5	3.22	109.12	102.99
9	B	507	MES	C7-N4-C5	3.16	119.31	111.23
10	D	504	DN0	C08-C07-N05	-3.16	104.73	113.31
5	A	501	GTP	C8-N7-C5	3.11	108.92	102.99
10	D	504	DN0	C22-C19-C18	3.10	126.33	121.68
5	D	503	GTP	PA-O3A-PB	-3.09	122.21	132.83
5	C	501	GTP	PA-O3A-PB	-3.08	122.27	132.83
5	C	501	GTP	PB-O3B-PG	-3.04	122.40	132.83
5	D	503	GTP	C5-C6-N1	3.00	119.25	113.95
5	D	503	GTP	C8-N7-C5	2.99	108.69	102.99
9	B	507	MES	C2-C3-N4	2.98	114.62	110.10
5	A	501	GTP	PA-O3A-PB	-2.92	122.82	132.83
9	B	507	MES	C5-N4-C3	2.87	115.28	108.83
10	B	506	DN0	O24-C23-N25	-2.83	117.67	123.01
11	F	402	ACP	C3'-C2'-C1'	-2.79	96.77	100.98
9	B	503	MES	O1S-S-C8	2.78	110.27	106.92
5	A	501	GTP	C2-N1-C6	-2.75	120.03	125.10
9	B	503	MES	O2S-S-C8	2.74	110.22	106.92
5	C	501	GTP	C2-N1-C6	-2.73	120.08	125.10
5	C	501	GTP	C2'-C3'-C4'	2.71	107.91	102.64
10	B	506	DN0	O24-C23-C22	-2.71	115.86	122.03
11	F	402	ACP	O4'-C4'-C5'	2.67	118.15	109.37
10	D	504	DN0	C21-N20-C19	2.67	121.24	117.82
5	D	503	GTP	C2'-C3'-C4'	2.63	107.75	102.64
11	F	402	ACP	C1'-N9-C4	2.59	131.20	126.64
11	F	402	ACP	O1G-PG-C3B	-2.58	105.68	111.24
5	A	501	GTP	PB-O3B-PG	-2.58	123.98	132.83
10	D	504	DN0	O24-C23-N25	-2.46	118.37	123.01
10	B	506	DN0	C17-C16-C13	2.43	125.56	121.36
8	B	501	GDP	C8-N7-C5	2.42	107.60	102.99

*Continued on next page...*

*Continued from previous page...*

Mol	Chain	Res	Type	Atoms	Z	Observed(°)	Ideal(°)
10	B	506	DN0	C17-C18-C19	2.40	121.33	118.86
10	D	504	DN0	C17-C16-C13	2.38	125.47	121.36
5	D	503	GTP	C2-N1-C6	-2.37	120.73	125.10
8	B	501	GDP	C5-C6-N1	2.37	118.13	113.95
11	F	402	ACP	O2B-PB-C3B	2.33	116.10	106.58
10	B	506	DN0	C21-N20-C19	2.26	120.73	117.82
8	B	501	GDP	PA-O3A-PB	-2.25	125.12	132.83
8	B	501	GDP	O3'-C3'-C4'	-2.22	104.62	111.05
10	D	504	DN0	C03-C04-N05	-2.21	106.75	110.10
10	B	506	DN0	C03-C04-N05	-2.20	106.77	110.10
5	C	501	GTP	O6-C6-C5	-2.13	120.20	124.37
9	B	503	MES	C7-N4-C5	2.12	116.67	111.23
10	D	504	DN0	O24-C23-C22	-2.11	117.23	122.03
10	B	506	DN0	O02-C01-C06	-2.09	107.20	111.80
5	A	501	GTP	O6-C6-C5	-2.08	120.30	124.37
9	B	507	MES	O2S-S-C8	2.07	109.40	106.92
11	F	402	ACP	O5'-C5'-C4'	2.06	116.07	108.99
11	F	402	ACP	O2A-PA-O5'	-2.05	98.20	107.75
10	D	504	DN0	O02-C01-C06	-2.05	107.28	111.80
5	D	503	GTP	N1-C2-N3	-2.04	119.51	123.32
5	D	503	GTP	C3'-C2'-C1'	2.03	104.04	100.98
5	D	503	GTP	O6-C6-C5	-2.02	120.43	124.37

There are no chirality outliers.

All (49) torsion outliers are listed below:

Mol	Chain	Res	Type	Atoms
5	A	501	GTP	PB-O3B-PG-O2G
5	A	501	GTP	C5'-O5'-PA-O1A
5	A	501	GTP	C5'-O5'-PA-O2A
5	C	501	GTP	C5'-O5'-PA-O1A
5	C	501	GTP	C5'-O5'-PA-O2A
5	D	503	GTP	C5'-O5'-PA-O1A
5	D	503	GTP	C5'-O5'-PA-O2A
8	B	501	GDP	C5'-O5'-PA-O1A
8	B	501	GDP	C5'-O5'-PA-O2A
9	B	503	MES	C7-C8-S-O2S
9	B	503	MES	C7-C8-S-O3S
9	B	507	MES	C7-C8-S-O3S
11	F	402	ACP	PB-C3B-PG-O1G
11	F	402	ACP	PB-C3B-PG-O2G
11	F	402	ACP	PB-C3B-PG-O3G

*Continued on next page...*

*Continued from previous page...*

Mol	Chain	Res	Type	Atoms
11	F	402	ACP	PG-C3B-PB-O1B
11	F	402	ACP	PG-C3B-PB-O2B
11	F	402	ACP	PG-C3B-PB-O3A
11	F	402	ACP	C5'-O5'-PA-O1A
11	F	402	ACP	C3'-C4'-C5'-O5'
10	B	506	DN0	C22-C23-N25-C26
10	D	504	DN0	C22-C23-N25-C26
11	F	402	ACP	O4'-C4'-C5'-O5'
10	B	506	DN0	O24-C23-N25-C26
10	D	504	DN0	O24-C23-N25-C26
10	B	506	DN0	C11-C10-O09-C08
10	D	504	DN0	C15-C10-O09-C08
10	B	506	DN0	C15-C10-O09-C08
10	D	504	DN0	C11-C10-O09-C08
10	B	506	DN0	C07-C08-O09-C10
10	D	504	DN0	C07-C08-O09-C10
9	B	503	MES	C8-C7-N4-C5
5	A	501	GTP	PB-O3B-PG-O1G
11	F	402	ACP	C5'-O5'-PA-O3A
9	B	503	MES	C7-C8-S-O1S
9	B	507	MES	C7-C8-S-O1S
9	B	507	MES	C7-C8-S-O2S
9	B	503	MES	C8-C7-N4-C3
5	C	501	GTP	PB-O3B-PG-O1G
5	C	501	GTP	PB-O3A-PA-O2A
5	C	501	GTP	PB-O3B-PG-O2G
5	C	501	GTP	PB-O3B-PG-O3G
5	A	501	GTP	C5'-O5'-PA-O3A
5	C	501	GTP	C5'-O5'-PA-O3A
5	D	503	GTP	C5'-O5'-PA-O3A
8	B	501	GDP	C5'-O5'-PA-O3A
5	C	501	GTP	PB-O3A-PA-O1A
10	D	504	DN0	C08-C07-N05-C04
10	D	504	DN0	C08-C07-N05-C06

There are no ring outliers.

6 monomers are involved in 16 short contacts:

Mol	Chain	Res	Type	Clashes	Symm-Clashes
11	F	402	ACP	3	0
10	D	504	DN0	3	0
8	B	501	GDP	2	0

*Continued on next page...*

*Continued from previous page...*

Mol	Chain	Res	Type	Clashes	Symm-Clashes
5	A	501	GTP	1	0
10	B	506	DN0	1	0
9	B	507	MES	6	0

The following is a two-dimensional graphical depiction of Mogul quality analysis of bond lengths, bond angles, torsion angles, and ring geometry for all instances of the Ligand of Interest. In addition, ligands with molecular weight > 250 and outliers as shown on the validation Tables will also be included. For torsion angles, if less than 5% of the Mogul distribution of torsion angles is within 10 degrees of the torsion angle in question, then that torsion angle is considered an outlier. Any bond that is central to one or more torsion angles identified as an outlier by Mogul will be highlighted in the graph. For rings, the root-mean-square deviation (RMSD) between the ring in question and similar rings identified by Mogul is calculated over all ring torsion angles. If the average RMSD is greater than 60 degrees and the minimal RMSD between the ring in question and any Mogul-identified rings is also greater than 60 degrees, then that ring is considered an outlier. The outliers are highlighted in purple. The color gray indicates Mogul did not find sufficient equivalents in the CSD to analyse the geometry.

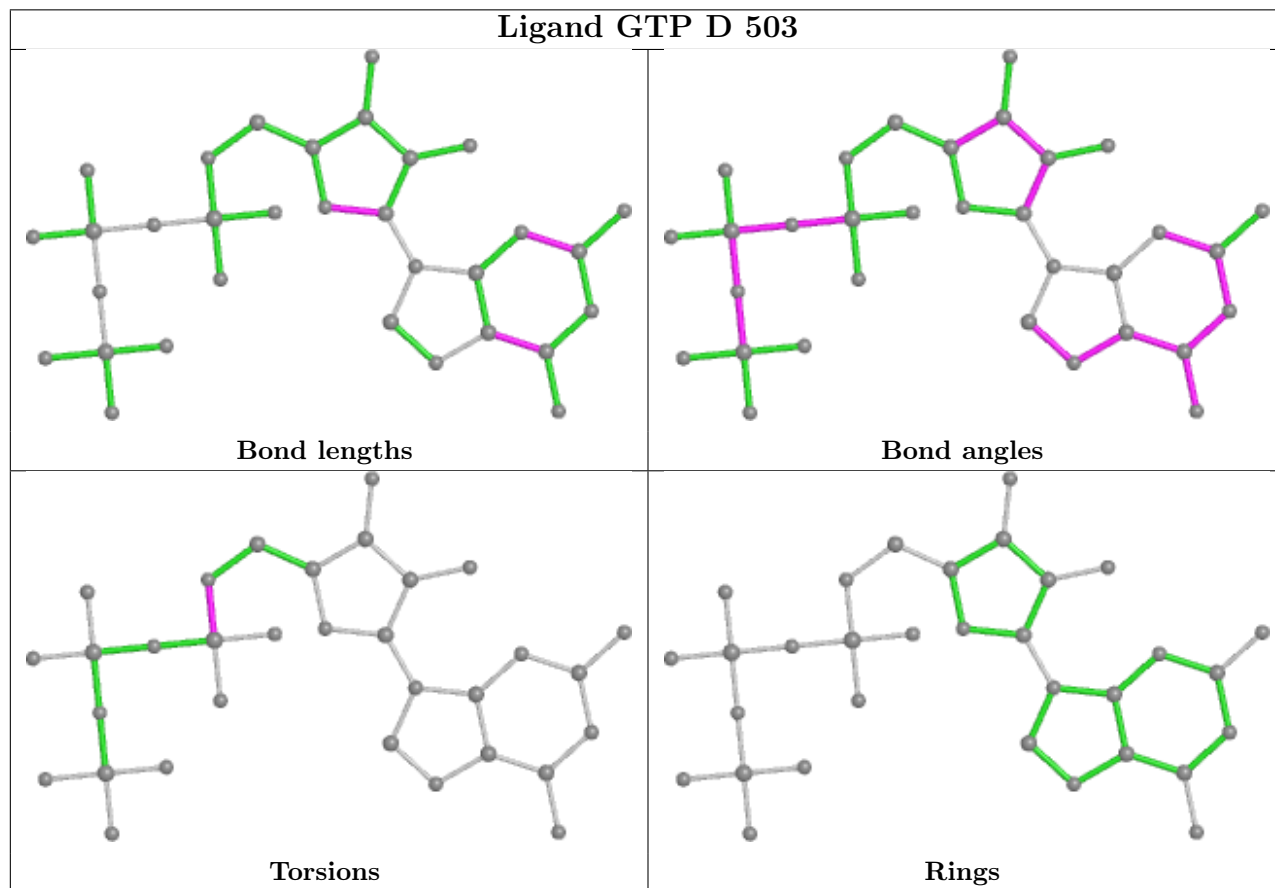

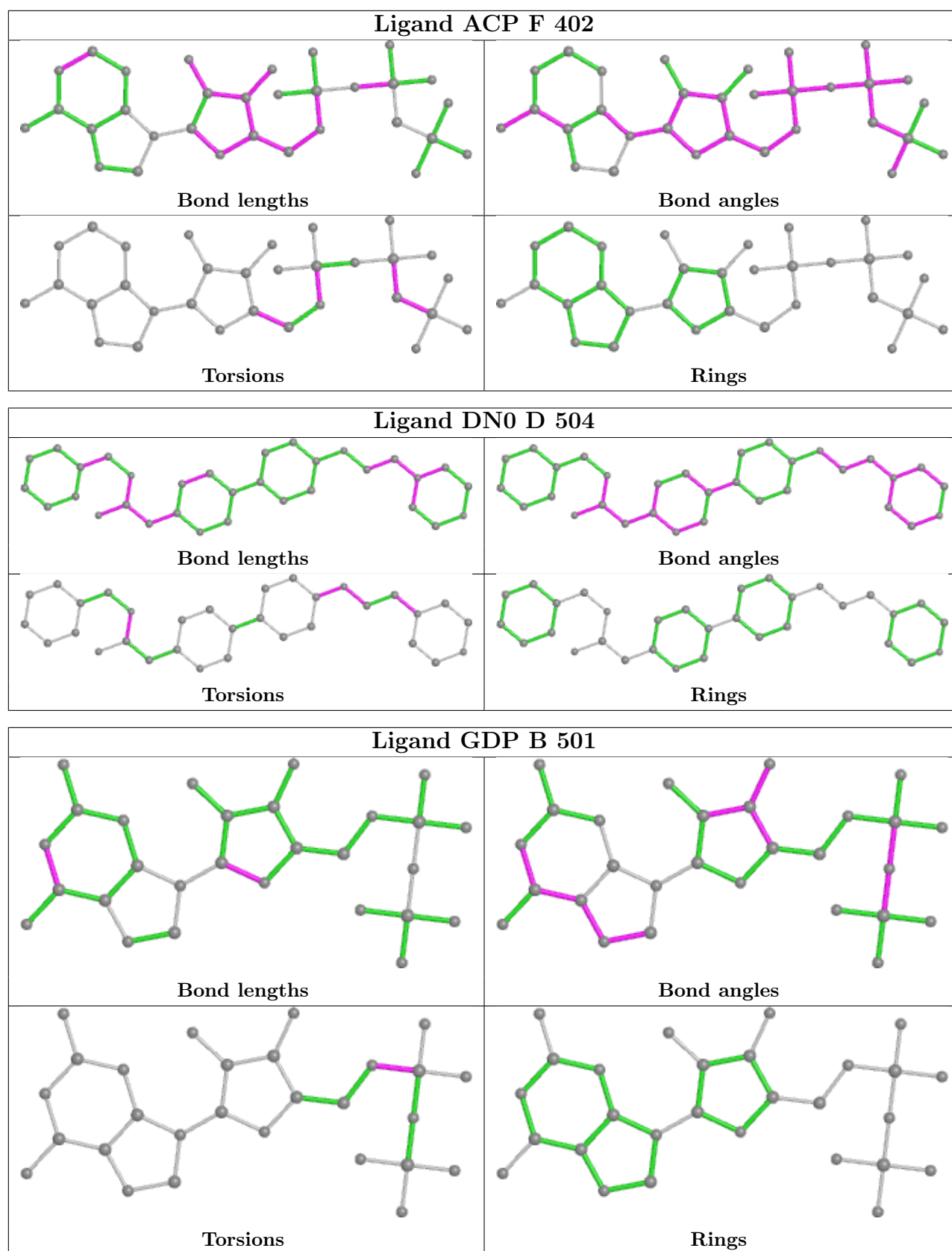



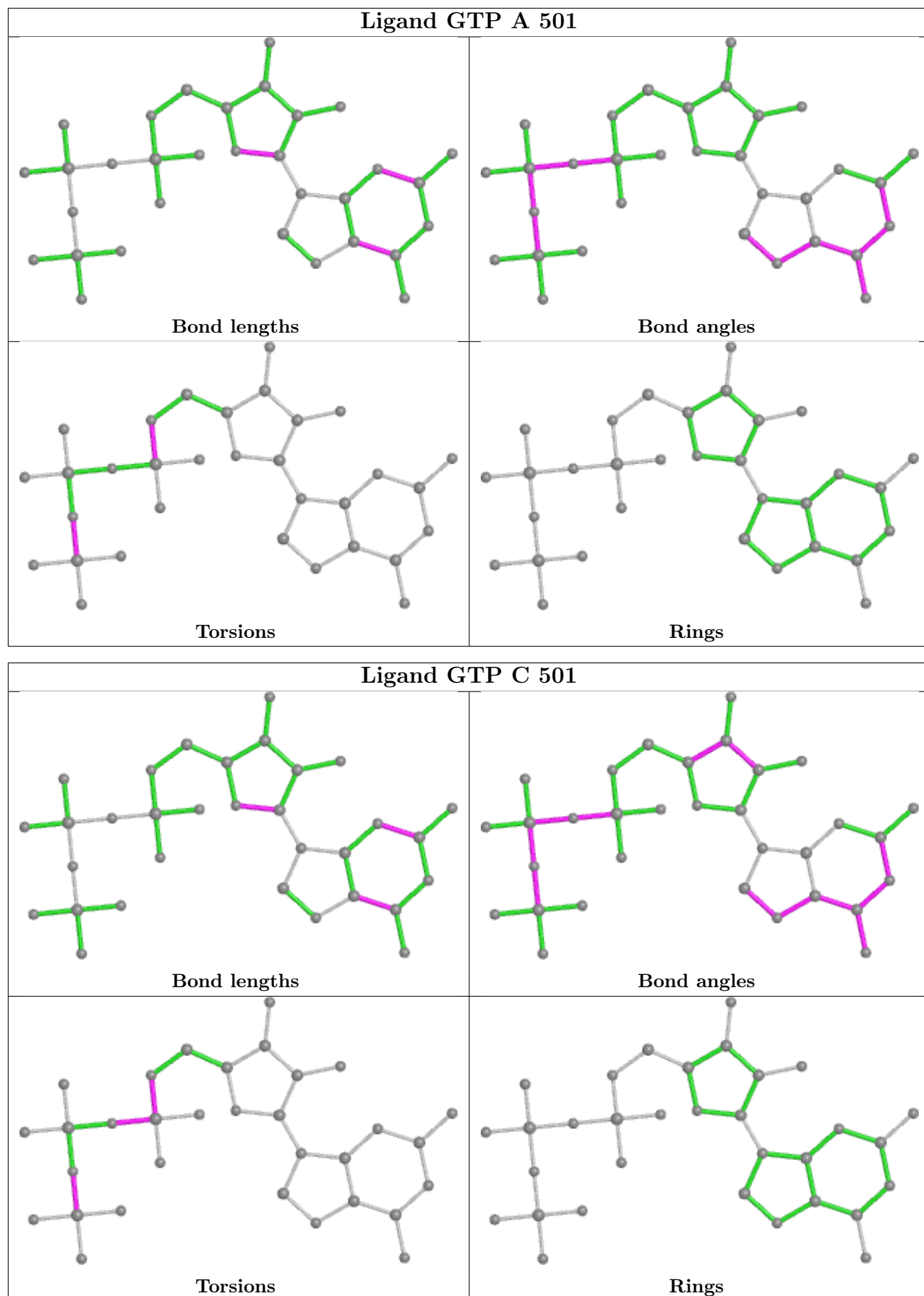

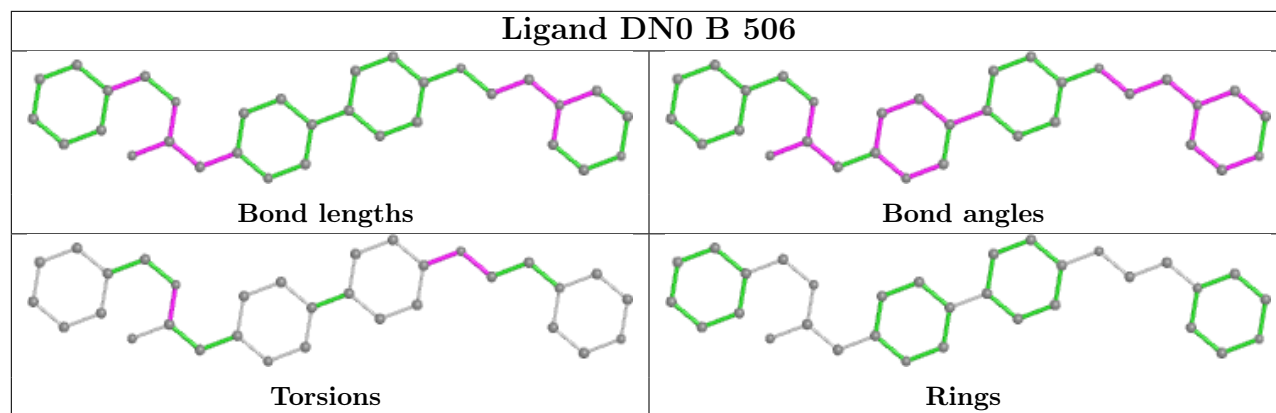

## 5.7 Other polymers [i](#)

There are no such residues in this entry.

## 5.8 Polymer linkage issues [i](#)

There are no chain breaks in this entry.

## 6 Fit of model and data [i](#)

### 6.1 Protein, DNA and RNA chains [i](#)

In the following table, the column labelled ‘#RSRZ > 2’ contains the number (and percentage) of RSRZ outliers, followed by percent RSRZ outliers for the chain as percentile scores relative to all X-ray entries and entries of similar resolution. The OWAB column contains the minimum, median, 95<sup>th</sup> percentile and maximum values of the occupancy-weighted average B-factor per residue. The column labelled ‘Q < 0.9’ lists the number of (and percentage) of residues with an average occupancy less than 0.9.

Mol	Chain	Analysed	<RSRZ>	#RSRZ>2	OWAB(Å <sup>2</sup> )	Q<0.9
1	A	438/450 (97%)	0.49	36 (8%) 11 11	36, 59, 83, 120	0
1	C	440/450 (97%)	0.25	24 (5%) 25 26	33, 49, 69, 80	0
2	B	425/445 (95%)	0.66	45 (10%) 6 5	34, 59, 88, 112	0
2	D	425/445 (95%)	1.07	95 (22%) 0 0	45, 77, 96, 104	0
3	E	123/143 (86%)	1.21	26 (21%) 1 0	45, 72, 96, 111	0
4	F	349/384 (90%)	1.39	101 (28%) 0 0	47, 82, 133, 205	0
All	All	2200/2317 (94%)	0.77	327 (14%) 2 1	33, 64, 108, 205	0

All (327) RSRZ outliers are listed below:

Mol	Chain	Res	Type	RSRZ
4	F	157	GLY	9.6
1	A	281	ALA	8.1
4	F	253	TYR	7.5
4	F	155	ALA	6.9
4	F	177	GLY	6.8
4	F	153	ALA	6.6
4	F	138	ARG	6.6
4	F	139	ARG	6.5
4	F	173	ILE	6.3
1	A	282	TYR	6.3
4	F	256	TYR	6.0
4	F	158	GLU	6.0
3	E	143	ALA	6.0
4	F	252	ASN	5.8
4	F	156	LYS	5.7
2	D	37	HIS	5.6
2	D	221	THR	5.6
2	D	94	PHE	5.5
4	F	154	GLY	5.5

*Continued on next page...*

*Continued from previous page...*

<b>Mol</b>	<b>Chain</b>	<b>Res</b>	<b>Type</b>	<b>RSRZ</b>
4	F	125	THR	5.5
1	A	283	HIS	5.4
2	B	440	ALA	5.4
4	F	233	PHE	5.4
4	F	249	TYR	5.4
2	D	277	SER	5.3
2	B	439	THR	5.3
2	B	438	ALA	5.2
4	F	101	TYR	5.2
4	F	136	ASN	5.2
4	F	372	THR	5.1
3	E	26	PRO	5.1
4	F	244	CYS	5.1
4	F	137	ARG	5.1
3	E	27	PRO	5.0
4	F	142	ARG	4.9
4	F	251	LYS	4.9
4	F	132	LEU	4.9
2	B	284	ARG	4.9
4	F	161	LEU	4.7
4	F	175	GLU	4.7
2	B	283	TYR	4.6
3	E	142	GLU	4.6
4	F	143	GLU	4.6
4	F	178	GLN	4.6
4	F	255	ARG	4.6
2	B	56	ALA	4.5
2	B	59	ASN	4.4
1	C	178	SER	4.4
4	F	135	TYR	4.4
4	F	152	SER	4.4
4	F	231	ALA	4.4
2	D	276	THR	4.3
2	D	169	PHE	4.3
2	D	218	LYS	4.3
2	D	219	LEU	4.3
2	D	217	LEU	4.2
4	F	176	GLN	4.2
4	F	232	ASN	4.2
2	D	97	SER	4.1
3	E	139	LEU	4.1
3	E	46	SER	4.1

*Continued on next page...*

*Continued from previous page...*

<b>Mol</b>	<b>Chain</b>	<b>Res</b>	<b>Type</b>	<b>RSRZ</b>
2	D	57	THR	4.1
4	F	234	GLN	4.1
4	F	133	ALA	4.1
2	D	7	ILE	4.0
1	A	438	ASP	4.0
4	F	179	VAL	4.0
4	F	170	LEU	3.9
3	E	120	LEU	3.9
2	B	57	THR	3.9
4	F	130	VAL	3.9
2	D	275	LEU	3.9
2	D	82	PRO	3.9
2	D	441	ASP	3.9
4	F	379	HIS	3.9
2	D	139	HIS	3.8
3	E	45	PRO	3.8
4	F	159	GLY	3.8
2	B	169	PHE	3.8
4	F	148	ILE	3.8
1	A	262	TYR	3.8
2	D	247	GLN	3.8
1	C	1	MET	3.7
4	F	236	LYS	3.7
2	B	247	GLN	3.7
2	B	377	PHE	3.7
2	D	400	ARG	3.7
4	F	169	LEU	3.7
1	A	437	VAL	3.7
4	F	147	TRP	3.6
4	F	89	GLU	3.6
2	B	277	SER	3.6
4	F	141	GLY	3.6
2	D	202	TYR	3.6
4	F	312	PHE	3.6
2	D	170	SER	3.6
4	F	10	ASN	3.5
2	D	280	SER	3.5
2	D	96	GLN	3.5
3	E	141	GLU	3.4
2	B	276	THR	3.4
2	D	286	LEU	3.4
4	F	134	ALA	3.4

*Continued on next page...*

*Continued from previous page...*

<b>Mol</b>	<b>Chain</b>	<b>Res</b>	<b>Type</b>	<b>RSRZ</b>
4	F	140	GLU	3.4
1	C	440	VAL	3.4
4	F	247	LYS	3.4
2	B	42	LEU	3.3
3	E	48	GLU	3.3
4	F	9	GLU	3.3
1	A	315[A]	CYS	3.3
4	F	225	SER	3.3
2	D	147	SER	3.2
2	D	401	ARG	3.2
4	F	259	GLY	3.2
4	F	380	HIS	3.2
2	D	140	SER	3.2
4	F	144	GLY	3.1
2	D	138	THR	3.1
3	E	44	ASP	3.1
2	B	378	ILE	3.1
2	D	95	GLY	3.1
2	B	379	GLY	3.1
2	D	58	GLY	3.1
4	F	181	VAL	3.1
1	A	295	CYS	3.1
2	D	59	ASN	3.1
2	D	141	LEU	3.1
1	C	66	VAL	3.0
2	D	117	SER	3.0
3	E	28	SER	3.0
2	D	407	TRP	3.0
2	D	168	THR	3.0
2	D	187	ALA	3.0
2	B	130	ASP	2.9
3	E	140	LYS	2.9
2	D	279	GLY	2.9
3	E	122	ARG	2.9
2	D	220	THR	2.9
4	F	254	GLY	2.9
4	F	257	GLU	2.9
1	A	430	LYS	2.9
2	B	316	ALA	2.9
2	D	39	ASP	2.9
2	B	282	GLN	2.9
3	E	7	GLU	2.9

*Continued on next page...*

*Continued from previous page...*

<b>Mol</b>	<b>Chain</b>	<b>Res</b>	<b>Type</b>	<b>RSRZ</b>
4	F	127	GLU	2.9
2	D	75	MET	2.9
4	F	23	ALA	2.9
1	A	18	ASN	2.8
4	F	258	GLU	2.8
2	D	56	ALA	2.8
2	B	270	PRO	2.8
4	F	174	ASP	2.8
2	B	40	SER	2.8
2	B	36	TYR	2.8
2	D	40	SER	2.8
1	A	88	HIS	2.8
1	A	346	TRP	2.8
2	D	312	TYR	2.8
3	E	135	LYS	2.7
1	A	376	CYS	2.7
2	D	190	SER	2.7
2	B	312	TYR	2.7
1	A	163	LYS	2.7
2	D	83	PHE	2.7
2	D	235	MET	2.7
1	C	9	VAL	2.7
1	C	340	SER	2.7
4	F	224	SER	2.7
2	D	137	LEU	2.7
2	D	98	GLY	2.7
2	D	213	CYS	2.7
2	D	322	ARG	2.7
4	F	128	ARG	2.7
2	D	245	PRO	2.7
2	D	439	THR	2.6
3	E	49	GLU	2.6
4	F	46	ARG	2.6
2	D	278	ARG	2.6
1	C	179	THR	2.6
2	D	337	ASN	2.6
3	E	138	GLU	2.6
2	B	82	PRO	2.6
1	C	439	SER	2.6
2	D	105	LYS	2.6
4	F	129	GLU	2.6
4	F	185	TYR	2.6

*Continued on next page...*

*Continued from previous page...*

<b>Mol</b>	<b>Chain</b>	<b>Res</b>	<b>Type</b>	<b>RSRZ</b>
1	C	245	ASP	2.6
2	D	223	THR	2.6
1	A	377	MET	2.6
2	D	150	GLY	2.6
2	D	369	ARG	2.6
2	D	46	LEU	2.6
2	D	185	TYR	2.6
1	C	8	HIS	2.5
1	A	151	SER	2.5
2	D	80	SER	2.5
1	A	150	THR	2.5
2	B	20	PHE	2.5
2	D	406	HIS	2.5
2	B	58	GLY	2.5
2	D	76	ASP	2.5
4	F	160	ILE	2.5
1	A	149	PHE	2.5
1	A	316[A]	CYS	2.5
3	E	25	LYS	2.5
2	D	333	LEU	2.5
1	A	20	CYS	2.5
4	F	362	ALA	2.5
1	C	146	GLY	2.5
2	D	48	ARG	2.4
2	B	202	TYR	2.4
4	F	90	SER	2.4
4	F	167	SER	2.4
1	C	138	PHE	2.4
2	D	270	PRO	2.4
2	B	168	THR	2.4
1	A	178	SER	2.4
4	F	164	SER	2.4
2	B	301	MET	2.4
3	E	6	MET	2.4
4	F	145	ASN	2.4
4	F	355	ILE	2.4
4	F	183	GLN	2.4
2	D	204	ILE	2.4
2	B	376	THR	2.4
2	D	85	GLN	2.4
2	D	151	THR	2.4
2	D	71	GLU	2.3

*Continued on next page...*



*Continued from previous page...*

<b>Mol</b>	<b>Chain</b>	<b>Res</b>	<b>Type</b>	<b>RSRZ</b>
2	B	370	GLY	2.3
4	F	195	GLY	2.3
3	E	119	MET	2.3
4	F	246	GLN	2.3
2	B	60	LYS	2.3
2	B	74	THR	2.3
4	F	191	LEU	2.3
2	D	179	ASP	2.3
4	F	31	ARG	2.3
2	D	226	ASP	2.3
4	F	196	HIS	2.3
2	B	314	THR	2.3
1	C	315[A]	CYS	2.3
2	B	437	ASP	2.3
2	D	8	GLN	2.3
4	F	361	LEU	2.3
1	A	379	SER	2.3
1	C	7	ILE	2.3
2	D	21	TRP	2.3
1	C	247	ALA	2.2
4	F	149	ALA	2.2
2	D	144	GLY	2.2
2	D	146	GLY	2.2
2	D	171	VAL	2.2
1	C	67	PHE	2.2
3	E	63	TYR	2.2
1	A	433	GLU	2.2
4	F	248	GLU	2.2
2	D	216	THR	2.2
4	F	199	PHE	2.2
2	B	39	ASP	2.2
1	A	279	GLU	2.2
2	D	113	GLU	2.2
4	F	166	ALA	2.2
1	A	381	THR	2.2
1	C	376	CYS	2.2
1	A	1	MET	2.2
4	F	350	ILE	2.2
2	B	150	GLY	2.2
1	A	6	SER	2.2
2	D	210	TYR	2.1
2	B	214	PHE	2.1

*Continued on next page...*

*Continued from previous page...*

Mol	Chain	Res	Type	RSRZ
1	C	248	LEU	2.1
3	E	52	LYS	2.1
4	F	341	LYS	2.1
1	A	8	HIS	2.1
2	B	249	ASN	2.1
1	A	270	ALA	2.1
2	D	177	VAL	2.1
4	F	242	ASN	2.1
2	D	222	PRO	2.1
2	D	404	PHE	2.1
3	E	96	MET	2.1
1	C	270	ALA	2.1
2	D	66	ILE	2.1
2	D	269	MET	2.1
1	C	357	TYR	2.1
2	B	315	VAL	2.1
2	D	136	GLN	2.1
2	D	440	ALA	2.1
3	E	50	ILE	2.1
1	A	338	LYS	2.1
2	D	41	ASP	2.1
2	D	38	GLY	2.1
3	E	124	GLN	2.1
1	A	9	VAL	2.1
1	C	137	VAL	2.1
1	A	317	LEU	2.1
1	C	151[A]	SER	2.1
4	F	39	LEU	2.1
4	F	172	PHE	2.1
2	B	302	MET	2.1
4	F	165	GLU	2.1
4	F	150	LYS	2.1
4	F	239	HIS	2.1
2	B	80	SER	2.1
2	D	114	LEU	2.1
1	C	17	GLY	2.1
4	F	73	ARG	2.1
2	B	269	MET	2.0
4	F	339	ALA	2.0
2	D	201	THR	2.0
1	A	42	ILE	2.0
2	D	67	LEU	2.0

*Continued on next page...*

*Continued from previous page...*

Mol	Chain	Res	Type	RSRZ
4	F	240	LEU	2.0
2	B	235	MET	2.0
1	C	139	HIS	2.0
1	A	147	SER	2.0
2	D	249	ASN	2.0
1	A	146	GLY	2.0
4	F	192	LEU	2.0
2	D	110	GLU	2.0
4	F	102	PRO	2.0
1	A	280	LYS	2.0
2	D	129	CYS	2.0
2	D	287	THR	2.0
4	F	126	ASP	2.0
2	B	245	PRO	2.0

## 6.2 Non-standard residues in protein, DNA, RNA chains [i](#)

There are no non-standard protein/DNA/RNA residues in this entry.

## 6.3 Carbohydrates [i](#)

There are no monosaccharides in this entry.

## 6.4 Ligands [i](#)

In the following table, the Atoms column lists the number of modelled atoms in the group and the number defined in the chemical component dictionary. The B-factors column lists the minimum, median, 95<sup>th</sup> percentile and maximum values of B factors of atoms in the group. The column labelled 'Q< 0.9' lists the number of atoms with occupancy less than 0.9.

Mol	Type	Chain	Res	Atoms	RSCC	RSR	B-factors(Å <sup>2</sup> )	Q<0.9
7	CA	D	502	1/1	0.65	0.53	100,100,100,100	0
7	CA	E	201	1/1	0.66	0.16	83,83,83,83	0
7	CA	B	505	1/1	0.71	0.08	93,93,93,93	0
11	ACP	F	402	31/31	0.77	0.28	99,114,133,139	0
10	DN0	D	504	32/32	0.81	0.28	61,74,89,92	0
10	DN0	B	506	32/32	0.81	0.24	50,65,90,108	0
7	CA	B	504	1/1	0.83	0.10	101,101,101,101	0
6	MG	F	401	1/1	0.89	0.14	98,98,98,98	0
9	MES	B	503	12/12	0.92	0.17	50,62,76,79	0

*Continued on next page...*

Continued from previous page...

Mol	Type	Chain	Res	Atoms	RSCC	RSR	B-factors( $\text{\AA}^2$ )	Q<0.9
5	GTP	D	503	32/32	0.92	0.18	67,76,89,94	0
9	MES	B	507	12/12	0.93	0.28	72,85,94,98	0
6	MG	B	502	1/1	0.94	0.08	39,39,39,39	0
6	MG	D	501	1/1	0.94	0.11	74,74,74,74	0
8	GDP	B	501	28/28	0.95	0.19	39,47,67,77	0
6	MG	C	502	1/1	0.95	0.08	42,42,42,42	0
5	GTP	C	501	32/32	0.97	0.17	30,43,55,57	0
7	CA	A	503	1/1	0.97	0.03	72,72,72,72	0
5	GTP	A	501	32/32	0.97	0.16	28,49,60,66	0
6	MG	A	502	1/1	0.97	0.10	40,40,40,40	0
7	CA	C	503	1/1	0.98	0.08	65,65,65,65	0

The following is a graphical depiction of the model fit to experimental electron density of all instances of the Ligand of Interest. In addition, ligands with molecular weight > 250 and outliers as shown on the geometry validation Tables will also be included. Each fit is shown from different orientation to approximate a three-dimensional view.

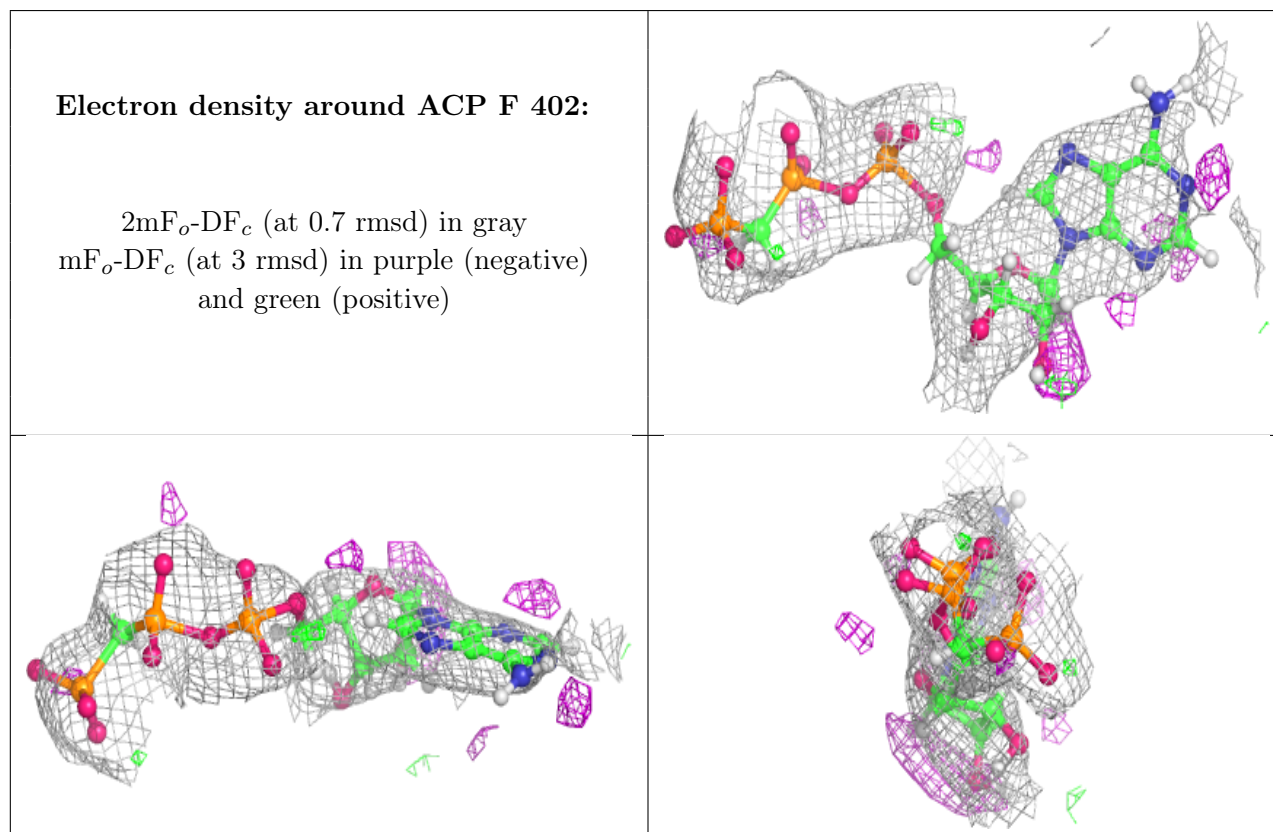

**Electron density around DN0 D 504:**

$2mF_o-DF_c$  (at 0.7 rmsd) in gray  
 $mF_o-DF_c$  (at 3 rmsd) in purple (negative)  
and green (positive)

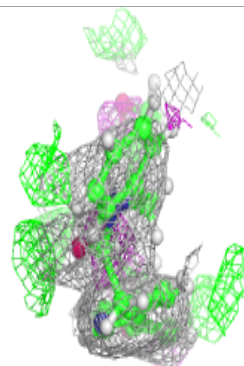
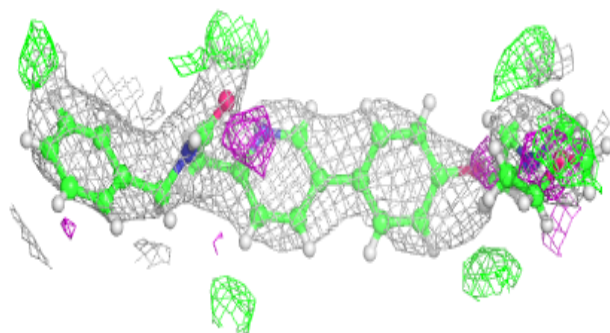
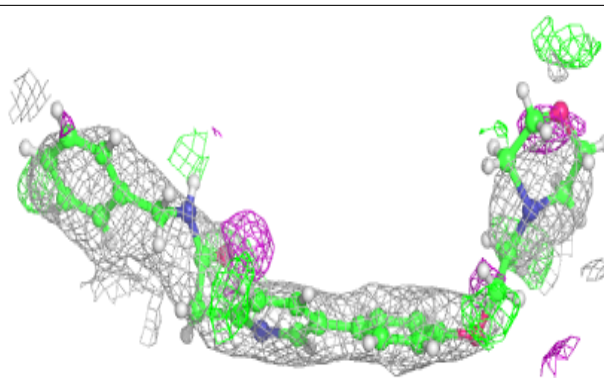
**Electron density around DN0 B 506:**

$2mF_o-DF_c$  (at 0.7 rmsd) in gray  
 $mF_o-DF_c$  (at 3 rmsd) in purple (negative)  
and green (positive)

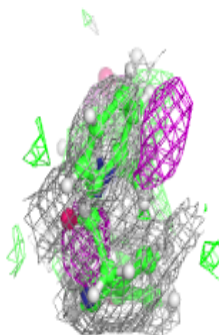
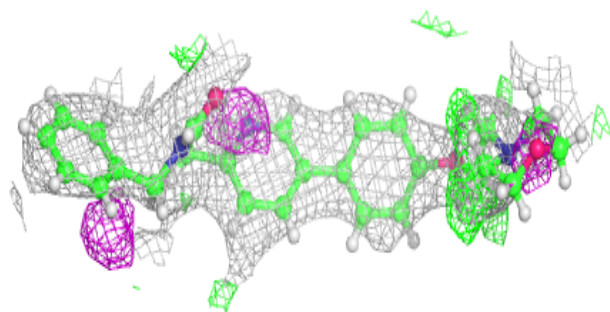
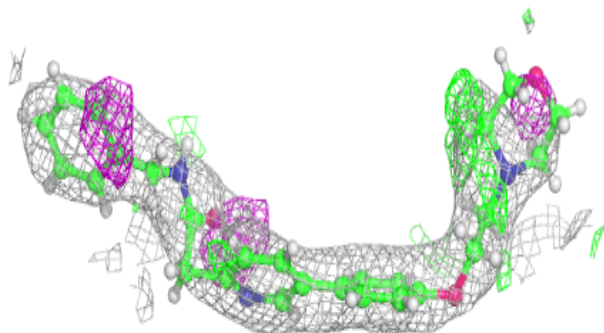

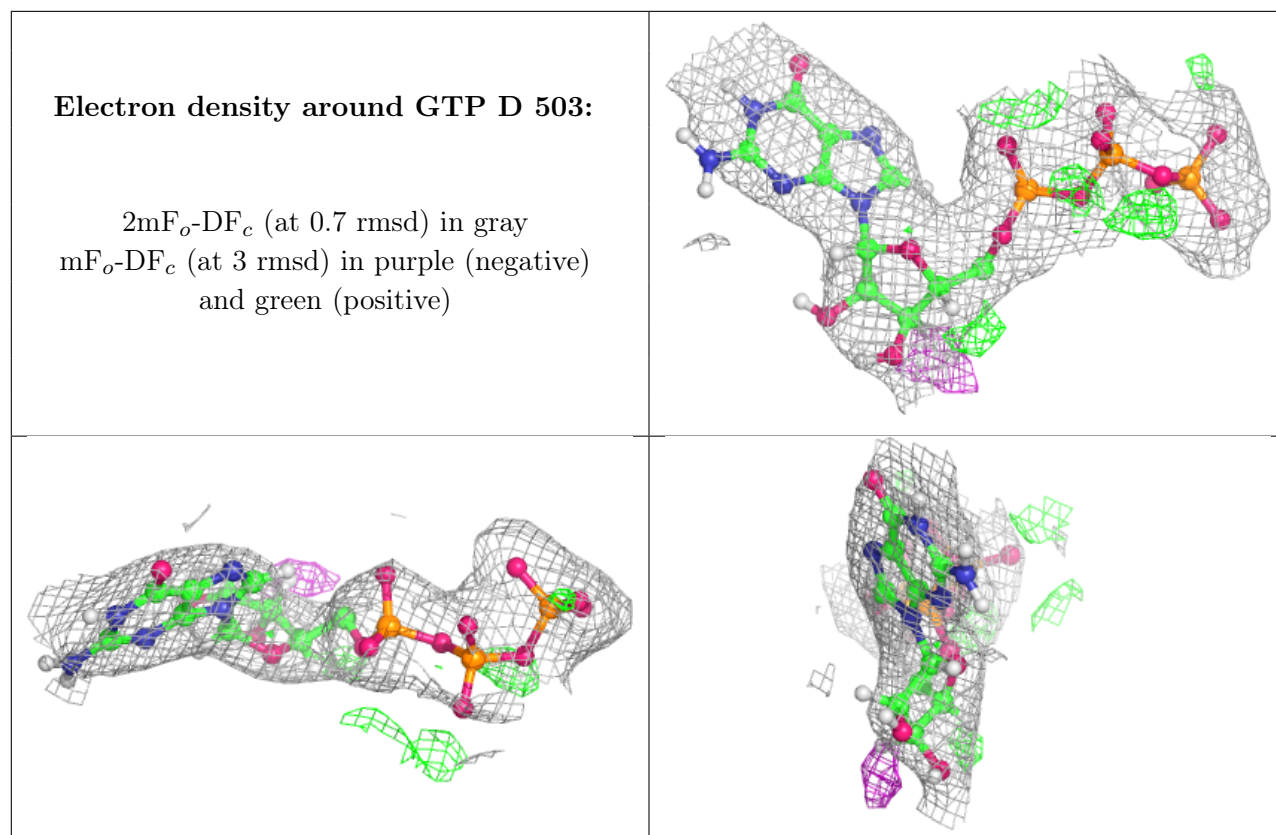

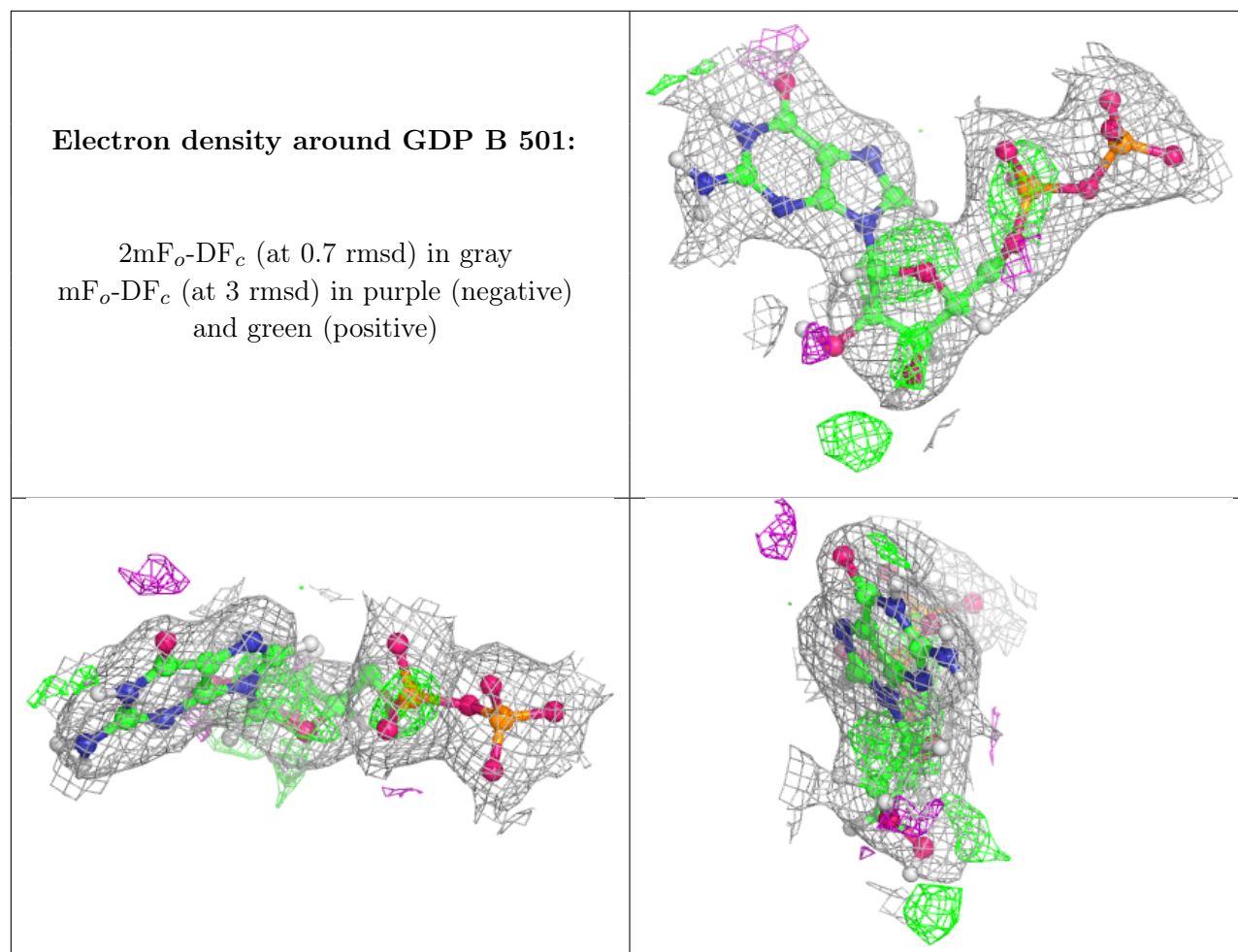



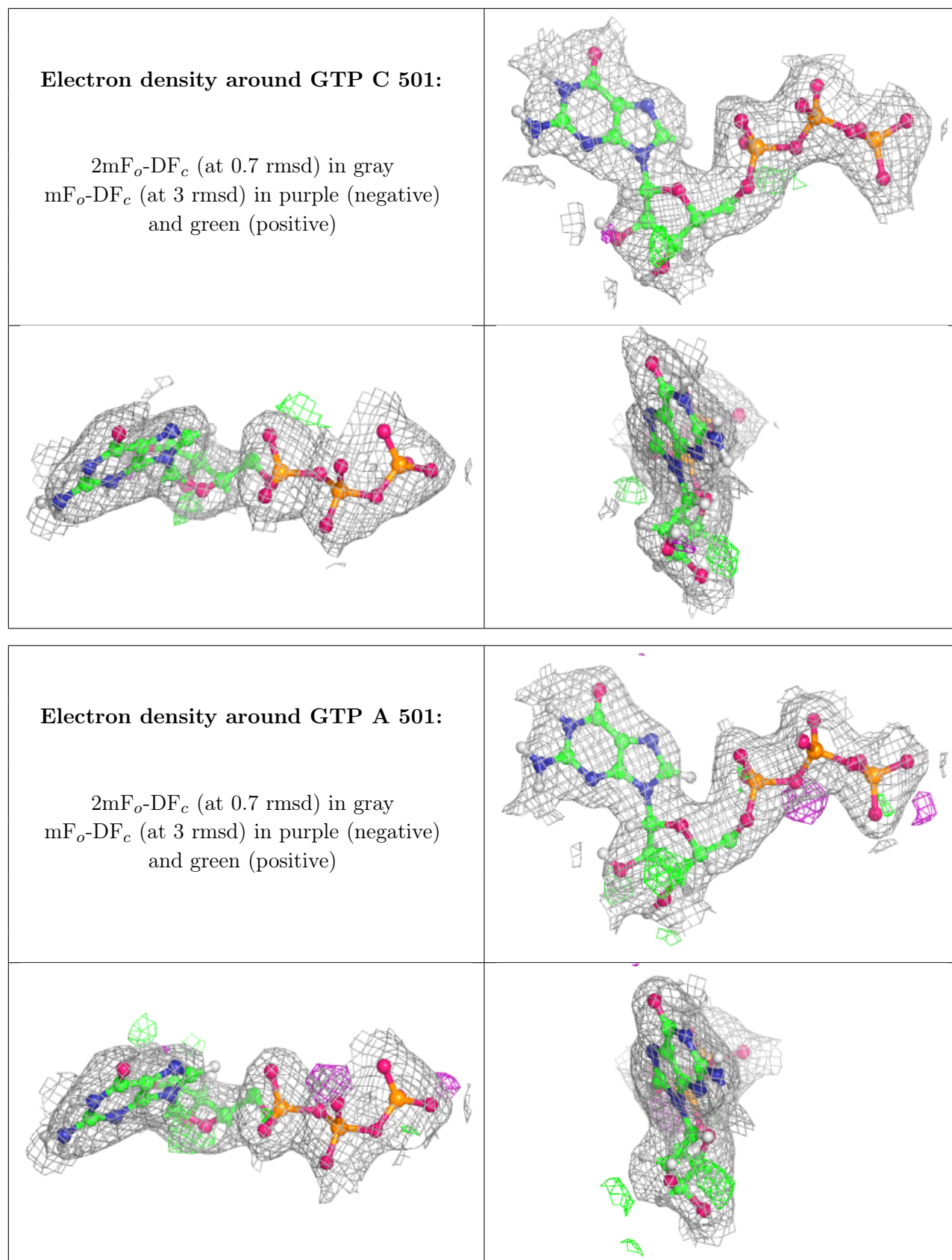



## 6.5 Other polymers [i](#)

There are no such residues in this entry.