



wwPDB EM Validation Summary Report ⓘ

Nov 20, 2022 – 02:58 pm GMT

PDB ID : 5LCW
EMDB ID : EMD-4037
Title : Cryo-EM structure of the Anaphase-promoting complex/Cyclosome, in complex with the Mitotic checkpoint complex (APC/C-MCC) at 4.2 angstrom resolution
Authors : Alfieri, C.; Chang, L.; Zhang, Z.; Yang, J.; Maslen, S.; Skehel, M.; Barford, D.
Deposited on : 2016-06-22
Resolution : 4.00 Å(reported)

This is a wwPDB EM Validation Summary Report for a publicly released PDB entry.

We welcome your comments at validation@mail.wwpdb.org

A user guide is available at

<https://www.wwpdb.org/validation/2017/EMValidationReportHelp>

with specific help available everywhere you see the ⓘ symbol.

The types of validation reports are described at

<http://www.wwpdb.org/validation/2017/FAQs#types>.

The following versions of software and data (see [references ⓘ](#)) were used in the production of this report:

EMDB validation analysis : 0.0.1.dev43
MolProbity : 4.02b-467
Percentile statistics : 20191225.v01 (using entries in the PDB archive December 25th 2019)
MapQ : 1.9.9
Ideal geometry (proteins) : Engh & Huber (2001)
Ideal geometry (DNA, RNA) : Parkinson et al. (1996)
Validation Pipeline (wwPDB-VP) : 2.31.2

1 Overall quality at a glance i

The following experimental techniques were used to determine the structure:

ELECTRON MICROSCOPY

The reported resolution of this entry is 4.00 Å.

Percentile scores (ranging between 0-100) for global validation metrics of the entry are shown in the following graphic. The table shows the number of entries on which the scores are based.

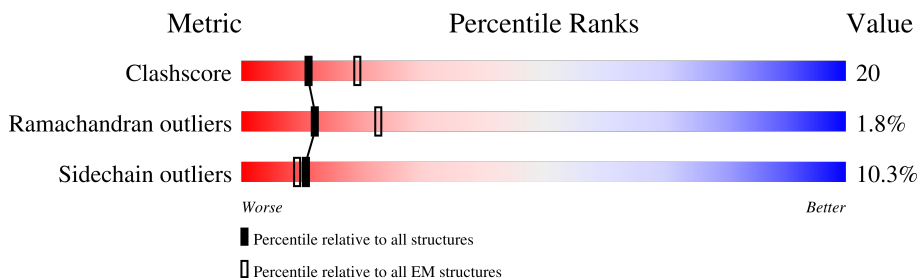

Metric	Whole archive (#Entries)	EM structures (#Entries)
Clashscore	158937	4297
Ramachandran outliers	154571	4023
Sidechain outliers	154315	3826

The table below summarises the geometric issues observed across the polymeric chains and their fit to the map. The red, orange, yellow and green segments of the bar indicate the fraction of residues that contain outliers for ≥ 3 , 2, 1 and 0 types of geometric quality criteria respectively. A grey segment represents the fraction of residues that are not modelled. The numeric value for each fraction is indicated below the corresponding segment, with a dot representing fractions $\leq 5\%$. The upper red bar (where present) indicates the fraction of residues that have poor fit to the EM map (all-atom inclusion $< 40\%$). The numeric value is given above the bar.

Mol	Chain	Length	Quality of chain
1	A	1944	<div style="display: flex; justify-content: space-between;"> 11% 45% 25% • 26% </div>
2	B	84	<div style="display: flex; justify-content: space-between;"> 79% 40% 42% 8% • 6% </div>
3	C	597	<div style="display: flex; justify-content: space-between;"> 11% 55% 30% • 12% </div>
3	P	597	<div style="display: flex; justify-content: space-between;"> 8% 54% 24% • 18% </div>
4	D	121	<div style="display: flex; justify-content: space-between;"> 7% 6% 8% • 85% </div>
5	E	110	<div style="display: flex; justify-content: space-between;"> • 34% 15% • 49% </div>
6	F	824	<div style="display: flex; justify-content: space-between;"> • 40% 17% • 41% </div>
6	H	824	<div style="display: flex; justify-content: space-between;"> • 40% 17% • 41% </div>

Continued on next page...

Continued from previous page...

Mol	Chain	Length	Quality of chain
7	G	85	16% 12% 71%
7	W	85	18% 9% 71%
8	I	808	19% 55% 33% 9%
9	J	620	50% 26% 5% 19%
9	K	620	48% 28% 20%
10	L	185	9% 61% 34% 2% 2%
11	M	74	15% 47% 28% 20%
12	N	822	23% 48% 28% 7% 14%
13	O	755	17% 57% 28% 6% 9%
14	Q	374	22% 74% 19% 5%
15	R	499	15% 56% 19% 23%
16	S	342	21% 47% 29% 5% 19%
17	X	599	13% 53% 26% 19%
17	Y	599	7% 52% 27% 17%
18	Z	205	26% 69% 21% 5%

2 Entry composition i

There are 18 unique types of molecules in this entry. The entry contains 72075 atoms, of which 0 are hydrogens and 0 are deuteriums.

In the tables below, the AltConf column contains the number of residues with at least one atom in alternate conformation and the Trace column contains the number of residues modelled with at most 2 atoms.

- Molecule 1 is a protein called Anaphase-promoting complex subunit 1.

Mol	Chain	Residues	Atoms					AltConf	Trace
			Total	C	N	O	S		
1	A	1441	10949	7039	1853	1983	74	0	0

There is a discrepancy between the modelled and reference sequences:

Chain	Residue	Modelled	Actual	Comment	Reference
A	356	PHE	PRO	conflict	UNP Q9H1A4

- Molecule 2 is a protein called Anaphase-promoting complex subunit 11.

Mol	Chain	Residues	Atoms					AltConf	Trace
			Total	C	N	O	S		
2	B	79	643	411	116	100	16	0	0

- Molecule 3 is a protein called Cell division cycle protein 23 homolog.

Mol	Chain	Residues	Atoms					AltConf	Trace
			Total	C	N	O	S		
3	C	524	4306	2774	727	781	24	0	0
3	P	491	4043	2611	679	729	24	0	0

- Molecule 4 is a protein called Anaphase-promoting complex subunit 15.

Mol	Chain	Residues	Atoms				AltConf	Trace
			Total	C	N	O		
4	D	18	153	104	23	26	0	0

- Molecule 5 is a protein called Anaphase-promoting complex subunit 16.

Mol	Chain	Residues	Atoms					AltConf	Trace
			Total	C	N	O	S		
5	E	56	450	290	74	85	1	0	0

- Molecule 6 is a protein called Cell division cycle protein 27 homolog.

Mol	Chain	Residues	Atoms					AltConf	Trace
			Total	C	N	O	S		
6	F	483	Total	C	N	O	S	0	0
			3849	2470	649	704	26		
6	H	483	Total	C	N	O	S	0	0
			3853	2473	650	704	26		

- Molecule 7 is a protein called Anaphase-promoting complex subunit CDC26.

Mol	Chain	Residues	Atoms					AltConf	Trace
			Total	C	N	O	S		
7	G	25	Total	C	N	O	S	0	0
			213	133	40	39	1		
7	W	25	Total	C	N	O	S	0	0
			213	133	40	39	1		

- Molecule 8 is a protein called Anaphase-promoting complex subunit 4.

Mol	Chain	Residues	Atoms					AltConf	Trace
			Total	C	N	O	S		
8	I	733	Total	C	N	O	S	0	0
			5716	3665	951	1067	33		

- Molecule 9 is a protein called Cell division cycle protein 16 homolog.

Mol	Chain	Residues	Atoms					AltConf	Trace
			Total	C	N	O	S		
9	J	504	Total	C	N	O	S	0	0
			4047	2601	684	737	25		
9	K	493	Total	C	N	O	S	0	0
			3988	2563	672	729	24		

- Molecule 10 is a protein called Anaphase-promoting complex subunit 10.

Mol	Chain	Residues	Atoms					AltConf	Trace
			Total	C	N	O	S		
10	L	182	Total	C	N	O	S	0	0
			1435	898	263	268	6		

- Molecule 11 is a protein called Anaphase-promoting complex subunit 13.

Mol	Chain	Residues	Atoms					AltConf	Trace
			Total	C	N	O	S		
11	M	59	Total	C	N	O	S	0	0
			493	310	79	102	2		

- Molecule 12 is a protein called Anaphase-promoting complex subunit 2.

Mol	Chain	Residues	Atoms					AltConf	Trace
			Total	C	N	O	S		
12	N	703	5403	3436	971	971	25	0	0

- Molecule 13 is a protein called Anaphase-promoting complex subunit 5.

Mol	Chain	Residues	Atoms					AltConf	Trace
			Total	C	N	O	S		
13	O	685	5402	3446	940	988	28	0	0

- Molecule 14 is a protein called Cell division cycle protein 20 homolog.

Mol	Chain	Residues	Atoms					AltConf	Trace
			Total	C	N	O	S		
14	Q	354	2671	1676	488	496	11	0	0

- Molecule 15 is a protein called Cell division cycle protein 20 homolog.

Mol	Chain	Residues	Atoms					AltConf	Trace
			Total	C	N	O	S		
15	R	383	2953	1855	538	548	12	0	0

- Molecule 16 is a protein called Mitotic checkpoint serine/threonine-protein kinase BUB1 beta, Mitotic checkpoint serine/threonine-protein kinase BUB1 beta.

Mol	Chain	Residues	Atoms					AltConf	Trace
			Total	C	N	O	S		
16	S	277	2077	1292	380	400	5	0	0

- Molecule 17 is a protein called Anaphase-promoting complex subunit 7.

Mol	Chain	Residues	Atoms					AltConf	Trace
			Total	C	N	O	S		
17	X	484	3773	2393	652	704	24	0	0
17	Y	496	3868	2449	669	724	26	0	0

- Molecule 18 is a protein called Mitotic spindle assembly checkpoint protein MAD2A.

Mol	Chain	Residues	Atoms					AltConf	Trace
			Total	C	N	O	S		
18	Z	195	1577	1012	256	305	4	0	0

3 Residue-property plots

These plots are drawn for all protein, RNA, DNA and oligosaccharide chains in the entry. The first graphic for a chain summarises the proportions of the various outlier classes displayed in the second graphic. The second graphic shows the sequence view annotated by issues in geometry and atom inclusion in map density. Residues are color-coded according to the number of geometric quality criteria for which they contain at least one outlier: green = 0, yellow = 1, orange = 2 and red = 3 or more. A red diamond above a residue indicates a poor fit to the EM map for this residue (all-atom inclusion < 40%). Stretches of 2 or more consecutive residues without any outlier are shown as a green connector. Residues present in the sample, but not in the model, are shown in grey.

• Molecule 1: Anaphase-promoting complex subunit 1

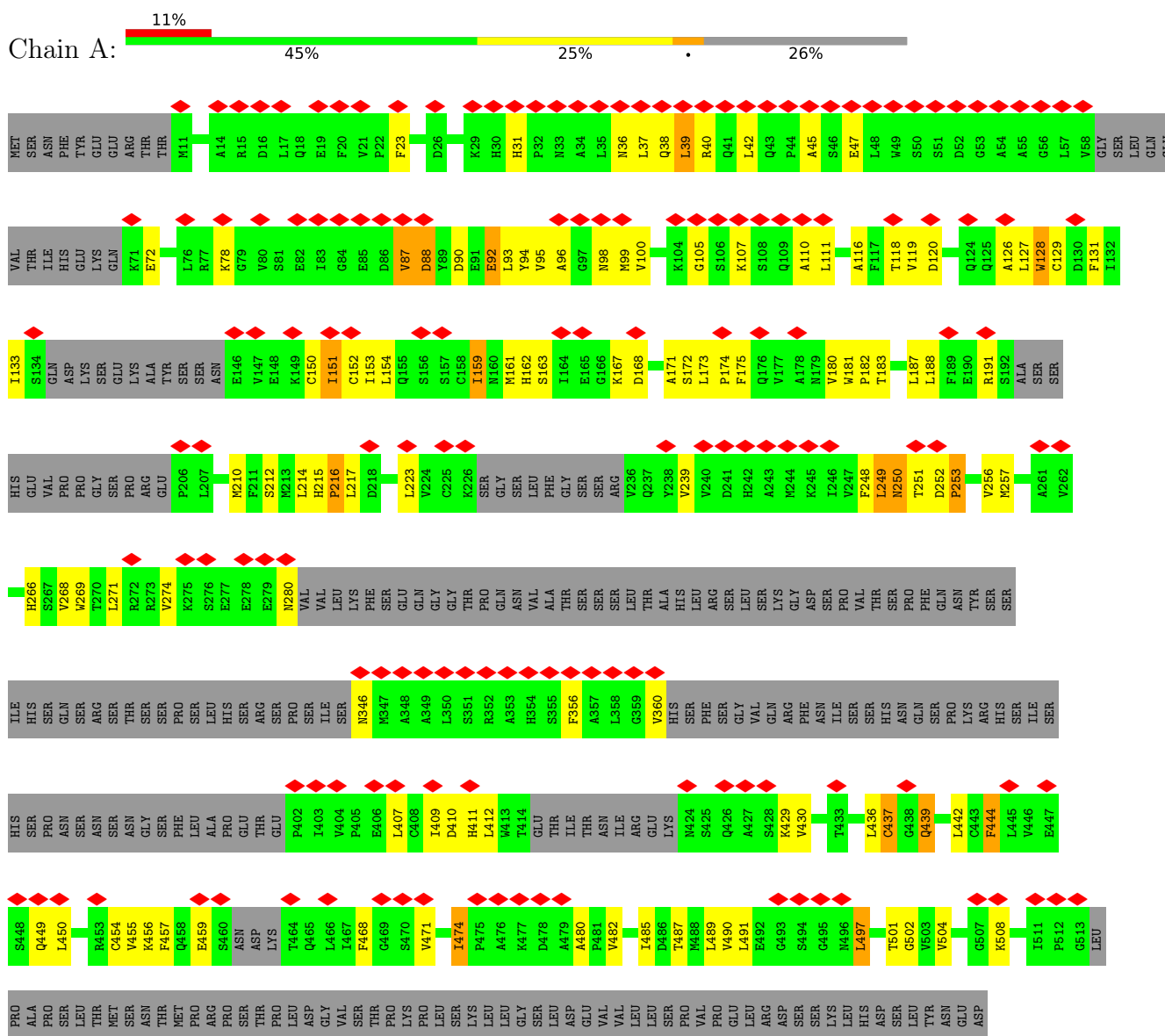

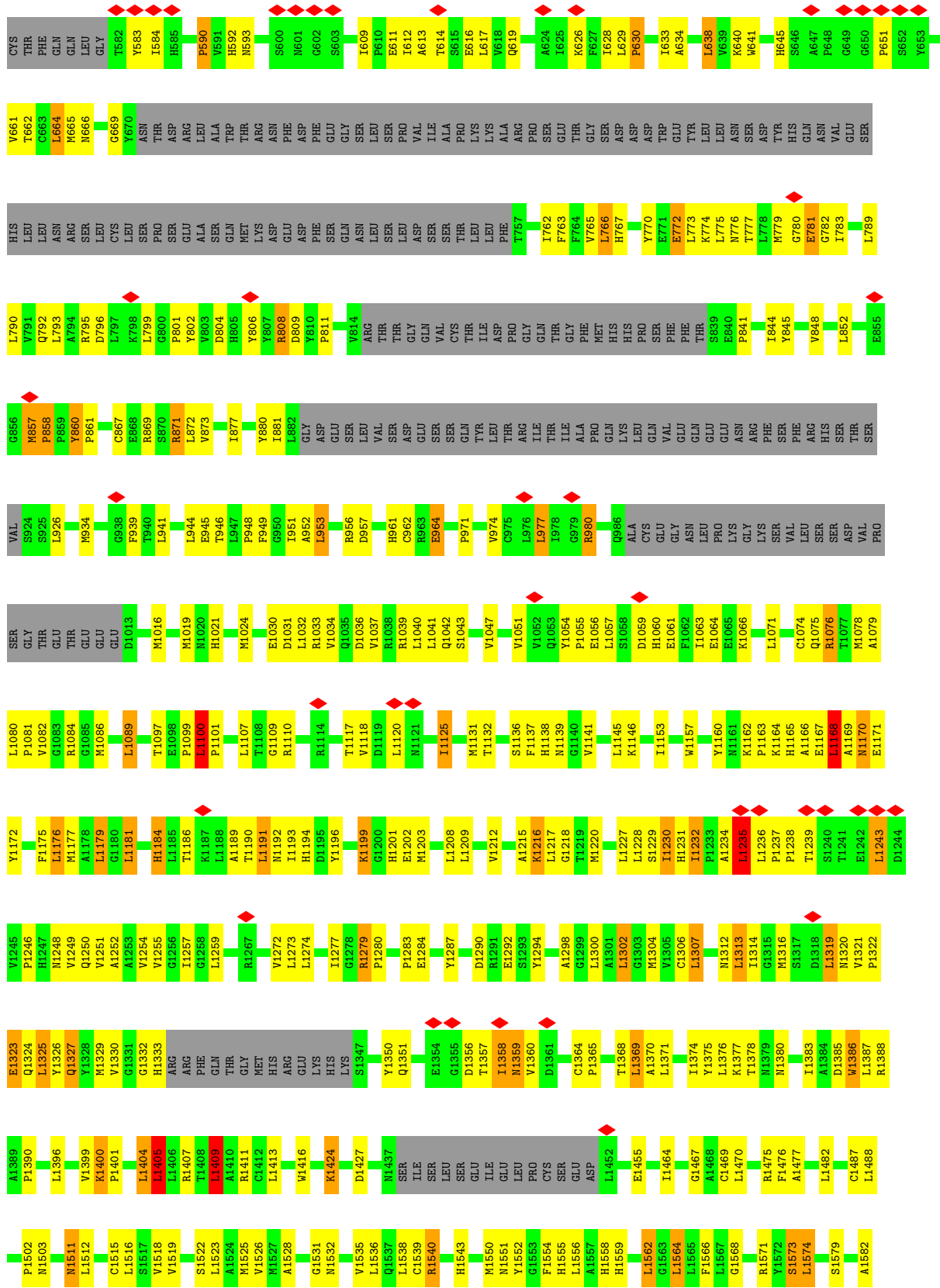

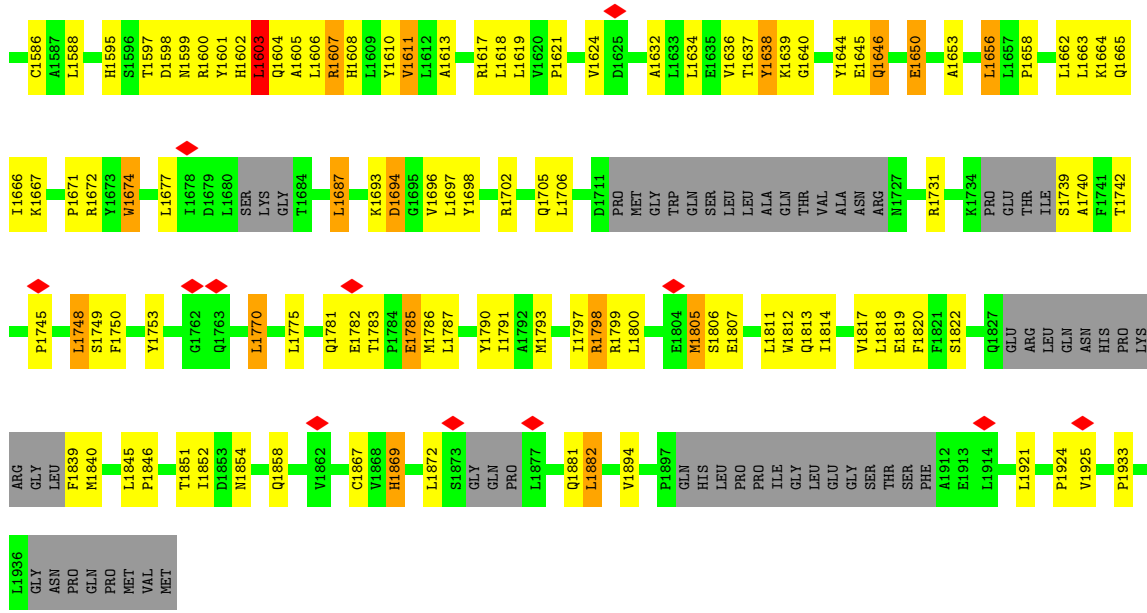

• Molecule 2: Anaphase-promoting complex subunit 11

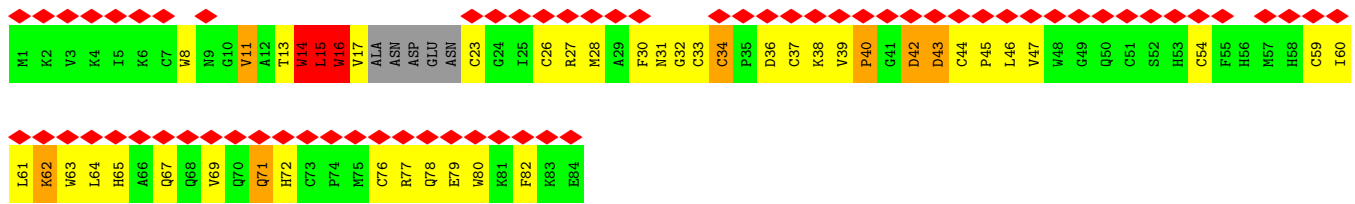
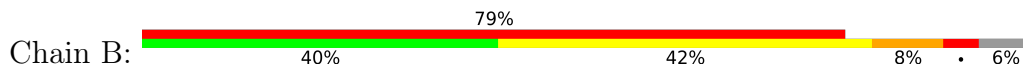

• Molecule 3: Cell division cycle protein 23 homolog

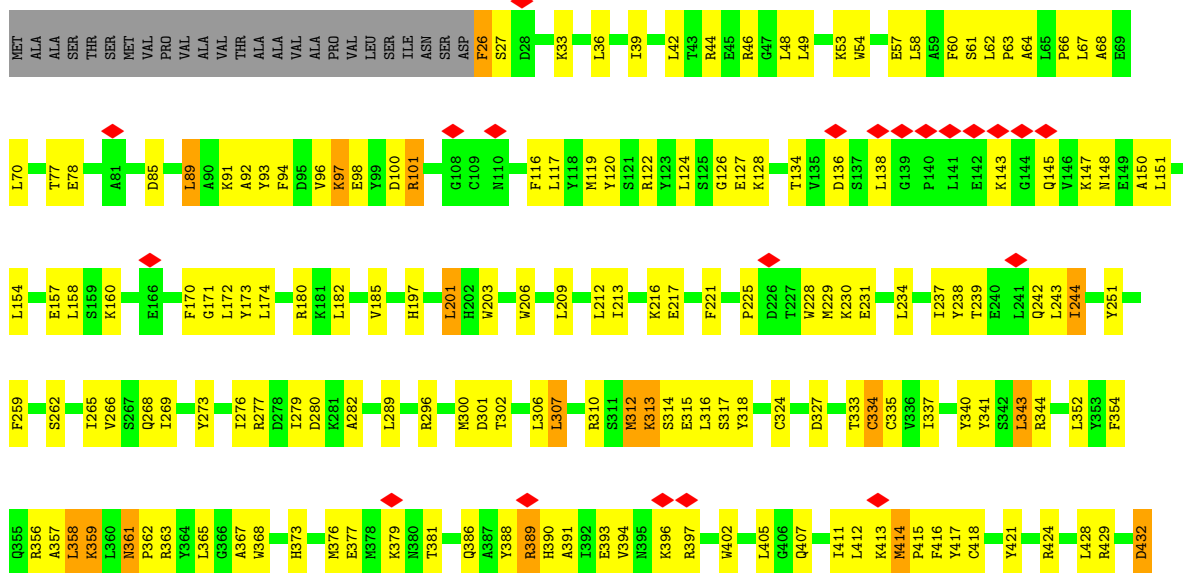

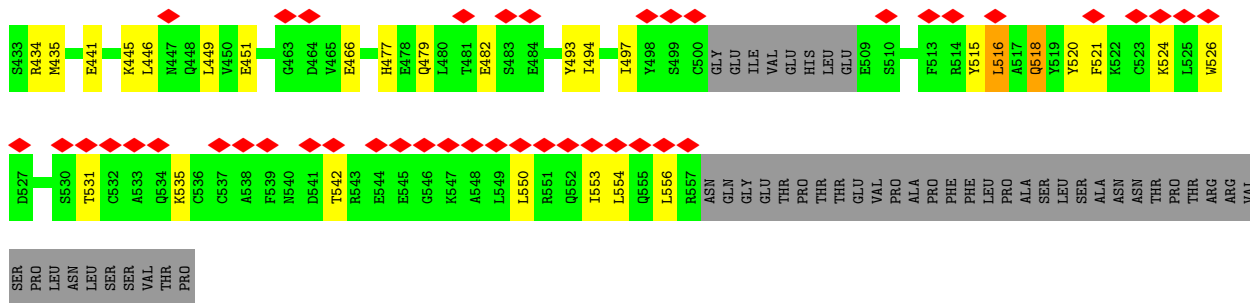

• Molecule 3: Cell division cycle protein 23 homolog

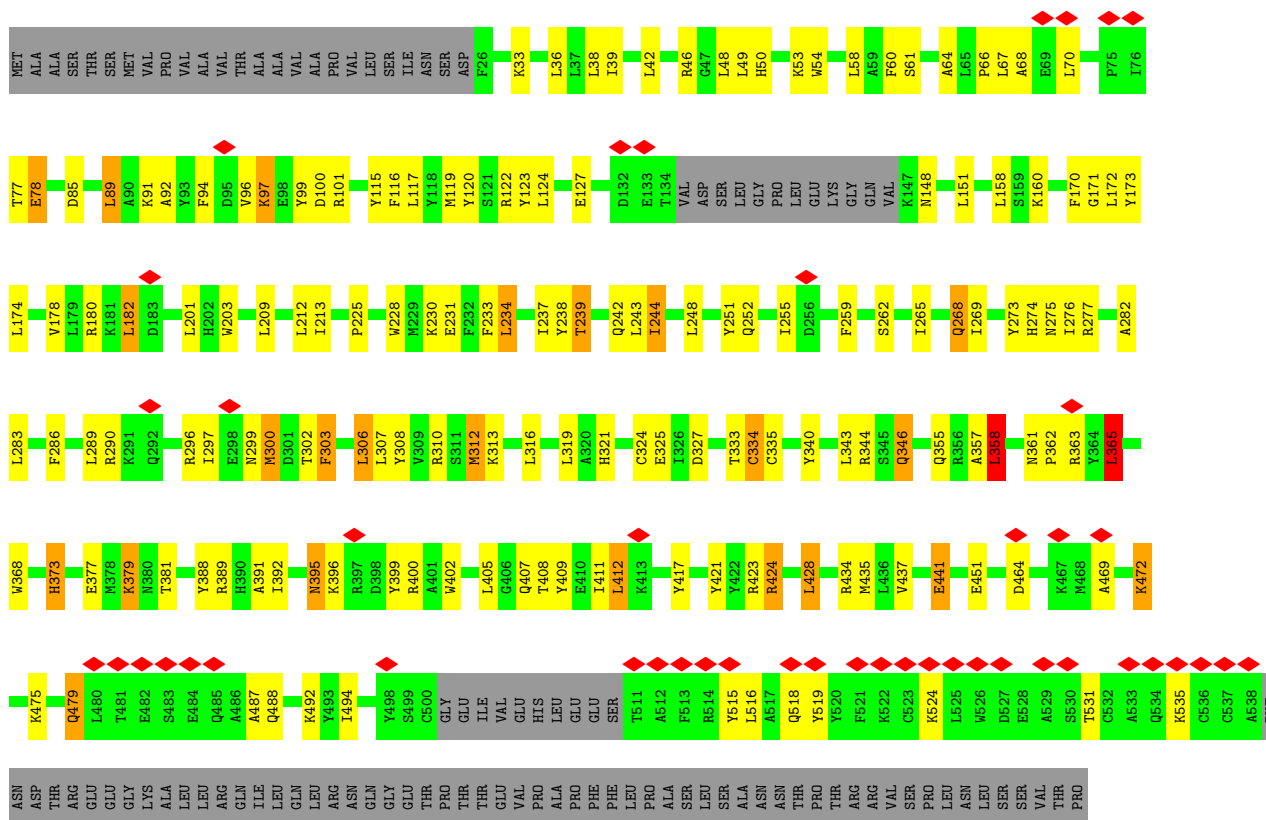

• Molecule 4: Anaphase-promoting complex subunit 15

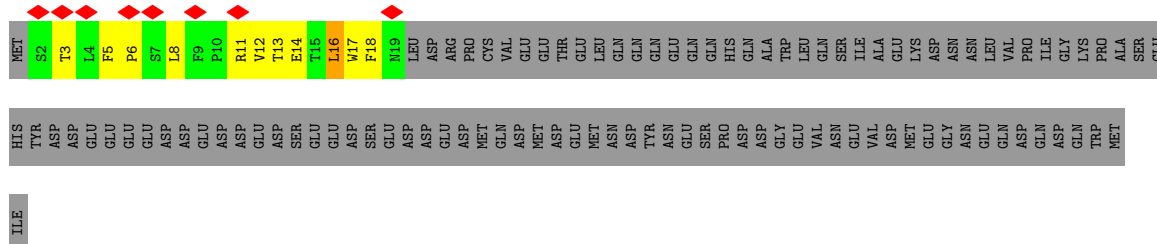

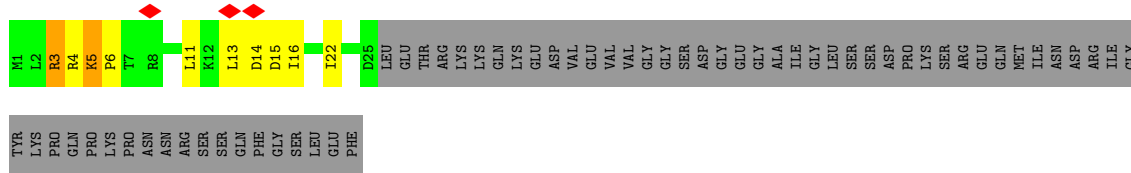

• Molecule 8: Anaphase-promoting complex subunit 4

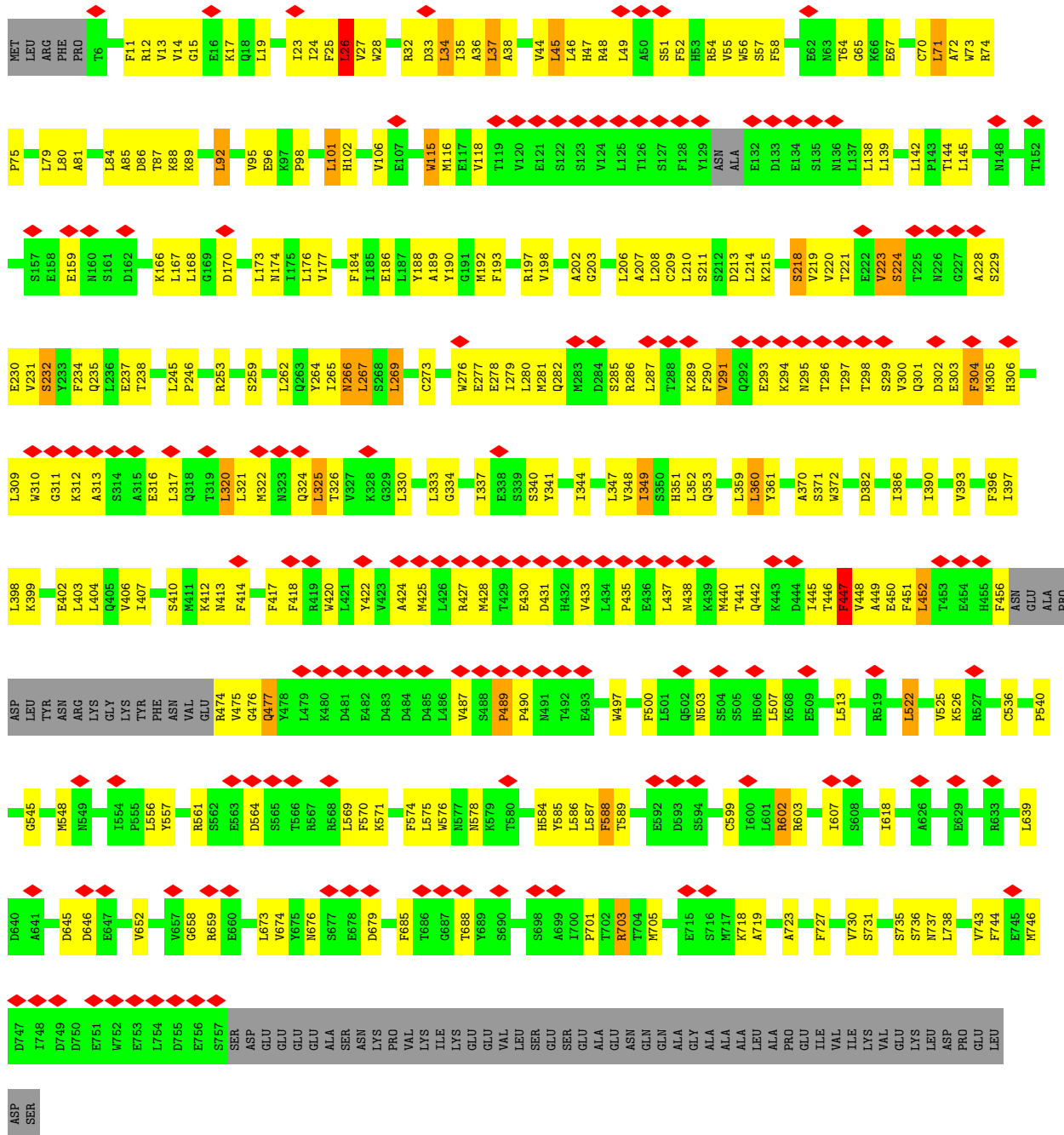

• Molecule 9: Cell division cycle protein 16 homolog

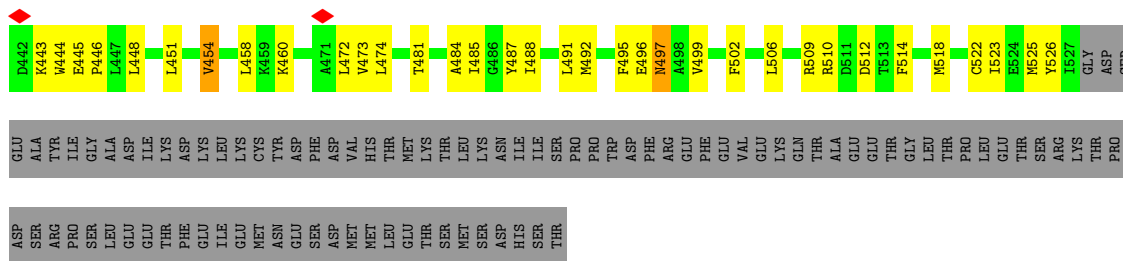

● Molecule 10: Anaphase-promoting complex subunit 10

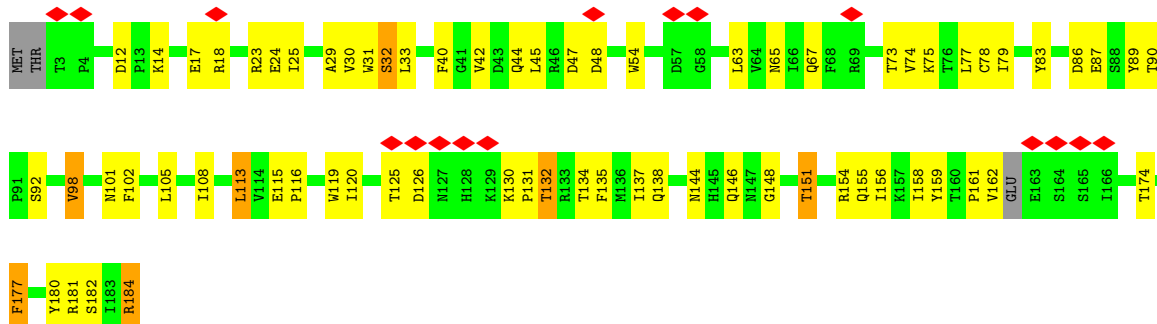

● Molecule 11: Anaphase-promoting complex subunit 13

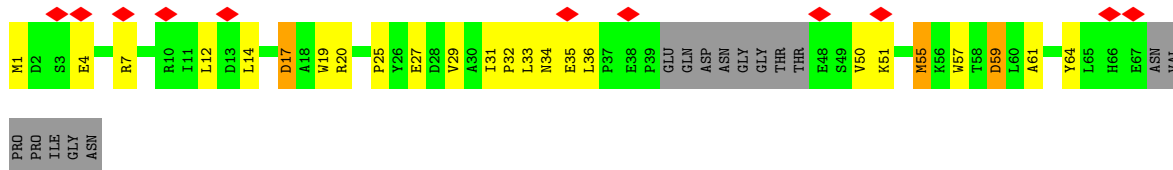

● Molecule 12: Anaphase-promoting complex subunit 2

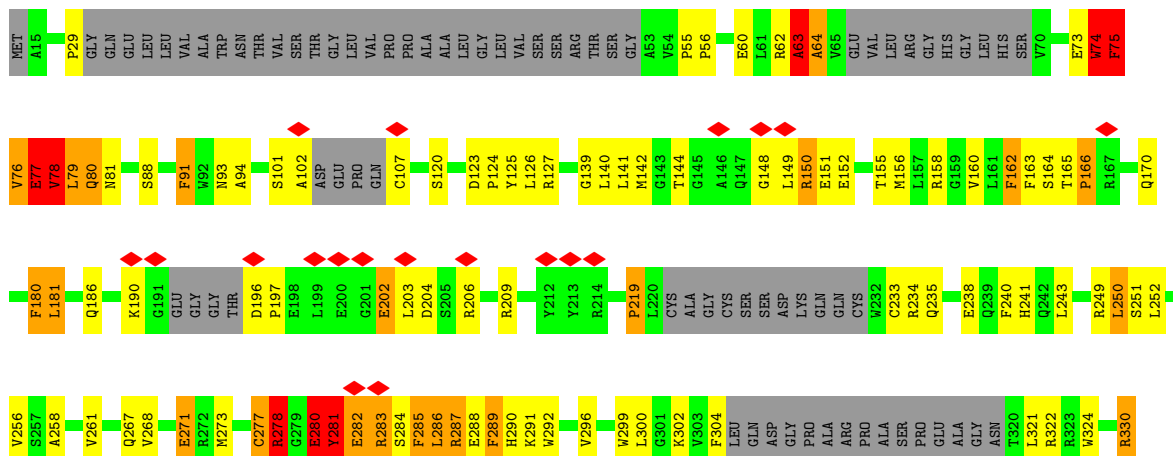

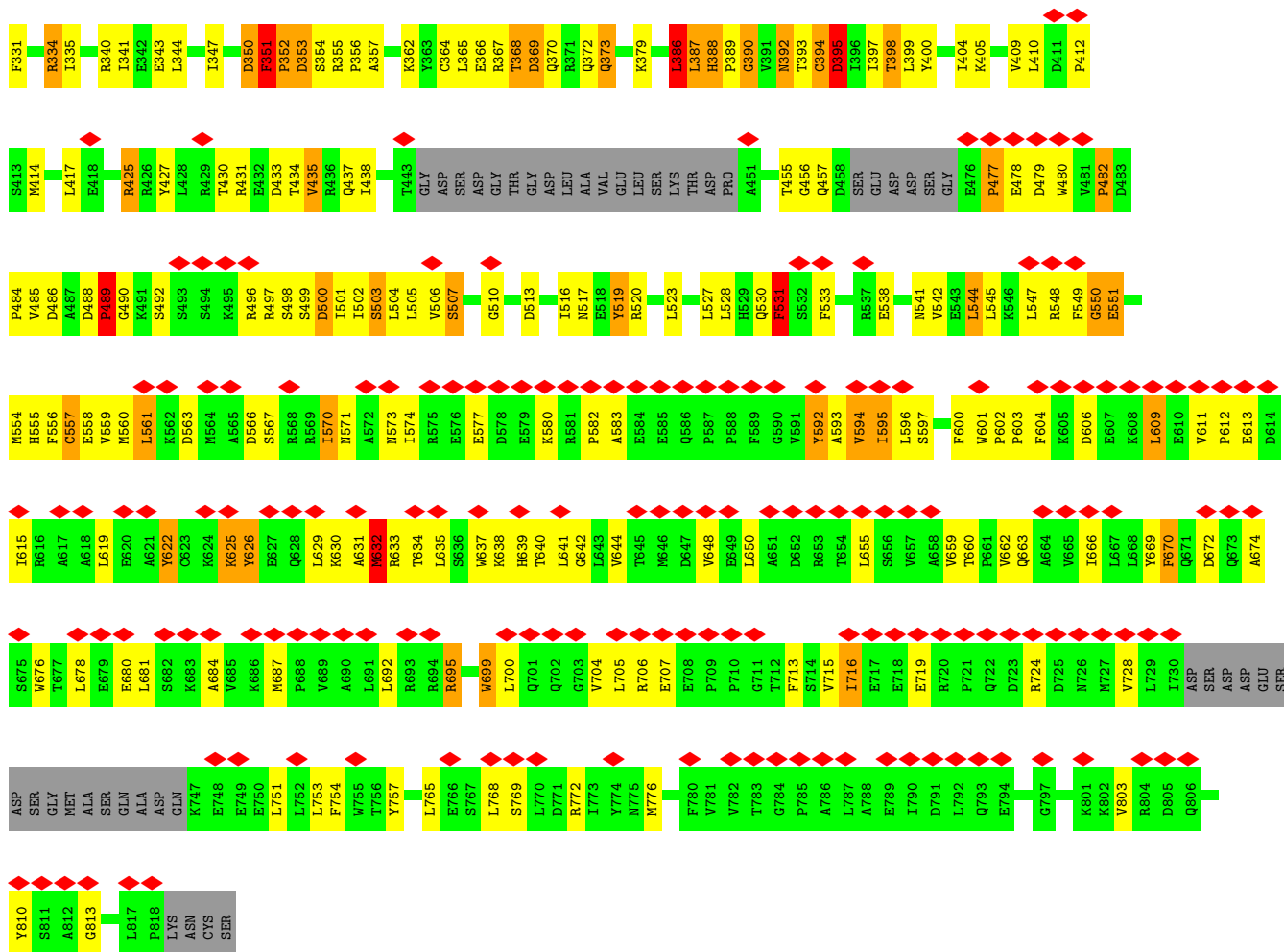

● Molecule 13: Anaphase-promoting complex subunit 5

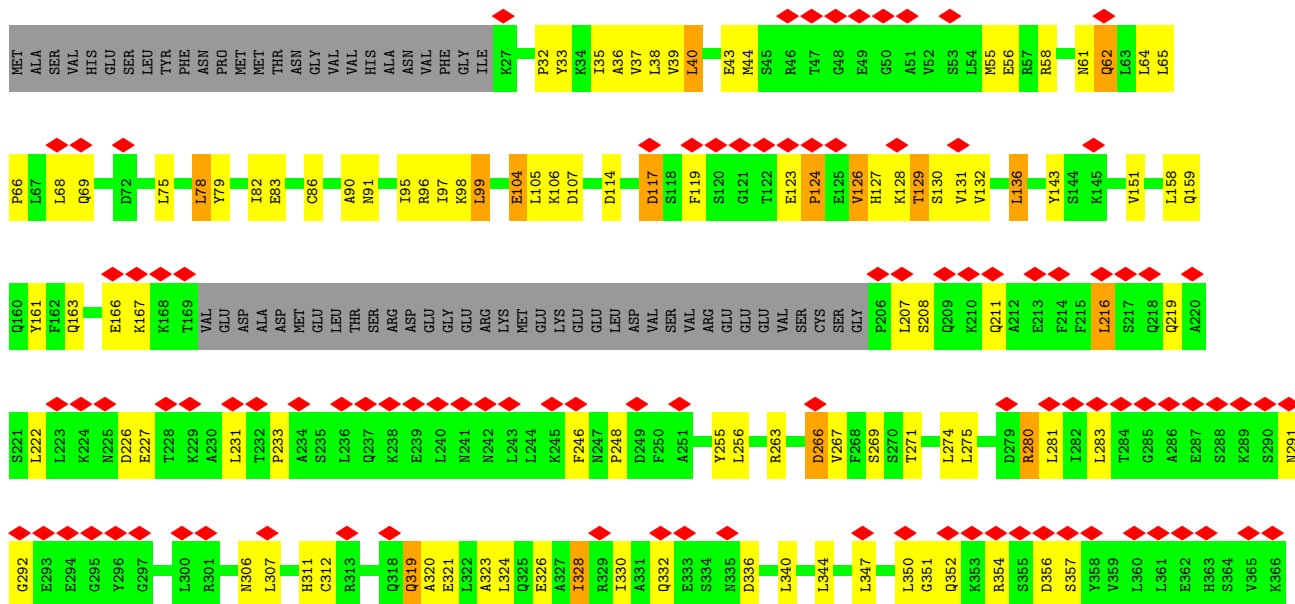

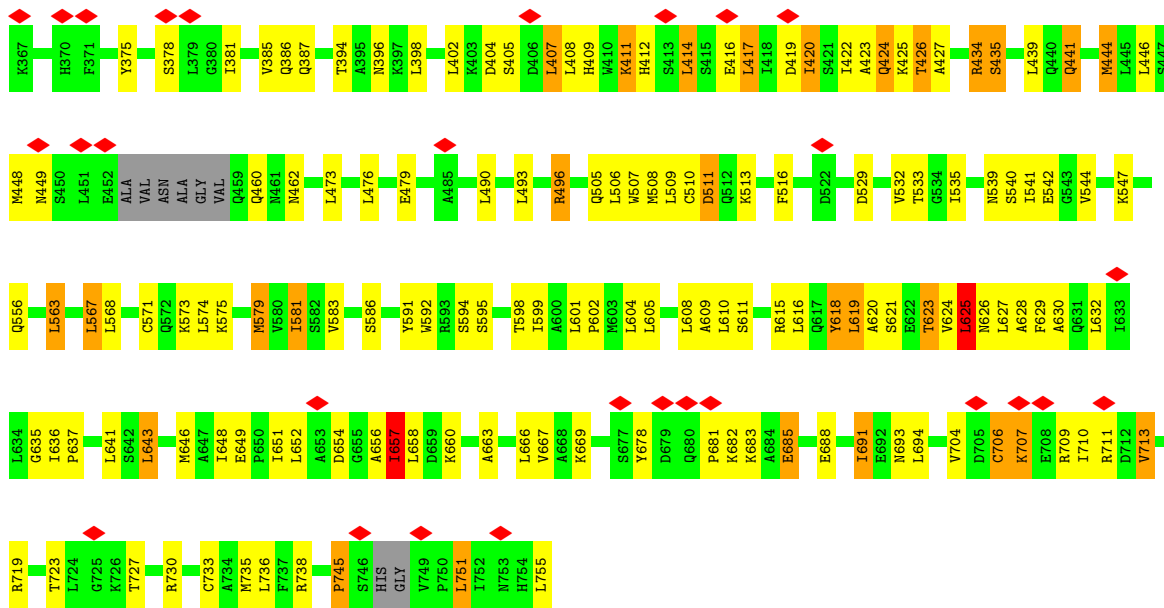

• Molecule 14: Cell division cycle protein 20 homolog

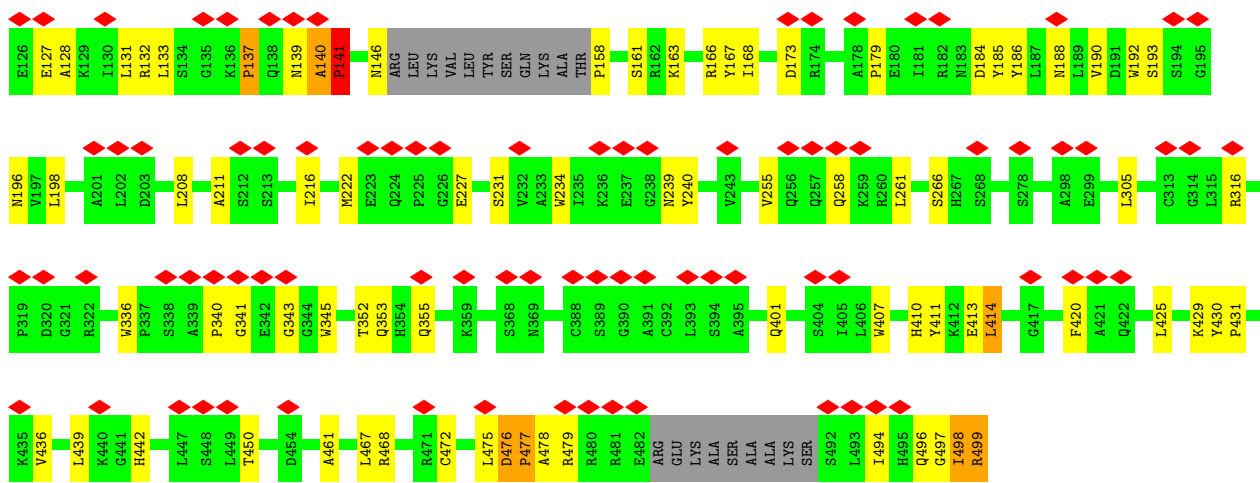
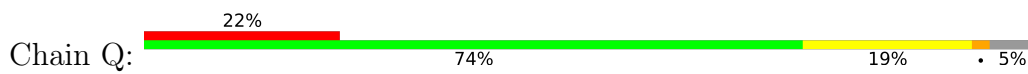

• Molecule 15: Cell division cycle protein 20 homolog

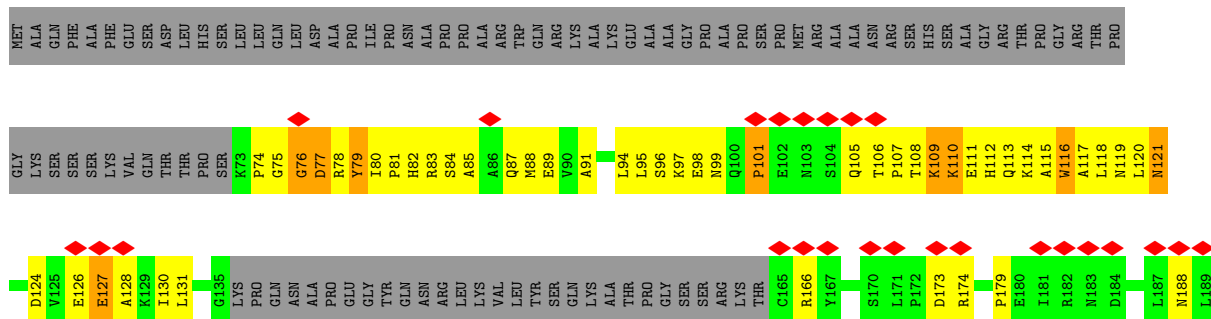

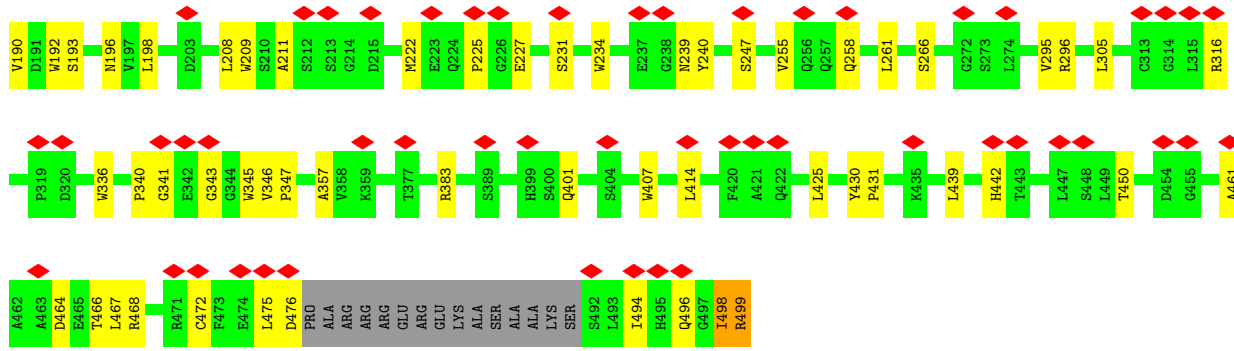

● Molecule 16: Mitotic checkpoint serine/threonine-protein kinase BUB1 beta, Mitotic checkpoint serine/threonine-protein kinase BUB1 beta

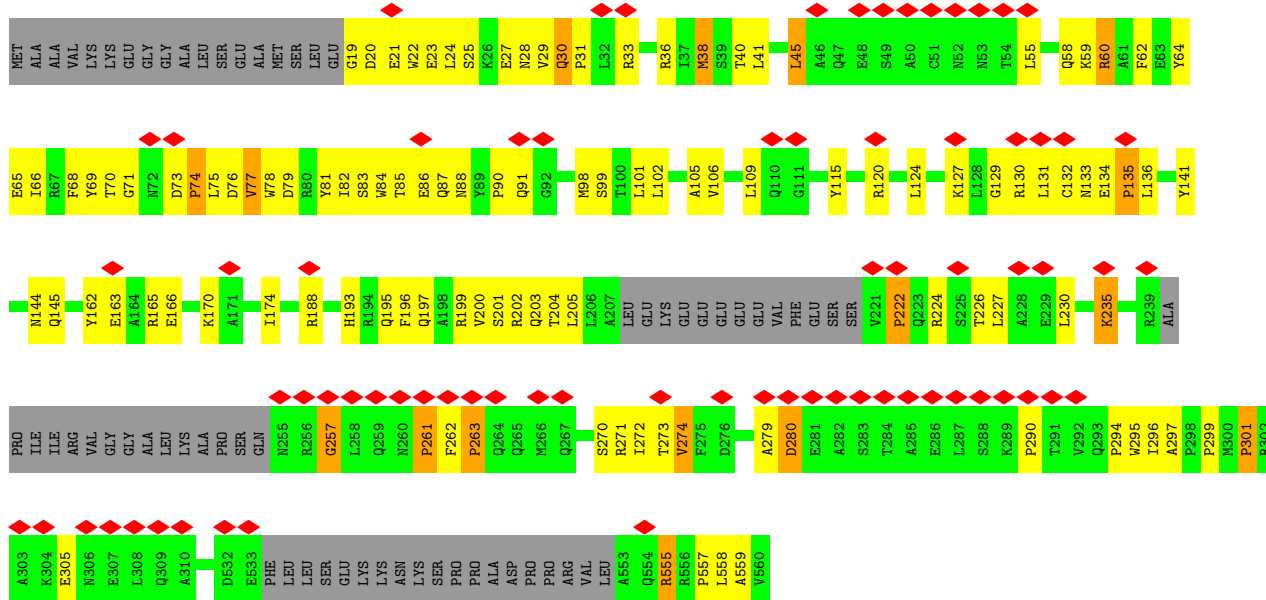

● Molecule 17: Anaphase-promoting complex subunit 7

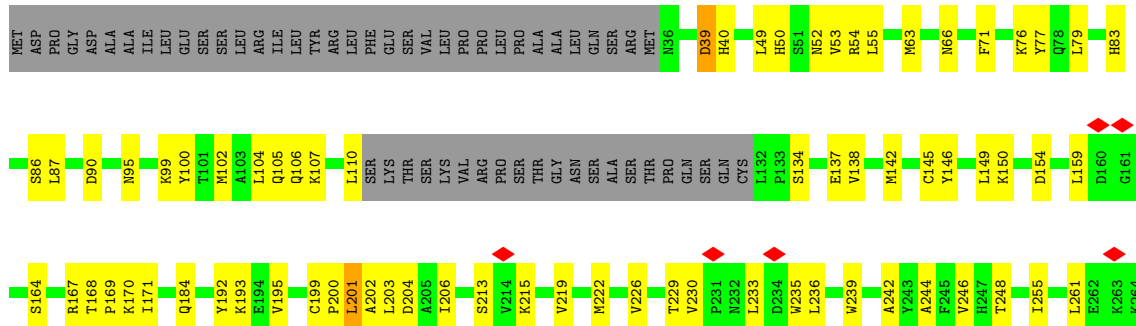

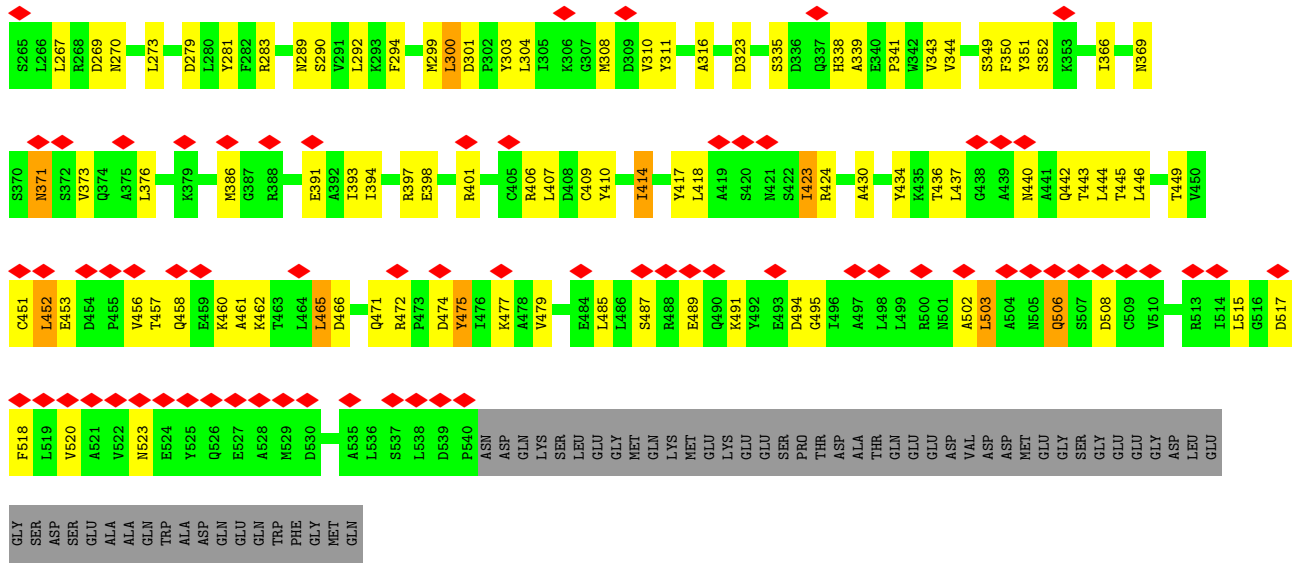

• Molecule 17: Anaphase-promoting complex subunit 7

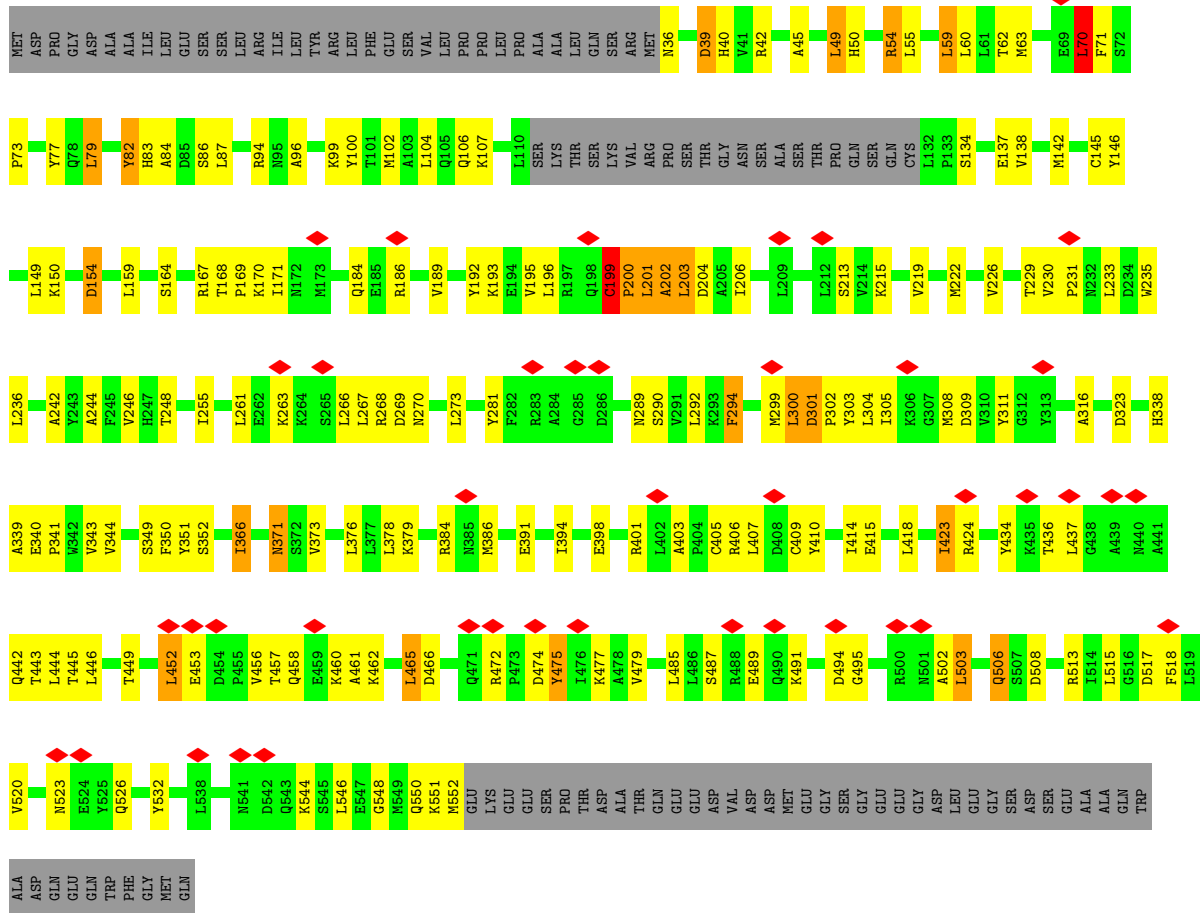

• Molecule 18: Mitotic spindle assembly checkpoint protein MAD2A

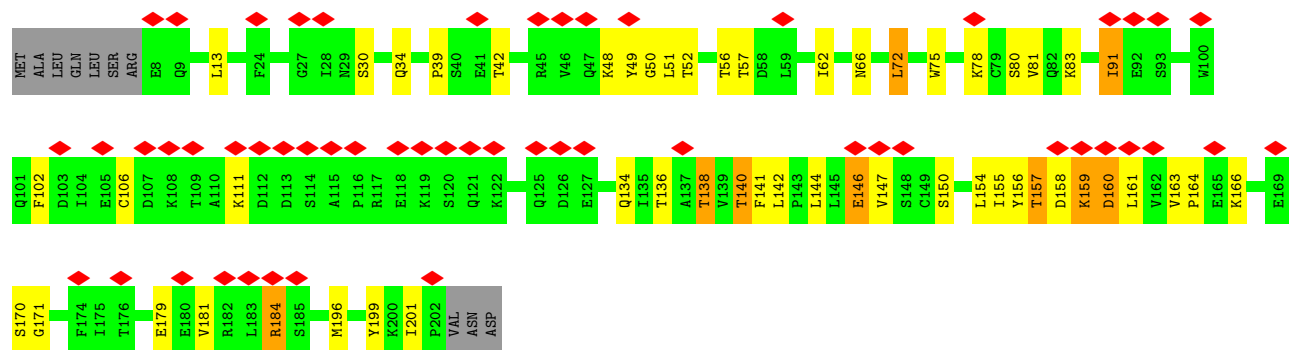

4 Experimental information

Property	Value	Source
EM reconstruction method	SINGLE PARTICLE	Depositor
Imposed symmetry	POINT, Not provided	
Number of particles used	155263	Depositor
Resolution determination method	FSC 0.143 CUT-OFF	Depositor
CTF correction method	PHASE FLIPPING AND AMPLITUDE CORRECTION	Depositor
Microscope	FEI POLARA 300	Depositor
Voltage (kV)	300	Depositor
Electron dose ($e^-/\text{\AA}^2$)	27	Depositor
Minimum defocus (nm)	Not provided	
Maximum defocus (nm)	Not provided	
Magnification	Not provided	
Image detector	FEI FALCON II (4k x 4k)	Depositor
Maximum map value	0.292	Depositor
Minimum map value	-0.094	Depositor
Average map value	0.003	Depositor
Map value standard deviation	0.015	Depositor
Recommended contour level	0.08	Depositor
Map size (\AA)	359.04, 359.04, 359.04	wwPDB
Map dimensions	264, 264, 264	wwPDB
Map angles ($^\circ$)	90.0, 90.0, 90.0	wwPDB
Pixel spacing (\AA)	1.36, 1.36, 1.36	Depositor

5 Model quality i

5.1 Standard geometry i

The Z score for a bond length (or angle) is the number of standard deviations the observed value is removed from the expected value. A bond length (or angle) with $|Z| > 5$ is considered an outlier worth inspection. RMSZ is the root-mean-square of all Z scores of the bond lengths (or angles).

Mol	Chain	Bond lengths		Bond angles	
		RMSZ	# Z >5	RMSZ	# Z >5
1	A	0.67	6/11190 (0.1%)	0.89	23/15236 (0.2%)
2	B	0.81	2/665 (0.3%)	0.98	2/896 (0.2%)
3	C	0.57	0/4404	0.83	4/5945 (0.1%)
3	P	0.60	0/4138	0.86	5/5587 (0.1%)
4	D	0.69	0/159	0.89	0/218
5	E	0.60	0/459	0.80	0/619
6	F	0.58	0/3939	0.82	3/5325 (0.1%)
6	H	0.61	2/3943 (0.1%)	0.82	2/5329 (0.0%)
7	G	0.63	0/214	1.02	1/284 (0.4%)
7	W	0.66	0/214	0.97	1/284 (0.4%)
8	I	0.66	1/5834 (0.0%)	0.92	11/7909 (0.1%)
9	J	0.71	2/4146 (0.0%)	0.95	5/5616 (0.1%)
9	K	0.73	1/4086 (0.0%)	0.93	7/5534 (0.1%)
10	L	0.54	0/1468	0.83	0/1993
11	M	0.66	0/502	0.95	0/680
12	N	0.63	3/5495 (0.1%)	0.94	18/7441 (0.2%)
13	O	0.58	0/5501	0.85	8/7432 (0.1%)
14	Q	0.72	0/2737	0.86	4/3732 (0.1%)
15	R	0.73	0/3029	0.86	2/4124 (0.0%)
16	S	0.66	0/2112	0.88	12/2863 (0.4%)
17	X	0.57	0/3833	0.82	3/5187 (0.1%)
17	Y	0.58	0/3928	0.84	9/5311 (0.2%)
18	Z	0.64	0/1605	0.79	2/2176 (0.1%)
All	All	0.64	17/73601 (0.0%)	0.88	122/99721 (0.1%)

Chiral center outliers are detected by calculating the chiral volume of a chiral center and verifying if the center is modelled as a planar moiety or with the opposite hand. A planarity outlier is detected by checking planarity of atoms in a peptide group, atoms in a mainchain group or atoms of a sidechain that are expected to be planar.

Mol	Chain	#Chirality outliers	#Planarity outliers
1	A	0	1
8	I	0	2

Continued on next page...

Continued from previous page...

Mol	Chain	#Chirality outliers	#Planarity outliers
9	J	0	1
12	N	0	16
16	S	0	1
All	All	0	21

The worst 5 of 17 bond length outliers are listed below:

Mol	Chain	Res	Type	Atoms	Z	Observed(Å)	Ideal(Å)
1	A	1030	GLU	CD-OE1	21.93	1.49	1.25
1	A	1030	GLU	CD-OE2	15.62	1.42	1.25
1	A	1199	LYS	CE-NZ	9.92	1.73	1.49
12	N	209	ARG	NE-CZ	9.66	1.45	1.33
1	A	1030	GLU	CG-CD	8.25	1.64	1.51

The worst 5 of 122 bond angle outliers are listed below:

Mol	Chain	Res	Type	Atoms	Z	Observed(°)	Ideal(°)
12	N	330	ARG	NE-CZ-NH2	-13.57	113.52	120.30
16	S	60	ARG	NE-CZ-NH1	9.25	124.92	120.30
9	K	351	ASP	CB-CG-OD1	8.97	126.37	118.30
1	A	1235	LEU	CB-CG-CD2	-8.77	96.09	111.00
3	P	358	LEU	CB-CG-CD1	-8.46	96.62	111.00

There are no chirality outliers.

5 of 21 planarity outliers are listed below:

Mol	Chain	Res	Type	Group
1	A	1191	LEU	Peptide
8	I	658	GLY	Peptide
8	I	727	PHE	Peptide
9	J	220	ILE	Peptide
12	N	62	ARG	Peptide

5.2 Too-close contacts [i](#)

In the following table, the Non-H and H(model) columns list the number of non-hydrogen atoms and hydrogen atoms in the chain respectively. The H(added) column lists the number of hydrogen atoms added and optimized by MolProbity. The Clashes column lists the number of clashes within the asymmetric unit, whereas Symm-Clashes lists symmetry-related clashes.

Mol	Chain	Non-H	H(model)	H(added)	Clashes	Symm-Clashes
1	A	10949	0	10690	418	0
2	B	643	0	617	80	0
3	C	4306	0	4272	161	0
3	P	4043	0	4000	137	0
4	D	153	0	148	8	0
5	E	450	0	435	10	0
6	F	3849	0	3783	108	0
6	H	3853	0	3794	128	0
7	G	213	0	220	11	0
7	W	213	0	220	12	0
8	I	5716	0	5587	345	0
9	J	4047	0	3949	185	0
9	K	3988	0	3908	174	0
10	L	1435	0	1382	55	0
11	M	493	0	469	24	0
12	N	5403	0	5103	276	0
13	O	5402	0	5436	221	0
14	Q	2671	0	2516	103	0
15	R	2953	0	2839	111	0
16	S	2077	0	1827	327	0
17	X	3773	0	3831	163	0
17	Y	3868	0	3925	169	0
18	Z	1577	0	1592	89	0
All	All	72075	0	70543	2914	0

The all-atom clashscore is defined as the number of clashes found per 1000 atoms (including hydrogen atoms). The all-atom clashscore for this structure is 20.

The worst 5 of 2914 close contacts within the same asymmetric unit are listed below, sorted by their clash magnitude.

Atom-1	Atom-2	Interatomic distance (Å)	Clash overlap (Å)
16:S:38:MET:CE	18:Z:181:VAL:HG23	1.22	1.65
16:S:22:TRP:CZ3	16:S:41:LEU:HB2	1.31	1.64
16:S:19:GLY:CA	18:Z:134:GLN:HE21	1.16	1.54
8:I:413:ASN:HA	8:I:447:PHE:CZ	1.38	1.53
1:A:1199:LYS:NZ	1:A:1199:LYS:CE	1.73	1.45

There are no symmetry-related clashes.

5.3 Torsion angles

5.3.1 Protein backbone

In the following table, the Percentiles column shows the percent Ramachandran outliers of the chain as a percentile score with respect to all PDB entries followed by that with respect to all EM entries.

The Analysed column shows the number of residues for which the backbone conformation was analysed, and the total number of residues.

Mol	Chain	Analysed	Favoured	Allowed	Outliers	Percentiles	
1	A	1397/1944 (72%)	1267 (91%)	106 (8%)	24 (2%)	9	43
2	B	75/84 (89%)	62 (83%)	8 (11%)	5 (7%)	1	17
3	C	520/597 (87%)	498 (96%)	20 (4%)	2 (0%)	34	71
3	P	485/597 (81%)	465 (96%)	20 (4%)	0	100	100
4	D	16/121 (13%)	14 (88%)	2 (12%)	0	100	100
5	E	54/110 (49%)	53 (98%)	1 (2%)	0	100	100
6	F	479/824 (58%)	458 (96%)	13 (3%)	8 (2%)	9	43
6	H	479/824 (58%)	459 (96%)	14 (3%)	6 (1%)	12	48
7	G	23/85 (27%)	23 (100%)	0	0	100	100
7	W	23/85 (27%)	23 (100%)	0	0	100	100
8	I	725/808 (90%)	683 (94%)	35 (5%)	7 (1%)	15	53
9	J	500/620 (81%)	467 (93%)	29 (6%)	4 (1%)	19	58
9	K	489/620 (79%)	456 (93%)	27 (6%)	6 (1%)	13	49
10	L	180/185 (97%)	165 (92%)	14 (8%)	1 (1%)	25	63
11	M	55/74 (74%)	46 (84%)	9 (16%)	0	100	100
12	N	679/822 (83%)	557 (82%)	68 (10%)	54 (8%)	1	14
13	O	677/755 (90%)	640 (94%)	29 (4%)	8 (1%)	13	49
14	Q	348/374 (93%)	317 (91%)	21 (6%)	10 (3%)	4	32
15	R	377/499 (76%)	344 (91%)	26 (7%)	7 (2%)	8	40
16	S	267/342 (78%)	237 (89%)	18 (7%)	12 (4%)	2	24
17	X	480/599 (80%)	464 (97%)	13 (3%)	3 (1%)	25	63
17	Y	492/599 (82%)	474 (96%)	13 (3%)	5 (1%)	15	53
18	Z	193/205 (94%)	186 (96%)	6 (3%)	1 (0%)	29	67
All	All	9013/11773 (77%)	8358 (93%)	492 (6%)	163 (2%)	12	41

5 of 163 Ramachandran outliers are listed below:

Mol	Chain	Res	Type
1	A	274	VAL
1	A	630	PRO
1	A	857	MET
1	A	1125	ILE
1	A	1358	ILE

5.3.2 Protein sidechains [i](#)

In the following table, the Percentiles column shows the percent sidechain outliers of the chain as a percentile score with respect to all PDB entries followed by that with respect to all EM entries.

The Analysed column shows the number of residues for which the sidechain conformation was analysed, and the total number of residues.

Mol	Chain	Analysed	Rotameric	Outliers	Percentiles	
1	A	1151/1720 (67%)	1011 (88%)	140 (12%)	5	23
2	B	71/75 (95%)	59 (83%)	12 (17%)	2	14
3	C	452/520 (87%)	390 (86%)	62 (14%)	3	20
3	P	422/520 (81%)	374 (89%)	48 (11%)	5	25
4	D	18/115 (16%)	15 (83%)	3 (17%)	2	14
5	E	47/89 (53%)	37 (79%)	10 (21%)	1	6
6	F	407/727 (56%)	361 (89%)	46 (11%)	6	25
6	H	408/727 (56%)	368 (90%)	40 (10%)	8	29
7	G	23/77 (30%)	20 (87%)	3 (13%)	4	22
7	W	23/77 (30%)	21 (91%)	2 (9%)	10	35
8	I	617/730 (84%)	579 (94%)	38 (6%)	18	46
9	J	424/548 (77%)	373 (88%)	51 (12%)	5	23
9	K	423/548 (77%)	383 (90%)	40 (10%)	8	31
10	L	155/170 (91%)	137 (88%)	18 (12%)	5	24
11	M	55/67 (82%)	45 (82%)	10 (18%)	1	11
12	N	518/724 (72%)	448 (86%)	70 (14%)	4	21
13	O	577/650 (89%)	503 (87%)	74 (13%)	4	22
14	Q	271/310 (87%)	264 (97%)	7 (3%)	46	67
15	R	311/411 (76%)	293 (94%)	18 (6%)	20	48

Continued on next page...

Continued from previous page...

Mol	Chain	Analysed	Rotameric	Outliers	Percentiles	
16	S	186/293 (64%)	181 (97%)	5 (3%)	44	66
17	X	407/513 (79%)	376 (92%)	31 (8%)	13	40
17	Y	418/513 (82%)	381 (91%)	37 (9%)	9	34
18	Z	181/190 (95%)	170 (94%)	11 (6%)	18	47
All	All	7565/10314 (73%)	6789 (90%)	776 (10%)	11	28

5 of 776 residues with a non-rotameric sidechain are listed below:

Mol	Chain	Res	Type
11	M	7	ARG
13	O	419	ASP
12	N	77	GLU
10	L	184	ARG
12	N	519	TYR

Sometimes sidechains can be flipped to improve hydrogen bonding and reduce clashes. 5 of 162 such sidechains are listed below:

Mol	Chain	Res	Type
13	O	412	HIS
17	X	78	GLN
13	O	472	HIS
3	P	488	GLN
17	X	371	ASN

5.3.3 RNA [i](#)

There are no RNA molecules in this entry.

5.4 Non-standard residues in protein, DNA, RNA chains [i](#)

There are no non-standard protein/DNA/RNA residues in this entry.

5.5 Carbohydrates [i](#)

There are no monosaccharides in this entry.

5.6 Ligand geometry [i](#)

There are no ligands in this entry.

5.7 Other polymers [i](#)

There are no such residues in this entry.

5.8 Polymer linkage issues [i](#)

The following chains have linkage breaks:

Mol	Chain	Number of breaks
12	N	2
16	S	1
8	I	1

All chain breaks are listed below:

Model	Chain	Residue-1	Atom-1	Residue-2	Atom-2	Distance (Å)
1	S	310:ALA	C	529:SER	N	39.42
1	N	92:TRP	C	93:ASN	N	3.29
1	N	563:ASP	C	564:MET	N	2.78
1	I	302:ASP	C	303:GLU	N	2.26

6 Map visualisation [i](#)

This section contains visualisations of the EMDB entry EMD-4037. These allow visual inspection of the internal detail of the map and identification of artifacts.

No raw map or half-maps were deposited for this entry and therefore no images, graphs, etc. pertaining to the raw map can be shown.

6.1 Orthogonal projections [i](#)

6.1.1 Primary map

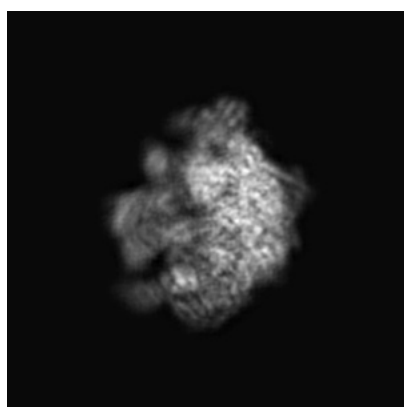

X

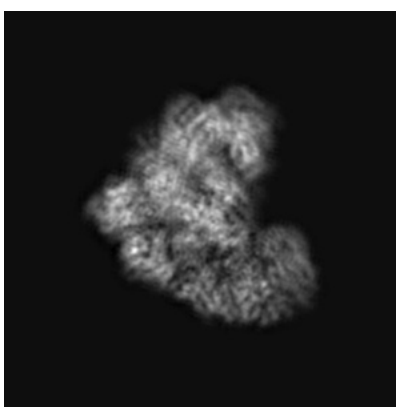

Y

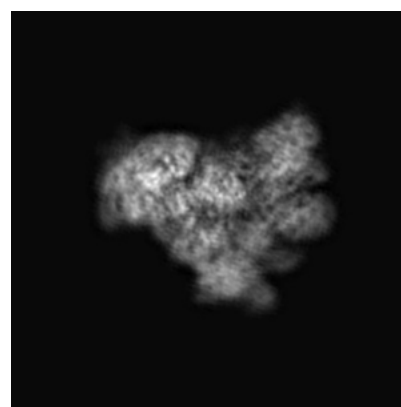

Z

The images above show the map projected in three orthogonal directions.

6.2 Central slices [i](#)

6.2.1 Primary map

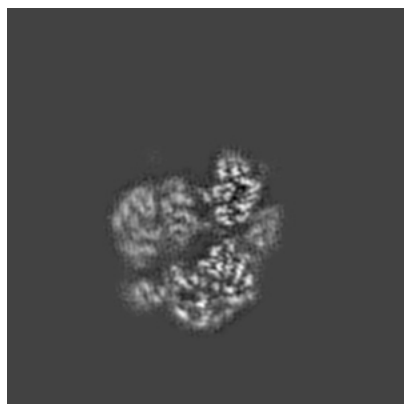

X Index: 132

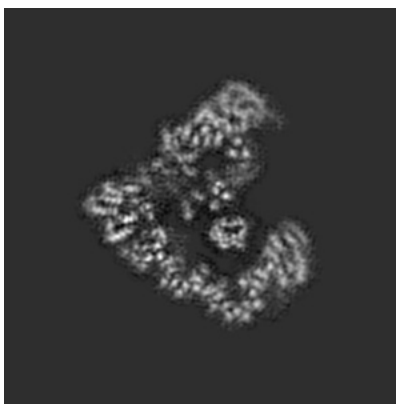

Y Index: 132

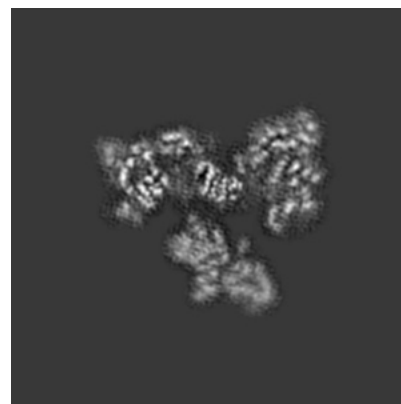

Z Index: 132

The images above show central slices of the map in three orthogonal directions.

6.3 Largest variance slices [i](#)

6.3.1 Primary map

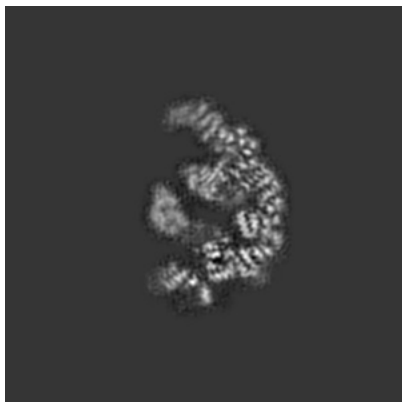

X Index: 112

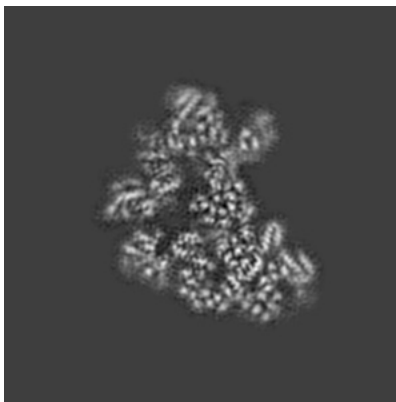

Y Index: 155

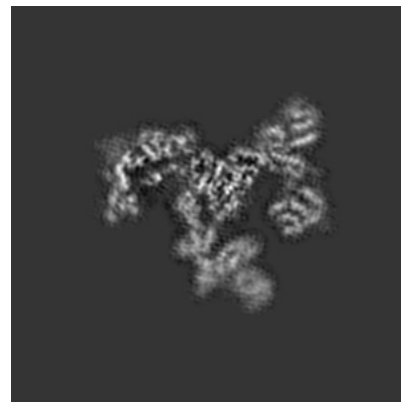

Z Index: 140

The images above show the largest variance slices of the map in three orthogonal directions.

6.4 Orthogonal surface views [i](#)

6.4.1 Primary map

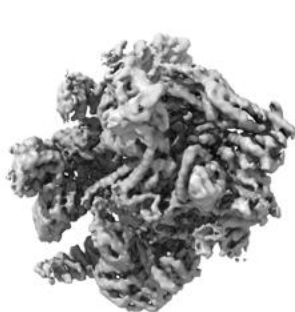

X



Y



Z

The images above show the 3D surface view of the map at the recommended contour level 0.08. These images, in conjunction with the slice images, may facilitate assessment of whether an appropriate contour level has been provided.

6.5 Mask visualisation

This section was not generated. No masks/segmentation were deposited.

7 Map analysis [i](#)

This section contains the results of statistical analysis of the map.

7.1 Map-value distribution [i](#)

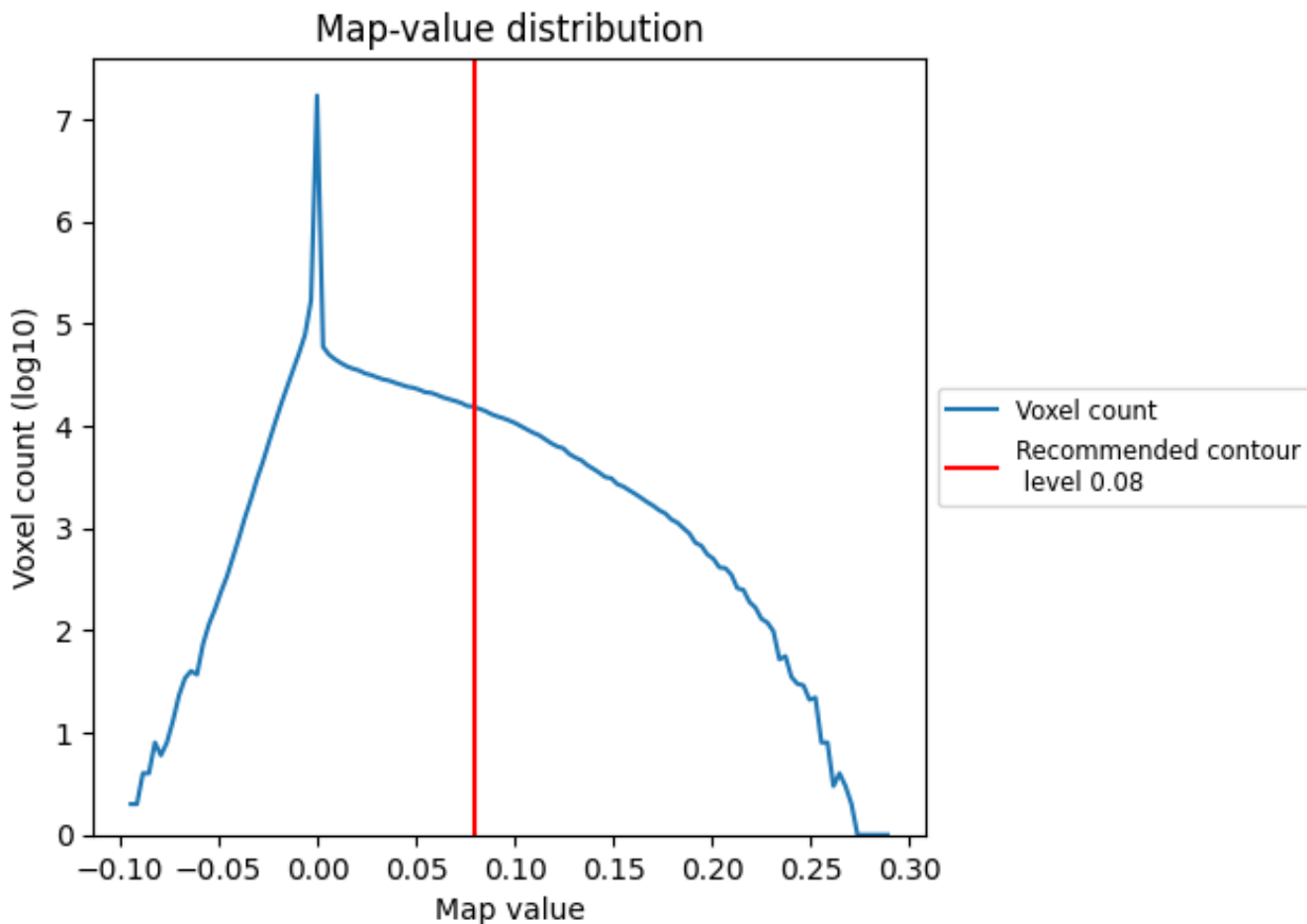

The map-value distribution is plotted in 128 intervals along the x-axis. The y-axis is logarithmic. A spike in this graph at zero usually indicates that the volume has been masked.

7.2 Volume estimate [i](#)

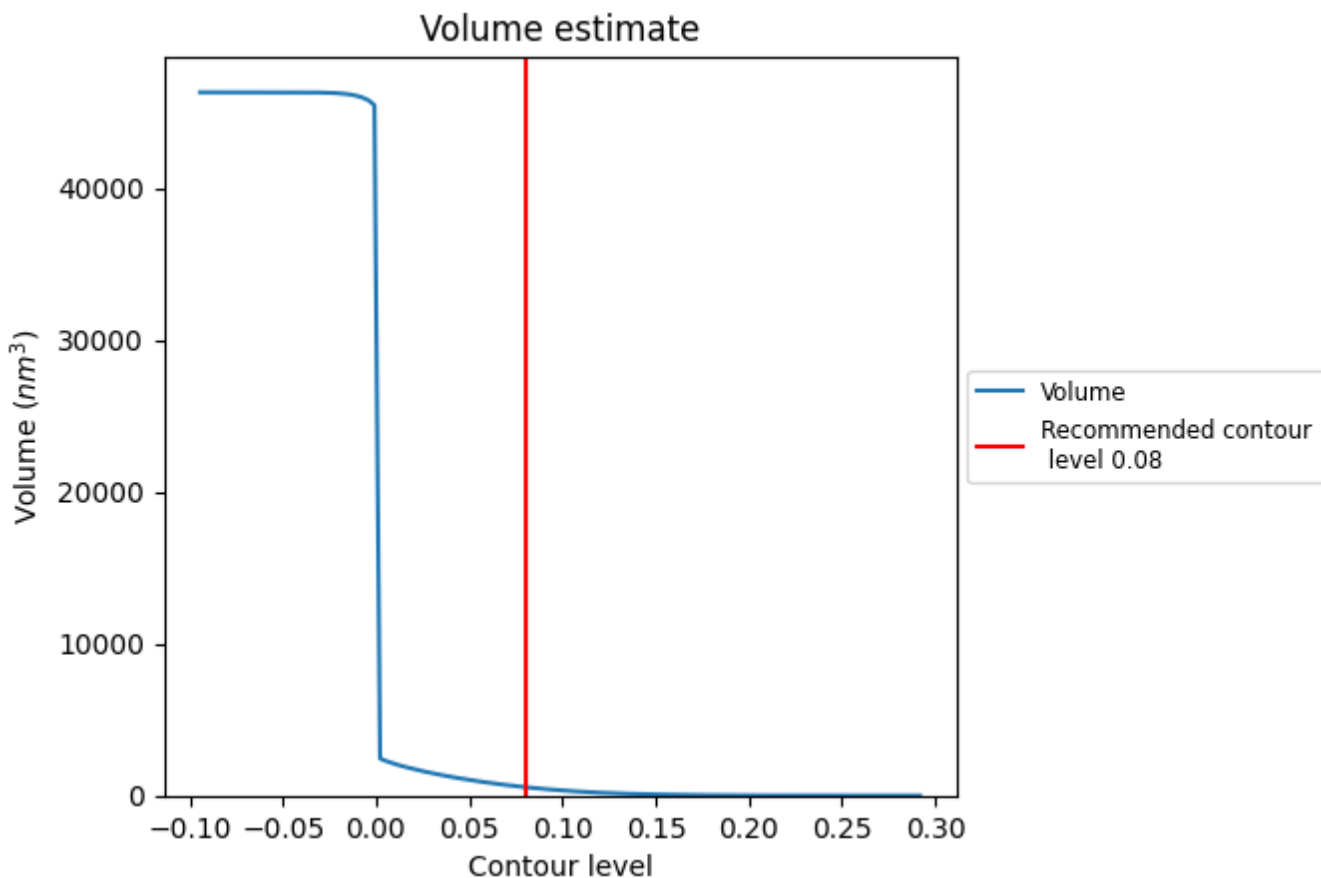

The volume at the recommended contour level is 554 nm^3 ; this corresponds to an approximate mass of 501 kDa.

The volume estimate graph shows how the enclosed volume varies with the contour level. The recommended contour level is shown as a vertical line and the intersection between the line and the curve gives the volume of the enclosed surface at the given level.

7.3 Rotationally averaged power spectrum [i](#)

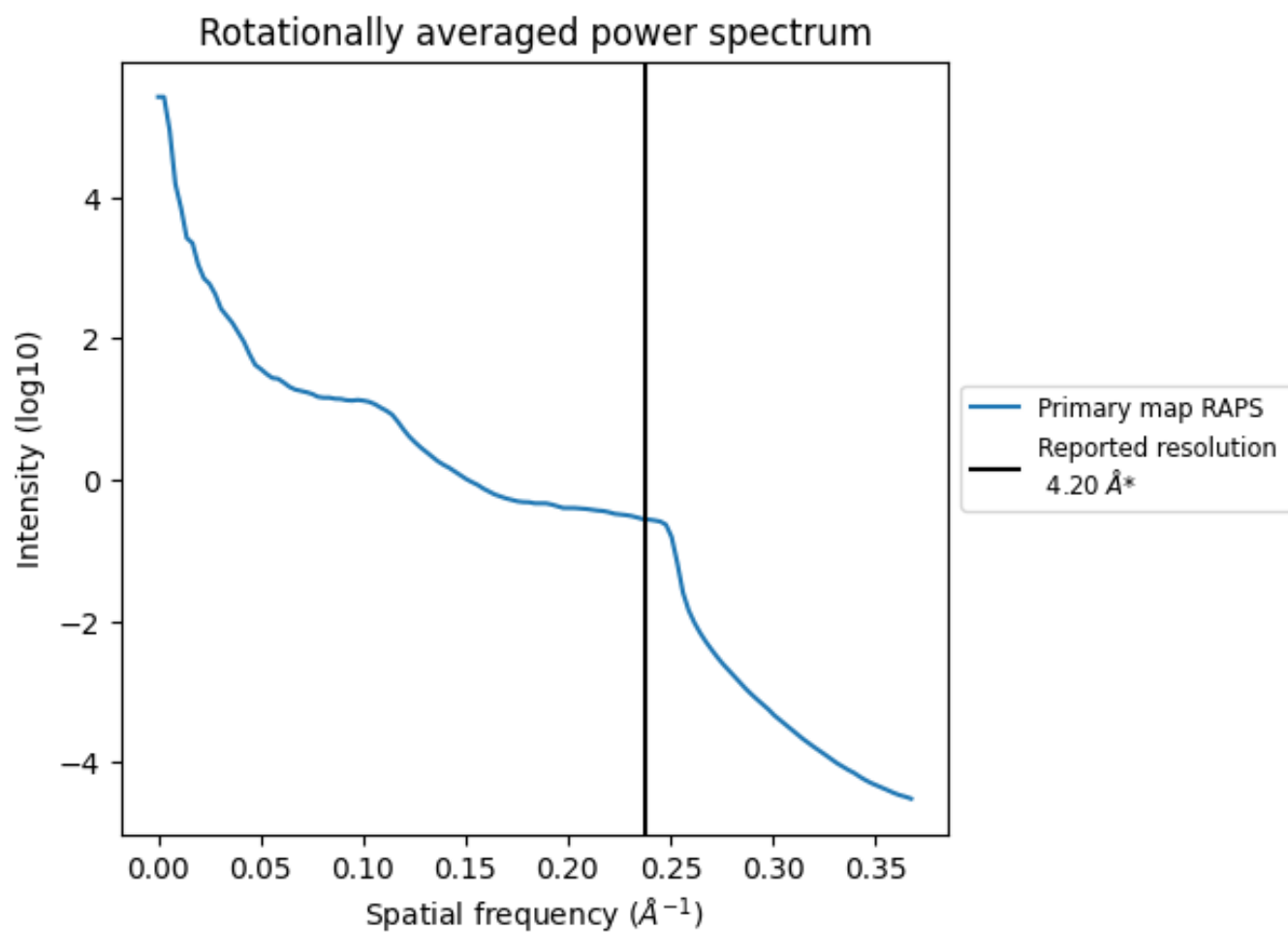

*Reported resolution corresponds to spatial frequency of 0.238\AA^{-1}

8 Fourier-Shell correlation

This section was not generated. No FSC curve or half-maps provided.

9 Map-model fit [i](#)

This section contains information regarding the fit between EMDB map EMD-4037 and PDB model 5LCW. Per-residue inclusion information can be found in section [3](#) on page [7](#).

9.1 Map-model overlay [i](#)

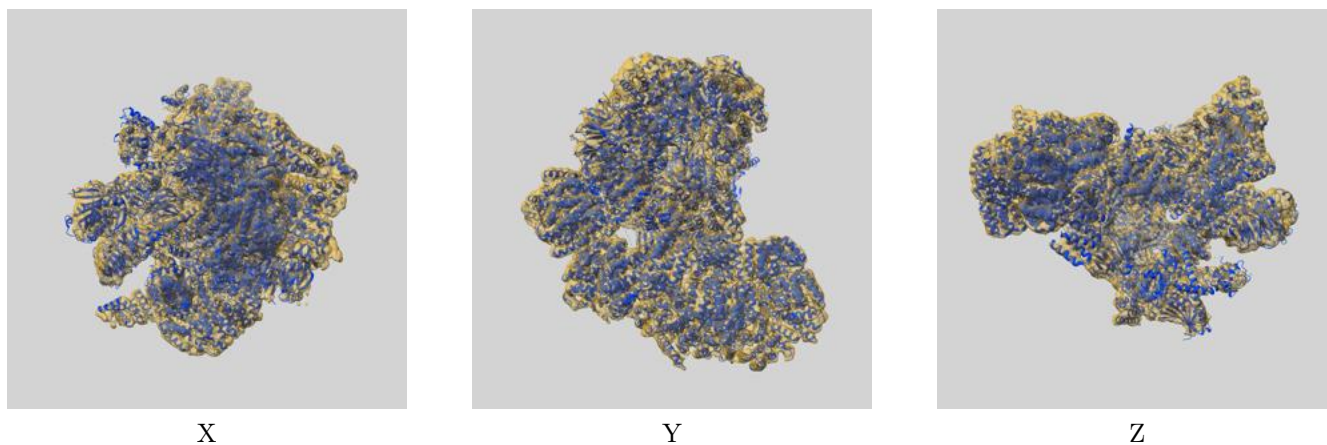

The images above show the 3D surface view of the map at the recommended contour level 0.08 at 50% transparency in yellow overlaid with a ribbon representation of the model coloured in blue. These images allow for the visual assessment of the quality of fit between the atomic model and the map.

9.2 Q-score mapped to coordinate model [i](#)

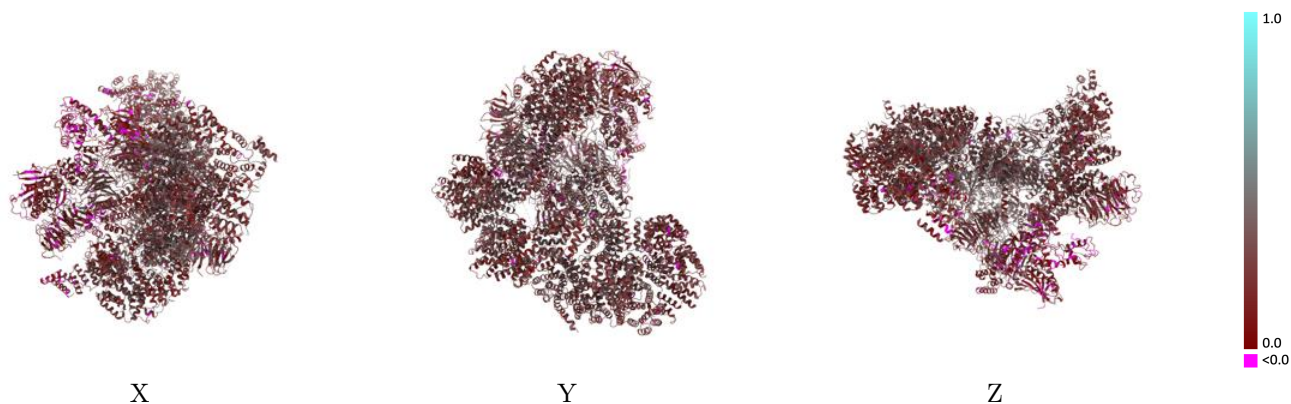

The images above show the model with each residue coloured according to its Q-score. This shows their resolvability in the map with higher Q-score values reflecting better resolvability. Please note: Q-score is calculating the resolvability of atoms, and thus high values are only expected at resolutions at which atoms can be resolved. Low Q-score values may therefore be expected for many entries.

9.3 Atom inclusion mapped to coordinate model [i](#)

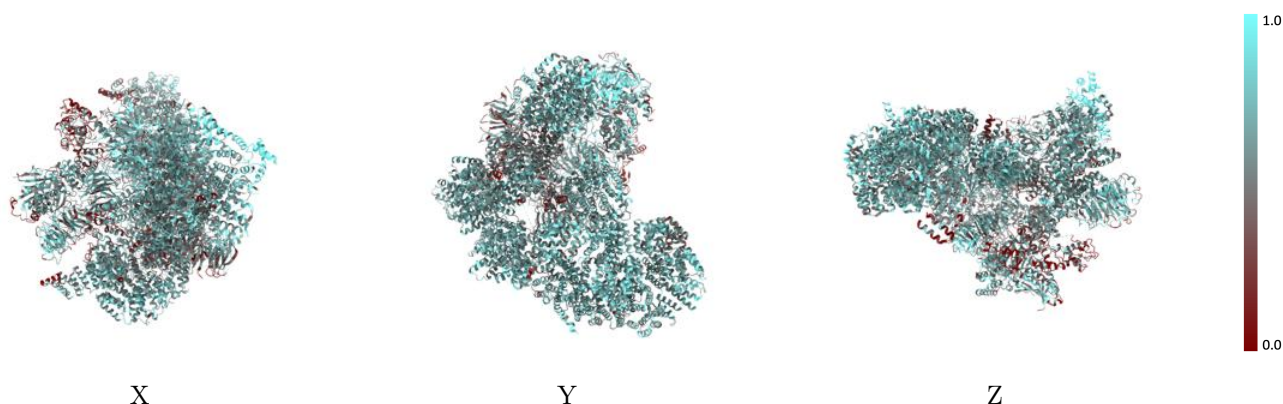

The images above show the model with each residue coloured according to its atom inclusion. This shows to what extent they are inside the map at the recommended contour level (0.08).



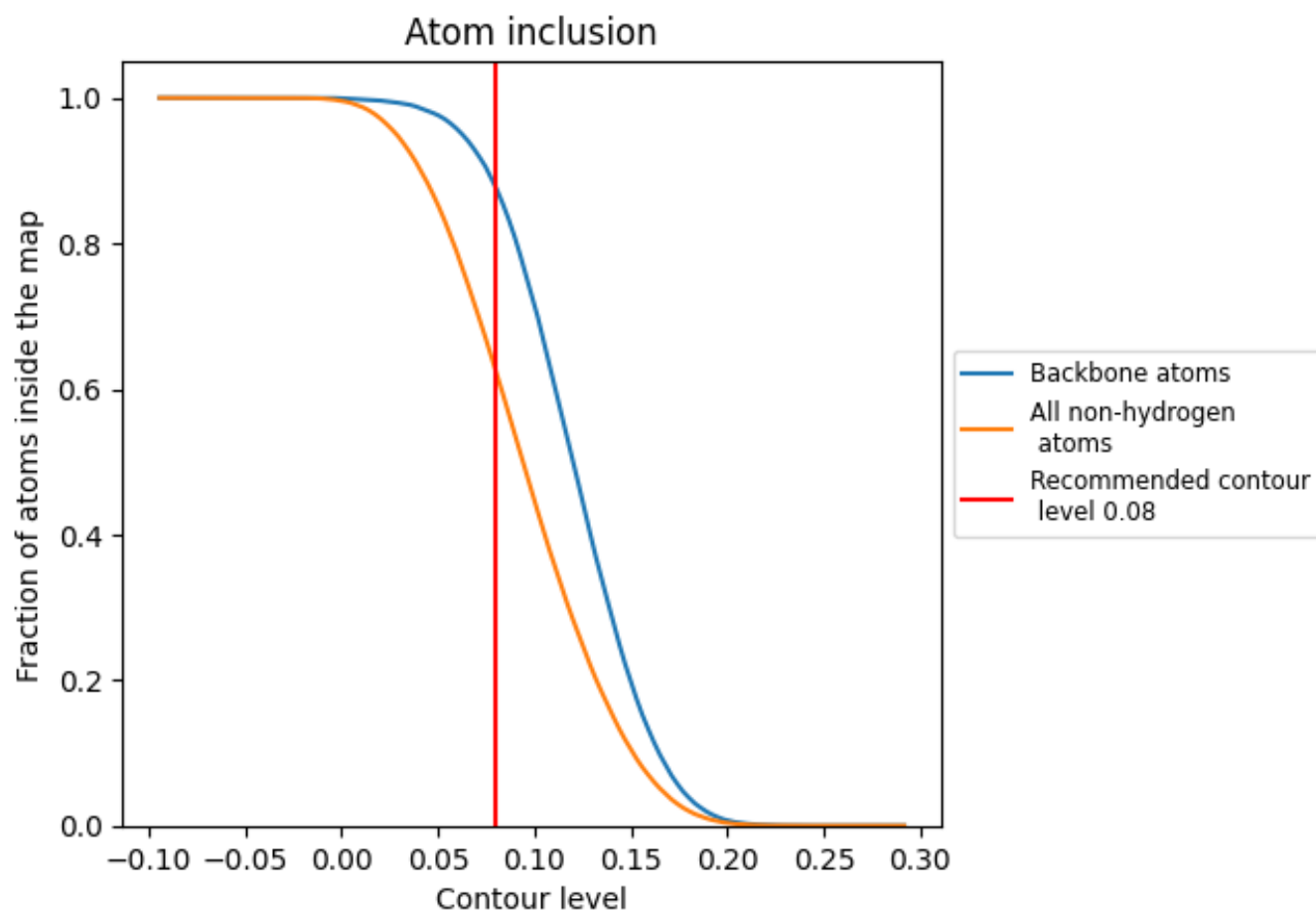













































9.4 Atom inclusion [i](#)



At the recommended contour level, 88% of all backbone atoms, 62% of all non-hydrogen atoms, are inside the map.

9.5 Map-model fit summary

The table lists the average atom inclusion at the recommended contour level (0.08) and Q-score for the entire model and for each chain.

Chain	Atom inclusion	Q-score
All	 0.6245	 0.2520
A	 0.6230	 0.3020
B	 0.1264	 0.0340
C	 0.6194	 0.2630
D	 0.4400	 0.3690
E	 0.6757	 0.3320
F	 0.6863	 0.2920
G	 0.6244	 0.3050
H	 0.7133	 0.3030
I	 0.6013	 0.2160
J	 0.7106	 0.2910
K	 0.6912	 0.2680
L	 0.6840	 0.3260
M	 0.5569	 0.3280
N	 0.5605	 0.1860
O	 0.5683	 0.2670
P	 0.6460	 0.2500
Q	 0.6250	 0.2000
R	 0.6391	 0.2310
S	 0.5834	 0.1970
W	 0.5902	 0.2950
X	 0.6021	 0.2040
Y	 0.6431	 0.2340
Z	 0.5436	 0.1520

