



wwPDB X-ray Structure Validation Summary Report ⓘ

Oct 9, 2023 – 10:48 PM EDT

PDB ID : 7LRM
Title : Structure of HIV-1 Reverse Transcriptase in complex with DNA, dCTP, and CA(2+) ion
Authors : Hoang, A.; Ruiz, F.X.; Arnold, E.
Deposited on : 2021-02-16
Resolution : 3.14 Å(reported)

This is a wwPDB X-ray Structure Validation Summary Report for a publicly released PDB entry.

We welcome your comments at validation@mail.wwpdb.org

A user guide is available at

<https://www.wwpdb.org/validation/2017/XrayValidationReportHelp>

with specific help available everywhere you see the ⓘ symbol.

The types of validation reports are described at

<http://www.wwpdb.org/validation/2017/FAQs#types>.

The following versions of software and data (see [references ⓘ](#)) were used in the production of this report:

MolProbity : 4.02b-467
Mogul : 1.8.5 (274361), CSD as541be (2020)
Xtrriage (Phenix) : 1.13
EDS : 2.35.1
buster-report : 1.1.7 (2018)
Percentile statistics : 20191225.v01 (using entries in the PDB archive December 25th 2019)
Refmac : 5.8.0158
CCP4 : 7.0.044 (Gargrove)
Ideal geometry (proteins) : Engh & Huber (2001)
Ideal geometry (DNA, RNA) : Parkinson et al. (1996)
Validation Pipeline (wwPDB-VP) : 2.35.1

1 Overall quality at a glance

The following experimental techniques were used to determine the structure:

X-RAY DIFFRACTION

The reported resolution of this entry is 3.14 Å.

Percentile scores (ranging between 0-100) for global validation metrics of the entry are shown in the following graphic. The table shows the number of entries on which the scores are based.

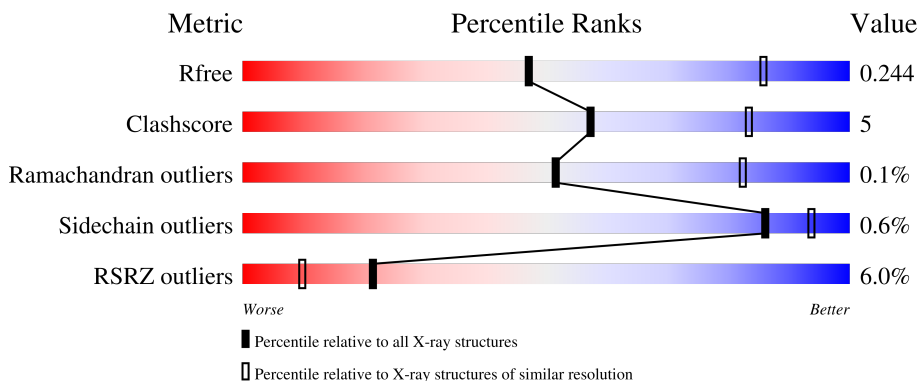

Metric	Whole archive (#Entries)	Similar resolution (#Entries, resolution range(Å))
R_{free}	130704	1626 (3.18-3.10)
Clashscore	141614	1735 (3.18-3.10)
Ramachandran outliers	138981	1677 (3.18-3.10)
Sidechain outliers	138945	1677 (3.18-3.10)
RSRZ outliers	127900	1588 (3.18-3.10)

The table below summarises the geometric issues observed across the polymeric chains and their fit to the electron density. The red, orange, yellow and green segments of the lower bar indicate the fraction of residues that contain outliers for ≥ 3 , 2, 1 and 0 types of geometric quality criteria respectively. A grey segment represents the fraction of residues that are not modelled. The numeric value for each fraction is indicated below the corresponding segment, with a dot representing fractions $\leq 5\%$. The upper red bar (where present) indicates the fraction of residues that have poor fit to the electron density. The numeric value is given above the bar.

Mol	Chain	Length	Quality of chain
1	A	555	 6% 83% 17%
1	C	555	 9% 85% 15%
2	B	429	 3% 88% 9% .
2	D	429	 5% 83% 13% .
3	E	38	 63% 21% 8% 8%

Continued on next page...

Continued from previous page...

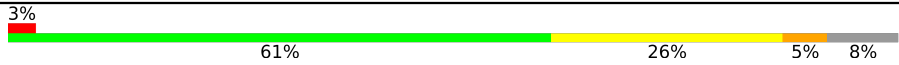
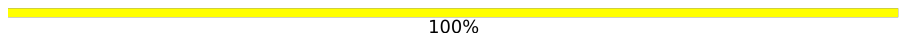
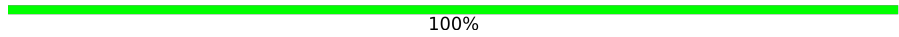
Mol	Chain	Length	Quality of chain
3	F	38	 3% 61% 26% 5% 8%
4	I	2	 100%
4	J	2	 100%

2 Entry composition

There are 9 unique types of molecules in this entry. The entry contains 17629 atoms, of which 0 are hydrogens and 0 are deuteriums.

In the tables below, the ZeroOcc column contains the number of atoms modelled with zero occupancy, the AltConf column contains the number of residues with at least one atom in alternate conformation and the Trace column contains the number of residues modelled with at most 2 atoms.

- Molecule 1 is a protein called Reverse transcriptase p66.

Mol	Chain	Residues	Atoms					ZeroOcc	AltConf	Trace
			Total	C	N	O	S			
1	A	553	4504	2916	750	831	7	0	0	0
1	C	553	4504	2916	750	831	7	0	0	0

There are 4 discrepancies between the modelled and reference sequences:

Chain	Residue	Modelled	Actual	Comment	Reference
A	280	SER	CYS	engineered mutation	UNP P03366
A	498	ASN	ASP	engineered mutation	UNP P03366
C	280	SER	CYS	engineered mutation	UNP P03366
C	498	ASN	ASP	engineered mutation	UNP P03366

- Molecule 2 is a protein called Reverse transcriptase p51.

Mol	Chain	Residues	Atoms					ZeroOcc	AltConf	Trace
			Total	C	N	O	S			
2	B	415	3434	2239	567	621	7	0	0	0
2	D	410	3409	2225	562	615	7	0	2	0

There are 4 discrepancies between the modelled and reference sequences:

Chain	Residue	Modelled	Actual	Comment	Reference
B	0	GLY	-	expression tag	UNP P03366
B	280	SER	CYS	engineered mutation	UNP P03366
D	0	GLY	-	expression tag	UNP P03366
D	280	SER	CYS	engineered mutation	UNP P03366

- Molecule 3 is a DNA chain called DNA/RNA (38-MER).

Mol	Chain	Residues	Atoms					ZeroOcc	AltConf	Trace
3	F	35	Total	C	N	O	P	0	0	0
			721	340	130	216	35			
3	E	35	Total	C	N	O	P	0	0	0
			721	340	130	216	35			

- Molecule 4 is an oligosaccharide called beta-D-fructofuranose-(2-1)-alpha-D-glucopyranose.

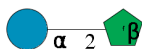

Mol	Chain	Residues	Atoms			ZeroOcc	AltConf	Trace
4	I	2	Total	C	O	0	0	0
			23	12	11			
4	J	2	Total	C	O	0	0	0
			23	12	11			

- Molecule 5 is SULFATE ION (three-letter code: SO4) (formula: O₄S).

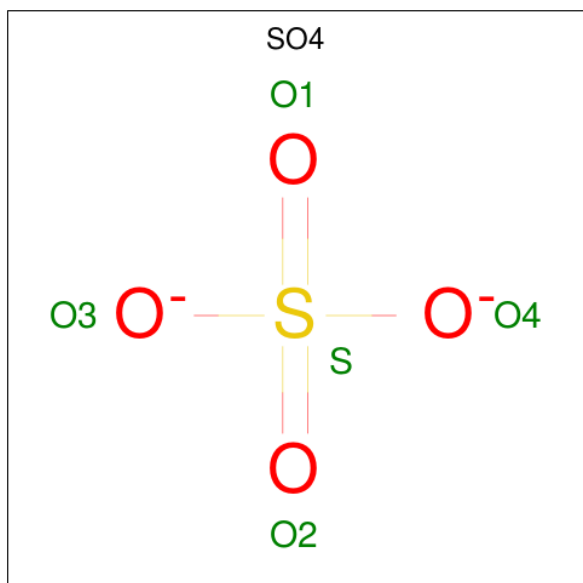

Mol	Chain	Residues	Atoms			ZeroOcc	AltConf
5	A	1	Total	O	S	0	0
			5	4	1		
5	C	1	Total	O	S	0	0
			5	4	1		

- Molecule 6 is GLYCEROL (three-letter code: GOL) (formula: C₃H₈O₃).



Mol	Chain	Residues	Atoms	ZeroOcc	AltConf
6	A	1	Total C O 6 3 3	0	0
6	A	1	Total C O 6 3 3	0	0
6	B	1	Total C O 6 3 3	0	0
6	B	1	Total C O 6 3 3	0	0
6	B	1	Total C O 6 3 3	0	0
6	B	1	Total C O 6 3 3	0	0
6	C	1	Total C O 6 3 3	0	0
6	C	1	Total C O 6 3 3	0	0
6	C	1	Total C O 6 3 3	0	0
6	D	1	Total C O 6 3 3	0	0
6	D	1	Total C O 6 3 3	0	0
6	D	1	Total C O 6 3 3	0	0

- Molecule 7 is 2'-DEOXYCYTIDINE-5'-TRIPHOSPHATE (three-letter code: DCP) (formula: C₉H₁₆N₃O₁₃P₃) (labeled as "Ligand of Interest" by depositor).

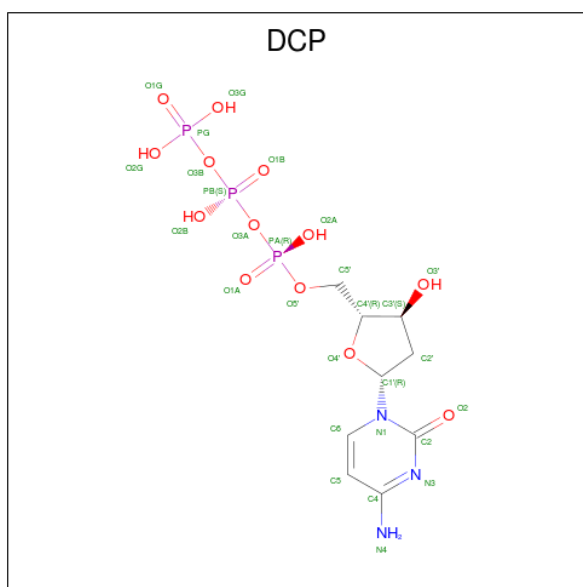

Mol	Chain	Residues	Atoms				ZeroOcc	AltConf	
7	A	1	Total	C	N	O	P	0	0
			28	9	3	13	3		
7	C	1	Total	C	N	O	P	0	0
			28	9	3	13	3		

- Molecule 8 is CALCIUM ION (three-letter code: CA) (formula: Ca).

Mol	Chain	Residues	Atoms		ZeroOcc	AltConf
8	A	1	Total	Ca	0	0
			1	1		
8	C	1	Total	Ca	0	0
			1	1		

- Molecule 9 is water.

Mol	Chain	Residues	Atoms		ZeroOcc	AltConf
9	A	36	Total	O	0	0
			36	36		
9	B	24	Total	O	0	0
			24	24		
9	C	43	Total	O	0	0
			43	43		
9	D	33	Total	O	0	0
			33	33		
9	F	4	Total	O	0	0
			4	4		

Continued on next page...

Continued from previous page...

Mol	Chain	Residues	Atoms		ZeroOcc	AltConf
9	E	10	Total	O	0	0
			10	10		

3 Residue-property plots i

These plots are drawn for all protein, RNA, DNA and oligosaccharide chains in the entry. The first graphic for a chain summarises the proportions of the various outlier classes displayed in the second graphic. The second graphic shows the sequence view annotated by issues in geometry and electron density. Residues are color-coded according to the number of geometric quality criteria for which they contain at least one outlier: green = 0, yellow = 1, orange = 2 and red = 3 or more. A red dot above a residue indicates a poor fit to the electron density ($RSRZ > 2$). Stretches of 2 or more consecutive residues without any outlier are shown as a green connector. Residues present in the sample, but not in the model, are shown in grey.

- Molecule 1: Reverse transcriptase p66

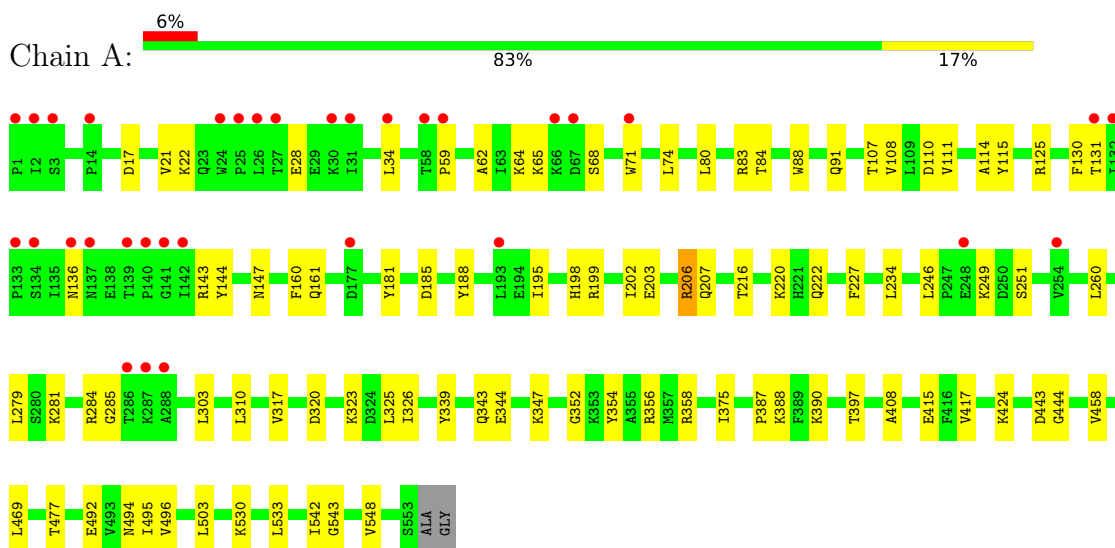

- Molecule 1: Reverse transcriptase p66

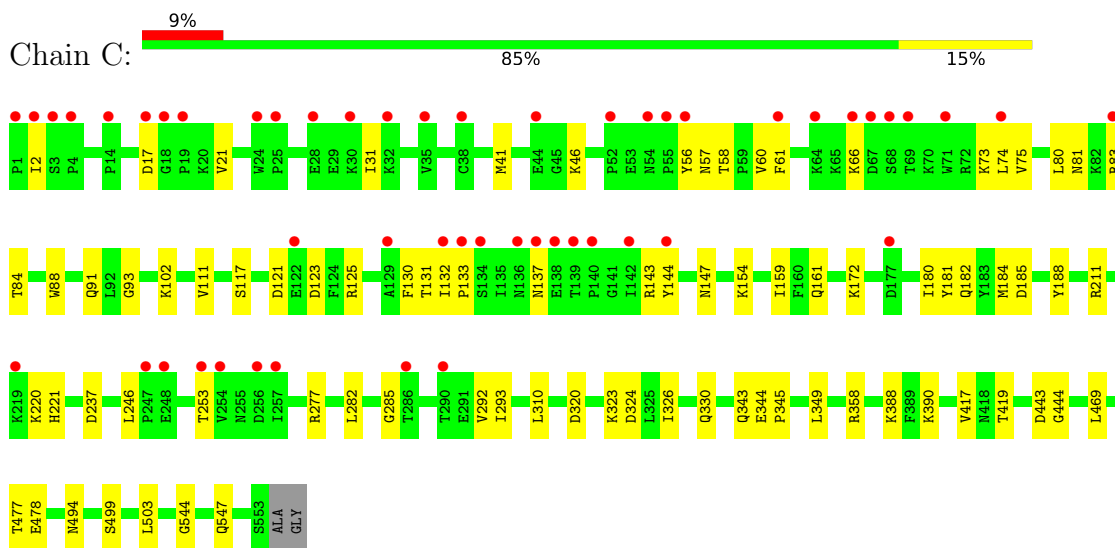

- Molecule 2: Reverse transcriptase p51

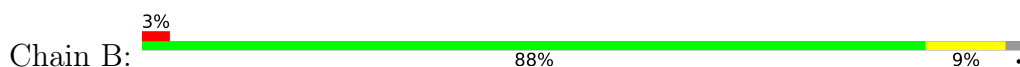

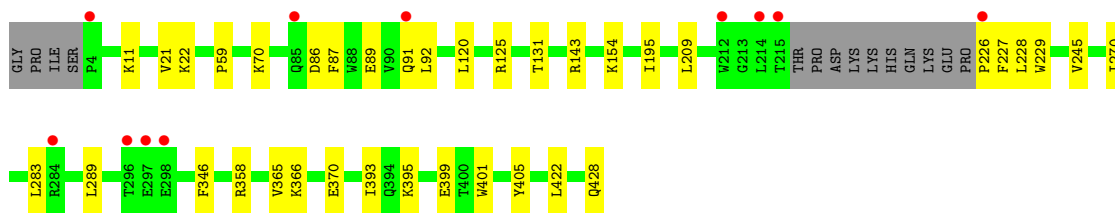

• Molecule 2: Reverse transcriptase p51

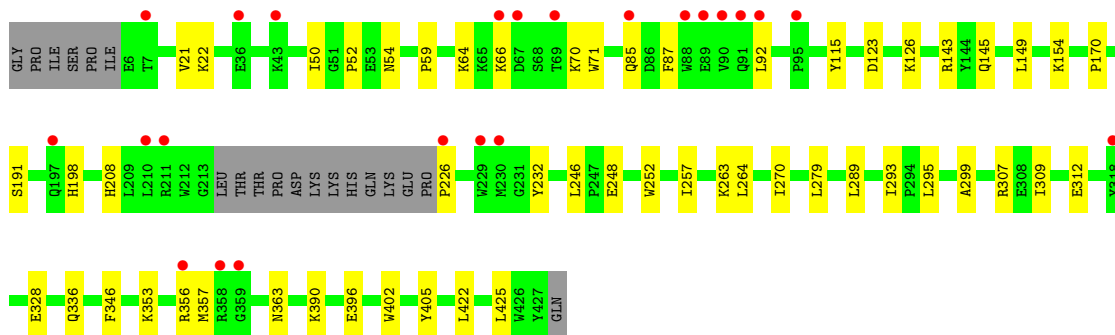
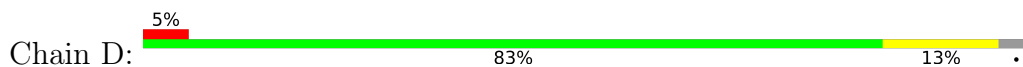

• Molecule 3: DNA/RNA (38-MER)

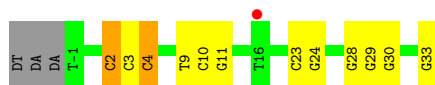

• Molecule 3: DNA/RNA (38-MER)



• Molecule 4: beta-D-fructofuranose-(2-1)-alpha-D-glucopyranose

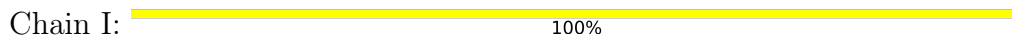

• Molecule 4: beta-D-fructofuranose-(2-1)-alpha-D-glucopyranose



4 Data and refinement statistics

Property	Value	Source
Space group	P 1 21 1	Depositor
Cell constants a, b, c, α , β , γ	89.66Å 131.25Å 137.49Å 90.00° 97.72° 90.00°	Depositor
Resolution (Å)	34.13 – 3.14 34.13 – 3.14	Depositor EDS
% Data completeness (in resolution range)	80.3 (34.13-3.14) 80.3 (34.13-3.14)	Depositor EDS
R_{merge}	0.09	Depositor
R_{sym}	(Not available)	Depositor
$\langle I/\sigma(I) \rangle$ ¹	3.62 (at 3.12Å)	Xtrriage
Refinement program	PHENIX 1.18.2_3874	Depositor
R, R_{free}	0.194 , 0.244 0.194 , 0.244	Depositor DCC
R_{free} test set	1998 reflections (4.51%)	wwPDB-VP
Wilson B-factor (Å ²)	56.8	Xtrriage
Anisotropy	0.218	Xtrriage
Bulk solvent k_{sol} (e/Å ³), B_{sol} (Å ²)	0.28 , 45.2	EDS
L-test for twinning ²	$\langle L \rangle = 0.46$, $\langle L^2 \rangle = 0.28$	Xtrriage
Estimated twinning fraction	No twinning to report.	Xtrriage
F_o, F_c correlation	0.90	EDS
Total number of atoms	17629	wwPDB-VP
Average B, all atoms (Å ²)	77.0	wwPDB-VP

Xtrriage's analysis on translational NCS is as follows: *The largest off-origin peak in the Patterson function is 2.86% of the height of the origin peak. No significant pseudotranslation is detected.*

¹Intensities estimated from amplitudes.

²Theoretical values of $\langle |L| \rangle$, $\langle L^2 \rangle$ for acentric reflections are 0.5, 0.333 respectively for untwinned datasets, and 0.375, 0.2 for perfectly twinned datasets.

5 Model quality

5.1 Standard geometry

Bond lengths and bond angles in the following residue types are not validated in this section: DCP, FRU, CA, GLC, GOL, OMC, SO4

The Z score for a bond length (or angle) is the number of standard deviations the observed value is removed from the expected value. A bond length (or angle) with $|Z| > 5$ is considered an outlier worth inspection. RMSZ is the root-mean-square of all Z scores of the bond lengths (or angles).

Mol	Chain	Bond lengths		Bond angles	
		RMSZ	# Z >5	RMSZ	# Z >5
1	A	0.24	0/4622	0.41	0/6279
1	C	0.24	0/4622	0.41	0/6279
2	B	0.24	0/3534	0.41	0/4800
2	D	0.24	0/3515	0.41	0/4775
3	E	0.58	1/760 (0.1%)	0.86	0/1172
3	F	0.46	0/760	0.84	0/1172
All	All	0.27	1/17813 (0.0%)	0.47	0/24477

All (1) bond length outliers are listed below:

Mol	Chain	Res	Type	Atoms	Z	Observed(Å)	Ideal(Å)
3	E	0	DG	O3'-P	-5.07	1.55	1.61

There are no bond angle outliers.

There are no chirality outliers.

There are no planarity outliers.

5.2 Too-close contacts

In the following table, the Non-H and H(model) columns list the number of non-hydrogen atoms and hydrogen atoms in the chain respectively. The H(added) column lists the number of hydrogen atoms added and optimized by MolProbity. The Clashes column lists the number of clashes within the asymmetric unit, whereas Symm-Clashes lists symmetry-related clashes.

Mol	Chain	Non-H	H(model)	H(added)	Clashes	Symm-Clashes
1	A	4504	0	4567	62	0
1	C	4504	0	4566	46	0
2	B	3434	0	3466	29	0
2	D	3409	0	3438	31	0

Continued on next page...

Continued from previous page...

Mol	Chain	Non-H	H(model)	H(added)	Clashes	Symm-Clashes
3	E	721	0	397	9	0
3	F	721	0	397	9	0
4	I	23	0	21	1	0
4	J	23	0	21	0	0
5	A	5	0	0	0	0
5	C	5	0	0	0	0
6	A	12	0	16	0	0
6	B	24	0	32	1	0
6	C	18	0	24	0	0
6	D	18	0	24	2	0
7	A	28	0	12	1	0
7	C	28	0	12	0	0
8	A	1	0	0	0	0
8	C	1	0	0	0	0
9	A	36	0	0	2	0
9	B	24	0	0	0	0
9	C	43	0	0	0	0
9	D	33	0	0	3	0
9	E	10	0	0	0	0
9	F	4	0	0	0	0
All	All	17629	0	16993	168	0

The all-atom clashscore is defined as the number of clashes found per 1000 atoms (including hydrogen atoms). The all-atom clashscore for this structure is 5.

The worst 5 of 168 close contacts within the same asymmetric unit are listed below, sorted by their clash magnitude.

Atom-1	Atom-2	Interatomic distance (Å)	Clash overlap (Å)
2:D:402:TRP:HE1	6:D:503:GOL:H11	1.50	0.76
1:A:390:LYS:NZ	1:A:415:GLU:OE2	2.26	0.68
1:A:131:THR:HG22	1:A:143:ARG:HG2	1.76	0.66
1:C:390:LYS:HB3	1:C:417:VAL:HG21	1.78	0.66
1:A:91:GLN:NE2	1:A:161:GLN:OE1	2.28	0.66

There are no symmetry-related clashes.

5.3 Torsion angles [i](#)

5.3.1 Protein backbone [i](#)

In the following table, the Percentiles column shows the percent Ramachandran outliers of the chain as a percentile score with respect to all X-ray entries followed by that with respect to entries of similar resolution.

The Analysed column shows the number of residues for which the backbone conformation was analysed, and the total number of residues.

Mol	Chain	Analysed	Favoured	Allowed	Outliers	Percentiles	
1	A	551/555 (99%)	536 (97%)	15 (3%)	0	100	100
1	C	551/555 (99%)	532 (97%)	18 (3%)	1 (0%)	47	78
2	B	411/429 (96%)	399 (97%)	12 (3%)	0	100	100
2	D	408/429 (95%)	393 (96%)	15 (4%)	0	100	100
All	All	1921/1968 (98%)	1860 (97%)	60 (3%)	1 (0%)	51	82

All (1) Ramachandran outliers are listed below:

Mol	Chain	Res	Type
1	C	117	SER

5.3.2 Protein sidechains [i](#)

In the following table, the Percentiles column shows the percent sidechain outliers of the chain as a percentile score with respect to all X-ray entries followed by that with respect to entries of similar resolution.

The Analysed column shows the number of residues for which the sidechain conformation was analysed, and the total number of residues.

Mol	Chain	Analysed	Rotameric	Outliers	Percentiles	
1	A	495/495 (100%)	493 (100%)	2 (0%)	91	96
1	C	495/495 (100%)	488 (99%)	7 (1%)	67	85
2	B	377/390 (97%)	377 (100%)	0	100	100
2	D	374/390 (96%)	372 (100%)	2 (0%)	88	95
All	All	1741/1770 (98%)	1730 (99%)	11 (1%)	86	94

5 of 11 residues with a non-rotameric sidechain are listed below:

Mol	Chain	Res	Type
1	C	221	HIS
1	C	277	ARG
2	D	357	MET
2	D	356	ARG
1	C	123	ASP

Sometimes sidechains can be flipped to improve hydrogen bonding and reduce clashes. All (2) such sidechains are listed below:

Mol	Chain	Res	Type
1	A	91	GLN
1	A	161	GLN

5.3.3 RNA [i](#)

There are no RNA molecules in this entry.

5.4 Non-standard residues in protein, DNA, RNA chains [i](#)

4 non-standard protein/DNA/RNA residues are modelled in this entry.

In the following table, the Counts columns list the number of bonds (or angles) for which Mogul statistics could be retrieved, the number of bonds (or angles) that are observed in the model and the number of bonds (or angles) that are defined in the Chemical Component Dictionary. The Link column lists molecule types, if any, to which the group is linked. The Z score for a bond length (or angle) is the number of standard deviations the observed value is removed from the expected value. A bond length (or angle) with $|Z| > 2$ is considered an outlier worth inspection. RMSZ is the root-mean-square of all Z scores of the bond lengths (or angles).

Mol	Type	Chain	Res	Link	Bond lengths			Bond angles		
					Counts	RMSZ	# Z > 2	Counts	RMSZ	# Z > 2
3	OMC	E	2	3	19,22,23	3.06	7 (36%)	26,31,34	0.72	0
3	OMC	F	4	3	19,22,23	3.07	7 (36%)	26,31,34	0.71	0
3	OMC	E	4	3	19,22,23	3.04	7 (36%)	26,31,34	0.71	0
3	OMC	F	2	3	19,22,23	3.05	7 (36%)	26,31,34	0.74	0

In the following table, the Chirals column lists the number of chiral outliers, the number of chiral centers analysed, the number of these observed in the model and the number defined in the Chemical Component Dictionary. Similar counts are reported in the Torsion and Rings columns. '-' means no outliers of that kind were identified.

Mol	Type	Chain	Res	Link	Chirals	Torsions	Rings
3	OMC	E	2	3	-	1/9/27/28	0/2/2/2
3	OMC	F	4	3	-	1/9/27/28	0/2/2/2
3	OMC	E	4	3	-	1/9/27/28	0/2/2/2
3	OMC	F	2	3	-	1/9/27/28	0/2/2/2

The worst 5 of 28 bond length outliers are listed below:

Mol	Chain	Res	Type	Atoms	Z	Observed(Å)	Ideal(Å)
3	F	4	OMC	C6-C5	6.51	1.50	1.35
3	E	2	OMC	C6-C5	6.45	1.50	1.35
3	E	4	OMC	C6-C5	6.45	1.50	1.35
3	F	4	OMC	C2-N3	6.45	1.49	1.36
3	F	2	OMC	C6-C5	6.43	1.50	1.35

There are no bond angle outliers.

There are no chirality outliers.

All (4) torsion outliers are listed below:

Mol	Chain	Res	Type	Atoms
3	F	2	OMC	C1'-C2'-O2'-CM2
3	E	2	OMC	C1'-C2'-O2'-CM2
3	F	4	OMC	C1'-C2'-O2'-CM2
3	E	4	OMC	C1'-C2'-O2'-CM2

There are no ring outliers.

4 monomers are involved in 6 short contacts:

Mol	Chain	Res	Type	Clashes	Symm-Clashes
3	E	2	OMC	1	0
3	F	4	OMC	2	0
3	E	4	OMC	2	0
3	F	2	OMC	1	0

5.5 Carbohydrates [i](#)

4 monosaccharides are modelled in this entry.

In the following table, the Counts columns list the number of bonds (or angles) for which Mogul statistics could be retrieved, the number of bonds (or angles) that are observed in the model and the number of bonds (or angles) that are defined in the Chemical Component Dictionary. The Link column lists molecule types, if any, to which the group is linked. The Z score for a bond

length (or angle) is the number of standard deviations the observed value is removed from the expected value. A bond length (or angle) with $|Z| > 2$ is considered an outlier worth inspection. RMSZ is the root-mean-square of all Z scores of the bond lengths (or angles).

Mol	Type	Chain	Res	Link	Bond lengths			Bond angles		
					Counts	RMSZ	# Z > 2	Counts	RMSZ	# Z > 2
4	GLC	I	1	4	11,11,12	0.60	0	15,15,17	0.68	0
4	FRU	I	2	4	11,12,12	0.55	0	10,18,18	0.84	0
4	GLC	J	1	4	11,11,12	0.59	0	15,15,17	0.62	0
4	FRU	J	2	4	11,12,12	0.52	0	10,18,18	0.76	0

In the following table, the Chirals column lists the number of chiral outliers, the number of chiral centers analysed, the number of these observed in the model and the number defined in the Chemical Component Dictionary. Similar counts are reported in the Torsion and Rings columns. '-' means no outliers of that kind were identified.

Mol	Type	Chain	Res	Link	Chirals	Torsions	Rings
4	GLC	I	1	4	-	2/2/19/22	0/1/1/1
4	FRU	I	2	4	-	5/5/24/24	0/1/1/1
4	GLC	J	1	4	-	0/2/19/22	0/1/1/1
4	FRU	J	2	4	-	5/5/24/24	0/1/1/1

There are no bond length outliers.

There are no bond angle outliers.

There are no chirality outliers.

5 of 12 torsion outliers are listed below:

Mol	Chain	Res	Type	Atoms
4	I	2	FRU	O1-C1-C2-C3
4	I	2	FRU	O1-C1-C2-O2
4	I	2	FRU	O1-C1-C2-O5
4	J	2	FRU	O1-C1-C2-O2
4	J	2	FRU	O5-C5-C6-O6

There are no ring outliers.

2 monomers are involved in 1 short contact:

Mol	Chain	Res	Type	Clashes	Symm-Clashes
4	I	1	GLC	1	0
4	I	2	FRU	1	0

The following is a two-dimensional graphical depiction of Mogul quality analysis of bond lengths,

bond angles, torsion angles, and ring geometry for oligosaccharide.

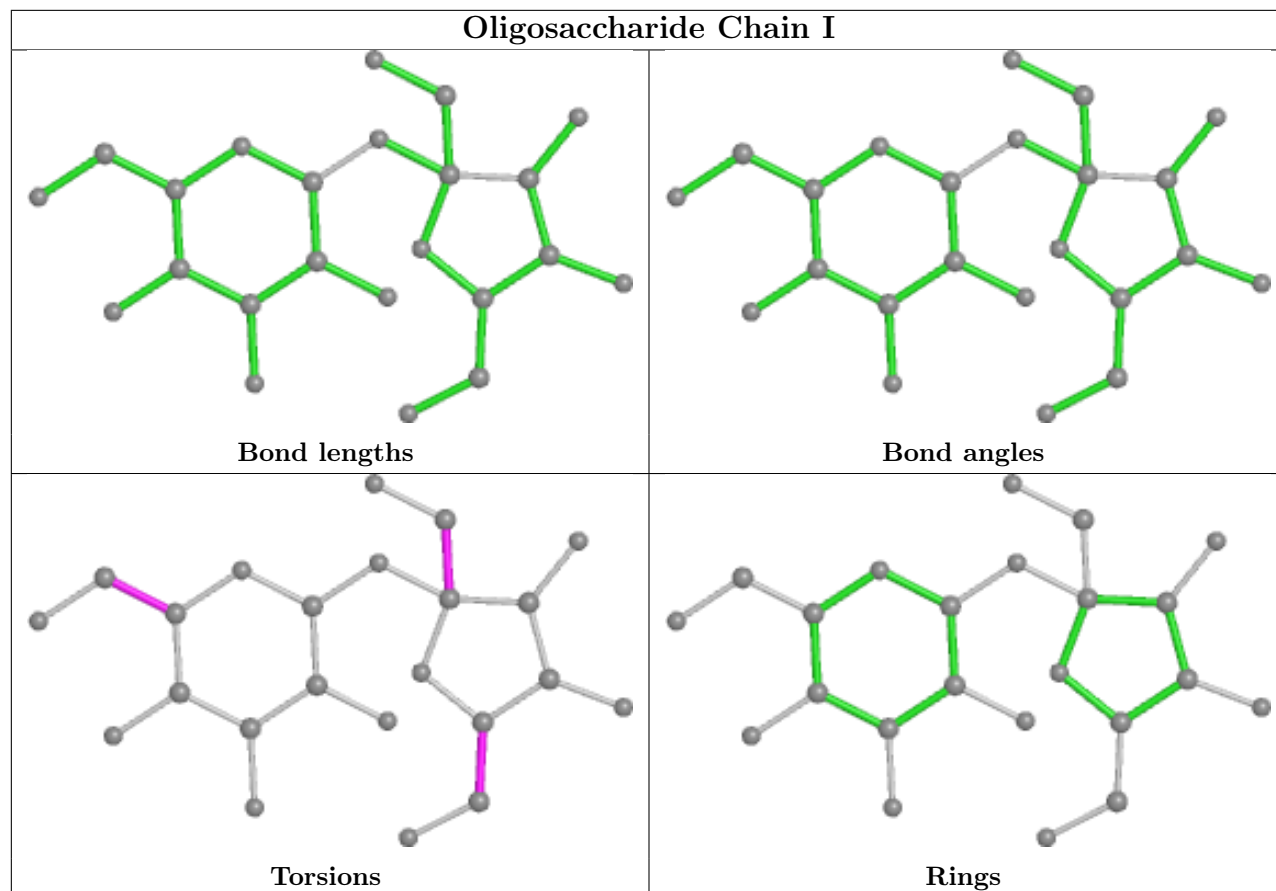

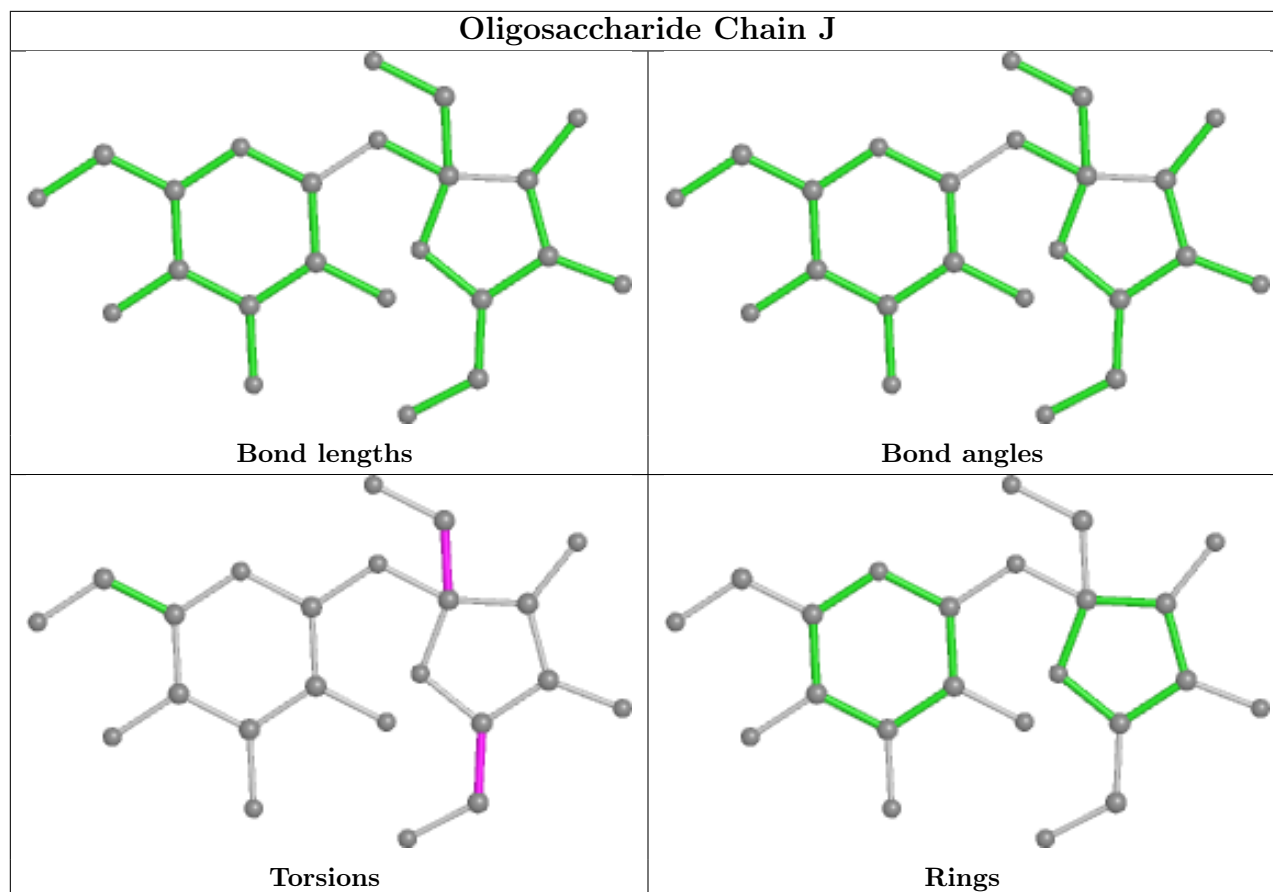

5.6 Ligand geometry [i](#)

Of 18 ligands modelled in this entry, 2 are monoatomic - leaving 16 for Mogul analysis.

In the following table, the Counts columns list the number of bonds (or angles) for which Mogul statistics could be retrieved, the number of bonds (or angles) that are observed in the model and the number of bonds (or angles) that are defined in the Chemical Component Dictionary. The Link column lists molecule types, if any, to which the group is linked. The Z score for a bond length (or angle) is the number of standard deviations the observed value is removed from the expected value. A bond length (or angle) with $|Z| > 2$ is considered an outlier worth inspection. RMSZ is the root-mean-square of all Z scores of the bond lengths (or angles).

Mol	Type	Chain	Res	Link	Bond lengths			Bond angles		
					Counts	RMSZ	$\# Z > 2$	Counts	RMSZ	$\# Z > 2$
5	SO4	A	601	-	4,4,4	0.14	0	6,6,6	0.05	0
6	GOL	D	503	-	5,5,5	0.90	0	5,5,5	1.05	0
6	GOL	C	605	-	5,5,5	0.89	0	5,5,5	1.06	0
6	GOL	B	502	-	5,5,5	0.95	0	5,5,5	0.90	0
7	DCP	C	604	8	25,29,29	0.49	0	37,45,45	0.83	2 (5%)
7	DCP	A	603	8	25,29,29	0.42	0	37,45,45	0.82	1 (2%)
6	GOL	D	501	-	5,5,5	0.84	0	5,5,5	1.04	0
6	GOL	B	501	-	5,5,5	0.96	0	5,5,5	0.92	0

Mol	Type	Chain	Res	Link	Bond lengths			Bond angles		
					Counts	RMSZ	# Z > 2	Counts	RMSZ	# Z > 2
6	GOL	A	604	-	5,5,5	0.87	0	5,5,5	1.08	0
6	GOL	B	504	-	5,5,5	0.90	0	5,5,5	1.03	0
6	GOL	C	602	-	5,5,5	0.86	0	5,5,5	1.07	0
6	GOL	B	503	-	5,5,5	0.89	0	5,5,5	0.99	0
6	GOL	D	502	-	5,5,5	0.92	0	5,5,5	0.94	0
6	GOL	C	603	-	5,5,5	0.88	0	5,5,5	1.05	0
6	GOL	A	602	-	5,5,5	0.84	0	5,5,5	1.02	0
5	SO4	C	601	-	4,4,4	0.14	0	6,6,6	0.05	0

In the following table, the Chirals column lists the number of chiral outliers, the number of chiral centers analysed, the number of these observed in the model and the number defined in the Chemical Component Dictionary. Similar counts are reported in the Torsion and Rings columns. '-' means no outliers of that kind were identified.

Mol	Type	Chain	Res	Link	Chirals	Torsions	Rings
6	GOL	D	503	-	-	2/4/4/4	-
6	GOL	C	605	-	-	2/4/4/4	-
6	GOL	B	502	-	-	2/4/4/4	-
7	DCP	C	604	8	-	6/22/34/34	0/2/2/2
7	DCP	A	603	8	-	8/22/34/34	0/2/2/2
6	GOL	D	501	-	-	2/4/4/4	-
6	GOL	B	501	-	-	2/4/4/4	-
6	GOL	A	604	-	-	2/4/4/4	-
6	GOL	B	504	-	-	0/4/4/4	-
6	GOL	C	602	-	-	2/4/4/4	-
6	GOL	B	503	-	-	2/4/4/4	-
6	GOL	D	502	-	-	4/4/4/4	-
6	GOL	C	603	-	-	2/4/4/4	-
6	GOL	A	602	-	-	4/4/4/4	-

There are no bond length outliers.

All (3) bond angle outliers are listed below:

Mol	Chain	Res	Type	Atoms	Z	Observed(°)	Ideal(°)
7	C	604	DCP	O2B-PB-O1B	3.93	131.65	112.24
7	A	603	DCP	O2B-PB-O1B	3.75	130.78	112.24
7	C	604	DCP	O3G-PG-O3B	2.00	111.35	104.64

There are no chirality outliers.

5 of 40 torsion outliers are listed below:

Mol	Chain	Res	Type	Atoms
6	A	602	GOL	O1-C1-C2-C3
6	A	602	GOL	C1-C2-C3-O3
6	A	604	GOL	O1-C1-C2-C3
6	B	502	GOL	O1-C1-C2-O2
6	B	502	GOL	O1-C1-C2-C3

There are no ring outliers.

4 monomers are involved in 4 short contacts:

Mol	Chain	Res	Type	Clashes	Symm-Clashes
6	D	503	GOL	1	0
6	B	502	GOL	1	0
7	A	603	DCP	1	0
6	D	501	GOL	1	0

The following is a two-dimensional graphical depiction of Mogul quality analysis of bond lengths, bond angles, torsion angles, and ring geometry for all instances of the Ligand of Interest. In addition, ligands with molecular weight > 250 and outliers as shown on the validation Tables will also be included. For torsion angles, if less than 5% of the Mogul distribution of torsion angles is within 10 degrees of the torsion angle in question, then that torsion angle is considered an outlier. Any bond that is central to one or more torsion angles identified as an outlier by Mogul will be highlighted in the graph. For rings, the root-mean-square deviation (RMSD) between the ring in question and similar rings identified by Mogul is calculated over all ring torsion angles. If the average RMSD is greater than 60 degrees and the minimal RMSD between the ring in question and any Mogul-identified rings is also greater than 60 degrees, then that ring is considered an outlier. The outliers are highlighted in purple. The color gray indicates Mogul did not find sufficient equivalents in the CSD to analyse the geometry.

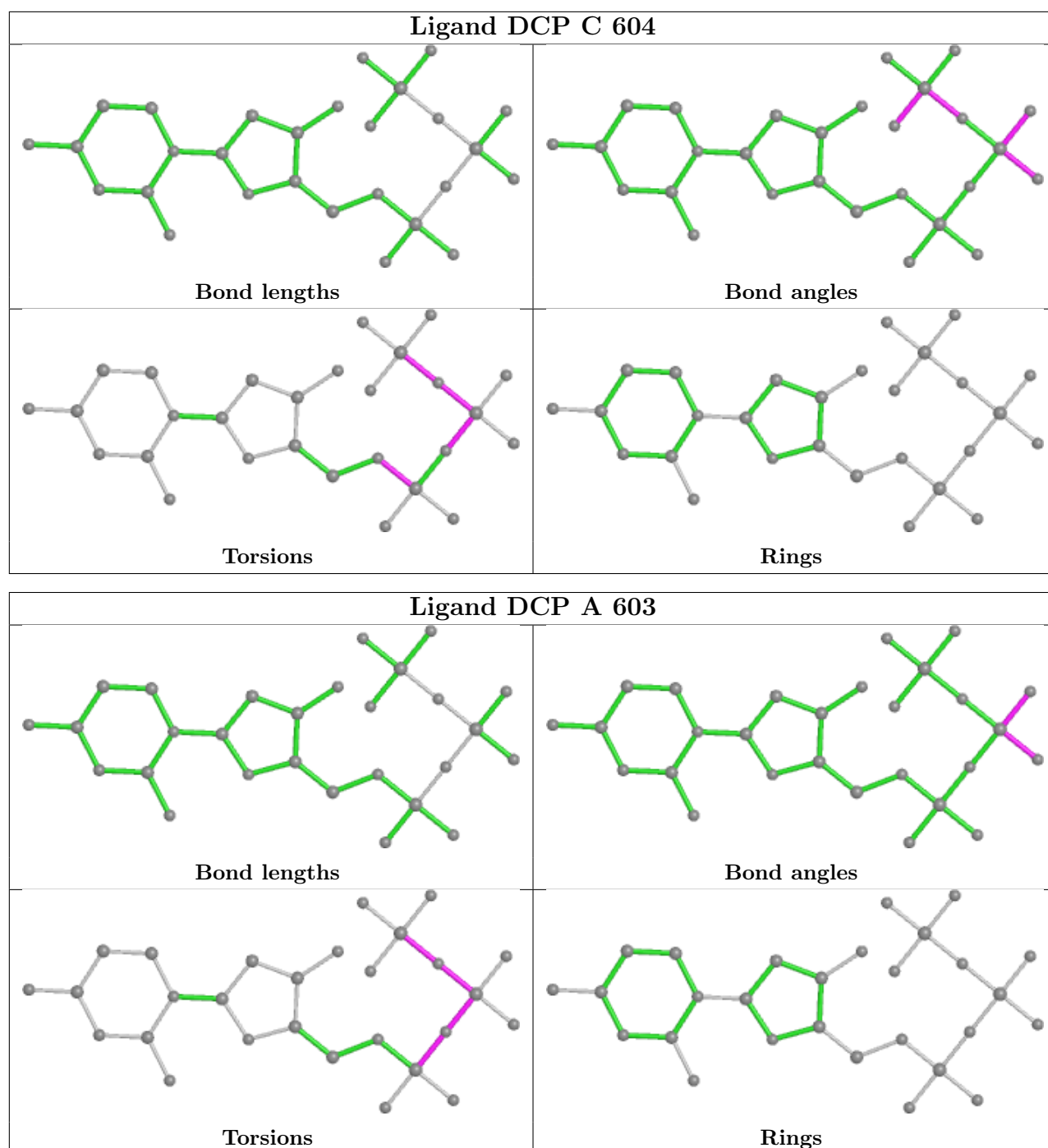

5.7 Other polymers [i](#)

There are no such residues in this entry.

5.8 Polymer linkage issues [i](#)

There are no chain breaks in this entry.

6 Fit of model and data [i](#)

6.1 Protein, DNA and RNA chains [i](#)

In the following table, the column labelled ‘#RSRZ> 2’ contains the number (and percentage) of RSRZ outliers, followed by percent RSRZ outliers for the chain as percentile scores relative to all X-ray entries and entries of similar resolution. The OWAB column contains the minimum, median, 95th percentile and maximum values of the occupancy-weighted average B-factor per residue. The column labelled ‘Q< 0.9’ lists the number of (and percentage) of residues with an average occupancy less than 0.9.

Mol	Chain	Analysed	<RSRZ>	#RSRZ>2	OWAB(Å ²)	Q<0.9
1	A	553/555 (99%)	0.07	33 (5%) 21 10	20, 65, 147, 193	0
1	C	553/555 (99%)	0.21	51 (9%) 9 3	11, 81, 165, 206	0
2	B	415/429 (96%)	-0.13	11 (2%) 54 32	23, 63, 125, 168	0
2	D	410/429 (95%)	0.09	23 (5%) 24 11	24, 80, 147, 185	0
3	E	33/38 (86%)	-0.09	0 100 100	41, 80, 120, 176	0
3	F	33/38 (86%)	0.30	1 (3%) 50 29	51, 94, 131, 170	0
All	All	1997/2044 (97%)	0.07	119 (5%) 21 10	11, 71, 152, 206	0

The worst 5 of 119 RSRZ outliers are listed below:

Mol	Chain	Res	Type	RSRZ
1	A	133	PRO	7.7
1	C	133	PRO	7.1
1	A	1	PRO	6.9
1	C	2	ILE	6.8
2	B	214	LEU	6.8

6.2 Non-standard residues in protein, DNA, RNA chains [i](#)

In the following table, the Atoms column lists the number of modelled atoms in the group and the number defined in the chemical component dictionary. The B-factors column lists the minimum, median, 95th percentile and maximum values of B factors of atoms in the group. The column labelled ‘Q< 0.9’ lists the number of atoms with occupancy less than 0.9.

Mol	Type	Chain	Res	Atoms	RSCC	RSR	B-factors(Å ²)	Q<0.9
3	OMC	F	2	21/22	0.94	0.19	78,89,94,101	0
3	OMC	E	2	21/22	0.97	0.20	58,73,87,89	0
3	OMC	F	4	21/22	0.97	0.18	50,63,76,77	0
3	OMC	E	4	21/22	0.97	0.18	32,45,54,61	0

6.3 Carbohydrates [i](#)

In the following table, the Atoms column lists the number of modelled atoms in the group and the number defined in the chemical component dictionary. The B-factors column lists the minimum, median, 95th percentile and maximum values of B factors of atoms in the group. The column labelled 'Q<0.9' lists the number of atoms with occupancy less than 0.9.

Mol	Type	Chain	Res	Atoms	RSCC	RSR	B-factors(Å ²)	Q<0.9
4	FRU	I	2	12/12	0.86	0.46	67,94,105,109	0
4	GLC	I	1	11/12	0.89	0.30	51,82,94,98	0
4	FRU	J	2	12/12	0.90	0.23	71,94,103,106	0
4	GLC	J	1	11/12	0.91	0.15	53,85,92,99	0

The following is a graphical depiction of the model fit to experimental electron density for oligosaccharide. Each fit is shown from different orientation to approximate a three-dimensional view.

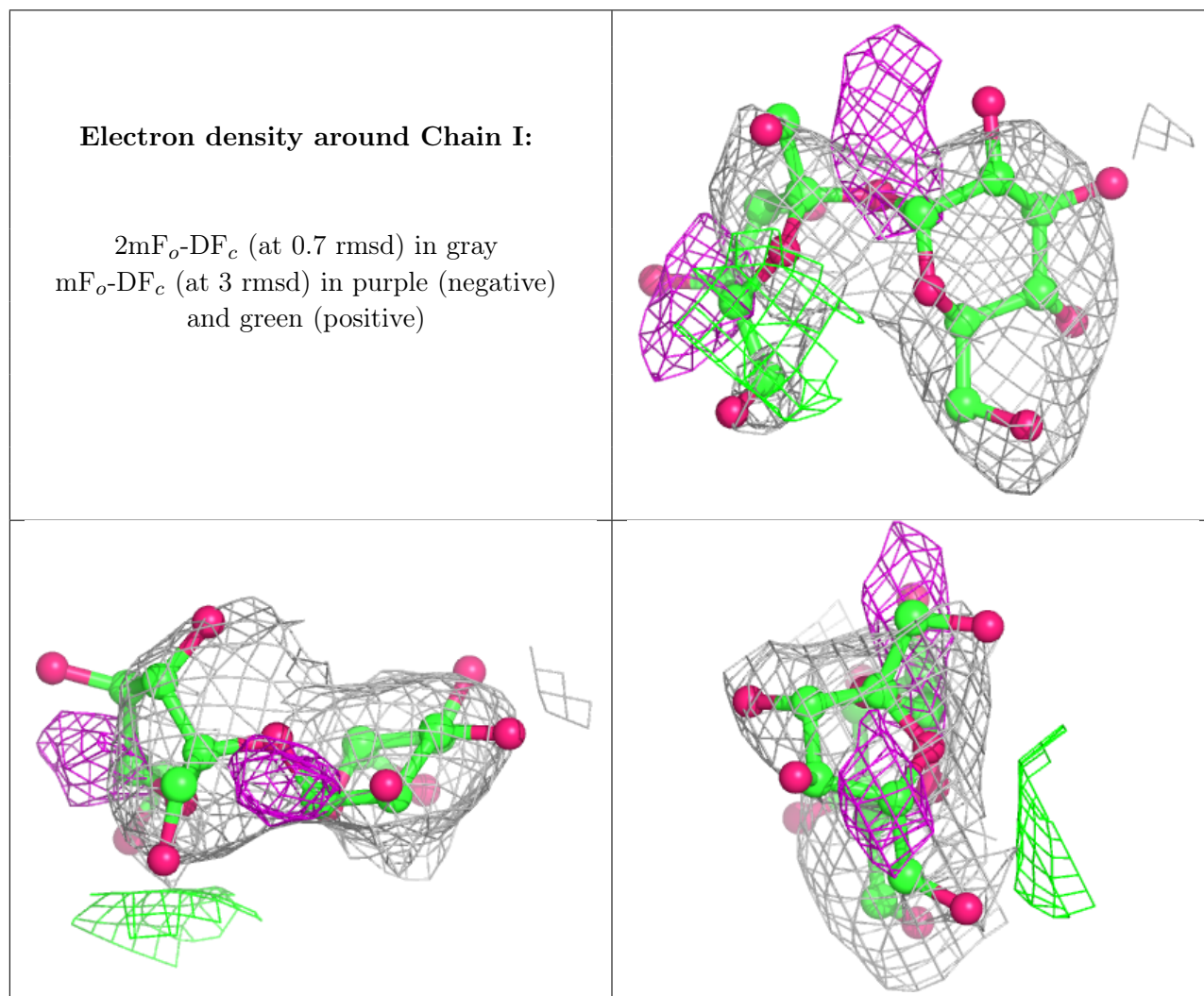

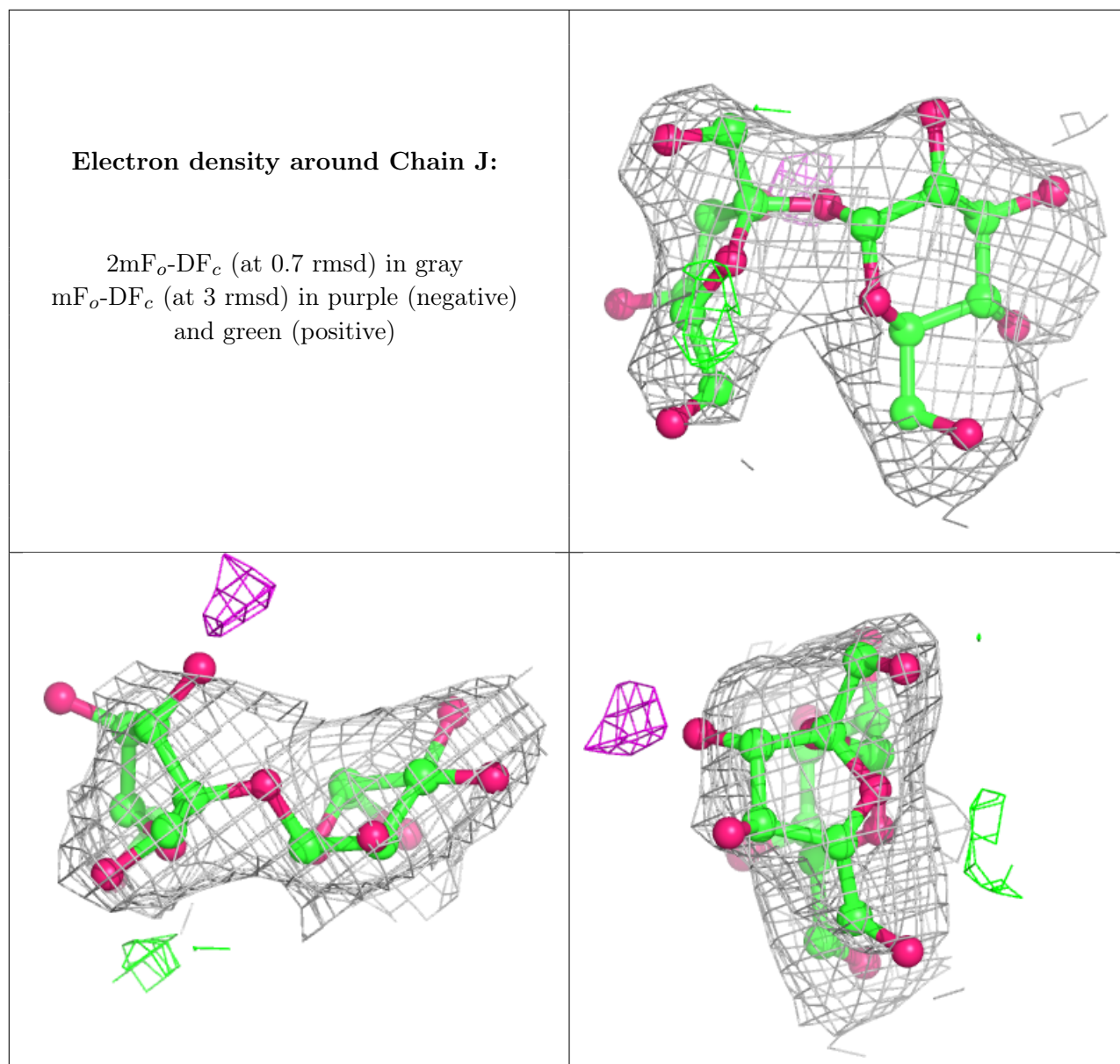

6.4 Ligands [i](#)

In the following table, the Atoms column lists the number of modelled atoms in the group and the number defined in the chemical component dictionary. The B-factors column lists the minimum, median, 95th percentile and maximum values of B factors of atoms in the group. The column labelled 'Q< 0.9' lists the number of atoms with occupancy less than 0.9.

Mol	Type	Chain	Res	Atoms	RSCC	RSR	B-factors(Å ²)	Q<0.9
6	GOL	B	504	6/6	0.78	0.38	43,54,71,84	0
8	CA	C	606	1/1	0.78	0.06	132,132,132,132	0
5	SO4	A	601	5/5	0.80	0.25	65,118,142,145	0
8	CA	A	605	1/1	0.82	0.09	100,100,100,100	0
6	GOL	C	605	6/6	0.84	0.28	62,70,87,87	0

Continued on next page...

Continued from previous page...

Mol	Type	Chain	Res	Atoms	RSCC	RSR	B-factors(\AA^2)	Q<0.9
6	GOL	D	503	6/6	0.84	0.32	50,52,67,75	0
6	GOL	A	602	6/6	0.85	0.32	40,69,72,82	0
6	GOL	C	603	6/6	0.85	0.24	50,60,68,75	0
6	GOL	D	501	6/6	0.86	0.30	49,58,72,87	0
6	GOL	B	501	6/6	0.87	0.36	25,44,55,61	0
7	DCP	C	604	28/28	0.87	0.23	82,102,138,161	0
6	GOL	C	602	6/6	0.89	0.53	42,48,53,57	0
6	GOL	A	604	6/6	0.92	0.33	35,41,48,49	0
6	GOL	D	502	6/6	0.92	0.25	38,49,59,70	0
6	GOL	B	502	6/6	0.92	0.30	25,47,57,61	0
5	SO4	C	601	5/5	0.95	0.16	86,87,98,101	0
6	GOL	B	503	6/6	0.95	0.22	35,43,52,53	0
7	DCP	A	603	28/28	0.96	0.14	63,80,102,118	0

The following is a graphical depiction of the model fit to experimental electron density of all instances of the Ligand of Interest. In addition, ligands with molecular weight > 250 and outliers as shown on the geometry validation Tables will also be included. Each fit is shown from different orientation to approximate a three-dimensional view.

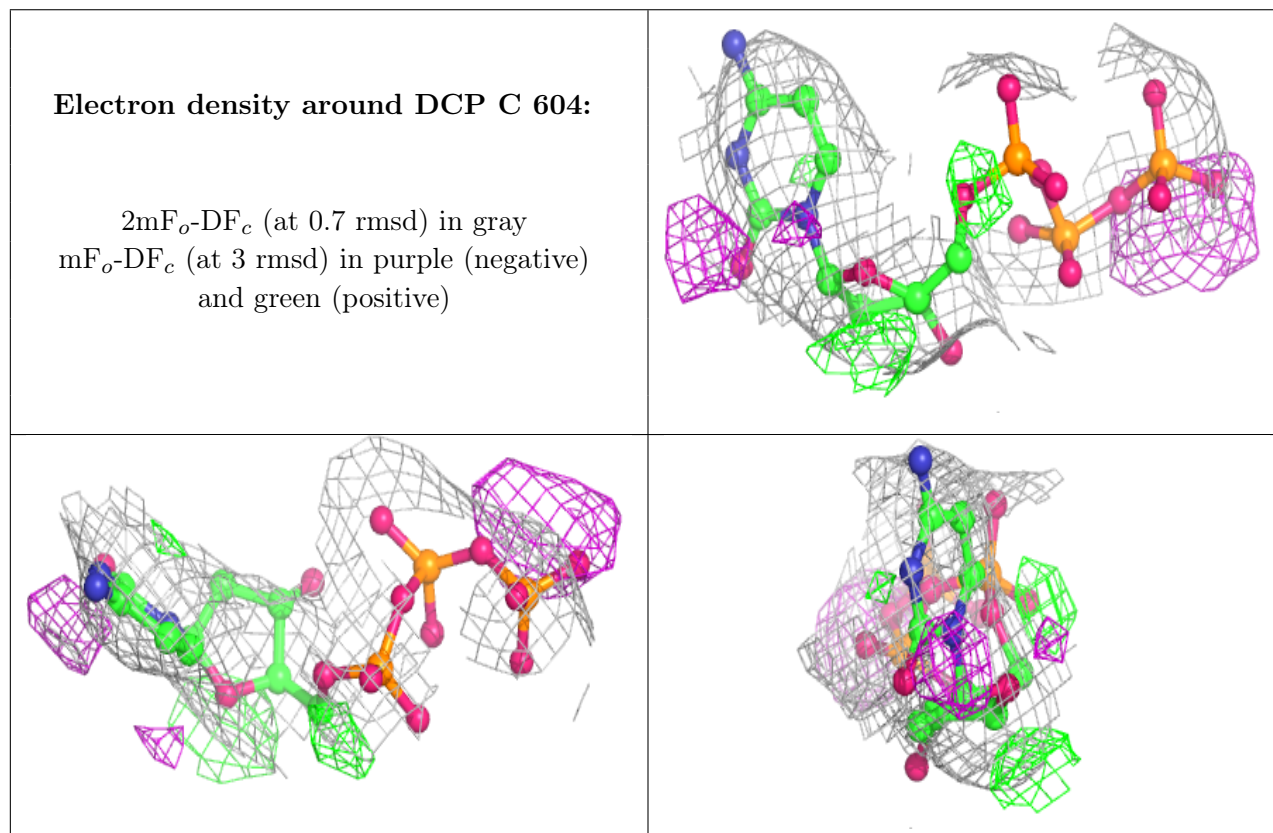

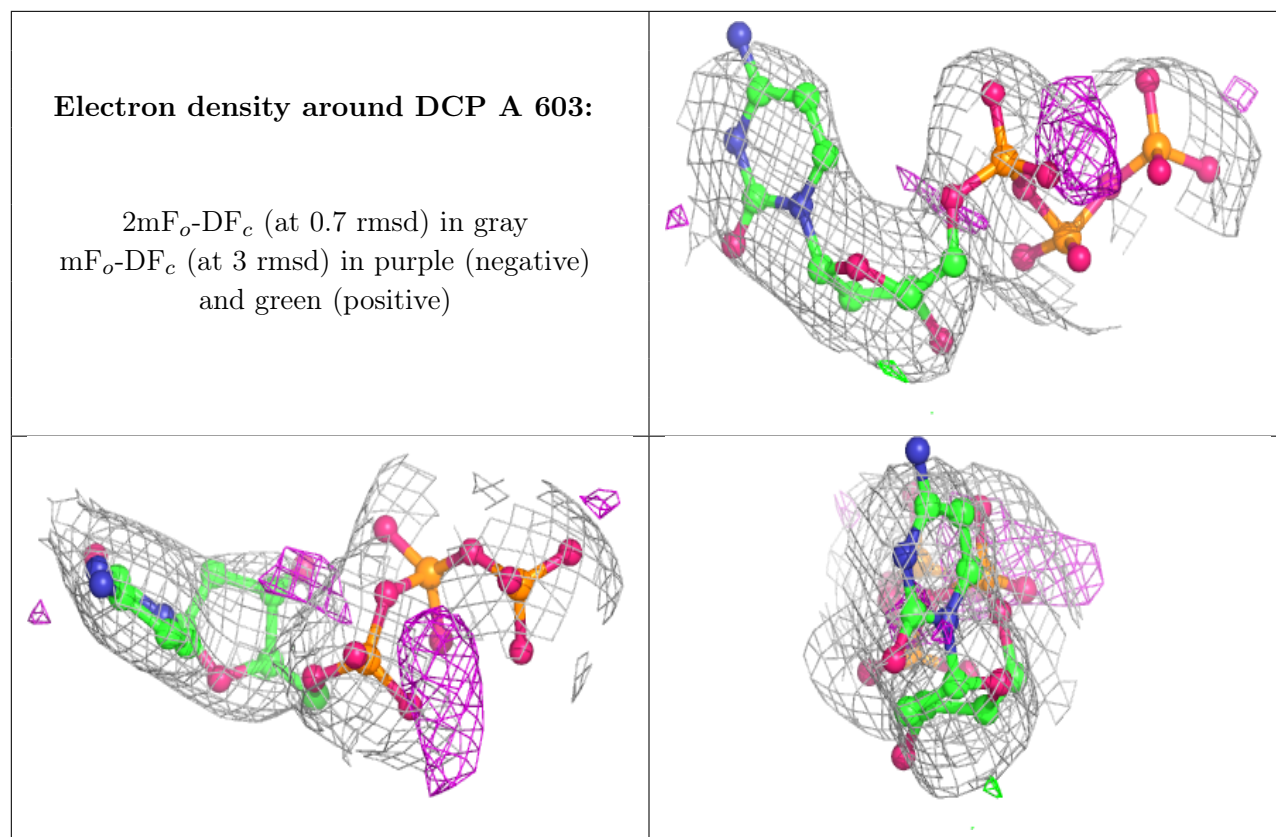

6.5 Other polymers [i](#)

There are no such residues in this entry.