



wwPDB EM Validation Summary Report ⓘ

Nov 19, 2022 – 01:40 pm GMT

PDB ID : 5MP9
EMDB ID : EMD-3534
Title : 26S proteasome in presence of ATP (s1)
Authors : Wehmer, M.; Rudack, T.; Beck, F.; Aufderheide, A.; Pfeifer, G.; Plitzko, J.M.;
Foerster, F.; Schulten, K.; Baumeister, W.; Sakata, E.
Deposited on : 2016-12-16
Resolution : 4.10 Å(reported)

This is a wwPDB EM Validation Summary Report for a publicly released PDB entry.

We welcome your comments at validation@mail.wwpdb.org

A user guide is available at

<https://www.wwpdb.org/validation/2017/EMValidationReportHelp>

with specific help available everywhere you see the ⓘ symbol.

The types of validation reports are described at

<http://www.wwpdb.org/validation/2017/FAQs#types>.

The following versions of software and data (see [references ⓘ](#)) were used in the production of this report:

EMDB validation analysis : 0.0.1.dev43
Mogul : 1.8.4, CSD as541be (2020)
MolProbity : 4.02b-467
buster-report : 1.1.7 (2018)
Percentile statistics : 20191225.v01 (using entries in the PDB archive December 25th 2019)
MapQ : 1.9.9
Ideal geometry (proteins) : Engh & Huber (2001)
Ideal geometry (DNA, RNA) : Parkinson et al. (1996)
Validation Pipeline (wwPDB-VP) : 2.31.2

1 Overall quality at a glance i

The following experimental techniques were used to determine the structure:
ELECTRON MICROSCOPY

The reported resolution of this entry is 4.10 Å.

Percentile scores (ranging between 0-100) for global validation metrics of the entry are shown in the following graphic. The table shows the number of entries on which the scores are based.

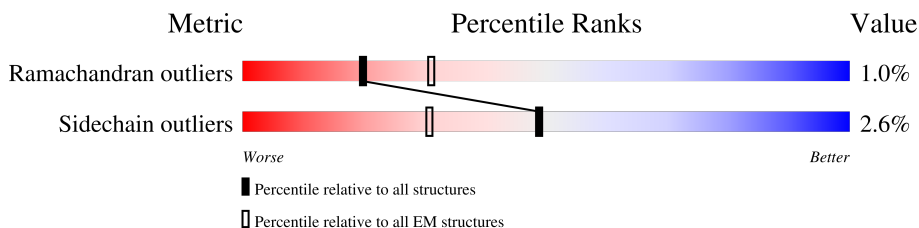

Metric	Whole archive (#Entries)	EM structures (#Entries)
Ramachandran outliers	154571	4023
Sidechain outliers	154315	3826

The table below summarises the geometric issues observed across the polymeric chains and their fit to the map. The red, orange, yellow and green segments of the bar indicate the fraction of residues that contain outliers for ≥ 3 , 2, 1 and 0 types of geometric quality criteria respectively. A grey segment represents the fraction of residues that are not modelled. The numeric value for each fraction is indicated below the corresponding segment, with a dot representing fractions $\leq 5\%$. The upper red bar (where present) indicates the fraction of residues that have poor fit to the EM map (all-atom inclusion $< 40\%$). The numeric value is given above the bar.

Mol	Chain	Length	Quality of chain
1	A	252	89% 6% .
1	a	252	92% . .
2	B	250	96% . .
2	b	250	96% .
3	C	258	90% . 5%
3	c	258	91% . 5%
4	D	254	85% 8% . 6%
4	d	254	91% . 6%
5	E	260	86% 7% . 7%

Continued on next page...

Continued from previous page...

Mol	Chain	Length	Quality of chain
5	e	260	88% 7%
6	F	234	93% 6%
6	f	234	95%
7	G	288	78% 6% 16%
7	g	288	82% 16%
8	1	215	87% 9%
8	h	215	89% 9%
9	2	261	84% 13%
9	i	261	84% 13%
10	3	205	96%
10	j	205	99%
11	4	198	95%
11	k	198	93% 5%
12	5	287	71% 26%
12	l	287	70% 26%
13	6	241	88% 8%
13	m	241	90% 8%
14	7	266	82% 14%
14	n	266	83% 13%
15	H	467	77% 6% 16% 11%
16	I	437	84% 12% 14%
17	K	428	85% 6% 9% 13%
18	L	437	86% 11% 13%
19	M	434	82% 6% 12% 13%
20	J	405	92% 5% 21%

2 Entry composition [i](#)

There are 23 unique types of molecules in this entry. The entry contains 67883 atoms, of which 0 are hydrogens and 0 are deuteriums.

In the tables below, the AltConf column contains the number of residues with at least one atom in alternate conformation and the Trace column contains the number of residues modelled with at most 2 atoms.

- Molecule 1 is a protein called Proteasome subunit alpha type-1.

Mol	Chain	Residues	Atoms					AltConf	Trace
			Total	C	N	O	S		
1	a	241	Total	C	N	O	S	0	0
			1907	1214	320	365	8		
1	A	241	Total	C	N	O	S	0	0
			1907	1214	320	365	8		

- Molecule 2 is a protein called Proteasome subunit alpha type-2.

Mol	Chain	Residues	Atoms					AltConf	Trace
			Total	C	N	O	S		
2	b	250	Total	C	N	O	S	0	0
			1915	1219	315	377	4		
2	B	250	Total	C	N	O	S	0	0
			1915	1219	315	377	4		

- Molecule 3 is a protein called Proteasome subunit alpha type-3.

Mol	Chain	Residues	Atoms					AltConf	Trace
			Total	C	N	O	S		
3	c	244	Total	C	N	O	S	0	0
			1904	1201	321	379	3		
3	C	244	Total	C	N	O	S	0	0
			1904	1201	321	379	3		

- Molecule 4 is a protein called Proteasome subunit alpha type-4.

Mol	Chain	Residues	Atoms					AltConf	Trace
			Total	C	N	O	S		
4	d	240	Total	C	N	O	S	0	0
			1881	1176	329	372	4		
4	D	240	Total	C	N	O	S	0	0
			1881	1176	329	372	4		

- Molecule 5 is a protein called Proteasome subunit alpha type-5.

Mol	Chain	Residues	Atoms					AltConf	Trace
5	e	242	Total	C	N	O	S	0	0
			1861	1162	314	378	7		
5	E	242	Total	C	N	O	S	0	0
			1861	1162	314	378	7		

- Molecule 6 is a protein called Proteasome subunit alpha type-6.

Mol	Chain	Residues	Atoms					AltConf	Trace
6	f	231	Total	C	N	O	S	0	0
			1773	1114	307	348	4		
6	F	233	Total	C	N	O	S	0	0
			1795	1129	312	350	4		

- Molecule 7 is a protein called Probable proteasome subunit alpha type-7.

Mol	Chain	Residues	Atoms					AltConf	Trace
7	g	243	Total	C	N	O	S	0	0
			1892	1203	329	356	4		
7	G	243	Total	C	N	O	S	0	0
			1892	1203	329	356	4		

- Molecule 8 is a protein called Proteasome subunit beta type-1.

Mol	Chain	Residues	Atoms					AltConf	Trace
8	h	196	Total	C	N	O	S	0	0
			1512	955	250	300	7		
8	1	196	Total	C	N	O	S	0	0
			1512	955	250	300	7		

- Molecule 9 is a protein called Proteasome subunit beta type-2.

Mol	Chain	Residues	Atoms					AltConf	Trace
9	i	226	Total	C	N	O	S	0	0
			1719	1082	298	332	7		
9	2	226	Total	C	N	O	S	0	0
			1719	1082	298	332	7		

- Molecule 10 is a protein called Proteasome subunit beta type-3.

Mol	Chain	Residues	Atoms					AltConf	Trace
10	j	204	Total	C	N	O	S	0	0
			1581	1010	258	305	8		

Continued on next page...

Continued from previous page...

Mol	Chain	Residues	Atoms					AltConf	Trace
10	3	204	Total	C	N	O	S	0	0
			1581	1010	258	305	8		

- Molecule 11 is a protein called Proteasome subunit beta type-4.

Mol	Chain	Residues	Atoms					AltConf	Trace
11	k	195	Total	C	N	O	S	0	0
			1561	992	264	299	6		
11	4	195	Total	C	N	O	S	0	0
			1561	992	264	299	6		

- Molecule 12 is a protein called Proteasome subunit beta type-5.

Mol	Chain	Residues	Atoms					AltConf	Trace
12	l	212	Total	C	N	O	S	0	0
			1644	1045	280	312	7		
12	5	212	Total	C	N	O	S	0	0
			1644	1045	280	312	7		

- Molecule 13 is a protein called Proteasome subunit beta type-6.

Mol	Chain	Residues	Atoms					AltConf	Trace
13	m	222	Total	C	N	O	S	0	0
			1757	1115	303	335	4		
13	6	222	Total	C	N	O	S	0	0
			1757	1115	303	335	4		

- Molecule 14 is a protein called Proteasome subunit beta type-7.

Mol	Chain	Residues	Atoms					AltConf	Trace
14	n	232	Total	C	N	O	S	0	0
			1815	1148	311	349	7		
14	7	229	Total	C	N	O	S	0	0
			1790	1133	306	344	7		

- Molecule 15 is a protein called 26S protease regulatory subunit 7 homolog.

Mol	Chain	Residues	Atoms					AltConf	Trace
15	H	390	Total	C	N	O	S	0	0
			3053	1920	546	570	17		

- Molecule 16 is a protein called 26S protease regulatory subunit 4 homolog.

Mol	Chain	Residues	Atoms					AltConf	Trace
			Total	C	N	O	S		
16	I	385	3022	1899	508	598	17	0	0

- Molecule 17 is a protein called 26S protease regulatory subunit 6B homolog.

Mol	Chain	Residues	Atoms					AltConf	Trace
			Total	C	N	O	S		
17	K	389	3078	1933	540	595	10	0	0

- Molecule 18 is a protein called 26S protease subunit RPT4.

Mol	Chain	Residues	Atoms					AltConf	Trace
			Total	C	N	O	S		
18	L	388	3082	1942	548	580	12	0	0

- Molecule 19 is a protein called 26S protease regulatory subunit 6A.

Mol	Chain	Residues	Atoms					AltConf	Trace
			Total	C	N	O	S		
19	M	381	2986	1870	524	580	12	0	0

- Molecule 20 is a protein called 26S protease regulatory subunit 8 homolog.

Mol	Chain	Residues	Atoms					AltConf	Trace
			Total	C	N	O	S		
20	J	386	3033	1906	543	567	17	0	0

- Molecule 21 is ADENOSINE-5'-TRIPHOSPHATE (three-letter code: ATP) (formula: $C_{10}H_{16}N_5O_{13}P_3$).



Mol	Chain	Residues	Atoms					AltConf
			Total	C	N	O	P	
21	H	1	Total	C	N	O	P	0
			31	10	5	13	3	
21	I	1	Total	C	N	O	P	0
			31	10	5	13	3	
21	K	1	Total	C	N	O	P	0
			31	10	5	13	3	
21	L	1	Total	C	N	O	P	0
			31	10	5	13	3	
21	M	1	Total	C	N	O	P	0
			31	10	5	13	3	

- Molecule 22 is MAGNESIUM ION (three-letter code: MG) (formula: Mg).

Mol	Chain	Residues	Atoms		AltConf
			Total	Mg	
22	H	1	Total	Mg	0
			1	1	
22	I	1	Total	Mg	0
			1	1	
22	K	1	Total	Mg	0
			1	1	
22	L	1	Total	Mg	0
			1	1	
22	M	1	Total	Mg	0
			1	1	
22	J	1	Total	Mg	0
			1	1	

- Molecule 23 is ADENOSINE-5'-DIPHOSPHATE (three-letter code: ADP) (formula:

C₁₀H₁₅N₅O₁₀P₂).

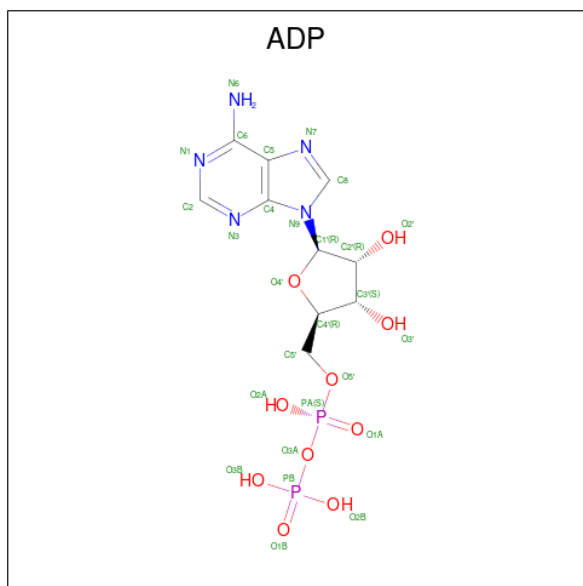

Mol	Chain	Residues	Atoms					AltConf
			Total	C	N	O	P	
23	J	1	27	10	5	10	2	0

3 Residue-property plots [i](#)

These plots are drawn for all protein, RNA, DNA and oligosaccharide chains in the entry. The first graphic for a chain summarises the proportions of the various outlier classes displayed in the second graphic. The second graphic shows the sequence view annotated by issues in geometry and atom inclusion in map density. Residues are color-coded according to the number of geometric quality criteria for which they contain at least one outlier: green = 0, yellow = 1, orange = 2 and red = 3 or more. A red diamond above a residue indicates a poor fit to the EM map for this residue (all-atom inclusion < 40%). Stretches of 2 or more consecutive residues without any outlier are shown as a green connector. Residues present in the sample, but not in the model, are shown in grey.

- Molecule 1: Proteasome subunit alpha type-1

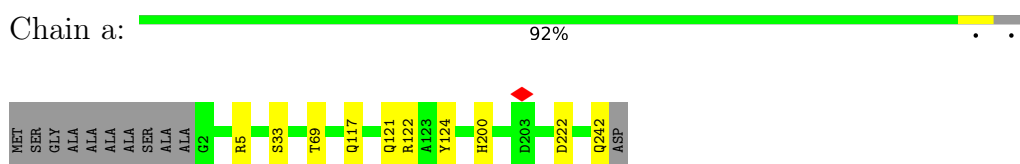

- Molecule 1: Proteasome subunit alpha type-1

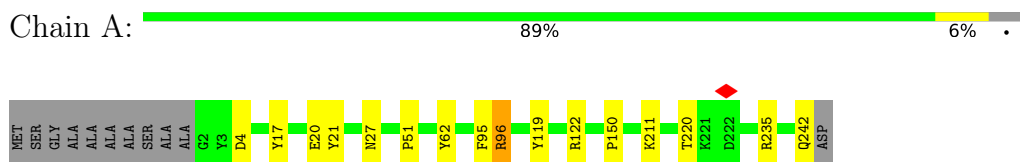

- Molecule 2: Proteasome subunit alpha type-2

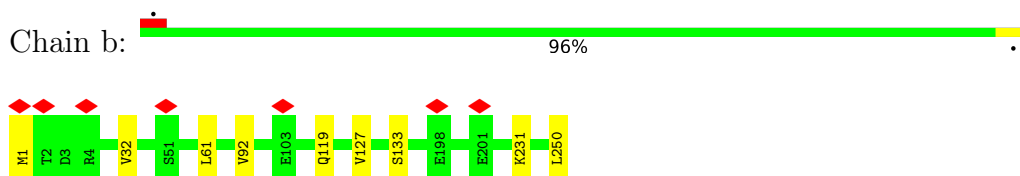

- Molecule 2: Proteasome subunit alpha type-2

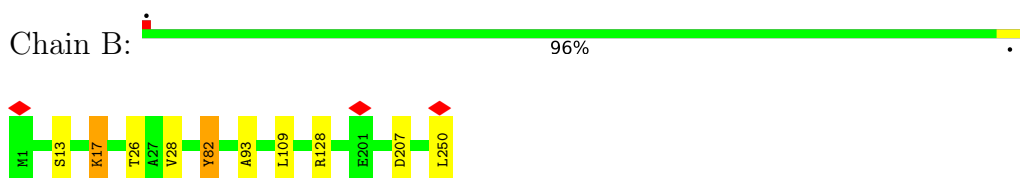

- Molecule 3: Proteasome subunit alpha type-3

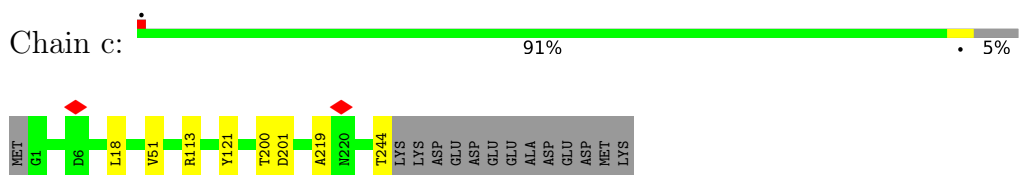

- Molecule 3: Proteasome subunit alpha type-3

Chain C:  90% 5%

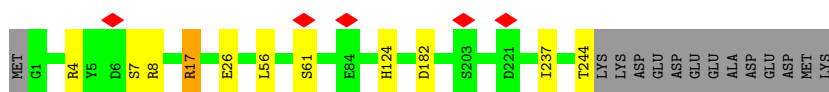

- Molecule 4: Proteasome subunit alpha type-4

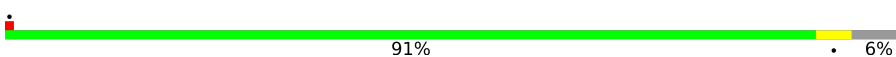
Chain d:  91% 6%



- Molecule 4: Proteasome subunit alpha type-4

Chain D:  85% 8% 6%



- Molecule 5: Proteasome subunit alpha type-5

Chain e:  88% 7%

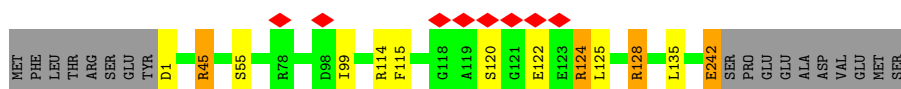

- Molecule 5: Proteasome subunit alpha type-5

Chain E:  86% 7% 7%

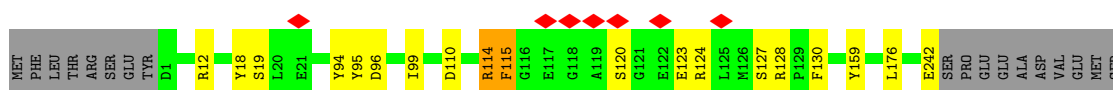

- Molecule 6: Proteasome subunit alpha type-6

Chain f:  95%

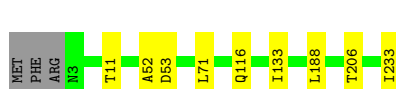

- Molecule 6: Proteasome subunit alpha type-6

Chain F:  93% 6%

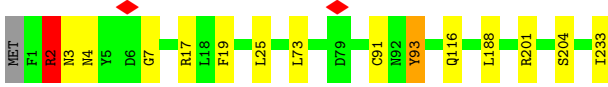

• Molecule 7: Probable proteasome subunit alpha type-7

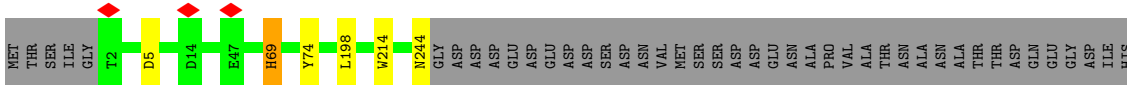
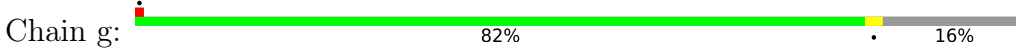

• Molecule 7: Probable proteasome subunit alpha type-7

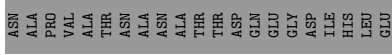
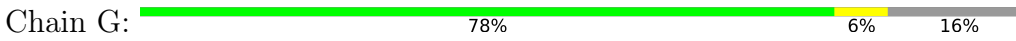

• Molecule 8: Proteasome subunit beta type-1

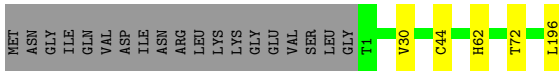
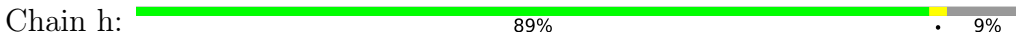

• Molecule 8: Proteasome subunit beta type-1

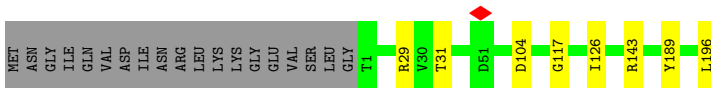
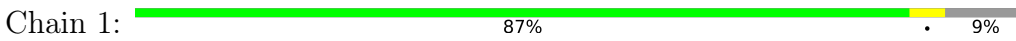

• Molecule 9: Proteasome subunit beta type-2

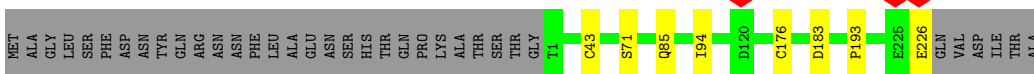
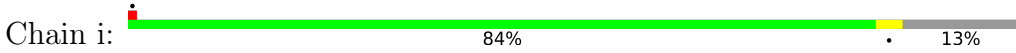

• Molecule 9: Proteasome subunit beta type-2

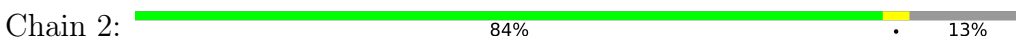

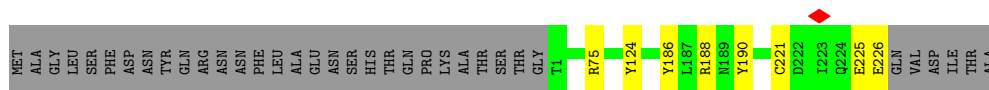

• Molecule 10: Proteasome subunit beta type-3

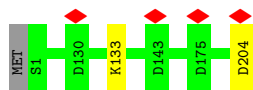

• Molecule 10: Proteasome subunit beta type-3

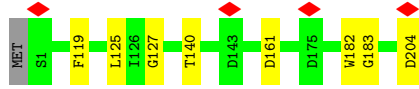

• Molecule 11: Proteasome subunit beta type-4

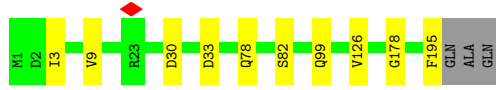

• Molecule 11: Proteasome subunit beta type-4



• Molecule 12: Proteasome subunit beta type-5

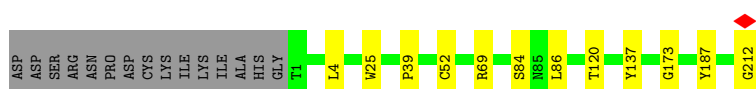

• Molecule 12: Proteasome subunit beta type-5



- Molecule 16: 26S protease regulatory subunit 4 homolog

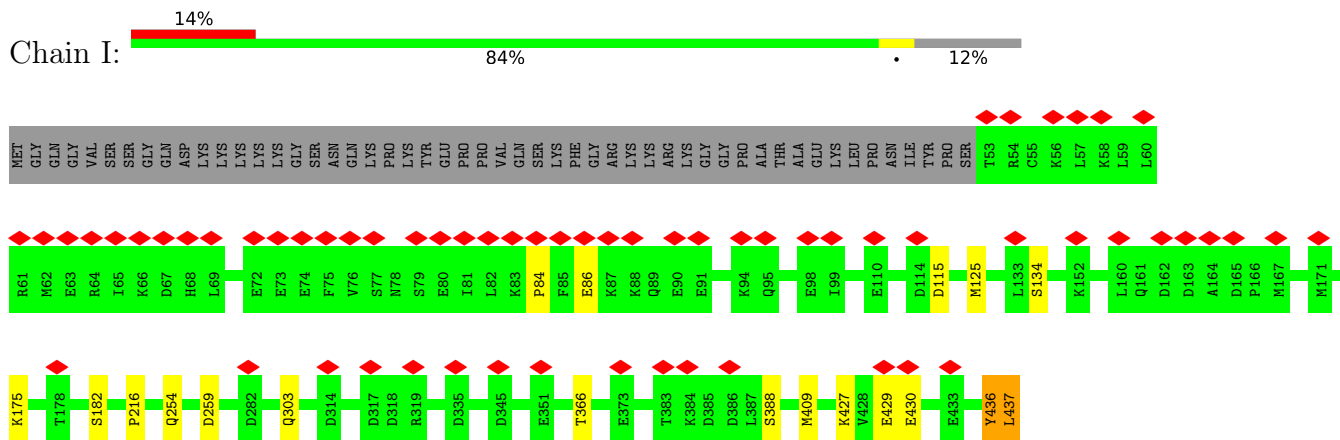

- Molecule 17: 26S protease regulatory subunit 6B homolog

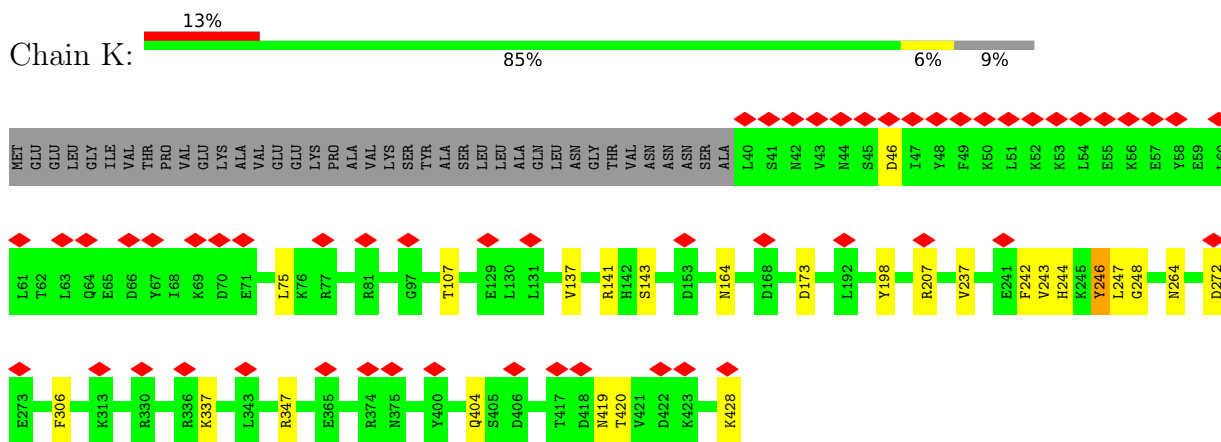

- Molecule 18: 26S protease subunit RPT4

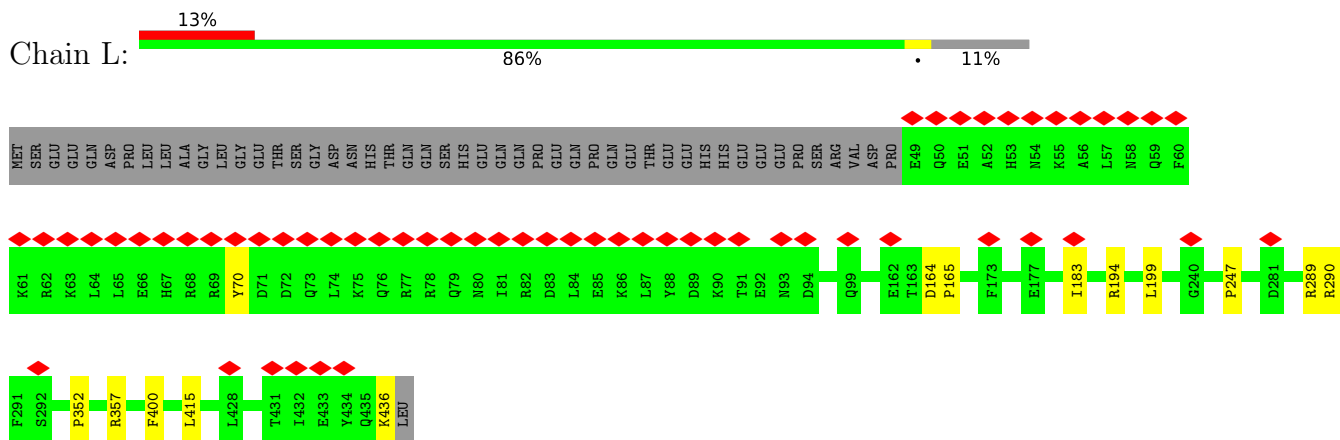

- Molecule 19: 26S protease regulatory subunit 6A

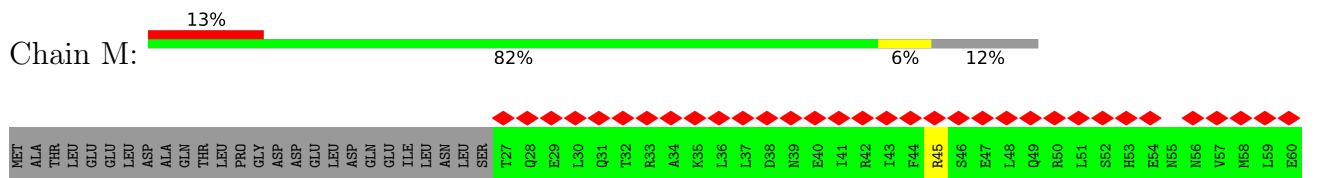

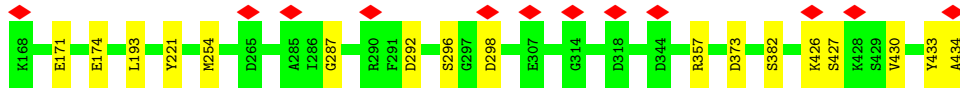
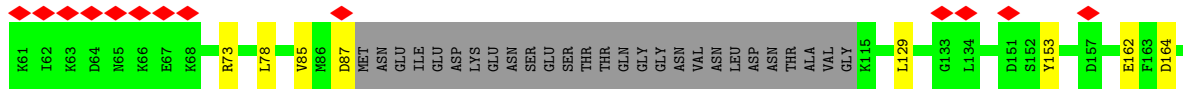

• Molecule 20: 26S protease regulatory subunit 8 homolog

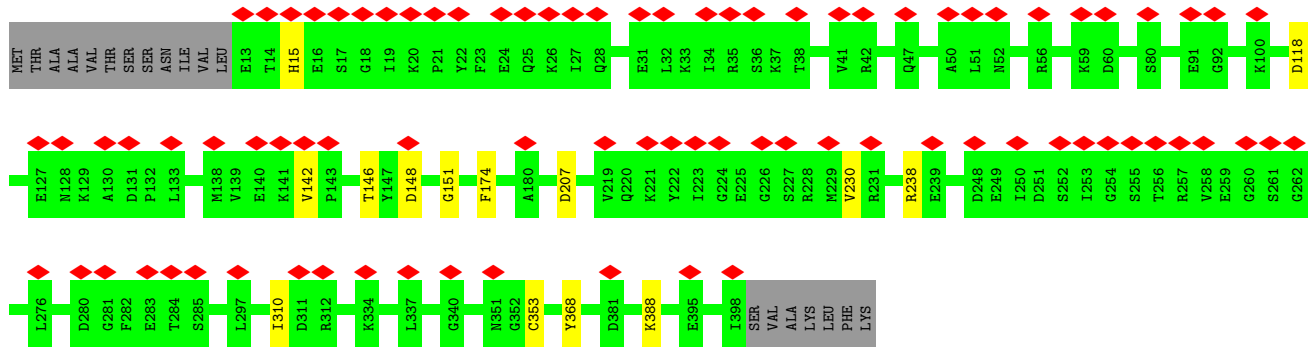
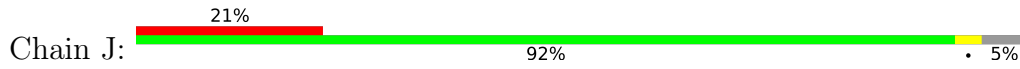

4 Experimental information

Property	Value	Source
EM reconstruction method	SINGLE PARTICLE	Depositor
Imposed symmetry	POINT, C1	Depositor
Number of particles used	286500	Depositor
Resolution determination method	FSC 0.143 CUT-OFF	Depositor
CTF correction method	PHASE FLIPPING AND AMPLITUDE CORRECTION	Depositor
Microscope	FEI TITAN KRIOS	Depositor
Voltage (kV)	300	Depositor
Electron dose ($e^-/\text{\AA}^2$)	45	Depositor
Minimum defocus (nm)	1500	Depositor
Maximum defocus (nm)	3500	Depositor
Magnification	Not provided	
Image detector	GATAN K2 SUMMIT (4k x 4k)	Depositor
Maximum map value	0.211	Depositor
Minimum map value	-0.133	Depositor
Average map value	-0.000	Depositor
Map value standard deviation	0.006	Depositor
Recommended contour level	0.02	Depositor
Map size (Å)	529.92, 529.92, 529.92	wwPDB
Map dimensions	384, 384, 384	wwPDB
Map angles (°)	90.0, 90.0, 90.0	wwPDB
Pixel spacing (Å)	1.38, 1.38, 1.38	Depositor

5 Model quality [i](#)

5.1 Standard geometry [i](#)

Bond lengths and bond angles in the following residue types are not validated in this section: MG, ADP, ATP

The Z score for a bond length (or angle) is the number of standard deviations the observed value is removed from the expected value. A bond length (or angle) with $|Z| > 5$ is considered an outlier worth inspection. RMSZ is the root-mean-square of all Z scores of the bond lengths (or angles).

Mol	Chain	Bond lengths		Bond angles	
		RMSZ	# Z >5	RMSZ	# Z >5
1	A	0.84	4/1945 (0.2%)	0.93	10/2634 (0.4%)
1	a	0.44	1/1945 (0.1%)	0.54	1/2634 (0.0%)
2	B	0.87	2/1952 (0.1%)	0.96	6/2642 (0.2%)
2	b	0.53	2/1952 (0.1%)	0.55	1/2642 (0.0%)
3	C	0.84	2/1934 (0.1%)	0.91	4/2618 (0.2%)
3	c	0.46	1/1934 (0.1%)	0.56	1/2618 (0.0%)
4	D	0.86	1/1910 (0.1%)	0.95	10/2586 (0.4%)
4	d	0.44	1/1910 (0.1%)	0.55	1/2586 (0.0%)
5	E	1.02	7/1886 (0.4%)	1.19	20/2541 (0.8%)
5	e	0.79	4/1886 (0.2%)	0.80	5/2541 (0.2%)
6	F	0.93	4/1823 (0.2%)	0.96	8/2463 (0.3%)
6	f	0.53	2/1800 (0.1%)	0.56	1/2433 (0.0%)
7	G	0.90	4/1932 (0.2%)	0.91	11/2609 (0.4%)
7	g	0.45	1/1932 (0.1%)	0.53	1/2609 (0.0%)
8	1	0.89	3/1541 (0.2%)	0.90	4/2087 (0.2%)
8	h	0.59	2/1541 (0.1%)	0.56	1/2087 (0.0%)
9	2	0.80	2/1750 (0.1%)	0.92	7/2373 (0.3%)
9	i	0.49	1/1750 (0.1%)	0.58	1/2373 (0.0%)
10	3	0.88	3/1611 (0.2%)	0.86	1/2174 (0.0%)
10	j	0.58	2/1611 (0.1%)	0.55	1/2174 (0.0%)
11	4	0.79	1/1589 (0.1%)	0.92	4/2142 (0.2%)
11	k	0.49	1/1589 (0.1%)	0.54	1/2142 (0.0%)
12	5	0.92	2/1681 (0.1%)	0.92	5/2274 (0.2%)
12	l	0.60	2/1681 (0.1%)	0.58	1/2274 (0.0%)
13	6	0.87	2/1795 (0.1%)	0.92	3/2420 (0.1%)
13	m	0.57	2/1795 (0.1%)	0.56	1/2420 (0.0%)
14	7	0.91	2/1821 (0.1%)	0.99	7/2470 (0.3%)
14	n	0.49	1/1846 (0.1%)	0.59	1/2503 (0.0%)
15	H	0.70	5/3102 (0.2%)	0.75	9/4175 (0.2%)
16	I	0.66	2/3061 (0.1%)	0.70	2/4121 (0.0%)
17	K	0.67	4/3121 (0.1%)	0.72	8/4213 (0.2%)
18	L	0.67	2/3128 (0.1%)	0.74	7/4204 (0.2%)

Mol	Chain	Bond lengths		Bond angles	
		RMSZ	# Z >5	RMSZ	# Z >5
19	M	0.71	3/3023 (0.1%)	0.74	7/4070 (0.2%)
20	J	0.55	0/3073	0.65	4/4129 (0.1%)
All	All	0.71	78/68850 (0.1%)	0.77	155/92981 (0.2%)

Chiral center outliers are detected by calculating the chiral volume of a chiral center and verifying if the center is modelled as a planar moiety or with the opposite hand. A planarity outlier is detected by checking planarity of atoms in a peptide group, atoms in a mainchain group or atoms of a sidechain that are expected to be planar.

Mol	Chain	#Chirality outliers	#Planarity outliers
1	A	0	1
2	B	0	1
3	C	0	1
4	D	0	3
5	e	0	2
6	F	0	2
7	G	0	2
8	1	0	1
13	6	0	2
14	7	0	1
14	n	0	1
15	H	0	1
16	I	0	1
18	L	0	1
19	M	0	1
All	All	0	21

The worst 5 of 78 bond length outliers are listed below:

Mol	Chain	Res	Type	Atoms	Z	Observed(Å)	Ideal(Å)
14	7	229	GLY	C-O	-14.49	1.00	1.23
12	5	212	GLY	C-O	-14.48	1.00	1.23
12	1	212	GLY	C-O	-14.48	1.00	1.23
9	2	226	GLU	C-O	-12.13	1.00	1.23
3	C	244	THR	C-O	-12.09	1.00	1.23

The worst 5 of 155 bond angle outliers are listed below:

Mol	Chain	Res	Type	Atoms	Z	Observed(°)	Ideal(°)
11	4	139	TYR	CB-CG-CD2	-12.28	113.64	121.00
3	C	17	ARG	NE-CZ-NH1	-12.00	114.30	120.30
5	E	124	ARG	NE-CZ-NH2	-11.92	114.34	120.30

Continued on next page...

Continued from previous page...

Mol	Chain	Res	Type	Atoms	Z	Observed(°)	Ideal(°)
6	F	93	TYR	CB-CG-CD2	-11.62	114.03	121.00
2	B	82	TYR	CB-CG-CD2	-11.20	114.28	121.00

There are no chirality outliers.

5 of 21 planarity outliers are listed below:

Mol	Chain	Res	Type	Group
1	A	96	ARG	Sidechain
2	B	82	TYR	Sidechain
5	e	124	ARG	Sidechain
5	e	128	ARG	Sidechain
14	n	77	ASP	Peptide

5.2 Too-close contacts [i](#)

Due to software issues we are unable to calculate clashes - this section is therefore empty.

5.3 Torsion angles [i](#)

5.3.1 Protein backbone [i](#)

In the following table, the Percentiles column shows the percent Ramachandran outliers of the chain as a percentile score with respect to all PDB entries followed by that with respect to all EM entries.

The Analysed column shows the number of residues for which the backbone conformation was analysed, and the total number of residues.

Mol	Chain	Analysed	Favoured	Allowed	Outliers	Percentiles	
1	A	239/252 (95%)	228 (95%)	9 (4%)	2 (1%)	19	58
1	a	239/252 (95%)	224 (94%)	14 (6%)	1 (0%)	34	71
2	B	248/250 (99%)	235 (95%)	12 (5%)	1 (0%)	34	71
2	b	248/250 (99%)	232 (94%)	16 (6%)	0	100	100
3	C	242/258 (94%)	232 (96%)	9 (4%)	1 (0%)	34	71
3	c	242/258 (94%)	227 (94%)	13 (5%)	2 (1%)	19	58
4	D	238/254 (94%)	223 (94%)	12 (5%)	3 (1%)	12	47
4	d	238/254 (94%)	224 (94%)	12 (5%)	2 (1%)	19	58
5	E	240/260 (92%)	228 (95%)	9 (4%)	3 (1%)	12	47

Continued on next page...

Continued from previous page...

Mol	Chain	Analysed	Favoured	Allowed	Outliers	Percentiles	
5	e	240/260 (92%)	225 (94%)	12 (5%)	3 (1%)	12	47
6	F	231/234 (99%)	214 (93%)	14 (6%)	3 (1%)	12	47
6	f	229/234 (98%)	216 (94%)	11 (5%)	2 (1%)	17	54
7	G	241/288 (84%)	228 (95%)	11 (5%)	2 (1%)	19	58
7	g	241/288 (84%)	229 (95%)	11 (5%)	1 (0%)	34	71
8	1	194/215 (90%)	181 (93%)	12 (6%)	1 (0%)	29	67
8	h	194/215 (90%)	178 (92%)	15 (8%)	1 (0%)	29	67
9	2	224/261 (86%)	214 (96%)	9 (4%)	1 (0%)	34	71
9	i	224/261 (86%)	205 (92%)	17 (8%)	2 (1%)	17	54
10	3	202/205 (98%)	184 (91%)	14 (7%)	4 (2%)	7	39
10	j	202/205 (98%)	181 (90%)	21 (10%)	0	100	100
11	4	193/198 (98%)	184 (95%)	8 (4%)	1 (0%)	29	67
11	k	193/198 (98%)	186 (96%)	5 (3%)	2 (1%)	15	52
12	5	210/287 (73%)	195 (93%)	13 (6%)	2 (1%)	15	52
12	l	210/287 (73%)	196 (93%)	12 (6%)	2 (1%)	15	52
13	6	220/241 (91%)	207 (94%)	13 (6%)	0	100	100
13	m	220/241 (91%)	202 (92%)	18 (8%)	0	100	100
14	7	227/266 (85%)	209 (92%)	15 (7%)	3 (1%)	12	47
14	n	230/266 (86%)	211 (92%)	19 (8%)	0	100	100
15	H	386/467 (83%)	348 (90%)	26 (7%)	12 (3%)	4	31
16	I	383/437 (88%)	353 (92%)	22 (6%)	8 (2%)	7	38
17	K	387/428 (90%)	357 (92%)	24 (6%)	6 (2%)	9	43
18	L	386/437 (88%)	361 (94%)	23 (6%)	2 (0%)	29	67
19	M	377/434 (87%)	342 (91%)	26 (7%)	9 (2%)	6	35
20	J	384/405 (95%)	356 (93%)	22 (6%)	6 (2%)	9	43
All	All	8602/9546 (90%)	8015 (93%)	499 (6%)	88 (1%)	20	52

5 of 88 Ramachandran outliers are listed below:

Mol	Chain	Res	Type
3	c	219	ALA
4	d	184	ALA
8	h	72	THR

Continued on next page...

Continued from previous page...

Mol	Chain	Res	Type
4	D	203	THR
16	I	84	PRO

5.3.2 Protein sidechains [i](#)

In the following table, the Percentiles column shows the percent sidechain outliers of the chain as a percentile score with respect to all PDB entries followed by that with respect to all EM entries.

The Analysed column shows the number of residues for which the sidechain conformation was analysed, and the total number of residues.

Mol	Chain	Analysed	Rotameric	Outliers	Percentiles
1	A	206/210 (98%)	201 (98%)	5 (2%)	49 69
1	a	206/210 (98%)	198 (96%)	8 (4%)	32 58
2	B	209/209 (100%)	204 (98%)	5 (2%)	49 69
2	b	209/209 (100%)	201 (96%)	8 (4%)	33 59
3	C	203/216 (94%)	197 (97%)	6 (3%)	41 64
3	c	203/216 (94%)	198 (98%)	5 (2%)	47 68
4	D	212/226 (94%)	201 (95%)	11 (5%)	23 51
4	d	212/226 (94%)	206 (97%)	6 (3%)	43 65
5	E	198/215 (92%)	196 (99%)	2 (1%)	76 85
5	e	198/215 (92%)	193 (98%)	5 (2%)	47 68
6	F	192/193 (100%)	185 (96%)	7 (4%)	35 60
6	f	190/193 (98%)	184 (97%)	6 (3%)	39 62
7	G	201/239 (84%)	196 (98%)	5 (2%)	47 68
7	g	201/239 (84%)	196 (98%)	5 (2%)	47 68
8	1	162/178 (91%)	159 (98%)	3 (2%)	57 75
8	h	162/178 (91%)	159 (98%)	3 (2%)	57 75
9	2	185/214 (86%)	184 (100%)	1 (0%)	88 93
9	i	185/214 (86%)	180 (97%)	5 (3%)	44 66
10	3	172/173 (99%)	170 (99%)	2 (1%)	71 83
10	j	172/173 (99%)	171 (99%)	1 (1%)	86 92
11	4	173/175 (99%)	170 (98%)	3 (2%)	60 78
11	k	173/175 (99%)	166 (96%)	7 (4%)	31 57

Continued on next page...

Continued from previous page...

Mol	Chain	Analysed	Rotameric	Outliers	Percentiles	
12	5	169/235 (72%)	166 (98%)	3 (2%)	59	77
12	l	169/235 (72%)	160 (95%)	9 (5%)	22	51
13	6	185/201 (92%)	180 (97%)	5 (3%)	44	66
13	m	185/201 (92%)	182 (98%)	3 (2%)	62	78
14	7	195/224 (87%)	194 (100%)	1 (0%)	88	93
14	n	198/224 (88%)	190 (96%)	8 (4%)	31	57
15	H	330/399 (83%)	323 (98%)	7 (2%)	53	72
16	I	342/385 (89%)	332 (97%)	10 (3%)	42	64
17	K	342/374 (91%)	328 (96%)	14 (4%)	30	57
18	L	332/377 (88%)	328 (99%)	4 (1%)	71	83
19	M	329/375 (88%)	319 (97%)	10 (3%)	41	64
20	J	336/352 (96%)	331 (98%)	5 (2%)	65	79
All	All	7336/8078 (91%)	7148 (97%)	188 (3%)	49	67

5 of 188 residues with a non-rotameric sidechain are listed below:

Mol	Chain	Res	Type
7	G	5	ASP
15	H	363	PRO
7	G	214	TRP
12	5	104	TYR
16	I	409	MET

Sometimes sidechains can be flipped to improve hydrogen bonding and reduce clashes. 5 of 14 such sidechains are listed below:

Mol	Chain	Res	Type
6	F	147	GLN
8	1	161	GLN
20	J	269	GLN
16	I	376	ASN
18	L	393	ASN

5.3.3 RNA [i](#)

There are no RNA molecules in this entry.

5.4 Non-standard residues in protein, DNA, RNA chains [i](#)

There are no non-standard protein/DNA/RNA residues in this entry.

5.5 Carbohydrates [i](#)

There are no monosaccharides in this entry.

5.6 Ligand geometry [i](#)

Of 12 ligands modelled in this entry, 6 are monoatomic - leaving 6 for Mogul analysis.

In the following table, the Counts columns list the number of bonds (or angles) for which Mogul statistics could be retrieved, the number of bonds (or angles) that are observed in the model and the number of bonds (or angles) that are defined in the Chemical Component Dictionary. The Link column lists molecule types, if any, to which the group is linked. The Z score for a bond length (or angle) is the number of standard deviations the observed value is removed from the expected value. A bond length (or angle) with $|Z| > 2$ is considered an outlier worth inspection. RMSZ is the root-mean-square of all Z scores of the bond lengths (or angles).

Mol	Type	Chain	Res	Link	Bond lengths			Bond angles		
					Counts	RMSZ	# Z > 2	Counts	RMSZ	# Z > 2
23	ADP	J	501	22	24,29,29	0.99	2 (8%)	29,45,45	1.28	3 (10%)
21	ATP	M	501	22	26,33,33	0.95	1 (3%)	31,52,52	1.34	5 (16%)
21	ATP	I	501	22	26,33,33	0.90	2 (7%)	31,52,52	1.33	5 (16%)
21	ATP	L	501	22	26,33,33	0.92	1 (3%)	31,52,52	1.37	4 (12%)
21	ATP	H	501	22	26,33,33	0.92	2 (7%)	31,52,52	1.46	6 (19%)
21	ATP	K	501	22	26,33,33	0.91	1 (3%)	31,52,52	1.36	5 (16%)

In the following table, the Chirals column lists the number of chiral outliers, the number of chiral centers analysed, the number of these observed in the model and the number defined in the Chemical Component Dictionary. Similar counts are reported in the Torsion and Rings columns. '-' means no outliers of that kind were identified.

Mol	Type	Chain	Res	Link	Chirals	Torsions	Rings
23	ADP	J	501	22	-	5/12/32/32	0/3/3/3
21	ATP	M	501	22	-	8/18/38/38	0/3/3/3
21	ATP	I	501	22	-	5/18/38/38	0/3/3/3
21	ATP	L	501	22	-	6/18/38/38	0/3/3/3
21	ATP	H	501	22	-	3/18/38/38	0/3/3/3
21	ATP	K	501	22	-	8/18/38/38	0/3/3/3

The worst 5 of 9 bond length outliers are listed below:

Mol	Chain	Res	Type	Atoms	Z	Observed(Å)	Ideal(Å)
23	J	501	ADP	O4'-C1'	2.38	1.44	1.41
21	K	501	ATP	C5-C4	2.34	1.47	1.40
23	J	501	ADP	C5-C4	2.31	1.47	1.40
21	H	501	ATP	C5-C4	2.25	1.46	1.40
21	I	501	ATP	C5-C4	2.20	1.46	1.40

The worst 5 of 28 bond angle outliers are listed below:

Mol	Chain	Res	Type	Atoms	Z	Observed(°)	Ideal(°)
21	M	501	ATP	PA-O3A-PB	-3.96	119.24	132.83
21	H	501	ATP	PB-O3B-PG	-3.88	119.50	132.83
21	L	501	ATP	PA-O3A-PB	-3.82	119.72	132.83
21	K	501	ATP	N3-C2-N1	-3.59	123.06	128.68
21	L	501	ATP	N3-C2-N1	-3.51	123.20	128.68

There are no chirality outliers.

5 of 35 torsion outliers are listed below:

Mol	Chain	Res	Type	Atoms
21	H	501	ATP	C5'-O5'-PA-O1A
21	I	501	ATP	C5'-O5'-PA-O2A
21	K	501	ATP	PB-O3B-PG-O2G
21	L	501	ATP	C5'-O5'-PA-O2A
21	L	501	ATP	C5'-O5'-PA-O3A

There are no ring outliers.

No monomer is involved in short contacts.

The following is a two-dimensional graphical depiction of Mogul quality analysis of bond lengths, bond angles, torsion angles, and ring geometry for all instances of the Ligand of Interest. In addition, ligands with molecular weight > 250 and outliers as shown on the validation Tables will also be included. For torsion angles, if less than 5% of the Mogul distribution of torsion angles is within 10 degrees of the torsion angle in question, then that torsion angle is considered an outlier. Any bond that is central to one or more torsion angles identified as an outlier by Mogul will be highlighted in the graph. For rings, the root-mean-square deviation (RMSD) between the ring in question and similar rings identified by Mogul is calculated over all ring torsion angles. If the average RMSD is greater than 60 degrees and the minimal RMSD between the ring in question and any Mogul-identified rings is also greater than 60 degrees, then that ring is considered an outlier. The outliers are highlighted in purple. The color gray indicates Mogul did not find sufficient equivalents in the CSD to analyse the geometry.

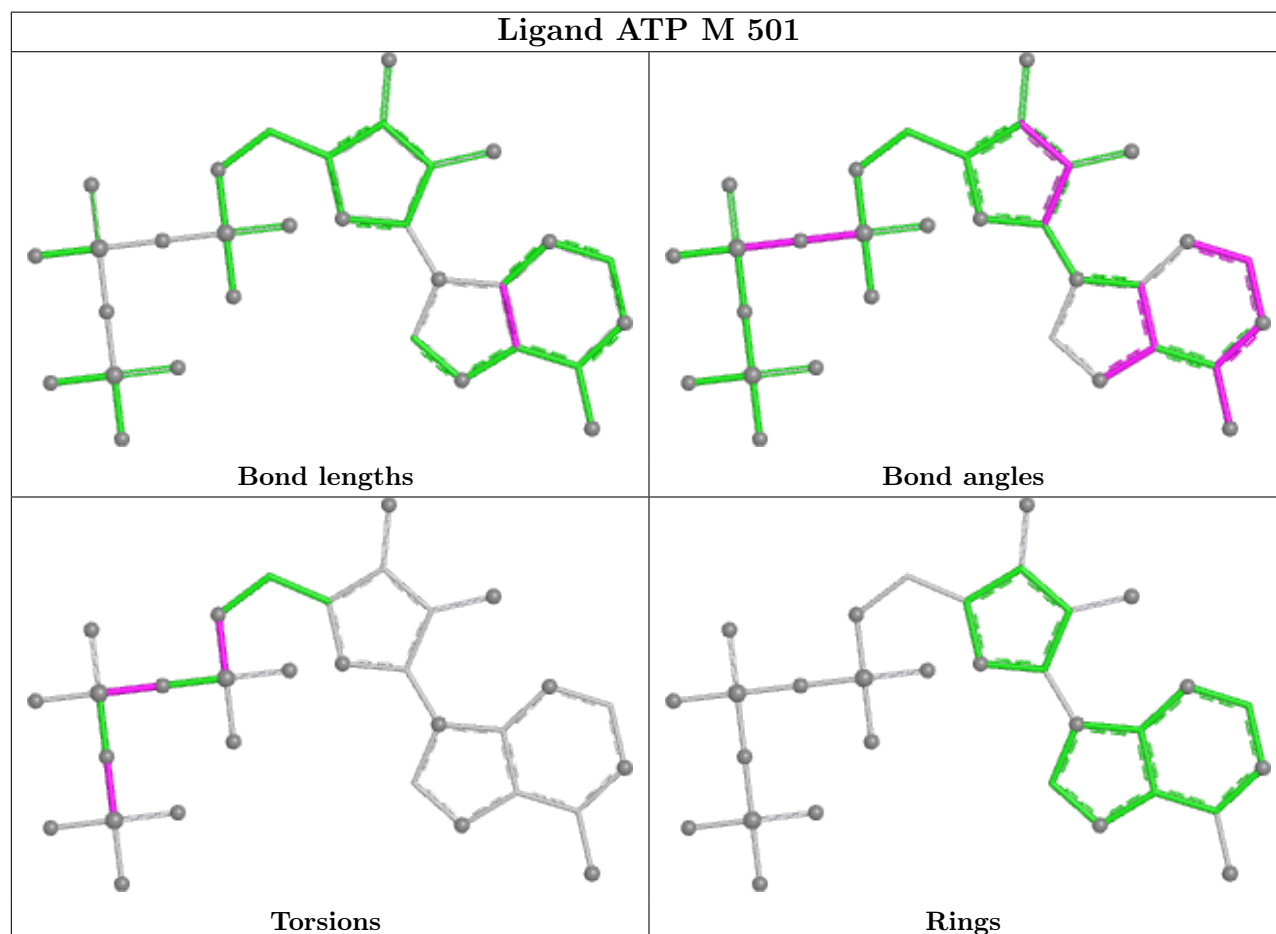
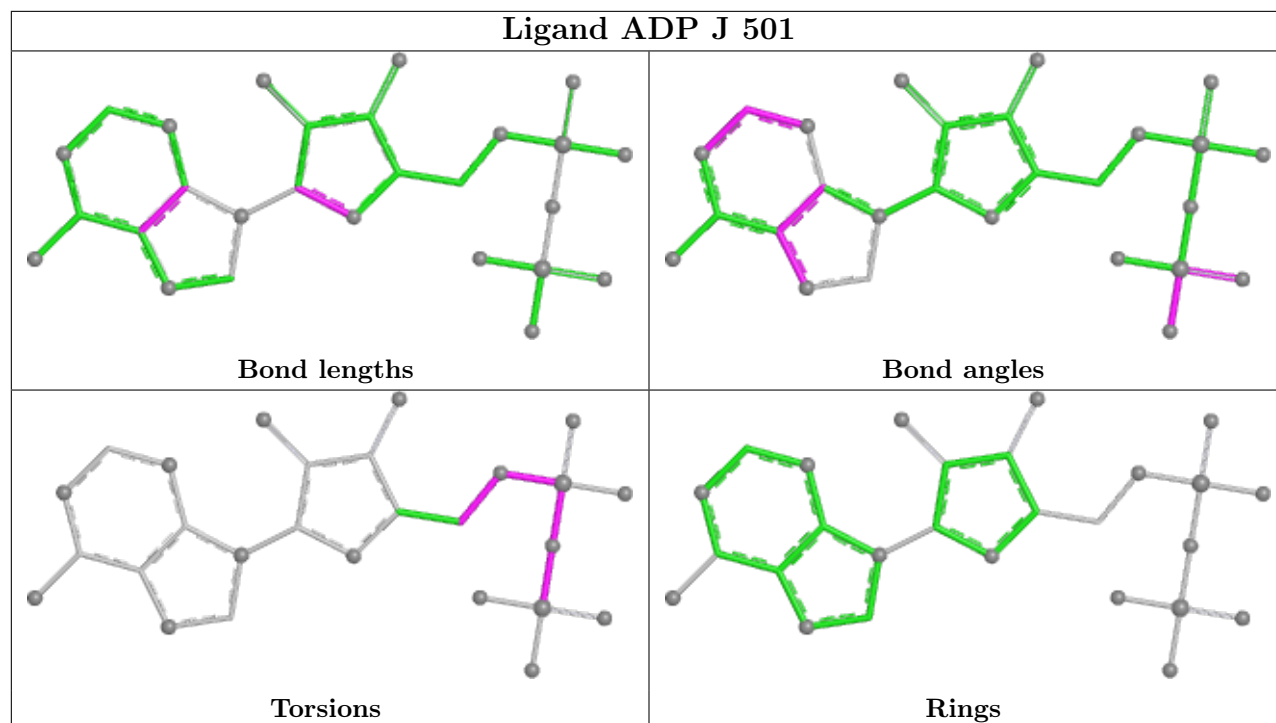

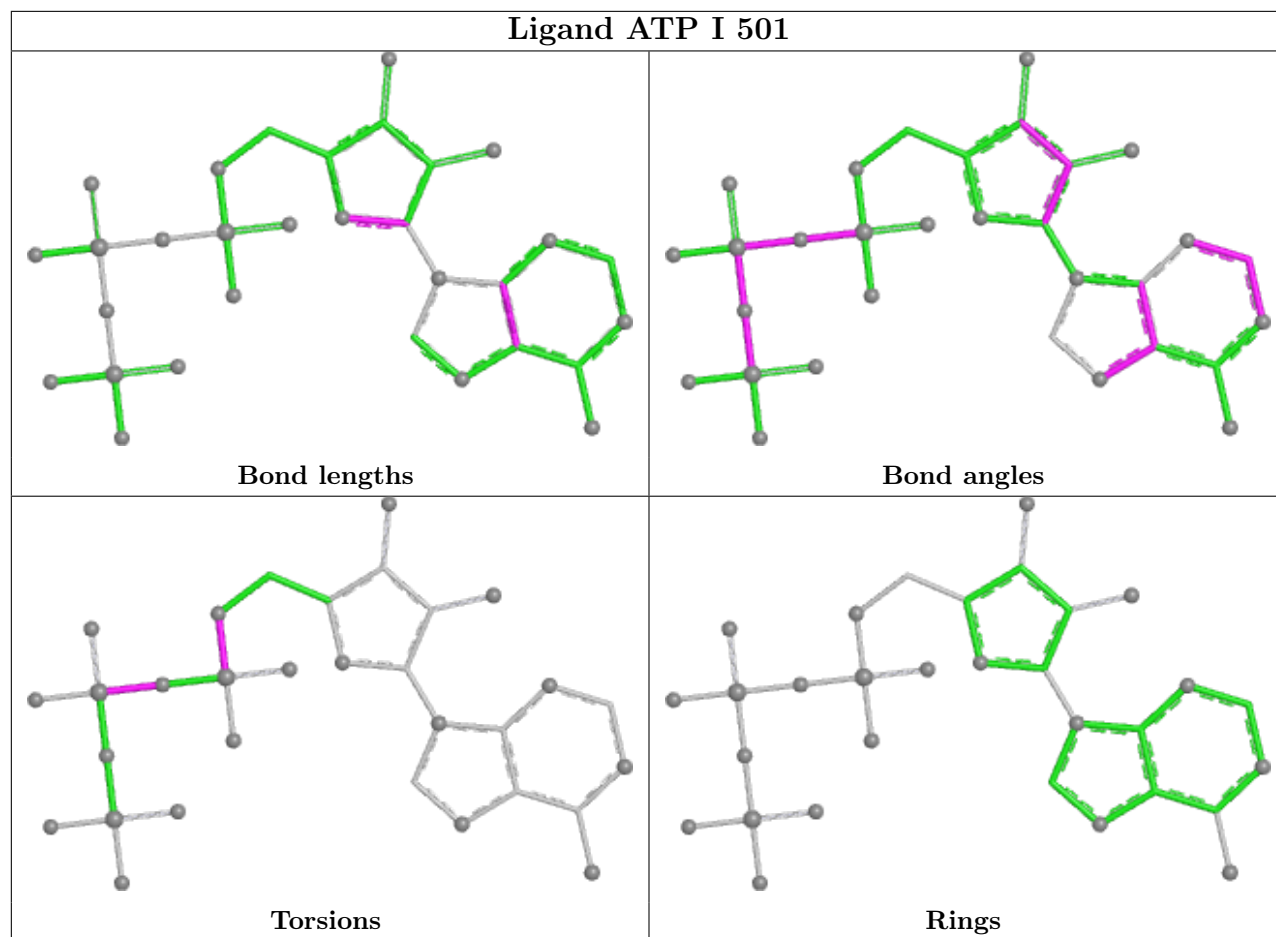

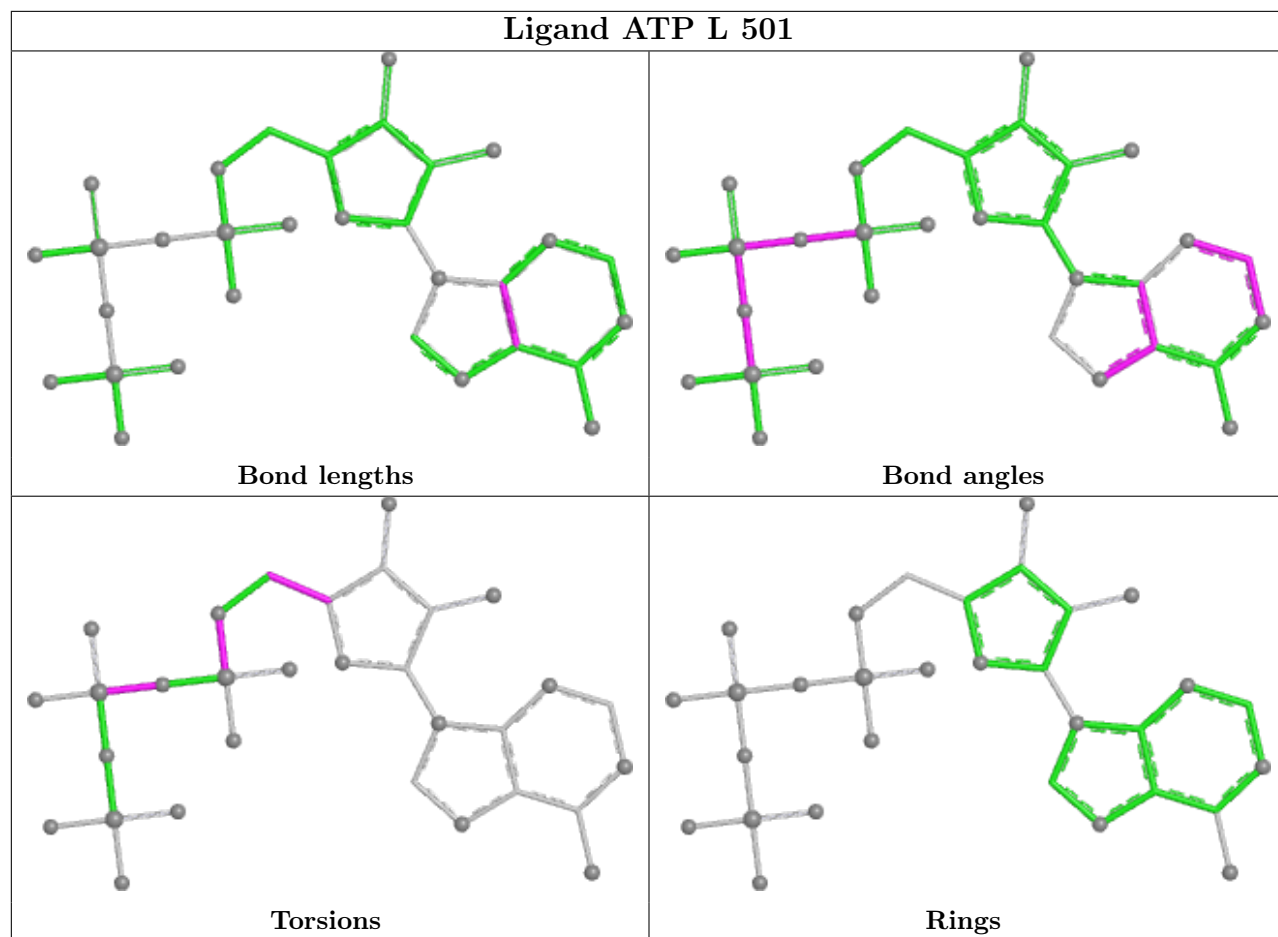

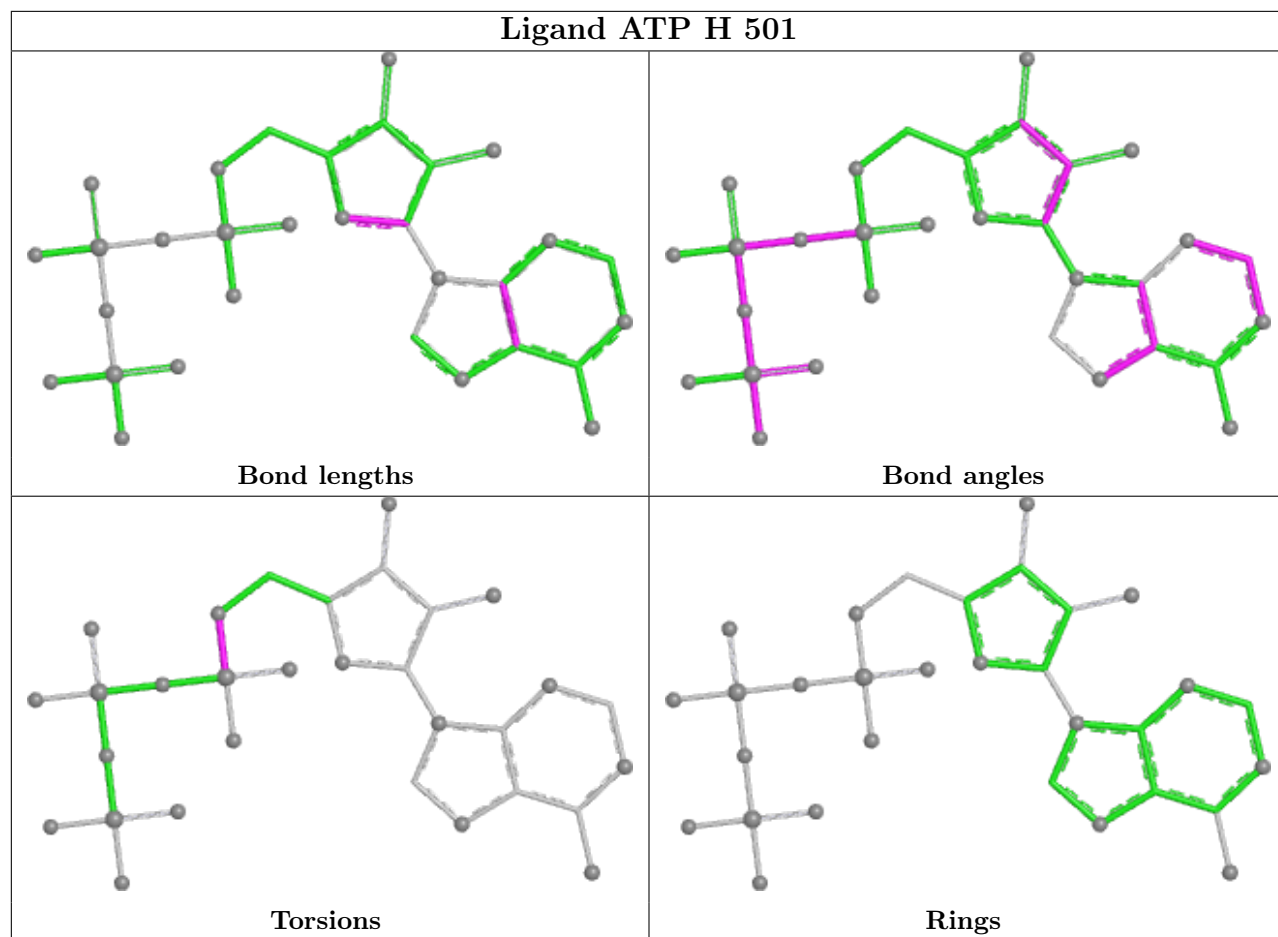

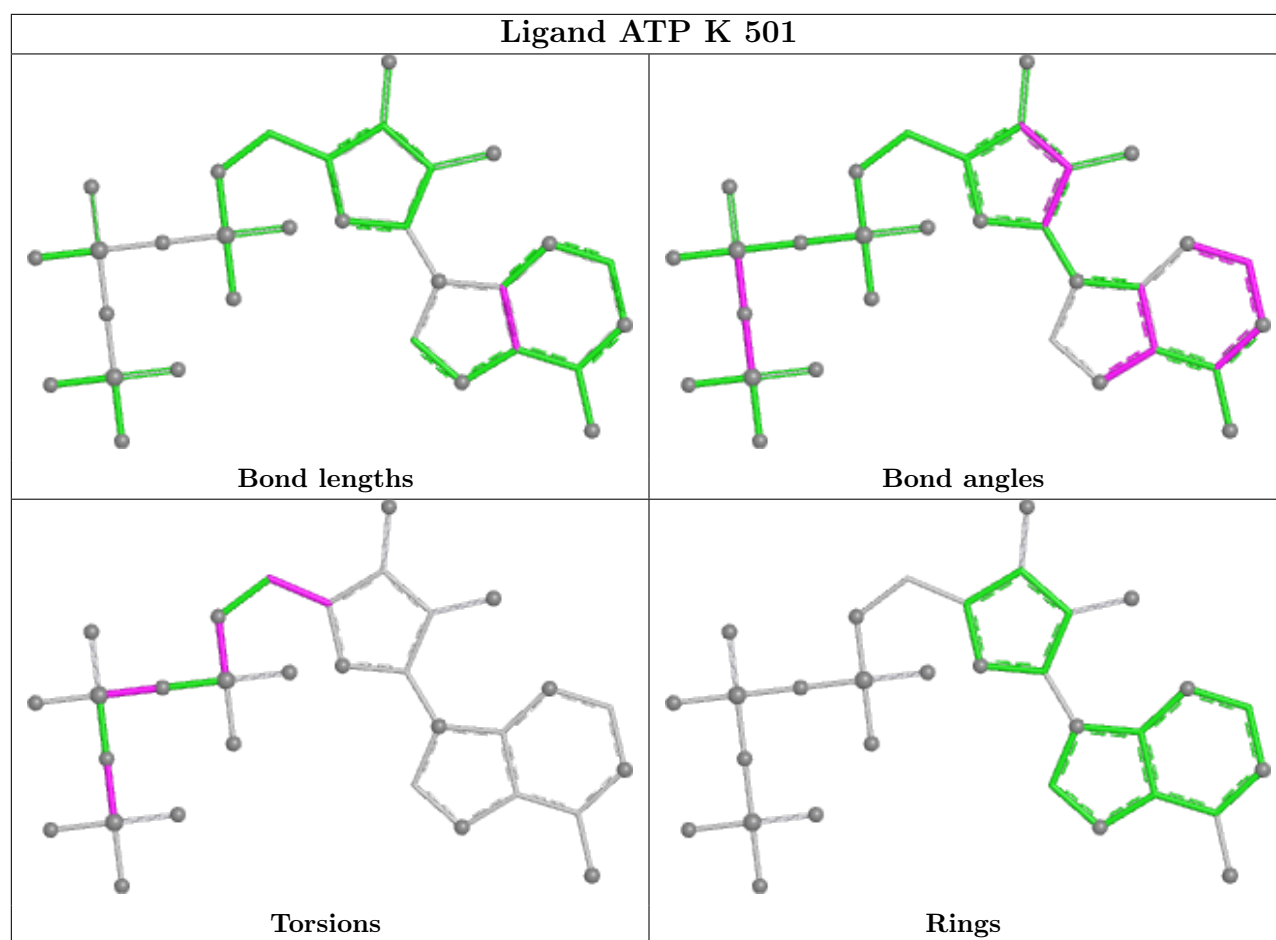

5.7 Other polymers [i](#)

There are no such residues in this entry.

5.8 Polymer linkage issues [i](#)

There are no chain breaks in this entry.

6 Map visualisation [i](#)

This section contains visualisations of the EMDB entry EMD-3534. These allow visual inspection of the internal detail of the map and identification of artifacts.

No raw map or half-maps were deposited for this entry and therefore no images, graphs, etc. pertaining to the raw map can be shown.

6.1 Orthogonal projections [i](#)

6.1.1 Primary map

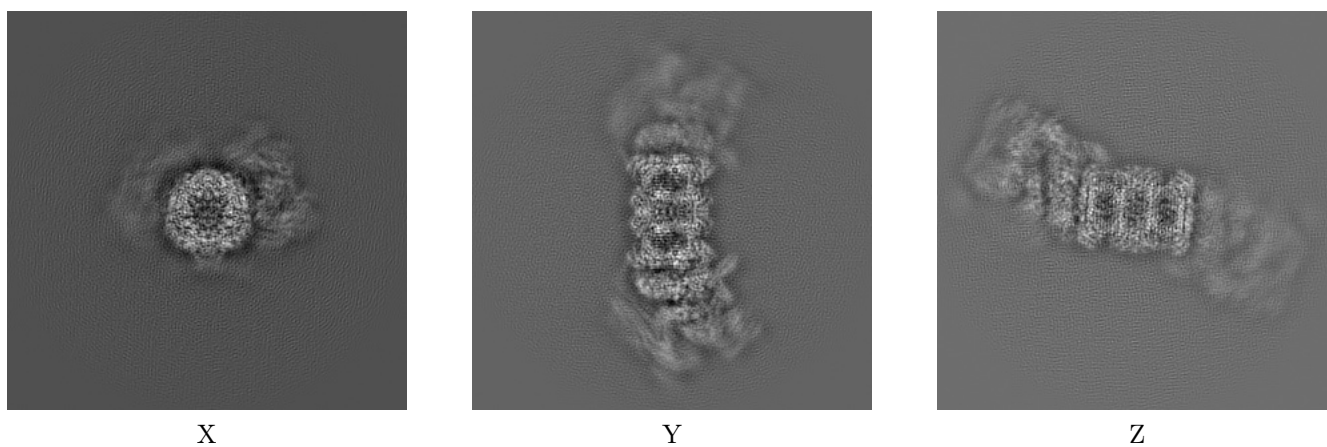

The images above show the map projected in three orthogonal directions.

6.2 Central slices [i](#)

6.2.1 Primary map

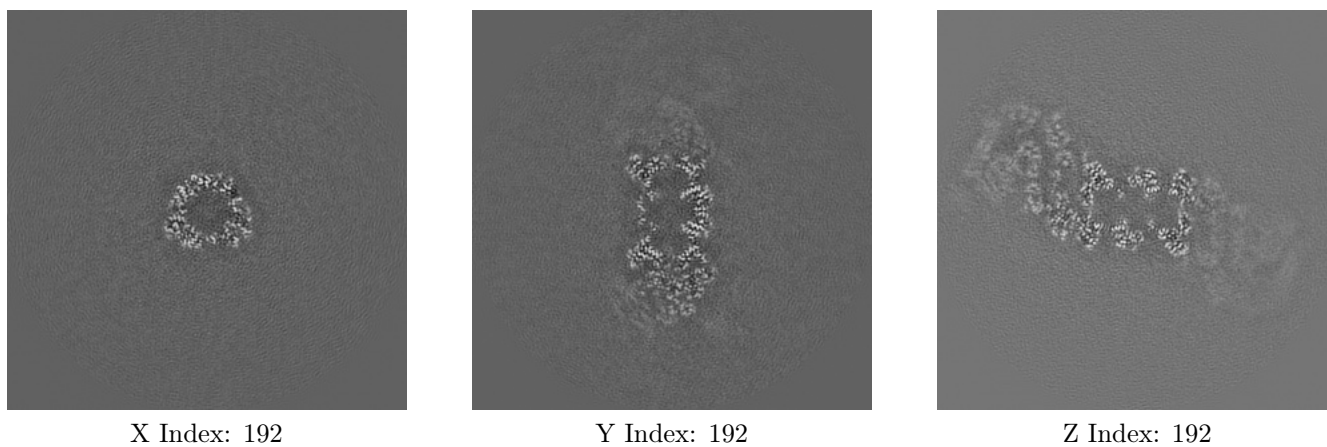

The images above show central slices of the map in three orthogonal directions.

6.3 Largest variance slices [i](#)

6.3.1 Primary map

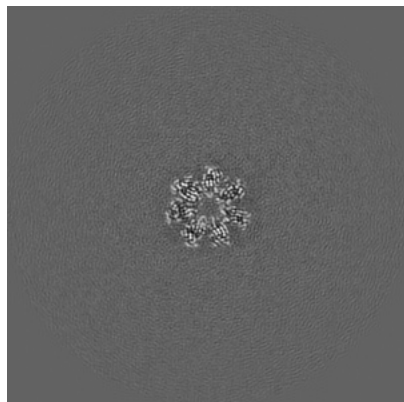

X Index: 177

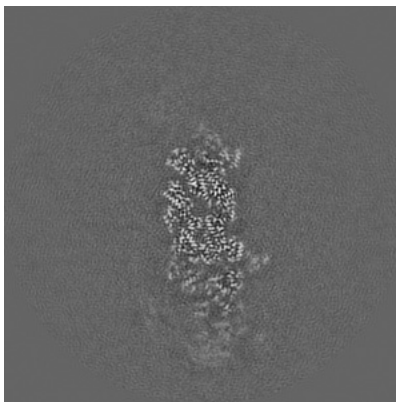

Y Index: 212

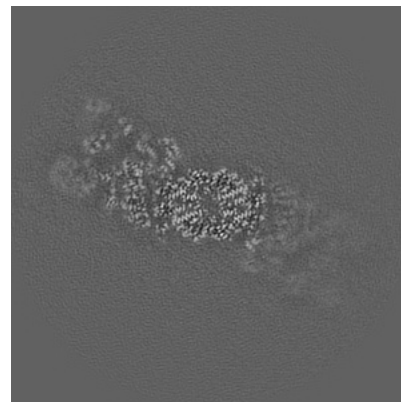

Z Index: 208

The images above show the largest variance slices of the map in three orthogonal directions.

6.4 Orthogonal surface views [i](#)

6.4.1 Primary map



X

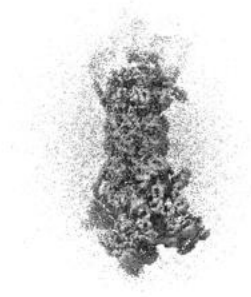

Y

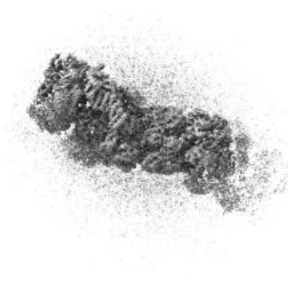

Z

The images above show the 3D surface view of the map at the recommended contour level 0.02. These images, in conjunction with the slice images, may facilitate assessment of whether an appropriate contour level has been provided.

6.5 Mask visualisation

This section was not generated. No masks/segmentation were deposited.

7 Map analysis [i](#)

This section contains the results of statistical analysis of the map.

7.1 Map-value distribution [i](#)

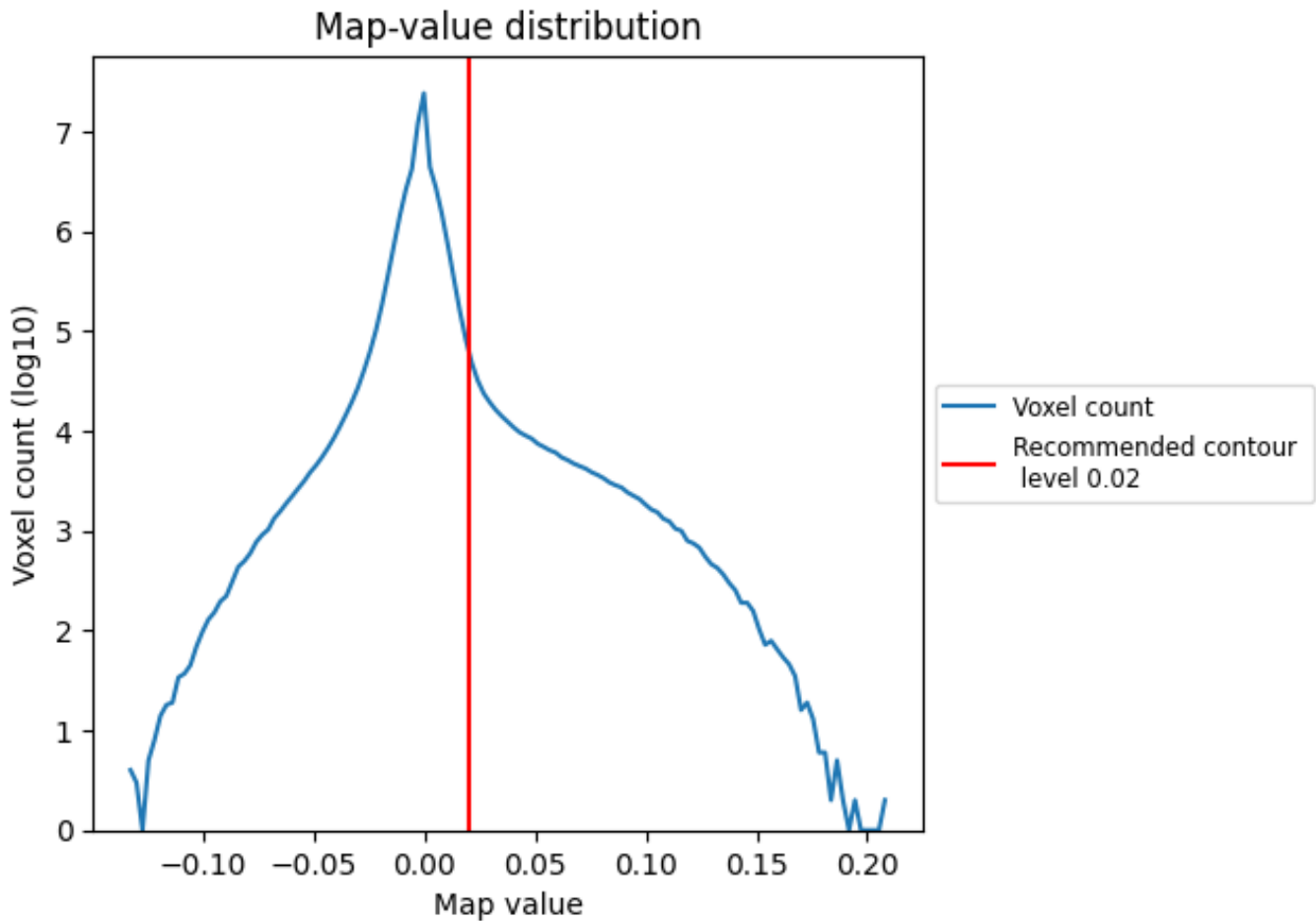

The map-value distribution is plotted in 128 intervals along the x-axis. The y-axis is logarithmic. A spike in this graph at zero usually indicates that the volume has been masked.

7.2 Volume estimate [\(i\)](#)

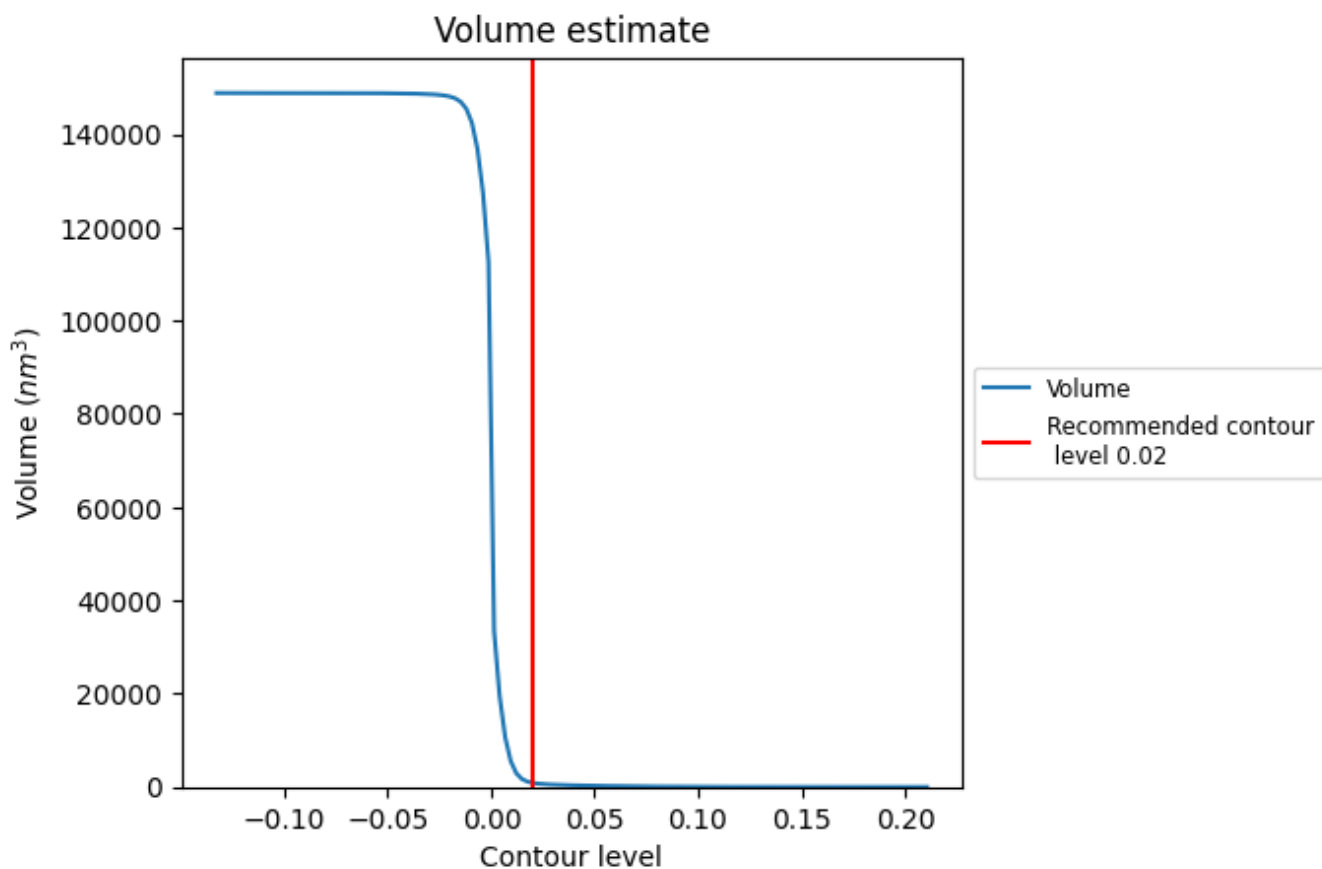

The volume at the recommended contour level is 881 nm^3 ; this corresponds to an approximate mass of 796 kDa.

The volume estimate graph shows how the enclosed volume varies with the contour level. The recommended contour level is shown as a vertical line and the intersection between the line and the curve gives the volume of the enclosed surface at the given level.

7.3 Rotationally averaged power spectrum [\(i\)](#)

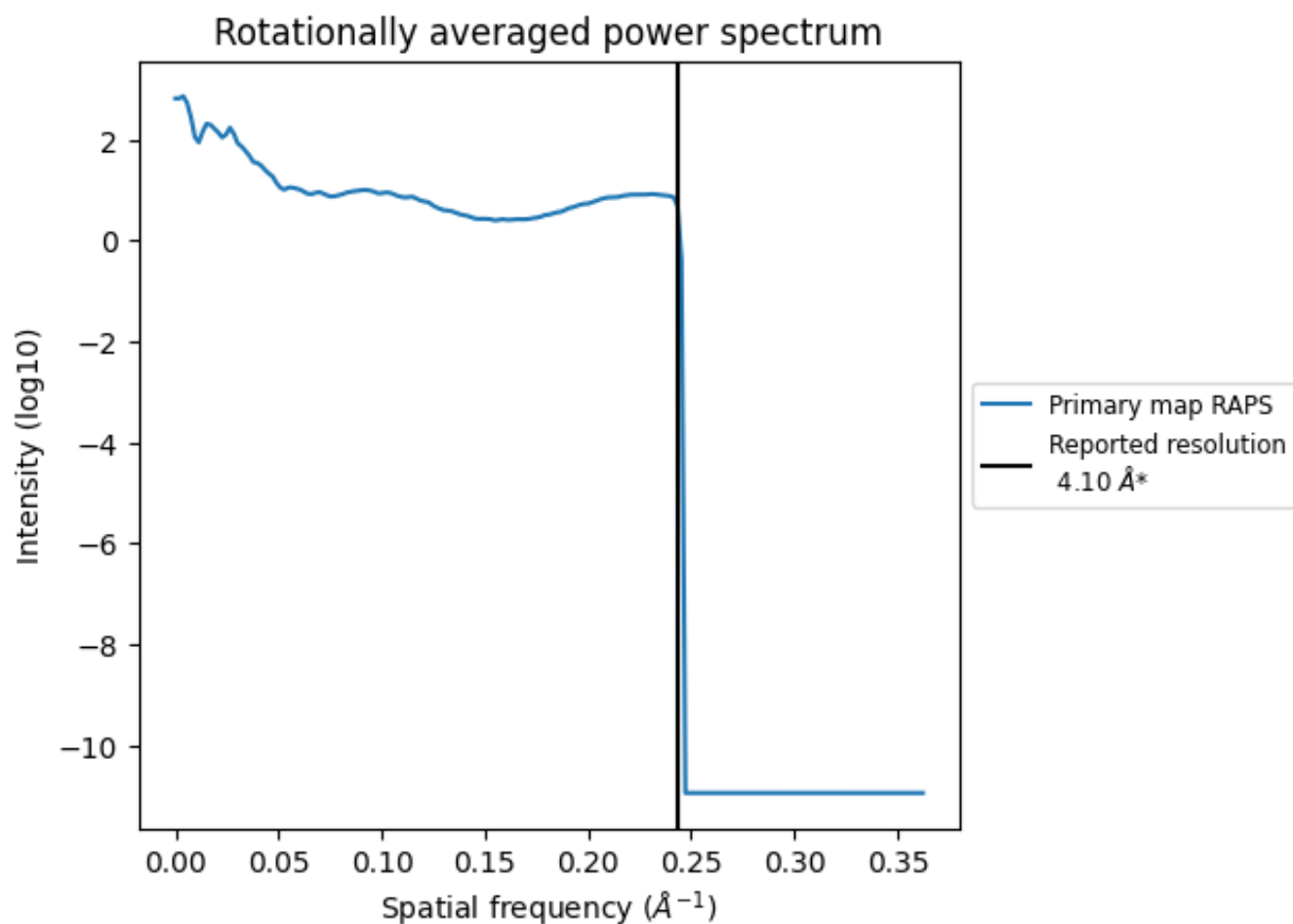

*Reported resolution corresponds to spatial frequency of 0.244 Å⁻¹

8 Fourier-Shell correlation

This section was not generated. No FSC curve or half-maps provided.

9 Map-model fit [i](#)

This section contains information regarding the fit between EMDB map EMD-3534 and PDB model 5MP9. Per-residue inclusion information can be found in section 3 on page 10.

9.1 Map-model overlay [i](#)

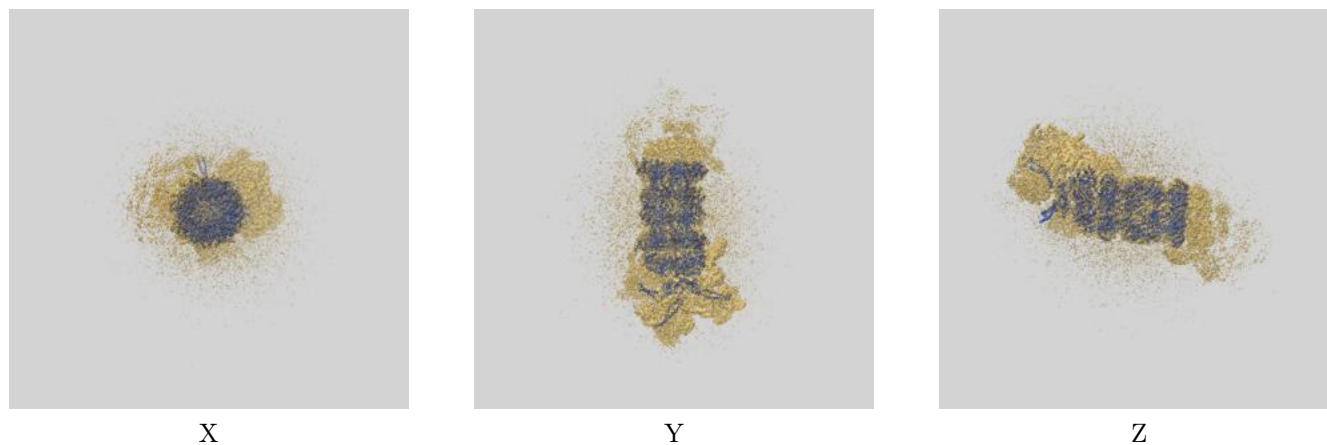

The images above show the 3D surface view of the map at the recommended contour level 0.02 at 50% transparency in yellow overlaid with a ribbon representation of the model coloured in blue. These images allow for the visual assessment of the quality of fit between the atomic model and the map.

9.2 Q-score mapped to coordinate model [i](#)

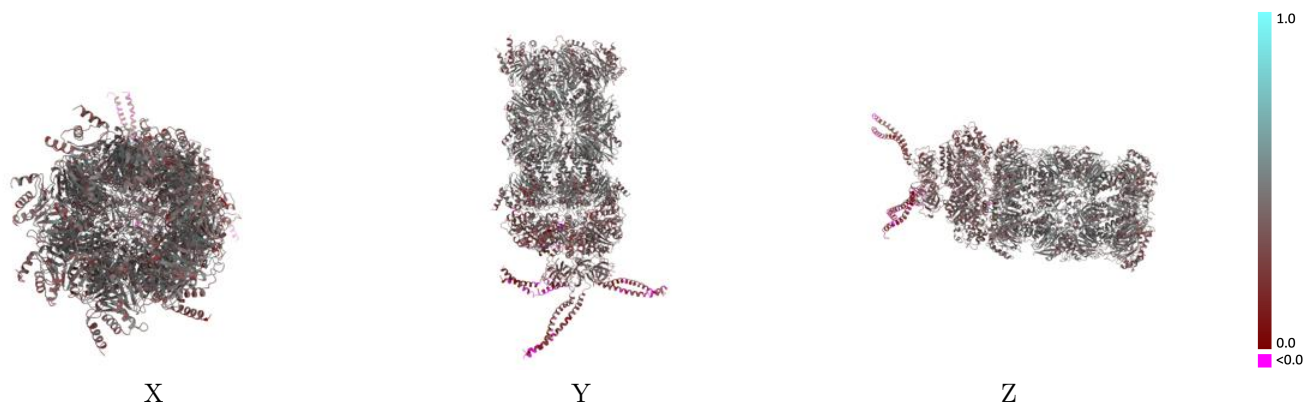

The images above show the model with each residue coloured according to its Q-score. This shows their resolvability in the map with higher Q-score values reflecting better resolvability. Please note: Q-score is calculating the resolvability of atoms, and thus high values are only expected at resolutions at which atoms can be resolved. Low Q-score values may therefore be expected for many entries.

9.3 Atom inclusion mapped to coordinate model [i](#)

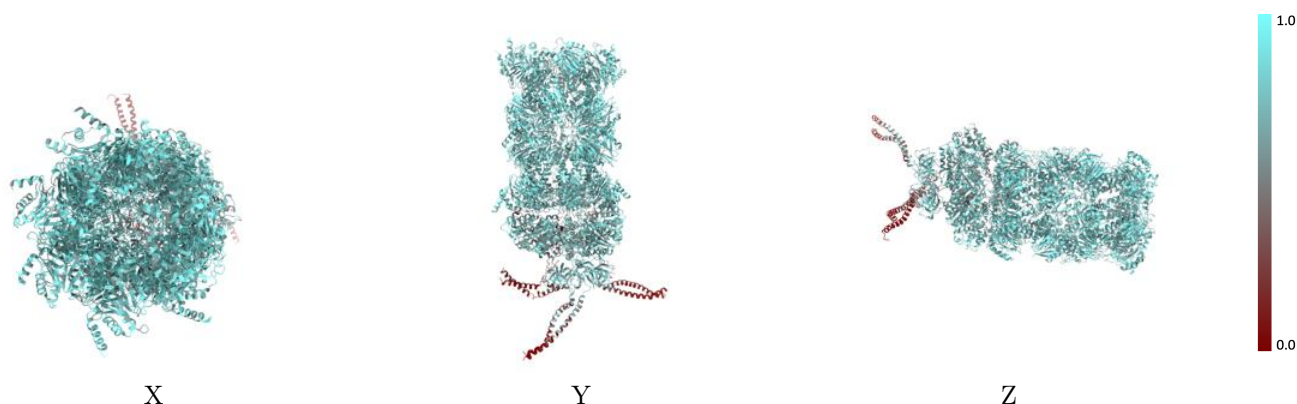

The images above show the model with each residue coloured according to its atom inclusion. This shows to what extent they are inside the map at the recommended contour level (0.02).



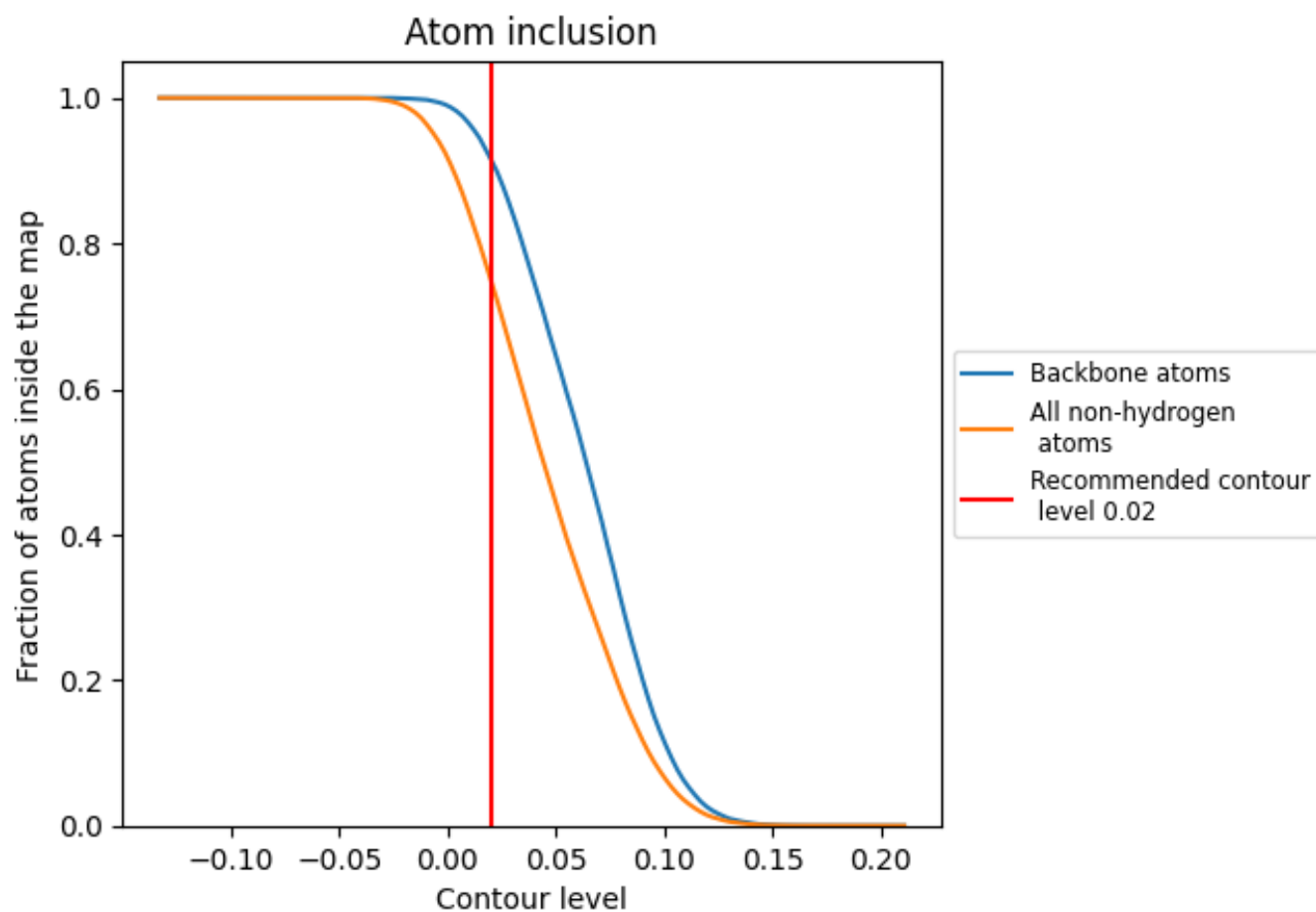



































































9.4 Atom inclusion [i](#)



At the recommended contour level, 92% of all backbone atoms, 75% of all non-hydrogen atoms, are inside the map.

9.5 Map-model fit summary

The table lists the average atom inclusion at the recommended contour level (0.02) and Q-score for the entire model and for each chain.

Chain	Atom inclusion	Q-score
All	 0.7501	 0.3940
1	 0.8160	 0.4380
2	 0.8022	 0.4330
3	 0.7956	 0.4410
4	 0.7971	 0.4300
5	 0.8254	 0.4320
6	 0.8235	 0.4400
7	 0.8260	 0.4380
A	 0.7883	 0.4190
B	 0.7745	 0.4130
C	 0.7762	 0.4060
D	 0.7874	 0.4100
E	 0.7572	 0.4040
F	 0.8039	 0.4290
G	 0.8045	 0.4240
H	 0.6539	 0.3470
I	 0.6090	 0.2990
J	 0.5722	 0.2810
K	 0.6305	 0.3180
L	 0.6279	 0.3290
M	 0.6385	 0.3460
a	 0.7894	 0.4070
b	 0.7740	 0.4040
c	 0.7794	 0.3940
d	 0.7792	 0.4080
e	 0.7556	 0.3920
f	 0.7976	 0.4080
g	 0.7986	 0.4090
h	 0.8228	 0.4400
i	 0.8093	 0.4360
j	 0.8001	 0.4370
k	 0.8037	 0.4340
l	 0.8229	 0.4360
m	 0.8287	 0.4380
n	 0.8251	 0.4370

