



# Full wwPDB X-ray Structure Validation Report ⓘ

Aug 30, 2023 – 11:40 AM EDT

PDB ID : 3NGB  
Title : Crystal structure of broadly and potently neutralizing antibody VRC01 in complex with HIV-1 gp120  
Authors : Zhou, T.; Kwong, P.D.  
Deposited on : 2010-06-11  
Resolution : 2.68 Å (reported)

This is a Full wwPDB X-ray Structure Validation Report for a publicly released PDB entry.

We welcome your comments at [validation@mail.wwpdb.org](mailto:validation@mail.wwpdb.org)

A user guide is available at

<https://www.wwpdb.org/validation/2017/XrayValidationReportHelp>

with specific help available everywhere you see the ⓘ symbol.

The types of validation reports are described at

<http://www.wwpdb.org/validation/2017/FAQs#types>.

---

The following versions of software and data (see [references ⓘ](#)) were used in the production of this report:

MolProbity : 4.02b-467  
Mogul : 1.8.5 (274361), CSD as541be (2020)  
Xtriage (Phenix) : 1.13  
EDS : 2.35  
Percentile statistics : 20191225.v01 (using entries in the PDB archive December 25th 2019)  
Refmac : 5.8.0158  
CCP4 : 7.0.044 (Gargrove)  
Ideal geometry (proteins) : Engh & Huber (2001)  
Ideal geometry (DNA, RNA) : Parkinson et al. (1996)  
Validation Pipeline (wwPDB-VP) : 2.35

# 1 Overall quality at a glance

The following experimental techniques were used to determine the structure:

*X-RAY DIFFRACTION*

The reported resolution of this entry is 2.68 Å.

Percentile scores (ranging between 0-100) for global validation metrics of the entry are shown in the following graphic. The table shows the number of entries on which the scores are based.

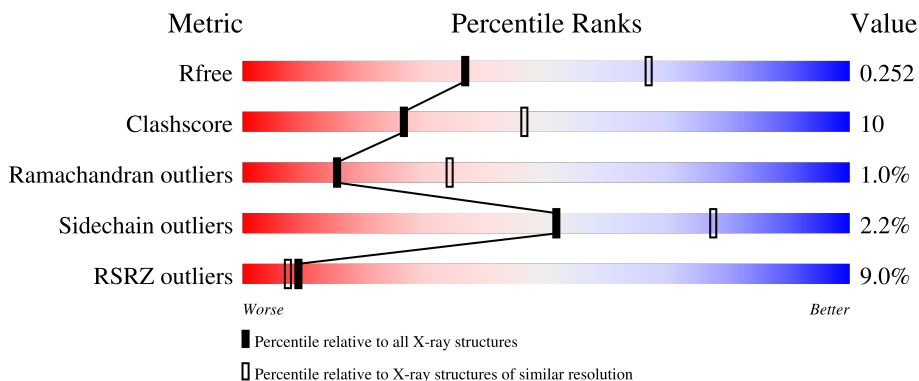

Metric	Whole archive (#Entries)	Similar resolution (#Entries, resolution range(Å))
$R_{free}$	130704	3863 (2.70-2.66)
Clashscore	141614	4210 (2.70-2.66)
Ramachandran outliers	138981	4141 (2.70-2.66)
Sidechain outliers	138945	4141 (2.70-2.66)
RSRZ outliers	127900	3780 (2.70-2.66)

The table below summarises the geometric issues observed across the polymeric chains and their fit to the electron density. The red, orange, yellow and green segments of the lower bar indicate the fraction of residues that contain outliers for  $\geq 3$ , 2, 1 and 0 types of geometric quality criteria respectively. A grey segment represents the fraction of residues that are not modelled. The numeric value for each fraction is indicated below the corresponding segment, with a dot representing fractions  $\leq 5\%$ . The upper red bar (where present) indicates the fraction of residues that have poor fit to the electron density. The numeric value is given above the bar.

Mol	Chain	Length	Quality of chain
1	A	353	 2% 74% 23% ..
1	D	353	 3% 75% 22% ..
1	G	353	 4% 75% 22% ..
1	I	353	 8% 77% 21% ..
2	B	224	 6% 74% 25%

*Continued on next page...*

Continued from previous page...

Mol	Chain	Length	Quality of chain
2	E	224	
2	H	224	
2	J	224	
3	C	210	
3	F	210	
3	K	210	
3	L	210	
4	M	5	
4	N	5	
4	P	5	
5	O	2	

The following table lists non-polymeric compounds, carbohydrate monomers and non-standard residues in protein, DNA, RNA chains that are outliers for geometric or electron-density-fit criteria:

Mol	Type	Chain	Res	Chirality	Geometry	Clashes	Electron density
4	MAN	M	5	-	-	-	X
6	NAG	A	509	-	-	-	X
6	NAG	D	501	-	-	-	X
6	NAG	D	503	-	-	-	X
7	BGC	A	517	-	-	-	X
8	TRS	K	301	-	-	-	X

## 2 Entry composition [i](#)

There are 9 unique types of molecules in this entry. The entry contains 25808 atoms, of which 0 are hydrogens and 0 are deuteriums.

In the tables below, the ZeroOcc column contains the number of atoms modelled with zero occupancy, the AltConf column contains the number of residues with at least one atom in alternate conformation and the Trace column contains the number of residues modelled with at most 2 atoms.

- Molecule 1 is a protein called Envelope glycoprotein gp160.

Mol	Chain	Residues	Atoms					ZeroOcc	AltConf	Trace
			Total	C	N	O	S			
1	G	347	2713	1700	472	518	23	0	0	0
1	A	349	2723	1705	474	521	23	0	0	0
1	D	350	2727	1707	475	522	23	0	0	0
1	I	349	2721	1704	474	520	23	0	0	0

There are 32 discrepancies between the modelled and reference sequences:

Chain	Residue	Modelled	Actual	Comment	Reference
G	124	GLY	-	linker	UNP Q0ED31
G	198	GLY	-	linker	UNP Q0ED31
G	318	GLY	-	linker	UNP Q0ED31
G	319	GLY	-	linker	UNP Q0ED31
G	320	SER	-	linker	UNP Q0ED31
G	321	GLY	-	linker	UNP Q0ED31
G	322	SER	-	linker	UNP Q0ED31
G	323	GLY	-	linker	UNP Q0ED31
A	124	GLY	-	linker	UNP Q0ED31
A	198	GLY	-	linker	UNP Q0ED31
A	318	GLY	-	linker	UNP Q0ED31
A	319	GLY	-	linker	UNP Q0ED31
A	320	SER	-	linker	UNP Q0ED31
A	321	GLY	-	linker	UNP Q0ED31
A	322	SER	-	linker	UNP Q0ED31
A	323	GLY	-	linker	UNP Q0ED31
D	124	GLY	-	linker	UNP Q0ED31
D	198	GLY	-	linker	UNP Q0ED31
D	318	GLY	-	linker	UNP Q0ED31
D	319	GLY	-	linker	UNP Q0ED31
D	320	SER	-	linker	UNP Q0ED31

*Continued on next page...*

Continued from previous page...

Chain	Residue	Modelled	Actual	Comment	Reference
D	321	GLY	-	linker	UNP Q0ED31
D	322	SER	-	linker	UNP Q0ED31
D	323	GLY	-	linker	UNP Q0ED31
I	124	GLY	-	linker	UNP Q0ED31
I	198	GLY	-	linker	UNP Q0ED31
I	302	GLY	-	linker	UNP Q0ED31
I	319	GLY	-	linker	UNP Q0ED31
I	320	SER	-	linker	UNP Q0ED31
I	321	GLY	-	linker	UNP Q0ED31
I	322	SER	-	linker	UNP Q0ED31
I	323	GLY	-	linker	UNP Q0ED31

- Molecule 2 is a protein called Antigen binding fragment of heavy chain: Antibody VRC01.

Mol	Chain	Residues	Atoms					ZeroOcc	AltConf	Trace
			Total	C	N	O	S			
2	H	224	Total 1710	C 1077	N 297	O 325	S 11	0	0	0
2	B	224	Total 1710	C 1077	N 297	O 325	S 11	0	0	0
2	E	224	Total 1710	C 1077	N 297	O 325	S 11	0	0	0
2	J	224	Total 1710	C 1077	N 297	O 325	S 11	0	0	0

- Molecule 3 is a protein called Antigen binding fragment of light chain: Antibody VRC01.

Mol	Chain	Residues	Atoms					ZeroOcc	AltConf	Trace
			Total	C	N	O	S			
3	L	208	Total 1615	C 1011	N 277	O 322	S 5	0	0	0
3	C	210	Total 1632	C 1022	N 279	O 326	S 5	0	0	0
3	F	208	Total 1615	C 1011	N 277	O 322	S 5	0	0	0
3	K	210	Total 1632	C 1022	N 279	O 326	S 5	0	0	0

- Molecule 4 is an oligosaccharide called alpha-D-mannopyranose-(1-3)-[alpha-D-mannopyranose-(1-6)]beta-D-mannopyranose-(1-4)-2-acetamido-2-deoxy-beta-D-glucopyranose-(1-4)-2-acetamido-2-deoxy-beta-D-glucopyranose.

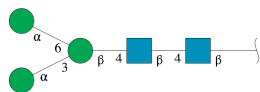

Mol	Chain	Residues	Atoms				ZeroOcc	AltConf	Trace
			Total	C	N	O			
4	M	5	61	34	2	25	0	0	0
4	N	5	61	34	2	25	0	0	0
4	P	5	61	34	2	25	0	0	0

- Molecule 5 is an oligosaccharide called 2-acetamido-2-deoxy-beta-D-glucopyranose-(1-4)-2-acetamido-2-deoxy-beta-D-glucopyranose.



Mol	Chain	Residues	Atoms				ZeroOcc	AltConf	Trace
			Total	C	N	O			
5	O	2	28	16	2	10	0	0	0

- Molecule 6 is 2-acetamido-2-deoxy-beta-D-glucopyranose (three-letter code: NAG) (formula: C<sub>8</sub>H<sub>15</sub>NO<sub>6</sub>).

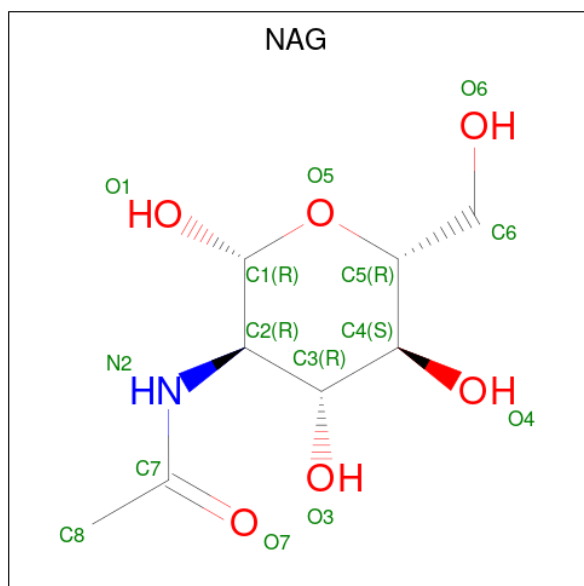

Mol	Chain	Residues	Atoms				ZeroOcc	AltConf
6	G	1	Total	C	N	O	0	0
			14	8	1	5		
6	G	1	Total	C	N	O	0	0
			14	8	1	5		
6	G	1	Total	C	N	O	0	0
			14	8	1	5		
6	G	1	Total	C	N	O	0	0
			14	8	1	5		
6	G	1	Total	C	N	O	0	0
			14	8	1	5		
6	G	1	Total	C	N	O	0	0
			14	8	1	5		
6	G	1	Total	C	N	O	0	0
			14	8	1	5		
6	G	1	Total	C	N	O	0	0
			14	8	1	5		
6	G	1	Total	C	N	O	0	0
			14	8	1	5		
6	A	1	Total	C	N	O	0	0
			14	8	1	5		
6	A	1	Total	C	N	O	0	0
			14	8	1	5		
6	A	1	Total	C	N	O	0	0
			14	8	1	5		
6	A	1	Total	C	N	O	0	0
			14	8	1	5		
6	A	1	Total	C	N	O	0	0
			14	8	1	5		
6	A	1	Total	C	N	O	0	0
			14	8	1	5		
6	A	1	Total	C	N	O	0	0
			14	8	1	5		
6	A	1	Total	C	N	O	0	0
			14	8	1	5		

*Continued on next page...*

*Continued from previous page...*

Mol	Chain	Residues	Atoms				ZeroOcc	AltConf
6	A	1	Total	C	N	O	0	0
			14	8	1	5		
6	D	1	Total	C	N	O	0	0
			14	8	1	5		
6	D	1	Total	C	N	O	0	0
			14	8	1	5		
6	D	1	Total	C	N	O	0	0
			14	8	1	5		
6	D	1	Total	C	N	O	0	0
			14	8	1	5		
6	D	1	Total	C	N	O	0	0
			14	8	1	5		
6	D	1	Total	C	N	O	0	0
			14	8	1	5		
6	D	1	Total	C	N	O	0	0
			14	8	1	5		
6	D	1	Total	C	N	O	0	0
			14	8	1	5		
6	D	1	Total	C	N	O	0	0
			14	8	1	5		
6	D	1	Total	C	N	O	0	0
			14	8	1	5		
6	D	1	Total	C	N	O	0	0
			14	8	1	5		
6	I	1	Total	C	N	O	0	0
			14	8	1	5		
6	I	1	Total	C	N	O	0	0
			14	8	1	5		
6	I	1	Total	C	N	O	0	0
			14	8	1	5		
6	I	1	Total	C	N	O	0	0
			14	8	1	5		
6	I	1	Total	C	N	O	0	0
			14	8	1	5		
6	I	1	Total	C	N	O	0	0
			14	8	1	5		
6	I	1	Total	C	N	O	0	0
			14	8	1	5		

*Continued on next page...*



Continued from previous page...

Mol	Chain	Residues	Atoms				ZeroOcc	AltConf
6	I	1	Total	C	N	O	0	0
			14	8	1	5		
6	I	1	Total	C	N	O	0	0
			14	8	1	5		
6	I	1	Total	C	N	O	0	0
			14	8	1	5		

- Molecule 7 is beta-D-glucopyranose (three-letter code: BGC) (formula: C<sub>6</sub>H<sub>12</sub>O<sub>6</sub>).

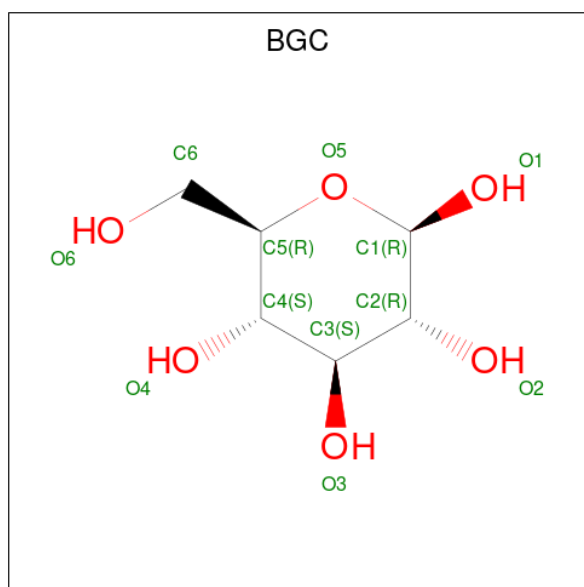

Mol	Chain	Residues	Atoms			ZeroOcc	AltConf
7	G	1	Total	C	O	0	0
			12	6	6		
7	A	1	Total	C	O	0	0
			12	6	6		
7	A	1	Total	C	O	0	0
			12	6	6		
7	A	1	Total	C	O	0	0
			12	6	6		
7	A	1	Total	C	O	0	0
			12	6	6		
7	B	1	Total	C	O	0	0
			12	6	6		
7	B	1	Total	C	O	0	0
			12	6	6		
7	C	1	Total	C	O	0	0
			12	6	6		

Continued on next page...

Continued from previous page...

Mol	Chain	Residues	Atoms			ZeroOcc	AltConf
7	D	1	Total	C	O	0	0
			12	6	6		
7	E	1	Total	C	O	0	0
			12	6	6		
7	I	1	Total	C	O	0	0
			12	6	6		
7	I	1	Total	C	O	0	0
			12	6	6		
7	J	1	Total	C	O	0	0
			12	6	6		

- Molecule 8 is 2-AMINO-2-HYDROXYMETHYL-PROPANE-1,3-DIOL (three-letter code: TRS) (formula: C<sub>4</sub>H<sub>12</sub>NO<sub>3</sub>).

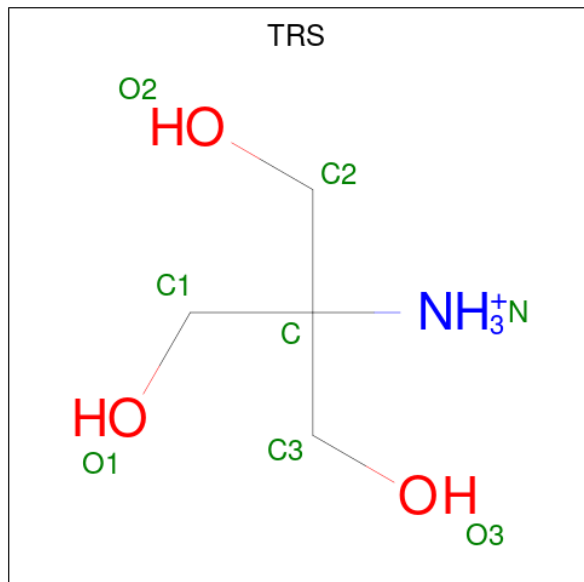

Mol	Chain	Residues	Atoms				ZeroOcc	AltConf
8	A	1	Total	C	N	O	0	0
			8	4	1	3		
8	A	1	Total	C	N	O	0	0
			8	4	1	3		
8	D	1	Total	C	N	O	0	0
			8	4	1	3		
8	D	1	Total	C	N	O	0	0
			8	4	1	3		
8	I	1	Total	C	N	O	0	0
			8	4	1	3		
8	J	1	Total	C	N	O	0	0
			8	4	1	3		

Continued on next page...

*Continued from previous page...*

Mol	Chain	Residues	Atoms			ZeroOcc	AltConf	
8	K	1	Total	C	N	O	0	0
			8	4	1	3		

- Molecule 9 is water.

Mol	Chain	Residues	Atoms		ZeroOcc	AltConf
9	G	66	Total	O	0	0
			66	66		
9	H	53	Total	O	0	0
			53	53		
9	L	43	Total	O	0	0
			43	43		
9	A	89	Total	O	0	0
			89	89		
9	B	45	Total	O	0	0
			45	45		
9	C	33	Total	O	0	0
			33	33		
9	D	55	Total	O	0	0
			55	55		
9	E	32	Total	O	0	0
			32	32		
9	F	8	Total	O	0	0
			8	8		
9	I	44	Total	O	0	0
			44	44		
9	J	24	Total	O	0	0
			24	24		
9	K	31	Total	O	0	0
			31	31		

### 3 Residue-property plots [i](#)

These plots are drawn for all protein, RNA, DNA and oligosaccharide chains in the entry. The first graphic for a chain summarises the proportions of the various outlier classes displayed in the second graphic. The second graphic shows the sequence view annotated by issues in geometry and electron density. Residues are color-coded according to the number of geometric quality criteria for which they contain at least one outlier: green = 0, yellow = 1, orange = 2 and red = 3 or more. A red dot above a residue indicates a poor fit to the electron density ( $RSRZ > 2$ ). Stretches of 2 or more consecutive residues without any outlier are shown as a green connector. Residues present in the sample, but not in the model, are shown in grey.

- Molecule 1: Envelope glycoprotein gp160

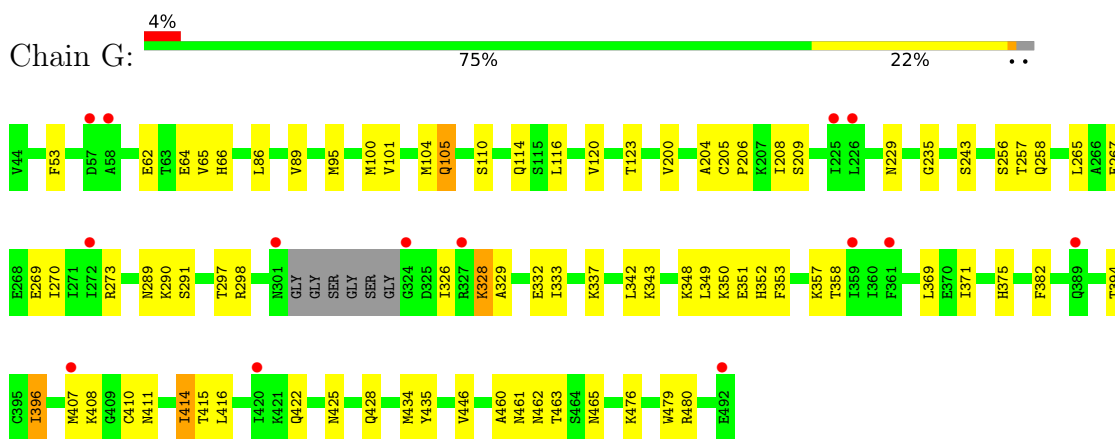

- Molecule 1: Envelope glycoprotein gp160

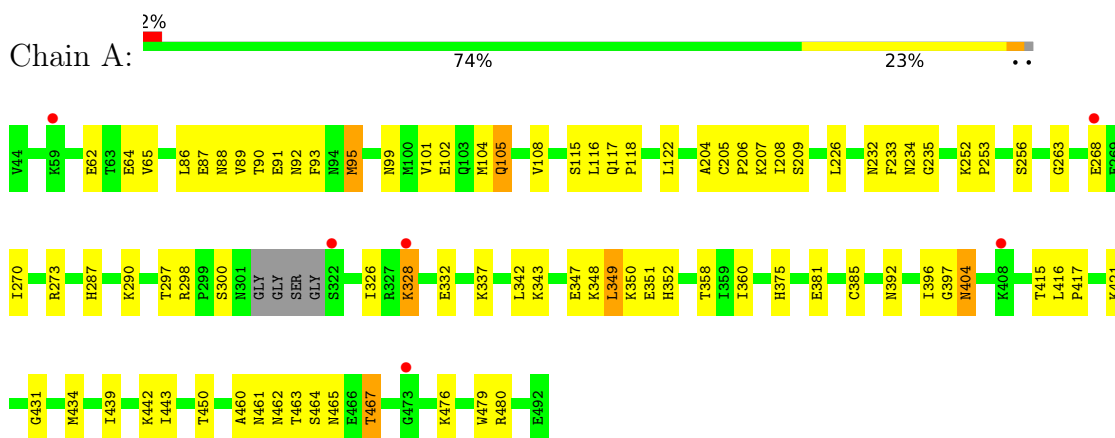

- Molecule 1: Envelope glycoprotein gp160

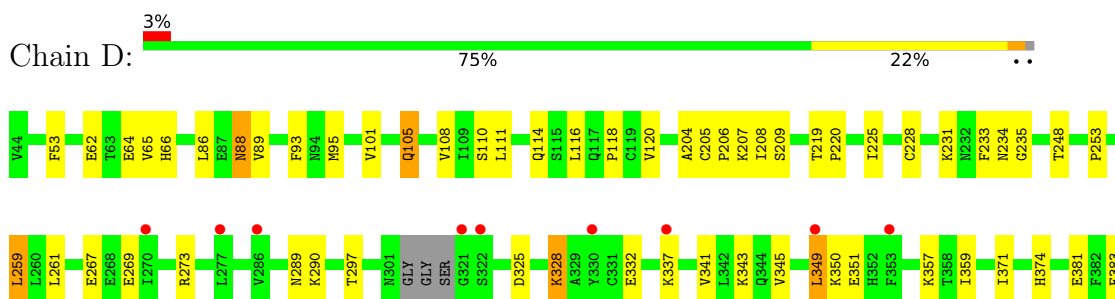

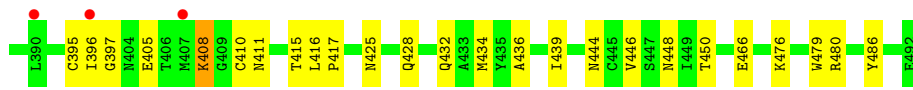

● Molecule 1: Envelope glycoprotein gp160

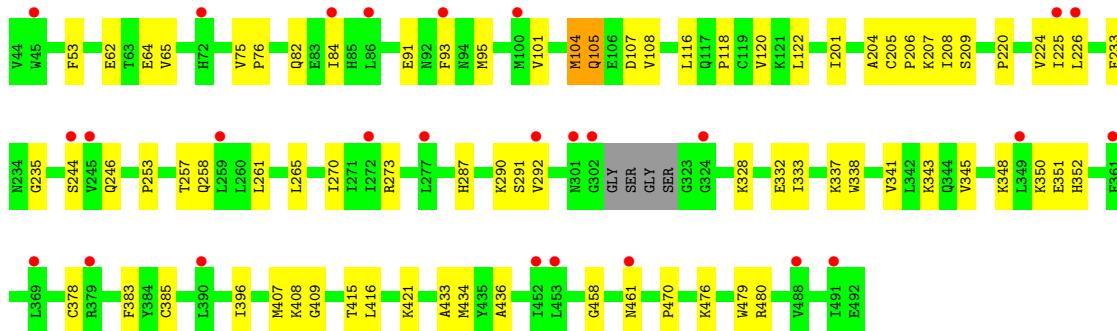
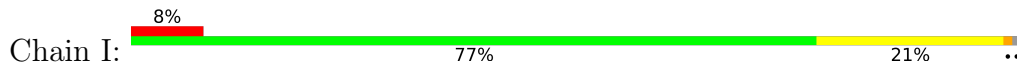

● Molecule 2: Antigen binding fragment of heavy chain: Antibody VRC01

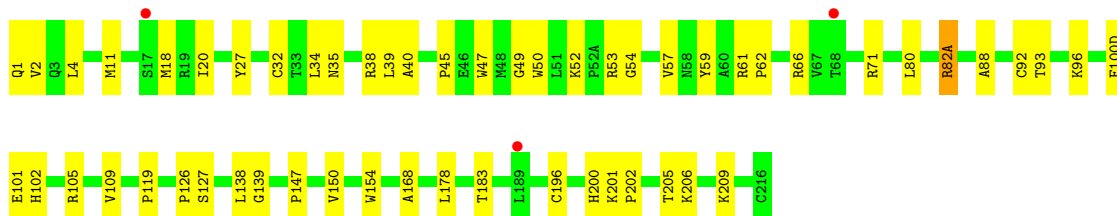
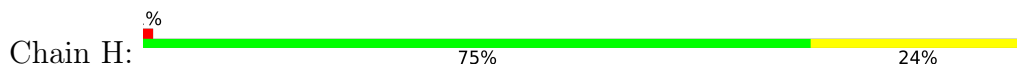

● Molecule 2: Antigen binding fragment of heavy chain: Antibody VRC01

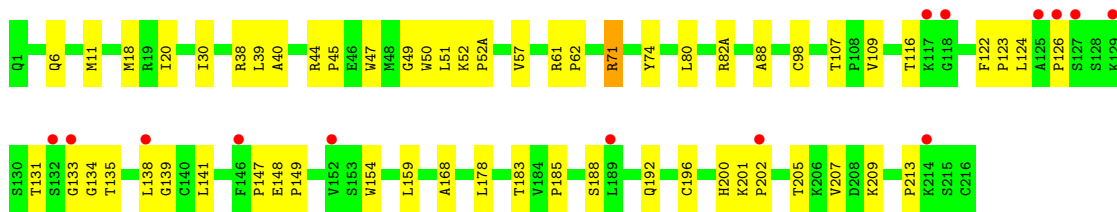
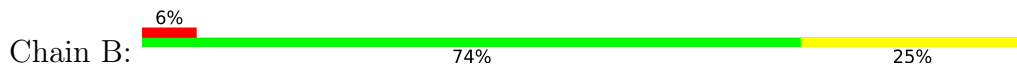

● Molecule 2: Antigen binding fragment of heavy chain: Antibody VRC01

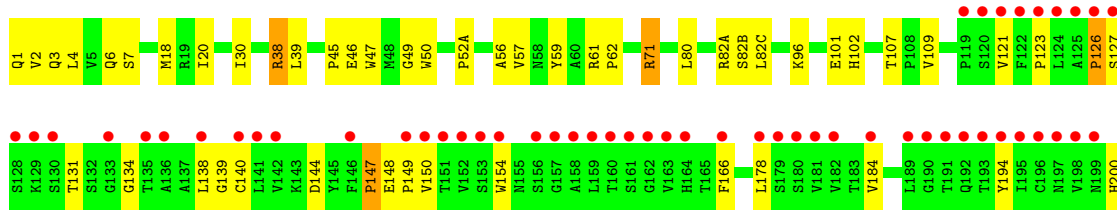
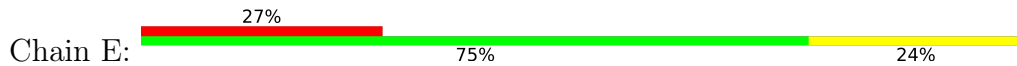

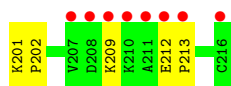

- Molecule 2: Antigen binding fragment of heavy chain: Antibody VRC01

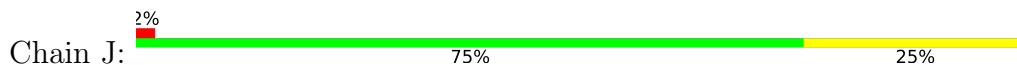

- Molecule 3: Antigen binding fragment of light chain: Antibody VRC01

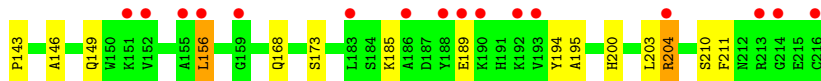
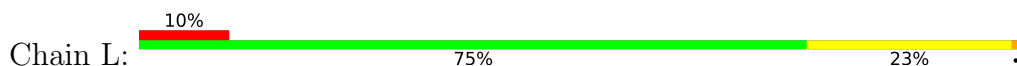

- Molecule 3: Antigen binding fragment of light chain: Antibody VRC01

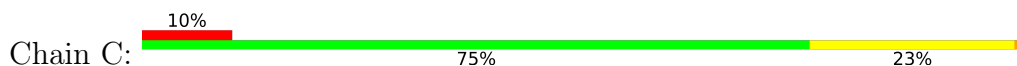

- Molecule 3: Antigen binding fragment of light chain: Antibody VRC01

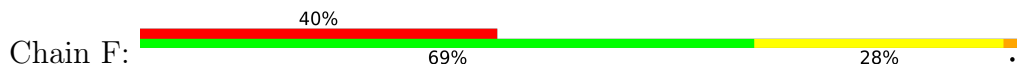

- Molecule 3: Antigen binding fragment of light chain: Antibody VRC01

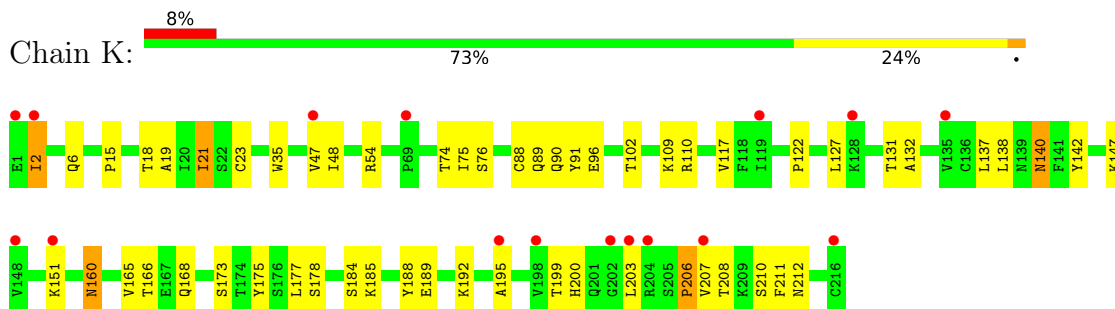

- Molecule 4: alpha-D-mannopyranose-(1-3)-[alpha-D-mannopyranose-(1-6)]beta-D-mannopyranose-(1-4)-2-acetamido-2-deoxy-beta-D-glucopyranose-(1-4)-2-acetamido-2-deoxy-beta-D-glucopyranose

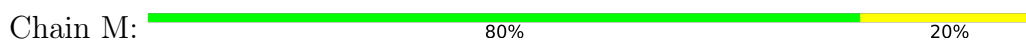

- Molecule 4: alpha-D-mannopyranose-(1-3)-[alpha-D-mannopyranose-(1-6)]beta-D-mannopyranose-(1-4)-2-acetamido-2-deoxy-beta-D-glucopyranose-(1-4)-2-acetamido-2-deoxy-beta-D-glucopyranose



- Molecule 4: alpha-D-mannopyranose-(1-3)-[alpha-D-mannopyranose-(1-6)]beta-D-mannopyranose-(1-4)-2-acetamido-2-deoxy-beta-D-glucopyranose-(1-4)-2-acetamido-2-deoxy-beta-D-glucopyranose

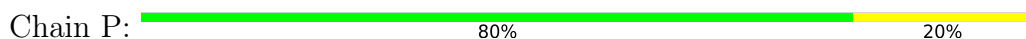

- Molecule 5: 2-acetamido-2-deoxy-beta-D-glucopyranose-(1-4)-2-acetamido-2-deoxy-beta-D-glucopyranose

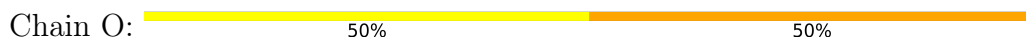

## 4 Data and refinement statistics

Property	Value	Source
Space group	P 1 21 1	Depositor
Cell constants a, b, c, $\alpha$ , $\beta$ , $\gamma$	108.63Å 98.28Å 205.26Å 90.00° 99.68° 90.00°	Depositor
Resolution (Å)	49.73 – 2.68 49.73 – 2.68	Depositor EDS
% Data completeness (in resolution range)	94.8 (49.73-2.68) 81.3 (49.73-2.68)	Depositor EDS
$R_{merge}$	(Not available)	Depositor
$R_{sym}$	0.08	Depositor
$\langle I/\sigma(I) \rangle$ <sup>1</sup>	1.20 (at 2.69Å)	Xtrriage
Refinement program	PHENIX (phenix.refine: 1.5_2)	Depositor
R, $R_{free}$	0.197 , 0.256 0.188 , 0.252	Depositor DCC
$R_{free}$ test set	4868 reflections (5.01%)	wwPDB-VP
Wilson B-factor (Å <sup>2</sup> )	82.6	Xtrriage
Anisotropy	0.100	Xtrriage
Bulk solvent $k_{sol}$ (e/Å <sup>3</sup> ), $B_{sol}$ (Å <sup>2</sup> )	0.29 , 68.2	EDS
L-test for twinning <sup>2</sup>	$\langle  L  \rangle = 0.49$ , $\langle L^2 \rangle = 0.32$	Xtrriage
Estimated twinning fraction	No twinning to report.	Xtrriage
$F_o, F_c$ correlation	0.95	EDS
Total number of atoms	25808	wwPDB-VP
Average B, all atoms (Å <sup>2</sup> )	116.0	wwPDB-VP

Xtrriage's analysis on translational NCS is as follows: *The largest off-origin peak in the Patterson function is 2.51% of the height of the origin peak. No significant pseudotranslation is detected.*

<sup>1</sup>Intensities estimated from amplitudes.

<sup>2</sup>Theoretical values of  $\langle |L| \rangle$ ,  $\langle L^2 \rangle$  for acentric reflections are 0.5, 0.333 respectively for untwinned datasets, and 0.375, 0.2 for perfectly twinned datasets.



## 5 Model quality

### 5.1 Standard geometry

Bond lengths and bond angles in the following residue types are not validated in this section: NAG, BGC, MAN, TRS, BMA

The Z score for a bond length (or angle) is the number of standard deviations the observed value is removed from the expected value. A bond length (or angle) with  $|Z| > 5$  is considered an outlier worth inspection. RMSZ is the root-mean-square of all Z scores of the bond lengths (or angles).

Mol	Chain	Bond lengths		Bond angles	
		RMSZ	# Z  >5	RMSZ	# Z  >5
1	A	0.21	0/2780	0.39	0/3773
1	D	0.21	0/2784	0.38	0/3778
1	G	0.21	0/2770	0.39	0/3760
1	I	0.21	0/2778	0.37	0/3770
2	B	0.21	0/1755	0.40	0/2387
2	E	0.21	0/1755	0.39	0/2387
2	H	0.22	0/1755	0.41	0/2387
2	J	0.21	0/1755	0.40	0/2387
3	C	0.21	0/1669	0.38	0/2265
3	F	0.20	0/1652	0.36	0/2242
3	K	0.21	0/1669	0.38	0/2265
3	L	0.21	0/1652	0.37	0/2242
All	All	0.21	0/24774	0.39	0/33643

There are no bond length outliers.

There are no bond angle outliers.

There are no chirality outliers.

There are no planarity outliers.

### 5.2 Too-close contacts

In the following table, the Non-H and H(model) columns list the number of non-hydrogen atoms and hydrogen atoms in the chain respectively. The H(added) column lists the number of hydrogen atoms added and optimized by MolProbity. The Clashes column lists the number of clashes within the asymmetric unit, whereas Symm-Clashes lists symmetry-related clashes.

Mol	Chain	Non-H	H(model)	H(added)	Clashes	Symm-Clashes
1	A	2723	0	2649	58	0

*Continued on next page...*

*Continued from previous page...*

Mol	Chain	Non-H	H(model)	H(added)	Clashes	Symm-Clashes
1	D	2727	0	2652	56	0
1	G	2713	0	2642	53	0
1	I	2721	0	2648	56	0
2	B	1710	0	1680	45	0
2	E	1710	0	1680	34	0
2	H	1710	0	1680	34	0
2	J	1710	0	1680	44	0
3	C	1632	0	1573	38	0
3	F	1615	0	1553	41	0
3	K	1632	0	1573	40	0
3	L	1615	0	1553	35	0
4	M	61	0	52	0	0
4	N	61	0	52	1	0
4	P	61	0	52	0	0
5	O	28	0	25	1	0
6	A	168	0	156	2	0
6	D	168	0	156	1	0
6	G	154	0	143	1	0
6	I	154	0	142	1	0
7	A	48	0	48	6	0
7	B	24	0	24	1	0
7	C	12	0	12	0	0
7	D	12	0	12	0	0
7	E	12	0	12	0	0
7	G	12	0	12	1	0
7	I	24	0	24	1	0
7	J	12	0	12	1	0
8	A	16	0	24	0	0
8	D	16	0	24	1	0
8	I	8	0	12	2	0
8	J	8	0	12	0	0
8	K	8	0	12	1	0
9	A	89	0	0	1	0
9	B	45	0	0	1	0
9	C	33	0	0	2	0
9	D	55	0	0	0	0
9	E	32	0	0	1	0
9	F	8	0	0	0	0
9	G	66	0	0	2	0
9	H	53	0	0	2	0
9	I	44	0	0	2	0
9	J	24	0	0	2	0

*Continued on next page...*

*Continued from previous page...*

Mol	Chain	Non-H	H(model)	H(added)	Clashes	Symm-Clashes
9	K	31	0	0	0	0
9	L	43	0	0	1	0
All	All	25808	0	24581	514	0

The all-atom clashscore is defined as the number of clashes found per 1000 atoms (including hydrogen atoms). The all-atom clashscore for this structure is 10.

All (514) close contacts within the same asymmetric unit are listed below, sorted by their clash magnitude.

Atom-1	Atom-2	Interatomic distance (Å)	Clash overlap (Å)
1:G:105:GLN:HG3	1:G:476:LYS:HG2	1.47	0.96
1:A:342:LEU:HD23	1:A:396:ILE:HD11	1.54	0.88
1:I:105:GLN:HG3	1:I:476:LYS:HG2	1.56	0.87
1:A:95:MET:HE1	1:A:235:GLY:HA3	1.56	0.86
3:F:6:GLN:HE21	3:F:21:ILE:HD11	1.42	0.85
1:D:349:LEU:HB3	1:D:359:ILE:HG12	1.63	0.79
1:I:408:LYS:HG2	1:I:409:GLY:H	1.48	0.78
2:B:20:ILE:HD11	2:B:80:LEU:HD23	1.66	0.77
1:A:101:VAL:HG21	1:A:480:ARG:HG2	1.68	0.76
2:J:39:LEU:HD21	2:J:45:PRO:HG3	1.66	0.74
1:I:62:GLU:HG3	1:I:64:GLU:H	1.51	0.74
1:D:65:VAL:HG21	1:D:208:ILE:HD12	1.70	0.74
1:G:65:VAL:HG21	1:G:208:ILE:HD12	1.71	0.73
1:I:84:ILE:HB	1:I:244:SER:HB3	1.71	0.72
2:J:126:PRO:HG3	2:J:138:LEU:HB3	1.73	0.70
2:H:39:LEU:HD21	2:H:45:PRO:HG3	1.71	0.70
3:F:204:ARG:H	3:F:204:ARG:HD3	1.54	0.70
7:A:517:BGC:H6C1	2:B:74:TYR:HB2	1.71	0.70
2:B:11:MET:HG2	1:I:122:LEU:HD12	1.74	0.69
2:B:126:PRO:HD2	2:B:213:PRO:HA	1.74	0.69
1:I:95:MET:HE1	1:I:235:GLY:HA3	1.73	0.69
1:A:460:ALA:HB3	2:B:61:ARG:HD2	1.75	0.69
2:J:18:MET:HE3	2:J:82(C):LEU:HD21	1.74	0.68
3:C:195:ALA:HB2	3:C:210:SER:HB3	1.75	0.68
1:G:62:GLU:HG3	1:G:64:GLU:H	1.58	0.68
1:A:62:GLU:HG3	1:A:64:GLU:H	1.59	0.67
3:F:163:GLU:HB3	3:F:177:LEU:HD11	1.77	0.67
2:E:126:PRO:HG3	2:E:138:LEU:HD23	1.76	0.67
1:A:350:LYS:O	1:A:351:GLU:HB3	1.96	0.66
1:G:95:MET:HE1	1:G:235:GLY:HA3	1.77	0.66
1:A:332:GLU:HG2	1:A:415:THR:HG22	1.76	0.66

*Continued on next page...*

*Continued from previous page...*

Atom-1	Atom-2	Interatomic distance (Å)	Clash overlap (Å)
1:A:86:LEU:O	1:A:89:VAL:HG12	1.97	0.65
3:L:47:VAL:HG12	3:L:48:ILE:HG12	1.77	0.65
1:D:332:GLU:HG2	1:D:415:THR:HG22	1.77	0.65
1:G:265:LEU:HD21	1:G:291:SER:HB3	1.80	0.64
2:E:6:GLN:HE21	2:E:107:THR:HG23	1.62	0.64
2:J:35:ASN:OD1	2:J:50:TRP:HB3	1.98	0.64
1:D:120:VAL:HG12	1:D:434:MET:HB3	1.80	0.64
2:J:201:LYS:HB2	2:J:202:PRO:HD3	1.80	0.63
1:D:95:MET:HE1	1:D:235:GLY:HA3	1.80	0.62
1:I:332:GLU:HG2	1:I:415:THR:HG22	1.81	0.62
1:G:332:GLU:HG2	1:G:415:THR:HG22	1.81	0.62
1:D:371:ILE:HD13	2:E:56:ALA:HB2	1.82	0.62
1:I:207:LYS:HE2	1:I:436:ALA:HB3	1.82	0.62
1:A:205:CYS:N	1:A:206:PRO:HD3	2.15	0.61
3:K:110:ARG:HD2	3:K:173:SER:HB2	1.81	0.61
3:F:187:ASP:HA	3:F:190:LYS:HE3	1.81	0.61
3:F:21:ILE:HD12	3:F:102:THR:HB	1.81	0.61
1:I:350:LYS:O	1:I:351:GLU:HB3	2.00	0.61
3:C:47:VAL:HG12	3:C:48:ILE:HG12	1.81	0.61
3:K:21:ILE:HD12	3:K:102:THR:HB	1.82	0.61
1:G:446:VAL:HG21	6:G:507:NAG:H82	1.82	0.61
2:H:126:PRO:HG3	2:H:138:LEU:HB3	1.82	0.61
1:G:105:GLN:CG	1:G:476:LYS:HG2	2.27	0.61
2:H:47:TRP:CZ2	2:H:49:GLY:HA2	2.36	0.60
2:J:30:ILE:HA	2:J:52(A):PRO:HB2	1.83	0.60
2:J:17:SER:OG	7:J:502:BGC:H5	2.02	0.60
1:G:105:GLN:HG3	1:G:476:LYS:CG	2.29	0.60
1:A:431:GLY:HA2	7:A:517:BGC:O4	2.02	0.60
1:I:265:LEU:HD21	1:I:291:SER:HB3	1.84	0.60
1:G:358:THR:O	1:G:465:ASN:HB2	2.02	0.60
1:I:204:ALA:C	1:I:206:PRO:HD3	2.21	0.60
3:F:152:VAL:HG23	3:F:157:GLN:HG3	1.83	0.59
1:D:405:GLU:O	1:D:408:LYS:HG3	2.03	0.59
2:E:61:ARG:HB2	2:E:62:PRO:HD3	1.84	0.59
1:A:381:GLU:HG3	1:A:443:ILE:HD13	1.84	0.59
1:G:342:LEU:HD23	1:G:396:ILE:HD11	1.84	0.59
1:G:204:ALA:C	1:G:206:PRO:HD3	2.23	0.59
1:I:246:GLN:HB2	9:I:625:HOH:O	2.02	0.58
6:A:505:NAG:H5	3:C:28:TYR:OH	2.03	0.58
1:D:350:LYS:O	1:D:351:GLU:HB3	2.03	0.58
1:G:290:LYS:HE2	1:G:337:LYS:HE3	1.85	0.58

*Continued on next page...*

*Continued from previous page...*

Atom-1	Atom-2	Interatomic distance (Å)	Clash overlap (Å)
1:I:105:GLN:HG2	1:I:479:TRP:HE1	1.67	0.57
3:C:192:LYS:HA	3:C:213:ARG:HB3	1.86	0.57
3:F:47:VAL:HG12	3:F:48:ILE:HG12	1.85	0.57
2:J:20:ILE:HD11	2:J:80:LEU:HD23	1.87	0.57
3:K:195:ALA:HA	3:K:210:SER:HB3	1.86	0.57
7:A:517:BGC:C6	2:B:74:TYR:HB2	2.34	0.57
3:F:192:LYS:HG3	3:F:193:VAL:HG23	1.86	0.57
3:K:203:LEU:HD13	3:K:207:VAL:HG23	1.87	0.57
1:A:65:VAL:HG21	1:A:208:ILE:HD12	1.85	0.57
1:D:101:VAL:HG21	1:D:480:ARG:HG2	1.87	0.57
1:G:357:LYS:HB3	1:G:465:ASN:HA	1.86	0.57
1:A:290:LYS:HE2	1:A:337:LYS:HE3	1.86	0.57
2:E:82(A):ARG:HB3	2:E:82(A):ARG:NH1	2.20	0.57
2:J:63:LEU:HD23	2:J:66:ARG:HH12	1.71	0.56
3:K:117:VAL:HG22	3:K:138:LEU:HG	1.88	0.56
3:K:177:LEU:HD23	3:K:178:SER:N	2.21	0.56
1:D:207:LYS:HG2	1:D:439:ILE:HG23	1.86	0.56
2:E:148:GLU:HB3	2:E:149:PRO:HA	1.87	0.56
1:I:105:GLN:HG3	1:I:476:LYS:CG	2.33	0.56
1:G:350:LYS:O	1:G:351:GLU:HB3	2.06	0.56
2:J:18:MET:CE	2:J:109:VAL:HG11	2.36	0.56
2:J:5:VAL:HG13	2:J:105:ARG:HH22	1.69	0.56
1:I:65:VAL:HG21	1:I:208:ILE:HD12	1.86	0.56
1:I:101:VAL:HG21	1:I:480:ARG:HG2	1.87	0.55
2:E:30:ILE:HA	2:E:52(A):PRO:HB2	1.87	0.55
2:H:82(A):ARG:HH11	2:H:82(A):ARG:HB3	1.71	0.55
2:J:47:TRP:CZ2	2:J:49:GLY:HA2	2.41	0.55
3:K:185:LYS:O	3:K:189:GLU:HG2	2.07	0.55
1:G:104:MET:HE2	1:G:479:TRP:HB3	1.88	0.55
3:L:146:ALA:HB2	3:L:200:HIS:HD2	1.72	0.55
3:F:194:TYR:HB2	3:F:211:PHE:HE2	1.72	0.55
1:I:270:ILE:HB	1:I:348:LYS:HG3	1.89	0.55
1:A:463:THR:O	1:A:464:SER:HB3	2.07	0.55
1:D:207:LYS:HG2	1:D:439:ILE:CG2	2.36	0.55
2:E:47:TRP:CH2	2:E:49:GLY:HA2	2.42	0.55
1:G:205:CYS:N	1:G:206:PRO:HD3	2.22	0.54
1:A:95:MET:CE	1:A:235:GLY:HA3	2.34	0.54
3:C:21:ILE:HD11	3:C:35:TRP:HZ3	1.72	0.54
2:E:18:MET:HE3	2:E:82(C):LEU:HD21	1.89	0.54
1:A:116:LEU:O	1:A:118:PRO:HD3	2.07	0.54
3:C:209:LYS:HB2	3:C:209:LYS:NZ	2.22	0.54

*Continued on next page...*

*Continued from previous page...*

Atom-1	Atom-2	Interatomic distance (Å)	Clash overlap (Å)
1:D:341:VAL:O	1:D:345:VAL:HG23	2.06	0.54
1:I:105:GLN:HG2	1:I:479:TRP:NE1	2.22	0.54
3:K:140:ASN:ND2	8:K:301:TRS:H21	2.23	0.54
2:H:105:ARG:HD2	9:E:418:HOH:O	2.06	0.54
1:G:64:GLU:HA	1:G:209:SER:HB3	1.88	0.54
5:O:1:NAG:O3	5:O:2:NAG:H2	2.07	0.54
2:B:51:LEU:HD21	2:B:71:ARG:HB3	1.89	0.54
1:I:53:PHE:HA	8:I:514:TRS:H21	1.89	0.54
1:D:53:PHE:HA	8:D:513:TRS:H31	1.89	0.54
3:L:195:ALA:HB2	3:L:210:SER:HB3	1.89	0.53
3:C:54:ARG:NE	3:C:60:ASP:HA	2.23	0.53
3:C:2:ILE:HG22	3:C:3:VAL:H	1.73	0.53
1:D:116:LEU:O	1:D:118:PRO:HD3	2.09	0.53
2:B:82(A):ARG:HB3	2:B:82(A):ARG:NH1	2.22	0.53
1:I:273:ARG:HH12	1:I:287:HIS:CG	2.27	0.53
2:J:200:HIS:CD2	2:J:202:PRO:HD2	2.44	0.53
1:A:463:THR:HG22	9:A:681:HOH:O	2.08	0.53
1:D:205:CYS:N	1:D:206:PRO:HD3	2.23	0.53
2:B:98:CYS:HB2	7:B:302:BGC:H6C2	1.91	0.53
3:F:194:TYR:HB2	3:F:211:PHE:CE2	2.44	0.53
3:L:168:GLN:HE21	3:L:173:SER:HB3	1.73	0.53
3:K:6:GLN:NE2	3:K:21:ILE:HD11	2.24	0.53
2:H:66:ARG:HD3	9:H:303:HOH:O	2.08	0.52
3:F:38:GLN:HB3	3:F:85:VAL:HG13	1.92	0.52
1:D:204:ALA:C	1:D:206:PRO:HD3	2.30	0.52
2:E:47:TRP:CZ2	2:E:49:GLY:HA2	2.45	0.52
3:F:6:GLN:NE2	3:F:21:ILE:HD11	2.20	0.52
2:B:131:THR:HG23	2:B:133:GLY:H	1.74	0.52
1:D:261:LEU:HD21	1:D:374:HIS:CE1	2.45	0.52
2:J:82(A):ARG:HB3	2:J:82(A):ARG:NH1	2.25	0.52
1:G:95:MET:CE	1:G:235:GLY:HA3	2.40	0.52
1:G:101:VAL:HG21	1:G:480:ARG:HG2	1.92	0.52
2:H:82(A):ARG:HB3	2:H:82(A):ARG:NH1	2.24	0.52
1:A:105:GLN:HG3	1:A:476:LYS:HG2	1.90	0.52
3:L:79:GLU:H	3:L:82:ASP:HB2	1.75	0.52
1:D:62:GLU:HG3	1:D:64:GLU:H	1.75	0.52
2:E:20:ILE:HD11	2:E:80:LEU:HD23	1.91	0.52
3:K:137:LEU:C	3:K:138:LEU:HD12	2.31	0.52
1:G:86:LEU:HB2	1:G:89:VAL:HG11	1.92	0.51
2:H:35:ASN:HB2	2:H:93:THR:OG1	2.10	0.51
1:D:105:GLN:HG3	1:D:476:LYS:HG2	1.93	0.51

*Continued on next page...*

*Continued from previous page...*

Atom-1	Atom-2	Interatomic distance (Å)	Clash overlap (Å)
1:I:116:LEU:HD13	1:I:208:ILE:HD11	1.92	0.51
2:B:18:MET:CE	2:B:109:VAL:HG11	2.41	0.51
2:B:47:TRP:HZ2	2:B:50:TRP:CD1	2.28	0.51
1:A:87:GLU:O	1:A:88:ASN:HB2	2.10	0.51
1:I:385:CYS:SG	1:I:416:LEU:HB2	2.51	0.51
3:L:77:ASN:HB2	9:L:312:HOH:O	2.10	0.51
3:L:204:ARG:H	3:L:204:ARG:HE	1.57	0.51
1:I:292:VAL:HG21	1:I:338:TRP:HE3	1.75	0.51
2:J:139:GLY:HA2	2:J:154:TRP:CH2	2.46	0.51
3:F:168:GLN:HB2	3:F:175:TYR:CE1	2.46	0.51
1:I:101:VAL:HG13	1:I:479:TRP:HB2	1.92	0.51
3:C:109:LYS:HA	3:C:142:TYR:OH	2.11	0.51
3:L:27:GLN:HG3	3:L:28:TYR:N	2.27	0.50
1:A:105:GLN:CG	1:A:476:LYS:HG2	2.41	0.50
3:F:110:ARG:HH12	3:F:113:ALA:HB2	1.75	0.50
1:G:463:THR:HG21	2:H:61:ARG:NH2	2.25	0.50
3:C:79:GLU:H	3:C:82:ASP:HB2	1.77	0.50
1:G:350:LYS:C	1:G:352:HIS:H	2.14	0.50
3:K:142:TYR:O	3:K:200:HIS:HE1	1.94	0.50
2:B:44:ARG:HG2	3:C:100:GLN:HA	1.94	0.50
2:B:47:TRP:CZ2	2:B:49:GLY:HA2	2.46	0.50
1:I:64:GLU:HA	1:I:209:SER:HB3	1.94	0.50
3:L:185:LYS:O	3:L:189:GLU:HG2	2.12	0.50
2:B:201:LYS:HE2	2:B:201:LYS:HA	1.93	0.50
3:K:35:TRP:CZ3	3:K:88:CYS:HB3	2.46	0.50
3:F:191:HIS:HB2	3:F:194:TYR:OH	2.11	0.50
1:A:421:LYS:NZ	7:A:518:BGC:H3	2.26	0.50
2:B:139:GLY:HA2	2:B:154:TRP:CH2	2.46	0.50
1:D:231:LYS:HD2	1:D:267:GLU:HB3	1.94	0.50
2:E:18:MET:CE	2:E:109:VAL:HG11	2.42	0.50
3:C:21:ILE:HD12	3:C:102:THR:HB	1.93	0.49
3:L:110:ARG:HH12	3:L:113:ALA:HB2	1.76	0.49
2:B:134:GLY:HA3	9:B:437:HOH:O	2.13	0.49
1:A:108:VAL:HG22	1:A:253:PRO:HB3	1.94	0.49
1:I:290:LYS:HD2	6:I:506:NAG:H82	1.95	0.49
1:A:350:LYS:C	1:A:352:HIS:H	2.16	0.49
2:B:200:HIS:CE1	2:B:202:PRO:HB2	2.48	0.49
3:F:65:SER:OG	3:F:72:ASN:HB2	2.13	0.49
1:G:371:ILE:HD11	2:H:54:GLY:HA3	1.94	0.49
1:D:261:LEU:HD21	1:D:374:HIS:HE1	1.78	0.49
1:I:95:MET:SD	1:I:273:ARG:HD3	2.53	0.49

*Continued on next page...*

*Continued from previous page...*

Atom-1	Atom-2	Interatomic distance (Å)	Clash overlap (Å)
2:B:30:ILE:HA	2:B:52(A):PRO:HB2	1.94	0.48
2:B:124:LEU:HD11	2:B:141:LEU:HB2	1.95	0.48
1:D:95:MET:HB3	1:D:95:MET:HE2	1.69	0.48
2:E:7:SER:O	2:E:107:THR:HG22	2.12	0.48
1:D:328:LYS:O	1:D:328:LYS:HD3	2.13	0.48
2:J:124:LEU:HD11	2:J:141:LEU:HB2	1.95	0.48
2:B:11:MET:CE	1:I:434:MET:HB2	2.43	0.48
2:B:135:THR:HG22	2:B:185:PRO:HA	1.95	0.48
2:J:210:LYS:NZ	2:J:212:GLU:HG2	2.28	0.48
2:B:124:LEU:HB3	3:C:120:PHE:CD1	2.48	0.48
2:E:123:PRO:HG3	2:E:209:LYS:HD2	1.95	0.48
3:L:89:GLN:HG2	3:L:90:GLN:N	2.27	0.48
2:E:139:GLY:HA2	2:E:154:TRP:HH2	1.79	0.48
3:K:131:THR:HG22	3:K:184:SER:HA	1.96	0.48
1:A:93:PHE:HB2	1:A:233:PHE:HZ	1.79	0.48
1:D:86:LEU:HB2	1:D:89:VAL:HG11	1.96	0.48
3:K:48:ILE:HD13	3:K:54:ARG:HA	1.96	0.48
3:K:165:VAL:HG12	3:K:166:THR:O	2.14	0.48
3:L:127:LEU:O	3:L:185:LYS:HD2	2.14	0.48
1:D:408:LYS:HD2	1:D:408:LYS:C	2.34	0.48
2:H:50:TRP:CZ3	2:H:52:LYS:HG3	2.49	0.48
2:B:126:PRO:HG3	2:B:138:LEU:HD23	1.95	0.48
1:D:325:ASP:O	1:D:328:LYS:HG3	2.13	0.48
2:E:150:VAL:HG23	2:E:178:LEU:HD21	1.96	0.48
1:A:95:MET:HE1	1:A:234:ASN:O	2.14	0.47
1:A:256:SER:HA	1:A:375:HIS:O	2.14	0.47
3:C:137:LEU:C	3:C:138:LEU:HD12	2.34	0.47
3:L:204:ARG:H	3:L:204:ARG:NE	2.12	0.47
3:C:77:ASN:HB2	9:C:408:HOH:O	2.14	0.47
3:C:191:HIS:O	3:C:213:ARG:HD3	2.13	0.47
1:A:273:ARG:HH12	1:A:287:HIS:CG	2.33	0.47
1:D:108:VAL:HG22	1:D:253:PRO:HB3	1.96	0.47
1:I:341:VAL:O	1:I:345:VAL:HG23	2.14	0.47
2:J:129:LYS:NZ	3:K:211:PHE:HA	2.29	0.47
3:K:147:LYS:HB3	3:K:199:THR:OG1	2.15	0.47
1:I:93:PHE:HB2	1:I:233:PHE:CZ	2.50	0.47
3:K:199:THR:HG22	3:K:206:PRO:HB3	1.95	0.47
2:H:178:LEU:HD12	2:H:178:LEU:C	2.34	0.47
1:A:263:GLY:O	1:A:450:THR:HG21	2.14	0.47
2:B:61:ARG:HB2	2:B:62:PRO:HD3	1.96	0.47
2:B:116:THR:HG22	2:B:147:PRO:HD3	1.96	0.47

*Continued on next page...*



*Continued from previous page...*

Atom-1	Atom-2	Interatomic distance (Å)	Clash overlap (Å)
3:C:131:THR:HB	3:C:183:LEU:O	2.14	0.47
3:C:177:LEU:HD23	3:C:178:SER:N	2.30	0.47
1:D:446:VAL:HG11	6:D:507:NAG:H82	1.97	0.47
2:E:96:LYS:HG3	2:E:101:GLU:OE1	2.14	0.47
3:F:110:ARG:HD2	3:F:173:SER:HB2	1.96	0.47
3:F:160:ASN:HD22	3:F:183:LEU:HD21	1.80	0.47
3:K:89:GLN:HG2	3:K:90:GLN:N	2.29	0.47
1:G:256:SER:HA	1:G:375:HIS:O	2.15	0.47
3:C:2:ILE:HD13	3:C:97:PHE:HD2	1.79	0.47
1:I:104:MET:HG2	1:I:479:TRP:CG	2.49	0.47
2:J:63:LEU:HD23	2:J:66:ARG:NH1	2.29	0.47
2:H:11:MET:CE	1:D:434:MET:HB2	2.45	0.47
3:L:18:THR:HG22	3:L:76:SER:O	2.14	0.47
1:A:207:LYS:HG2	1:A:439:ILE:CG2	2.45	0.47
2:J:123:PRO:HG3	2:J:209:LYS:HD2	1.96	0.47
3:C:17:GLU:O	3:C:78:LEU:HD13	2.14	0.47
3:F:75:ILE:HD12	3:F:75:ILE:N	2.30	0.47
3:L:33:LEU:HD13	3:L:71:TYR:CG	2.50	0.46
1:I:458:GLY:O	2:J:60:ALA:HA	2.15	0.46
1:G:394:THR:HB	9:G:601:HOH:O	2.15	0.46
1:D:95:MET:SD	1:D:273:ARG:HD3	2.55	0.46
2:E:201:LYS:N	2:E:202:PRO:CD	2.78	0.46
2:H:119:PRO:HD2	2:H:205:THR:HG21	1.98	0.46
3:K:23:CYS:HB2	3:K:35:TRP:CH2	2.50	0.46
2:H:40:ALA:HB2	2:H:88:ALA:HB2	1.97	0.46
2:B:178:LEU:C	2:B:178:LEU:HD12	2.35	0.46
1:D:259:LEU:HB2	1:D:374:HIS:CE1	2.51	0.46
1:I:116:LEU:O	1:I:118:PRO:HD3	2.15	0.46
1:I:333:ILE:N	1:I:333:ILE:HD12	2.30	0.46
1:G:414:ILE:HD11	1:G:416:LEU:HD21	1.98	0.46
2:H:20:ILE:HD11	2:H:80:LEU:HD23	1.97	0.46
1:A:298:ARG:HD2	1:A:326:ILE:O	2.14	0.46
1:D:408:LYS:C	1:D:410:CYS:H	2.18	0.46
1:D:343:LYS:NZ	1:D:343:LYS:HB3	2.30	0.46
1:G:349:LEU:O	1:G:353:PHE:HD2	1.98	0.46
2:E:39:LEU:HD21	2:E:45:PRO:HG3	1.96	0.46
3:L:66:ARG:HG3	3:L:71:TYR:CZ	2.51	0.46
1:A:360:ILE:O	1:A:467:THR:HA	2.14	0.46
1:A:392:ASN:O	1:A:396:ILE:HD13	2.15	0.46
2:B:39:LEU:HD22	2:B:45:PRO:HB3	1.97	0.46
1:D:207:LYS:HE2	1:D:436:ALA:HB3	1.97	0.46

*Continued on next page...*

*Continued from previous page...*

Atom-1	Atom-2	Interatomic distance (Å)	Clash overlap (Å)
3:K:160:ASN:H	3:K:160:ASN:HD22	1.64	0.46
1:G:120:VAL:HG12	1:G:434:MET:HB3	1.98	0.46
3:L:12:SER:HB3	3:L:107:ASP:HB2	1.98	0.46
2:E:121:VAL:HG13	2:E:140:CYS:HB3	1.98	0.46
1:A:358:THR:HB	1:A:465:ASN:HB3	1.96	0.46
3:F:54:ARG:NE	3:F:60:ASP:HA	2.31	0.46
1:I:350:LYS:C	1:I:352:HIS:H	2.19	0.46
2:E:200:HIS:CE1	2:E:202:PRO:HB2	2.50	0.45
3:K:127:LEU:O	3:K:185:LYS:HD2	2.16	0.45
2:H:57:VAL:HG21	2:H:59:TYR:CE1	2.52	0.45
3:L:83:PHE:HA	3:L:104:VAL:HG23	1.98	0.45
3:L:110:ARG:HD2	3:L:173:SER:HB2	1.98	0.45
2:B:126:PRO:HG3	2:B:138:LEU:HB3	1.98	0.45
2:E:131:THR:HG23	2:E:134:GLY:H	1.81	0.45
3:F:116:SER:OG	3:F:139:ASN:HB3	2.16	0.45
2:H:183:THR:HG21	3:L:139:ASN:ND2	2.32	0.45
3:L:194:TYR:HB2	3:L:211:PHE:CE2	2.51	0.45
1:A:351:GLU:OE2	7:A:516:BGC:H6C1	2.15	0.45
1:D:425:ASN:ND2	1:D:432:GLN:HG2	2.31	0.45
6:A:507:NAG:H82	6:A:507:NAG:H2	1.87	0.45
2:B:148:GLU:HB3	2:B:149:PRO:HA	1.98	0.45
1:D:248:THR:HA	1:D:486:TYR:CE1	2.51	0.45
3:F:204:ARG:H	3:F:204:ARG:CD	2.19	0.45
2:J:57:VAL:HG21	2:J:59:TYR:CE1	2.52	0.45
2:H:61:ARG:HB2	2:H:62:PRO:HD3	1.99	0.45
1:A:91:GLU:HG3	1:A:226:LEU:HD13	1.99	0.45
1:A:232:ASN:OD1	1:A:268:GLU:HB3	2.17	0.45
2:E:147:PRO:HB2	2:E:148:GLU:H	1.44	0.45
1:I:120:VAL:HG12	1:I:434:MET:HB3	1.99	0.45
1:G:95:MET:HB3	1:G:95:MET:HE2	1.79	0.45
3:L:168:GLN:NE2	3:L:173:SER:HB3	2.32	0.45
2:E:3:GLN:C	2:E:4:LEU:HD12	2.37	0.45
3:L:65:SER:OG	3:L:72:ASN:HB2	2.17	0.45
2:E:82(A):ARG:HB3	2:E:82(A):ARG:HH11	1.81	0.45
1:I:105:GLN:HG2	1:I:479:TRP:CD1	2.51	0.45
1:I:205:CYS:N	1:I:206:PRO:HD3	2.32	0.45
3:K:18:THR:HG22	3:K:76:SER:O	2.17	0.45
1:D:101:VAL:HG13	1:D:479:TRP:HB2	1.98	0.45
1:I:108:VAL:HG22	1:I:253:PRO:HB3	1.97	0.45
2:J:18:MET:HE1	2:J:109:VAL:HG11	1.99	0.45
1:G:104:MET:CE	1:G:479:TRP:HB3	2.47	0.45

*Continued on next page...*

*Continued from previous page...*

Atom-1	Atom-2	Interatomic distance (Å)	Clash overlap (Å)
1:A:434:MET:HB2	2:J:11:MET:CE	2.47	0.45
3:C:142:TYR:O	3:C:200:HIS:HE1	2.00	0.45
1:D:93:PHE:HB2	1:D:233:PHE:HZ	1.82	0.45
1:I:290:LYS:HE2	1:I:337:LYS:HE3	1.99	0.45
1:G:95:MET:SD	1:G:273:ARG:HD3	2.57	0.44
2:B:154:TRP:HB2	2:B:159:LEU:HB3	1.98	0.44
3:F:33:LEU:HD13	3:F:71:TYR:CD1	2.52	0.44
3:L:35:TRP:CZ3	3:L:88:CYS:HB3	2.52	0.44
2:J:44:ARG:NH1	3:K:2:ILE:HD11	2.31	0.44
3:K:21:ILE:HD12	3:K:102:THR:CB	2.47	0.44
2:H:53:ARG:HB3	9:H:308:HOH:O	2.16	0.44
1:D:381:GLU:HB2	1:D:383:PHE:HE2	1.82	0.44
3:F:120:PHE:HB2	3:F:135:VAL:HB	1.99	0.44
3:F:138:LEU:HB2	3:F:177:LEU:HB3	2.00	0.44
3:F:142:TYR:O	3:F:200:HIS:HE1	2.00	0.44
1:I:421:LYS:HE2	1:I:421:LYS:HB3	1.85	0.44
1:G:65:VAL:HG12	1:G:66:HIS:N	2.32	0.44
2:B:40:ALA:HB2	2:B:88:ALA:HB2	2.00	0.44
3:F:139:ASN:O	3:F:141:PHE:HD1	2.01	0.44
1:A:104:MET:HE2	1:A:479:TRP:HB3	2.00	0.44
3:K:47:VAL:HG12	3:K:48:ILE:HG12	2.00	0.44
2:H:18:MET:CE	2:H:109:VAL:HG11	2.48	0.44
1:D:290:LYS:HE2	1:D:337:LYS:HE3	2.00	0.44
3:K:6:GLN:HE21	3:K:21:ILE:HD11	1.82	0.44
2:H:11:MET:HE3	1:D:434:MET:HB2	1.98	0.44
3:C:147:LYS:HE3	9:C:405:HOH:O	2.18	0.44
2:E:47:TRP:HZ2	2:E:50:TRP:CD1	2.35	0.44
2:J:66:ARG:HD3	9:J:603:HOH:O	2.17	0.44
3:C:2:ILE:HD13	3:C:97:PHE:CD2	2.53	0.44
3:C:114:ALA:HA	3:C:115:PRO:HD3	1.76	0.44
1:D:357:LYS:HD3	1:D:466:GLU:HG2	1.98	0.44
1:I:461:ASN:OD1	3:K:2:ILE:HG22	2.17	0.44
1:G:269:GLU:HA	1:G:289:ASN:ND2	2.32	0.44
1:A:64:GLU:HA	1:A:209:SER:HB3	1.99	0.44
1:A:99:ASN:HA	1:A:102:GLU:HG2	2.00	0.44
1:I:378:CYS:HB3	1:I:383:PHE:CE2	2.53	0.44
2:J:82(A):ARG:HB3	2:J:82(A):ARG:HH11	1.83	0.44
3:K:151:LYS:HB2	3:K:195:ALA:HB3	1.99	0.44
1:G:269:GLU:HA	1:G:289:ASN:HD22	1.83	0.43
3:L:75:ILE:N	3:L:75:ILE:HD12	2.33	0.43
3:L:203:LEU:HD22	3:L:204:ARG:HH21	1.82	0.43

*Continued on next page...*

*Continued from previous page...*

Atom-1	Atom-2	Interatomic distance (Å)	Clash overlap (Å)
1:A:270:ILE:O	1:A:348:LYS:HE2	2.17	0.43
2:B:82(A):ARG:HB3	2:B:82(A):ARG:HH11	1.83	0.43
1:G:53:PHE:HB2	9:G:626:HOH:O	2.17	0.43
3:F:39:ARG:HD3	3:F:81:GLY:O	2.17	0.43
2:J:47:TRP:CH2	2:J:49:GLY:HA2	2.53	0.43
1:G:229:ASN:HD21	1:G:243:SER:HB3	1.82	0.43
2:H:2:VAL:HB	2:H:102:HIS:CD2	2.53	0.43
1:I:118:PRO:HB3	1:I:433:ALA:HB1	1.99	0.43
1:G:408:LYS:HD2	1:G:408:LYS:N	2.34	0.43
1:A:93:PHE:HB2	1:A:233:PHE:CZ	2.53	0.43
1:D:93:PHE:CE2	1:D:228:CYS:HB2	2.54	0.43
1:I:408:LYS:HG2	1:I:409:GLY:N	2.25	0.43
1:G:460:ALA:HB3	2:H:61:ARG:HD3	2.00	0.43
2:E:38:ARG:HG3	2:E:46:GLU:HB3	2.00	0.43
3:F:6:GLN:H	3:F:100:GLN:HE22	1.67	0.43
3:K:109:LYS:HA	3:K:142:TYR:OH	2.18	0.43
2:H:139:GLY:HA2	2:H:154:TRP:CH2	2.54	0.43
2:H:205:THR:C	2:H:206:LYS:HD2	2.38	0.43
1:A:252:LYS:HA	1:A:253:PRO:HD3	1.83	0.43
1:G:100:MET:HB3	1:G:100:MET:HE2	1.93	0.43
1:G:461:ASN:HD22	3:L:3:VAL:HG13	1.84	0.43
2:B:123:PRO:HG3	2:B:209:LYS:HD2	2.00	0.43
3:C:135:VAL:HG12	3:C:136:CYS:N	2.33	0.43
3:C:136:CYS:HB2	3:C:150:TRP:CZ2	2.54	0.43
3:K:207:VAL:HG12	3:K:208:THR:N	2.34	0.43
1:G:110:SER:O	1:G:114:GLN:HG2	2.18	0.43
2:H:27:TYR:HE2	2:H:32:CYS:HB2	1.83	0.43
1:A:349:LEU:HD12	1:A:349:LEU:HA	1.82	0.43
2:J:18:MET:HE2	2:J:109:VAL:HG11	2.00	0.43
1:G:422:GLN:HB3	1:G:435:TYR:O	2.19	0.43
2:H:168:ALA:HA	2:H:178:LEU:HB3	2.01	0.43
1:A:122:LEU:HD12	2:J:11:MET:HG2	2.01	0.43
2:B:188:SER:O	2:B:192:GLN:HB2	2.18	0.43
2:B:196:CYS:SG	2:B:209:LYS:HB3	2.59	0.43
2:H:196:CYS:SG	2:H:209:LYS:HB3	2.58	0.43
2:B:168:ALA:HA	2:B:178:LEU:HB3	2.00	0.43
1:D:64:GLU:HA	1:D:209:SER:HB3	2.00	0.43
2:E:184:VAL:HG21	2:E:194:TYR:CE1	2.54	0.43
2:J:51:LEU:HD23	2:J:51:LEU:C	2.39	0.43
2:J:116:THR:HG22	2:J:147:PRO:HD3	2.01	0.43
1:I:95:MET:HB3	1:I:95:MET:HE2	1.80	0.42

*Continued on next page...*

*Continued from previous page...*

Atom-1	Atom-2	Interatomic distance (Å)	Clash overlap (Å)
2:J:59:TYR:HB2	2:J:64:GLN:HG2	2.01	0.42
1:G:257:THR:O	1:G:258:GLN:HB2	2.19	0.42
3:C:78:LEU:HD23	3:C:83:PHE:CZ	2.54	0.42
1:G:333:ILE:HD12	1:G:333:ILE:N	2.35	0.42
1:A:204:ALA:C	1:A:206:PRO:HD3	2.40	0.42
3:C:65:SER:OG	3:C:72:ASN:HB2	2.18	0.42
2:E:2:VAL:HB	2:E:102:HIS:NE2	2.34	0.42
2:E:57:VAL:HG21	2:E:59:TYR:CE1	2.53	0.42
2:E:212:GLU:HA	2:E:213:PRO:HD3	1.92	0.42
3:F:136:CYS:HB2	3:F:150:TRP:CH2	2.54	0.42
1:I:201:ILE:N	1:I:201:ILE:HD12	2.34	0.42
2:J:19:ARG:HA	2:J:80:LEU:O	2.19	0.42
2:H:35:ASN:O	2:H:92:CYS:HA	2.19	0.42
4:N:3:BMA:H61	4:N:5:MAN:H2	1.68	0.42
2:H:96:LYS:HG3	2:H:101:GLU:OE1	2.20	0.42
2:H:206:LYS:HD2	2:H:206:LYS:N	2.34	0.42
1:A:65:VAL:HG13	1:A:115:SER:OG	2.20	0.42
1:I:107:ASP:OD2	8:I:514:TRS:H32	2.20	0.42
3:C:64:GLY:HA2	3:C:72:ASN:O	2.19	0.42
3:C:75:ILE:HD12	3:C:75:ILE:N	2.35	0.42
3:F:104:VAL:HG23	3:F:104:VAL:O	2.20	0.42
1:G:343:LYS:NZ	1:G:343:LYS:HB3	2.34	0.42
1:A:104:MET:CE	1:A:479:TRP:HB3	2.49	0.42
2:B:6:GLN:HE21	2:B:107:THR:HG23	1.84	0.42
2:J:61:ARG:HB2	2:J:62:PRO:HD3	2.01	0.42
2:J:206:LYS:HD3	2:J:206:LYS:N	2.34	0.42
3:K:19:ALA:O	3:K:74:THR:HA	2.19	0.42
3:K:160:ASN:HD22	3:K:160:ASN:N	2.17	0.42
3:C:195:ALA:HB2	3:C:210:SER:CB	2.46	0.42
3:F:35:TRP:CZ3	3:F:88:CYS:HB3	2.54	0.42
3:K:75:ILE:HD12	3:K:75:ILE:N	2.34	0.42
1:G:297:THR:O	1:G:329:ALA:HB1	2.20	0.42
3:C:83:PHE:HA	3:C:104:VAL:HG23	2.02	0.42
1:D:93:PHE:HB2	1:D:233:PHE:CZ	2.55	0.42
3:F:139:ASN:O	3:F:140:ASN:C	2.59	0.42
2:J:122:PHE:HA	2:J:123:PRO:HD3	1.82	0.42
3:K:192:LYS:O	3:K:212:ASN:HA	2.20	0.42
1:D:88:ASN:N	1:D:88:ASN:OD1	2.52	0.42
1:I:95:MET:CE	1:I:235:GLY:HA3	2.47	0.42
3:K:127:LEU:HD23	3:K:132:ALA:HB2	2.02	0.42
2:H:150:VAL:HG12	2:H:200:HIS:CD2	2.55	0.41

*Continued on next page...*

*Continued from previous page...*

Atom-1	Atom-2	Interatomic distance (Å)	Clash overlap (Å)
3:L:149:GLN:CD	3:L:156:LEU:HD21	2.40	0.41
2:J:29:PHE:O	2:J:52(A):PRO:HG2	2.19	0.41
3:C:204:ARG:HG2	3:C:205:SER:N	2.35	0.41
1:I:82:GLN:HB3	9:I:625:HOH:O	2.18	0.41
2:J:146:PHE:HA	2:J:147:PRO:HA	1.88	0.41
1:A:115:SER:O	1:A:117:GLN:HG3	2.19	0.41
1:A:343:LYS:NZ	1:A:343:LYS:HB3	2.34	0.41
1:A:416:LEU:HA	1:A:417:PRO:HD3	1.84	0.41
2:B:38:ARG:C	2:B:39:LEU:HD23	2.41	0.41
2:B:50:TRP:CZ3	2:B:52:LYS:HG3	2.55	0.41
1:D:416:LEU:HA	1:D:417:PRO:HD3	1.88	0.41
1:A:300:SER:HB3	1:A:442:LYS:N	2.36	0.41
1:D:66:HIS:CD2	1:D:111:LEU:HD11	2.56	0.41
1:D:269:GLU:HA	1:D:289:ASN:ND2	2.35	0.41
3:F:64:GLY:HA2	3:F:72:ASN:O	2.20	0.41
3:L:27:GLN:HG3	3:L:28:TYR:H	1.84	0.41
3:L:66:ARG:HG3	3:L:71:TYR:CE2	2.55	0.41
3:L:84:GLY:H	3:L:104:VAL:HG23	1.85	0.41
3:L:149:GLN:OE1	3:L:156:LEU:HD21	2.20	0.41
1:A:328:LYS:HD3	1:A:328:LYS:O	2.21	0.41
2:J:35:ASN:HD21	2:J:100(A):ASN:ND2	2.18	0.41
1:G:298:ARG:HD2	1:G:326:ILE:O	2.20	0.41
1:G:342:LEU:HD12	1:G:342:LEU:HA	1.95	0.41
2:H:201:LYS:N	2:H:202:PRO:CD	2.83	0.41
2:B:122:PHE:HA	2:B:123:PRO:HD3	1.84	0.41
2:B:201:LYS:N	2:B:202:PRO:CD	2.83	0.41
3:C:6:GLN:H	3:C:100:GLN:NE2	2.18	0.41
1:D:349:LEU:HA	1:D:349:LEU:HD12	1.86	0.41
1:I:343:LYS:NZ	1:I:343:LYS:HB3	2.36	0.41
1:I:480:ARG:NH1	7:I:513:BGC:H2	2.35	0.41
2:J:153:SER:OG	2:J:197:ASN:HB2	2.20	0.41
3:K:91:TYR:HB3	3:K:96:GLU:OE1	2.20	0.41
1:G:328:LYS:O	1:G:328:LYS:HD3	2.21	0.41
1:D:297:THR:HB	1:D:444:ASN:OD1	2.21	0.41
3:K:122:PRO:HG2	3:K:188:TYR:CZ	2.56	0.41
1:G:270:ILE:O	1:G:348:LYS:HE2	2.21	0.41
1:A:86:LEU:HB2	1:A:89:VAL:HG11	2.02	0.41
2:E:166:PHE:HA	3:F:166:THR:HG22	2.02	0.41
3:F:190:LYS:NZ	3:F:190:LYS:HB2	2.35	0.41
1:I:91:GLU:HG3	1:I:226:LEU:HD13	2.01	0.41
1:I:257:THR:O	1:I:258:GLN:HB2	2.21	0.41

*Continued on next page...*

Continued from previous page...

Atom-1	Atom-2	Interatomic distance (Å)	Clash overlap (Å)
2:J:17:SER:HB3	9:J:613:HOH:O	2.19	0.41
2:J:118:GLY:HA2	2:J:119:PRO:HD3	1.81	0.41
1:A:421:LYS:HE2	1:A:421:LYS:HB3	1.87	0.41
1:A:461:ASN:HD21	3:C:2:ILE:HA	1.85	0.41
3:F:127:LEU:HB3	3:F:185:LYS:NZ	2.36	0.41
1:I:75:VAL:HB	1:I:76:PRO:HD2	2.03	0.41
3:L:142:TYR:CG	3:L:143:PRO:HA	2.56	0.40
2:B:183:THR:HG21	3:C:139:ASN:HD22	1.86	0.40
2:B:205:THR:HG22	2:B:207:VAL:HG23	2.02	0.40
3:F:19:ALA:HB3	3:F:75:ILE:HD13	2.04	0.40
2:J:17:SER:CB	2:J:82(A):ARG:HA	2.51	0.40
1:G:425:ASN:HD21	7:G:512:BGC:H1	1.85	0.40
3:L:142:TYR:O	3:L:200:HIS:HE1	2.04	0.40
3:C:78:LEU:HD23	3:C:83:PHE:CE1	2.56	0.40
1:D:219:THR:HA	1:D:220:PRO:HD3	1.87	0.40
1:D:234:ASN:O	1:D:273:ARG:HG2	2.21	0.40
1:D:448:ASN:O	1:D:450:THR:HG23	2.21	0.40
3:F:134:VAL:O	3:F:180:THR:HA	2.20	0.40
3:K:160:ASN:N	3:K:160:ASN:ND2	2.69	0.40
1:G:116:LEU:HD13	1:G:382:PHE:HZ	1.86	0.40
1:D:110:SER:O	1:D:114:GLN:HG2	2.21	0.40
2:B:50:TRP:CH2	2:B:52:LYS:HE3	2.56	0.40
1:D:225:ILE:HG21	1:D:486:TYR:HD1	1.86	0.40
2:E:123:PRO:O	3:F:123:SER:HB3	2.22	0.40
3:K:168:GLN:HB2	3:K:175:TYR:CE1	2.56	0.40
3:L:17:GLU:OE1	3:L:109:LYS:HE3	2.22	0.40
1:A:397:GLY:O	1:A:404:ASN:HB2	2.22	0.40
1:A:421:LYS:HZ3	7:A:518:BGC:H3	1.87	0.40
3:C:194:TYR:HB2	3:C:211:PHE:CE2	2.57	0.40
2:E:71:ARG:O	2:E:71:ARG:HD3	2.21	0.40
3:F:84:GLY:H	3:F:104:VAL:HG23	1.86	0.40
1:I:224:VAL:HG22	1:I:225:ILE:N	2.37	0.40

There are no symmetry-related clashes.

## 5.3 Torsion angles [i](#)

### 5.3.1 Protein backbone [i](#)

In the following table, the Percentiles column shows the percent Ramachandran outliers of the chain as a percentile score with respect to all X-ray entries followed by that with respect to entries

of similar resolution.

The Analysed column shows the number of residues for which the backbone conformation was analysed, and the total number of residues.

Mol	Chain	Analysed	Favoured	Allowed	Outliers	Percentiles	
1	A	345/353 (98%)	312 (90%)	30 (9%)	3 (1%)	17	37
1	D	346/353 (98%)	314 (91%)	30 (9%)	2 (1%)	25	47
1	G	343/353 (97%)	315 (92%)	25 (7%)	3 (1%)	17	37
1	I	345/353 (98%)	311 (90%)	31 (9%)	3 (1%)	17	37
2	B	222/224 (99%)	203 (91%)	19 (9%)	0	100	100
2	E	222/224 (99%)	192 (86%)	25 (11%)	5 (2%)	6	14
2	H	222/224 (99%)	201 (90%)	19 (9%)	2 (1%)	17	37
2	J	222/224 (99%)	206 (93%)	14 (6%)	2 (1%)	17	37
3	C	208/210 (99%)	178 (86%)	28 (14%)	2 (1%)	15	34
3	F	206/210 (98%)	176 (85%)	26 (13%)	4 (2%)	8	18
3	K	208/210 (99%)	188 (90%)	16 (8%)	4 (2%)	8	18
3	L	206/210 (98%)	192 (93%)	12 (6%)	2 (1%)	15	34
All	All	3095/3148 (98%)	2788 (90%)	275 (9%)	32 (1%)	15	34

All (32) Ramachandran outliers are listed below:

Mol	Chain	Res	Type
2	H	127	SER
2	E	147	PRO
1	G	410	CYS
2	H	100(D)	PHE
3	L	140	ASN
1	A	404	ASN
3	C	140	ASN
1	D	397	GLY
1	D	411	ASN
3	K	2	ILE
3	K	140	ASN
1	G	267	GLU
1	G	411	ASN
2	E	127	SER
3	F	140	ASN
1	I	396	ILE
2	J	203	SER
1	A	467	THR

*Continued on next page...*



*Continued from previous page...*

Mol	Chain	Res	Type
3	F	110	ARG
2	J	100(D)	PHE
1	A	462	ASN
2	E	82(B)	SER
2	E	144	ASP
3	F	15	PRO
3	K	15	PRO
3	L	15	PRO
1	I	470	PRO
3	K	206	PRO
3	C	2	ILE
3	F	206	PRO
1	I	220	PRO
2	E	126	PRO

### 5.3.2 Protein sidechains [i](#)

In the following table, the Percentiles column shows the percent sidechain outliers of the chain as a percentile score with respect to all X-ray entries followed by that with respect to entries of similar resolution.

The Analysed column shows the number of residues for which the sidechain conformation was analysed, and the total number of residues.

Mol	Chain	Analysed	Rotameric	Outliers	Percentiles	
1	A	310/311 (100%)	301 (97%)	9 (3%)	42	69
1	D	310/311 (100%)	301 (97%)	9 (3%)	42	69
1	G	309/311 (99%)	299 (97%)	10 (3%)	39	65
1	I	309/311 (99%)	304 (98%)	5 (2%)	62	83
2	B	192/192 (100%)	190 (99%)	2 (1%)	76	90
2	E	192/192 (100%)	189 (98%)	3 (2%)	62	83
2	H	192/192 (100%)	185 (96%)	7 (4%)	35	61
2	J	192/192 (100%)	191 (100%)	1 (0%)	88	95
3	C	182/182 (100%)	178 (98%)	4 (2%)	52	77
3	F	180/182 (99%)	175 (97%)	5 (3%)	43	70
3	K	182/182 (100%)	180 (99%)	2 (1%)	73	89
3	L	180/182 (99%)	177 (98%)	3 (2%)	60	82
All	All	2730/2740 (100%)	2670 (98%)	60 (2%)	52	77

All (60) residues with a non-rotameric sidechain are listed below:

Mol	Chain	Res	Type
1	G	105	GLN
1	G	123	THR
1	G	200	VAL
1	G	328	LYS
1	G	369	LEU
1	G	396	ILE
1	G	407	MET
1	G	414	ILE
1	G	428	GLN
1	G	462	ASN
2	H	1	GLN
2	H	4	LEU
2	H	34	LEU
2	H	38	ARG
2	H	71	ARG
2	H	82(A)	ARG
2	H	147	PRO
3	L	74	THR
3	L	156	LEU
3	L	204	ARG
1	A	90	THR
1	A	92	ASN
1	A	95	MET
1	A	105	GLN
1	A	297	THR
1	A	328	LYS
1	A	347	GLU
1	A	349	LEU
1	A	385	CYS
2	B	57	VAL
2	B	71	ARG
3	C	21	ILE
3	C	74	THR
3	C	204	ARG
3	C	209	LYS
1	D	88	ASN
1	D	105	GLN
1	D	259	LEU
1	D	328	LYS
1	D	349	LEU
1	D	395	CYS
1	D	396	ILE

*Continued on next page...*

*Continued from previous page...*

Mol	Chain	Res	Type
1	D	408	LYS
1	D	428	GLN
2	E	1	GLN
2	E	38	ARG
2	E	71	ARG
3	F	21	ILE
3	F	70	ASP
3	F	181	LEU
3	F	204	ARG
3	F	211	PHE
1	I	104	MET
1	I	105	GLN
1	I	261	LEU
1	I	328	LYS
1	I	407	MET
2	J	71	ARG
3	K	21	ILE
3	K	160	ASN

Sometimes sidechains can be flipped to improve hydrogen bonding and reduce clashes. All (3) such sidechains are listed below:

Mol	Chain	Res	Type
1	G	389	GLN
1	A	92	ASN
1	A	362	GLN

### 5.3.3 RNA [i](#)

There are no RNA molecules in this entry.

## 5.4 Non-standard residues in protein, DNA, RNA chains [i](#)

There are no non-standard protein/DNA/RNA residues in this entry.

## 5.5 Carbohydrates [i](#)

17 monosaccharides are modelled in this entry.

In the following table, the Counts columns list the number of bonds (or angles) for which Mogul statistics could be retrieved, the number of bonds (or angles) that are observed in the model and

the number of bonds (or angles) that are defined in the Chemical Component Dictionary. The Link column lists molecule types, if any, to which the group is linked. The Z score for a bond length (or angle) is the number of standard deviations the observed value is removed from the expected value. A bond length (or angle) with  $|Z| > 2$  is considered an outlier worth inspection. RMSZ is the root-mean-square of all Z scores of the bond lengths (or angles).

Mol	Type	Chain	Res	Link	Bond lengths			Bond angles		
					Counts	RMSZ	# Z  > 2	Counts	RMSZ	# Z  > 2
4	NAG	M	1	4,3	14,14,15	0.57	0	17,19,21	0.77	0
4	NAG	M	2	4	14,14,15	0.53	0	17,19,21	0.84	0
4	BMA	M	3	4	11,11,12	0.64	0	15,15,17	0.84	1 (6%)
4	MAN	M	4	4	11,11,12	0.68	0	15,15,17	0.67	0
4	MAN	M	5	4	11,11,12	0.64	0	15,15,17	0.68	0
4	NAG	N	1	4,3	14,14,15	0.59	0	17,19,21	0.74	0
4	NAG	N	2	4	14,14,15	0.59	0	17,19,21	0.74	0
4	BMA	N	3	4	11,11,12	0.63	0	15,15,17	0.86	1 (6%)
4	MAN	N	4	4	11,11,12	0.65	0	15,15,17	0.57	0
4	MAN	N	5	4	11,11,12	0.68	0	15,15,17	0.69	0
5	NAG	O	1	3,5	14,14,15	0.49	0	17,19,21	0.99	1 (5%)
5	NAG	O	2	5	14,14,15	0.53	0	17,19,21	0.64	0
4	NAG	P	1	4,3	14,14,15	0.59	0	17,19,21	0.84	0
4	NAG	P	2	4	14,14,15	0.56	0	17,19,21	0.88	0
4	BMA	P	3	4	11,11,12	0.69	0	15,15,17	1.04	1 (6%)
4	MAN	P	4	4	11,11,12	0.62	0	15,15,17	0.61	0
4	MAN	P	5	4	11,11,12	0.66	0	15,15,17	0.72	0

In the following table, the Chirals column lists the number of chiral outliers, the number of chiral centers analysed, the number of these observed in the model and the number defined in the Chemical Component Dictionary. Similar counts are reported in the Torsion and Rings columns. '-' means no outliers of that kind were identified.

Mol	Type	Chain	Res	Link	Chirals	Torsions	Rings
4	NAG	M	1	4,3	-	0/6/23/26	0/1/1/1
4	NAG	M	2	4	-	2/6/23/26	0/1/1/1
4	BMA	M	3	4	-	2/2/19/22	0/1/1/1
4	MAN	M	4	4	-	0/2/19/22	0/1/1/1
4	MAN	M	5	4	-	0/2/19/22	0/1/1/1
4	NAG	N	1	4,3	-	2/6/23/26	0/1/1/1
4	NAG	N	2	4	-	0/6/23/26	0/1/1/1
4	BMA	N	3	4	-	2/2/19/22	0/1/1/1
4	MAN	N	4	4	-	0/2/19/22	0/1/1/1
4	MAN	N	5	4	-	0/2/19/22	0/1/1/1
5	NAG	O	1	3,5	-	2/6/23/26	0/1/1/1

*Continued on next page...*

*Continued from previous page...*

Mol	Type	Chain	Res	Link	Chirals	Torsions	Rings
5	NAG	O	2	5	-	2/6/23/26	0/1/1/1
4	NAG	P	1	4,3	-	2/6/23/26	0/1/1/1
4	NAG	P	2	4	-	0/6/23/26	0/1/1/1
4	BMA	P	3	4	-	2/2/19/22	0/1/1/1
4	MAN	P	4	4	-	0/2/19/22	0/1/1/1
4	MAN	P	5	4	-	0/2/19/22	0/1/1/1

There are no bond length outliers.

All (4) bond angle outliers are listed below:

Mol	Chain	Res	Type	Atoms	Z	Observed(°)	Ideal(°)
4	P	3	BMA	C1-C2-C3	3.13	113.51	109.67
5	O	1	NAG	O5-C5-C6	2.94	111.81	107.20
4	M	3	BMA	C1-C2-C3	2.35	112.56	109.67
4	N	3	BMA	O5-C5-C6	2.26	110.75	107.20

There are no chirality outliers.

All (16) torsion outliers are listed below:

Mol	Chain	Res	Type	Atoms
4	M	2	NAG	C8-C7-N2-C2
4	M	2	NAG	O7-C7-N2-C2
5	O	2	NAG	C8-C7-N2-C2
5	O	2	NAG	O7-C7-N2-C2
4	N	3	BMA	O5-C5-C6-O6
4	P	3	BMA	O5-C5-C6-O6
4	N	3	BMA	C4-C5-C6-O6
4	P	3	BMA	C4-C5-C6-O6
4	P	1	NAG	C8-C7-N2-C2
4	M	3	BMA	C4-C5-C6-O6
4	N	1	NAG	C8-C7-N2-C2
4	P	1	NAG	O7-C7-N2-C2
5	O	1	NAG	C8-C7-N2-C2
4	M	3	BMA	O5-C5-C6-O6
4	N	1	NAG	O7-C7-N2-C2
5	O	1	NAG	O7-C7-N2-C2

There are no ring outliers.

4 monomers are involved in 2 short contacts:

Mol	Chain	Res	Type	Clashes	Symm-Clashes
5	O	2	NAG	1	0
5	O	1	NAG	1	0
4	N	3	BMA	1	0
4	N	5	MAN	1	0

The following is a two-dimensional graphical depiction of Mogul quality analysis of bond lengths, bond angles, torsion angles, and ring geometry for oligosaccharide.

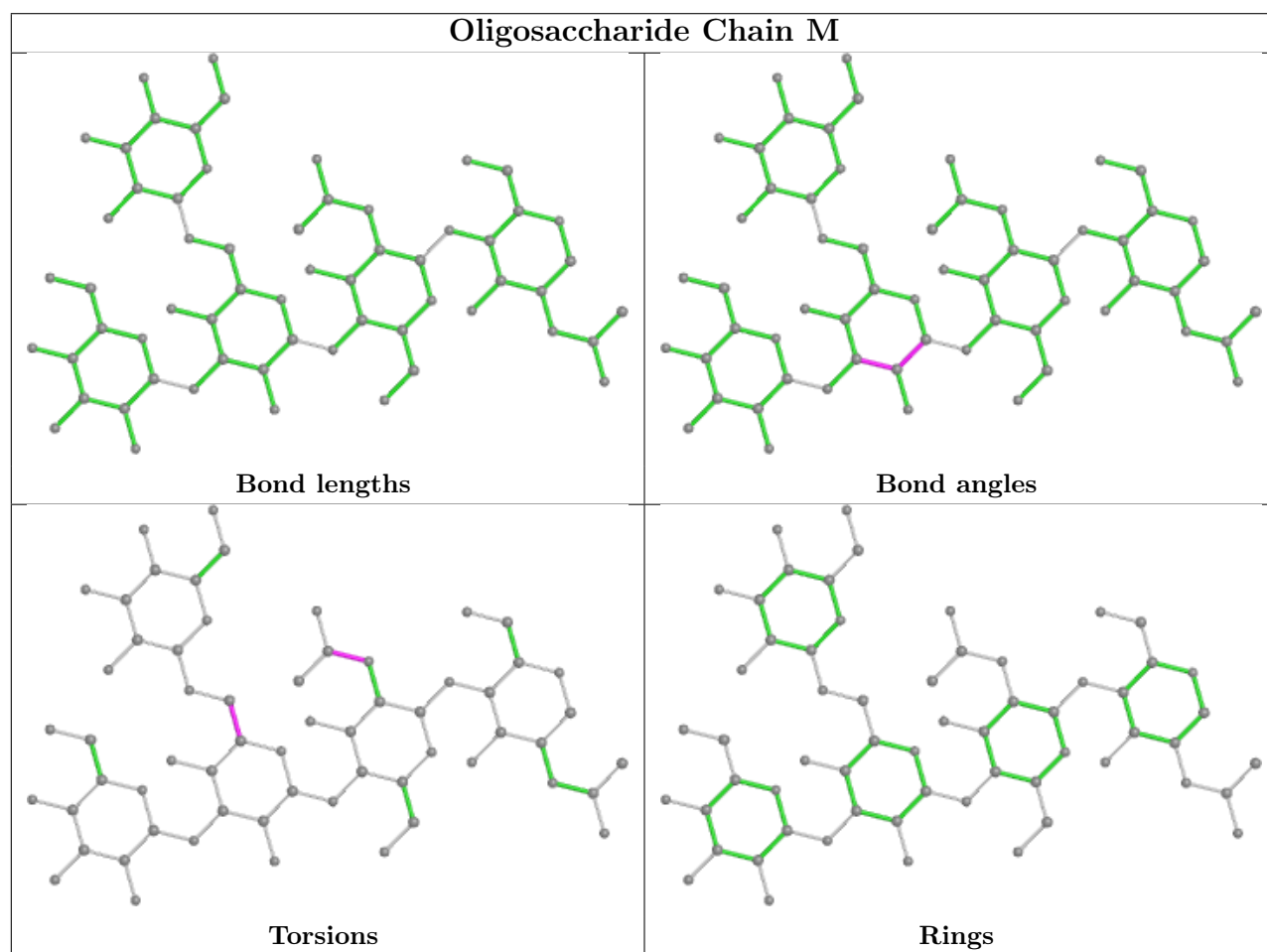

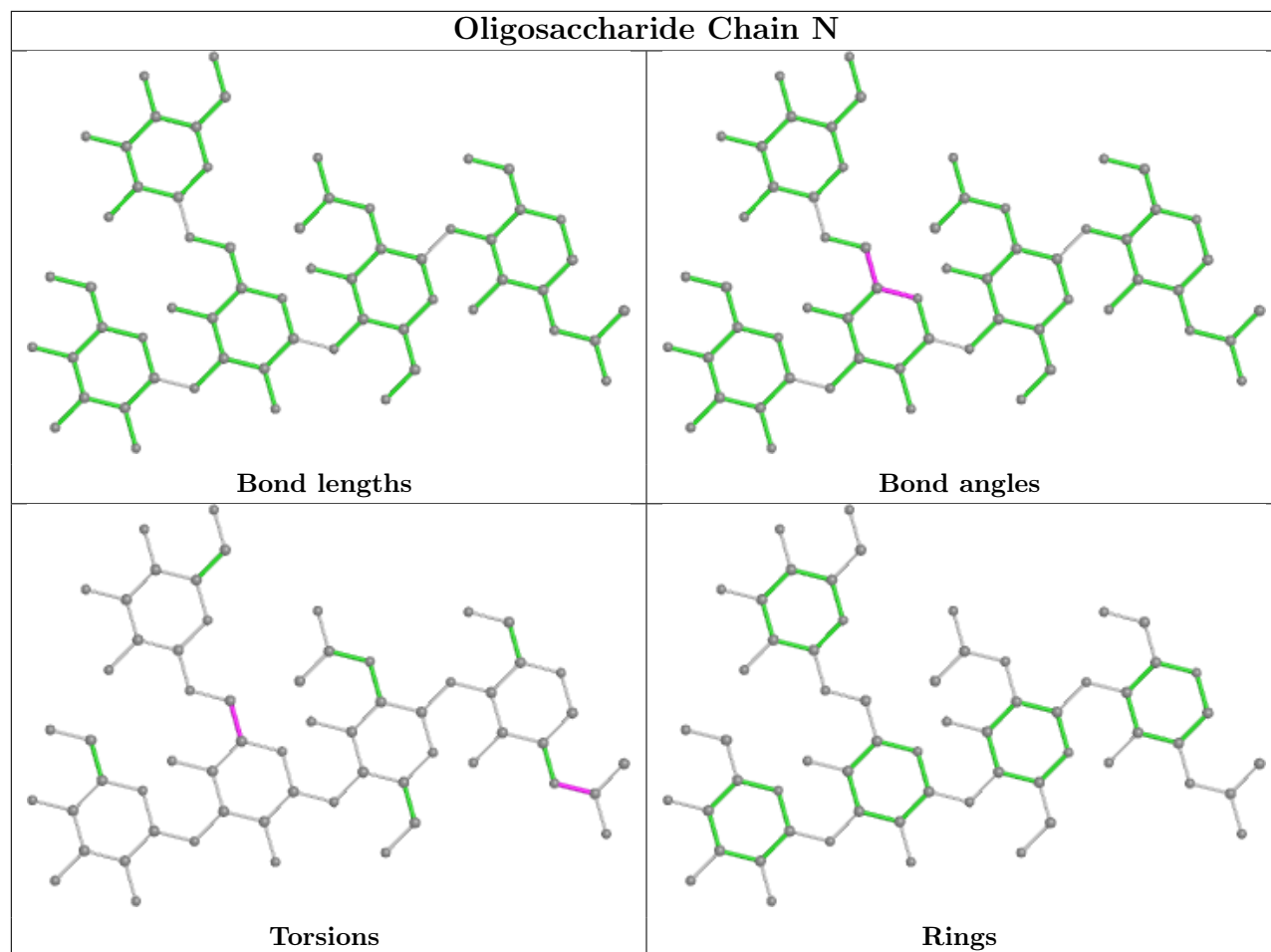

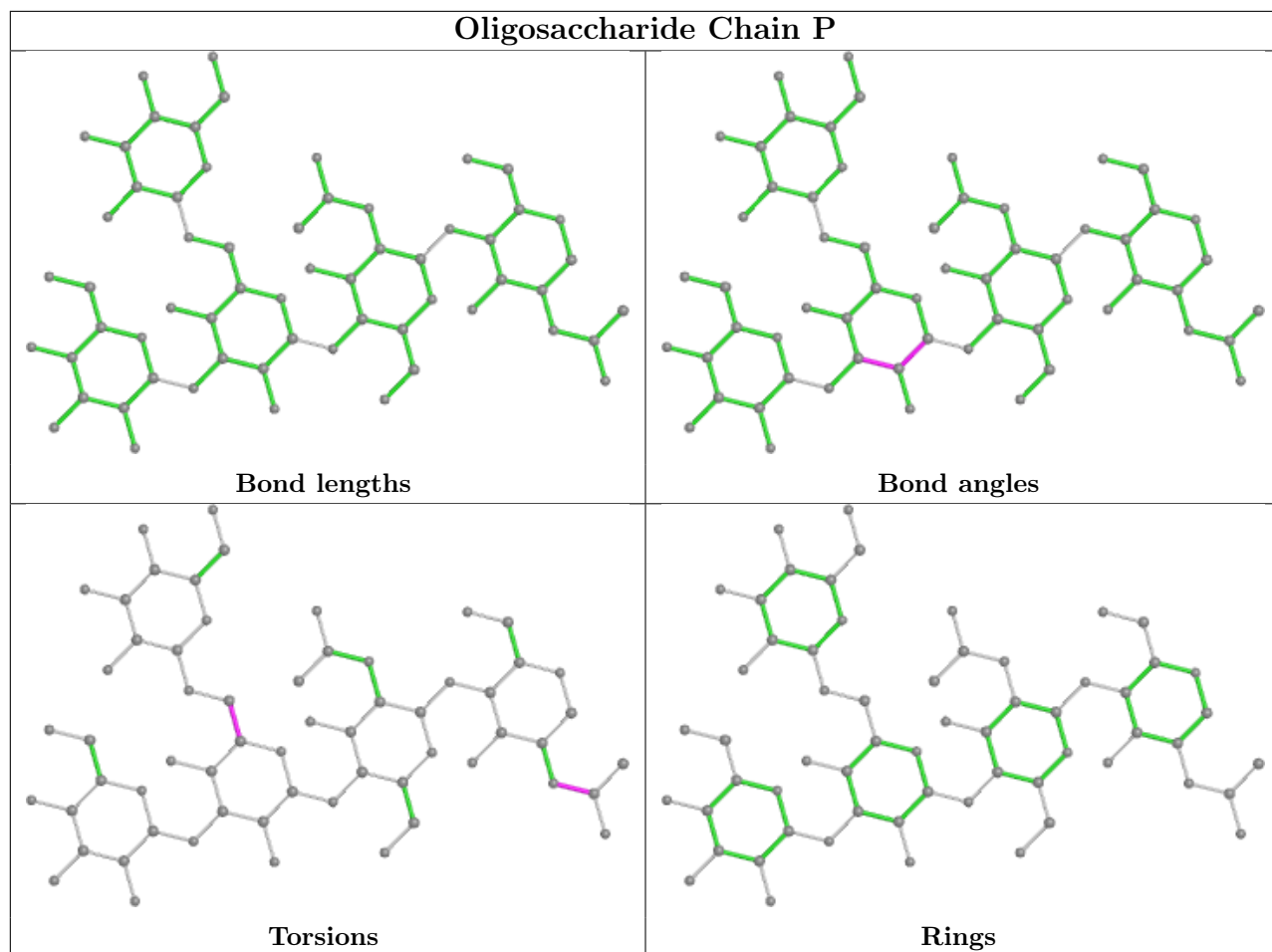



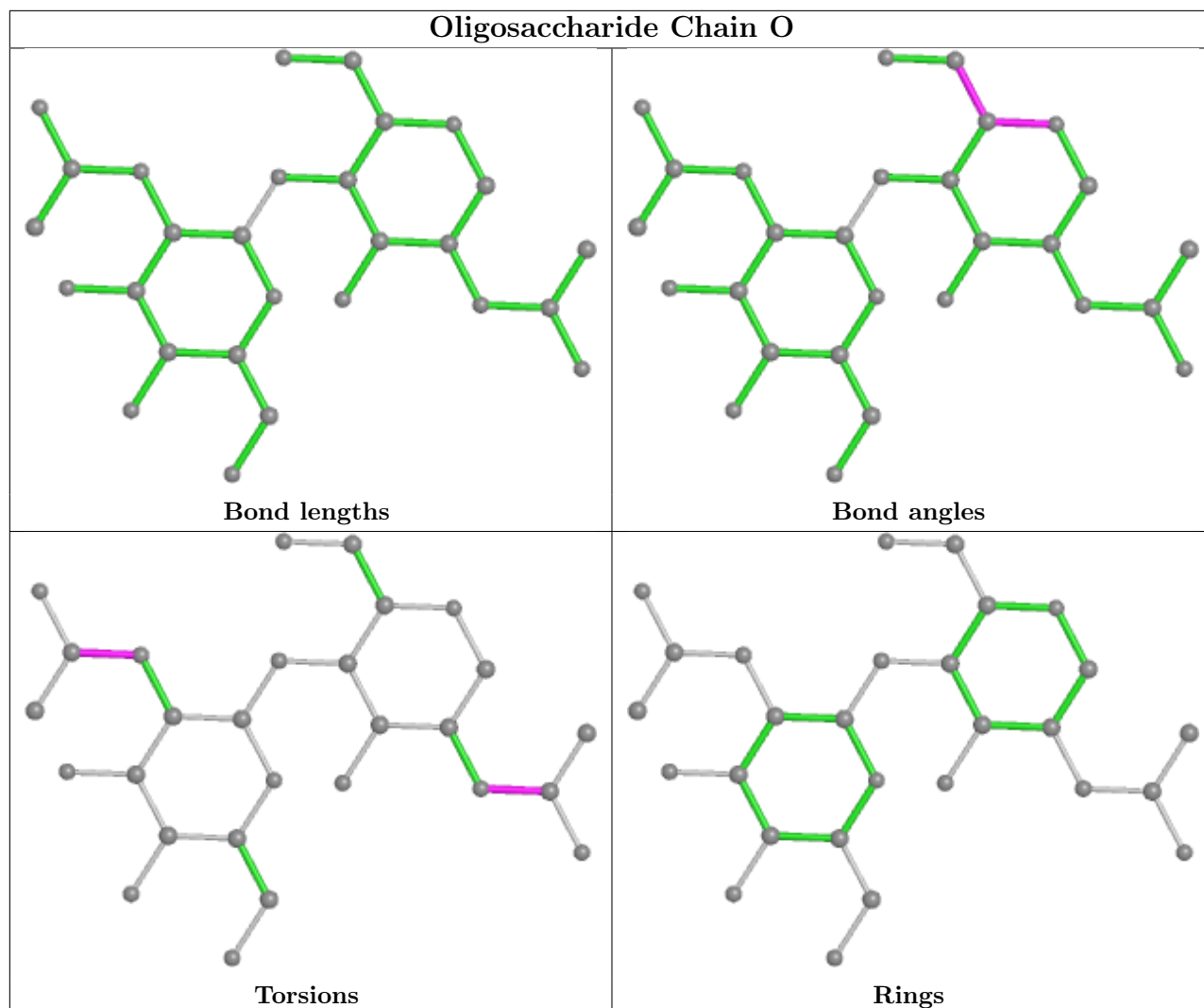

## 5.6 Ligand geometry [i](#)

66 ligands are modelled in this entry.

In the following table, the Counts columns list the number of bonds (or angles) for which Mogul statistics could be retrieved, the number of bonds (or angles) that are observed in the model and the number of bonds (or angles) that are defined in the Chemical Component Dictionary. The Link column lists molecule types, if any, to which the group is linked. The Z score for a bond length (or angle) is the number of standard deviations the observed value is removed from the expected value. A bond length (or angle) with  $|Z| > 2$  is considered an outlier worth inspection. RMSZ is the root-mean-square of all Z scores of the bond lengths (or angles).

Mol	Type	Chain	Res	Link	Bond lengths			Bond angles		
					Counts	RMSZ	$\# Z  > 2$	Counts	RMSZ	$\# Z  > 2$
7	BGC	J	502	-	12,12,12	0.53	0	17,17,17	0.53	0
6	NAG	D	511	1	14,14,15	0.54	0	17,19,21	0.73	0
6	NAG	I	503	1	14,14,15	0.55	0	17,19,21	0.59	0
6	NAG	G	502	1	14,14,15	0.54	0	17,19,21	0.71	0

Mol	Type	Chain	Res	Link	Bond lengths			Bond angles		
					Counts	RMSZ	# Z  > 2	Counts	RMSZ	# Z  > 2
6	NAG	D	503	1	14,14,15	0.54	0	17,19,21	0.62	0
6	NAG	A	509	1	14,14,15	0.56	0	17,19,21	0.57	0
6	NAG	G	510	1	14,14,15	0.55	0	17,19,21	0.66	0
6	NAG	I	505	1	14,14,15	0.57	0	17,19,21	0.67	0
7	BGC	A	518	-	12,12,12	0.54	0	17,17,17	0.58	0
6	NAG	G	511	1	14,14,15	0.56	0	17,19,21	0.71	0
6	NAG	A	506	1	14,14,15	0.54	0	17,19,21	0.84	0
6	NAG	A	512	1	14,14,15	0.54	0	17,19,21	0.62	0
8	TRS	D	513	-	7,7,7	0.32	0	9,9,9	0.34	0
7	BGC	I	512	-	12,12,12	0.54	0	17,17,17	0.50	0
6	NAG	I	501	1	14,14,15	0.53	0	17,19,21	1.00	2 (11%)
6	NAG	I	510	1	14,14,15	0.52	0	17,19,21	0.82	1 (5%)
6	NAG	I	508	1	14,14,15	0.57	0	17,19,21	0.61	0
7	BGC	B	301	-	12,12,12	0.53	0	17,17,17	0.50	0
6	NAG	D	506	1	14,14,15	0.56	0	17,19,21	0.63	0
8	TRS	J	501	-	7,7,7	0.33	0	9,9,9	0.31	0
7	BGC	A	516	-	12,12,12	0.52	0	17,17,17	0.54	0
7	BGC	A	515	-	12,12,12	0.54	0	17,17,17	0.51	0
7	BGC	E	301	-	12,12,12	0.52	0	17,17,17	0.51	0
6	NAG	G	509	1	14,14,15	0.59	0	17,19,21	0.67	0
6	NAG	I	506	1	14,14,15	0.50	0	17,19,21	0.94	1 (5%)
6	NAG	I	502	1	14,14,15	0.52	0	17,19,21	0.78	0
6	NAG	A	511	1	14,14,15	0.52	0	17,19,21	0.76	0
6	NAG	D	507	1	14,14,15	0.57	0	17,19,21	0.66	0
8	TRS	A	513	-	7,7,7	0.32	0	9,9,9	0.35	0
7	BGC	B	302	-	12,12,12	0.53	0	17,17,17	0.48	0
6	NAG	I	511	1	14,14,15	0.58	0	17,19,21	1.63	2 (11%)
8	TRS	D	514	-	7,7,7	0.33	0	9,9,9	0.28	0
6	NAG	D	501	1	14,14,15	0.54	0	17,19,21	0.70	0
8	TRS	K	301	-	7,7,7	0.33	0	9,9,9	0.30	0
6	NAG	A	503	1	14,14,15	0.52	0	17,19,21	0.82	0
6	NAG	D	508	1	14,14,15	0.53	0	17,19,21	0.75	1 (5%)
7	BGC	C	301	-	12,12,12	0.54	0	17,17,17	0.50	0
6	NAG	G	506	1	14,14,15	0.49	0	17,19,21	0.91	1 (5%)
6	NAG	G	501	1	14,14,15	0.52	0	17,19,21	0.60	0
6	NAG	D	504	1	14,14,15	0.59	0	17,19,21	0.70	0
6	NAG	I	507	1	14,14,15	0.55	0	17,19,21	0.59	0
6	NAG	D	509	1	14,14,15	0.55	0	17,19,21	0.69	0
6	NAG	G	505	1	14,14,15	0.54	0	17,19,21	0.81	1 (5%)
7	BGC	G	512	-	12,12,12	0.54	0	17,17,17	0.49	0
6	NAG	A	510	1	14,14,15	0.56	0	17,19,21	0.70	0

Mol	Type	Chain	Res	Link	Bond lengths			Bond angles		
					Counts	RMSZ	# Z  > 2	Counts	RMSZ	# Z  > 2
6	NAG	G	508	1	14,14,15	0.55	0	17,19,21	0.71	0
7	BGC	I	513	-	12,12,12	0.55	0	17,17,17	0.55	0
6	NAG	A	507	1	14,14,15	0.51	0	17,19,21	0.85	0
6	NAG	A	502	1	14,14,15	0.54	0	17,19,21	0.78	0
6	NAG	A	501	1	14,14,15	0.55	0	17,19,21	0.75	0
6	NAG	G	507	1	14,14,15	0.54	0	17,19,21	0.72	0
6	NAG	A	508	1	14,14,15	0.53	0	17,19,21	0.63	0
6	NAG	G	503	1	14,14,15	0.54	0	17,19,21	0.71	0
6	NAG	G	504	1	14,14,15	0.54	0	17,19,21	1.04	1 (5%)
8	TRS	I	514	-	7,7,7	0.33	0	9,9,9	0.37	0
6	NAG	D	510	1	14,14,15	0.57	0	17,19,21	0.70	0
6	NAG	A	505	1	14,14,15	0.54	0	17,19,21	0.74	1 (5%)
6	NAG	A	504	1	14,14,15	0.56	0	17,19,21	0.90	1 (5%)
6	NAG	I	504	1	14,14,15	0.55	0	17,19,21	0.74	0
6	NAG	D	505	1	14,14,15	0.58	0	17,19,21	0.58	0
7	BGC	D	515	-	12,12,12	0.53	0	17,17,17	0.45	0
6	NAG	D	512	1	14,14,15	0.55	0	17,19,21	0.57	0
6	NAG	I	509	1	14,14,15	0.56	0	17,19,21	0.67	0
6	NAG	D	502	1	14,14,15	0.55	0	17,19,21	0.65	0
8	TRS	A	514	-	7,7,7	0.32	0	9,9,9	0.31	0
7	BGC	A	517	-	12,12,12	0.53	0	17,17,17	0.45	0

In the following table, the Chirals column lists the number of chiral outliers, the number of chiral centers analysed, the number of these observed in the model and the number defined in the Chemical Component Dictionary. Similar counts are reported in the Torsion and Rings columns. '-' means no outliers of that kind were identified.

Mol	Type	Chain	Res	Link	Chirals	Torsions	Rings
7	BGC	J	502	-	-	2/2/22/22	0/1/1/1
6	NAG	D	511	1	-	2/6/23/26	0/1/1/1
6	NAG	I	503	1	-	0/6/23/26	0/1/1/1
6	NAG	G	502	1	-	2/6/23/26	0/1/1/1
6	NAG	D	503	1	-	2/6/23/26	0/1/1/1
6	NAG	A	509	1	-	4/6/23/26	0/1/1/1
6	NAG	G	510	1	-	2/6/23/26	0/1/1/1
6	NAG	I	505	1	-	3/6/23/26	0/1/1/1
7	BGC	A	518	-	-	1/2/22/22	0/1/1/1
6	NAG	G	511	1	-	2/6/23/26	0/1/1/1
6	NAG	A	506	1	-	4/6/23/26	0/1/1/1
6	NAG	A	512	1	-	3/6/23/26	0/1/1/1

Continued on next page...

*Continued from previous page...*

Mol	Type	Chain	Res	Link	Chirals	Torsions	Rings
8	TRS	D	513	-	-	0/9/9/9	-
7	BGC	I	512	-	-	1/2/22/22	0/1/1/1
6	NAG	I	501	1	-	2/6/23/26	0/1/1/1
6	NAG	I	510	1	-	3/6/23/26	0/1/1/1
6	NAG	I	508	1	-	3/6/23/26	0/1/1/1
7	BGC	B	301	-	-	0/2/22/22	0/1/1/1
6	NAG	D	506	1	-	3/6/23/26	0/1/1/1
8	TRS	J	501	-	-	0/9/9/9	-
7	BGC	A	516	-	-	0/2/22/22	0/1/1/1
7	BGC	A	515	-	-	0/2/22/22	0/1/1/1
7	BGC	E	301	-	-	0/2/22/22	0/1/1/1
6	NAG	G	509	1	-	2/6/23/26	0/1/1/1
6	NAG	I	506	1	-	0/6/23/26	0/1/1/1
6	NAG	I	502	1	-	3/6/23/26	0/1/1/1
6	NAG	A	511	1	-	2/6/23/26	0/1/1/1
6	NAG	D	507	1	-	0/6/23/26	0/1/1/1
8	TRS	A	513	-	-	2/9/9/9	-
7	BGC	B	302	-	-	1/2/22/22	0/1/1/1
6	NAG	I	511	1	-	4/6/23/26	0/1/1/1
8	TRS	D	514	-	-	0/9/9/9	-
6	NAG	D	501	1	-	0/6/23/26	0/1/1/1
8	TRS	K	301	-	-	0/9/9/9	-
6	NAG	A	503	1	-	2/6/23/26	0/1/1/1
6	NAG	D	508	1	-	2/6/23/26	0/1/1/1
7	BGC	C	301	-	-	0/2/22/22	0/1/1/1
6	NAG	G	506	1	-	0/6/23/26	0/1/1/1
6	NAG	G	501	1	-	2/6/23/26	0/1/1/1
6	NAG	D	504	1	-	0/6/23/26	0/1/1/1
6	NAG	I	507	1	-	3/6/23/26	0/1/1/1
6	NAG	D	509	1	-	2/6/23/26	0/1/1/1
6	NAG	G	505	1	-	2/6/23/26	0/1/1/1
7	BGC	G	512	-	-	0/2/22/22	0/1/1/1
6	NAG	A	510	1	-	0/6/23/26	0/1/1/1
6	NAG	G	508	1	-	3/6/23/26	0/1/1/1
7	BGC	I	513	-	-	0/2/22/22	0/1/1/1
6	NAG	A	507	1	-	2/6/23/26	0/1/1/1
6	NAG	A	502	1	-	2/6/23/26	0/1/1/1
6	NAG	A	501	1	-	2/6/23/26	0/1/1/1

*Continued on next page...*

Continued from previous page...

Mol	Type	Chain	Res	Link	Chirals	Torsions	Rings
6	NAG	G	507	1	-	0/6/23/26	0/1/1/1
6	NAG	A	508	1	-	2/6/23/26	0/1/1/1
6	NAG	G	503	1	-	2/6/23/26	0/1/1/1
6	NAG	G	504	1	-	4/6/23/26	0/1/1/1
8	TRS	I	514	-	-	1/9/9/9	-
6	NAG	D	510	1	-	0/6/23/26	0/1/1/1
6	NAG	A	505	1	-	3/6/23/26	0/1/1/1
6	NAG	A	504	1	-	2/6/23/26	0/1/1/1
6	NAG	I	504	1	-	2/6/23/26	0/1/1/1
6	NAG	D	505	1	-	2/6/23/26	0/1/1/1
7	BGC	D	515	-	-	0/2/22/22	0/1/1/1
6	NAG	D	512	1	-	2/6/23/26	0/1/1/1
6	NAG	I	509	1	-	3/6/23/26	0/1/1/1
6	NAG	D	502	1	-	0/6/23/26	0/1/1/1
8	TRS	A	514	-	-	0/9/9/9	-
7	BGC	A	517	-	-	1/2/22/22	0/1/1/1

There are no bond length outliers.

All (12) bond angle outliers are listed below:

Mol	Chain	Res	Type	Atoms	Z	Observed(°)	Ideal(°)
6	I	511	NAG	O5-C1-C2	4.52	118.42	111.29
6	I	511	NAG	C1-O5-C5	4.38	118.13	112.19
6	I	506	NAG	C1-O5-C5	3.07	116.35	112.19
6	G	504	NAG	C1-O5-C5	2.93	116.16	112.19
6	I	501	NAG	C1-O5-C5	2.81	115.99	112.19
6	G	506	NAG	C1-O5-C5	2.55	115.64	112.19
6	I	510	NAG	C1-O5-C5	2.46	115.53	112.19
6	A	504	NAG	C1-O5-C5	2.32	115.33	112.19
6	G	505	NAG	C1-O5-C5	2.29	115.29	112.19
6	A	505	NAG	C1-O5-C5	2.22	115.20	112.19
6	I	501	NAG	O5-C1-C2	2.14	114.67	111.29
6	D	508	NAG	C1-O5-C5	2.04	114.95	112.19

There are no chirality outliers.

All (99) torsion outliers are listed below:

Mol	Chain	Res	Type	Atoms
6	G	501	NAG	C8-C7-N2-C2

Continued on next page...

*Continued from previous page...*

Mol	Chain	Res	Type	Atoms
6	G	501	NAG	O7-C7-N2-C2
6	G	502	NAG	C8-C7-N2-C2
6	G	502	NAG	O7-C7-N2-C2
6	G	504	NAG	C8-C7-N2-C2
6	G	504	NAG	O7-C7-N2-C2
6	G	509	NAG	C8-C7-N2-C2
6	G	509	NAG	O7-C7-N2-C2
6	G	511	NAG	C8-C7-N2-C2
6	G	511	NAG	O7-C7-N2-C2
6	A	503	NAG	C8-C7-N2-C2
6	A	503	NAG	O7-C7-N2-C2
6	A	504	NAG	C8-C7-N2-C2
6	A	504	NAG	O7-C7-N2-C2
6	A	506	NAG	C8-C7-N2-C2
6	A	506	NAG	O7-C7-N2-C2
6	A	507	NAG	C8-C7-N2-C2
6	A	507	NAG	O7-C7-N2-C2
6	A	509	NAG	C3-C2-N2-C7
6	A	509	NAG	C8-C7-N2-C2
6	A	509	NAG	O7-C7-N2-C2
6	A	511	NAG	C8-C7-N2-C2
6	A	511	NAG	O7-C7-N2-C2
6	D	503	NAG	C8-C7-N2-C2
6	D	503	NAG	O7-C7-N2-C2
6	D	506	NAG	C3-C2-N2-C7
6	D	506	NAG	C8-C7-N2-C2
6	D	506	NAG	O7-C7-N2-C2
6	D	508	NAG	C8-C7-N2-C2
6	D	508	NAG	O7-C7-N2-C2
6	D	509	NAG	O7-C7-N2-C2
6	I	502	NAG	C8-C7-N2-C2
6	I	502	NAG	O7-C7-N2-C2
6	I	505	NAG	C3-C2-N2-C7
6	I	505	NAG	C8-C7-N2-C2
6	I	505	NAG	O7-C7-N2-C2
6	I	507	NAG	C8-C7-N2-C2
6	I	507	NAG	O7-C7-N2-C2
6	I	510	NAG	C8-C7-N2-C2
6	I	510	NAG	O7-C7-N2-C2
6	I	511	NAG	C3-C2-N2-C7
8	A	513	TRS	N-C-C2-O2
8	I	514	TRS	N-C-C1-O1

*Continued on next page...*

*Continued from previous page...*

Mol	Chain	Res	Type	Atoms
6	D	509	NAG	C8-C7-N2-C2
6	I	508	NAG	C8-C7-N2-C2
6	I	508	NAG	O7-C7-N2-C2
6	D	512	NAG	C8-C7-N2-C2
6	G	504	NAG	O5-C5-C6-O6
6	G	505	NAG	C8-C7-N2-C2
6	A	502	NAG	C8-C7-N2-C2
6	A	512	NAG	C8-C7-N2-C2
6	D	511	NAG	C8-C7-N2-C2
6	G	505	NAG	O7-C7-N2-C2
6	G	510	NAG	C8-C7-N2-C2
6	G	510	NAG	O7-C7-N2-C2
6	A	501	NAG	C8-C7-N2-C2
6	A	501	NAG	O7-C7-N2-C2
6	A	502	NAG	O7-C7-N2-C2
6	A	505	NAG	C8-C7-N2-C2
6	A	505	NAG	O7-C7-N2-C2
6	A	512	NAG	O7-C7-N2-C2
6	D	505	NAG	C8-C7-N2-C2
6	D	505	NAG	O7-C7-N2-C2
6	D	511	NAG	O7-C7-N2-C2
6	D	512	NAG	O7-C7-N2-C2
6	I	511	NAG	C8-C7-N2-C2
6	A	506	NAG	O5-C5-C6-O6
6	G	504	NAG	C4-C5-C6-O6
7	J	502	BGC	O5-C5-C6-O6
6	I	504	NAG	C8-C7-N2-C2
6	I	511	NAG	O7-C7-N2-C2
6	A	508	NAG	C8-C7-N2-C2
6	I	507	NAG	O5-C5-C6-O6
6	I	509	NAG	C8-C7-N2-C2
6	I	508	NAG	O5-C5-C6-O6
7	A	518	BGC	O5-C5-C6-O6
6	I	509	NAG	O5-C5-C6-O6
7	B	302	BGC	O5-C5-C6-O6
6	I	504	NAG	O7-C7-N2-C2
7	A	517	BGC	O5-C5-C6-O6
6	G	508	NAG	O5-C5-C6-O6
7	I	512	BGC	O5-C5-C6-O6
6	A	509	NAG	O5-C5-C6-O6
6	A	512	NAG	O5-C5-C6-O6
6	I	502	NAG	O5-C5-C6-O6

*Continued on next page...*

*Continued from previous page...*

Mol	Chain	Res	Type	Atoms
6	I	510	NAG	O5-C5-C6-O6
6	A	508	NAG	O7-C7-N2-C2
6	G	508	NAG	C8-C7-N2-C2
6	I	509	NAG	O7-C7-N2-C2
6	A	506	NAG	C4-C5-C6-O6
6	G	503	NAG	C8-C7-N2-C2
8	A	513	TRS	C3-C-C2-O2
6	G	508	NAG	O7-C7-N2-C2
6	G	503	NAG	O7-C7-N2-C2
6	I	501	NAG	C8-C7-N2-C2
6	I	501	NAG	O7-C7-N2-C2
7	J	502	BGC	C4-C5-C6-O6
6	I	511	NAG	C1-C2-N2-C7
6	A	505	NAG	O5-C5-C6-O6

There are no ring outliers.

15 monomers are involved in 19 short contacts:

Mol	Chain	Res	Type	Clashes	Symm-Clashes
7	J	502	BGC	1	0
7	A	518	BGC	2	0
8	D	513	TRS	1	0
7	A	516	BGC	1	0
6	I	506	NAG	1	0
6	D	507	NAG	1	0
7	B	302	BGC	1	0
8	K	301	TRS	1	0
7	G	512	BGC	1	0
7	I	513	BGC	1	0
6	A	507	NAG	1	0
6	G	507	NAG	1	0
8	I	514	TRS	2	0
6	A	505	NAG	1	0
7	A	517	BGC	3	0

## 5.7 Other polymers

There are no such residues in this entry.



## 5.8 Polymer linkage issues

There are no chain breaks in this entry.

## 6 Fit of model and data [i](#)

### 6.1 Protein, DNA and RNA chains [i](#)

In the following table, the column labelled ‘#RSRZ> 2’ contains the number (and percentage) of RSRZ outliers, followed by percent RSRZ outliers for the chain as percentile scores relative to all X-ray entries and entries of similar resolution. The OWAB column contains the minimum, median, 95<sup>th</sup> percentile and maximum values of the occupancy-weighted average B-factor per residue. The column labelled ‘Q< 0.9’ lists the number of (and percentage) of residues with an average occupancy less than 0.9.

Mol	Chain	Analysed	<RSRZ>	#RSRZ>2	OWAB(Å <sup>2</sup> )	Q<0.9
1	A	349/353 (98%)	0.15	6 (1%) 70 71	55, 89, 141, 225	0
1	D	350/353 (99%)	0.22	12 (3%) 45 44	64, 97, 168, 273	0
1	G	347/353 (98%)	0.37	14 (4%) 38 36	68, 103, 160, 241	0
1	I	349/353 (98%)	0.40	27 (7%) 13 11	74, 118, 181, 249	0
2	B	224/224 (100%)	0.32	14 (6%) 20 18	59, 102, 172, 208	0
2	E	224/224 (100%)	1.84	61 (27%) 0 0	70, 118, 264, 292	0
2	H	224/224 (100%)	0.44	3 (1%) 77 78	59, 85, 117, 165	0
2	J	224/224 (100%)	0.16	4 (1%) 68 69	66, 101, 134, 202	0
3	C	210/210 (100%)	0.55	20 (9%) 8 6	61, 116, 173, 216	0
3	F	208/210 (99%)	2.07	83 (39%) 0 0	88, 181, 245, 270	0
3	K	210/210 (100%)	0.48	16 (7%) 13 11	78, 114, 163, 210	0
3	L	208/210 (99%)	0.40	20 (9%) 8 6	71, 112, 154, 228	0
All	All	3127/3148 (99%)	0.56	280 (8%) 9 7	55, 105, 206, 292	0

All (280) RSRZ outliers are listed below:

Mol	Chain	Res	Type	RSRZ
2	E	181	VAL	14.9
3	F	155	ALA	14.9
2	E	125	ALA	13.5
2	E	141	LEU	12.9
2	E	210	LYS	12.2
2	E	129	LYS	12.0
2	E	127	SER	12.0
2	E	194	TYR	11.7
2	E	180	SER	10.7
3	F	150	TRP	10.7
3	F	183	LEU	10.1

*Continued on next page...*

*Continued from previous page...*

<b>Mol</b>	<b>Chain</b>	<b>Res</b>	<b>Type</b>	<b>RSRZ</b>
3	F	134	VAL	10.0
3	F	151	LYS	9.7
3	F	119	ILE	9.7
3	F	207	VAL	9.1
3	F	135	VAL	8.9
3	F	120	PHE	8.9
3	F	206	PRO	8.7
2	E	136	ALA	8.7
3	F	198	VAL	8.6
2	E	158	ALA	8.4
2	E	211	ALA	8.3
2	E	184	VAL	8.2
2	E	191	THR	8.2
2	E	152	VAL	8.0
3	F	117	VAL	8.0
3	C	1	GLU	7.9
2	E	126	PRO	7.8
3	F	185	LYS	7.7
3	F	122	PRO	7.6
2	E	198	VAL	7.2
2	E	195	ILE	7.0
3	F	214	GLY	6.9
3	K	2	ILE	6.8
2	E	130	SER	6.7
2	E	122	PHE	6.5
2	E	128	SER	6.5
2	E	164	HIS	6.5
3	F	208	THR	6.4
3	F	196	CYS	6.4
3	F	182	THR	6.3
2	E	189	LEU	6.3
3	F	136	CYS	6.0
3	F	205	SER	6.0
2	E	159	LEU	6.0
2	E	212	GLU	6.0
3	F	197	GLU	5.9
1	I	379	ARG	5.9
3	F	210	SER	5.8
3	F	118	PHE	5.8
2	E	142	VAL	5.7
3	F	123	SER	5.7
3	K	1	GLU	5.6

*Continued on next page...*

*Continued from previous page...*

<b>Mol</b>	<b>Chain</b>	<b>Res</b>	<b>Type</b>	<b>RSRZ</b>
2	E	124	LEU	5.6
3	F	156	LEU	5.5
3	F	124	ASP	5.5
3	F	133	SER	5.5
2	E	207	VAL	5.4
2	E	196	CYS	5.4
2	E	120	SER	5.3
3	F	154	ASN	5.3
2	E	190	GLY	5.2
2	E	209	LYS	5.2
2	E	179	SER	5.2
2	E	156	SER	5.2
2	E	208	ASP	5.2
3	L	204	ARG	5.1
3	F	193	VAL	5.1
3	C	186	ALA	5.0
2	E	197	ASN	5.0
3	F	121	PRO	4.9
3	F	138	LEU	4.9
2	E	162	GLY	4.7
2	E	193	THR	4.6
3	C	171	LYS	4.6
2	B	125	ALA	4.6
3	C	203	LEU	4.6
3	K	135	VAL	4.6
1	G	407	MET	4.5
3	L	216	CYS	4.5
3	F	148	VAL	4.5
2	E	150	VAL	4.5
2	E	160	THR	4.5
3	F	177	LEU	4.5
3	F	204	ARG	4.4
3	F	209	LYS	4.4
3	F	129	SER	4.4
2	B	132	SER	4.3
3	F	152	VAL	4.3
2	B	138	LEU	4.2
2	E	140	CYS	4.2
3	F	203	LEU	4.2
3	K	203	LEU	4.2
3	L	156	LEU	4.2
2	E	133	GLY	4.2

*Continued on next page...*

*Continued from previous page...*

<b>Mol</b>	<b>Chain</b>	<b>Res</b>	<b>Type</b>	<b>RSRZ</b>
3	F	144	ARG	4.2
2	E	199	ASN	4.2
3	K	148	VAL	4.2
2	E	123	PRO	4.1
3	K	198	VAL	4.1
1	I	349	LEU	4.1
3	F	184	SER	4.0
3	L	186	ALA	4.0
3	F	199	THR	4.0
3	K	151	LYS	4.0
3	F	194	TYR	4.0
1	I	452	ILE	4.0
3	K	207	VAL	4.0
2	E	121	VAL	3.8
3	C	204	ARG	3.8
3	F	195	ALA	3.8
1	I	259	LEU	3.8
2	E	178	LEU	3.7
1	A	322	SER	3.7
3	C	188	TYR	3.7
3	K	119	ILE	3.7
2	B	146	PHE	3.7
2	E	154	TRP	3.6
3	F	147	LYS	3.6
1	I	302	GLY	3.6
3	F	165	VAL	3.6
3	F	202	GLY	3.6
3	F	116	SER	3.5
3	F	128	LYS	3.5
1	D	322	SER	3.5
2	E	149	PRO	3.5
2	E	182	VAL	3.5
3	C	146	ALA	3.4
1	I	93	PHE	3.4
3	C	120	PHE	3.3
3	C	151	LYS	3.3
3	F	201	GLN	3.3
1	I	491	ILE	3.3
2	E	161	SER	3.3
1	I	272	ILE	3.3
3	F	159	GLY	3.3
2	E	138	LEU	3.3

*Continued on next page...*

*Continued from previous page...*

<b>Mol</b>	<b>Chain</b>	<b>Res</b>	<b>Type</b>	<b>RSRZ</b>
1	I	45	TRP	3.3
3	F	145	GLU	3.2
3	K	216	CYS	3.2
1	D	349	LEU	3.2
1	I	277	LEU	3.1
3	C	189	GLU	3.1
3	L	213	ARG	3.1
3	F	130	GLY	3.0
3	F	175	TYR	3.0
3	F	137	LEU	3.0
3	L	192	LYS	3.0
3	F	18	THR	2.9
3	C	137	LEU	2.9
2	E	213	PRO	2.9
3	F	47	VAL	2.9
1	G	492	GLU	2.9
1	D	337	LYS	2.9
3	L	188	TYR	2.9
3	F	132	ALA	2.9
3	F	67	TRP	2.8
3	L	152	VAL	2.8
1	A	408	LYS	2.8
1	D	396	ILE	2.8
1	D	321	GLY	2.8
3	F	19	ALA	2.8
2	E	166	PHE	2.8
3	F	13	LEU	2.8
3	F	181	LEU	2.8
3	F	188	TYR	2.8
3	F	58	ILE	2.8
3	C	202	GLY	2.8
1	D	407	MET	2.7
3	L	214	GLY	2.7
3	C	2	ILE	2.7
2	B	202	PRO	2.7
3	F	115	PRO	2.7
3	F	28	TYR	2.7
3	F	107	ASP	2.7
2	E	216	CYS	2.7
3	L	190	LYS	2.7
3	F	215	GLU	2.7
3	L	78	LEU	2.7

*Continued on next page...*

*Continued from previous page...*

<b>Mol</b>	<b>Chain</b>	<b>Res</b>	<b>Type</b>	<b>RSRZ</b>
3	L	183	LEU	2.7
3	F	131	THR	2.7
3	F	189	GLU	2.7
2	E	192	GLN	2.7
3	K	202	GLY	2.6
3	F	200	HIS	2.6
1	I	86	LEU	2.6
2	E	163	VAL	2.6
2	B	126	PRO	2.6
2	J	189	LEU	2.6
2	B	152	VAL	2.6
1	D	353	PHE	2.6
3	C	207	VAL	2.5
1	G	361	PHE	2.5
1	I	453	LEU	2.5
3	F	149	GLN	2.5
3	K	195	ALA	2.5
2	E	119	PRO	2.5
2	E	157	GLY	2.5
1	A	328	LYS	2.5
1	I	226	LEU	2.4
3	K	204	ARG	2.4
1	G	420	ILE	2.4
1	I	225	ILE	2.4
1	I	390	LEU	2.4
3	F	108	ILE	2.4
1	G	57	ASP	2.4
1	I	461	ASN	2.4
3	F	143	PRO	2.4
2	B	129	LYS	2.4
2	B	117	LYS	2.4
2	B	133	GLY	2.4
2	E	146	PHE	2.4
3	F	161	SER	2.4
3	F	83	PHE	2.4
2	B	214	LYS	2.4
1	G	324	GLY	2.3
1	I	245	VAL	2.3
3	C	135	VAL	2.3
1	I	244	SER	2.3
1	I	369	LEU	2.3
3	C	113	ALA	2.3

*Continued on next page...*

*Continued from previous page...*

<b>Mol</b>	<b>Chain</b>	<b>Res</b>	<b>Type</b>	<b>RSRZ</b>
1	I	84	ILE	2.3
3	F	48	ILE	2.3
1	I	361	PHE	2.3
1	I	324	GLY	2.3
3	F	9	GLY	2.3
2	J	121	VAL	2.3
3	C	67	TRP	2.3
1	G	225	ILE	2.3
1	G	389	GLN	2.3
3	F	176	SER	2.3
2	B	118	GLY	2.2
2	J	63	LEU	2.2
1	G	327	ARG	2.2
3	L	159	GLY	2.2
1	I	488	VAL	2.2
3	C	198	VAL	2.2
3	C	183	LEU	2.2
3	F	62	PHE	2.2
1	G	301	ASN	2.2
1	I	301	ASN	2.2
2	B	127	SER	2.2
1	A	473	GLY	2.2
3	L	4	LEU	2.2
3	L	189	GLU	2.2
2	H	68	THR	2.2
3	L	21	ILE	2.2
3	L	155	ALA	2.2
3	F	216	CYS	2.2
2	E	135	THR	2.1
2	E	151	THR	2.1
1	G	272	ILE	2.1
1	G	359	ILE	2.1
3	K	69	PRO	2.1
1	D	286	VAL	2.1
1	G	226	LEU	2.1
3	F	76	SER	2.1
1	I	292	VAL	2.1
3	K	47	VAL	2.1
3	F	75	ILE	2.1
1	G	58	ALA	2.1
2	J	129	LYS	2.1
3	L	193	VAL	2.1

*Continued on next page...*



*Continued from previous page...*

Mol	Chain	Res	Type	RSRZ
1	D	330	TYR	2.1
1	A	268	GLU	2.1
1	D	270	ILE	2.1
1	I	72	HIS	2.1
3	C	47	VAL	2.1
3	K	128	LYS	2.1
1	A	59	LYS	2.0
2	B	189	LEU	2.0
3	L	47	VAL	2.0
3	F	186	ALA	2.0
2	H	17	SER	2.0
2	E	153	SER	2.0
3	L	151	LYS	2.0
1	D	277	LEU	2.0
2	H	189	LEU	2.0
1	I	100	MET	2.0
1	D	390	LEU	2.0

## 6.2 Non-standard residues in protein, DNA, RNA chains [i](#)

There are no non-standard protein/DNA/RNA residues in this entry.

## 6.3 Carbohydrates [i](#)

In the following table, the Atoms column lists the number of modelled atoms in the group and the number defined in the chemical component dictionary. The B-factors column lists the minimum, median, 95<sup>th</sup> percentile and maximum values of B factors of atoms in the group. The column labelled 'Q< 0.9' lists the number of atoms with occupancy less than 0.9.

Mol	Type	Chain	Res	Atoms	RSCC	RSR	B-factors(Å <sup>2</sup> )	Q<0.9
4	BMA	P	3	11/12	0.24	0.23	230,237,239,242	0
4	BMA	M	3	11/12	0.53	0.33	211,219,224,230	0
4	MAN	M	5	11/12	0.58	0.44	209,235,239,239	0
4	BMA	N	3	11/12	0.65	0.22	211,218,224,225	0
4	NAG	P	2	14/15	0.71	0.30	118,182,200,219	0
4	MAN	M	4	11/12	0.75	0.29	159,191,200,207	0
4	MAN	P	4	11/12	0.78	0.38	217,221,232,232	0
4	MAN	N	4	11/12	0.79	0.27	188,198,216,216	0
4	MAN	P	5	11/12	0.79	0.27	216,236,238,239	0
4	MAN	N	5	11/12	0.80	0.15	202,209,216,216	0
4	NAG	P	1	14/15	0.86	0.21	116,142,167,186	0

*Continued on next page...*

Continued from previous page...

Mol	Type	Chain	Res	Atoms	RSCC	RSR	B-factors( $\text{\AA}^2$ )	Q<0.9
4	NAG	N	2	14/15	0.87	0.23	125,168,183,204	0
4	NAG	M	2	14/15	0.88	0.17	158,179,191,206	0
5	NAG	O	2	14/15	0.89	0.27	190,206,214,217	0
5	NAG	O	1	14/15	0.90	0.25	144,174,187,199	0
4	NAG	M	1	14/15	0.92	0.17	125,143,162,176	0
4	NAG	N	1	14/15	0.94	0.12	102,112,125,146	0

The following is a graphical depiction of the model fit to experimental electron density for oligosaccharide. Each fit is shown from different orientation to approximate a three-dimensional view.

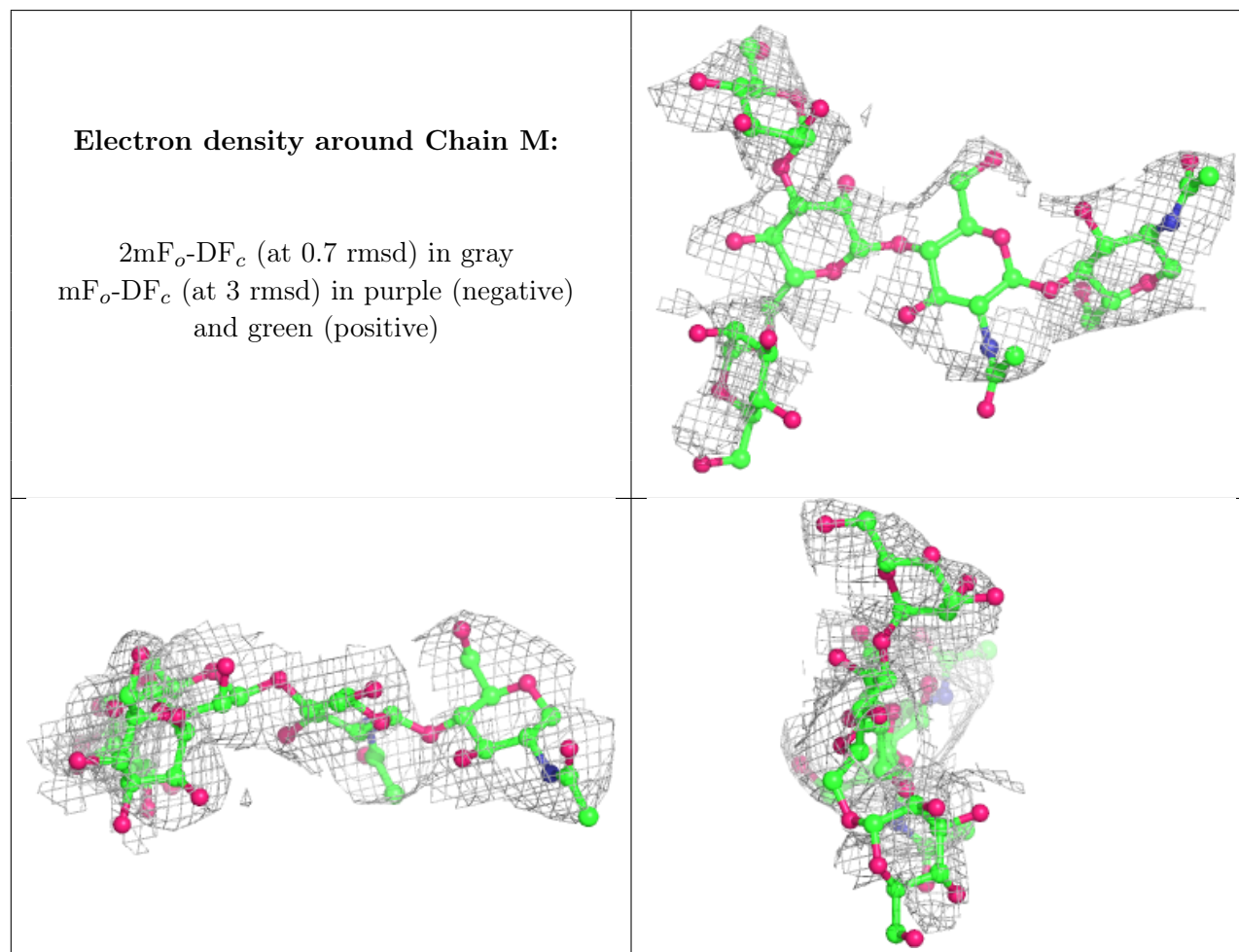

**Electron density around Chain N:**

$2mF_o-DF_c$  (at 0.7 rmsd) in gray  
 $mF_o-DF_c$  (at 3 rmsd) in purple (negative)  
and green (positive)

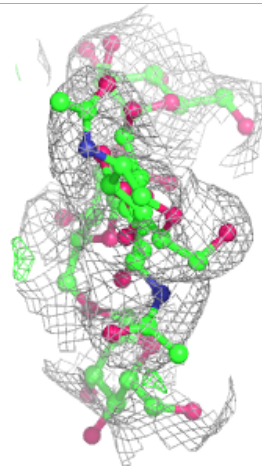
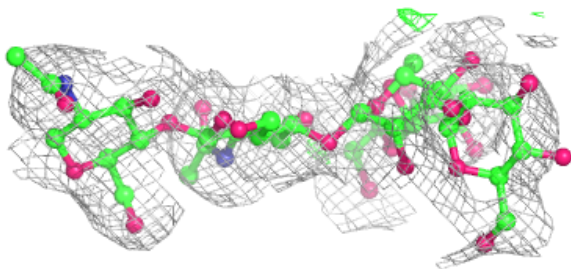
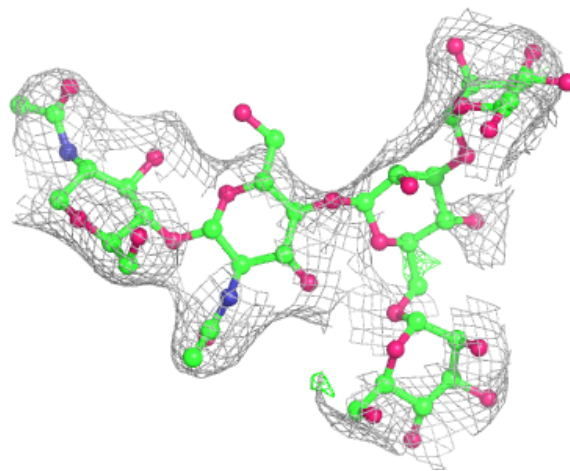

**Electron density around Chain P:**

$2mF_o-DF_c$  (at 0.7 rmsd) in gray  
 $mF_o-DF_c$  (at 3 rmsd) in purple (negative)  
and green (positive)

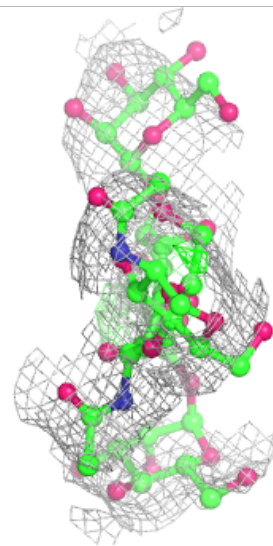
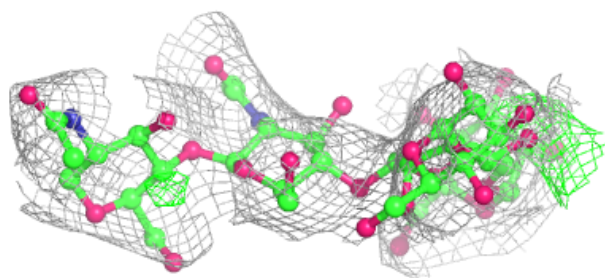
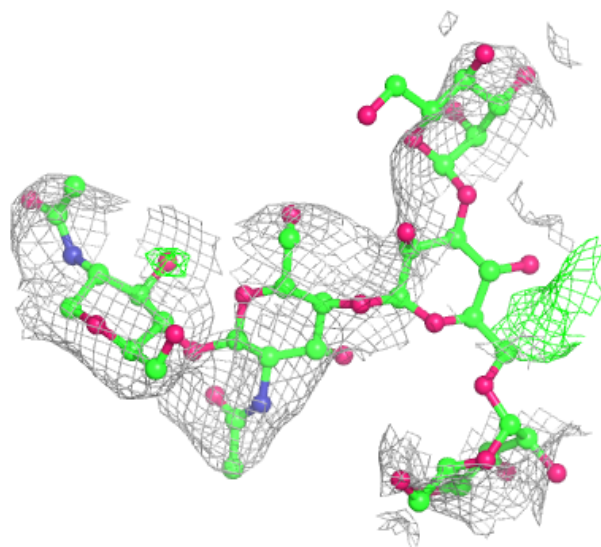

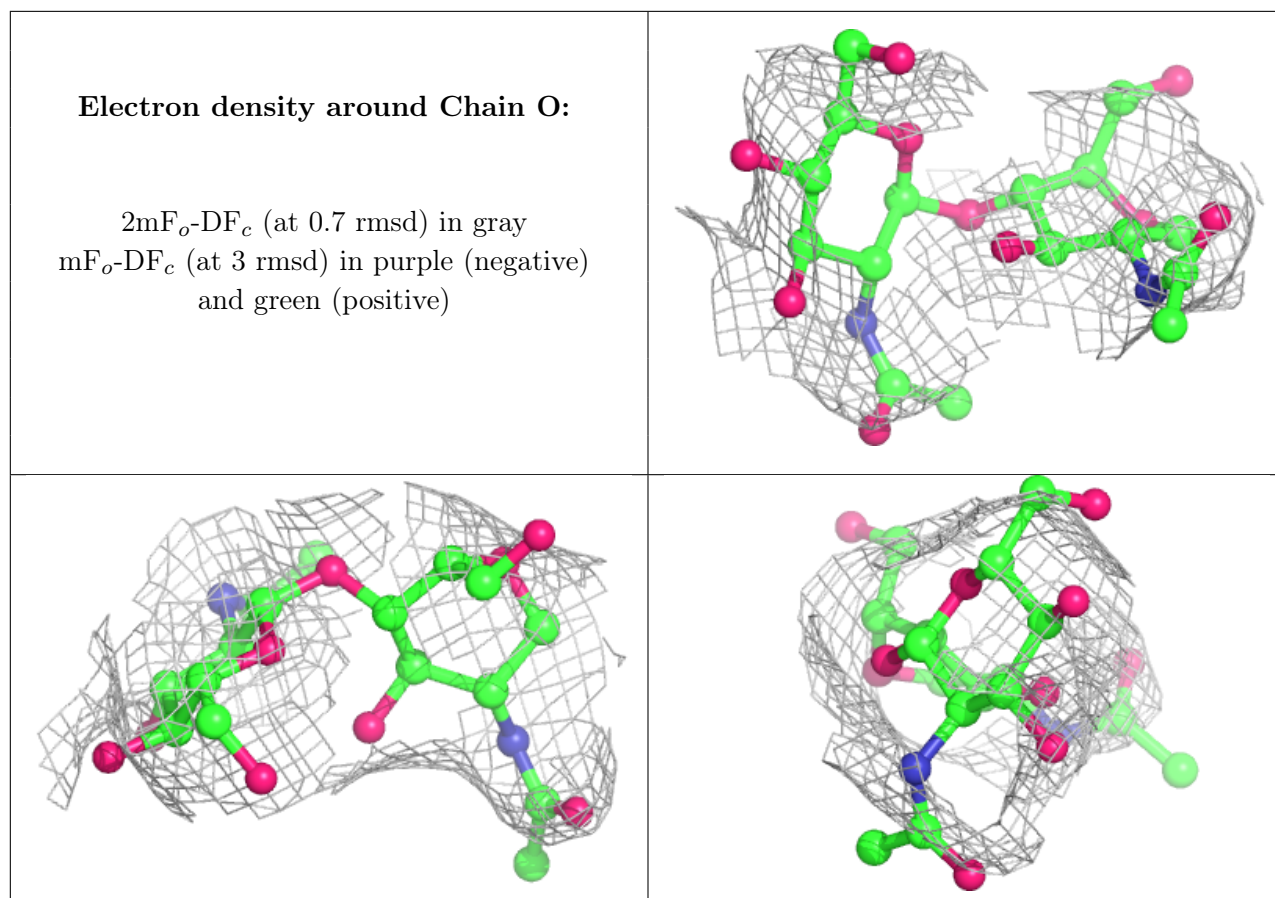

## 6.4 Ligands [i](#)

In the following table, the Atoms column lists the number of modelled atoms in the group and the number defined in the chemical component dictionary. The B-factors column lists the minimum, median, 95<sup>th</sup> percentile and maximum values of B factors of atoms in the group. The column labelled 'Q< 0.9' lists the number of atoms with occupancy less than 0.9.

Mol	Type	Chain	Res	Atoms	RSCC	RSR	B-factors(Å <sup>2</sup> )	Q<0.9
7	BGC	J	502	12/12	0.38	0.29	197,218,223,223	0
7	BGC	C	301	12/12	0.59	0.20	197,212,216,216	0
8	TRS	K	301	8/8	0.60	0.42	164,183,188,188	0
7	BGC	D	515	12/12	0.61	0.36	162,179,185,185	0
7	BGC	A	517	12/12	0.63	0.49	179,199,203,205	0
8	TRS	A	514	8/8	0.66	0.21	156,167,171,172	0
7	BGC	A	515	12/12	0.66	0.28	161,182,188,188	0
7	BGC	E	301	12/12	0.68	0.30	162,194,197,198	0
6	NAG	D	501	14/15	0.69	0.46	193,207,215,219	0
7	BGC	G	512	12/12	0.75	0.27	92,146,155,156	0
6	NAG	A	509	14/15	0.77	0.43	191,212,221,221	0
6	NAG	I	501	14/15	0.77	0.33	167,178,186,187	0
7	BGC	I	513	12/12	0.77	0.27	136,156,176,178	0

*Continued on next page...*

Continued from previous page...

Mol	Type	Chain	Res	Atoms	RSCC	RSR	B-factors( $\text{\AA}^2$ )	Q<0.9
6	NAG	D	503	14/15	0.79	0.47	176,190,202,207	0
7	BGC	B	301	12/12	0.80	0.25	140,182,188,189	0
6	NAG	I	503	14/15	0.81	0.19	149,180,190,191	0
6	NAG	A	505	14/15	0.83	0.27	98,128,144,144	0
8	TRS	D	514	8/8	0.83	0.28	108,137,143,151	0
7	BGC	I	512	12/12	0.83	0.33	208,216,220,220	0
7	BGC	A	516	12/12	0.85	0.13	113,153,160,160	0
7	BGC	A	518	12/12	0.85	0.34	141,162,172,177	0
6	NAG	D	509	14/15	0.86	0.22	170,185,192,193	0
6	NAG	G	501	14/15	0.86	0.28	159,171,176,177	0
6	NAG	G	511	14/15	0.86	0.22	153,173,179,179	0
6	NAG	D	505	14/15	0.88	0.23	126,154,166,168	0
6	NAG	G	503	14/15	0.88	0.18	143,160,167,171	0
7	BGC	B	302	12/12	0.88	0.18	114,145,150,152	0
6	NAG	A	511	14/15	0.89	0.17	123,151,163,164	0
6	NAG	I	505	14/15	0.89	0.19	146,173,183,184	0
8	TRS	J	501	8/8	0.89	0.22	125,145,154,155	0
6	NAG	D	508	14/15	0.89	0.23	116,132,139,144	0
6	NAG	D	512	14/15	0.90	0.15	129,149,163,168	0
6	NAG	I	508	14/15	0.90	0.17	124,151,159,166	0
6	NAG	I	511	14/15	0.90	0.21	152,171,176,185	0
6	NAG	A	503	14/15	0.90	0.12	105,126,137,138	0
6	NAG	D	511	14/15	0.90	0.22	134,145,164,165	0
6	NAG	G	509	14/15	0.91	0.24	94,111,128,136	0
6	NAG	G	507	14/15	0.91	0.13	97,123,136,139	0
6	NAG	A	512	14/15	0.91	0.29	152,166,176,182	0
6	NAG	A	507	14/15	0.91	0.16	109,120,136,142	0
6	NAG	I	507	14/15	0.92	0.22	98,133,154,155	0
6	NAG	A	508	14/15	0.92	0.14	122,135,148,151	0
6	NAG	A	510	14/15	0.93	0.18	72,86,111,112	0
6	NAG	G	505	14/15	0.93	0.16	120,140,150,156	0
6	NAG	I	510	14/15	0.93	0.21	149,165,177,179	0
6	NAG	I	502	14/15	0.93	0.17	116,136,144,147	0
6	NAG	D	510	14/15	0.93	0.17	82,103,121,122	0
6	NAG	G	506	14/15	0.93	0.16	110,116,129,134	0
6	NAG	I	506	14/15	0.93	0.18	120,132,137,142	0
8	TRS	I	514	8/8	0.94	0.13	113,126,128,130	0
8	TRS	D	513	8/8	0.94	0.17	84,102,120,123	0
6	NAG	D	506	14/15	0.94	0.17	105,121,137,138	0
6	NAG	I	509	14/15	0.95	0.14	102,127,140,149	0
8	TRS	A	513	8/8	0.95	0.18	98,108,120,124	0
6	NAG	G	508	14/15	0.95	0.12	136,145,179,186	0

Continued on next page...

*Continued from previous page...*

Mol	Type	Chain	Res	Atoms	RSCC	RSR	B-factors( $\text{\AA}^2$ )	Q<0.9
6	NAG	D	504	14/15	0.95	0.16	79,88,99,100	0
6	NAG	A	506	14/15	0.96	0.15	79,90,111,126	0
6	NAG	A	502	14/15	0.96	0.25	79,103,109,113	0
6	NAG	I	504	14/15	0.96	0.22	98,113,118,123	0
6	NAG	G	510	14/15	0.96	0.14	71,107,123,133	0
6	NAG	G	502	14/15	0.96	0.13	91,106,120,120	0
6	NAG	D	502	14/15	0.96	0.19	108,119,137,140	0
6	NAG	A	504	14/15	0.97	0.13	80,90,107,107	0
6	NAG	G	504	14/15	0.97	0.20	80,91,111,118	0
6	NAG	A	501	14/15	0.97	0.12	63,79,89,90	0
6	NAG	D	507	14/15	0.97	0.16	86,107,115,121	0

## 6.5 Other polymers [\(i\)](#)

There are no such residues in this entry.