



Full wwPDB X-ray Structure Validation Report ⓘ

Sep 12, 2023 – 07:39 AM EDT

PDB ID : 4NKX
Title : Human steroidogenic cytochrome P450 17A1 mutant A105L with substrate progesterone
Authors : Scott, E.E.; Petrunak, E.M.
Deposited on : 2013-11-13
Resolution : 2.79 Å(reported)

This is a Full wwPDB X-ray Structure Validation Report for a publicly released PDB entry.

We welcome your comments at validation@mail.wwpdb.org

A user guide is available at

<https://www.wwpdb.org/validation/2017/XrayValidationReportHelp>

with specific help available everywhere you see the ⓘ symbol.

The types of validation reports are described at

<http://www.wwpdb.org/validation/2017/FAQs#types>.

The following versions of software and data (see [references ⓘ](#)) were used in the production of this report:

MolProbity : 4.02b-467
Mogul : 1.8.5 (274361), CSD as541be (2020)
Xtrriage (Phenix) : 1.13
EDS : 2.35.1
buster-report : 1.1.7 (2018)
Percentile statistics : 20191225.v01 (using entries in the PDB archive December 25th 2019)
Refmac : 5.8.0158
CCP4 : 7.0.044 (Gargrove)
Ideal geometry (proteins) : Engh & Huber (2001)
Ideal geometry (DNA, RNA) : Parkinson et al. (1996)
Validation Pipeline (wwPDB-VP) : 2.35.1

1 Overall quality at a glance

The following experimental techniques were used to determine the structure:

X-RAY DIFFRACTION

The reported resolution of this entry is 2.79 Å.

Percentile scores (ranging between 0-100) for global validation metrics of the entry are shown in the following graphic. The table shows the number of entries on which the scores are based.

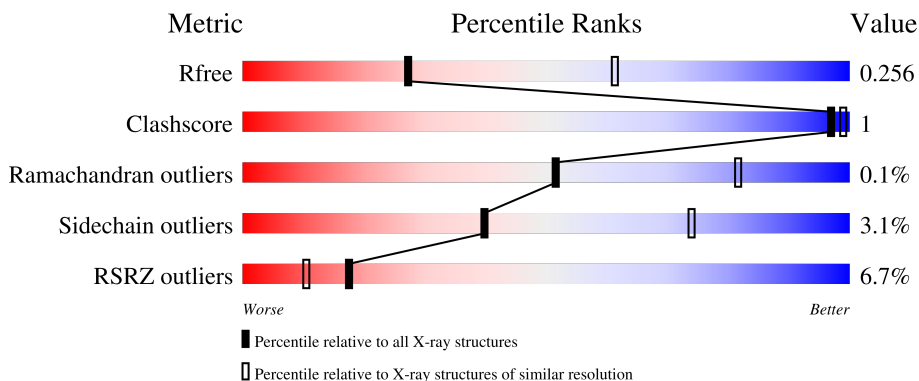

Metric	Whole archive (#Entries)	Similar resolution (#Entries, resolution range(Å))
R_{free}	130704	3140 (2.80-2.80)
Clashscore	141614	3569 (2.80-2.80)
Ramachandran outliers	138981	3498 (2.80-2.80)
Sidechain outliers	138945	3500 (2.80-2.80)
RSRZ outliers	127900	3078 (2.80-2.80)

The table below summarises the geometric issues observed across the polymeric chains and their fit to the electron density. The red, orange, yellow and green segments of the lower bar indicate the fraction of residues that contain outliers for ≥ 3 , 2, 1 and 0 types of geometric quality criteria respectively. A grey segment represents the fraction of residues that are not modelled. The numeric value for each fraction is indicated below the corresponding segment, with a dot representing fractions $\leq 5\%$. The upper red bar (where present) indicates the fraction of residues that have poor fit to the electron density. The numeric value is given above the bar.

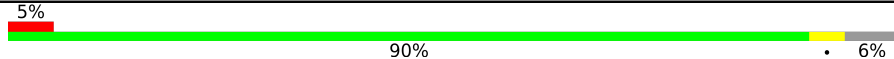
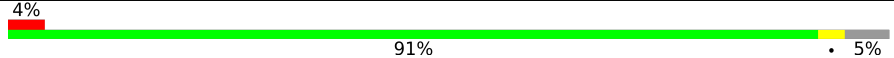
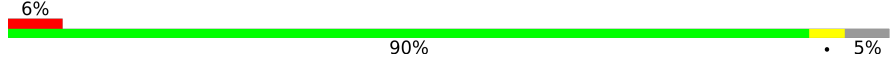
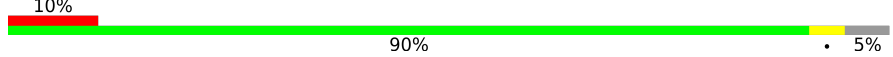
Mol	Chain	Length	Quality of chain
1	A	494	
1	B	494	
1	C	494	
1	D	494	

2 Entry composition [i](#)

There are 4 unique types of molecules in this entry. The entry contains 30719 atoms, of which 15484 are hydrogens and 0 are deuteriums.

In the tables below, the ZeroOcc column contains the number of atoms modelled with zero occupancy, the AltConf column contains the number of residues with at least one atom in alternate conformation and the Trace column contains the number of residues modelled with at most 2 atoms.

- Molecule 1 is a protein called Steroid 17-alpha-hydroxylase/17,20 lyase.

Mol	Chain	Residues	Atoms					ZeroOcc	AltConf	Trace	
			Total	C	H	N	O				S
1	A	466	7526	2387	3809	643	672	15	0	0	0
1	B	468	7549	2394	3817	646	677	15	0	0	0
1	C	469	7550	2398	3810	647	680	15	0	0	0
1	D	468	7544	2396	3808	646	679	15	0	0	0

There are 40 discrepancies between the modelled and reference sequences:

Chain	Residue	Modelled	Actual	Comment	Reference
A	19	MET	-	expression tag	UNP P05093
A	20	ALA	-	expression tag	UNP P05093
A	21	LYS	-	expression tag	UNP P05093
A	22	LYS	-	expression tag	UNP P05093
A	23	THR	-	expression tag	UNP P05093
A	105	LEU	ALA	engineered mutation	UNP P05093
A	509	HIS	-	expression tag	UNP P05093
A	510	HIS	-	expression tag	UNP P05093
A	511	HIS	-	expression tag	UNP P05093
A	512	HIS	-	expression tag	UNP P05093
B	19	MET	-	expression tag	UNP P05093
B	20	ALA	-	expression tag	UNP P05093
B	21	LYS	-	expression tag	UNP P05093
B	22	LYS	-	expression tag	UNP P05093
B	23	THR	-	expression tag	UNP P05093
B	105	LEU	ALA	engineered mutation	UNP P05093
B	509	HIS	-	expression tag	UNP P05093
B	510	HIS	-	expression tag	UNP P05093
B	511	HIS	-	expression tag	UNP P05093
B	512	HIS	-	expression tag	UNP P05093
C	19	MET	-	expression tag	UNP P05093

Continued on next page...

Continued from previous page...

Chain	Residue	Modelled	Actual	Comment	Reference
C	20	ALA	-	expression tag	UNP P05093
C	21	LYS	-	expression tag	UNP P05093
C	22	LYS	-	expression tag	UNP P05093
C	23	THR	-	expression tag	UNP P05093
C	105	LEU	ALA	engineered mutation	UNP P05093
C	509	HIS	-	expression tag	UNP P05093
C	510	HIS	-	expression tag	UNP P05093
C	511	HIS	-	expression tag	UNP P05093
C	512	HIS	-	expression tag	UNP P05093
D	19	MET	-	expression tag	UNP P05093
D	20	ALA	-	expression tag	UNP P05093
D	21	LYS	-	expression tag	UNP P05093
D	22	LYS	-	expression tag	UNP P05093
D	23	THR	-	expression tag	UNP P05093
D	105	LEU	ALA	engineered mutation	UNP P05093
D	509	HIS	-	expression tag	UNP P05093
D	510	HIS	-	expression tag	UNP P05093
D	511	HIS	-	expression tag	UNP P05093
D	512	HIS	-	expression tag	UNP P05093

- Molecule 2 is PROTOPORPHYRIN IX CONTAINING FE (three-letter code: HEM) (formula: $C_{34}H_{32}FeN_4O_4$).

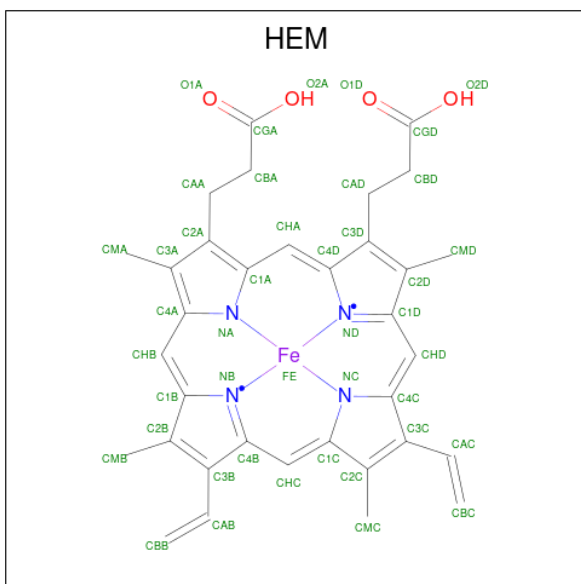

Mol	Chain	Residues	Atoms					ZeroOcc	AltConf	
			Total	C	Fe	H	N			O
2	A	1	73	34	1	30	4	4	0	0

Continued on next page...

Continued from previous page...

Mol	Chain	Residues	Atoms					ZeroOcc	AltConf	
2	B	1	Total	C	Fe	H	N	O	0	0
			73	34	1	30	4	4		
2	C	1	Total	C	Fe	H	N	O	0	0
			73	34	1	30	4	4		
2	D	1	Total	C	Fe	H	N	O	0	0
			73	34	1	30	4	4		

- Molecule 3 is PROGESTERONE (three-letter code: STR) (formula: $C_{21}H_{30}O_2$).

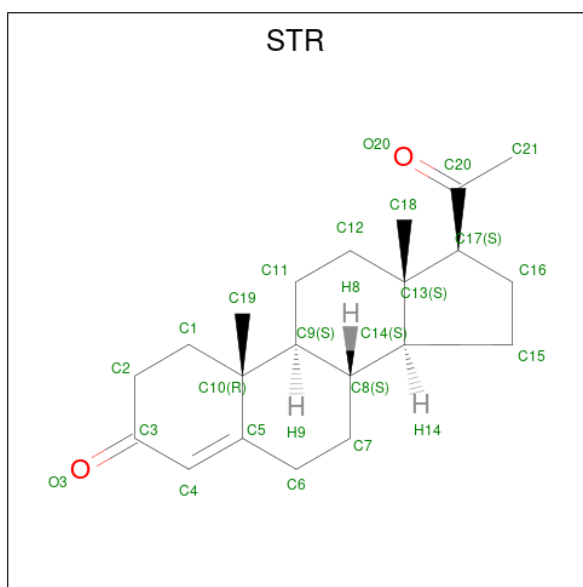

Mol	Chain	Residues	Atoms			ZeroOcc	AltConf	
3	A	1	Total	C	H	O	0	0
			53	21	30	2		
3	B	1	Total	C	H	O	0	0
			53	21	30	2		
3	C	1	Total	C	H	O	0	0
			53	21	30	2		
3	D	1	Total	C	H	O	0	0
			53	21	30	2		

- Molecule 4 is water.

Mol	Chain	Residues	Atoms		ZeroOcc	AltConf
4	A	14	Total	O	0	0
			14	14		
4	B	13	Total	O	0	0
			13	13		

Continued on next page...

Continued from previous page...

Mol	Chain	Residues	Atoms	ZeroOcc	AltConf
4	C	10	Total O 10 10	0	0
4	D	9	Total O 9 9	0	0

3 Residue-property plots [i](#)

These plots are drawn for all protein, RNA, DNA and oligosaccharide chains in the entry. The first graphic for a chain summarises the proportions of the various outlier classes displayed in the second graphic. The second graphic shows the sequence view annotated by issues in geometry and electron density. Residues are color-coded according to the number of geometric quality criteria for which they contain at least one outlier: green = 0, yellow = 1, orange = 2 and red = 3 or more. A red dot above a residue indicates a poor fit to the electron density ($RSRZ > 2$). Stretches of 2 or more consecutive residues without any outlier are shown as a green connector. Residues present in the sample, but not in the model, are shown in grey.

- Molecule 1: Steroid 17-alpha-hydroxylase/17,20 lyase

Chain A: 

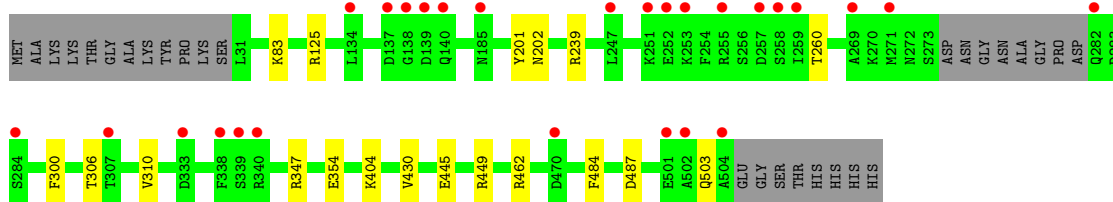

- Molecule 1: Steroid 17-alpha-hydroxylase/17,20 lyase

Chain B: 

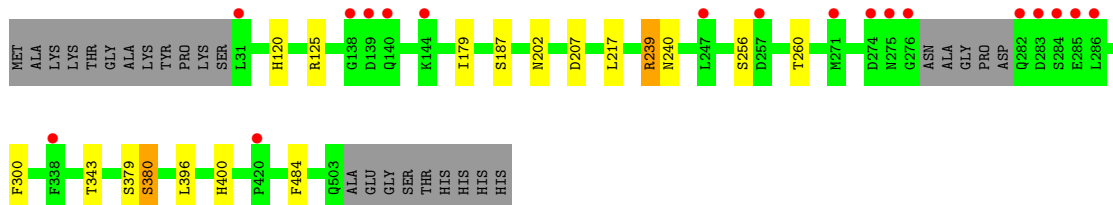

- Molecule 1: Steroid 17-alpha-hydroxylase/17,20 lyase

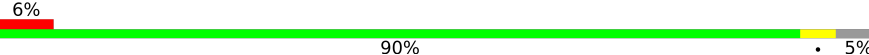
Chain C: 

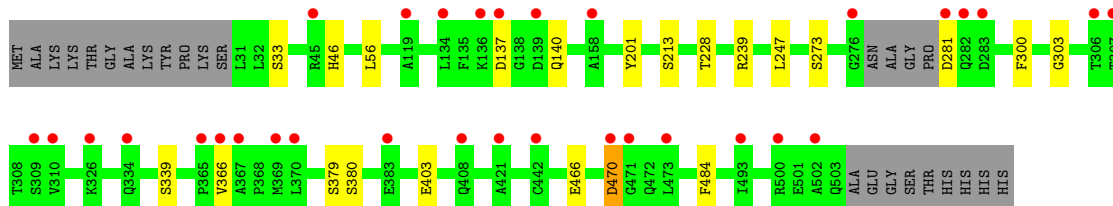

- Molecule 1: Steroid 17-alpha-hydroxylase/17,20 lyase

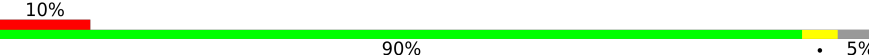
Chain D: 

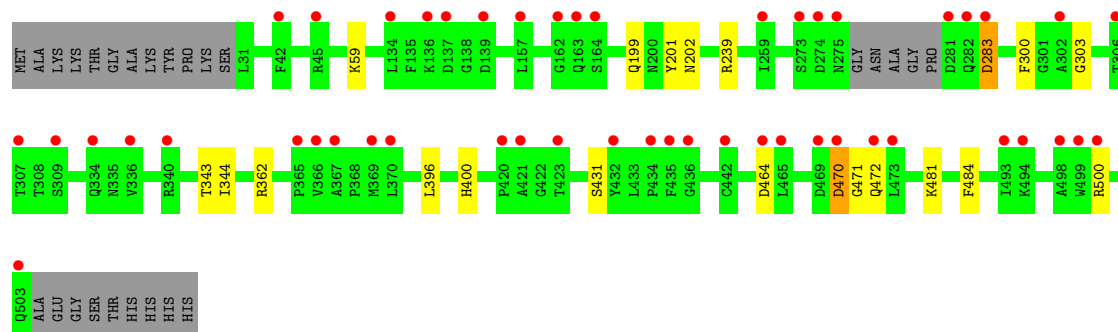

4 Data and refinement statistics

Property	Value	Source
Space group	P 21 21 21	Depositor
Cell constants a, b, c, α , β , γ	85.93Å 153.04Å 173.24Å 90.00° 90.00° 90.00°	Depositor
Resolution (Å)	39.13 – 2.79 39.13 – 2.79	Depositor EDS
% Data completeness (in resolution range)	99.0 (39.13-2.79) 99.1 (39.13-2.79)	Depositor EDS
R_{merge}	(Not available)	Depositor
R_{sym}	(Not available)	Depositor
$\langle I/\sigma(I) \rangle$ ¹	1.79 (at 2.81Å)	Xtrriage
Refinement program	PHENIX (phenix.refine: 1.8.2_1309)	Depositor
R, R_{free}	0.184 , 0.257 0.187 , 0.256	Depositor DCC
R_{free} test set	2886 reflections (5.07%)	wwPDB-VP
Wilson B-factor (Å ²)	58.1	Xtrriage
Anisotropy	0.418	Xtrriage
Bulk solvent k_{sol} (e/Å ³), B_{sol} (Å ²)	0.41 , 49.1	EDS
L-test for twinning ²	$\langle L \rangle = 0.48$, $\langle L^2 \rangle = 0.31$	Xtrriage
Estimated twinning fraction	No twinning to report.	Xtrriage
F_o, F_c correlation	0.95	EDS
Total number of atoms	30719	wwPDB-VP
Average B, all atoms (Å ²)	59.0	wwPDB-VP

Xtrriage's analysis on translational NCS is as follows: *The analyses of the Patterson function reveals a significant off-origin peak that is 39.90 % of the origin peak, indicating pseudo-translational symmetry. The chance of finding a peak of this or larger height randomly in a structure without pseudo-translational symmetry is equal to 2.9624e-04. The detected translational NCS is most likely also responsible for the elevated intensity ratio.*

¹Intensities estimated from amplitudes.

²Theoretical values of $\langle |L| \rangle$, $\langle L^2 \rangle$ for acentric reflections are 0.5, 0.333 respectively for untwinned datasets, and 0.375, 0.2 for perfectly twinned datasets.

5 Model quality [i](#)

5.1 Standard geometry [i](#)

Bond lengths and bond angles in the following residue types are not validated in this section: HEM, STR

The Z score for a bond length (or angle) is the number of standard deviations the observed value is removed from the expected value. A bond length (or angle) with $|Z| > 5$ is considered an outlier worth inspection. RMSZ is the root-mean-square of all Z scores of the bond lengths (or angles).

Mol	Chain	Bond lengths		Bond angles	
		RMSZ	# Z >5	RMSZ	# Z >5
1	A	0.39	0/3797	0.52	0/5140
1	B	0.40	0/3812	0.52	0/5160
1	C	0.39	0/3820	0.52	0/5171
1	D	0.38	0/3816	0.53	0/5166
All	All	0.39	0/15245	0.52	0/20637

There are no bond length outliers.

There are no bond angle outliers.

There are no chirality outliers.

There are no planarity outliers.

5.2 Too-close contacts [i](#)

In the following table, the Non-H and H(model) columns list the number of non-hydrogen atoms and hydrogen atoms in the chain respectively. The H(added) column lists the number of hydrogen atoms added and optimized by MolProbity. The Clashes column lists the number of clashes within the asymmetric unit, whereas Symm-Clashes lists symmetry-related clashes.

Mol	Chain	Non-H	H(model)	H(added)	Clashes	Symm-Clashes
1	A	3717	3809	3794	5	0
1	B	3732	3817	3802	5	0
1	C	3740	3810	3806	4	0
1	D	3736	3808	3803	8	0
2	A	43	30	30	2	0
2	B	43	30	30	1	0
2	C	43	30	30	4	0
2	D	43	30	30	3	0
3	A	23	30	30	0	0

Continued on next page...

Continued from previous page...

Mol	Chain	Non-H	H(model)	H(added)	Clashes	Symm-Clashes
3	B	23	30	30	1	0
3	C	23	30	30	0	0
3	D	23	30	30	1	0
4	A	14	0	0	0	0
4	B	13	0	0	0	0
4	C	10	0	0	0	0
4	D	9	0	0	0	0
All	All	15235	15484	15445	27	0

The all-atom clashscore is defined as the number of clashes found per 1000 atoms (including hydrogen atoms). The all-atom clashscore for this structure is 1.

All (27) close contacts within the same asymmetric unit are listed below, sorted by their clash magnitude.

Atom-1	Atom-2	Interatomic distance (Å)	Clash overlap (Å)
1:B:239:ARG:NH1	1:B:240:ASN:OD1	2.26	0.69
2:C:600:HEM:HBC2	2:C:600:HEM:HHD	1.79	0.65
1:D:470:ASP:O	1:D:472:GLN:N	2.31	0.64
2:D:600:HEM:HBC2	2:D:600:HEM:HHD	1.81	0.63
2:C:600:HEM:HHC	2:C:600:HEM:HBB2	1.84	0.60
1:C:379:SER:OG	1:C:380:SER:N	2.37	0.56
2:A:600:HEM:HBC2	2:A:600:HEM:HHD	1.88	0.55
1:A:125:ARG:NH1	2:A:600:HEM:O2D	2.39	0.54
1:C:303:GLY:HA2	2:C:600:HEM:HMC2	1.93	0.51
1:B:125:ARG:NH1	2:B:600:HEM:O2D	2.45	0.49
1:D:283:ASP:N	1:D:283:ASP:OD1	2.46	0.48
1:D:202:ASN:ND2	3:D:601:STR:O3	2.47	0.47
1:A:445:GLU:OE2	1:A:449:ARG:NH2	2.48	0.47
1:D:362:ARG:NH1	1:D:400:HIS:O	2.49	0.46
1:D:303:GLY:HA2	2:D:600:HEM:HMC2	1.98	0.45
1:D:343:THR:HG22	1:D:344:ILE:N	2.32	0.45
2:D:600:HEM:HMB2	2:D:600:HEM:HBB2	1.98	0.45
1:B:396:LEU:HD22	1:B:400:HIS:NE2	2.31	0.44
1:C:366:VAL:CG2	2:C:600:HEM:HMB2	2.47	0.43
1:C:470:ASP:OD1	1:C:470:ASP:N	2.51	0.43
1:A:83:LYS:NZ	1:A:430:VAL:O	2.51	0.43
1:A:306:THR:O	1:A:310:VAL:HG23	2.19	0.43
1:D:396:LEU:HD22	1:D:400:HIS:NE2	2.34	0.43
1:D:470:ASP:OD1	1:D:470:ASP:N	2.52	0.42
1:B:379:SER:OG	1:B:380:SER:N	2.50	0.41
1:A:347:ARG:NH2	1:A:354:GLU:OE1	2.48	0.41

Continued on next page...

Continued from previous page...

Atom-1	Atom-2	Interatomic distance (Å)	Clash overlap (Å)
1:B:202:ASN:ND2	3:B:601:STR:O3	2.55	0.40

There are no symmetry-related clashes.

5.3 Torsion angles [i](#)

5.3.1 Protein backbone [i](#)

In the following table, the Percentiles column shows the percent Ramachandran outliers of the chain as a percentile score with respect to all X-ray entries followed by that with respect to entries of similar resolution.

The Analysed column shows the number of residues for which the backbone conformation was analysed, and the total number of residues.

Mol	Chain	Analysed	Favoured	Allowed	Outliers	Percentiles	
1	A	462/494 (94%)	438 (95%)	24 (5%)	0	100	100
1	B	464/494 (94%)	440 (95%)	23 (5%)	1 (0%)	47	78
1	C	465/494 (94%)	446 (96%)	19 (4%)	0	100	100
1	D	464/494 (94%)	450 (97%)	13 (3%)	1 (0%)	47	78
All	All	1855/1976 (94%)	1774 (96%)	79 (4%)	2 (0%)	51	81

All (2) Ramachandran outliers are listed below:

Mol	Chain	Res	Type
1	D	471	GLY
1	B	217	LEU

5.3.2 Protein sidechains [i](#)

In the following table, the Percentiles column shows the percent sidechain outliers of the chain as a percentile score with respect to all X-ray entries followed by that with respect to entries of similar resolution.

The Analysed column shows the number of residues for which the sidechain conformation was analysed, and the total number of residues.

Mol	Chain	Analysed	Rotameric	Outliers	Percentiles	
1	A	416/437 (95%)	406 (98%)	10 (2%)	49	81

Continued on next page...

Continued from previous page...

Mol	Chain	Analysed	Rotameric	Outliers	Percentiles	
1	B	418/437 (96%)	407 (97%)	11 (3%)	46	79
1	C	419/437 (96%)	401 (96%)	18 (4%)	29	62
1	D	419/437 (96%)	407 (97%)	12 (3%)	42	76
All	All	1672/1748 (96%)	1621 (97%)	51 (3%)	40	74

All (51) residues with a non-rotameric sidechain are listed below:

Mol	Chain	Res	Type
1	A	201	TYR
1	A	202	ASN
1	A	239	ARG
1	A	260	THR
1	A	300	PHE
1	A	404	LYS
1	A	462	ARG
1	A	484	PHE
1	A	487	ASP
1	A	503	GLN
1	B	120	HIS
1	B	179	ILE
1	B	187	SER
1	B	207	ASP
1	B	239	ARG
1	B	256	SER
1	B	260	THR
1	B	300	PHE
1	B	343	THR
1	B	380	SER
1	B	484	PHE
1	C	33	SER
1	C	46	HIS
1	C	56	LEU
1	C	137	ASP
1	C	140	GLN
1	C	201	TYR
1	C	213	SER
1	C	228	THR
1	C	239	ARG
1	C	247	LEU
1	C	273	SER
1	C	281	ASP

Continued on next page...

Continued from previous page...

Mol	Chain	Res	Type
1	C	300	PHE
1	C	339	SER
1	C	403	GLU
1	C	466	GLU
1	C	470	ASP
1	C	484	PHE
1	D	59	LYS
1	D	199	GLN
1	D	201	TYR
1	D	239	ARG
1	D	283	ASP
1	D	300	PHE
1	D	431	SER
1	D	464	ASP
1	D	470	ASP
1	D	481	LYS
1	D	484	PHE
1	D	500	ARG

Sometimes sidechains can be flipped to improve hydrogen bonding and reduce clashes. All (11) such sidechains are listed below:

Mol	Chain	Res	Type
1	A	50	HIS
1	A	202	ASN
1	B	48	HIS
1	B	50	HIS
1	B	202	ASN
1	C	202	ASN
1	D	50	HIS
1	D	120	HIS
1	D	202	ASN
1	D	407	HIS
1	D	408	GLN

5.3.3 RNA

There are no RNA molecules in this entry.

5.4 Non-standard residues in protein, DNA, RNA chains [i](#)

There are no non-standard protein/DNA/RNA residues in this entry.

5.5 Carbohydrates [i](#)

There are no monosaccharides in this entry.

5.6 Ligand geometry [i](#)

8 ligands are modelled in this entry.

In the following table, the Counts columns list the number of bonds (or angles) for which Mogul statistics could be retrieved, the number of bonds (or angles) that are observed in the model and the number of bonds (or angles) that are defined in the Chemical Component Dictionary. The Link column lists molecule types, if any, to which the group is linked. The Z score for a bond length (or angle) is the number of standard deviations the observed value is removed from the expected value. A bond length (or angle) with $|Z| > 2$ is considered an outlier worth inspection. RMSZ is the root-mean-square of all Z scores of the bond lengths (or angles).

Mol	Type	Chain	Res	Link	Bond lengths			Bond angles		
					Counts	RMSZ	# Z > 2	Counts	RMSZ	# Z > 2
2	HEM	A	600	1	41,50,50	2.04	8 (19%)	45,82,82	1.71	5 (11%)
3	STR	D	601	-	26,26,26	4.41	17 (65%)	42,42,42	2.59	17 (40%)
3	STR	B	601	-	26,26,26	4.42	17 (65%)	42,42,42	2.51	15 (35%)
2	HEM	C	600	1	41,50,50	1.92	7 (17%)	45,82,82	1.75	10 (22%)
2	HEM	D	600	1	41,50,50	1.91	6 (14%)	45,82,82	1.67	9 (20%)
2	HEM	B	600	1	41,50,50	1.94	7 (17%)	45,82,82	1.57	7 (15%)
3	STR	A	601	-	26,26,26	4.42	17 (65%)	42,42,42	2.41	12 (28%)
3	STR	C	601	-	26,26,26	4.39	18 (69%)	42,42,42	2.52	16 (38%)

In the following table, the Chirals column lists the number of chiral outliers, the number of chiral centers analysed, the number of these observed in the model and the number defined in the Chemical Component Dictionary. Similar counts are reported in the Torsion and Rings columns. '-' means no outliers of that kind were identified.

Mol	Type	Chain	Res	Link	Chirals	Torsions	Rings
2	HEM	A	600	1	-	2/12/54/54	-
3	STR	D	601	-	-	0/4/62/62	0/4/4/4
3	STR	B	601	-	-	0/4/62/62	0/4/4/4
2	HEM	C	600	1	-	4/12/54/54	-

Continued on next page...

Continued from previous page...

Mol	Type	Chain	Res	Link	Chirals	Torsions	Rings
2	HEM	D	600	1	-	2/12/54/54	-
2	HEM	B	600	1	-	2/12/54/54	-
3	STR	A	601	-	-	0/4/62/62	0/4/4/4
3	STR	C	601	-	-	0/4/62/62	0/4/4/4

All (97) bond length outliers are listed below:

Mol	Chain	Res	Type	Atoms	Z	Observed(Å)	Ideal(Å)
3	B	601	STR	C11-C9	11.66	1.73	1.53
3	D	601	STR	C11-C9	11.57	1.73	1.53
3	C	601	STR	C11-C9	11.48	1.73	1.53
3	A	601	STR	C11-C9	11.21	1.72	1.53
3	A	601	STR	C12-C11	8.87	1.72	1.53
3	B	601	STR	C12-C11	8.63	1.71	1.53
3	C	601	STR	C12-C11	8.51	1.71	1.53
3	D	601	STR	C12-C11	8.40	1.71	1.53
2	A	600	HEM	C3D-C2D	8.12	1.54	1.36
2	B	600	HEM	C3D-C2D	7.98	1.53	1.36
2	D	600	HEM	C3D-C2D	7.69	1.53	1.36
2	C	600	HEM	C3D-C2D	7.50	1.52	1.36
3	D	601	STR	C10-C9	-7.19	1.44	1.56
3	C	601	STR	C10-C9	-7.10	1.44	1.56
3	B	601	STR	C10-C9	-7.08	1.44	1.56
3	A	601	STR	C10-C9	-7.03	1.44	1.56
3	C	601	STR	C7-C6	6.23	1.66	1.52
3	D	601	STR	C7-C6	6.23	1.66	1.52
3	B	601	STR	C7-C6	6.17	1.66	1.52
3	A	601	STR	C7-C6	5.95	1.66	1.52
3	A	601	STR	C7-C8	5.66	1.63	1.53
3	A	601	STR	C6-C5	5.07	1.59	1.50
3	D	601	STR	C7-C8	4.95	1.62	1.53
3	B	601	STR	C13-C14	-4.95	1.45	1.55
3	B	601	STR	C6-C5	4.95	1.59	1.50
3	B	601	STR	C7-C8	4.92	1.62	1.53
3	D	601	STR	C13-C14	-4.78	1.45	1.55
3	C	601	STR	C7-C8	4.77	1.62	1.53
3	C	601	STR	C13-C14	-4.76	1.45	1.55
3	A	601	STR	C13-C14	-4.65	1.46	1.55
2	A	600	HEM	C3C-CAC	4.59	1.57	1.47
2	D	600	HEM	C3C-C2C	-4.58	1.34	1.40
3	C	601	STR	C6-C5	4.52	1.58	1.50
3	D	601	STR	C6-C5	4.43	1.58	1.50

Continued on next page...

Continued from previous page...

Mol	Chain	Res	Type	Atoms	Z	Observed(Å)	Ideal(Å)
3	C	601	STR	C2-C3	4.36	1.59	1.49
3	A	601	STR	C4-C3	4.31	1.54	1.45
3	D	601	STR	C2-C3	4.28	1.59	1.49
3	A	601	STR	C2-C3	4.26	1.59	1.49
3	B	601	STR	C2-C3	4.24	1.59	1.49
2	C	600	HEM	C3C-C2C	-4.20	1.34	1.40
3	A	601	STR	C10-C5	-4.18	1.44	1.52
2	A	600	HEM	C3C-C2C	-4.15	1.34	1.40
2	B	600	HEM	C3C-CAC	4.15	1.56	1.47
3	B	601	STR	C12-C13	-4.09	1.46	1.54
3	D	601	STR	C12-C13	-4.05	1.46	1.54
3	B	601	STR	C4-C3	4.03	1.54	1.45
3	C	601	STR	C4-C3	4.02	1.54	1.45
3	C	601	STR	C12-C13	-3.97	1.47	1.54
2	C	600	HEM	C3C-CAC	3.94	1.55	1.47
3	D	601	STR	C17-C20	-3.92	1.46	1.51
3	D	601	STR	C8-C9	-3.89	1.46	1.53
3	A	601	STR	C12-C13	-3.87	1.47	1.54
3	C	601	STR	C8-C9	-3.85	1.46	1.53
3	D	601	STR	C4-C3	3.84	1.53	1.45
3	C	601	STR	C16-C17	3.82	1.64	1.54
3	B	601	STR	C17-C20	-3.79	1.46	1.51
3	C	601	STR	C17-C20	-3.77	1.46	1.51
2	D	600	HEM	C3C-CAC	3.76	1.55	1.47
3	D	601	STR	C16-C17	3.73	1.64	1.54
3	B	601	STR	C8-C9	-3.73	1.46	1.53
3	C	601	STR	C10-C5	-3.70	1.45	1.52
3	D	601	STR	C10-C5	-3.58	1.45	1.52
3	A	601	STR	C16-C17	3.54	1.63	1.54
3	A	601	STR	C8-C9	-3.46	1.47	1.53
3	B	601	STR	C16-C17	3.43	1.63	1.54
3	B	601	STR	C10-C5	-3.37	1.46	1.52
2	B	600	HEM	C3C-C2C	-3.35	1.35	1.40
3	D	601	STR	C16-C15	3.24	1.62	1.54
3	D	601	STR	C1-C10	3.23	1.60	1.54
3	B	601	STR	C1-C10	3.22	1.60	1.54
3	A	601	STR	C1-C10	3.19	1.60	1.54
2	A	600	HEM	FE-NB	3.18	2.12	1.96
3	C	601	STR	C1-C10	3.16	1.60	1.54
3	A	601	STR	C17-C20	-3.14	1.47	1.51
3	A	601	STR	C16-C15	3.13	1.62	1.54
3	B	601	STR	C16-C15	3.06	1.62	1.54

Continued on next page...

Continued from previous page...

Mol	Chain	Res	Type	Atoms	Z	Observed(Å)	Ideal(Å)
3	C	601	STR	C16-C15	3.03	1.62	1.54
2	B	600	HEM	CAB-C3B	3.02	1.55	1.47
2	D	600	HEM	CAB-C3B	2.94	1.55	1.47
2	C	600	HEM	CAB-C3B	2.91	1.55	1.47
2	A	600	HEM	CAB-C3B	2.87	1.55	1.47
3	B	601	STR	C8-C14	-2.68	1.48	1.53
3	D	601	STR	C8-C14	-2.63	1.48	1.53
2	C	600	HEM	CAA-C2A	2.47	1.55	1.52
2	D	600	HEM	CAA-C2A	2.41	1.55	1.52
3	C	601	STR	C8-C14	-2.39	1.49	1.53
2	A	600	HEM	CMB-C2B	2.38	1.55	1.50
3	A	601	STR	C8-C14	-2.34	1.49	1.53
2	C	600	HEM	FE-ND	2.31	2.08	1.96
2	C	600	HEM	CMB-C2B	2.28	1.55	1.50
2	A	600	HEM	CAA-C2A	2.16	1.55	1.52
2	B	600	HEM	CMB-C2B	2.15	1.55	1.50
3	C	601	STR	C1-C2	2.11	1.57	1.53
2	D	600	HEM	FE-ND	2.11	2.07	1.96
2	A	600	HEM	CMA-C3A	2.07	1.56	1.51
2	B	600	HEM	FE-ND	2.03	2.06	1.96
2	B	600	HEM	CMA-C3A	2.02	1.55	1.51

All (91) bond angle outliers are listed below:

Mol	Chain	Res	Type	Atoms	Z	Observed(°)	Ideal(°)
2	A	600	HEM	C4D-ND-C1D	6.85	112.14	105.07
3	A	601	STR	C12-C13-C17	-5.85	108.95	116.10
3	B	601	STR	C16-C17-C13	-5.79	99.05	104.21
3	A	601	STR	C17-C13-C14	5.68	105.78	99.72
3	B	601	STR	C1-C2-C3	-5.65	99.51	111.62
2	D	600	HEM	C4D-ND-C1D	5.57	110.83	105.07
2	B	600	HEM	C4D-ND-C1D	5.39	110.64	105.07
3	A	601	STR	C11-C9-C8	-5.39	103.99	111.75
3	D	601	STR	C12-C13-C17	-5.38	109.52	116.10
3	C	601	STR	C1-C2-C3	-5.32	100.23	111.62
2	C	600	HEM	C4D-ND-C1D	5.28	110.52	105.07
3	C	601	STR	C6-C5-C4	-5.27	112.05	120.87
3	D	601	STR	C1-C2-C3	-5.25	100.37	111.62
3	B	601	STR	C12-C13-C17	-5.23	109.70	116.10
3	D	601	STR	C6-C5-C4	-5.10	112.35	120.87
3	C	601	STR	C12-C13-C17	-5.10	109.87	116.10
3	A	601	STR	C1-C2-C3	-4.99	100.94	111.62

Continued on next page...

Continued from previous page...

Mol	Chain	Res	Type	Atoms	Z	Observed(°)	Ideal(°)
3	A	601	STR	C16-C17-C13	-4.91	99.83	104.21
3	C	601	STR	C6-C5-C10	4.90	125.81	116.77
3	D	601	STR	C16-C17-C13	-4.85	99.89	104.21
3	C	601	STR	C11-C9-C8	-4.81	104.83	111.75
3	D	601	STR	C6-C5-C10	4.71	125.46	116.77
3	C	601	STR	C17-C13-C14	4.68	104.72	99.72
3	B	601	STR	C15-C14-C8	-4.55	111.58	119.08
3	B	601	STR	C6-C5-C4	-4.36	113.57	120.87
3	D	601	STR	C15-C14-C8	-4.23	112.11	119.08
3	D	601	STR	C7-C6-C5	-4.22	103.99	111.93
3	D	601	STR	C11-C9-C8	-4.19	105.72	111.75
3	A	601	STR	C7-C6-C5	-4.12	104.17	111.93
3	B	601	STR	C13-C17-C20	3.99	120.61	114.98
3	D	601	STR	C17-C13-C14	3.94	103.92	99.72
2	A	600	HEM	C4C-CHD-C1D	3.89	127.69	122.56
3	A	601	STR	C13-C17-C20	3.89	120.46	114.98
3	A	601	STR	C15-C14-C8	-3.78	112.86	119.08
3	B	601	STR	C6-C5-C10	3.76	123.70	116.77
2	C	600	HEM	C4C-CHD-C1D	3.60	127.31	122.56
3	C	601	STR	C21-C20-C17	3.59	122.78	117.56
3	B	601	STR	C9-C10-C5	3.54	115.21	109.65
2	C	600	HEM	C4B-CHC-C1C	3.52	127.20	122.56
3	C	601	STR	C15-C14-C8	-3.50	113.31	119.08
3	D	601	STR	C9-C10-C5	3.45	115.06	109.65
3	B	601	STR	C11-C9-C8	-3.43	106.81	111.75
2	C	600	HEM	C1B-NB-C4B	3.29	108.47	105.07
3	D	601	STR	C12-C13-C14	3.29	112.37	107.27
3	C	601	STR	C9-C10-C5	3.29	114.80	109.65
2	D	600	HEM	C4C-CHD-C1D	3.25	126.85	122.56
3	B	601	STR	C17-C13-C14	3.23	103.17	99.72
3	C	601	STR	C7-C8-C14	-3.13	106.73	112.08
3	C	601	STR	C16-C17-C13	-3.09	101.45	104.21
2	A	600	HEM	C4B-CHC-C1C	3.08	126.62	122.56
3	B	601	STR	C7-C6-C5	-3.05	106.19	111.93
3	B	601	STR	C7-C8-C14	-2.96	107.03	112.08
3	B	601	STR	C15-C14-C13	2.89	107.33	103.84
2	B	600	HEM	CMC-C2C-C3C	2.86	130.03	124.68
2	B	600	HEM	C4B-CHC-C1C	2.85	126.32	122.56
3	D	601	STR	C11-C12-C13	-2.80	107.97	112.78
2	C	600	HEM	CMA-C3A-C4A	-2.80	124.17	128.46
3	A	601	STR	C6-C5-C10	2.78	121.90	116.77
3	D	601	STR	C7-C8-C14	-2.78	107.34	112.08

Continued on next page...

Continued from previous page...

Mol	Chain	Res	Type	Atoms	Z	Observed(°)	Ideal(°)
2	B	600	HEM	C4C-CHD-C1D	2.72	126.15	122.56
2	D	600	HEM	C1B-NB-C4B	2.71	107.88	105.07
2	D	600	HEM	C4B-CHC-C1C	2.65	126.05	122.56
2	A	600	HEM	CHD-C1D-ND	2.64	127.30	124.43
3	A	601	STR	C2-C3-C4	2.64	120.80	116.74
3	B	601	STR	C21-C20-C17	2.63	121.38	117.56
2	D	600	HEM	CMB-C2B-C1B	-2.60	121.09	125.04
3	C	601	STR	C7-C6-C5	-2.59	107.05	111.93
2	B	600	HEM	C1B-NB-C4B	2.57	107.73	105.07
3	C	601	STR	C12-C13-C14	2.45	111.06	107.27
3	B	601	STR	C11-C12-C13	-2.43	108.61	112.78
3	C	601	STR	C2-C3-C4	2.42	120.47	116.74
3	D	601	STR	C2-C3-C4	2.41	120.46	116.74
2	B	600	HEM	CHB-C1B-NB	2.41	127.36	124.38
2	B	600	HEM	CMB-C2B-C1B	-2.37	121.43	125.04
3	A	601	STR	C21-C20-C17	2.32	120.93	117.56
2	C	600	HEM	C3B-C2B-C1B	2.30	108.19	106.49
3	D	601	STR	C21-C20-C17	2.29	120.89	117.56
3	A	601	STR	C6-C5-C4	-2.28	117.06	120.87
2	C	600	HEM	CHC-C4B-C3B	2.28	128.06	124.57
2	D	600	HEM	CHD-C1D-ND	2.26	126.89	124.43
3	C	601	STR	C16-C15-C14	-2.25	100.67	105.13
3	C	601	STR	C11-C12-C13	-2.18	109.05	112.78
2	D	600	HEM	CHA-C4D-ND	2.16	127.05	124.38
2	C	600	HEM	CMD-C2D-C1D	2.12	128.26	125.04
2	A	600	HEM	C1B-NB-C4B	2.11	107.25	105.07
2	D	600	HEM	CHC-C4B-NB	2.11	126.72	124.43
2	C	600	HEM	CHB-C1B-NB	2.02	126.88	124.38
2	D	600	HEM	CHB-C1B-NB	2.02	126.88	124.38
2	C	600	HEM	CHA-C4D-ND	2.02	126.88	124.38
3	D	601	STR	C11-C9-C10	-2.01	110.43	113.08
3	D	601	STR	C16-C15-C14	-2.01	101.15	105.13

There are no chirality outliers.

All (10) torsion outliers are listed below:

Mol	Chain	Res	Type	Atoms
2	C	600	HEM	C1A-C2A-CAA-CBA
2	C	600	HEM	C3A-C2A-CAA-CBA
2	C	600	HEM	C4B-C3B-CAB-CBB
2	B	600	HEM	C1A-C2A-CAA-CBA
2	A	600	HEM	CAA-CBA-CGA-O2A

Continued on next page...

Continued from previous page...

Mol	Chain	Res	Type	Atoms
2	A	600	HEM	CAA-CBA-CGA-O1A
2	B	600	HEM	CAA-CBA-CGA-O2A
2	D	600	HEM	CAA-CBA-CGA-O1A
2	C	600	HEM	CAA-CBA-CGA-O2A
2	D	600	HEM	CAA-CBA-CGA-O2A

There are no ring outliers.

6 monomers are involved in 12 short contacts:

Mol	Chain	Res	Type	Clashes	Symm-Clashes
2	A	600	HEM	2	0
3	D	601	STR	1	0
3	B	601	STR	1	0
2	C	600	HEM	4	0
2	D	600	HEM	3	0
2	B	600	HEM	1	0

The following is a two-dimensional graphical depiction of Mogul quality analysis of bond lengths, bond angles, torsion angles, and ring geometry for all instances of the Ligand of Interest. In addition, ligands with molecular weight > 250 and outliers as shown on the validation Tables will also be included. For torsion angles, if less than 5% of the Mogul distribution of torsion angles is within 10 degrees of the torsion angle in question, then that torsion angle is considered an outlier. Any bond that is central to one or more torsion angles identified as an outlier by Mogul will be highlighted in the graph. For rings, the root-mean-square deviation (RMSD) between the ring in question and similar rings identified by Mogul is calculated over all ring torsion angles. If the average RMSD is greater than 60 degrees and the minimal RMSD between the ring in question and any Mogul-identified rings is also greater than 60 degrees, then that ring is considered an outlier. The outliers are highlighted in purple. The color gray indicates Mogul did not find sufficient equivalents in the CSD to analyse the geometry.

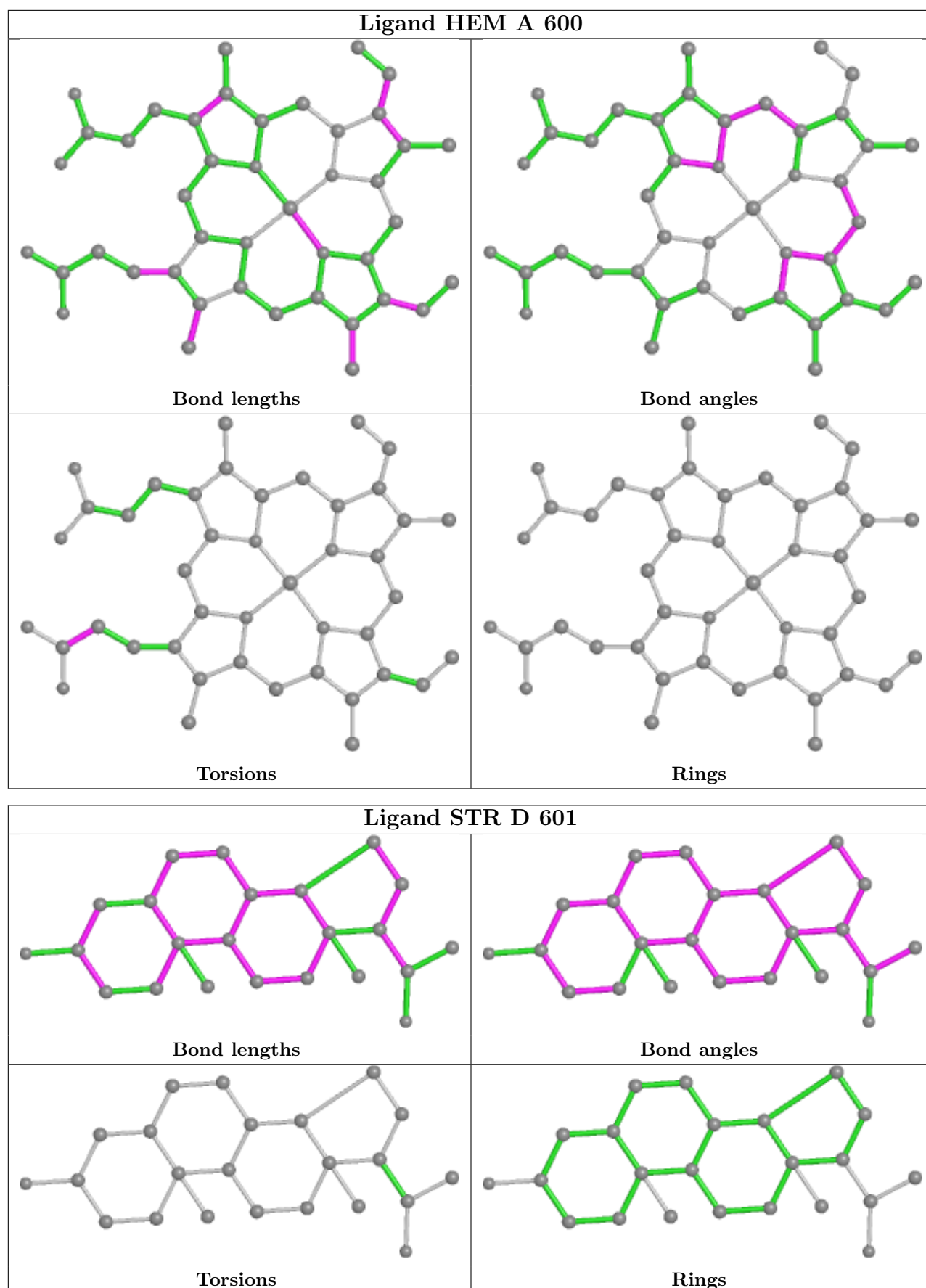

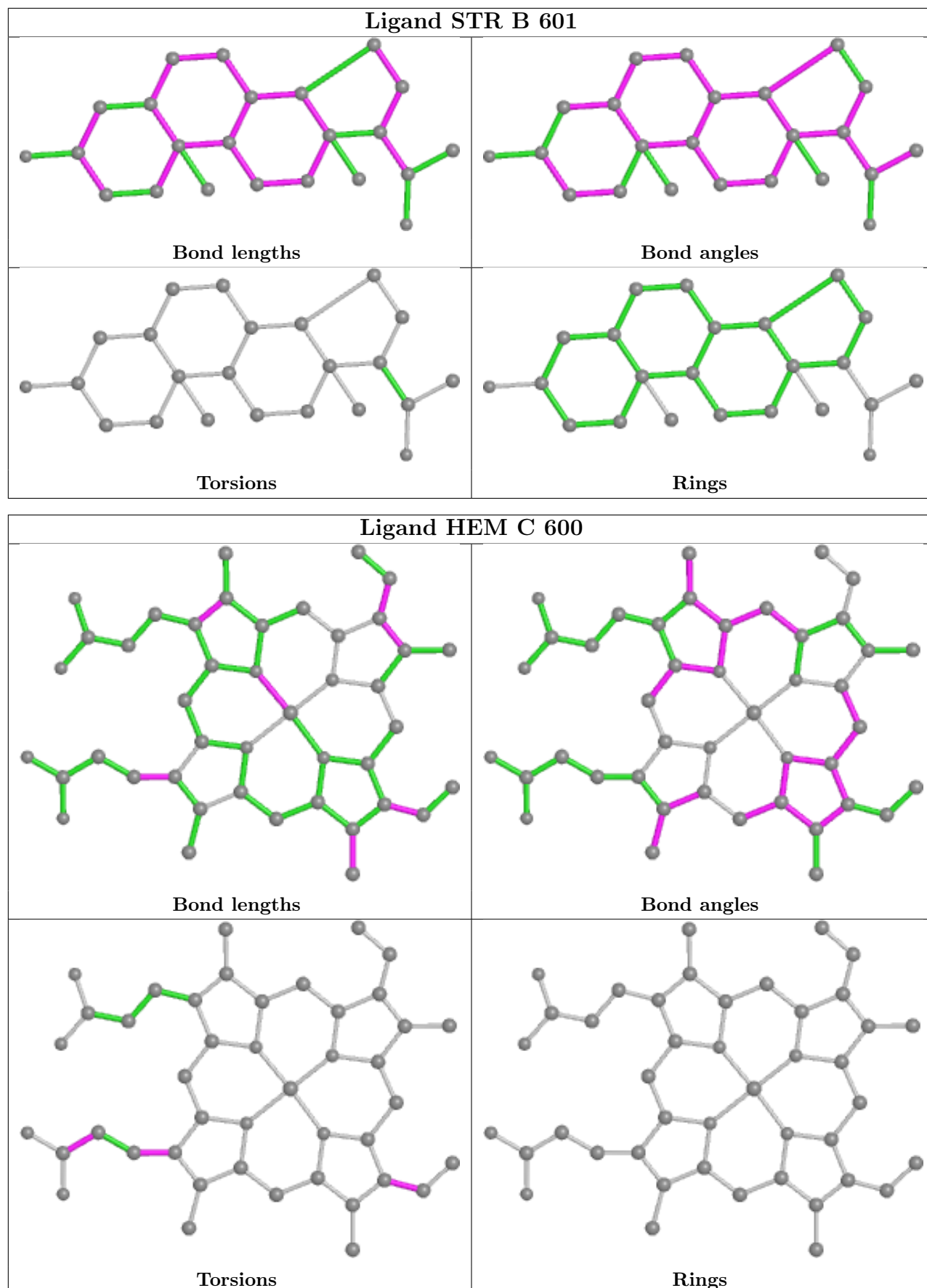

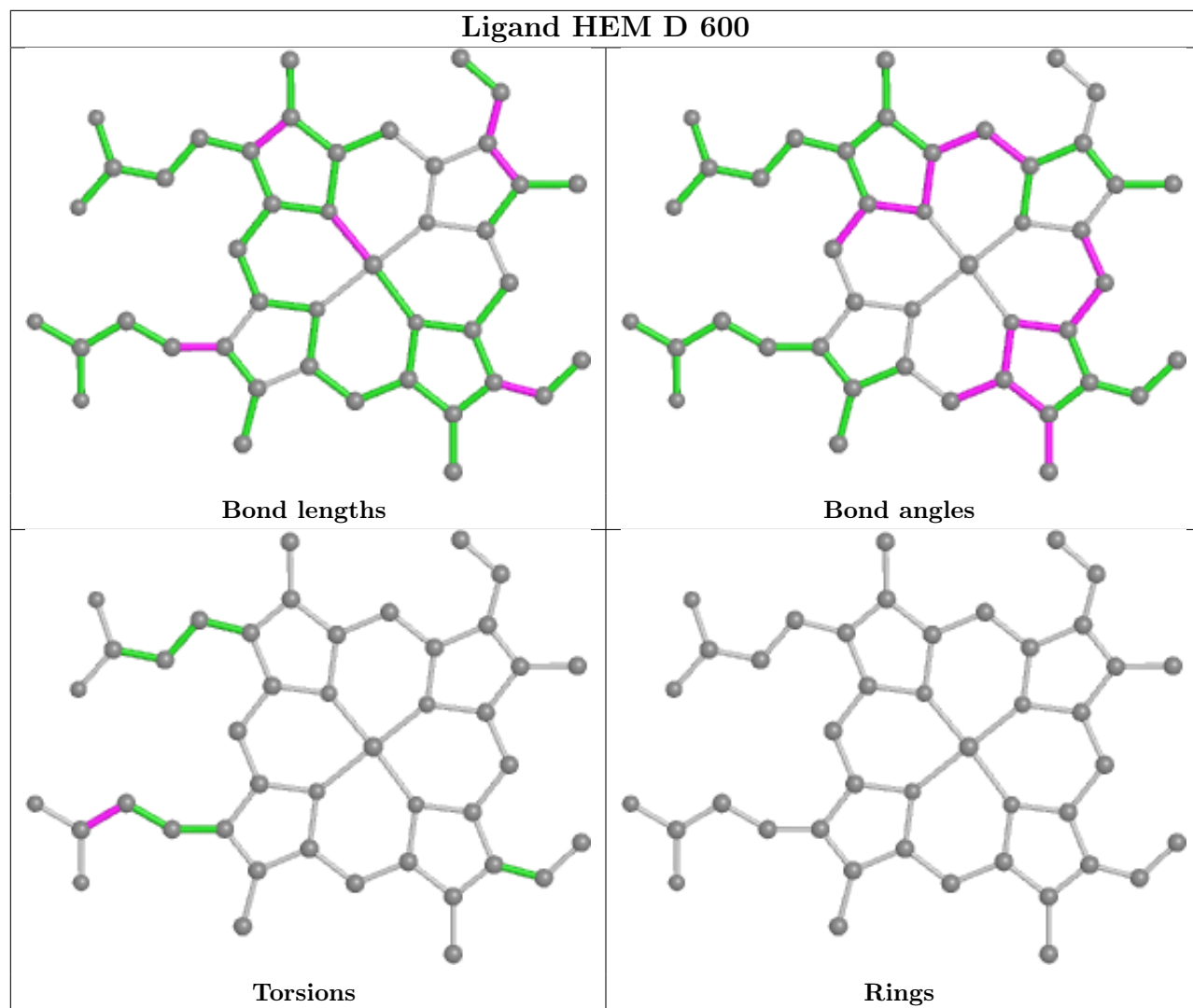

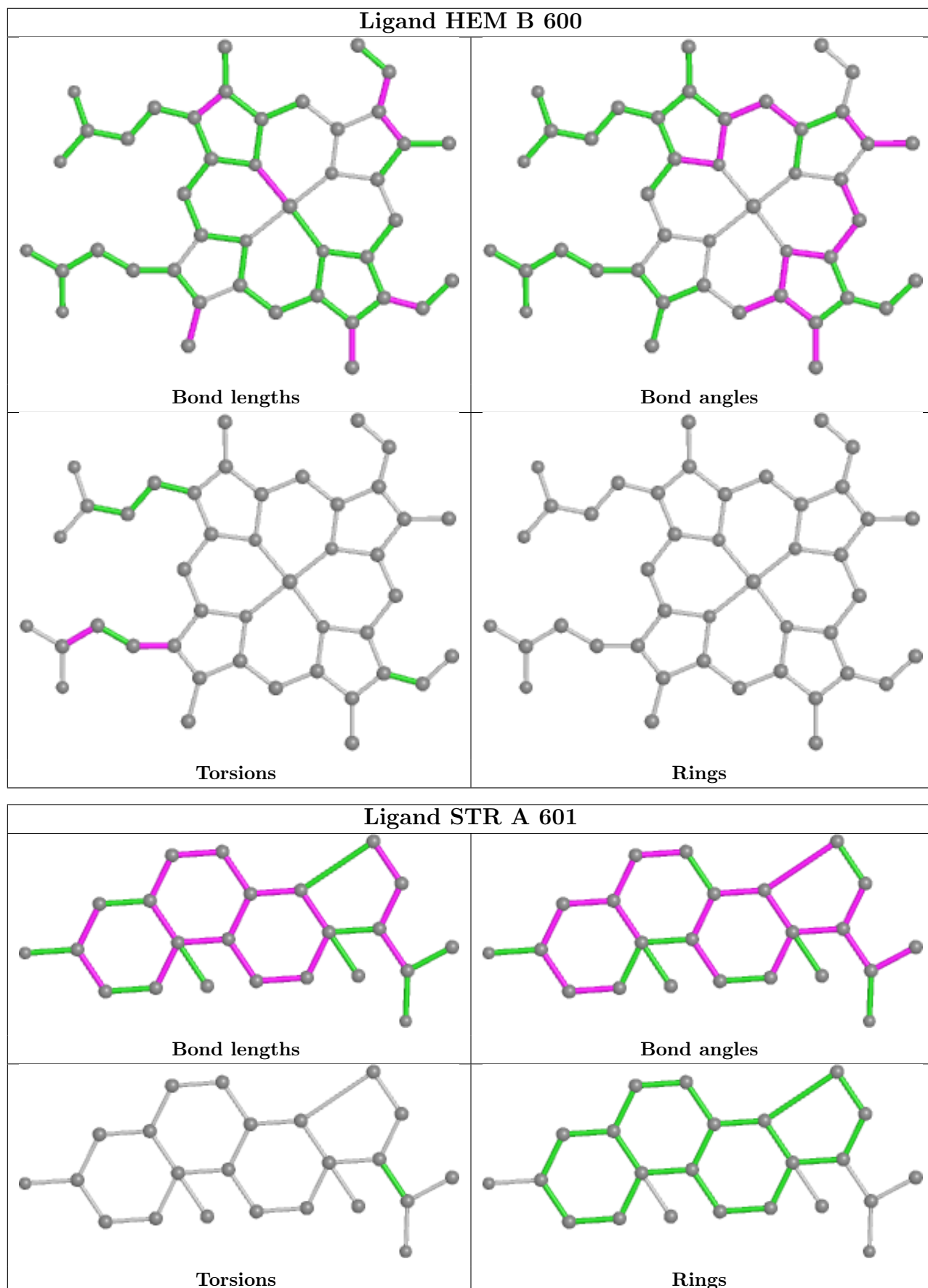

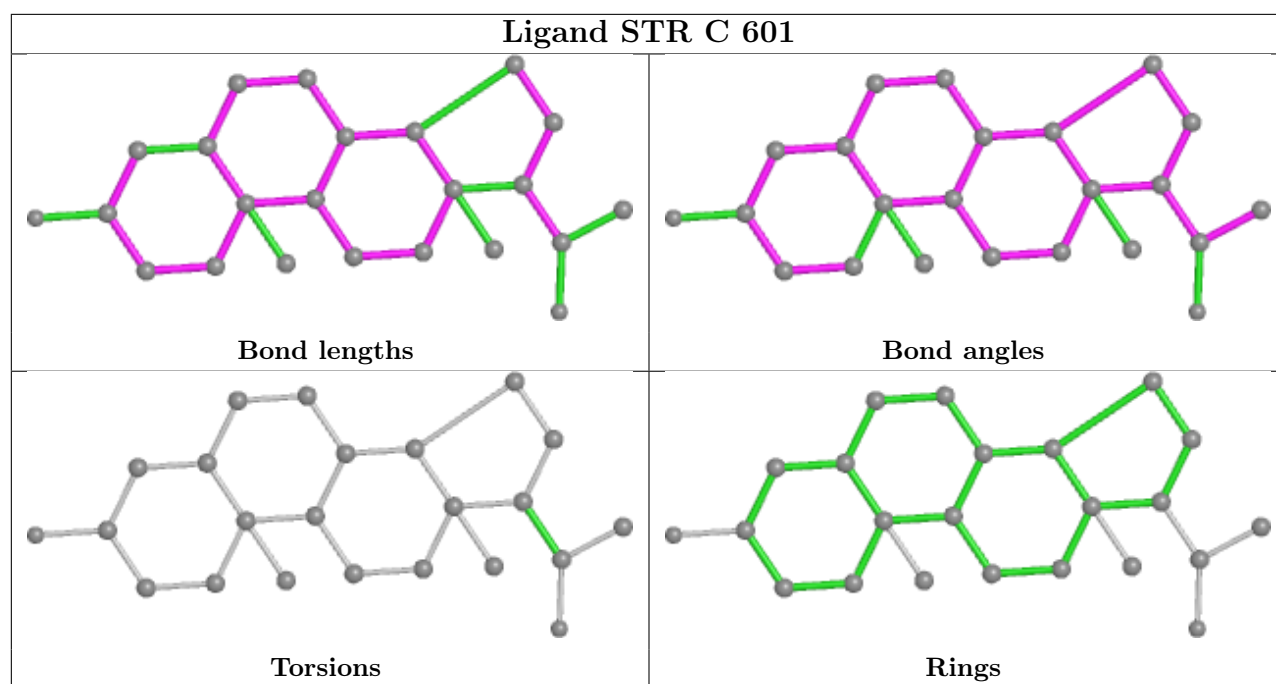

5.7 Other polymers [i](#)

There are no such residues in this entry.

5.8 Polymer linkage issues [i](#)

There are no chain breaks in this entry.

6 Fit of model and data

6.1 Protein, DNA and RNA chains

In the following table, the column labelled ‘#RSRZ > 2’ contains the number (and percentage) of RSRZ outliers, followed by percent RSRZ outliers for the chain as percentile scores relative to all X-ray entries and entries of similar resolution. The OWAB column contains the minimum, median, 95th percentile and maximum values of the occupancy-weighted average B-factor per residue. The column labelled ‘Q < 0.9’ lists the number of (and percentage) of residues with an average occupancy less than 0.9.

Mol	Chain	Analysed	<RSRZ>	#RSRZ>2	OWAB(Å ²)	Q<0.9
1	A	466/494 (94%)	0.29	27 (5%) 23 15	27, 49, 82, 109	0
1	B	468/494 (94%)	0.26	18 (3%) 40 30	28, 47, 76, 114	0
1	C	469/494 (94%)	0.46	32 (6%) 17 10	30, 51, 85, 103	0
1	D	468/494 (94%)	0.59	49 (10%) 6 3	31, 54, 92, 129	0
All	All	1871/1976 (94%)	0.40	126 (6%) 17 10	27, 50, 87, 129	0

All (126) RSRZ outliers are listed below:

Mol	Chain	Res	Type	RSRZ
1	D	281	ASP	7.9
1	A	139	ASP	7.2
1	B	139	ASP	6.6
1	B	275	ASN	5.9
1	C	281	ASP	5.7
1	B	282	GLN	5.7
1	B	274	ASP	5.0
1	D	45	ARG	4.9
1	D	275	ASN	4.4
1	C	276	GLY	4.3
1	B	140	GLN	4.2
1	D	139	ASP	4.1
1	B	276	GLY	4.1
1	B	284	SER	4.0
1	B	285	GLU	3.9
1	C	136	LYS	3.8
1	A	140	GLN	3.8
1	D	465	LEU	3.7
1	C	367	ALA	3.7
1	C	45	ARG	3.7
1	A	259	ILE	3.7

Continued on next page...

Continued from previous page...

Mol	Chain	Res	Type	RSRZ
1	A	271	MET	3.5
1	D	282	GLN	3.5
1	C	493	ILE	3.4
1	A	252	GLU	3.4
1	C	137	ASP	3.3
1	B	271	MET	3.3
1	A	251	LYS	3.3
1	D	421	ALA	3.3
1	B	31	LEU	3.3
1	A	258	SER	3.2
1	D	420	PRO	3.2
1	D	493	ILE	3.2
1	D	470	ASP	3.1
1	C	134	LEU	3.1
1	C	383	GLU	3.1
1	C	309	SER	3.1
1	A	501	GLU	3.1
1	D	134	LEU	3.0
1	C	369	MET	3.0
1	D	157	LEU	3.0
1	A	502	ALA	3.0
1	D	367	ALA	3.0
1	C	473	LEU	2.9
1	A	257	ASP	2.9
1	B	283	ASP	2.9
1	C	470	ASP	2.9
1	D	434	PRO	2.9
1	A	339	SER	2.8
1	C	500	ARG	2.8
1	C	310	VAL	2.8
1	D	369	MET	2.8
1	A	333	ASP	2.8
1	A	138	GLY	2.8
1	D	273	SER	2.8
1	D	259	ILE	2.8
1	D	469	ASP	2.8
1	D	340	ARG	2.8
1	C	421	ALA	2.8
1	D	365	PRO	2.7
1	C	471	GLY	2.7
1	D	473	LEU	2.7
1	D	370	LEU	2.7

Continued on next page...

Continued from previous page...

Mol	Chain	Res	Type	RSRZ
1	A	282	GLN	2.7
1	D	163	GLN	2.7
1	C	306	THR	2.6
1	C	502	ALA	2.6
1	A	253	LYS	2.6
1	D	499	TRP	2.6
1	C	366	VAL	2.5
1	D	283	ASP	2.5
1	D	307	THR	2.5
1	A	185	ASN	2.5
1	C	283	ASP	2.5
1	A	137	ASP	2.5
1	D	137	ASP	2.5
1	B	338	PHE	2.5
1	D	494	LYS	2.5
1	C	334	GLN	2.5
1	A	269	ALA	2.4
1	A	134	LEU	2.4
1	B	247	LEU	2.4
1	A	340	ARG	2.4
1	A	247	LEU	2.4
1	D	442	CYS	2.4
1	A	255	ARG	2.4
1	D	472	GLN	2.3
1	A	470	ASP	2.3
1	D	464	ASP	2.3
1	C	307	THR	2.3
1	B	138	GLY	2.3
1	D	164	SER	2.3
1	D	42	PHE	2.3
1	D	435	PHE	2.3
1	C	119	ALA	2.3
1	C	158	ALA	2.3
1	D	302	ALA	2.3
1	A	504	ALA	2.2
1	D	500	ARG	2.2
1	D	336	VAL	2.2
1	B	286	LEU	2.2
1	B	144	LYS	2.2
1	D	503	GLN	2.2
1	C	365	PRO	2.2
1	C	442	CYS	2.2

Continued on next page...

Continued from previous page...

Mol	Chain	Res	Type	RSRZ
1	D	366	VAL	2.2
1	B	257	ASP	2.2
1	D	423	THR	2.1
1	D	334	GLN	2.1
1	C	370	LEU	2.1
1	D	436	GLY	2.1
1	A	307	THR	2.1
1	C	408	GLN	2.1
1	A	338	PHE	2.1
1	D	162	GLY	2.1
1	D	432	TYR	2.1
1	D	306	THR	2.1
1	B	420	PRO	2.0
1	D	498	ALA	2.0
1	A	284	SER	2.0
1	C	139	ASP	2.0
1	D	274	ASP	2.0
1	D	136	LYS	2.0
1	C	282	GLN	2.0
1	D	309	SER	2.0
1	C	326	LYS	2.0

6.2 Non-standard residues in protein, DNA, RNA chains [i](#)

There are no non-standard protein/DNA/RNA residues in this entry.

6.3 Carbohydrates [i](#)

There are no monosaccharides in this entry.

6.4 Ligands [i](#)

In the following table, the Atoms column lists the number of modelled atoms in the group and the number defined in the chemical component dictionary. The B-factors column lists the minimum, median, 95th percentile and maximum values of B factors of atoms in the group. The column labelled 'Q< 0.9' lists the number of atoms with occupancy less than 0.9.

Mol	Type	Chain	Res	Atoms	RSCC	RSR	B-factors(Å ²)	Q<0.9
3	STR	C	601	23/23	0.95	0.30	30,42,52,57	0
3	STR	D	601	23/23	0.96	0.31	39,50,57,61	0

Continued on next page...

Continued from previous page...

Mol	Type	Chain	Res	Atoms	RSCC	RSR	B-factors(\AA^2)	Q<0.9
3	STR	A	601	23/23	0.97	0.24	35,45,55,55	0
2	HEM	C	600	43/43	0.97	0.31	27,39,53,57	0
2	HEM	D	600	43/43	0.97	0.33	29,43,55,62	0
3	STR	B	601	23/23	0.98	0.28	33,43,54,56	0
2	HEM	B	600	43/43	0.98	0.26	26,38,47,58	0
2	HEM	A	600	43/43	0.98	0.26	25,44,56,62	0

The following is a graphical depiction of the model fit to experimental electron density of all instances of the Ligand of Interest. In addition, ligands with molecular weight > 250 and outliers as shown on the geometry validation Tables will also be included. Each fit is shown from different orientation to approximate a three-dimensional view.

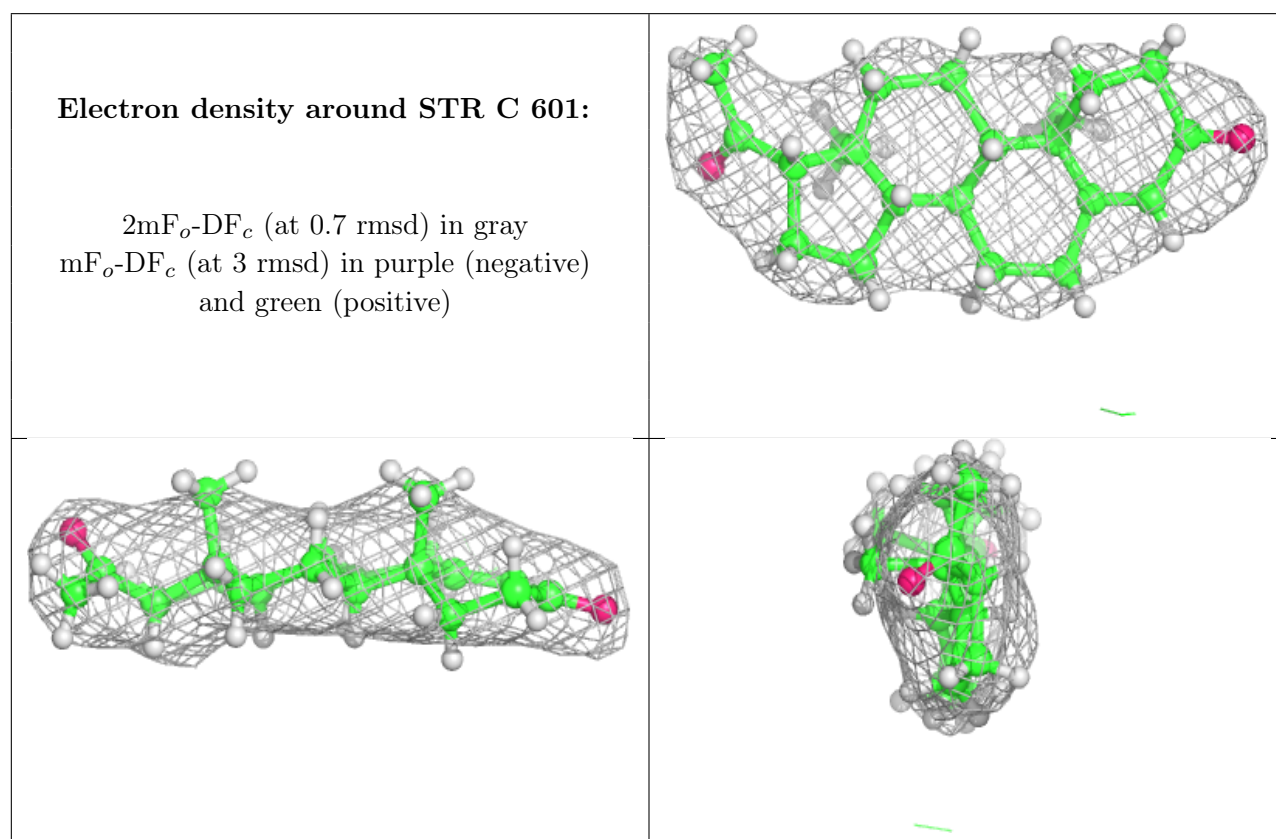

Electron density around STR D 601:

$2mF_o-DF_c$ (at 0.7 rmsd) in gray
 mF_o-DF_c (at 3 rmsd) in purple (negative)
and green (positive)

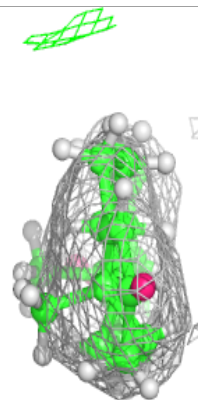
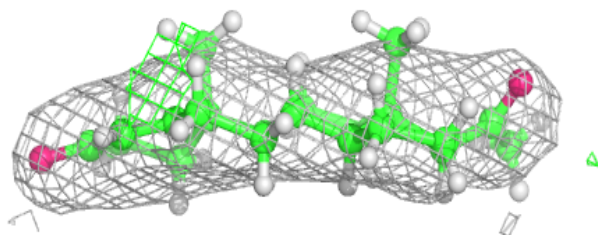
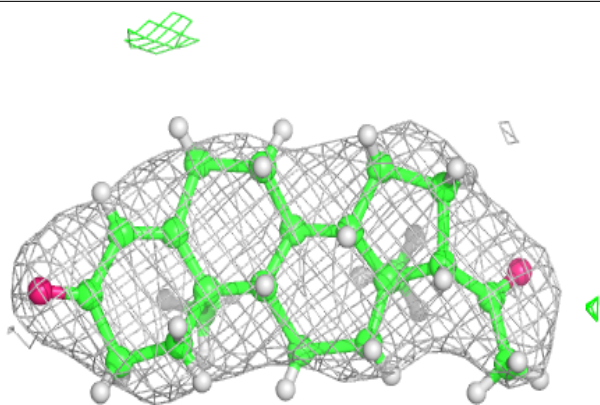
**Electron density around STR A 601:**

$2mF_o-DF_c$ (at 0.7 rmsd) in gray
 mF_o-DF_c (at 3 rmsd) in purple (negative)
and green (positive)

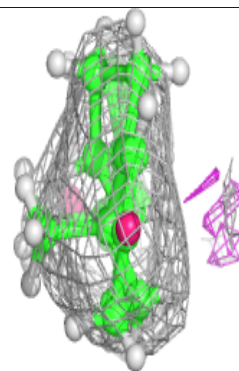
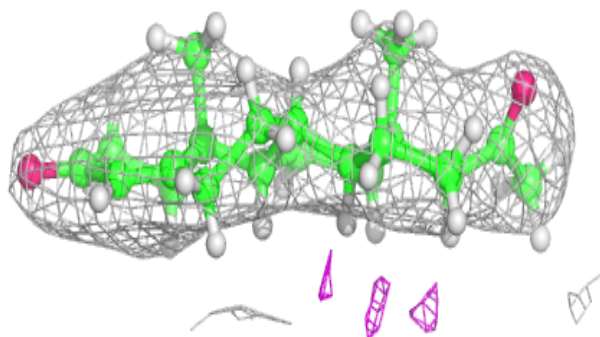
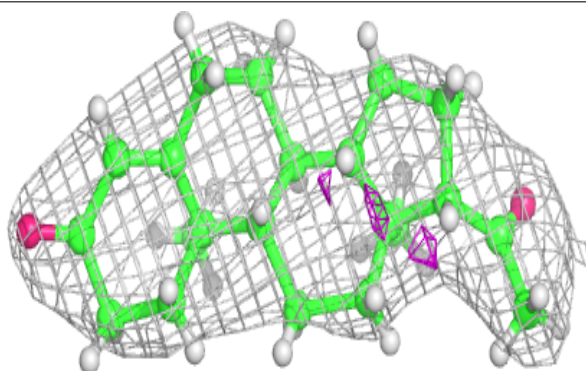

Electron density around HEM C 600:

$2mF_o-DF_c$ (at 0.7 rmsd) in gray
 mF_o-DF_c (at 3 rmsd) in purple (negative)
and green (positive)

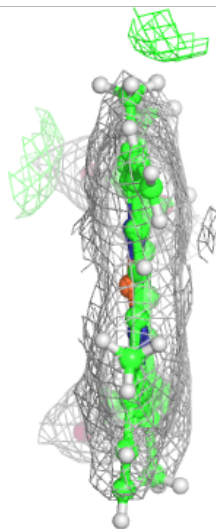
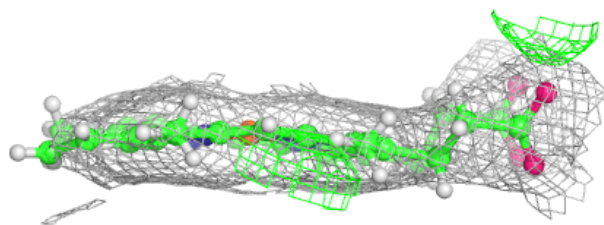
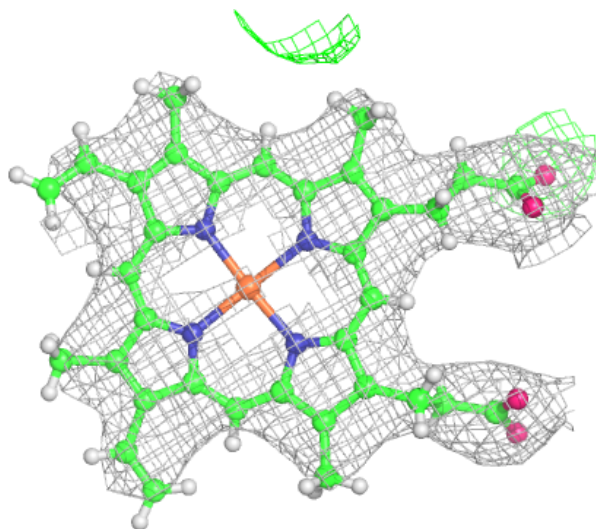

Electron density around HEM D 600:

$2mF_o-DF_c$ (at 0.7 rmsd) in gray
 mF_o-DF_c (at 3 rmsd) in purple (negative)
and green (positive)

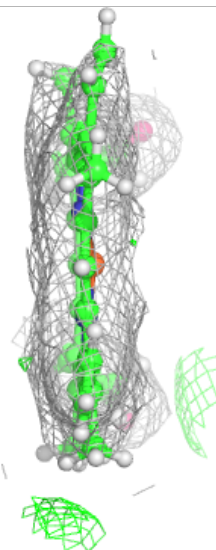
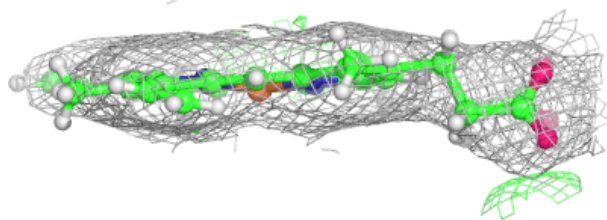
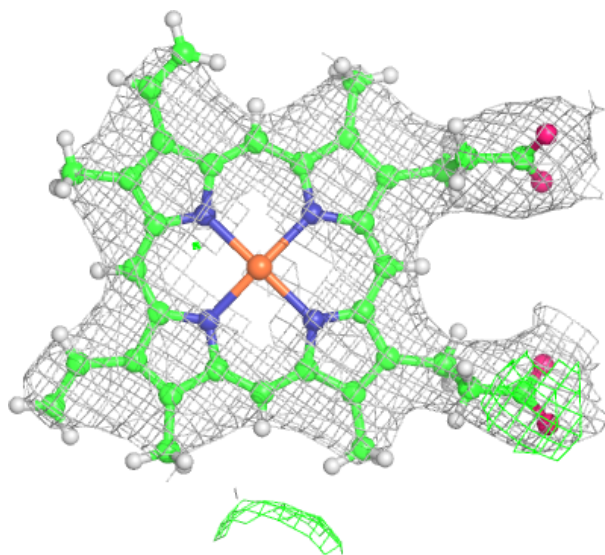

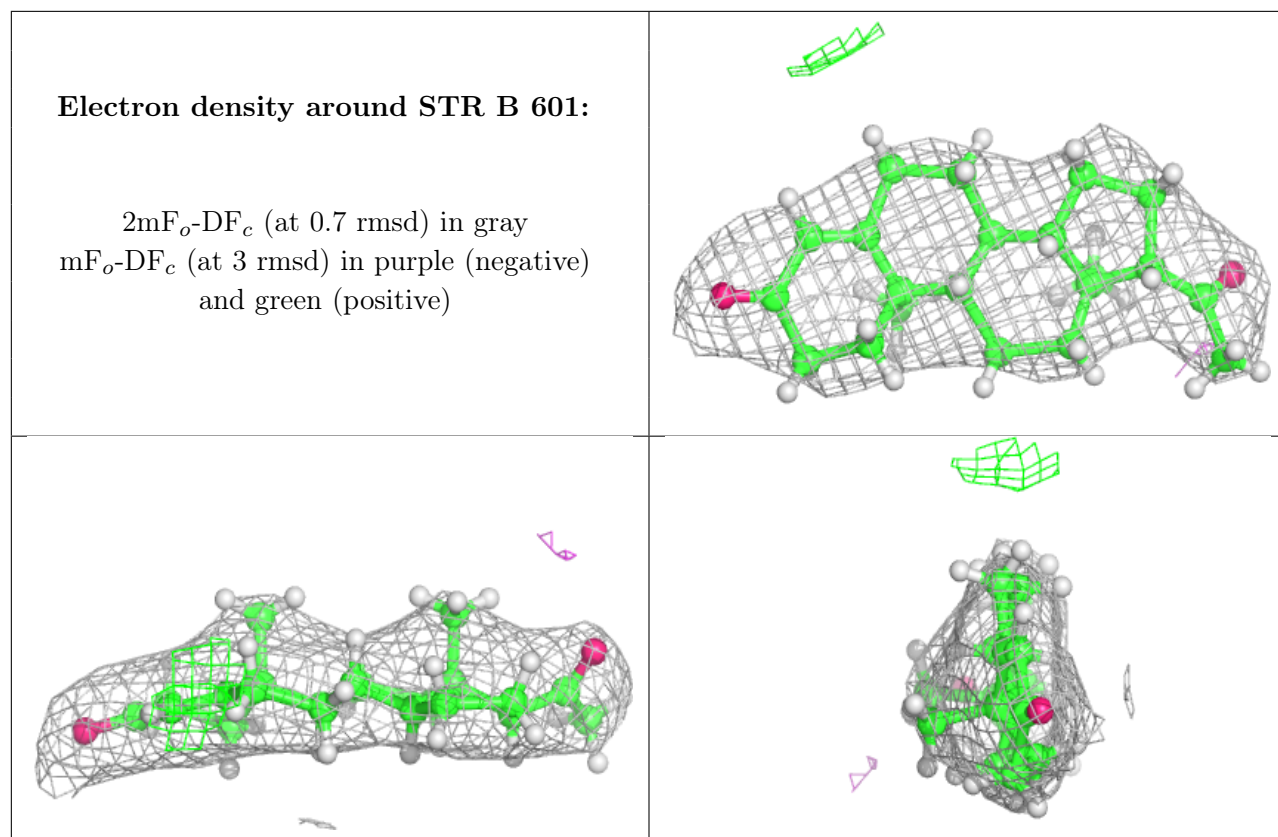

Electron density around HEM B 600:

$2mF_o-DF_c$ (at 0.7 rmsd) in gray
 mF_o-DF_c (at 3 rmsd) in purple (negative)
and green (positive)

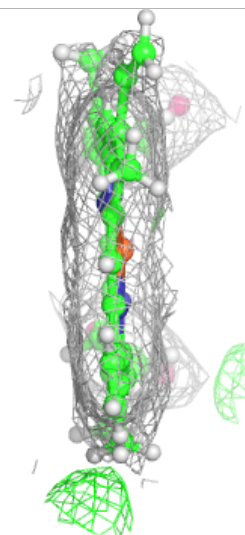
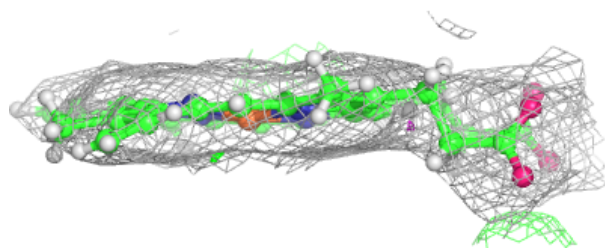
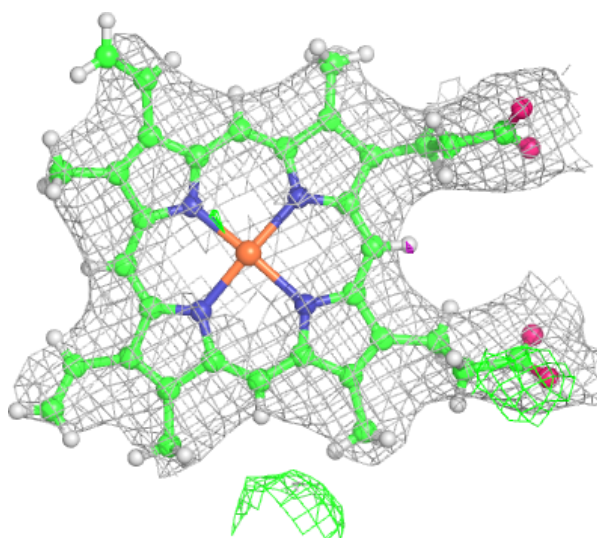

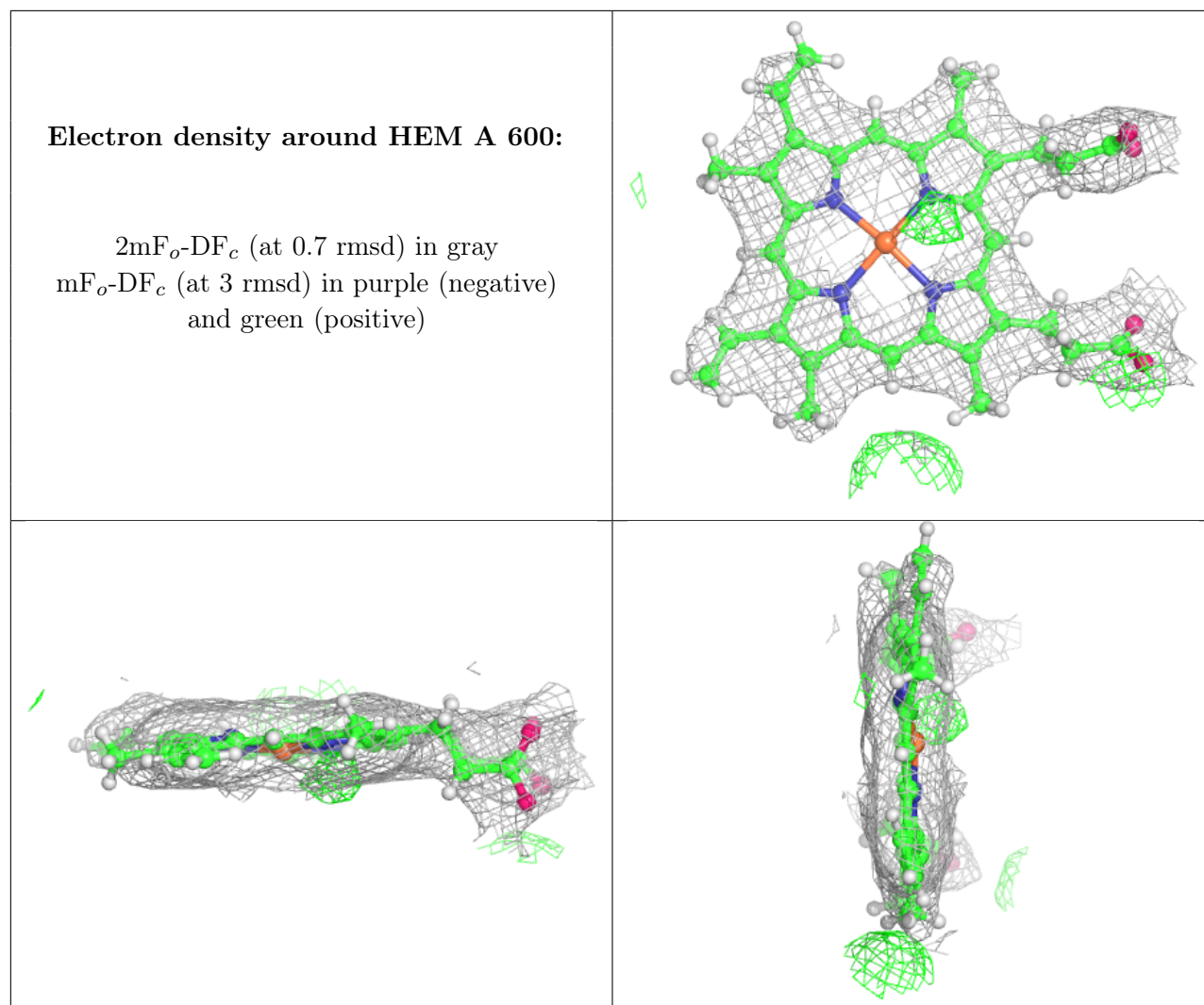

6.5 Other polymers [i](#)

There are no such residues in this entry.