



Full wwPDB X-ray Structure Validation Report ⓘ

Feb 23, 2022 – 12:15 pm GMT

PDB ID : 7NL1
Title : Crystal structure of cystathionine gamma-lyase from *Toxoplasma gondii*
Authors : Fernandez-Rodriguez, C.; Conter, C.; Recio, I.; Astegno, A.; Martinez-Cruz, L.A.
Deposited on : 2021-02-22
Resolution : 2.33 Å(reported)

This is a Full wwPDB X-ray Structure Validation Report for a publicly released PDB entry.

We welcome your comments at validation@mail.wwpdb.org

A user guide is available at

<https://www.wwpdb.org/validation/2017/XrayValidationReportHelp>

with specific help available everywhere you see the ⓘ symbol.

The following versions of software and data (see [references ⓘ](#)) were used in the production of this report:

MolProbity : 4.02b-467
Mogul : 1.8.4, CSD as541be (2020)
Xtriage (Phenix) : 1.13
EDS : 2.26
buster-report : 1.1.7 (2018)
Percentile statistics : 20191225.v01 (using entries in the PDB archive December 25th 2019)
Refmac : 5.8.0267
CCP4 : 7.1.010 (Gargrove)
Ideal geometry (proteins) : Engh & Huber (2001)
Ideal geometry (DNA, RNA) : Parkinson et al. (1996)
Validation Pipeline (wwPDB-VP) : 2.26

1 Overall quality at a glance

The following experimental techniques were used to determine the structure:

X-RAY DIFFRACTION

The reported resolution of this entry is 2.33 Å.

Percentile scores (ranging between 0-100) for global validation metrics of the entry are shown in the following graphic. The table shows the number of entries on which the scores are based.

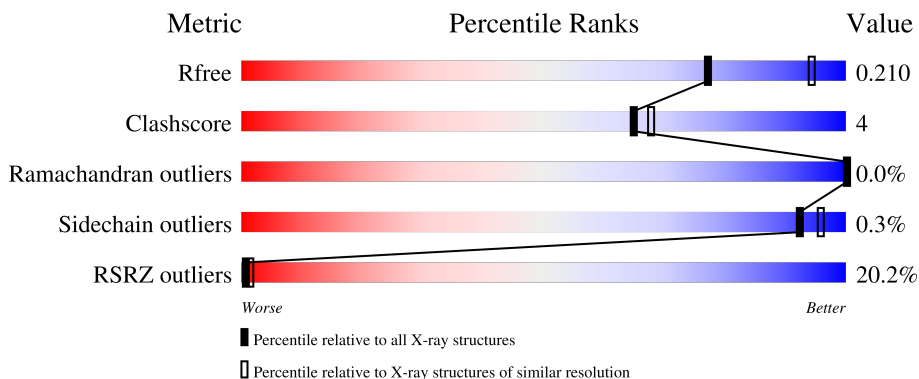



Metric	Whole archive (#Entries)	Similar resolution (#Entries, resolution range(Å))
R_{free}	130704	2096 (2.36-2.32)
Clashscore	141614	2193 (2.36-2.32)
Ramachandran outliers	138981	2159 (2.36-2.32)
Sidechain outliers	138945	2160 (2.36-2.32)
RSRZ outliers	127900	2067 (2.36-2.32)

The table below summarises the geometric issues observed across the polymeric chains and their fit to the electron density. The red, orange, yellow and green segments of the lower bar indicate the fraction of residues that contain outliers for ≥ 3 , 2, 1 and 0 types of geometric quality criteria respectively. A grey segment represents the fraction of residues that are not modelled. The numeric value for each fraction is indicated below the corresponding segment, with a dot representing fractions $\leq 5\%$. The upper red bar (where present) indicates the fraction of residues that have poor fit to the electron density. The numeric value is given above the bar.

Mol	Chain	Length	Quality of chain
1	A	417	 27% 87% 9% 5%
1	B	417	 19% 84% 10% 6%
1	C	417	 16% 87% 8% .
1	D	417	 16% 86% 10% .
1	E	417	 20% 80% 13% 7%

Continued on next page...

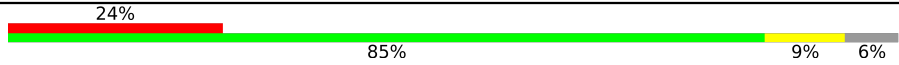
Continued from previous page...

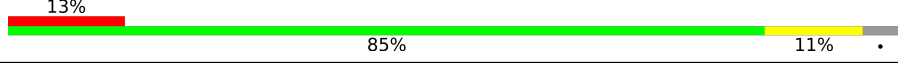
Mol	Chain	Length	Quality of chain
1	F	417	 <p>24% 85% 9% 6%</p>
1	G	417	 <p>18% 85% 10% 5%</p>
1	H	417	 <p>13% 85% 11% 5%</p>

2 Entry composition [i](#)

There are 3 unique types of molecules in this entry. The entry contains 25678 atoms, of which 0 are hydrogens and 0 are deuteriums.

In the tables below, the ZeroOcc column contains the number of atoms modelled with zero occupancy, the AltConf column contains the number of residues with at least one atom in alternate conformation and the Trace column contains the number of residues modelled with at most 2 atoms.

- Molecule 1 is a protein called Cystathione gamma lyase, putative.

Mol	Chain	Residues	Atoms					ZeroOcc	AltConf	Trace
			Total	C	N	O	S			
1	A	397	Total 3023	C 1930	N 509	O 564	S 20	0	1	0
1	C	399	Total 3075	C 1959	N 519	O 575	S 22	0	1	0
1	D	400	Total 3078	C 1963	N 519	O 574	S 22	0	0	0
1	E	389	Total 2969	C 1894	N 495	O 560	S 20	0	0	0
1	F	394	Total 3011	C 1921	N 509	O 561	S 20	0	0	0
1	G	397	Total 3044	C 1942	N 515	O 566	S 21	0	1	0
1	H	399	Total 3065	C 1953	N 518	O 572	S 22	0	0	0
1	B	391	Total 3001	C 1914	N 507	O 560	S 20	0	1	0

- Molecule 2 is PYRIDOXAL-5'-PHOSPHATE (three-letter code: PLP) (formula: C₈H₁₀NO₆P) (labeled as "Ligand of Interest" by depositor).



Mol	Chain	Residues	Atoms					ZeroOcc	AltConf
			Total	C	N	O	P		
2	A	1	Total 15	C 8	N 1	O 5	P 1	0	0
2	C	1	Total 15	C 8	N 1	O 5	P 1	0	0
2	D	1	Total 15	C 8	N 1	O 5	P 1	0	0
2	E	1	Total 15	C 8	N 1	O 5	P 1	0	0
2	F	1	Total 15	C 8	N 1	O 5	P 1	0	0
2	G	1	Total 15	C 8	N 1	O 5	P 1	0	0
2	H	1	Total 15	C 8	N 1	O 5	P 1	0	0
2	B	1	Total 15	C 8	N 1	O 5	P 1	0	0

- Molecule 3 is water.

Mol	Chain	Residues	Atoms		ZeroOcc	AltConf
3	A	149	Total 149	O 149	0	0
3	C	159	Total 159	O 159	0	0
3	D	165	Total 165	O 165	0	0
3	E	162	Total 162	O 162	0	0

Continued on next page...

Continued from previous page...

Mol	Chain	Residues	Atoms		ZeroOcc	AltConf
3	F	138	Total 138	O 138	0	0
3	G	169	Total 169	O 169	0	0
3	H	192	Total 192	O 192	0	0
3	B	158	Total 158	O 158	0	0

3 Residue-property plots [i](#)

These plots are drawn for all protein, RNA, DNA and oligosaccharide chains in the entry. The first graphic for a chain summarises the proportions of the various outlier classes displayed in the second graphic. The second graphic shows the sequence view annotated by issues in geometry and electron density. Residues are color-coded according to the number of geometric quality criteria for which they contain at least one outlier: green = 0, yellow = 1, orange = 2 and red = 3 or more. A red dot above a residue indicates a poor fit to the electron density ($RSRZ > 2$). Stretches of 2 or more consecutive residues without any outlier are shown as a green connector. Residues present in the sample, but not in the model, are shown in grey.

- Molecule 1: Cystathione gamma lyase, putative

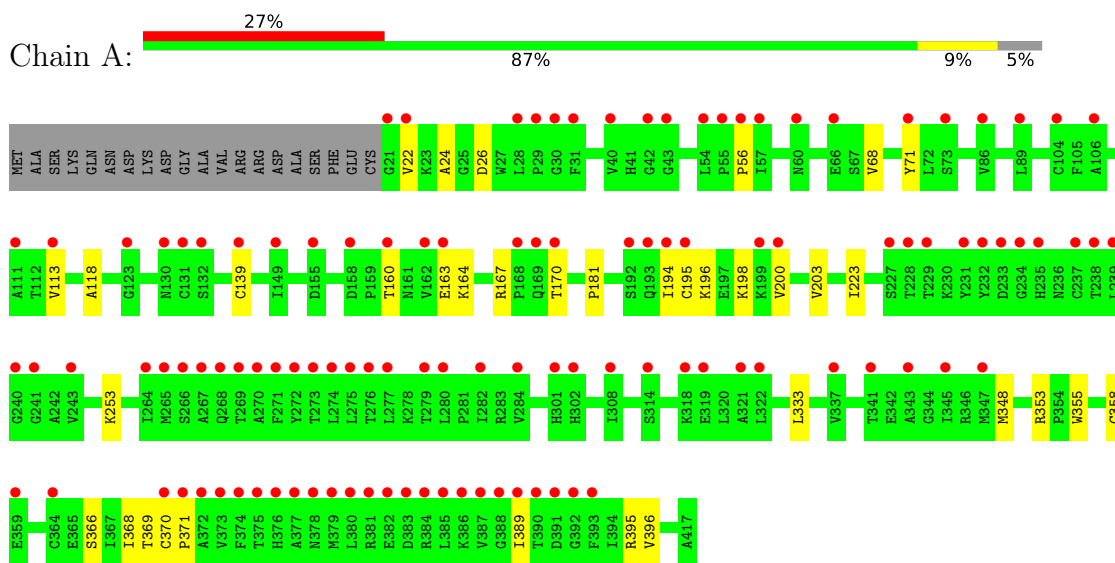

- Molecule 1: Cystathione gamma lyase, putative

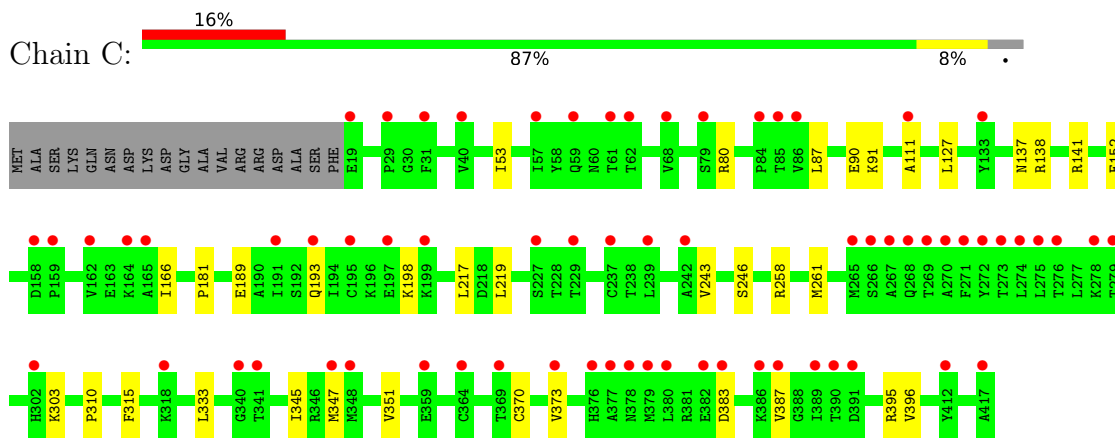

- Molecule 1: Cystathione gamma lyase, putative

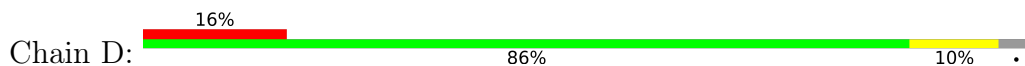

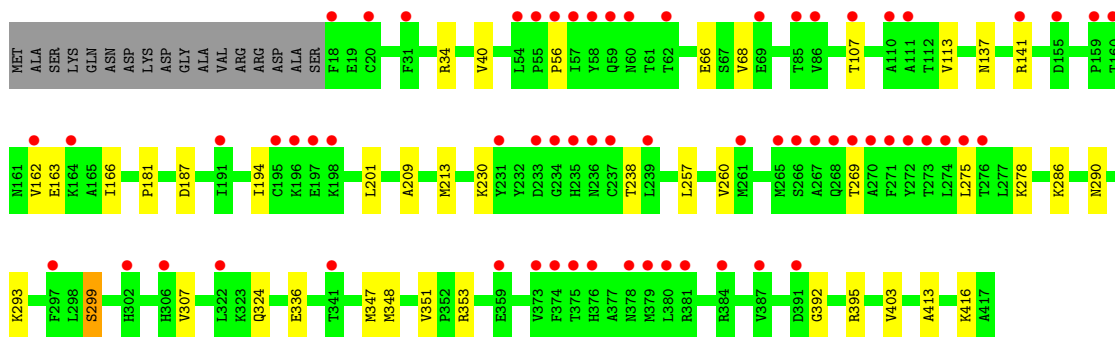

- Molecule 1: Cystathione gamma lyase, putative

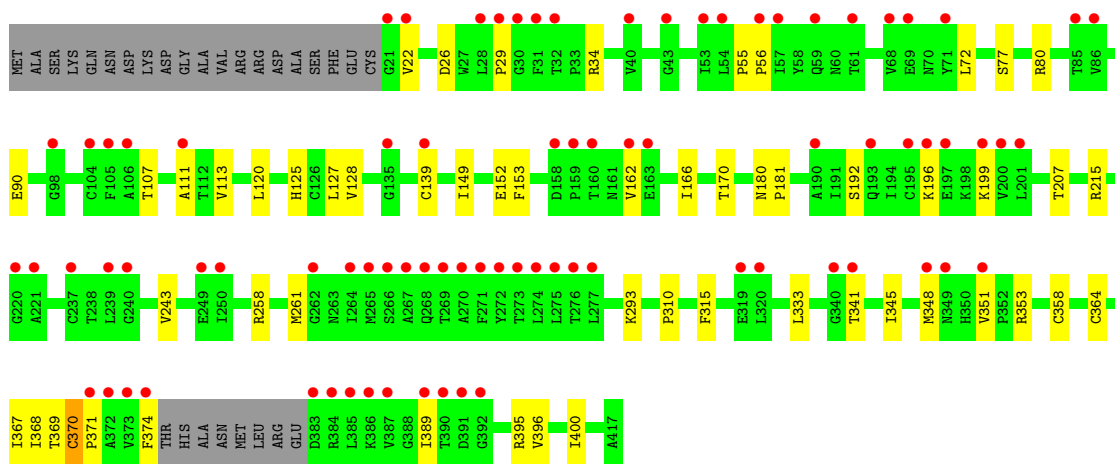
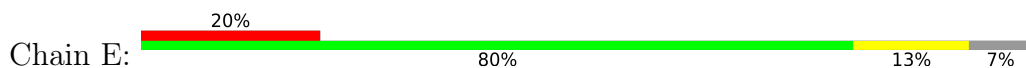

- Molecule 1: Cystathione gamma lyase, putative

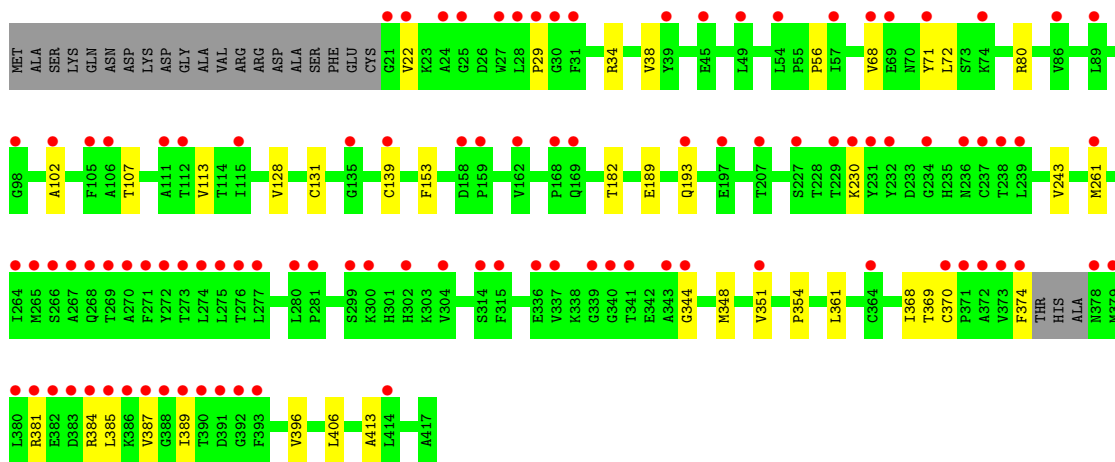
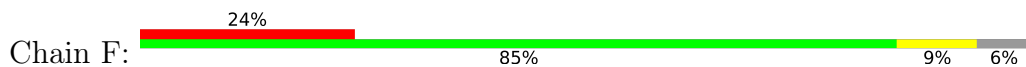

- Molecule 1: Cystathione gamma lyase, putative

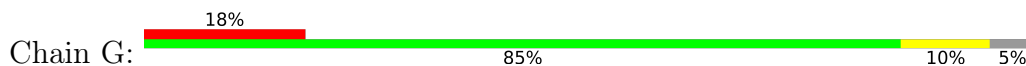

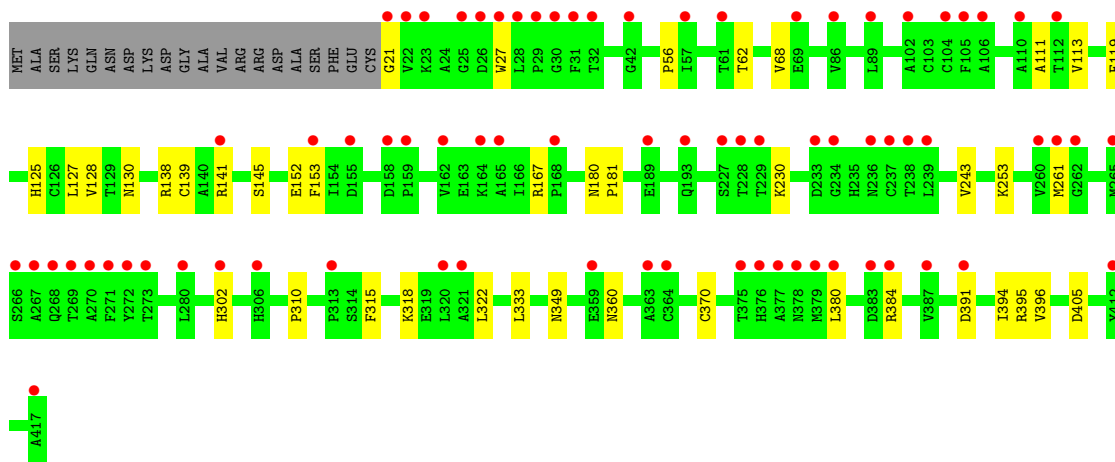

- Molecule 1: Cystathione gamma lyase, putative

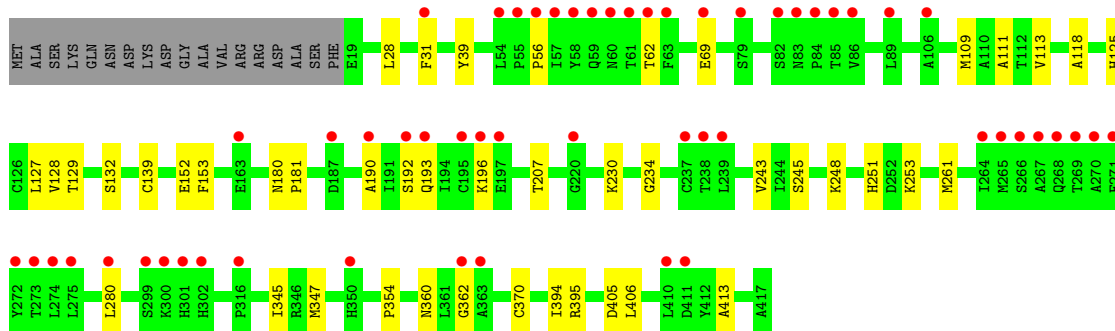
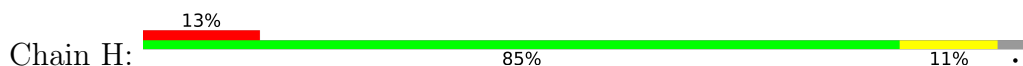

- Molecule 1: Cystathione gamma lyase, putative

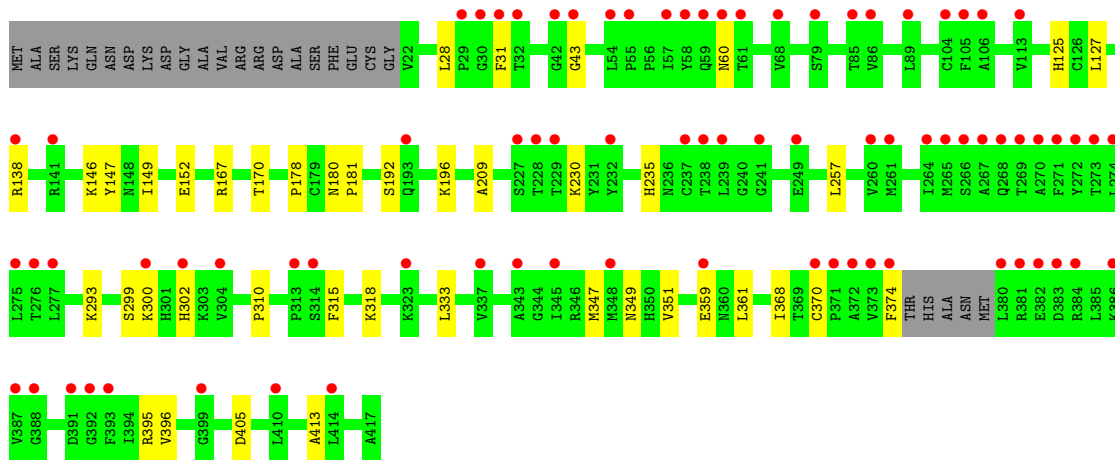
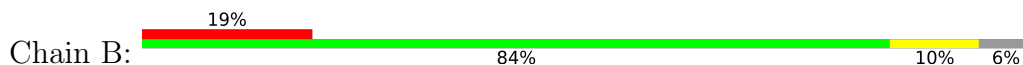

4 Data and refinement statistics

Property	Value	Source
Space group	C 2 2 21	Depositor
Cell constants a, b, c, α , β , γ	126.53Å 138.99Å 473.00Å 90.00° 90.00° 90.00°	Depositor
Resolution (Å)	48.45 – 2.33 48.45 – 2.33	Depositor EDS
% Data completeness (in resolution range)	100.0 (48.45-2.33) 100.0 (48.45-2.33)	Depositor EDS
R_{merge}	0.15	Depositor
R_{sym}	(Not available)	Depositor
$\langle I/\sigma(I) \rangle$ ¹	2.96 (at 2.34Å)	Xtriage
Refinement program	PHENIX 1.16_3549	Depositor
R, R_{free}	0.174 , 0.210 0.174 , 0.210	Depositor DCC
R_{free} test set	8762 reflections (4.95%)	wwPDB-VP
Wilson B-factor (Å ²)	43.7	Xtriage
Anisotropy	0.367	Xtriage
Bulk solvent k_{sol} (e/Å ³), B_{sol} (Å ²)	(Not available) , (Not available)	EDS
L-test for twinning ²	$\langle L \rangle = 0.46$, $\langle L^2 \rangle = 0.28$	Xtriage
Estimated twinning fraction	No twinning to report.	Xtriage
F_o, F_c correlation	0.96	EDS
Total number of atoms	25678	wwPDB-VP
Average B, all atoms (Å ²)	51.0	wwPDB-VP

Xtriage's analysis on translational NCS is as follows: *The largest off-origin peak in the Patterson function is 4.17% of the height of the origin peak. No significant pseudotranslation is detected.*

¹Intensities estimated from amplitudes.

²Theoretical values of $\langle |L| \rangle$, $\langle L^2 \rangle$ for acentric reflections are 0.5, 0.333 respectively for untwinned datasets, and 0.375, 0.2 for perfectly twinned datasets.

5 Model quality [i](#)

5.1 Standard geometry [i](#)

Bond lengths and bond angles in the following residue types are not validated in this section: PLP

The Z score for a bond length (or angle) is the number of standard deviations the observed value is removed from the expected value. A bond length (or angle) with $|Z| > 5$ is considered an outlier worth inspection. RMSZ is the root-mean-square of all Z scores of the bond lengths (or angles).

Mol	Chain	Bond lengths		Bond angles	
		RMSZ	# Z >5	RMSZ	# Z >5
1	A	0.27	0/3096	0.45	0/4207
1	B	0.27	0/3071	0.44	0/4169
1	C	0.27	0/3146	0.45	0/4271
1	D	0.28	0/3150	0.47	0/4275
1	E	0.27	0/3038	0.45	0/4127
1	F	0.27	0/3080	0.45	0/4182
1	G	0.27	0/3116	0.44	0/4235
1	H	0.27	0/3136	0.44	0/4258
All	All	0.27	0/24833	0.45	0/33724

There are no bond length outliers.

There are no bond angle outliers.

There are no chirality outliers.

There are no planarity outliers.

5.2 Too-close contacts [i](#)

In the following table, the Non-H and H(model) columns list the number of non-hydrogen atoms and hydrogen atoms in the chain respectively. The H(added) column lists the number of hydrogen atoms added and optimized by MolProbity. The Clashes column lists the number of clashes within the asymmetric unit, whereas Symm-Clashes lists symmetry-related clashes.

Mol	Chain	Non-H	H(model)	H(added)	Clashes	Symm-Clashes
1	A	3023	0	2966	24	0
1	B	3001	0	2938	31	0
1	C	3075	0	3033	23	0
1	D	3078	0	3038	29	0
1	E	2969	0	2902	38	0

Continued on next page...

Continued from previous page...

Mol	Chain	Non-H	H(model)	H(added)	Clashes	Symm-Clashes
1	F	3011	0	2961	27	0
1	G	3044	0	2986	30	0
1	H	3065	0	3026	28	0
2	A	15	0	7	0	0
2	B	15	0	7	0	0
2	C	15	0	7	0	0
2	D	15	0	7	1	0
2	E	15	0	7	1	0
2	F	15	0	7	0	0
2	G	15	0	7	0	0
2	H	15	0	7	2	0
3	A	149	0	0	3	0
3	B	158	0	0	5	0
3	C	159	0	0	4	0
3	D	165	0	0	3	0
3	E	162	0	0	4	0
3	F	138	0	0	1	0
3	G	169	0	0	4	0
3	H	192	0	0	1	0
All	All	25678	0	23906	200	0

The all-atom clashscore is defined as the number of clashes found per 1000 atoms (including hydrogen atoms). The all-atom clashscore for this structure is 4.

All (200) close contacts within the same asymmetric unit are listed below, sorted by their clash magnitude.

Atom-1	Atom-2	Interatomic distance (Å)	Clash overlap (Å)
1:E:348:MET:HE1	1:E:370:CYS:HB2	1.51	0.92
1:F:351:VAL:HG11	1:F:368:ILE:HG21	1.67	0.76
1:E:80:ARG:HG3	1:F:107:THR:HG21	1.69	0.74
1:D:416:LYS:NZ	3:D:601:HOH:O	2.21	0.72
1:A:163:GLU:HB2	1:A:194:ILE:HD13	1.72	0.72
1:B:192:SER:O	1:B:196:LYS:HG3	1.90	0.72
1:E:345:ILE:HD12	1:F:68:VAL:HG11	1.72	0.70
1:C:303:LYS:NZ	3:C:601:HOH:O	2.24	0.70
1:C:189[A]:GLU:HG3	1:C:219:LEU:HB3	1.73	0.69
1:F:348:MET:SD	1:F:370:CYS:HB2	2.33	0.68
1:C:141:ARG:NH2	3:C:602:HOH:O	2.25	0.68
1:E:113:VAL:HG22	1:E:139:CYS:SG	2.34	0.68
1:B:351:VAL:HG11	1:B:368:ILE:HG21	1.75	0.66
1:E:107:THR:HG21	1:F:80:ARG:HG3	1.76	0.66

Continued on next page...

Continued from previous page...

Atom-1	Atom-2	Interatomic distance (Å)	Clash overlap (Å)
1:C:80:ARG:HG3	1:D:107:THR:HG21	1.76	0.66
1:B:138:ARG:NH2	3:B:602:HOH:O	2.26	0.66
1:A:113:VAL:HG22	1:A:139:CYS:SG	2.36	0.65
1:E:215:ARG:NH1	3:E:601:HOH:O	2.29	0.65
1:B:318:LYS:NZ	3:B:604:HOH:O	2.30	0.64
1:A:348:MET:SD	1:A:370:CYS:HB2	2.39	0.63
1:D:299:SER:N	1:D:307:VAL:HG21	2.14	0.63
1:F:368:ILE:HD12	1:F:396:VAL:HG22	1.80	0.63
1:E:348:MET:HA	1:E:351:VAL:HG23	1.81	0.63
1:G:370:CYS:HB2	1:G:394:ILE:HD13	1.82	0.62
1:H:181:PRO:HB3	1:H:395:ARG:HD3	1.82	0.61
1:F:56:PRO:HB2	1:G:56:PRO:HB2	1.82	0.60
1:B:293:LYS:NZ	3:B:605:HOH:O	2.34	0.60
1:B:230:LYS:HD2	1:B:361:LEU:HG	1.83	0.59
1:G:380:LEU:HD21	1:B:302[B]:HIS:CG	2.37	0.59
1:E:34:ARG:NH1	1:G:405:ASP:OD1	2.35	0.59
1:B:147:TYR:HB2	1:B:149:ILE:HD12	1.85	0.58
1:H:118:ALA:O	1:H:253:LYS:NZ	2.36	0.57
1:B:370:CYS:O	1:B:374:PHE:HB2	2.04	0.57
1:E:22:VAL:HG13	1:E:26:ASP:HB2	1.85	0.57
1:E:293:LYS:NZ	3:E:610:HOH:O	2.39	0.56
1:C:261:MET:HA	1:D:113:VAL:HG21	1.86	0.56
1:E:127:LEU:HD23	1:E:152:GLU:HB3	1.88	0.55
1:G:181:PRO:HB3	1:G:395:ARG:HD3	1.88	0.55
1:D:137:ASN:HD21	1:D:141:ARG:NH2	2.03	0.55
1:E:192:SER:O	1:E:196:LYS:HG3	2.06	0.55
1:C:166:ILE:HG21	1:C:198:LYS:HD3	1.88	0.55
1:E:261:MET:HG2	1:F:113:VAL:HG11	1.87	0.55
1:A:203:VAL:HG22	1:A:223:ILE:HB	1.90	0.54
1:F:34:ARG:NH1	1:H:405:ASP:OD1	2.40	0.54
1:A:113:VAL:CG2	1:A:139:CYS:SG	2.96	0.53
1:G:302[A]:HIS:ND1	3:G:605:HOH:O	2.34	0.53
1:A:371:PRO:HB2	1:A:389:ILE:HD13	1.91	0.53
1:E:113:VAL:HG11	1:F:261:MET:HG2	1.91	0.53
1:F:131:CYS:HG	1:F:182:THR:HG1	1.47	0.53
1:A:22:VAL:HG13	1:A:26:ASP:HB2	1.91	0.52
1:E:22:VAL:HG21	1:E:29:PRO:HD3	1.90	0.52
1:H:234:GLY:HA2	1:H:362:GLY:O	2.08	0.52
1:H:129:THR:HG23	1:H:132:SER:HB3	1.92	0.52
1:D:353:ARG:NH1	3:D:612:HOH:O	2.41	0.52
1:C:137:ASN:HD21	1:C:141:ARG:HH21	1.56	0.52

Continued on next page...

Continued from previous page...

Atom-1	Atom-2	Interatomic distance (Å)	Clash overlap (Å)
1:E:341:THR:O	1:E:345:ILE:HG12	2.10	0.51
1:G:138:ARG:NH1	3:G:612:HOH:O	2.43	0.51
1:D:137:ASN:HD21	1:D:141:ARG:HH21	1.58	0.51
1:E:120:LEU:HD13	1:E:149:ILE:HG21	1.91	0.51
1:E:333:LEU:HG	1:E:396:VAL:HB	1.93	0.51
1:H:190:ALA:O	1:H:193:GLN:HG3	2.11	0.51
1:B:125:HIS:CE1	1:B:167:ARG:HD3	2.45	0.51
1:G:349:ASN:ND2	1:H:69:GLU:OE2	2.37	0.50
1:D:163:GLU:HB2	1:D:194:ILE:HD13	1.94	0.50
1:F:22:VAL:HG21	1:F:29:PRO:HD3	1.94	0.49
1:H:354:PRO:HG2	1:H:406:LEU:HD23	1.94	0.49
1:G:111:ALA:HB1	1:G:243:VAL:HG23	1.93	0.49
1:E:72:LEU:HD21	1:E:77:SER:HB2	1.94	0.49
1:A:170:THR:HG22	1:A:200:VAL:HG21	1.93	0.49
1:H:28:LEU:O	1:H:31:PHE:HB2	2.13	0.49
1:C:87:LEU:O	1:C:91:LYS:HG2	2.13	0.49
1:D:181:PRO:HB3	1:D:395:ARG:HD3	1.95	0.49
1:F:369:THR:HG23	1:F:374:PHE:HD2	1.78	0.48
1:G:62:THR:HB	1:H:360:ASN:HB2	1.95	0.48
1:E:370:CYS:O	1:E:374:PHE:HB2	2.13	0.48
1:E:125:HIS:HD1	1:E:170:THR:HG1	1.59	0.48
1:G:261:MET:HA	1:H:113:VAL:HG21	1.95	0.48
1:B:43:GLY:N	3:B:620:HOH:O	2.46	0.48
1:G:380:LEU:HD11	1:B:302[A]:HIS:CD2	2.49	0.48
1:F:230:LYS:HG3	1:F:361:LEU:HG	1.95	0.48
1:D:347:MET:HG2	1:D:413:ALA:HB1	1.96	0.48
1:G:380:LEU:HD11	1:B:302[A]:HIS:CG	2.49	0.48
1:C:138:ARG:NH1	3:C:610:HOH:O	2.47	0.47
1:F:354:PRO:HG2	1:F:406:LEU:HD23	1.97	0.47
1:F:381:ARG:O	1:F:385:LEU:HD12	2.15	0.47
1:E:56:PRO:HB2	1:H:56:PRO:HB2	1.95	0.47
1:A:160:THR:O	1:A:164:LYS:HG3	2.15	0.47
1:E:111:ALA:HB1	1:E:243:VAL:HG23	1.97	0.47
1:G:130:ASN:N	1:G:130:ASN:OD1	2.48	0.47
1:E:364:CYS:HB3	1:E:400:ILE:HG12	1.97	0.46
1:A:56:PRO:HB2	1:D:56:PRO:HB2	1.97	0.46
1:A:198:LYS:NZ	3:A:618:HOH:O	2.47	0.46
1:G:127:LEU:HD23	1:G:152:GLU:HB3	1.96	0.46
1:H:248:LYS:NZ	3:H:616:HOH:O	2.48	0.46
1:D:348:MET:O	1:D:351:VAL:HG12	2.14	0.46
1:H:109:MET:HE3	2:H:501:PLP:H5A2	1.98	0.46

Continued on next page...

Continued from previous page...

Atom-1	Atom-2	Interatomic distance (Å)	Clash overlap (Å)
1:F:384:ARG:HA	1:F:387:VAL:HG22	1.97	0.46
1:B:28:LEU:O	1:B:31:PHE:HB2	2.15	0.46
1:H:192:SER:O	1:H:196:LYS:HG3	2.16	0.46
1:B:146:LYS:NZ	3:B:608:HOH:O	2.36	0.46
1:H:347:MET:HG2	1:H:413:ALA:HB1	1.97	0.46
1:E:358:CYS:SG	1:E:367:ILE:HG12	2.56	0.46
1:H:370:CYS:HB2	1:H:394:ILE:HD13	1.96	0.46
1:A:368:ILE:HD13	1:A:396:VAL:HG22	1.98	0.46
1:C:193:GLN:NE2	3:C:613:HOH:O	2.49	0.46
1:E:113:VAL:HG21	1:F:261:MET:HA	1.98	0.46
1:G:180:ASN:HA	1:G:181:PRO:HA	1.81	0.46
1:C:345:ILE:HG12	1:D:68:VAL:HG11	1.97	0.45
1:F:344:GLY:O	1:F:348:MET:HE2	2.16	0.45
1:G:113:VAL:HG21	1:H:261:MET:HA	1.97	0.45
1:A:358:CYS:O	1:A:369:THR:HG22	2.17	0.45
1:F:71:TYR:CE2	1:F:72:LEU:HD23	2.51	0.45
1:G:128:VAL:O	1:G:153:PHE:HA	2.17	0.45
1:B:310:PRO:HA	1:B:315:PHE:CG	2.52	0.45
1:H:180:ASN:HA	1:H:181:PRO:HA	1.85	0.45
1:B:178:PRO:HD3	1:B:209:ALA:HB2	1.99	0.45
1:B:299:SER:OG	1:B:300:LYS:HE2	2.16	0.45
1:C:181:PRO:HB3	1:C:395:ARG:HD3	1.99	0.45
1:C:310:PRO:HA	1:C:315:PHE:CG	2.51	0.45
1:D:209:ALA:HA	1:D:213:MET:HE1	1.98	0.45
1:E:207:THR:HB	2:E:501:PLP:H2A2	1.99	0.45
1:F:189:GLU:O	1:F:193:GLN:HG3	2.17	0.45
1:C:333:LEU:HG	1:C:396:VAL:HB	1.99	0.45
1:D:257:LEU:HD12	1:D:257:LEU:HA	1.79	0.45
1:C:53:ILE:HG22	1:B:60:ASN:OD1	2.17	0.44
1:G:21:GLY:N	3:G:621:HOH:O	2.49	0.44
1:A:196[A]:LYS:HA	1:A:196[A]:LYS:HD2	1.73	0.44
1:F:34:ARG:O	1:F:38:VAL:HG23	2.17	0.44
1:D:336:GLU:HA	1:D:392:GLY:O	2.18	0.44
1:E:310:PRO:HA	1:E:315:PHE:CG	2.52	0.44
1:F:351:VAL:HA	1:F:413:ALA:HB2	1.99	0.44
1:G:384:ARG:NH2	1:G:391:ASP:OD1	2.50	0.44
1:A:71:TYR:OH	1:B:359:GLU:OE1	2.34	0.44
1:B:351:VAL:HA	1:B:413:ALA:HB2	2.00	0.44
1:E:180:ASN:ND2	3:E:609:HOH:O	2.36	0.44
1:G:318:LYS:O	1:G:322:LEU:HD12	2.18	0.44
1:C:111:ALA:HB1	1:C:243:VAL:HG23	2.00	0.44

Continued on next page...

Continued from previous page...

Atom-1	Atom-2	Interatomic distance (Å)	Clash overlap (Å)
1:C:347:MET:O	1:C:351:VAL:HG13	2.18	0.44
1:E:162:VAL:O	1:E:166:ILE:HG13	2.18	0.44
1:B:125:HIS:HB3	1:B:170:THR:HA	2.00	0.44
1:B:181:PRO:HB3	1:B:395:ARG:HD3	2.00	0.44
1:H:125:HIS:HE2	1:H:152:GLU:HB2	1.84	0.43
1:C:217:LEU:HD22	1:C:246:SER:HB3	2.00	0.43
1:D:40:VAL:HA	1:D:278:LYS:HG2	2.00	0.43
1:D:201:LEU:HD23	1:D:201:LEU:HA	1.86	0.43
1:A:24:ALA:HA	1:C:351:VAL:O	2.17	0.43
1:D:286:LYS:HE3	1:D:290:ASN:HD21	1.84	0.43
1:G:125:HIS:CE1	1:G:167:ARG:HD2	2.53	0.43
1:D:293:LYS:HD2	1:D:403:VAL:HG11	2.00	0.43
1:G:68:VAL:HG11	1:H:345:ILE:HG12	2.00	0.43
1:A:68:VAL:HG23	1:B:349:ASN:OD1	2.18	0.43
1:D:187:ASP:HA	1:D:324:GLN:OE1	2.19	0.42
1:G:141:ARG:O	1:G:145:SER:OG	2.36	0.42
1:H:207:THR:HB	2:H:501:PLP:H2A2	2.00	0.42
1:A:167:ARG:NE	3:A:613:HOH:O	2.44	0.42
1:A:195:CYS:HB3	1:A:200:VAL:HG13	2.01	0.42
1:G:119:PHE:CE1	1:G:253:LYS:HD3	2.54	0.42
1:G:167:ARG:NH2	3:G:609:HOH:O	2.41	0.42
1:A:181:PRO:HB3	1:A:395:ARG:HD3	2.01	0.42
1:C:370:CYS:SG	1:C:373:VAL:HG22	2.60	0.42
1:D:34:ARG:HD2	1:B:405:ASP:OD1	2.20	0.42
1:A:355:TRP:CE3	1:A:366:SER:HB3	2.55	0.42
1:B:257:LEU:HD12	1:B:257:LEU:HA	1.87	0.42
1:B:180:ASN:HA	1:B:181:PRO:HA	1.86	0.42
1:A:333:LEU:HG	1:A:396:VAL:HB	2.02	0.42
1:A:353:ARG:NH1	3:A:601:HOH:O	2.52	0.42
1:E:371:PRO:HB2	1:E:389:ILE:HG21	2.00	0.42
1:B:127:LEU:HD23	1:B:152:GLU:HB3	2.01	0.42
1:D:257:LEU:HD12	1:D:260:VAL:HB	2.02	0.42
1:H:39:TYR:CE2	1:H:280:LEU:HD22	2.55	0.42
1:A:118:ALA:O	1:A:253:LYS:HE3	2.19	0.41
1:D:66:GLU:HG2	3:D:709:HOH:O	2.19	0.41
1:E:128:VAL:O	1:E:153:PHE:HA	2.20	0.41
1:C:383:ASP:O	1:C:387:VAL:HG22	2.19	0.41
1:F:128:VAL:O	1:F:153:PHE:HA	2.21	0.41
1:F:387:VAL:HG12	3:F:1405:HOH:O	2.20	0.41
1:F:387:VAL:HG23	1:F:389:ILE:HD13	2.03	0.41
1:H:245:SER:HB2	1:H:251:HIS:HB2	2.01	0.41

Continued on next page...

Continued from previous page...

Atom-1	Atom-2	Interatomic distance (Å)	Clash overlap (Å)
1:E:181:PRO:HB3	1:E:395:ARG:HD3	2.02	0.41
1:D:275:LEU:HD22	1:B:235:HIS:HB3	2.03	0.41
1:H:111:ALA:HB1	1:H:243:VAL:HG23	2.01	0.41
1:D:162:VAL:O	1:D:166:ILE:HG13	2.21	0.41
1:E:55:PRO:HB2	3:E:649:HOH:O	2.20	0.41
1:B:347:MET:HG2	1:B:413:ALA:HB1	2.03	0.41
1:C:127:LEU:HD23	1:C:152:GLU:HB3	2.03	0.41
1:D:238:THR:HB	1:D:269:THR:HG23	2.03	0.41
1:E:368:ILE:HD12	1:E:396:VAL:HG22	2.02	0.41
1:G:310:PRO:HA	1:G:315:PHE:CG	2.56	0.41
1:G:360:ASN:HB2	1:H:62:THR:HB	2.02	0.41
1:B:333:LEU:HG	1:B:396:VAL:HB	2.03	0.41
1:D:230:LYS:NZ	2:D:501:PLP:O3	2.54	0.40
1:E:353:ARG:HB2	1:G:27:TRP:CD2	2.56	0.40
1:E:369:THR:CG2	1:E:395:ARG:HB3	2.51	0.40
1:C:90:GLU:OE2	1:C:258:ARG:NH1	2.43	0.40
1:H:127:LEU:HD23	1:H:152:GLU:HB3	2.02	0.40
1:H:128:VAL:O	1:H:153:PHE:HA	2.20	0.40
1:F:102:ALA:HA	1:F:243:VAL:O	2.21	0.40
1:D:416:LYS:HA	1:D:416:LYS:HD2	1.85	0.40
1:E:90:GLU:OE2	1:E:258:ARG:NH1	2.42	0.40
1:G:333:LEU:HG	1:G:396:VAL:HB	2.02	0.40

There are no symmetry-related clashes.

5.3 Torsion angles [i](#)

5.3.1 Protein backbone [i](#)

In the following table, the Percentiles column shows the percent Ramachandran outliers of the chain as a percentile score with respect to all X-ray entries followed by that with respect to entries of similar resolution.

The Analysed column shows the number of residues for which the backbone conformation was analysed, and the total number of residues.

Mol	Chain	Analysed	Favoured	Allowed	Outliers	Percentiles	
1	A	396/417 (95%)	383 (97%)	13 (3%)	0	100	100
1	B	388/417 (93%)	376 (97%)	12 (3%)	0	100	100
1	C	398/417 (95%)	385 (97%)	13 (3%)	0	100	100

Continued on next page...

Continued from previous page...

Mol	Chain	Analysed	Favoured	Allowed	Outliers	Percentiles	
1	D	398/417 (95%)	382 (96%)	15 (4%)	1 (0%)	41	47
1	E	385/417 (92%)	370 (96%)	15 (4%)	0	100	100
1	F	390/417 (94%)	375 (96%)	15 (4%)	0	100	100
1	G	396/417 (95%)	384 (97%)	12 (3%)	0	100	100
1	H	397/417 (95%)	385 (97%)	12 (3%)	0	100	100
All	All	3148/3336 (94%)	3040 (97%)	107 (3%)	1 (0%)	100	100

All (1) Ramachandran outliers are listed below:

Mol	Chain	Res	Type
1	D	299	SER

5.3.2 Protein sidechains [i](#)

In the following table, the Percentiles column shows the percent sidechain outliers of the chain as a percentile score with respect to all X-ray entries followed by that with respect to entries of similar resolution.

The Analysed column shows the number of residues for which the sidechain conformation was analysed, and the total number of residues.

Mol	Chain	Analysed	Rotameric	Outliers	Percentiles	
1	A	325/354 (92%)	325 (100%)	0	100	100
1	B	324/354 (92%)	324 (100%)	0	100	100
1	C	336/354 (95%)	336 (100%)	0	100	100
1	D	336/354 (95%)	336 (100%)	0	100	100
1	E	322/354 (91%)	320 (99%)	2 (1%)	86	92
1	F	326/354 (92%)	325 (100%)	1 (0%)	92	96
1	G	329/354 (93%)	327 (99%)	2 (1%)	86	92
1	H	335/354 (95%)	333 (99%)	2 (1%)	86	92
All	All	2633/2832 (93%)	2626 (100%)	7 (0%)	92	96

All (7) residues with a non-rotameric sidechain are listed below:

Mol	Chain	Res	Type
1	E	199	LYS
1	E	370	CYS

Continued on next page...

Continued from previous page...

Mol	Chain	Res	Type
1	F	139	CYS
1	G	139	CYS
1	G	230	LYS
1	H	139	CYS
1	H	230	LYS

Sometimes sidechains can be flipped to improve hydrogen bonding and reduce clashes. All (4) such sidechains are listed below:

Mol	Chain	Res	Type
1	C	143	HIS
1	D	137	ASN
1	G	137	ASN
1	H	143	HIS

5.3.3 RNA [i](#)

There are no RNA molecules in this entry.

5.4 Non-standard residues in protein, DNA, RNA chains [i](#)

There are no non-standard protein/DNA/RNA residues in this entry.

5.5 Carbohydrates [i](#)

There are no monosaccharides in this entry.

5.6 Ligand geometry [i](#)

8 ligands are modelled in this entry.

In the following table, the Counts columns list the number of bonds (or angles) for which Mogul statistics could be retrieved, the number of bonds (or angles) that are observed in the model and the number of bonds (or angles) that are defined in the Chemical Component Dictionary. The Link column lists molecule types, if any, to which the group is linked. The Z score for a bond length (or angle) is the number of standard deviations the observed value is removed from the expected value. A bond length (or angle) with $|Z| > 2$ is considered an outlier worth inspection. RMSZ is the root-mean-square of all Z scores of the bond lengths (or angles).

Mol	Type	Chain	Res	Link	Bond lengths			Bond angles		
					Counts	RMSZ	# Z > 2	Counts	RMSZ	# Z > 2
2	PLP	G	501	1	15,15,16	1.14	1 (6%)	20,22,23	0.99	1 (5%)
2	PLP	B	501	1	15,15,16	1.15	1 (6%)	20,22,23	0.97	1 (5%)
2	PLP	H	501	1	15,15,16	1.12	0	20,22,23	0.96	1 (5%)
2	PLP	F	501	1	15,15,16	1.14	1 (6%)	20,22,23	0.96	0
2	PLP	C	501	1	15,15,16	1.16	1 (6%)	20,22,23	0.94	1 (5%)
2	PLP	E	501	1	15,15,16	1.12	1 (6%)	20,22,23	0.98	1 (5%)
2	PLP	D	501	1	15,15,16	1.12	0	20,22,23	0.94	0
2	PLP	A	501	1	15,15,16	1.13	1 (6%)	20,22,23	0.93	1 (5%)

In the following table, the Chirals column lists the number of chiral outliers, the number of chiral centers analysed, the number of these observed in the model and the number defined in the Chemical Component Dictionary. Similar counts are reported in the Torsion and Rings columns. '-' means no outliers of that kind were identified.

Mol	Type	Chain	Res	Link	Chirals	Torsions	Rings
2	PLP	G	501	1	-	0/6/6/8	0/1/1/1
2	PLP	B	501	1	-	0/6/6/8	0/1/1/1
2	PLP	H	501	1	-	0/6/6/8	0/1/1/1
2	PLP	F	501	1	-	0/6/6/8	0/1/1/1
2	PLP	C	501	1	-	0/6/6/8	0/1/1/1
2	PLP	E	501	1	-	0/6/6/8	0/1/1/1
2	PLP	D	501	1	-	0/6/6/8	0/1/1/1
2	PLP	A	501	1	-	0/6/6/8	0/1/1/1

All (6) bond length outliers are listed below:

Mol	Chain	Res	Type	Atoms	Z	Observed(Å)	Ideal(Å)
2	C	501	PLP	C3-C2	-2.25	1.38	1.40
2	E	501	PLP	C3-C2	-2.19	1.38	1.40
2	F	501	PLP	C3-C2	-2.17	1.38	1.40
2	B	501	PLP	C3-C2	-2.12	1.38	1.40
2	A	501	PLP	C3-C2	-2.02	1.38	1.40
2	G	501	PLP	C3-C2	-2.02	1.38	1.40

All (6) bond angle outliers are listed below:

Mol	Chain	Res	Type	Atoms	Z	Observed(°)	Ideal(°)
2	G	501	PLP	C5-C6-N1	-2.15	120.23	123.82
2	C	501	PLP	C5-C6-N1	-2.07	120.37	123.82
2	E	501	PLP	C5-C6-N1	-2.06	120.38	123.82

Continued on next page...

Continued from previous page...

Mol	Chain	Res	Type	Atoms	Z	Observed(°)	Ideal(°)
2	H	501	PLP	C5-C6-N1	-2.06	120.39	123.82
2	A	501	PLP	C5-C6-N1	-2.03	120.44	123.82
2	B	501	PLP	C5-C6-N1	-2.03	120.44	123.82

There are no chirality outliers.

There are no torsion outliers.

There are no ring outliers.

3 monomers are involved in 4 short contacts:

Mol	Chain	Res	Type	Clashes	Symm-Clashes
2	H	501	PLP	2	0
2	E	501	PLP	1	0
2	D	501	PLP	1	0

The following is a two-dimensional graphical depiction of Mogul quality analysis of bond lengths, bond angles, torsion angles, and ring geometry for all instances of the Ligand of Interest. In addition, ligands with molecular weight > 250 and outliers as shown on the validation Tables will also be included. For torsion angles, if less than 5% of the Mogul distribution of torsion angles is within 10 degrees of the torsion angle in question, then that torsion angle is considered an outlier. Any bond that is central to one or more torsion angles identified as an outlier by Mogul will be highlighted in the graph. For rings, the root-mean-square deviation (RMSD) between the ring in question and similar rings identified by Mogul is calculated over all ring torsion angles. If the average RMSD is greater than 60 degrees and the minimal RMSD between the ring in question and any Mogul-identified rings is also greater than 60 degrees, then that ring is considered an outlier. The outliers are highlighted in purple. The color gray indicates Mogul did not find sufficient equivalents in the CSD to analyse the geometry.

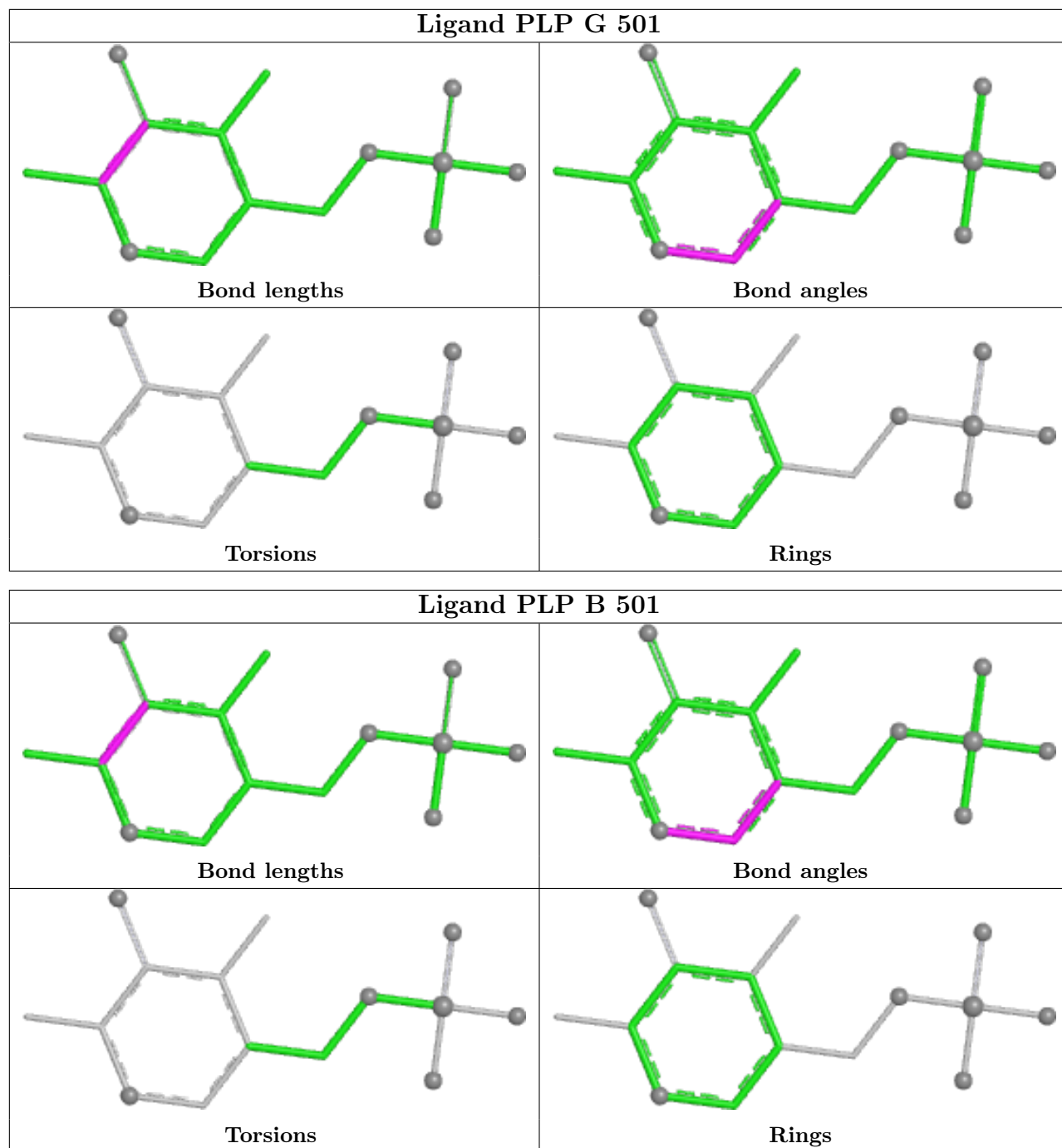

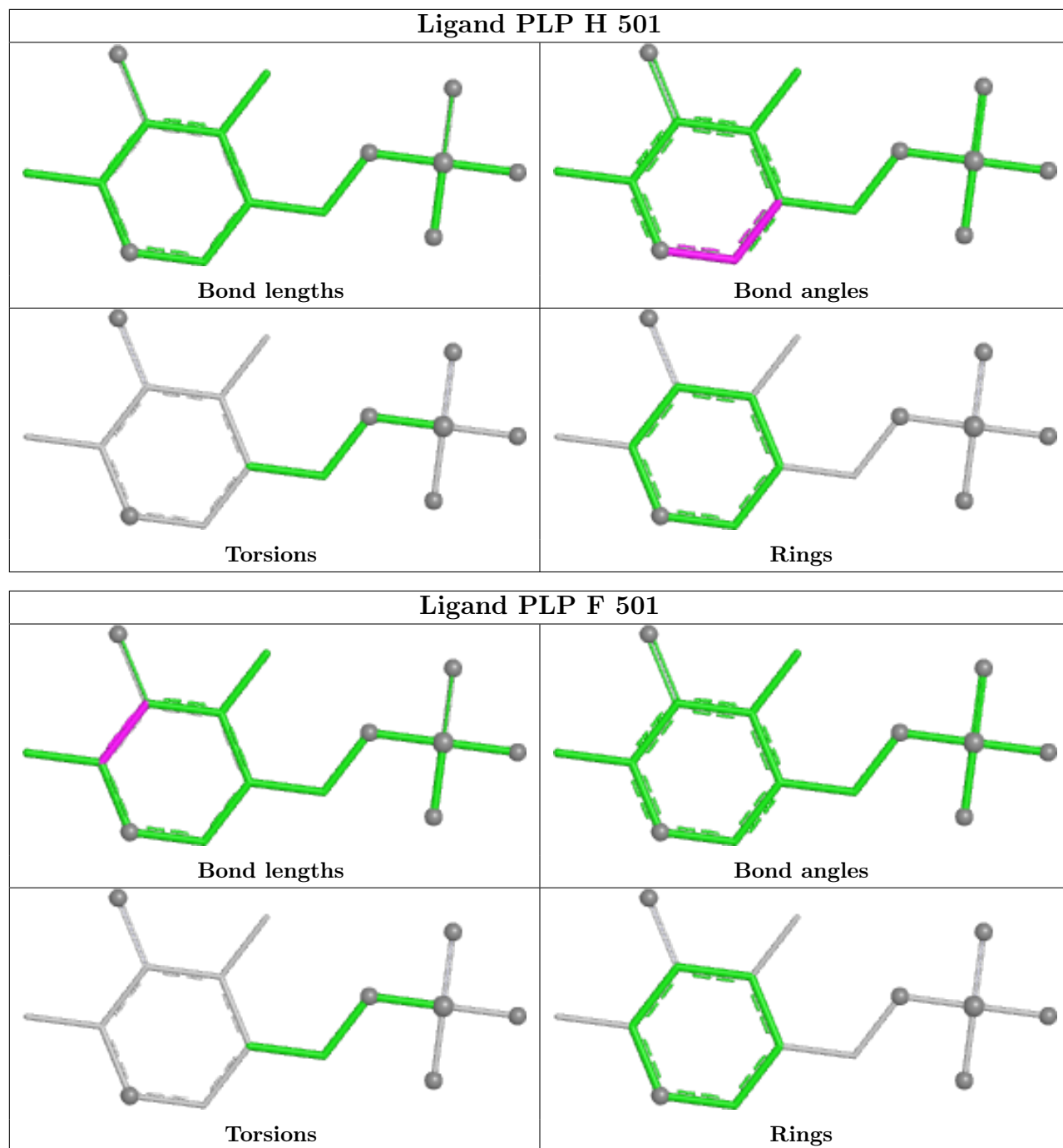

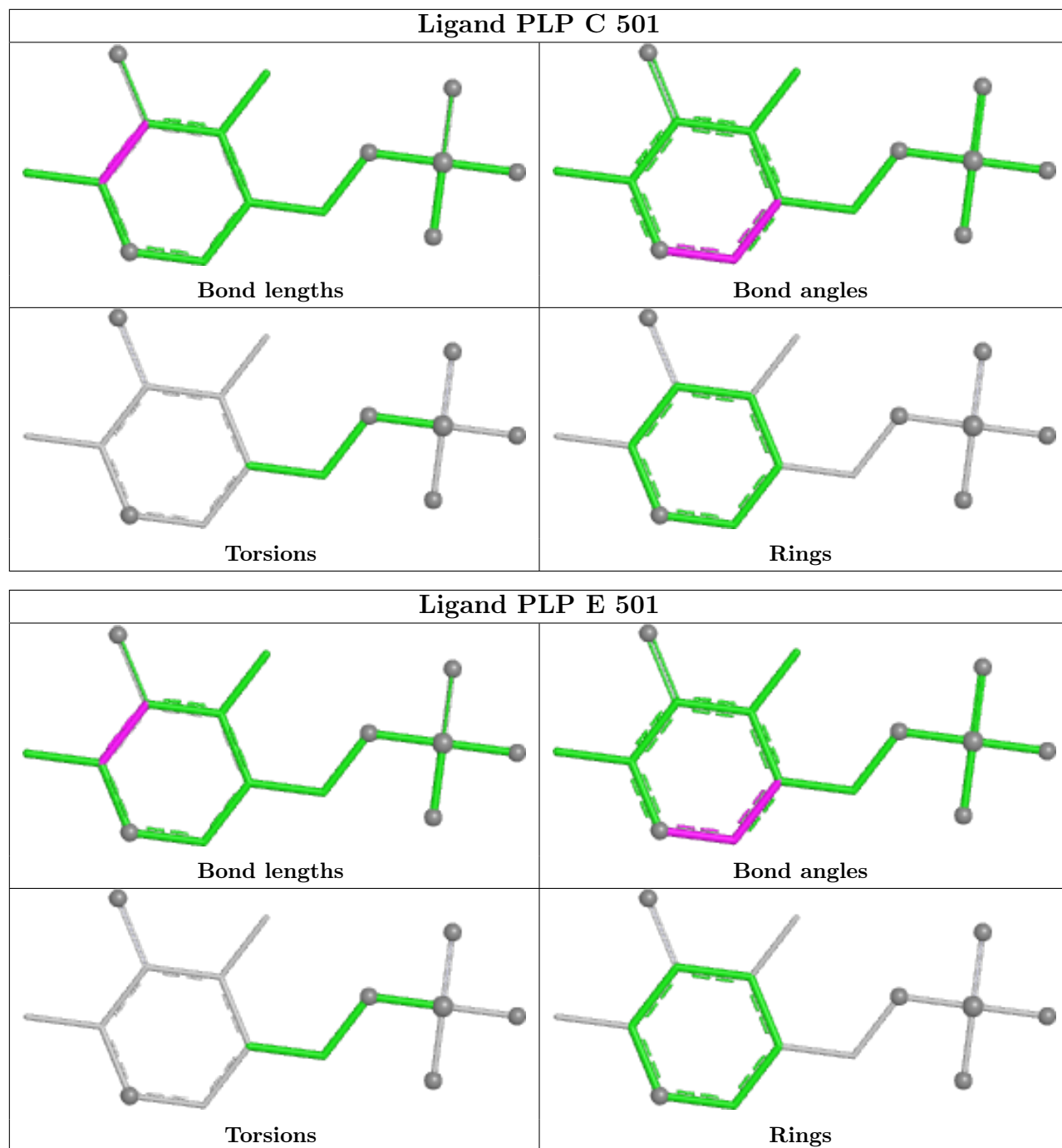

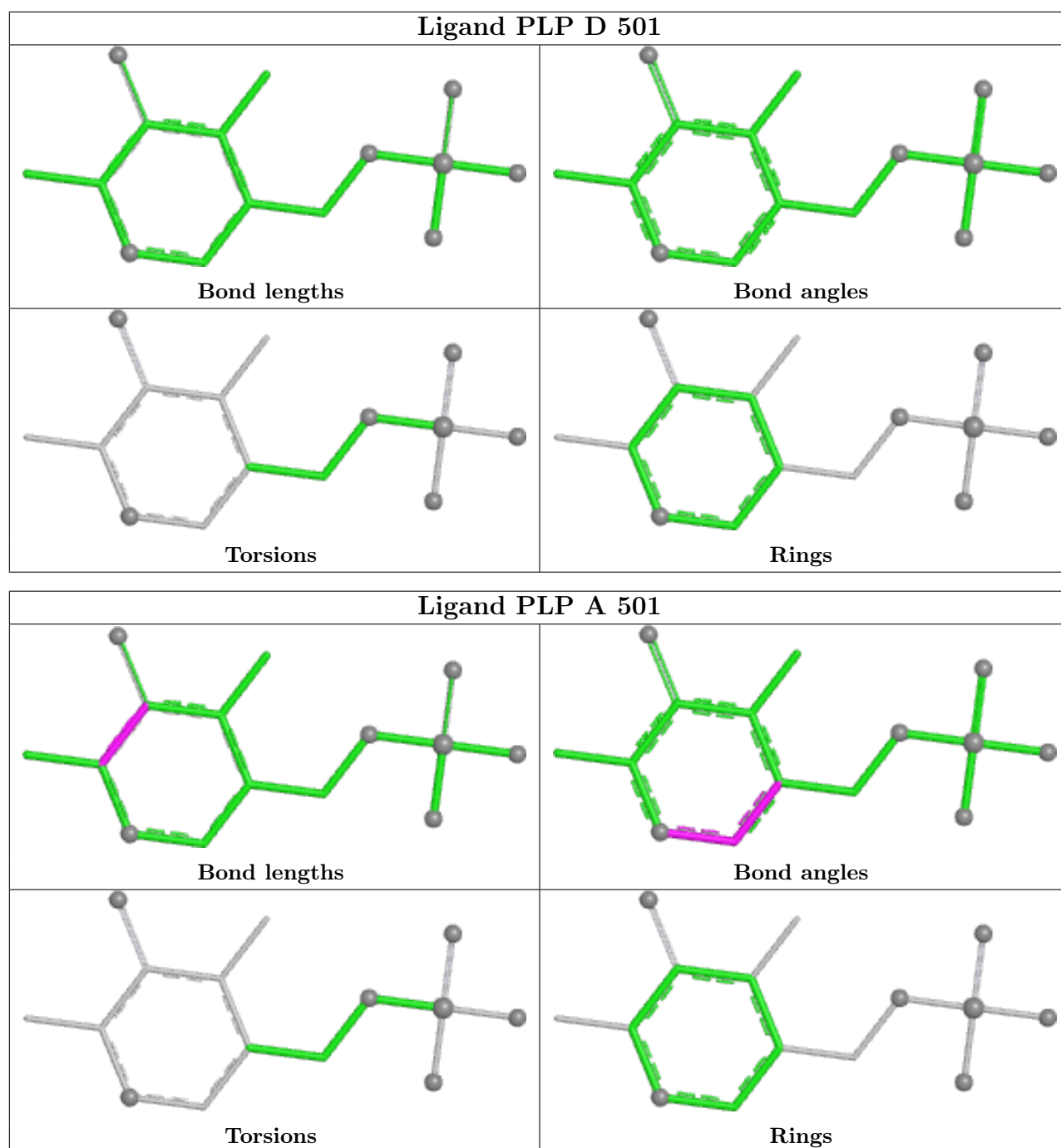

5.7 Other polymers [i](#)

There are no such residues in this entry.

5.8 Polymer linkage issues [i](#)

There are no chain breaks in this entry.

6 Fit of model and data

6.1 Protein, DNA and RNA chains

In the following table, the column labelled ‘#RSRZ > 2’ contains the number (and percentage) of RSRZ outliers, followed by percent RSRZ outliers for the chain as percentile scores relative to all X-ray entries and entries of similar resolution. The OWAB column contains the minimum, median, 95th percentile and maximum values of the occupancy-weighted average B-factor per residue. The column labelled ‘Q < 0.9’ lists the number of (and percentage) of residues with an average occupancy less than 0.9.

Mol	Chain	Analysed	<RSRZ>	#RSRZ>2	OWAB(Å ²)	Q<0.9
1	A	397/417 (95%)	1.64	114 (28%) 0 0	33, 53, 81, 90	1 (0%)
1	B	391/417 (93%)	1.26	80 (20%) 1 1	31, 49, 73, 87	0
1	C	399/417 (95%)	1.05	68 (17%) 1 2	31, 46, 68, 88	1 (0%)
1	D	400/417 (95%)	1.03	65 (16%) 1 3	30, 47, 70, 83	0
1	E	389/417 (93%)	1.22	82 (21%) 1 1	31, 49, 75, 92	1 (0%)
1	F	394/417 (94%)	1.44	101 (25%) 0 1	33, 51, 77, 88	0
1	G	397/417 (95%)	1.13	76 (19%) 1 2	33, 49, 72, 86	0
1	H	399/417 (95%)	1.04	55 (13%) 2 4	29, 48, 66, 76	0
All	All	3166/3336 (94%)	1.22	641 (20%) 1 1	29, 49, 74, 92	3 (0%)

All (641) RSRZ outliers are listed below:

Mol	Chain	Res	Type	RSRZ
1	A	377	ALA	12.3
1	F	387	VAL	11.9
1	F	379	MET	11.3
1	A	31	PHE	10.0
1	A	30	GLY	9.9
1	A	379	MET	9.5
1	G	22	VAL	9.2
1	F	22	VAL	9.2
1	A	374	PHE	9.1
1	E	387	VAL	9.0
1	A	376	HIS	8.8
1	G	31	PHE	8.7
1	A	384	ARG	8.6
1	A	372	ALA	8.6
1	F	31	PHE	8.5
1	B	370	CYS	8.4

Continued on next page...

Continued from previous page...

Mol	Chain	Res	Type	RSRZ
1	B	387	VAL	8.2
1	A	375	THR	8.0
1	A	21	GLY	8.0
1	A	389	ILE	7.7
1	B	372	ALA	7.7
1	F	378	ASN	7.5
1	B	373	VAL	7.1
1	C	380	LEU	7.1
1	F	21	GLY	7.1
1	B	391	ASP	7.0
1	A	168	PRO	6.9
1	E	374	PHE	6.9
1	E	385	LEU	6.7
1	A	302	HIS	6.7
1	F	29	PRO	6.6
1	A	378	ASN	6.6
1	B	392	GLY	6.5
1	A	380	LEU	6.5
1	A	387	VAL	6.4
1	F	382	GLU	6.2
1	F	389	ILE	6.2
1	E	21	GLY	6.2
1	A	373	VAL	6.1
1	F	383	ASP	6.1
1	F	372	ALA	6.1
1	C	378	ASN	6.0
1	A	132	SER	5.9
1	C	379	MET	5.9
1	B	384	ARG	5.9
1	A	388	GLY	5.7
1	G	21	GLY	5.7
1	B	371	PRO	5.6
1	C	376	HIS	5.6
1	A	272	TYR	5.6
1	B	31	PHE	5.6
1	F	380	LEU	5.5
1	E	384	ARG	5.5
1	E	383	ASP	5.4
1	C	31	PHE	5.4
1	H	271	PHE	5.3
1	D	18	PHE	5.2
1	E	386	LYS	5.2

Continued on next page...

Continued from previous page...

Mol	Chain	Res	Type	RSRZ
1	B	57	ILE	5.1
1	G	28	LEU	5.1
1	F	30	GLY	5.1
1	G	30	GLY	5.1
1	F	239	LEU	5.1
1	E	43	GLY	5.1
1	D	31	PHE	5.1
1	A	381	ARG	5.0
1	B	267	ALA	5.0
1	H	302	HIS	5.0
1	F	370	CYS	4.9
1	A	382	GLU	4.9
1	A	391	ASP	4.9
1	C	373	VAL	4.9
1	G	267	ALA	4.9
1	A	385	LEU	4.9
1	G	272	TYR	4.8
1	E	391	ASP	4.8
1	E	69	GLU	4.8
1	D	57	ILE	4.8
1	E	392	GLY	4.8
1	B	29	PRO	4.8
1	C	268	GLN	4.7
1	D	160	THR	4.7
1	E	271	PHE	4.7
1	G	266	SER	4.7
1	B	276	THR	4.7
1	C	271	PHE	4.7
1	E	68	VAL	4.6
1	H	300	LYS	4.6
1	C	237	CYS	4.6
1	E	57	ILE	4.6
1	H	57	ILE	4.6
1	A	393	PHE	4.6
1	E	371	PRO	4.5
1	A	237	CYS	4.5
1	H	272	TYR	4.5
1	B	380	LEU	4.5
1	E	389	ILE	4.5
1	G	158	ASP	4.5
1	A	271	PHE	4.4
1	E	249	GLU	4.4

Continued on next page...

Continued from previous page...

Mol	Chain	Res	Type	RSRZ
1	E	267	ALA	4.4
1	F	373	VAL	4.4
1	E	373	VAL	4.4
1	D	272	TYR	4.4
1	D	267	ALA	4.4
1	F	237	CYS	4.4
1	B	271	PHE	4.4
1	G	29	PRO	4.4
1	E	22	VAL	4.4
1	F	24	ALA	4.4
1	F	28	LEU	4.3
1	A	162	VAL	4.3
1	E	372	ALA	4.3
1	G	268	GLN	4.3
1	F	238	THR	4.3
1	E	237	CYS	4.3
1	D	379	MET	4.3
1	A	239	LEU	4.3
1	B	237	CYS	4.3
1	D	162	VAL	4.3
1	C	195	CYS	4.2
1	B	43	GLY	4.2
1	B	382	GLU	4.2
1	B	270	ALA	4.2
1	G	32	THR	4.2
1	A	131	CYS	4.2
1	F	392	GLY	4.2
1	E	29	PRO	4.2
1	A	267	ALA	4.2
1	E	340	GLY	4.2
1	B	269	THR	4.2
1	A	265	MET	4.2
1	A	270	ALA	4.2
1	A	269	THR	4.1
1	D	380	LEU	4.1
1	A	200	VAL	4.1
1	F	169	GLN	4.1
1	A	390	THR	4.1
1	C	159	PRO	4.1
1	D	197	GLU	4.1
1	F	265	MET	4.1
1	H	267	ALA	4.1

Continued on next page...

Continued from previous page...

Mol	Chain	Res	Type	RSRZ
1	B	381	ARG	4.1
1	A	280	LEU	4.1
1	C	387	VAL	4.1
1	D	378	ASN	4.1
1	G	239	LEU	4.1
1	B	106	ALA	4.0
1	D	164	LYS	4.0
1	D	384	ARG	4.0
1	B	272	TYR	4.0
1	E	54	LEU	4.0
1	F	374	PHE	4.0
1	A	155	ASP	4.0
1	C	267	ALA	4.0
1	H	273	THR	4.0
1	B	32	THR	4.0
1	F	339	GLY	4.0
1	F	391	ASP	4.0
1	F	269	THR	4.0
1	F	384	ARG	4.0
1	H	193	GLN	4.0
1	F	386	LYS	4.0
1	G	57	ILE	3.9
1	D	237	CYS	3.9
1	F	272	TYR	3.9
1	A	139	CYS	3.9
1	H	266	SER	3.9
1	H	268	GLN	3.9
1	D	20	CYS	3.9
1	D	373	VAL	3.9
1	H	239	LEU	3.9
1	A	195	CYS	3.9
1	A	383	ASP	3.9
1	B	388	GLY	3.8
1	F	271	PHE	3.8
1	F	275	LEU	3.8
1	B	273	THR	3.8
1	A	130	ASN	3.8
1	G	26	ASP	3.8
1	F	268	GLN	3.8
1	B	383	ASP	3.8
1	G	412	TYR	3.8
1	E	30	GLY	3.8

Continued on next page...

Continued from previous page...

Mol	Chain	Res	Type	RSRZ
1	H	238	THR	3.8
1	E	274	LEU	3.8
1	G	313	PRO	3.8
1	C	270	ALA	3.7
1	F	302	HIS	3.7
1	E	159	PRO	3.7
1	H	270	ALA	3.7
1	G	379	MET	3.7
1	A	158	ASP	3.7
1	E	272	TYR	3.7
1	C	57	ILE	3.7
1	B	268	GLN	3.7
1	F	381	ARG	3.7
1	G	237	CYS	3.6
1	B	302[A]	HIS	3.6
1	F	168	PRO	3.6
1	H	69	GLU	3.6
1	F	270	ALA	3.6
1	G	270	ALA	3.6
1	G	273	THR	3.6
1	C	272	TYR	3.6
1	F	280	LEU	3.6
1	B	266	SER	3.6
1	F	267	ALA	3.6
1	G	229	THR	3.6
1	A	268	GLN	3.6
1	F	337	VAL	3.6
1	G	380	LEU	3.6
1	C	377	ALA	3.6
1	E	193	GLN	3.6
1	H	299	SER	3.6
1	E	197	GLU	3.5
1	D	266	SER	3.5
1	G	377	ALA	3.5
1	A	274	LEU	3.5
1	E	270	ALA	3.5
1	H	269	THR	3.5
1	A	54	LEU	3.5
1	H	56	PRO	3.5
1	F	388	GLY	3.5
1	F	414	LEU	3.4
1	F	314	SER	3.4

Continued on next page...

Continued from previous page...

Mol	Chain	Res	Type	RSRZ
1	H	31	PHE	3.4
1	C	239	LEU	3.4
1	G	27	TRP	3.4
1	A	43	GLY	3.4
1	A	273	THR	3.4
1	C	266	SER	3.4
1	A	277	LEU	3.4
1	G	106	ALA	3.4
1	B	275	LEU	3.4
1	E	163	GLU	3.4
1	A	106	ALA	3.4
1	C	275	LEU	3.4
1	A	386	LYS	3.4
1	C	302	HIS	3.3
1	C	273	THR	3.3
1	D	341	THR	3.3
1	B	85	THR	3.3
1	D	387	VAL	3.3
1	E	266	SER	3.3
1	D	268	GLN	3.3
1	H	410	LEU	3.3
1	B	277	LEU	3.3
1	A	57	ILE	3.3
1	A	264	ILE	3.3
1	F	57	ILE	3.3
1	G	271	PHE	3.3
1	A	22	VAL	3.3
1	E	162	VAL	3.3
1	E	28	LEU	3.2
1	E	269	THR	3.2
1	E	341	THR	3.2
1	D	275	LEU	3.2
1	H	274	LEU	3.2
1	H	220	GLY	3.2
1	E	265	MET	3.2
1	A	232	TYR	3.2
1	B	30	GLY	3.2
1	H	59	GLN	3.2
1	B	348	MET	3.2
1	H	187	ASP	3.2
1	F	341	THR	3.2
1	B	86	VAL	3.2

Continued on next page...

Continued from previous page...

Mol	Chain	Res	Type	RSRZ
1	G	359	GLU	3.2
1	G	378	ASN	3.2
1	E	56	PRO	3.2
1	A	275	LEU	3.2
1	G	265	MET	3.2
1	C	59	GLN	3.1
1	H	264	ILE	3.1
1	C	269	THR	3.1
1	E	160	THR	3.1
1	G	384	ARG	3.1
1	B	238	THR	3.1
1	D	269	THR	3.1
1	A	29	PRO	3.1
1	D	159	PRO	3.1
1	F	393	PHE	3.1
1	A	284	VAL	3.1
1	E	351	VAL	3.1
1	C	390	THR	3.1
1	D	69	GLU	3.1
1	B	314	SER	3.1
1	E	390	THR	3.1
1	E	31	PHE	3.1
1	D	270	ALA	3.1
1	F	340	GLY	3.1
1	B	249	GLU	3.1
1	H	350	HIS	3.1
1	B	265	MET	3.1
1	A	341	THR	3.1
1	E	59	GLN	3.0
1	D	375	THR	3.0
1	H	85	THR	3.0
1	C	158	ASP	3.0
1	E	268	GLN	3.0
1	E	349	ASN	3.0
1	A	241	GLY	3.0
1	F	277	LEU	3.0
1	H	265	MET	3.0
1	B	239	LEU	3.0
1	D	110	ALA	3.0
1	B	105	PHE	3.0
1	A	321	ALA	3.0
1	F	106	ALA	3.0

Continued on next page...

Continued from previous page...

Mol	Chain	Res	Type	RSRZ
1	H	196	LYS	3.0
1	E	61	THR	3.0
1	E	273	THR	3.0
1	B	274	LEU	3.0
1	C	389	ILE	3.0
1	D	271	PHE	3.0
1	A	276	THR	3.0
1	F	197	GLU	2.9
1	E	264	ILE	2.9
1	H	83	ASN	2.9
1	C	276	THR	2.9
1	H	197	GLU	2.9
1	A	345	ILE	2.9
1	G	69	GLU	2.9
1	H	55	PRO	2.9
1	A	170	THR	2.9
1	H	61	THR	2.9
1	F	385	LEU	2.9
1	G	61	THR	2.9
1	B	229	THR	2.9
1	C	86	VAL	2.9
1	D	54	LEU	2.9
1	D	239	LEU	2.9
1	H	237	CYS	2.9
1	D	196	LYS	2.9
1	E	196	LYS	2.9
1	E	320	LEU	2.9
1	C	274	LEU	2.8
1	F	261	MET	2.8
1	D	58	TYR	2.8
1	A	240	GLY	2.8
1	B	59	GLN	2.8
1	A	227	SER	2.8
1	D	273	THR	2.8
1	F	86	VAL	2.8
1	D	261	MET	2.8
1	E	275	LEU	2.8
1	G	25	GLY	2.8
1	G	391	ASP	2.8
1	B	138	ARG	2.8
1	C	193	GLN	2.8
1	G	321	ALA	2.8

Continued on next page...

Continued from previous page...

Mol	Chain	Res	Type	RSRZ
1	H	195	CYS	2.8
1	B	313	PRO	2.8
1	D	141	ARG	2.8
1	F	71	TYR	2.8
1	A	86	VAL	2.7
1	E	106	ALA	2.7
1	B	337	VAL	2.7
1	F	315	PHE	2.7
1	H	63	PHE	2.7
1	B	374	PHE	2.7
1	A	199	LYS	2.7
1	F	273	THR	2.7
1	G	236	ASN	2.7
1	C	29	PRO	2.7
1	F	234	GLY	2.7
1	A	113	VAL	2.7
1	C	162	VAL	2.7
1	D	86	VAL	2.7
1	H	86	VAL	2.7
1	B	54	LEU	2.7
1	G	155	ASP	2.7
1	E	220	GLY	2.7
1	B	241	GLY	2.7
1	A	66	GLU	2.7
1	E	32	THR	2.7
1	A	163	GLU	2.7
1	F	336	GLU	2.7
1	B	300	LYS	2.7
1	A	282	ILE	2.7
1	D	191	ILE	2.7
1	E	158	ASP	2.7
1	G	383	ASP	2.7
1	G	105	PHE	2.7
1	G	387	VAL	2.7
1	C	341	THR	2.7
1	A	371	PRO	2.7
1	F	45	GLU	2.7
1	F	68	VAL	2.7
1	F	98	GLY	2.7
1	G	168	PRO	2.6
1	H	301	HIS	2.6
1	C	62	THR	2.6

Continued on next page...

Continued from previous page...

Mol	Chain	Res	Type	RSRZ
1	D	322	LEU	2.6
1	E	105	PHE	2.6
1	F	89	LEU	2.6
1	G	89	LEU	2.6
1	F	193	GLN	2.6
1	G	141	ARG	2.6
1	A	318	LYS	2.6
1	H	58	TYR	2.6
1	B	414	LEU	2.6
1	A	55	PRO	2.6
1	B	261	MET	2.6
1	A	194	ILE	2.6
1	F	264	ILE	2.6
1	A	193	GLN	2.6
1	F	274	LEU	2.6
1	H	89	LEU	2.6
1	D	376	HIS	2.6
1	E	85	THR	2.6
1	H	60	ASN	2.6
1	H	54	LEU	2.6
1	A	347	MET	2.6
1	C	265	MET	2.6
1	E	86	VAL	2.6
1	D	391	ASP	2.6
1	G	233	ASP	2.6
1	H	62	THR	2.5
1	B	61	THR	2.5
1	A	89	LEU	2.5
1	C	364	CYS	2.5
1	G	153	PHE	2.5
1	C	383	ASP	2.5
1	A	123	GLY	2.5
1	C	382	GLU	2.5
1	H	163	GLU	2.5
1	B	42	GLY	2.5
1	C	197	GLU	2.5
1	D	233	ASP	2.5
1	A	337	VAL	2.5
1	F	74	LYS	2.5
1	G	86	VAL	2.5
1	A	314	SER	2.5
1	H	192	SER	2.5

Continued on next page...

Continued from previous page...

Mol	Chain	Res	Type	RSRZ
1	G	269	THR	2.5
1	B	55	PRO	2.5
1	D	274	LEU	2.5
1	E	104	CYS	2.5
1	G	417	ALA	2.5
1	B	228	THR	2.5
1	H	84	PRO	2.5
1	F	344	GLY	2.5
1	C	242	ALA	2.5
1	C	417	ALA	2.5
1	D	111	ALA	2.5
1	A	359	GLU	2.5
1	G	280	LEU	2.5
1	H	280	LEU	2.5
1	B	304	VAL	2.5
1	B	141	ARG	2.5
1	A	238	THR	2.5
1	C	359	GLU	2.5
1	A	234	GLY	2.5
1	G	364	CYS	2.5
1	B	193	GLN	2.5
1	G	164	LYS	2.4
1	D	359	GLU	2.4
1	C	164	LYS	2.4
1	A	235	HIS	2.4
1	C	85	THR	2.4
1	G	234	GLY	2.4
1	A	233	ASP	2.4
1	C	79	SER	2.4
1	D	198	LYS	2.4
1	E	139	CYS	2.4
1	G	193	GLN	2.4
1	D	56	PRO	2.4
1	D	306	HIS	2.4
1	C	61	THR	2.4
1	F	69	GLU	2.4
1	A	322	LEU	2.4
1	G	261	MET	2.4
1	F	229	THR	2.4
1	B	343	ALA	2.4
1	D	107	THR	2.4
1	E	200	VAL	2.4

Continued on next page...

Continued from previous page...

Mol	Chain	Res	Type	RSRZ
1	E	276	THR	2.4
1	D	231	TYR	2.4
1	E	53	ILE	2.4
1	C	84	PRO	2.4
1	E	221	ALA	2.4
1	G	104	CYS	2.4
1	C	318	LYS	2.3
1	C	386	LYS	2.3
1	F	343	ALA	2.3
1	F	390	THR	2.3
1	F	227	SER	2.3
1	E	199	LYS	2.3
1	B	264	ILE	2.3
1	B	345	ILE	2.3
1	C	165	ALA	2.3
1	F	102	ALA	2.3
1	C	229	THR	2.3
1	F	207	THR	2.3
1	D	374	PHE	2.3
1	B	68	VAL	2.3
1	A	370	CYS	2.3
1	C	111	ALA	2.3
1	A	28	LEU	2.3
1	A	279	THR	2.3
1	E	201	LEU	2.3
1	G	238	THR	2.3
1	B	232	TYR	2.3
1	E	348	MET	2.3
1	F	105	PHE	2.3
1	H	411	ASP	2.3
1	G	262	GLY	2.3
1	D	60	ASN	2.3
1	F	236	ASN	2.3
1	A	73	SER	2.3
1	A	343	ALA	2.3
1	F	299	SER	2.3
1	E	98	GLY	2.2
1	B	359	GLU	2.2
1	D	265	MET	2.2
1	F	232	TYR	2.2
1	D	195	CYS	2.2
1	F	364	CYS	2.2

Continued on next page...

Continued from previous page...

Mol	Chain	Res	Type	RSRZ
1	B	104	CYS	2.2
1	F	230	LYS	2.2
1	F	162	VAL	2.2
1	F	304	VAL	2.2
1	C	227	SER	2.2
1	D	85	THR	2.2
1	E	262	GLY	2.2
1	F	25	GLY	2.2
1	G	376	HIS	2.2
1	D	155	ASP	2.2
1	D	55	PRO	2.2
1	D	381	ARG	2.2
1	H	82	SER	2.2
1	A	42	GLY	2.2
1	C	191	ILE	2.2
1	G	189	GLU	2.2
1	G	159	PRO	2.2
1	A	364	CYS	2.2
1	E	195	CYS	2.2
1	C	391	ASP	2.2
1	F	115	ILE	2.2
1	C	348	MET	2.2
1	F	300	LYS	2.2
1	A	228	THR	2.2
1	H	190	ALA	2.2
1	A	149	ILE	2.2
1	B	323	LYS	2.2
1	E	319	GLU	2.2
1	F	266	SER	2.2
1	A	60	ASN	2.2
1	A	111	ALA	2.2
1	E	190	ALA	2.2
1	G	102	ALA	2.2
1	G	363	ALA	2.2
1	F	139	CYS	2.2
1	F	27	TRP	2.2
1	H	275	LEU	2.2
1	C	19	GLU	2.2
1	A	56	PRO	2.2
1	C	347	MET	2.2
1	F	281	PRO	2.2
1	F	158	ASP	2.2

Continued on next page...

Continued from previous page...

Mol	Chain	Res	Type	RSRZ
1	A	169	GLN	2.2
1	B	60	ASN	2.1
1	D	297	PHE	2.1
1	A	160	THR	2.1
1	H	106	ALA	2.1
1	F	371	PRO	2.1
1	H	79	SER	2.1
1	A	71	TYR	2.1
1	A	231	TYR	2.1
1	E	40	VAL	2.1
1	F	351	VAL	2.1
1	B	260	VAL	2.1
1	C	369	THR	2.1
1	D	62	THR	2.1
1	E	111	ALA	2.1
1	B	386	LYS	2.1
1	A	308	ILE	2.1
1	G	227	SER	2.1
1	G	320	LEU	2.1
1	A	104	CYS	2.1
1	D	234	GLY	2.1
1	G	42	GLY	2.1
1	C	133	TYR	2.1
1	D	276	THR	2.1
1	F	112	THR	2.1
1	G	112	THR	2.1
1	G	162	VAL	2.1
1	G	228	THR	2.1
1	C	340	GLY	2.1
1	D	302	HIS	2.1
1	A	243	VAL	2.1
1	A	266	SER	2.1
1	A	392	GLY	2.1
1	E	135	GLY	2.1
1	H	316	PRO	2.1
1	C	278	LYS	2.1
1	E	277	LEU	2.1
1	F	49	LEU	2.1
1	A	301	HIS	2.1
1	G	302[A]	HIS	2.1
1	F	111	ALA	2.1
1	G	165	ALA	2.1

Continued on next page...

Continued from previous page...

Mol	Chain	Res	Type	RSRZ
1	H	363	ALA	2.1
1	B	113	VAL	2.1
1	B	79	SER	2.1
1	B	393	PHE	2.1
1	D	235	HIS	2.1
1	F	54	LEU	2.1
1	G	306	HIS	2.1
1	A	319	GLU	2.1
1	C	279	THR	2.1
1	A	192	SER	2.1
1	C	68	VAL	2.1
1	H	362	GLY	2.1
1	G	375	THR	2.0
1	E	240	GLY	2.0
1	G	110	ALA	2.0
1	C	40	VAL	2.0
1	D	59	GLN	2.0
1	C	412	TYR	2.0
1	E	71	TYR	2.0
1	F	39	TYR	2.0
1	E	250	ILE	2.0
1	D	236	ASN	2.0
1	F	135	GLY	2.0
1	F	276	THR	2.0
1	B	227	SER	2.0
1	F	159	PRO	2.0
1	A	40	VAL	2.0
1	G	23	LYS	2.0
1	G	260	VAL	2.0
1	F	231	TYR	2.0
1	B	58	TYR	2.0
1	E	239	LEU	2.0
1	B	89	LEU	2.0
1	B	410	LEU	2.0
1	B	399	GLY	2.0
1	A	229	THR	2.0
1	C	199	LYS	2.0

6.2 Non-standard residues in protein, DNA, RNA chains

There are no non-standard protein/DNA/RNA residues in this entry.

6.3 Carbohydrates [i](#)

There are no monosaccharides in this entry.

6.4 Ligands [i](#)

In the following table, the Atoms column lists the number of modelled atoms in the group and the number defined in the chemical component dictionary. The B-factors column lists the minimum, median, 95th percentile and maximum values of B factors of atoms in the group. The column labelled 'Q< 0.9' lists the number of atoms with occupancy less than 0.9.

Mol	Type	Chain	Res	Atoms	RSCC	RSR	B-factors(Å ²)	Q<0.9
2	PLP	A	501	15/16	0.92	0.23	40,45,47,48	0
2	PLP	B	501	15/16	0.92	0.17	39,44,50,52	0
2	PLP	F	501	15/16	0.94	0.21	37,41,49,49	0
2	PLP	H	501	15/16	0.94	0.18	39,43,47,49	0
2	PLP	E	501	15/16	0.94	0.17	36,44,49,50	1
2	PLP	G	501	15/16	0.96	0.20	35,43,46,47	0
2	PLP	C	501	15/16	0.96	0.18	36,38,47,48	0
2	PLP	D	501	15/16	0.96	0.17	31,37,38,41	0

The following is a graphical depiction of the model fit to experimental electron density of all instances of the Ligand of Interest. In addition, ligands with molecular weight > 250 and outliers as shown on the geometry validation Tables will also be included. Each fit is shown from different orientation to approximate a three-dimensional view.

Electron density around PLP A 501:

$2mF_o-DF_c$ (at 0.7 rmsd) in gray
 mF_o-DF_c (at 3 rmsd) in purple (negative)
and green (positive)

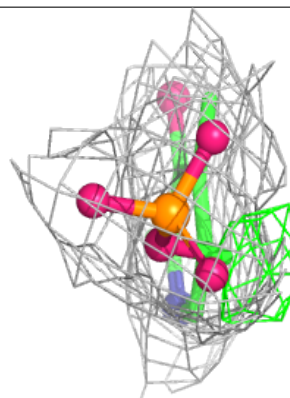
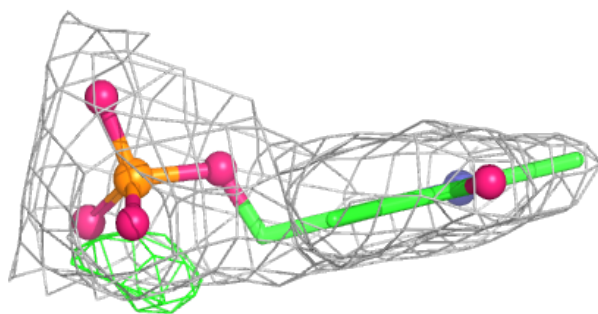
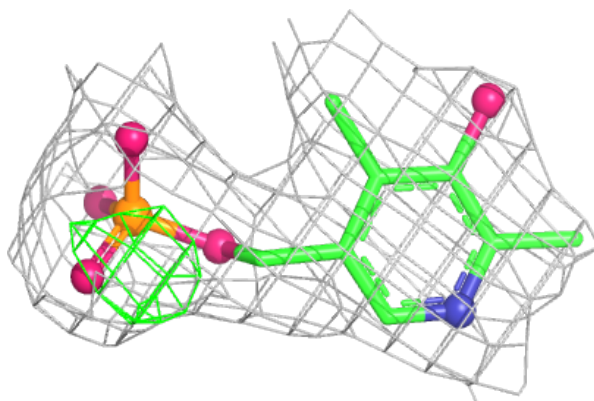
**Electron density around PLP B 501:**

$2mF_o-DF_c$ (at 0.7 rmsd) in gray
 mF_o-DF_c (at 3 rmsd) in purple (negative)
and green (positive)

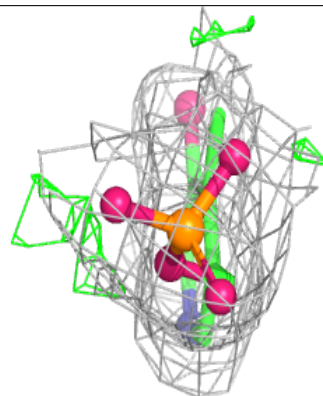
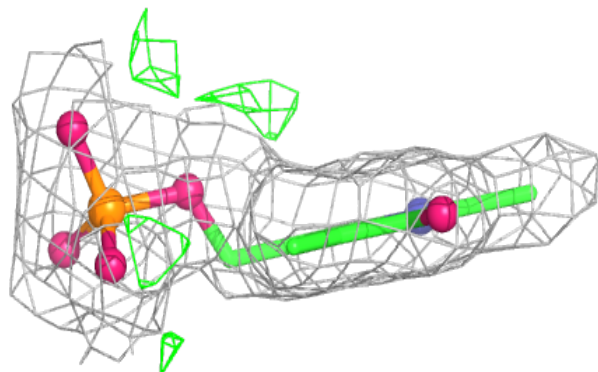
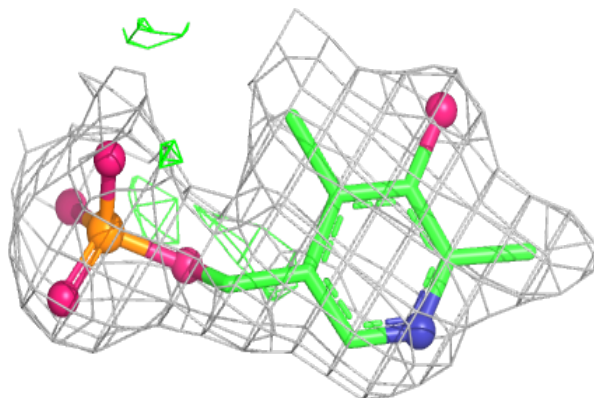

Electron density around PLP F 501:

$2mF_o-DF_c$ (at 0.7 rmsd) in gray
 mF_o-DF_c (at 3 rmsd) in purple (negative)
and green (positive)

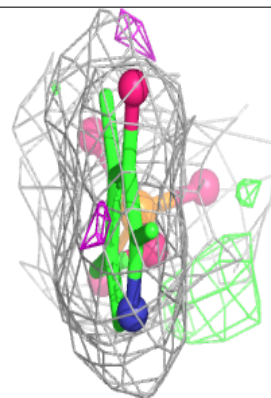
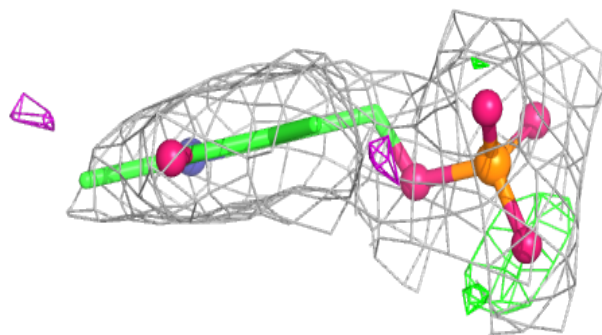
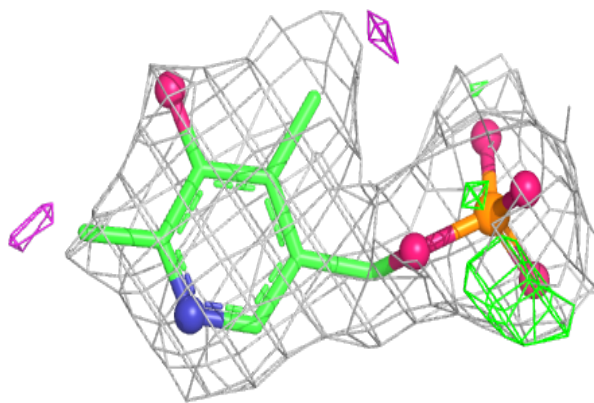
**Electron density around PLP H 501:**

$2mF_o-DF_c$ (at 0.7 rmsd) in gray
 mF_o-DF_c (at 3 rmsd) in purple (negative)
and green (positive)

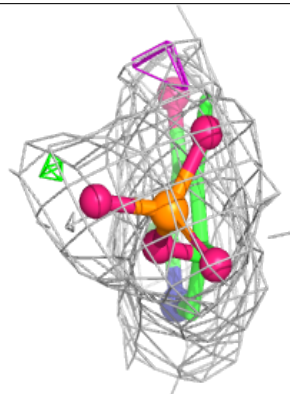
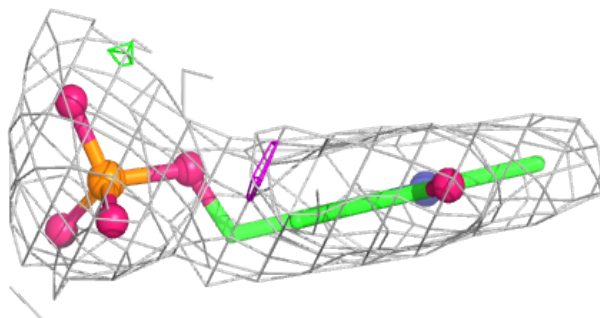
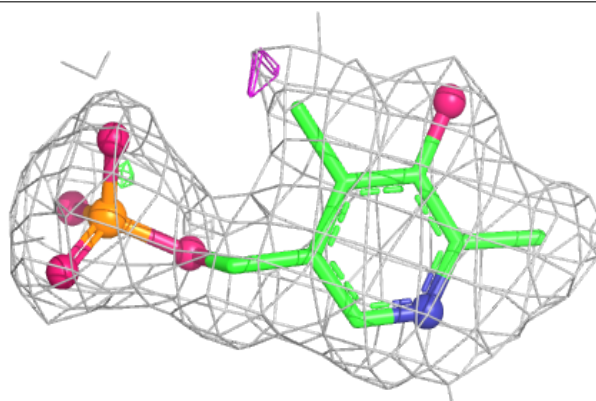

Electron density around PLP E 501:

$2mF_o-DF_c$ (at 0.7 rmsd) in gray
 mF_o-DF_c (at 3 rmsd) in purple (negative)
and green (positive)

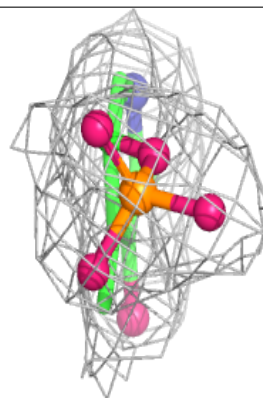
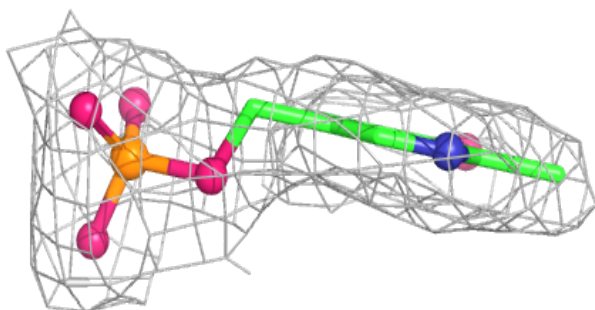
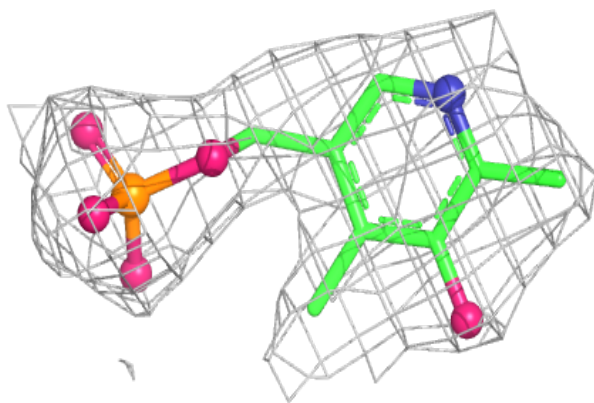
**Electron density around PLP G 501:**

$2mF_o-DF_c$ (at 0.7 rmsd) in gray
 mF_o-DF_c (at 3 rmsd) in purple (negative)
and green (positive)

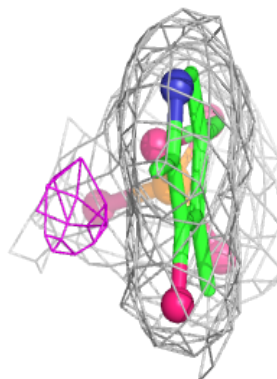
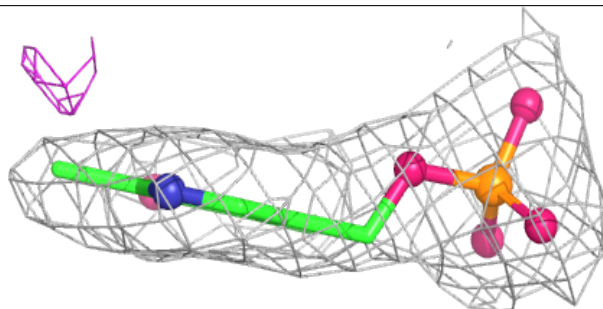
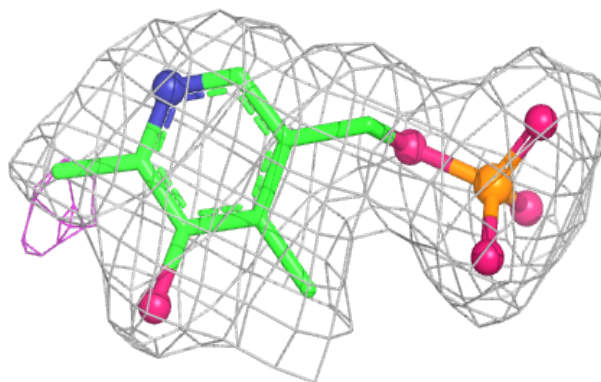

Electron density around PLP C 501:

$2mF_o-DF_c$ (at 0.7 rmsd) in gray
 mF_o-DF_c (at 3 rmsd) in purple (negative)
and green (positive)

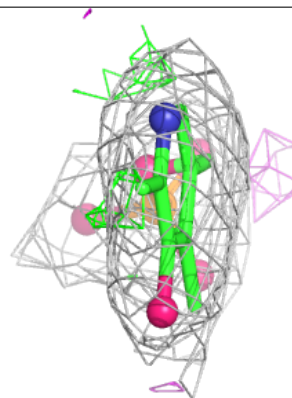
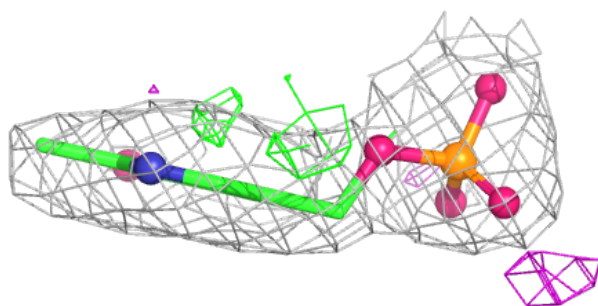
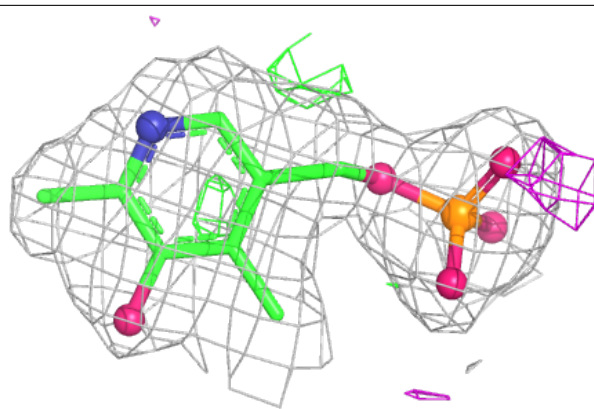
**Electron density around PLP D 501:**

$2mF_o-DF_c$ (at 0.7 rmsd) in gray
 mF_o-DF_c (at 3 rmsd) in purple (negative)
and green (positive)

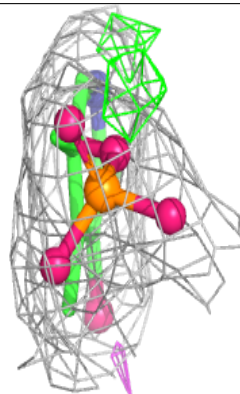
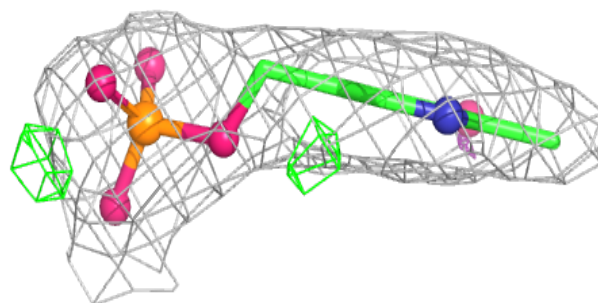
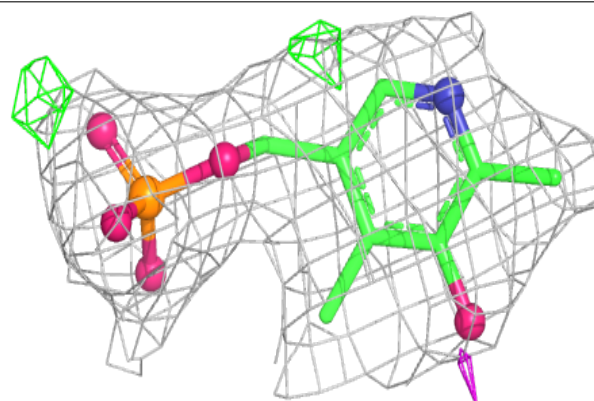

6.5 Other polymers [i](#)

There are no such residues in this entry.