



Full wwPDB X-ray Structure Validation Report ⓘ

May 13, 2020 – 06:30 am BST

PDB ID : 5NM5
Title : Tubulin Darpin room-temperature structure in complex with Colchicine determined by serial millisecond crystallography
Authors : Weinert, T.; Olieric, N.; James, D.; Gashi, D.; Nogly, P.; Jaeger, K.; Steinmetz, M.O.; Standfuss, J.
Deposited on : 2017-04-05
Resolution : 2.05 Å(reported)

This is a Full wwPDB X-ray Structure Validation Report for a publicly released PDB entry.

We welcome your comments at validation@mail.wwpdb.org

A user guide is available at

<https://www.wwpdb.org/validation/2017/XrayValidationReportHelp>

with specific help available everywhere you see the ⓘ symbol.

The following versions of software and data (see [references ⓘ](#)) were used in the production of this report:

MolProbity : 4.02b-467
Mogul : 1.8.5 (274361), CSD as541be (2020)
Xtriage (Phenix) : 1.13
EDS : 2.11
buster-report : 1.1.7 (2018)
Percentile statistics : 20191225.v01 (using entries in the PDB archive December 25th 2019)
Refmac : 5.8.0158
CCP4 : 7.0.044 (Gargrove)
Ideal geometry (proteins) : Engh & Huber (2001)
Ideal geometry (DNA, RNA) : Parkinson et al. (1996)
Validation Pipeline (wwPDB-VP) : 2.11

1 Overall quality at a glance

The following experimental techniques were used to determine the structure:

X-RAY DIFFRACTION

The reported resolution of this entry is 2.05 Å.

Percentile scores (ranging between 0-100) for global validation metrics of the entry are shown in the following graphic. The table shows the number of entries on which the scores are based.

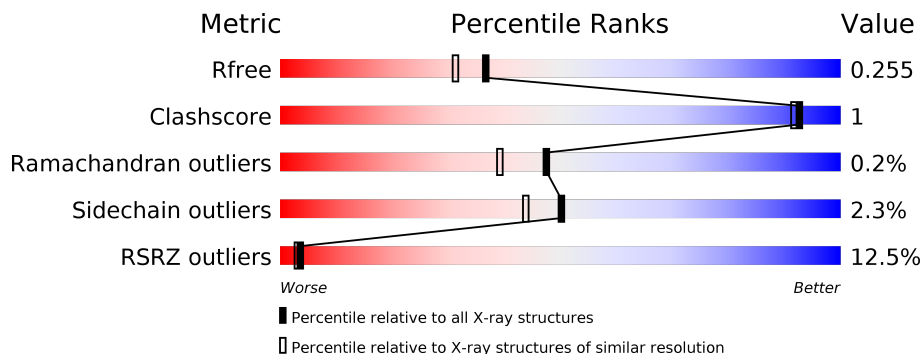

Metric	Whole archive (#Entries)	Similar resolution (#Entries, resolution range(Å))
R_{free}	130704	1692 (2.04-2.04)
Clashscore	141614	1773 (2.04-2.04)
Ramachandran outliers	138981	1752 (2.04-2.04)
Sidechain outliers	138945	1752 (2.04-2.04)
RSRZ outliers	127900	1672 (2.04-2.04)

The table below summarises the geometric issues observed across the polymeric chains and their fit to the electron density. The red, orange, yellow and green segments on the lower bar indicate the fraction of residues that contain outliers for ≥ 3 , 2, 1 and 0 types of geometric quality criteria respectively. A grey segment represents the fraction of residues that are not modelled. The numeric value for each fraction is indicated below the corresponding segment, with a dot representing fractions $\leq 5\%$. The upper red bar (where present) indicates the fraction of residues that have poor fit to the electron density. The numeric value is given above the bar.

Mol	Chain	Length	Quality of chain
1	A	451	 9% 86% 7% 6%
2	B	445	 17% 88% 5% 6%
3	F	169	 5% 89% 8%

2 Entry composition [i](#)

There are 8 unique types of molecules in this entry. The entry contains 15537 atoms, of which 7603 are hydrogens and 0 are deuteriums.

In the tables below, the ZeroOcc column contains the number of atoms modelled with zero occupancy, the AltConf column contains the number of residues with at least one atom in alternate conformation and the Trace column contains the number of residues modelled with at most 2 atoms.

- Molecule 1 is a protein called Tubulin alpha-1B chain.

Mol	Chain	Residues	Atoms					ZeroOcc	AltConf	Trace	
			Total	C	H	N	O				S
1	A	422	6571	2109	3244	566	628	24	0	8	0

- Molecule 2 is a protein called Tubulin beta-2B chain.

Mol	Chain	Residues	Atoms					ZeroOcc	AltConf	Trace	
			Total	C	H	N	O				S
2	B	417	6447	2069	3158	555	639	26	0	4	0

- Molecule 3 is a protein called Designed Ankyrin Repeat Protein (DARPIN) D1.

Mol	Chain	Residues	Atoms					ZeroOcc	AltConf	Trace	
			Total	C	H	N	O				S
3	F	155	2306	728	1152	195	228	3	0	1	0

- Molecule 4 is GUANOSINE-5'-TRIPHOSPHATE (three-letter code: GTP) (formula: $C_{10}H_{16}N_5O_{14}P_3$).

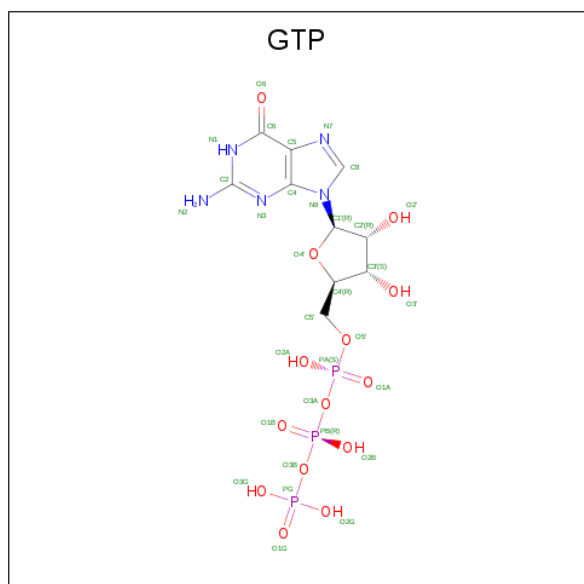

Mol	Chain	Residues	Atoms					ZeroOcc	AltConf	
			Total	C	H	N	O			P
4	A	1	44	10	12	5	14	3	0	0

- Molecule 5 is MAGNESIUM ION (three-letter code: MG) (formula: Mg).

Mol	Chain	Residues	Atoms		ZeroOcc	AltConf
			Total	Mg		
5	A	1	1	1	0	0

- Molecule 6 is GUANOSINE-5'-DIPHOSPHATE (three-letter code: GDP) (formula: $C_{10}H_{15}N_5O_{11}P_2$).

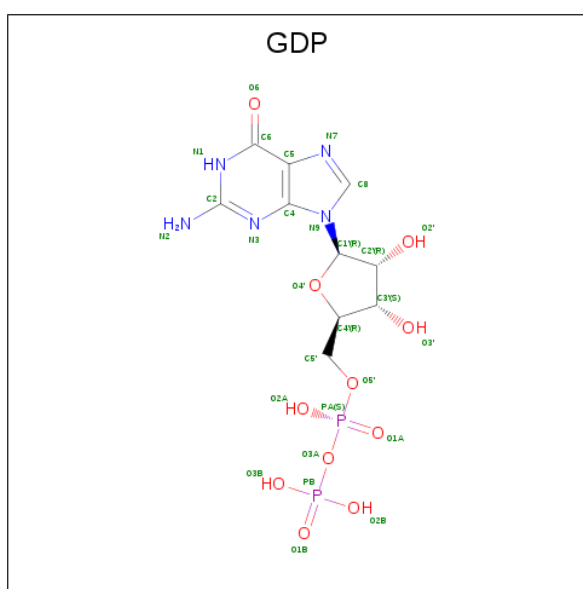

Mol	Chain	Residues	Atoms					ZeroOcc	AltConf	
			Total	C	H	N	O			P
6	B	1	40	10	12	5	11	2	0	0

- Molecule 7 is N-[(7S)-1,2,3,10-tetramethoxy-9-oxo-6,7-dihydro-5H-benzo[d]heptalen-7-yl]ethanamide (three-letter code: LOC) (formula: $C_{22}H_{25}NO_6$).

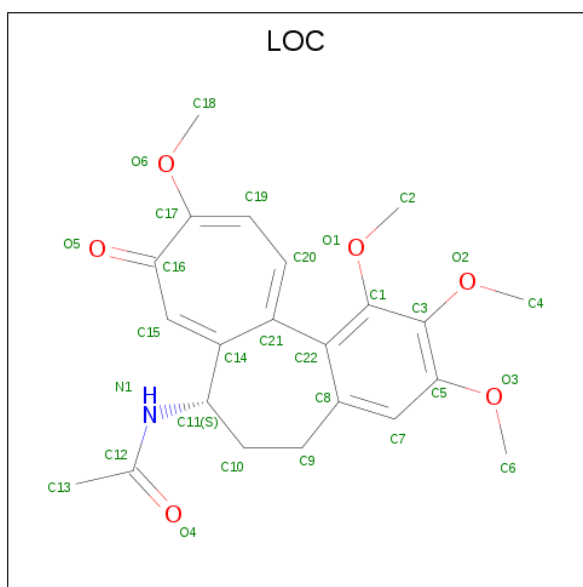

Mol	Chain	Residues	Atoms					ZeroOcc	AltConf
			Total	C	H	N	O		
7	B	1	54	22	25	1	6	0	0

- Molecule 8 is water.

Mol	Chain	Residues	Atoms		ZeroOcc	AltConf
8	A	31	Total	O	0	0
			31	31		
8	B	27	Total	O	0	0
			27	27		
8	F	16	Total	O	0	0
			16	16		

3 Residue-property plots [i](#)

These plots are drawn for all protein, RNA and DNA chains in the entry. The first graphic for a chain summarises the proportions of the various outlier classes displayed in the second graphic. The second graphic shows the sequence view annotated by issues in geometry and electron density. Residues are color-coded according to the number of geometric quality criteria for which they contain at least one outlier: green = 0, yellow = 1, orange = 2 and red = 3 or more. A red dot above a residue indicates a poor fit to the electron density ($RSRZ > 2$). Stretches of 2 or more consecutive residues without any outlier are shown as a green connector. Residues present in the sample, but not in the model, are shown in grey.

- Molecule 1: Tubulin alpha-1B chain

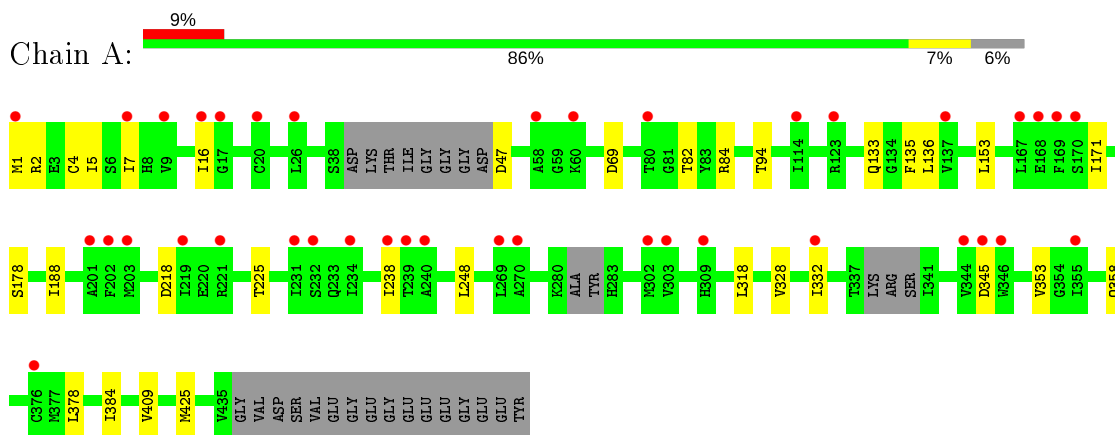

- Molecule 2: Tubulin beta-2B chain

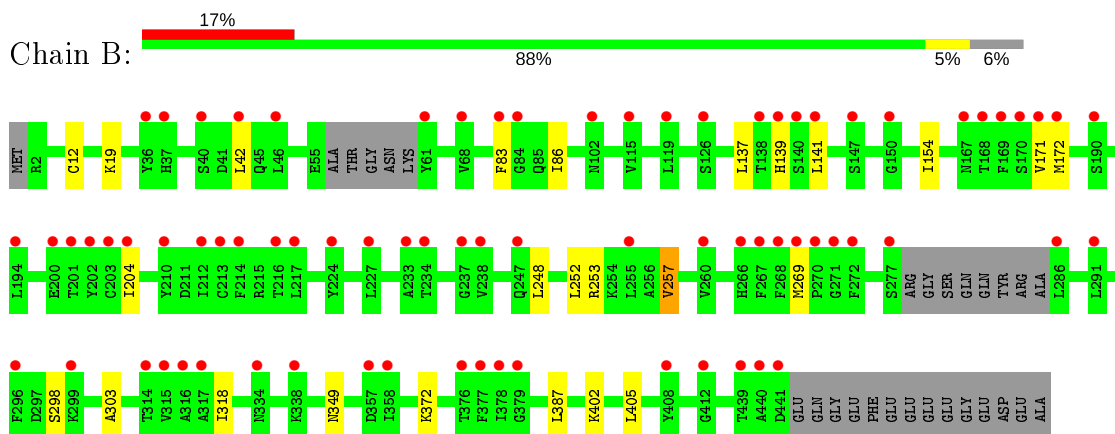

- Molecule 3: Designed Ankyrin Repeat Protein (DARPIN) D1

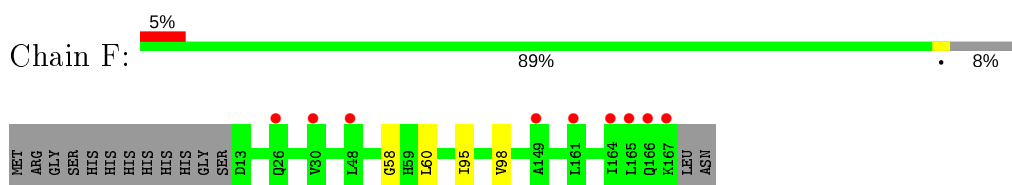

4 Data and refinement statistics

Property	Value	Source
Space group	P 1 21 1	Depositor
Cell constants a, b, c, α , β , γ	72.92Å 85.02Å 84.34Å 90.00° 97.32° 90.00°	Depositor
Resolution (Å)	31.00 – 2.05 29.81 – 2.05	Depositor EDS
% Data completeness (in resolution range)	92.1 (31.00-2.05) 92.1 (29.81-2.05)	Depositor EDS
R_{merge}	(Not available)	Depositor
R_{sym}	(Not available)	Depositor
$\langle I/\sigma(I) \rangle$ ¹	3.60 (at 2.04Å)	Xtrriage
Refinement program	BUSTER 2.10.2	Depositor
R, R_{free}	0.193 , 0.239 0.209 , 0.255	Depositor DCC
R_{free} test set	2855 reflections (4.83%)	wwPDB-VP
Wilson B-factor (Å ²)	55.7	Xtrriage
Anisotropy	0.055	Xtrriage
Bulk solvent k_{sol} (e/Å ³), B_{sol} (Å ²)	0.29 , 71.6	EDS
L-test for twinning ²	$\langle L \rangle = 0.47$, $\langle L^2 \rangle = 0.30$	Xtrriage
Estimated twinning fraction	No twinning to report.	Xtrriage
F_o, F_c correlation	0.97	EDS
Total number of atoms	15537	wwPDB-VP
Average B, all atoms (Å ²)	86.0	wwPDB-VP

Xtrriage's analysis on translational NCS is as follows: *The largest off-origin peak in the Patterson function is 4.46% of the height of the origin peak. No significant pseudotranslation is detected.*

¹ Intensities estimated from amplitudes.

² Theoretical values of $\langle |L| \rangle$, $\langle L^2 \rangle$ for acentric reflections are 0.5, 0.333 respectively for untwinned datasets, and 0.375, 0.2 for perfectly twinned datasets.

5 Model quality [i](#)

5.1 Standard geometry [i](#)

Bond lengths and bond angles in the following residue types are not validated in this section: GTP, LOC, MG, GDP

The Z score for a bond length (or angle) is the number of standard deviations the observed value is removed from the expected value. A bond length (or angle) with $|Z| > 5$ is considered an outlier worth inspection. RMSZ is the root-mean-square of all Z scores of the bond lengths (or angles).

Mol	Chain	Bond lengths		Bond angles	
		RMSZ	# Z >5	RMSZ	# Z >5
1	A	0.54	0/3426	0.69	0/4648
2	B	0.48	0/3374	0.65	0/4572
3	F	0.49	0/1173	0.58	0/1595
All	All	0.51	0/7973	0.66	0/10815

There are no bond length outliers.

There are no bond angle outliers.

There are no chirality outliers.

There are no planarity outliers.

5.2 Too-close contacts [i](#)

In the following table, the Non-H and H(model) columns list the number of non-hydrogen atoms and hydrogen atoms in the chain respectively. The H(added) column lists the number of hydrogen atoms added and optimized by MolProbity. The Clashes column lists the number of clashes within the asymmetric unit, whereas Symm-Clashes lists symmetry related clashes.

Mol	Chain	Non-H	H(model)	H(added)	Clashes	Symm-Clashes
1	A	3327	3244	3230	10	0
2	B	3289	3158	3147	11	0
3	F	1154	1152	1151	2	0
4	A	32	12	12	0	0
5	A	1	0	0	0	0
6	B	28	12	12	1	0
7	B	29	25	25	1	0
8	A	31	0	0	0	0
8	B	27	0	0	0	0
8	F	16	0	0	0	0
All	All	7934	7603	7577	23	0

The all-atom clashscore is defined as the number of clashes found per 1000 atoms (including hydrogen atoms). The all-atom clashscore for this structure is 1.

All (23) close contacts within the same asymmetric unit are listed below, sorted by their clash magnitude.

Atom-1	Atom-2	Interatomic distance (Å)	Clash overlap (Å)
2:B:402:LYS:HG3	2:B:405:LEU:HD22	1.84	0.59
3:F:60:LEU:HD11	3:F:98:VAL:HG21	1.84	0.59
2:B:318:ILE:HD11	7:B:502:LOC:H4	1.88	0.54
2:B:83:PHE:O	2:B:86:ILE:HG22	2.07	0.54
1:A:7:ILE:HG21	1:A:153:LEU:HD21	1.92	0.52
2:B:137:LEU:HD23	2:B:154:ILE:HD11	1.93	0.51
2:B:171:VAL:HA	2:B:204:ILE:O	2.14	0.48
2:B:253:ARG:O	2:B:257:VAL:HG13	2.12	0.48
1:A:4[B]:CYS:SG	1:A:136:LEU:HG	2.53	0.48
2:B:172:MET:HG3	2:B:387:LEU:HD21	1.96	0.47
1:A:16:ILE:CD1	1:A:171:ILE:HD11	2.44	0.47
2:B:137:LEU:CD2	2:B:154:ILE:HD11	2.45	0.47
2:B:269:MET:HG3	2:B:303:ALA:HB3	1.97	0.46
1:A:238:ILE:HG12	1:A:378:LEU:HD21	1.99	0.45
1:A:188:ILE:HD12	1:A:425:MET:HG3	1.98	0.45
2:B:141:LEU:HD12	2:B:172:MET:SD	2.57	0.45
1:A:69:ASP:O	1:A:94:THR:HA	2.17	0.44
1:A:2:ARG:HB3	1:A:133:GLN:HG2	2.01	0.43
1:A:248:LEU:HD23	1:A:318:LEU:HD23	2.01	0.42
2:B:12:CYS:HB2	6:B:501:GDP:C8	2.54	0.42
3:F:58:GLY:HA2	3:F:95:ILE:HD12	2.01	0.42
1:A:328:VAL:HG11	1:A:353:VAL:HG11	2.03	0.41
1:A:5:ILE:O	1:A:135:PHE:HA	2.21	0.40

There are no symmetry-related clashes.

5.3 Torsion angles [\(i\)](#)

5.3.1 Protein backbone [\(i\)](#)

In the following table, the Percentiles column shows the percent Ramachandran outliers of the chain as a percentile score with respect to all X-ray entries followed by that with respect to entries of similar resolution.

The Analysed column shows the number of residues for which the backbone conformation was analysed, and the total number of residues.

Mol	Chain	Analysed	Favoured	Allowed	Outliers	Percentiles	
1	A	422/451 (94%)	405 (96%)	15 (4%)	2 (0%)	29	18
2	B	415/445 (93%)	407 (98%)	8 (2%)	0	100	100
3	F	154/169 (91%)	149 (97%)	5 (3%)	0	100	100
All	All	991/1065 (93%)	961 (97%)	28 (3%)	2 (0%)	47	39

All (2) Ramachandran outliers are listed below:

Mol	Chain	Res	Type
1	A	345	ASP
1	A	178	SER

5.3.2 Protein sidechains [i](#)

In the following table, the Percentiles column shows the percent sidechain outliers of the chain as a percentile score with respect to all X-ray entries followed by that with respect to entries of similar resolution.

The Analysed column shows the number of residues for which the sidechain conformation was analysed, and the total number of residues.

Mol	Chain	Analysed	Rotameric	Outliers	Percentiles	
1	A	360/379 (95%)	350 (97%)	10 (3%)	43	37
2	B	363/383 (95%)	354 (98%)	9 (2%)	47	40
3	F	120/132 (91%)	120 (100%)	0	100	100
All	All	843/894 (94%)	824 (98%)	19 (2%)	50	44

All (19) residues with a non-rotameric sidechain are listed below:

Mol	Chain	Res	Type
1	A	1	MET
1	A	47	ASP
1	A	82	THR
1	A	84	ARG
1	A	218	ASP
1	A	225	THR
1	A	332	ILE
1	A	358	GLN
1	A	384	ILE
1	A	409	VAL
2	B	19	LYS

Continued on next page...

Continued from previous page...

Mol	Chain	Res	Type
2	B	42	LEU
2	B	139	HIS
2	B	248	LEU
2	B	252	LEU
2	B	257	VAL
2	B	298	SER
2	B	349	ASN
2	B	372	LYS

Some sidechains can be flipped to improve hydrogen bonding and reduce clashes. All (1) such sidechains are listed below:

Mol	Chain	Res	Type
1	A	266	HIS

5.3.3 RNA [i](#)

There are no RNA molecules in this entry.

5.4 Non-standard residues in protein, DNA, RNA chains [i](#)

There are no non-standard protein/DNA/RNA residues in this entry.

5.5 Carbohydrates [i](#)

There are no carbohydrates in this entry.

5.6 Ligand geometry [i](#)

Of 4 ligands modelled in this entry, 1 is monoatomic - leaving 3 for Mogul analysis.

In the following table, the Counts columns list the number of bonds (or angles) for which Mogul statistics could be retrieved, the number of bonds (or angles) that are observed in the model and the number of bonds (or angles) that are defined in the Chemical Component Dictionary. The Link column lists molecule types, if any, to which the group is linked. The Z score for a bond length (or angle) is the number of standard deviations the observed value is removed from the expected value. A bond length (or angle) with $|Z| > 2$ is considered an outlier worth inspection. RMSZ is the root-mean-square of all Z scores of the bond lengths (or angles).

Mol	Type	Chain	Res	Link	Bond lengths			Bond angles		
					Counts	RMSZ	# Z > 2	Counts	RMSZ	# Z > 2
4	GTP	A	501	5	26,34,34	1.05	1 (3%)	33,54,54	2.08	5 (15%)
6	GDP	B	501	-	24,30,30	1.37	4 (16%)	31,47,47	2.23	8 (25%)
7	LOC	B	502	-	28,31,31	1.15	3 (10%)	28,44,44	0.77	0

In the following table, the Chirals column lists the number of chiral outliers, the number of chiral centers analysed, the number of these observed in the model and the number defined in the Chemical Component Dictionary. Similar counts are reported in the Torsion and Rings columns. '-' means no outliers of that kind were identified.

Mol	Type	Chain	Res	Link	Chirals	Torsions	Rings
4	GTP	A	501	5	-	5/18/38/38	0/3/3/3
6	GDP	B	501	-	-	3/12/32/32	0/3/3/3
7	LOC	B	502	-	-	0/10/25/25	0/3/3/3

All (8) bond length outliers are listed below:

Mol	Chain	Res	Type	Atoms	Z	Observed(Å)	Ideal(Å)
6	B	501	GDP	PB-O2B	-3.86	1.40	1.54
7	B	502	LOC	C15-C16	3.41	1.46	1.39
6	B	501	GDP	C6-N1	3.31	1.38	1.33
4	A	501	GTP	C6-N1	3.29	1.38	1.33
7	B	502	LOC	C19-C17	-2.67	1.34	1.39
6	B	501	GDP	C6-C5	2.12	1.45	1.41
7	B	502	LOC	C20-C21	-2.11	1.35	1.40
6	B	501	GDP	C8-N7	-2.04	1.31	1.34

All (13) bond angle outliers are listed below:

Mol	Chain	Res	Type	Atoms	Z	Observed(°)	Ideal(°)
6	B	501	GDP	C5-C6-N1	-8.16	112.27	123.43
4	A	501	GTP	C5-C6-N1	-8.09	112.37	123.43
6	B	501	GDP	C6-N1-C2	5.96	125.40	115.93
4	A	501	GTP	C6-N1-C2	5.87	125.26	115.93
6	B	501	GDP	C6-C5-C4	-2.95	117.98	120.80
6	B	501	GDP	N3-C2-N1	-2.93	123.31	127.22
4	A	501	GTP	N3-C2-N1	-2.90	123.35	127.22
4	A	501	GTP	C6-C5-C4	-2.70	118.22	120.80
6	B	501	GDP	PA-O3A-PB	-2.51	124.22	132.83
4	A	501	GTP	C2-N3-C4	-2.41	112.61	115.36
6	B	501	GDP	C2-N3-C4	-2.22	112.82	115.36
6	B	501	GDP	O3B-PB-O1B	-2.09	102.52	110.68

Continued on next page...

Continued from previous page...

Mol	Chain	Res	Type	Atoms	Z	Observed(°)	Ideal(°)
6	B	501	GDP	O3B-PB-O2B	2.06	115.51	107.64

There are no chirality outliers.

All (8) torsion outliers are listed below:

Mol	Chain	Res	Type	Atoms
4	A	501	GTP	PB-O3B-PG-O3G
4	A	501	GTP	C5'-O5'-PA-O1A
4	A	501	GTP	C5'-O5'-PA-O2A
6	B	501	GDP	C5'-O5'-PA-O2A
6	B	501	GDP	C5'-O5'-PA-O3A
6	B	501	GDP	C5'-O5'-PA-O1A
4	A	501	GTP	PB-O3B-PG-O2G
4	A	501	GTP	C5'-O5'-PA-O3A

There are no ring outliers.

2 monomers are involved in 2 short contacts:

Mol	Chain	Res	Type	Clashes	Symm-Clashes
6	B	501	GDP	1	0
7	B	502	LOC	1	0

The following is a two-dimensional graphical depiction of Mogul quality analysis of bond lengths, bond angles, torsion angles, and ring geometry for all instances of the Ligand of Interest. In addition, ligands with molecular weight > 250 and outliers as shown on the validation Tables will also be included. For torsion angles, if less than 5% of the Mogul distribution of torsion angles is within 10 degrees of the torsion angle in question, then that torsion angle is considered an outlier. Any bond that is central to one or more torsion angles identified as an outlier by Mogul will be highlighted in the graph. For rings, the root-mean-square deviation (RMSD) between the ring in question and similar rings identified by Mogul is calculated over all ring torsion angles. If the average RMSD is greater than 60 degrees and the minimal RMSD between the ring in question and any Mogul-identified rings is also greater than 60 degrees, then that ring is considered an outlier. The outliers are highlighted in purple. The color gray indicates Mogul did not find sufficient equivalents in the CSD to analyse the geometry.

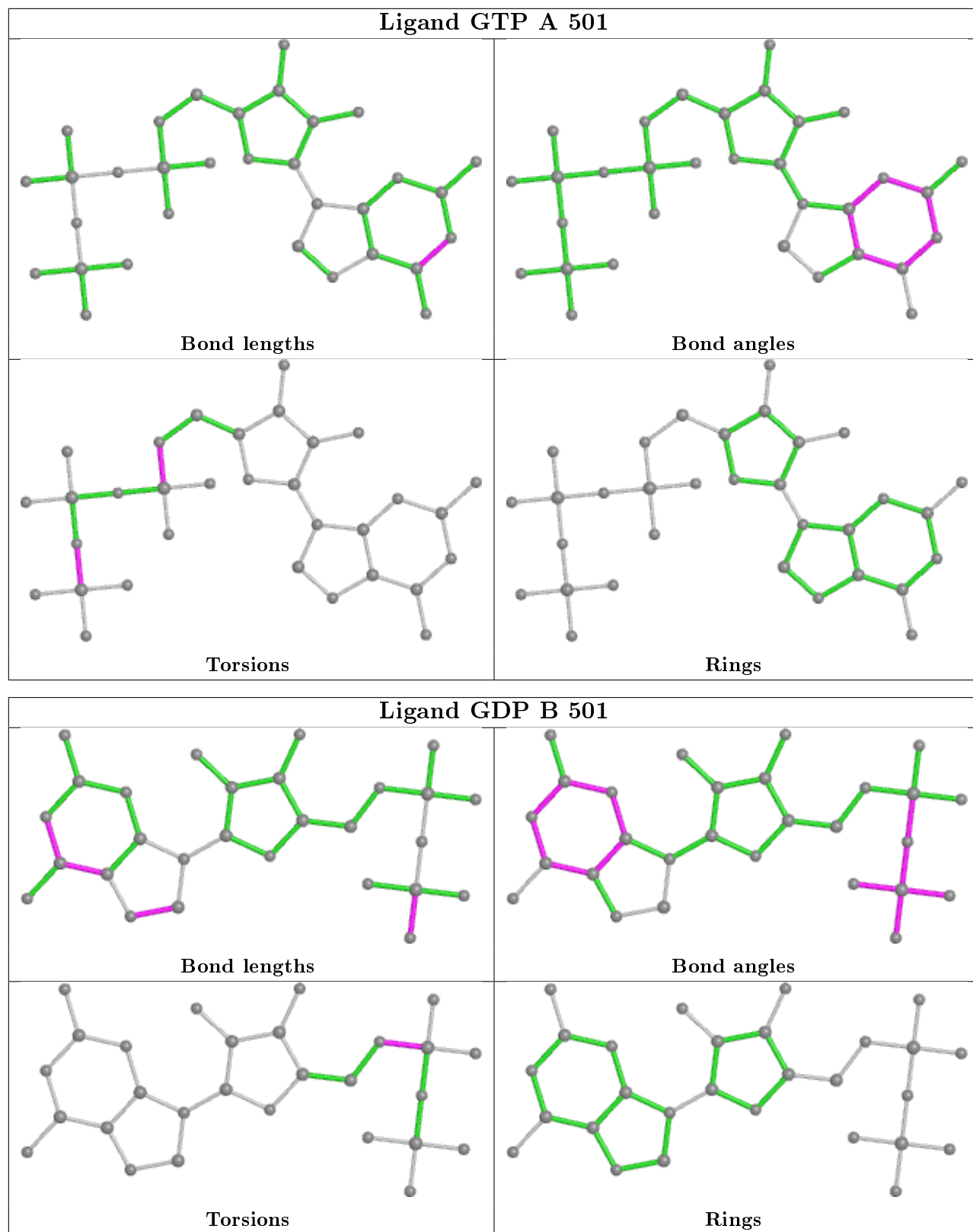

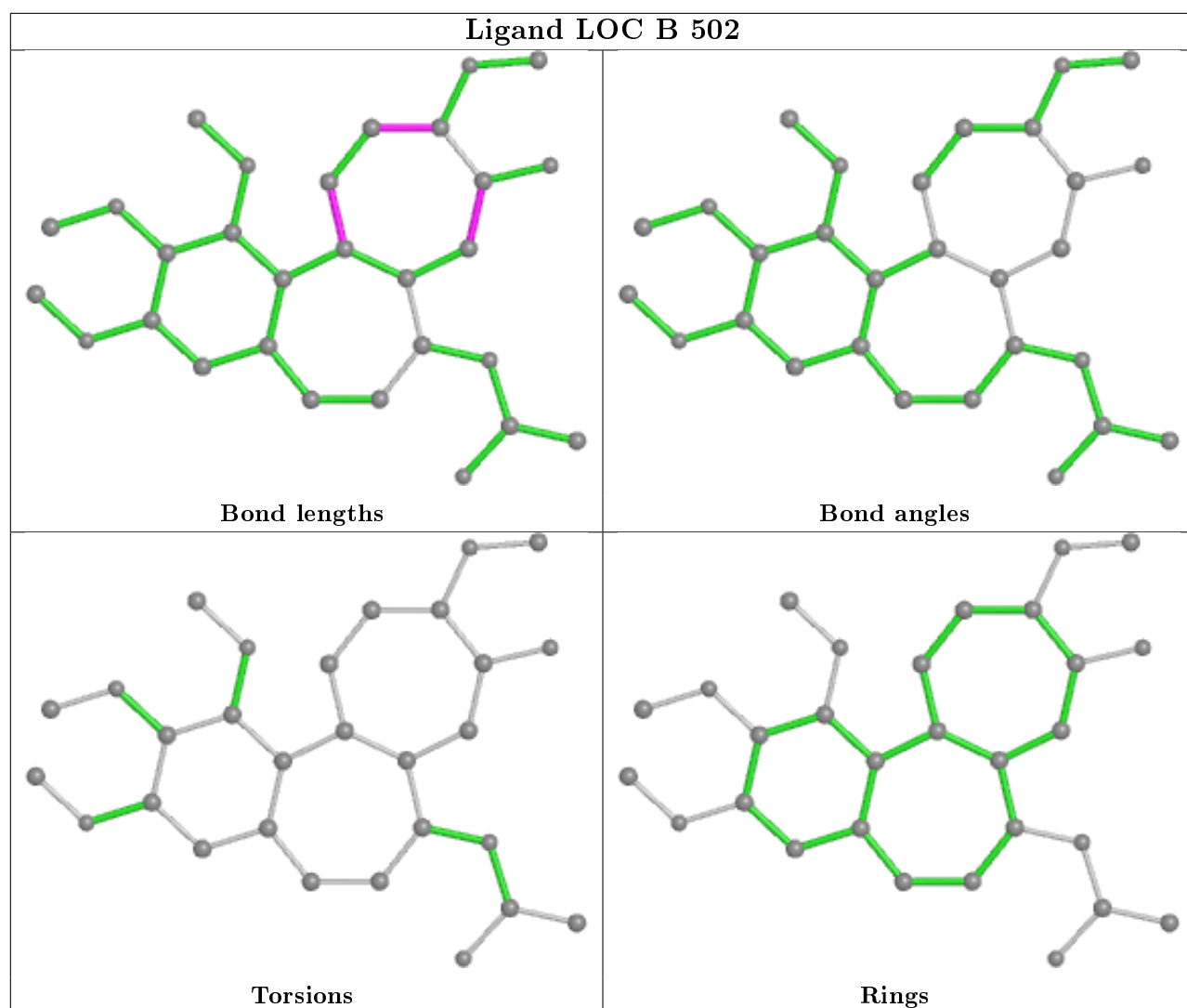

5.7 Other polymers [i](#)

There are no such residues in this entry.

5.8 Polymer linkage issues [i](#)

There are no chain breaks in this entry.

6 Fit of model and data i

6.1 Protein, DNA and RNA chains i

In the following table, the column labelled ‘#RSRZ> 2’ contains the number (and percentage) of RSRZ outliers, followed by percent RSRZ outliers for the chain as percentile scores relative to all X-ray entries and entries of similar resolution. The OWAB column contains the minimum, median, 95th percentile and maximum values of the occupancy-weighted average B-factor per residue. The column labelled ‘Q< 0.9’ lists the number of (and percentage) of residues with an average occupancy less than 0.9.

Mol	Chain	Analysed	<RSRZ>	#RSRZ>2	OWAB(Å ²)	Q<0.9
1	A	422/451 (93%)	0.30	39 (9%) 9 9	55, 76, 111, 139	0
2	B	417/445 (93%)	0.80	76 (18%) 1 1	59, 86, 131, 186	0
3	F	155/169 (91%)	0.07	9 (5%) 23 25	62, 78, 119, 196	0
All	All	994/1065 (93%)	0.48	124 (12%) 3 3	55, 80, 124, 196	0

All (124) RSRZ outliers are listed below:

Mol	Chain	Res	Type	RSRZ
3	F	164	ILE	7.5
2	B	202	TYR	6.8
3	F	167	LYS	6.8
2	B	358	ILE	6.5
2	B	441	ASP	6.3
2	B	61	TYR	6.3
1	A	1	MET	5.9
2	B	42	LEU	5.5
2	B	168	THR	5.3
2	B	169	PHE	4.9
2	B	201	THR	4.9
2	B	440	ALA	4.7
2	B	378	ILE	4.5
2	B	214	PHE	4.4
2	B	167	ASN	4.4
2	B	271	GLY	4.4
2	B	268	PHE	4.2
2	B	37	HIS	4.1
2	B	203	CYS	3.9
1	A	345	ASP	3.7
1	A	20	CYS	3.7
2	B	377	PHE	3.7
1	A	123[A]	ARG	3.7

Continued on next page...

Continued from previous page...

Mol	Chain	Res	Type	RSRZ
1	A	221	ARG	3.6
1	A	137	VAL	3.6
2	B	247	GLN	3.6
2	B	270	PRO	3.5
1	A	234	ILE	3.5
1	A	270	ALA	3.5
2	B	204	ILE	3.4
2	B	46	LEU	3.4
2	B	237	GLY	3.4
3	F	166	GLN	3.3
1	A	346	TRP	3.3
2	B	171	VAL	3.3
2	B	217	LEU	3.3
2	B	170	SER	3.2
3	F	149	ALA	3.2
2	B	126	SER	3.2
1	A	238	ILE	3.2
1	A	240	ALA	3.1
1	A	114	ILE	3.1
1	A	7	ILE	3.1
2	B	357	ASP	3.1
1	A	239	THR	3.0
2	B	140	SER	3.0
2	B	234	THR	3.0
2	B	317	ALA	3.0
2	B	36	TYR	3.0
1	A	302	MET	3.0
2	B	238	VAL	2.9
2	B	412	GLY	2.9
1	A	58	ALA	2.9
2	B	40	SER	2.9
2	B	439	THR	2.8
3	F	48	LEU	2.8
1	A	80	THR	2.8
1	A	26	LEU	2.8
2	B	210	TYR	2.8
2	B	68	VAL	2.7
2	B	272	PHE	2.7
1	A	170	SER	2.7
3	F	161	LEU	2.7
1	A	203	MET	2.7
1	A	231	ILE	2.7

Continued on next page...

Continued from previous page...

Mol	Chain	Res	Type	RSRZ
2	B	376	THR	2.7
1	A	169	PHE	2.7
2	B	296	PHE	2.6
2	B	212	ILE	2.6
1	A	202	PHE	2.6
2	B	216	THR	2.6
2	B	150	GLY	2.6
2	B	315	VAL	2.5
1	A	201	ALA	2.5
2	B	233	ALA	2.5
2	B	266	HIS	2.5
2	B	334	ASN	2.5
1	A	60	LYS	2.5
2	B	227	LEU	2.5
2	B	299	LYS	2.5
2	B	190	SER	2.4
2	B	408	TYR	2.4
2	B	84	GLY	2.4
2	B	338	LYS	2.4
1	A	219	ILE	2.4
2	B	102	ASN	2.4
3	F	30	VAL	2.4
2	B	115	VAL	2.3
2	B	316	ALA	2.3
2	B	224	TYR	2.3
1	A	376	CYS	2.3
2	B	172	MET	2.3
2	B	255	LEU	2.3
2	B	141	LEU	2.3
1	A	309	HIS	2.3
2	B	139	HIS	2.3
2	B	200	GLU	2.2
1	A	16	ILE	2.2
2	B	267	PHE	2.2
2	B	277	SER	2.2
2	B	269	MET	2.2
2	B	119	LEU	2.2
2	B	194	LEU	2.2
2	B	83	PHE	2.2
2	B	138	THR	2.2
1	A	17	GLY	2.2
1	A	167	LEU	2.2

Continued on next page...

Continued from previous page...

Mol	Chain	Res	Type	RSRZ
2	B	379	GLY	2.2
1	A	9	VAL	2.1
1	A	332	ILE	2.1
1	A	355	ILE	2.1
3	F	26	GLN	2.1
3	F	165	LEU	2.1
2	B	314	THR	2.1
1	A	168	GLU	2.1
2	B	213	CYS	2.1
1	A	232	SER	2.1
1	A	269	LEU	2.1
1	A	303	VAL	2.1
2	B	286	LEU	2.0
1	A	344	VAL	2.0
2	B	147	SER	2.0
2	B	291	LEU	2.0
2	B	260	VAL	2.0

6.2 Non-standard residues in protein, DNA, RNA chains [i](#)

There are no non-standard protein/DNA/RNA residues in this entry.

6.3 Carbohydrates [i](#)

There are no carbohydrates in this entry.

6.4 Ligands [i](#)

In the following table, the Atoms column lists the number of modelled atoms in the group and the number defined in the chemical component dictionary. The B-factors column lists the minimum, median, 95th percentile and maximum values of B factors of atoms in the group. The column labelled 'Q< 0.9' lists the number of atoms with occupancy less than 0.9.

Mol	Type	Chain	Res	Atoms	RSCC	RSR	B-factors(Å ²)	Q<0.9
7	LOC	B	502	29/29	0.92	0.20	60,68,81,83	0
6	GDP	B	501	28/28	0.94	0.13	61,64,70,76	0
5	MG	A	502	1/1	0.94	0.11	48,48,48,48	0
4	GTP	A	501	32/32	0.97	0.13	46,53,60,67	0

The following is a graphical depiction of the model fit to experimental electron density of all

instances of the Ligand of Interest. In addition, ligands with molecular weight > 250 and outliers as shown on the geometry validation Tables will also be included. Each fit is shown from different orientation to approximate a three-dimensional view.

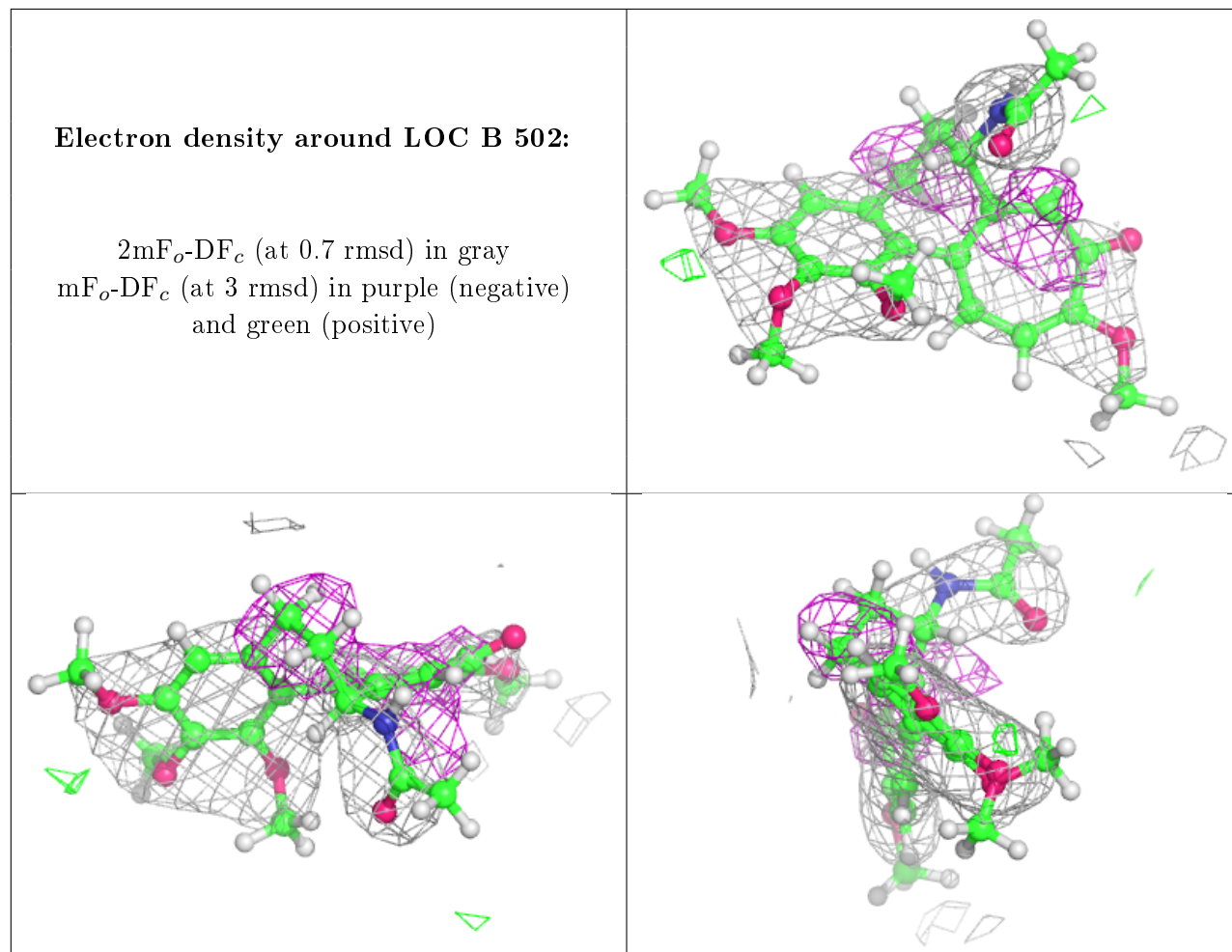

Electron density around GDP B 501:

$2mF_o-DF_c$ (at 0.7 rmsd) in gray
 mF_o-DF_c (at 3 rmsd) in purple (negative)
and green (positive)

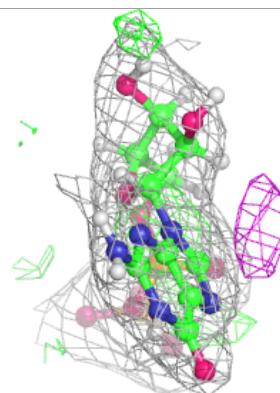
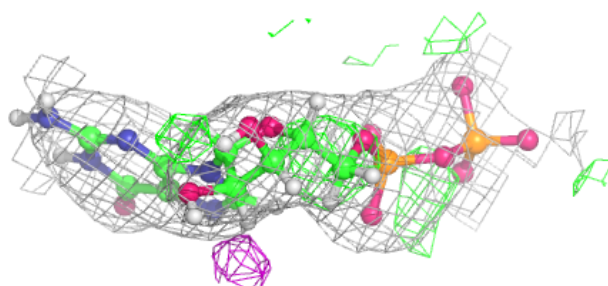
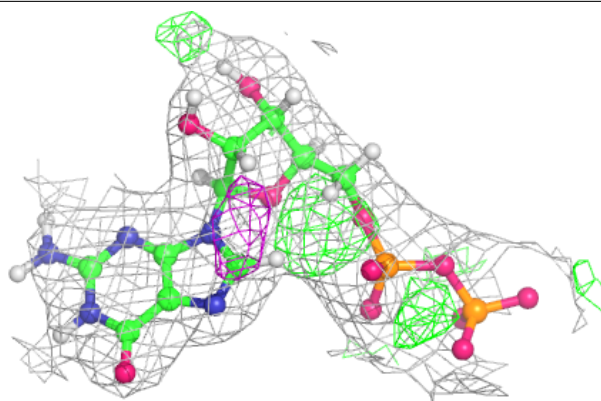
**Electron density around GTP A 501:**

$2mF_o-DF_c$ (at 0.7 rmsd) in gray
 mF_o-DF_c (at 3 rmsd) in purple (negative)
and green (positive)

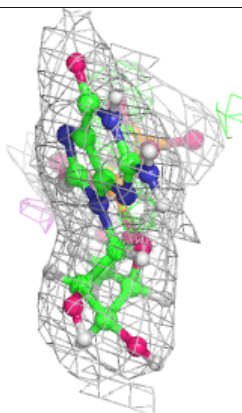
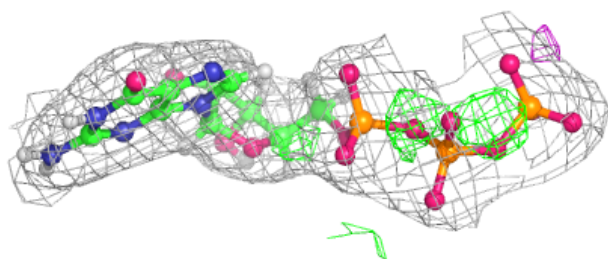
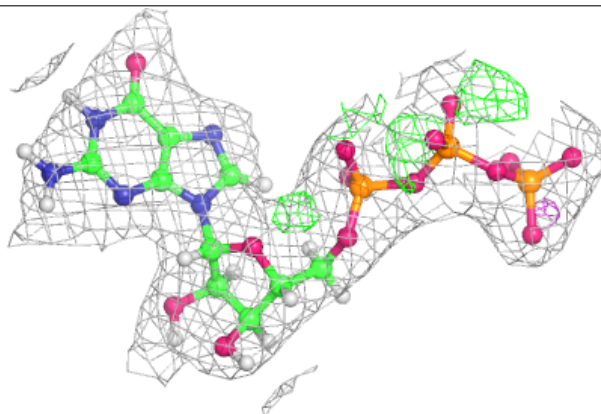

6.5 Other polymers [i](#)

There are no such residues in this entry.