



# Full wwPDB X-ray Structure Validation Report ⓘ

Jun 25, 2024 – 01:09 AM EDT

PDB ID : 6NXC  
Title : ECAI(T162A) MUTANT IN COMPLEX WITH CITRATE AT PH 4  
Authors : Lubkowski, J.; Wlodawer, A.  
Deposited on : 2019-02-08  
Resolution : 1.74 Å(reported)

This is a Full wwPDB X-ray Structure Validation Report for a publicly released PDB entry.

We welcome your comments at [validation@mail.wwpdb.org](mailto:validation@mail.wwpdb.org)

A user guide is available at

<https://www.wwpdb.org/validation/2017/XrayValidationReportHelp>

with specific help available everywhere you see the ⓘ symbol.

The types of validation reports are described at

<http://www.wwpdb.org/validation/2017/FAQs#types>.

---

The following versions of software and data (see [references ⓘ](#)) were used in the production of this report:

MolProbity : 4.02b-467  
Mogul : 1.8.5 (274361), CSD as541be (2020)  
Xtriage (Phenix) : 1.13  
EDS : 2.37.1  
buster-report : 1.1.7 (2018)  
Percentile statistics : 20191225.v01 (using entries in the PDB archive December 25th 2019)  
Refmac : 5.8.0158  
CCP4 : 7.0.044 (Gargrove)  
Ideal geometry (proteins) : Engh & Huber (2001)  
Ideal geometry (DNA, RNA) : Parkinson et al. (1996)  
Validation Pipeline (wwPDB-VP) : 2.37.1

# 1 Overall quality at a glance

The following experimental techniques were used to determine the structure:

*X-RAY DIFFRACTION*

The reported resolution of this entry is 1.74 Å.

Percentile scores (ranging between 0-100) for global validation metrics of the entry are shown in the following graphic. The table shows the number of entries on which the scores are based.

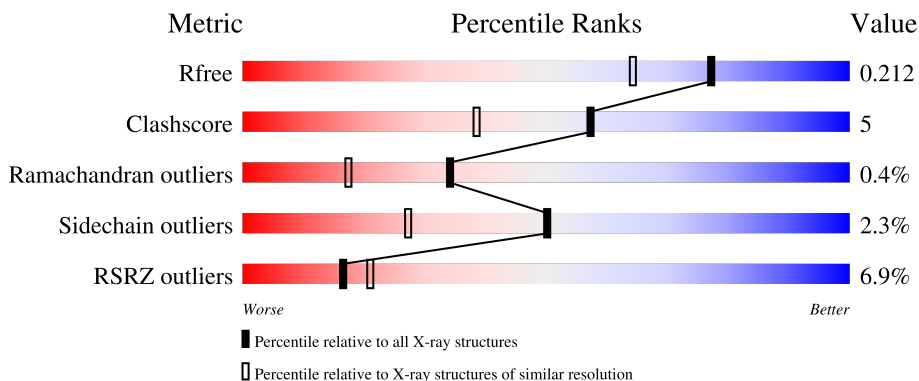

Metric	Whole archive (#Entries)	Similar resolution (#Entries, resolution range(Å))
$R_{free}$	130704	3764 (1.76-1.72)
Clashscore	141614	3923 (1.76-1.72)
Ramachandran outliers	138981	3878 (1.76-1.72)
Sidechain outliers	138945	3878 (1.76-1.72)
RSRZ outliers	127900	3705 (1.76-1.72)

The table below summarises the geometric issues observed across the polymeric chains and their fit to the electron density. The red, orange, yellow and green segments of the lower bar indicate the fraction of residues that contain outliers for  $\geq 3$ , 2, 1 and 0 types of geometric quality criteria respectively. A grey segment represents the fraction of residues that are not modelled. The numeric value for each fraction is indicated below the corresponding segment, with a dot representing fractions  $\leq 5\%$ . The upper red bar (where present) indicates the fraction of residues that have poor fit to the electron density. The numeric value is given above the bar.

Mol	Chain	Length	Quality of chain
1	A	357	 7% 81% 9% • 9%
1	B	357	 6% 80% 13% • 6%
1	C	357	 8% 78% 11% • 10%
1	D	357	 4% 83% 11% 6%

The following table lists non-polymeric compounds, carbohydrate monomers and non-standard

residues in protein, DNA, RNA chains that are outliers for geometric or electron-density-fit criteria:

Mol	Type	Chain	Res	Chirality	Geometry	Clashes	Electron density
5	GOL	A	9105	-	-	X	-

## 2 Entry composition [i](#)

There are 7 unique types of molecules in this entry. The entry contains 10857 atoms, of which 0 are hydrogens and 0 are deuteriums.

In the tables below, the ZeroOcc column contains the number of atoms modelled with zero occupancy, the AltConf column contains the number of residues with at least one atom in alternate conformation and the Trace column contains the number of residues modelled with at most 2 atoms.

- Molecule 1 is a protein called L-asparaginase 1.

Mol	Chain	Residues	Atoms					ZeroOcc	AltConf	Trace
			Total	C	N	O	S			
1	A	326	2504	1585	432	475	12	0	2	0
1	B	336	2589	1642	448	487	12	0	4	0
1	C	323	2485	1577	426	470	12	0	2	0
1	D	334	2570	1629	446	483	12	0	1	0

There are 84 discrepancies between the modelled and reference sequences:

Chain	Residue	Modelled	Actual	Comment	Reference
A	-19	MET	-	initiating methionine	UNP P0A962
A	-18	GLY	-	expression tag	UNP P0A962
A	-17	SER	-	expression tag	UNP P0A962
A	-16	SER	-	expression tag	UNP P0A962
A	-15	HIS	-	expression tag	UNP P0A962
A	-14	HIS	-	expression tag	UNP P0A962
A	-13	HIS	-	expression tag	UNP P0A962
A	-12	HIS	-	expression tag	UNP P0A962
A	-11	HIS	-	expression tag	UNP P0A962
A	-10	HIS	-	expression tag	UNP P0A962
A	-9	SER	-	expression tag	UNP P0A962
A	-8	SER	-	expression tag	UNP P0A962
A	-7	GLY	-	expression tag	UNP P0A962
A	-6	LEU	-	expression tag	UNP P0A962
A	-5	VAL	-	expression tag	UNP P0A962
A	-4	PRO	-	expression tag	UNP P0A962
A	-3	ARG	-	expression tag	UNP P0A962
A	-2	GLY	-	expression tag	UNP P0A962
A	-1	SER	-	expression tag	UNP P0A962
A	0	HIS	-	expression tag	UNP P0A962
A	162	ALA	THR	engineered mutation	UNP P0A962

*Continued on next page...*

*Continued from previous page...*

Chain	Residue	Modelled	Actual	Comment	Reference
B	-19	MET	-	initiating methionine	UNP P0A962
B	-18	GLY	-	expression tag	UNP P0A962
B	-17	SER	-	expression tag	UNP P0A962
B	-16	SER	-	expression tag	UNP P0A962
B	-15	HIS	-	expression tag	UNP P0A962
B	-14	HIS	-	expression tag	UNP P0A962
B	-13	HIS	-	expression tag	UNP P0A962
B	-12	HIS	-	expression tag	UNP P0A962
B	-11	HIS	-	expression tag	UNP P0A962
B	-10	HIS	-	expression tag	UNP P0A962
B	-9	SER	-	expression tag	UNP P0A962
B	-8	SER	-	expression tag	UNP P0A962
B	-7	GLY	-	expression tag	UNP P0A962
B	-6	LEU	-	expression tag	UNP P0A962
B	-5	VAL	-	expression tag	UNP P0A962
B	-4	PRO	-	expression tag	UNP P0A962
B	-3	ARG	-	expression tag	UNP P0A962
B	-2	GLY	-	expression tag	UNP P0A962
B	-1	SER	-	expression tag	UNP P0A962
B	0	HIS	-	expression tag	UNP P0A962
B	162	ALA	THR	engineered mutation	UNP P0A962
C	-19	MET	-	initiating methionine	UNP P0A962
C	-18	GLY	-	expression tag	UNP P0A962
C	-17	SER	-	expression tag	UNP P0A962
C	-16	SER	-	expression tag	UNP P0A962
C	-15	HIS	-	expression tag	UNP P0A962
C	-14	HIS	-	expression tag	UNP P0A962
C	-13	HIS	-	expression tag	UNP P0A962
C	-12	HIS	-	expression tag	UNP P0A962
C	-11	HIS	-	expression tag	UNP P0A962
C	-10	HIS	-	expression tag	UNP P0A962
C	-9	SER	-	expression tag	UNP P0A962
C	-8	SER	-	expression tag	UNP P0A962
C	-7	GLY	-	expression tag	UNP P0A962
C	-6	LEU	-	expression tag	UNP P0A962
C	-5	VAL	-	expression tag	UNP P0A962
C	-4	PRO	-	expression tag	UNP P0A962
C	-3	ARG	-	expression tag	UNP P0A962
C	-2	GLY	-	expression tag	UNP P0A962
C	-1	SER	-	expression tag	UNP P0A962
C	0	HIS	-	expression tag	UNP P0A962
C	162	ALA	THR	engineered mutation	UNP P0A962

*Continued on next page...*

Continued from previous page...

Chain	Residue	Modelled	Actual	Comment	Reference
D	-19	MET	-	initiating methionine	UNP P0A962
D	-18	GLY	-	expression tag	UNP P0A962
D	-17	SER	-	expression tag	UNP P0A962
D	-16	SER	-	expression tag	UNP P0A962
D	-15	HIS	-	expression tag	UNP P0A962
D	-14	HIS	-	expression tag	UNP P0A962
D	-13	HIS	-	expression tag	UNP P0A962
D	-12	HIS	-	expression tag	UNP P0A962
D	-11	HIS	-	expression tag	UNP P0A962
D	-10	HIS	-	expression tag	UNP P0A962
D	-9	SER	-	expression tag	UNP P0A962
D	-8	SER	-	expression tag	UNP P0A962
D	-7	GLY	-	expression tag	UNP P0A962
D	-6	LEU	-	expression tag	UNP P0A962
D	-5	VAL	-	expression tag	UNP P0A962
D	-4	PRO	-	expression tag	UNP P0A962
D	-3	ARG	-	expression tag	UNP P0A962
D	-2	GLY	-	expression tag	UNP P0A962
D	-1	SER	-	expression tag	UNP P0A962
D	0	HIS	-	expression tag	UNP P0A962
D	162	ALA	THR	engineered mutation	UNP P0A962

- Molecule 2 is CITRIC ACID (three-letter code: CIT) (formula:  $C_6H_8O_7$ ) (labeled as "Ligand of Interest" by depositor).

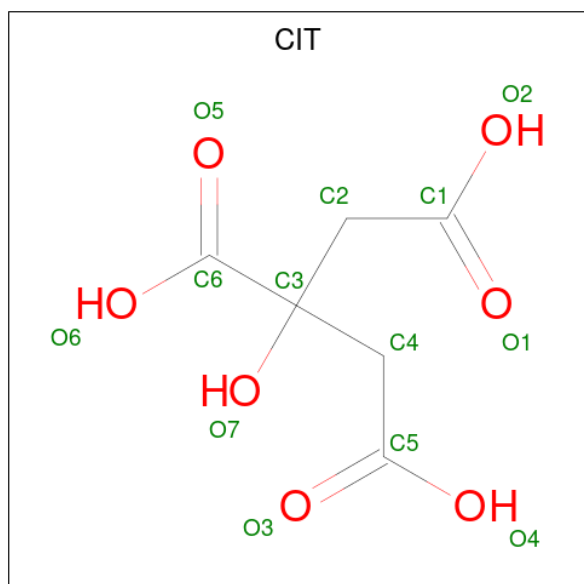

Mol	Chain	Residues	Atoms			ZeroOcc	AltConf
2	A	1	Total	C	O	0	0
			12	6	6		
2	B	1	Total	C	O	0	0
			12	6	6		
2	C	1	Total	C	O	0	0
			12	6	6		
2	D	1	Total	C	O	0	0
			12	6	6		

- Molecule 3 is 1,2-ETHANEDIOL (three-letter code: EDO) (formula: C<sub>2</sub>H<sub>6</sub>O<sub>2</sub>).

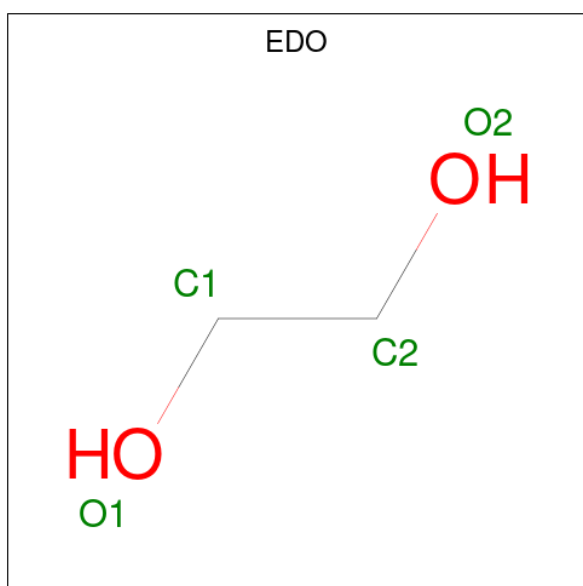

Mol	Chain	Residues	Atoms			ZeroOcc	AltConf
3	A	1	Total	C	O	0	0
			4	2	2		
3	A	1	Total	C	O	0	0
			4	2	2		
3	A	1	Total	C	O	0	0
			4	2	2		
3	B	1	Total	C	O	0	0
			4	2	2		
3	B	1	Total	C	O	0	0
			4	2	2		
3	B	1	Total	C	O	0	0
			4	2	2		
3	C	1	Total	C	O	0	0
			4	2	2		
3	C	1	Total	C	O	0	0
			4	2	2		

*Continued on next page...*

Continued from previous page...

Mol	Chain	Residues	Atoms	ZeroOcc	AltConf
3	C	1	Total C O 4 2 2	0	0
3	D	1	Total C O 4 2 2	0	0
3	D	1	Total C O 4 2 2	0	0

- Molecule 4 is CHLORIDE ION (three-letter code: CL) (formula: Cl).

Mol	Chain	Residues	Atoms	ZeroOcc	AltConf
4	A	3	Total Cl 3 3	0	0
4	B	3	Total Cl 3 3	0	0
4	C	1	Total Cl 1 1	0	0
4	D	3	Total Cl 3 3	0	0

- Molecule 5 is GLYCEROL (three-letter code: GOL) (formula: C<sub>3</sub>H<sub>8</sub>O<sub>3</sub>).

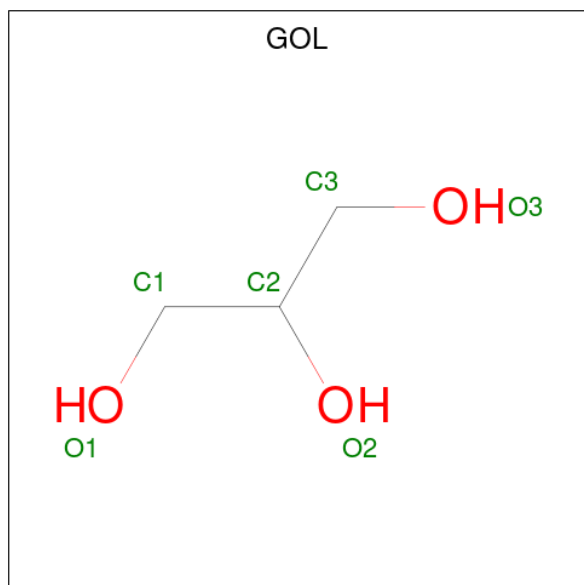

Mol	Chain	Residues	Atoms	ZeroOcc	AltConf
5	A	1	Total C O 6 3 3	0	0

- Molecule 6 is ASPARAGINE (three-letter code: ASN) (formula: C<sub>4</sub>H<sub>8</sub>N<sub>2</sub>O<sub>3</sub>) (labeled as



"Ligand of Interest" by depositor).

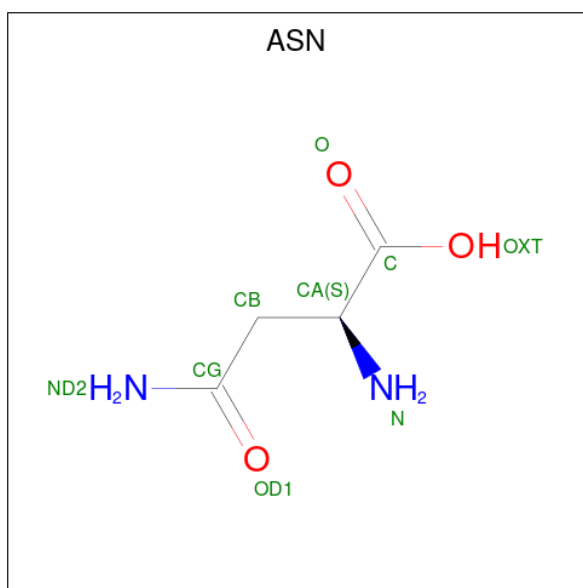

Mol	Chain	Residues	Atoms				ZeroOcc	AltConf
6	A	1	Total	C	N	O	0	0
			9	4	2	3		
6	B	1	Total	C	N	O	0	0
			9	4	2	3		
6	C	1	Total	C	N	O	0	0
			9	4	2	3		
6	D	1	Total	C	N	O	0	0
			9	4	2	3		

- Molecule 7 is water.

Mol	Chain	Residues	Atoms		ZeroOcc	AltConf
7	A	140	Total	O	0	0
			140	140		
7	B	135	Total	O	0	0
			135	135		
7	C	131	Total	O	0	0
			131	131		
7	D	159	Total	O	0	0
			159	159		

### 3 Residue-property plots [i](#)

These plots are drawn for all protein, RNA, DNA and oligosaccharide chains in the entry. The first graphic for a chain summarises the proportions of the various outlier classes displayed in the second graphic. The second graphic shows the sequence view annotated by issues in geometry and electron density. Residues are color-coded according to the number of geometric quality criteria for which they contain at least one outlier: green = 0, yellow = 1, orange = 2 and red = 3 or more. A red dot above a residue indicates a poor fit to the electron density ( $RSRZ > 2$ ). Stretches of 2 or more consecutive residues without any outlier are shown as a green connector. Residues present in the sample, but not in the model, are shown in grey.

- Molecule 1: L-asparaginase 1

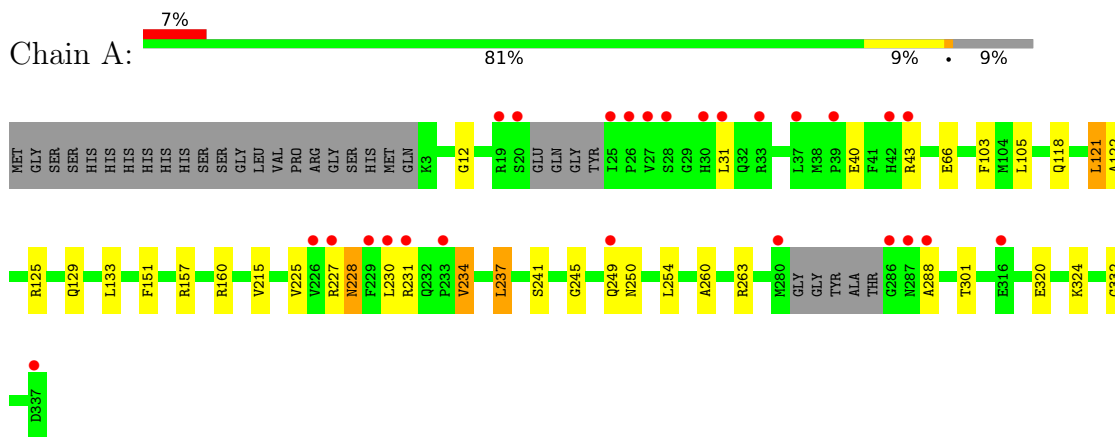

- Molecule 1: L-asparaginase 1

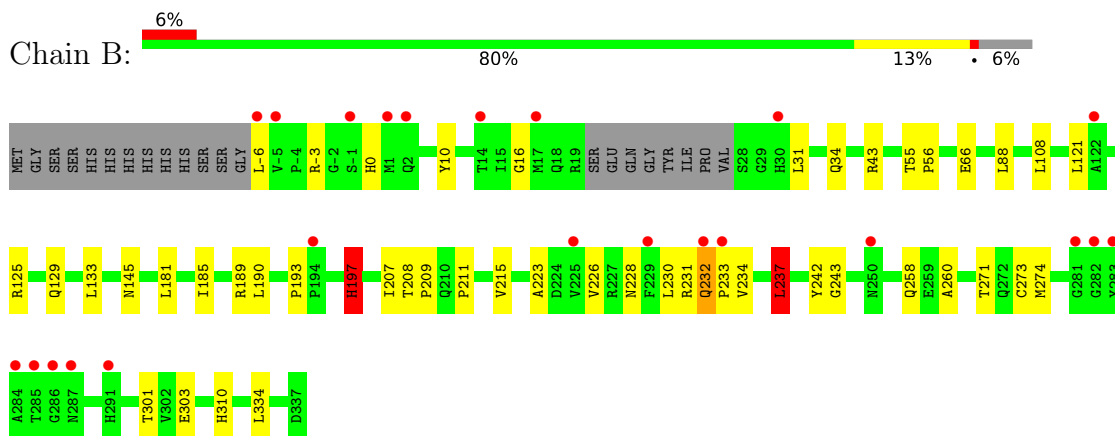

- Molecule 1: L-asparaginase 1

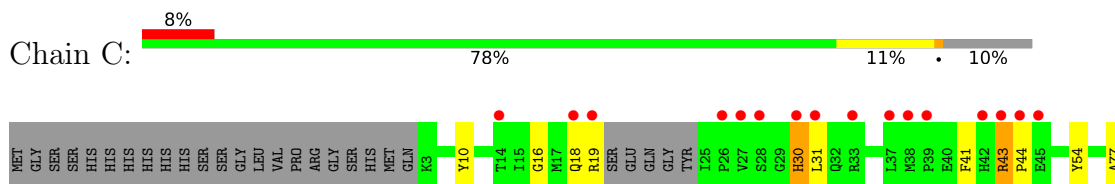

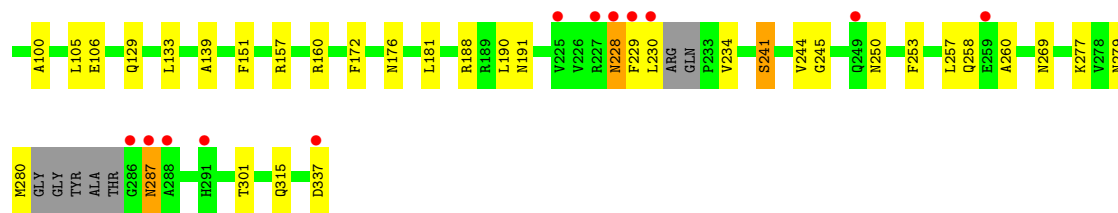

● Molecule 1: L-asparaginase 1

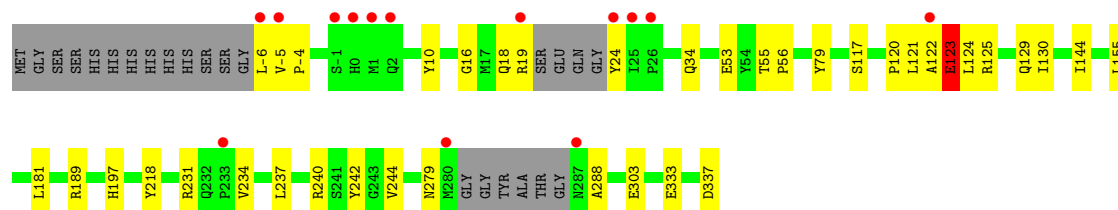
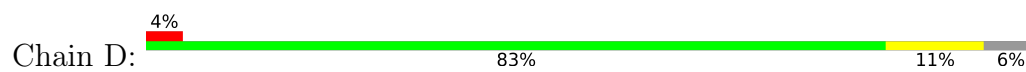

## 4 Data and refinement statistics

Property	Value	Source
Space group	P 1 21 1	Depositor
Cell constants a, b, c, $\alpha$ , $\beta$ , $\gamma$	90.52Å 89.77Å 93.29Å 90.00° 117.14° 90.00°	Depositor
Resolution (Å)	46.54 – 1.74 46.54 – 1.74	Depositor EDS
% Data completeness (in resolution range)	93.9 (46.54-1.74) 93.9 (46.54-1.74)	Depositor EDS
$R_{merge}$	(Not available)	Depositor
$R_{sym}$	(Not available)	Depositor
$\langle I/\sigma(I) \rangle$ <sup>1</sup>	2.38 (at 1.74Å)	Xtrriage
Refinement program	REFMAC 5.8.0232	Depositor
R, $R_{free}$	0.166 , 0.208 0.176 , 0.212	Depositor DCC
$R_{free}$ test set	6415 reflections (5.06%)	wwPDB-VP
Wilson B-factor (Å <sup>2</sup> )	19.9	Xtrriage
Anisotropy	0.041	Xtrriage
Bulk solvent $k_{sol}$ (e/Å <sup>3</sup> ), $B_{sol}$ (Å <sup>2</sup> )	0.38 , 50.2	EDS
L-test for twinning <sup>2</sup>	$\langle  L  \rangle = 0.49$ , $\langle L^2 \rangle = 0.32$	Xtrriage
Estimated twinning fraction	0.015 for h,-k,-h-l	Xtrriage
$F_o, F_c$ correlation	0.96	EDS
Total number of atoms	10857	wwPDB-VP
Average B, all atoms (Å <sup>2</sup> )	28.0	wwPDB-VP

Xtrriage's analysis on translational NCS is as follows: *The largest off-origin peak in the Patterson function is 5.19% of the height of the origin peak. No significant pseudotranslation is detected.*

<sup>1</sup>Intensities estimated from amplitudes.

<sup>2</sup>Theoretical values of  $\langle |L| \rangle$ ,  $\langle L^2 \rangle$  for acentric reflections are 0.5, 0.333 respectively for untwinned datasets, and 0.375, 0.2 for perfectly twinned datasets.

## 5 Model quality [i](#)

### 5.1 Standard geometry [i](#)

Bond lengths and bond angles in the following residue types are not validated in this section: GOL, CL, CIT, EDO

The Z score for a bond length (or angle) is the number of standard deviations the observed value is removed from the expected value. A bond length (or angle) with  $|Z| > 5$  is considered an outlier worth inspection. RMSZ is the root-mean-square of all Z scores of the bond lengths (or angles).

Mol	Chain	Bond lengths		Bond angles	
		RMSZ	# $ Z  > 5$	RMSZ	# $ Z  > 5$
1	A	1.05	3/2566 (0.1%)	1.15	7/3492 (0.2%)
1	B	1.04	2/2664 (0.1%)	1.14	8/3627 (0.2%)
1	C	1.03	6/2549 (0.2%)	1.17	9/3465 (0.3%)
1	D	1.03	4/2631 (0.2%)	1.13	7/3581 (0.2%)
All	All	1.04	15/10410 (0.1%)	1.15	31/14165 (0.2%)

Chiral center outliers are detected by calculating the chiral volume of a chiral center and verifying if the center is modelled as a planar moiety or with the opposite hand. A planarity outlier is detected by checking planarity of atoms in a peptide group, atoms in a mainchain group or atoms of a sidechain that are expected to be planar.

Mol	Chain	#Chirality outliers	#Planarity outliers
1	A	0	1
1	C	0	2
All	All	0	3

All (15) bond length outliers are listed below:

Mol	Chain	Res	Type	Atoms	Z	Observed(Å)	Ideal(Å)
1	A	66	GLU	CD-OE2	8.00	1.34	1.25
1	C	241[A]	SER	CB-OG	-6.61	1.33	1.42
1	C	241[B]	SER	CB-OG	-6.61	1.33	1.42
1	D	303	GLU	CD-OE2	6.51	1.32	1.25
1	D	53	GLU	CD-OE1	-6.21	1.18	1.25
1	D	333	GLU	CD-OE2	6.09	1.32	1.25
1	B	303	GLU	CD-OE2	5.67	1.31	1.25
1	B	66	GLU	CD-OE1	5.42	1.31	1.25
1	A	332	GLY	C-O	5.33	1.32	1.23
1	D	117	SER	CB-OG	-5.31	1.35	1.42
1	A	12	GLY	C-O	5.27	1.32	1.23
1	C	77	ALA	C-O	5.23	1.33	1.23

*Continued on next page...*

Continued from previous page...

Mol	Chain	Res	Type	Atoms	Z	Observed(Å)	Ideal(Å)
1	C	100	ALA	C-O	5.22	1.33	1.23
1	C	139	ALA	C-O	5.09	1.33	1.23
1	C	228	ASN	C-O	5.02	1.32	1.23

All (31) bond angle outliers are listed below:

Mol	Chain	Res	Type	Atoms	Z	Observed(°)	Ideal(°)
1	A	228	ASN	CB-CA-C	7.21	124.81	110.40
1	B	242	TYR	CB-CG-CD2	-7.06	116.76	121.00
1	D	125	ARG	NE-CZ-NH2	-7.01	116.79	120.30
1	A	125	ARG	NE-CZ-NH1	-6.95	116.83	120.30
1	D	337	ASP	CA-C-O	-6.67	106.10	120.10
1	D	240	ARG	NE-CZ-NH2	6.51	123.55	120.30
1	B	242	TYR	CB-CG-CD1	6.42	124.85	121.00
1	C	160	ARG	NE-CZ-NH1	-6.34	117.13	120.30
1	C	280	MET	CG-SD-CE	-6.26	90.18	100.20
1	A	157	ARG	NE-CZ-NH2	-6.23	117.19	120.30
1	A	125	ARG	NE-CZ-NH2	6.14	123.37	120.30
1	B	237[A]	LEU	N-CA-CB	-6.13	98.13	110.40
1	B	237[B]	LEU	N-CA-CB	-6.13	98.13	110.40
1	C	157	ARG	NE-CZ-NH2	-6.02	117.29	120.30
1	D	79	TYR	CB-CG-CD1	5.95	124.57	121.00
1	C	181[A]	LEU	N-CA-CB	-5.90	98.61	110.40
1	C	181[B]	LEU	N-CA-CB	-5.90	98.61	110.40
1	C	157	ARG	NE-CZ-NH1	5.74	123.17	120.30
1	A	160	ARG	NE-CZ-NH2	-5.59	117.50	120.30
1	C	43	ARG	CG-CD-NE	-5.59	100.06	111.80
1	A	228	ASN	N-CA-CB	-5.51	100.69	110.60
1	D	123	GLU	CB-CA-C	5.46	121.33	110.40
1	D	242	TYR	CB-CG-CD1	5.46	124.28	121.00
1	C	172	PHE	CB-CG-CD1	-5.40	117.02	120.80
1	C	54	TYR	CB-CG-CD2	-5.34	117.80	121.00
1	D	218	TYR	CB-CG-CD1	-5.28	117.83	121.00
1	B	-3	ARG	CB-CA-C	5.28	120.97	110.40
1	A	103	PHE	CB-CG-CD2	-5.18	117.17	120.80
1	B	197[A]	HIS	CA-CB-CG	-5.14	104.85	113.60
1	B	197[B]	HIS	CA-CB-CG	-5.14	104.85	113.60
1	B	125	ARG	NE-CZ-NH1	-5.06	117.77	120.30

There are no chirality outliers.

All (3) planarity outliers are listed below:

Mol	Chain	Res	Type	Group
1	A	105	LEU	Mainchain
1	C	105	LEU	Mainchain
1	C	287	ASN	Peptide

## 5.2 Too-close contacts [i](#)

In the following table, the Non-H and H(model) columns list the number of non-hydrogen atoms and hydrogen atoms in the chain respectively. The H(added) column lists the number of hydrogen atoms added and optimized by MolProbity. The Clashes column lists the number of clashes within the asymmetric unit, whereas Symm-Clashes lists symmetry-related clashes.

Mol	Chain	Non-H	H(model)	H(added)	Clashes	Symm-Clashes
1	A	2504	0	2463	22	0
1	B	2589	0	2549	33	0
1	C	2485	0	2455	29	0
1	D	2570	0	2544	19	0
2	A	12	0	5	1	0
2	B	12	0	5	1	0
2	C	12	0	5	1	0
2	D	12	0	5	1	0
3	A	12	0	17	1	0
3	B	12	0	17	3	0
3	C	12	0	18	2	0
3	D	8	0	11	0	0
4	A	3	0	0	0	0
4	B	3	0	0	0	0
4	C	1	0	0	0	0
4	D	3	0	0	0	0
5	A	6	0	8	8	0
6	A	9	0	5	0	0
6	B	9	0	5	0	0
6	C	9	0	5	0	0
6	D	9	0	5	0	0
7	A	140	0	0	2	0
7	B	135	0	0	1	0
7	C	131	0	0	3	0
7	D	159	0	0	3	0
All	All	10857	0	10122	101	0

The all-atom clashscore is defined as the number of clashes found per 1000 atoms (including hydrogen atoms). The all-atom clashscore for this structure is 5.

All (101) close contacts within the same asymmetric unit are listed below, sorted by their clash magnitude.

Atom-1	Atom-2	Interatomic distance (Å)	Clash overlap (Å)
1:D:-5:VAL:CB	1:D:144:ILE:HD11	1.81	1.09
5:A:9105:GOL:H12	1:C:244:VAL:HG22	1.35	1.06
1:B:145:ASN:O	1:B:197[A]:HIS:HE1	1.45	0.99
1:C:315:GLN:HG2	7:C:507:HOH:O	1.65	0.96
1:D:130:ILE:HD11	7:D:593:HOH:O	1.70	0.90
1:B:243:GLY:O	1:B:271[B]:THR:HG23	1.75	0.87
1:C:229:PHE:O	1:C:234:VAL:HG11	1.76	0.85
5:A:9105:GOL:O2	7:A:9201:HOH:O	2.01	0.79
1:D:-5:VAL:CB	1:D:144:ILE:CD1	2.61	0.78
1:A:215:VAL:HG23	1:A:237:LEU:CD1	2.15	0.77
1:C:229:PHE:O	1:C:234:VAL:CG1	2.34	0.76
1:A:230:LEU:HD21	1:A:260:ALA:HB2	1.69	0.74
1:C:43:ARG:HG3	1:C:44:PRO:HD2	1.67	0.74
1:B:271[B]:THR:HG22	1:B:273:CYS:H	1.52	0.74
1:C:43:ARG:NH2	1:D:123:GLU:HA	2.03	0.73
1:B:145:ASN:O	1:B:197[A]:HIS:CE1	2.37	0.73
1:D:34:GLN:OE1	1:D:122:ALA:HB3	1.91	0.71
1:A:31:LEU:HD12	1:A:121:LEU:HD12	1.75	0.69
1:B:232:GLN:HB3	1:B:233:PRO:HD2	1.73	0.68
1:D:197:HIS:HD2	7:D:514:HOH:O	1.78	0.66
1:B:193:PRO:HG3	1:C:191:ASN:HD22	1.61	0.66
1:A:129:GLN:HG2	7:A:9281:HOH:O	1.96	0.65
1:B:232:GLN:HB3	1:B:233:PRO:CD	2.26	0.65
1:B:31:LEU:HA	1:B:34:GLN:OE1	1.96	0.65
1:A:230:LEU:CD2	1:A:260:ALA:HB2	2.28	0.63
5:A:9105:GOL:C1	1:C:244:VAL:H	2.11	0.62
5:A:9105:GOL:C1	1:C:244:VAL:HG22	2.22	0.62
5:A:9105:GOL:H12	1:C:244:VAL:CG2	2.21	0.62
1:C:129:GLN:HB2	7:C:568:HOH:O	2.00	0.62
1:A:230:LEU:O	1:A:263:ARG:NH2	2.33	0.61
1:B:193:PRO:HG3	1:C:191:ASN:ND2	2.15	0.61
1:B:226:VAL:O	1:B:230:LEU:HD13	2.01	0.61
1:A:225:VAL:O	1:A:228:ASN:HB3	2.01	0.60
1:B:215:VAL:HG21	1:B:237[A]:LEU:HD21	1.84	0.60
2:D:403:CIT:O2	2:D:403:CIT:C6	2.50	0.60
1:C:43:ARG:HG3	1:C:44:PRO:CD	2.32	0.60
1:D:121:LEU:HD11	1:D:129:GLN:HG3	1.84	0.60
1:B:10:TYR:OH	1:B:16:GLY:HA3	2.00	0.59
1:C:241[A]:SER:OG	1:C:245:GLY:HA2	2.01	0.59
1:A:241[B]:SER:OG	1:A:245:GLY:HA2	2.03	0.59
1:B:211:PRO:HG3	1:B:233:PRO:HB2	1.84	0.58
1:B:228:ASN:OD1	1:B:231:ARG:NH1	2.37	0.57

*Continued on next page...*



*Continued from previous page...*

Atom-1	Atom-2	Interatomic distance (Å)	Clash overlap (Å)
1:B:207:ILE:HG23	1:B:310:HIS:HB3	1.87	0.56
1:A:254:LEU:HD21	1:A:288:ALA:HB1	1.86	0.56
1:A:215:VAL:CG2	1:A:237:LEU:CD1	2.83	0.56
1:B:0:HIS:NE2	3:B:9103:EDO:H22	2.21	0.55
1:B:231:ARG:NH2	1:D:231:ARG:HD3	2.22	0.55
1:D:-4:PRO:HD2	1:D:144:ILE:HG12	1.90	0.54
1:A:215:VAL:HG23	1:A:237:LEU:HD11	1.90	0.54
2:C:403:CIT:O1	2:C:403:CIT:C6	2.56	0.53
1:A:215:VAL:CG2	1:A:237:LEU:HD11	2.39	0.53
1:A:228:ASN:ND2	1:C:228:ASN:HB3	2.24	0.53
2:B:9101:CIT:O1	2:B:9101:CIT:C6	2.57	0.53
1:A:234:VAL:HG11	1:A:237:LEU:HD23	1.91	0.52
1:B:215:VAL:CG2	1:B:237[A]:LEU:HD21	2.40	0.52
1:D:197:HIS:HE1	7:D:505:HOH:O	1.92	0.52
1:A:40:GLU:HG3	1:A:43:ARG:NH1	2.25	0.52
1:A:301:THR:HA	3:A:9103:EDO:H12	1.91	0.52
1:C:230:LEU:HD11	1:C:260:ALA:HB2	1.92	0.51
2:A:9101:CIT:C6	2:A:9101:CIT:O2	2.59	0.51
1:C:176:ASN:ND2	3:C:404:EDO:H11	2.25	0.50
1:A:122:ALA:O	1:B:43:ARG:NH1	2.45	0.50
5:A:9105:GOL:H11	1:C:244:VAL:H	1.76	0.50
1:B:121:LEU:HD11	1:B:129:GLN:HG3	1.94	0.49
1:A:227:ARG:HD3	1:A:231:ARG:NH2	2.28	0.49
1:C:43:ARG:HH22	1:D:123:GLU:HA	1.77	0.49
1:C:277:LYS:HZ1	1:C:337:ASP:C	2.15	0.49
1:C:10:TYR:OH	1:C:16:GLY:HA3	2.13	0.48
5:A:9105:GOL:H31	1:B:185:ILE:HD11	1.94	0.48
1:B:301:THR:HA	3:B:9104:EDO:H21	1.96	0.48
1:B:230:LEU:HD11	1:B:260:ALA:HB2	1.95	0.47
1:C:190:LEU:N	1:C:190:LEU:HD12	2.30	0.47
3:B:9105:EDO:H12	1:D:244:VAL:HG13	1.97	0.46
1:C:253:PHE:CE1	1:C:257:LEU:HD11	2.50	0.46
1:B:55:THR:HA	1:B:56:PRO:HA	1.79	0.46
1:D:18:GLN:O	1:D:24:TYR:N	2.49	0.45
1:B:121:LEU:CD1	1:B:129:GLN:HG3	2.48	0.44
1:D:10:TYR:OH	1:D:16:GLY:HA3	2.18	0.44
1:D:234:VAL:HG11	1:D:237:LEU:HD13	2.00	0.44
1:B:-6:LEU:HD23	1:B:190:LEU:O	2.18	0.43
1:B:207:ILE:HD13	1:B:207:ILE:HG21	1.82	0.43
1:A:320:GLU:OE2	1:A:324:LYS:NZ	2.28	0.43
1:D:155:LEU:HB3	1:D:181:LEU:HB3	2.00	0.43

*Continued on next page...*

Continued from previous page...

Atom-1	Atom-2	Interatomic distance (Å)	Clash overlap (Å)
1:B:274:MET:HE3	7:B:9326:HOH:O	2.17	0.43
1:D:120:PRO:O	1:D:123:GLU:HB3	2.19	0.43
1:C:241[A]:SER:HB3	1:C:269:ASN:OD1	2.18	0.42
1:D:124:LEU:HD23	1:D:124:LEU:HA	1.84	0.42
1:C:41:PHE:HE2	1:C:129:GLN:HG3	1.84	0.42
1:A:234:VAL:HG11	1:A:237:LEU:CD2	2.49	0.42
1:C:18:GLN:HB2	1:C:30:HIS:HD2	1.85	0.42
1:B:181[A]:LEU:CD2	1:B:189:ARG:HG2	2.49	0.42
1:A:118:GLN:OE1	5:A:9105:GOL:H32	2.20	0.42
1:C:18:GLN:O	1:C:19:ARG:HB3	2.20	0.41
1:B:271[B]:THR:CG2	1:B:273:CYS:HB2	2.50	0.41
1:C:301:THR:HA	3:C:404:EDO:H12	2.02	0.41
1:A:121:LEU:HD23	1:A:121:LEU:HA	1.98	0.41
1:B:108:LEU:O	1:B:197[A]:HIS:NE2	2.52	0.41
1:D:55:THR:HA	1:D:56:PRO:HA	1.92	0.40
1:B:88:LEU:HD23	1:B:88:LEU:HA	1.94	0.40
1:B:208:THR:HB	1:B:209:PRO:HD2	2.04	0.40
1:C:106:GLU:OE2	7:C:501:HOH:O	2.22	0.40

There are no symmetry-related clashes.

## 5.3 Torsion angles [i](#)

### 5.3.1 Protein backbone [i](#)

In the following table, the Percentiles column shows the percent Ramachandran outliers of the chain as a percentile score with respect to all X-ray entries followed by that with respect to entries of similar resolution.

The Analysed column shows the number of residues for which the backbone conformation was analysed, and the total number of residues.

Mol	Chain	Analysed	Favoured	Allowed	Outliers	Percentiles
1	A	322/357 (90%)	308 (96%)	13 (4%)	1 (0%)	41 23
1	B	336/357 (94%)	325 (97%)	9 (3%)	2 (1%)	25 10
1	C	317/357 (89%)	306 (96%)	10 (3%)	1 (0%)	41 23
1	D	329/357 (92%)	322 (98%)	6 (2%)	1 (0%)	41 23
All	All	1304/1428 (91%)	1261 (97%)	38 (3%)	5 (0%)	34 17

All (5) Ramachandran outliers are listed below:

Mol	Chain	Res	Type
1	B	232	GLN
1	C	250	ASN
1	D	288	ALA
1	A	250	ASN
1	B	223	ALA

### 5.3.2 Protein sidechains [i](#)

In the following table, the Percentiles column shows the percent sidechain outliers of the chain as a percentile score with respect to all X-ray entries followed by that with respect to entries of similar resolution.

The Analysed column shows the number of residues for which the sidechain conformation was analysed, and the total number of residues.

Mol	Chain	Analysed	Rotameric	Outliers	Percentiles	
1	A	269/296 (91%)	263 (98%)	6 (2%)	52	29
1	B	277/296 (94%)	269 (97%)	8 (3%)	42	18
1	C	267/296 (90%)	259 (97%)	8 (3%)	41	17
1	D	276/296 (93%)	271 (98%)	5 (2%)	59	38
All	All	1089/1184 (92%)	1062 (98%)	27 (2%)	50	24

All (27) residues with a non-rotameric sidechain are listed below:

Mol	Chain	Res	Type
1	A	121	LEU
1	A	133	LEU
1	A	151	PHE
1	A	234	VAL
1	A	237	LEU
1	A	249	GLN
1	B	133	LEU
1	B	197[A]	HIS
1	B	197[B]	HIS
1	B	234	VAL
1	B	237[A]	LEU
1	B	237[B]	LEU
1	B	258	GLN
1	B	334	LEU
1	C	30	HIS
1	C	31	LEU
1	C	133	LEU

*Continued on next page...*

*Continued from previous page...*

Mol	Chain	Res	Type
1	C	151	PHE
1	C	188	ARG
1	C	258	GLN
1	C	279	ASN
1	C	287	ASN
1	D	-6	LEU
1	D	19	ARG
1	D	123	GLU
1	D	189	ARG
1	D	279	ASN

Sometimes sidechains can be flipped to improve hydrogen bonding and reduce clashes. All (17) such sidechains are listed below:

Mol	Chain	Res	Type
1	A	30	HIS
1	A	129	GLN
1	A	249	GLN
1	A	315	GLN
1	A	328	GLN
1	B	18	GLN
1	B	30	HIS
1	C	34	GLN
1	C	246	ASN
1	C	279	ASN
1	D	52	HIS
1	D	145	ASN
1	D	152	ASN
1	D	232	GLN
1	D	279	ASN
1	D	287	ASN
1	D	315	GLN

### 5.3.3 RNA [i](#)

There are no RNA molecules in this entry.

### 5.4 Non-standard residues in protein, DNA, RNA chains [i](#)

There are no non-standard protein/DNA/RNA residues in this entry.

## 5.5 Carbohydrates [i](#)

There are no monosaccharides in this entry.

## 5.6 Ligand geometry [i](#)

Of 30 ligands modelled in this entry, 10 are monoatomic - leaving 20 for Mogul analysis.

In the following table, the Counts columns list the number of bonds (or angles) for which Mogul statistics could be retrieved, the number of bonds (or angles) that are observed in the model and the number of bonds (or angles) that are defined in the Chemical Component Dictionary. The Link column lists molecule types, if any, to which the group is linked. The Z score for a bond length (or angle) is the number of standard deviations the observed value is removed from the expected value. A bond length (or angle) with  $|Z| > 2$  is considered an outlier worth inspection. RMSZ is the root-mean-square of all Z scores of the bond lengths (or angles).

Mol	Type	Chain	Res	Link	Bond lengths			Bond angles		
					Counts	RMSZ	# Z  > 2	Counts	RMSZ	# Z  > 2
3	EDO	B	9104	-	3,3,3	1.25	0	2,2,2	0.71	0
6	ASN	B	9102	-	6,8,8	1.29	1 (16%)	8,10,10	1.28	2 (25%)
6	ASN	D	402	-	6,8,8	0.96	0	8,10,10	1.38	1 (12%)
3	EDO	C	401	-	3,3,3	0.34	0	2,2,2	0.69	0
2	CIT	D	403	1	11,11,12	1.34	2 (18%)	11,15,17	1.84	2 (18%)
6	ASN	A	9109	-	6,8,8	1.21	1 (16%)	8,10,10	1.20	1 (12%)
3	EDO	D	406	-	3,3,3	1.11	0	2,2,2	0.85	0
2	CIT	C	403	1	11,11,12	1.39	2 (18%)	14,15,17	1.30	2 (14%)
3	EDO	B	9103	-	3,3,3	0.21	0	2,2,2	0.17	0
3	EDO	B	9105	-	3,3,3	0.82	0	2,2,2	0.76	0
3	EDO	A	9107	-	3,3,3	0.40	0	2,2,2	0.88	0
3	EDO	A	9102	-	3,3,3	0.72	0	2,2,2	0.24	0
3	EDO	C	405	-	3,3,3	0.44	0	2,2,2	0.54	0
2	CIT	A	9101	1	11,11,12	0.86	0	14,15,17	1.93	3 (21%)
5	GOL	A	9105	-	5,5,5	0.62	0	5,5,5	0.66	0
6	ASN	C	402	-	6,8,8	1.00	0	8,10,10	1.16	2 (25%)
3	EDO	A	9103	-	3,3,3	0.74	0	2,2,2	0.62	0
3	EDO	D	407	-	3,3,3	0.67	0	2,2,2	0.32	0
3	EDO	C	404	-	3,3,3	0.60	0	2,2,2	0.24	0
2	CIT	B	9101	1	11,11,12	1.47	3 (27%)	11,15,17	1.77	2 (18%)

In the following table, the Chirals column lists the number of chiral outliers, the number of chiral centers analysed, the number of these observed in the model and the number defined in the Chemical Component Dictionary. Similar counts are reported in the Torsion and Rings columns. '-' means no outliers of that kind were identified.

Mol	Type	Chain	Res	Link	Chirals	Torsions	Rings
3	EDO	B	9104	-	-	0/1/1/1	-
6	ASN	B	9102	-	-	2/8/8/8	-
6	ASN	D	402	-	-	3/8/8/8	-
3	EDO	C	401	-	-	0/1/1/1	-
2	CIT	D	403	1	-	2/15/15/16	-
6	ASN	A	9109	-	-	1/8/8/8	-
3	EDO	D	406	-	-	0/1/1/1	-
2	CIT	C	403	1	-	1/15/15/16	-
3	EDO	B	9103	-	-	1/1/1/1	-
3	EDO	B	9105	-	-	1/1/1/1	-
3	EDO	A	9107	-	-	0/1/1/1	-
3	EDO	A	9102	-	-	0/1/1/1	-
3	EDO	C	405	-	-	0/1/1/1	-
2	CIT	A	9101	1	-	3/15/15/16	-
5	GOL	A	9105	-	-	4/4/4/4	-
6	ASN	C	402	-	-	1/8/8/8	-
3	EDO	A	9103	-	-	0/1/1/1	-
3	EDO	D	407	-	-	0/1/1/1	-
3	EDO	C	404	-	-	1/1/1/1	-
2	CIT	B	9101	1	-	2/15/15/16	-

All (9) bond length outliers are listed below:

Mol	Chain	Res	Type	Atoms	Z	Observed(Å)	Ideal(Å)
6	B	9102	ASN	O-C	2.84	1.30	1.22
6	A	9109	ASN	O-C	2.80	1.30	1.22
2	C	403	CIT	C3-C6	2.60	1.56	1.53
2	B	9101	CIT	O1-C1	2.58	1.30	1.22
2	D	403	CIT	O4-C5	-2.31	1.30	1.42
2	B	9101	CIT	O2-C1	-2.26	1.23	1.30
2	B	9101	CIT	O4-C5	-2.18	1.30	1.42
2	D	403	CIT	O2-C1	-2.09	1.23	1.30
2	C	403	CIT	O2-C1	-2.04	1.23	1.30

All (15) bond angle outliers are listed below:

Mol	Chain	Res	Type	Atoms	Z	Observed(°)	Ideal(°)
2	A	9101	CIT	O5-C6-C3	-5.54	114.41	122.25
2	B	9101	CIT	O5-C6-C3	-3.96	116.65	122.25
2	D	403	CIT	O4-C5-C4	3.87	121.72	111.39
2	D	403	CIT	O5-C6-C3	-3.74	116.96	122.25
2	B	9101	CIT	O4-C5-C4	3.72	121.32	111.39

*Continued on next page...*

*Continued from previous page...*

Mol	Chain	Res	Type	Atoms	Z	Observed(°)	Ideal(°)
2	C	403	CIT	O5-C6-C3	-3.35	117.51	122.25
6	D	402	ASN	OXT-C-O	2.90	130.66	124.09
2	A	9101	CIT	O6-C6-C3	2.57	117.52	113.05
6	A	9109	ASN	OXT-C-CA	2.52	121.96	113.38
6	B	9102	ASN	O-C-CA	-2.42	113.60	122.14
2	C	403	CIT	O6-C6-C3	2.23	116.93	113.05
6	B	9102	ASN	OXT-C-CA	2.20	120.86	113.38
2	A	9101	CIT	O7-C3-C4	2.14	114.06	109.21
6	C	402	ASN	O-C-CA	-2.09	114.78	122.14
6	C	402	ASN	OXT-C-CA	2.06	120.40	113.38

There are no chirality outliers.

All (22) torsion outliers are listed below:

Mol	Chain	Res	Type	Atoms
5	A	9105	GOL	O1-C1-C2-O2
5	A	9105	GOL	O1-C1-C2-C3
5	A	9105	GOL	C1-C2-C3-O3
5	A	9105	GOL	O2-C2-C3-O3
6	D	402	ASN	OXT-C-CA-CB
6	D	402	ASN	O-C-CA-CB
2	B	9101	CIT	C2-C3-C6-O5
2	B	9101	CIT	C2-C3-C6-O6
3	C	404	EDO	O1-C1-C2-O2
6	B	9102	ASN	OXT-C-CA-CB
6	A	9109	ASN	OXT-C-CA-CB
3	B	9103	EDO	O1-C1-C2-O2
6	B	9102	ASN	O-C-CA-CB
2	A	9101	CIT	O2-C1-C2-C3
2	A	9101	CIT	C3-C4-C5-O3
2	C	403	CIT	C3-C4-C5-O3
2	D	403	CIT	O1-C1-C2-C3
3	B	9105	EDO	O1-C1-C2-O2
2	D	403	CIT	O2-C1-C2-C3
6	C	402	ASN	OXT-C-CA-CB
2	A	9101	CIT	O1-C1-C2-C3
6	D	402	ASN	OXT-C-CA-N

There are no ring outliers.

10 monomers are involved in 18 short contacts:

Mol	Chain	Res	Type	Clashes	Symm-Clashes
3	B	9104	EDO	1	0
2	D	403	CIT	1	0
2	C	403	CIT	1	0
3	B	9103	EDO	1	0
3	B	9105	EDO	1	0
2	A	9101	CIT	1	0
5	A	9105	GOL	8	0
3	A	9103	EDO	1	0
3	C	404	EDO	2	0
2	B	9101	CIT	1	0

The following is a two-dimensional graphical depiction of Mogul quality analysis of bond lengths, bond angles, torsion angles, and ring geometry for all instances of the Ligand of Interest. In addition, ligands with molecular weight > 250 and outliers as shown on the validation Tables will also be included. For torsion angles, if less than 5% of the Mogul distribution of torsion angles is within 10 degrees of the torsion angle in question, then that torsion angle is considered an outlier. Any bond that is central to one or more torsion angles identified as an outlier by Mogul will be highlighted in the graph. For rings, the root-mean-square deviation (RMSD) between the ring in question and similar rings identified by Mogul is calculated over all ring torsion angles. If the average RMSD is greater than 60 degrees and the minimal RMSD between the ring in question and any Mogul-identified rings is also greater than 60 degrees, then that ring is considered an outlier. The outliers are highlighted in purple. The color gray indicates Mogul did not find sufficient equivalents in the CSD to analyse the geometry.



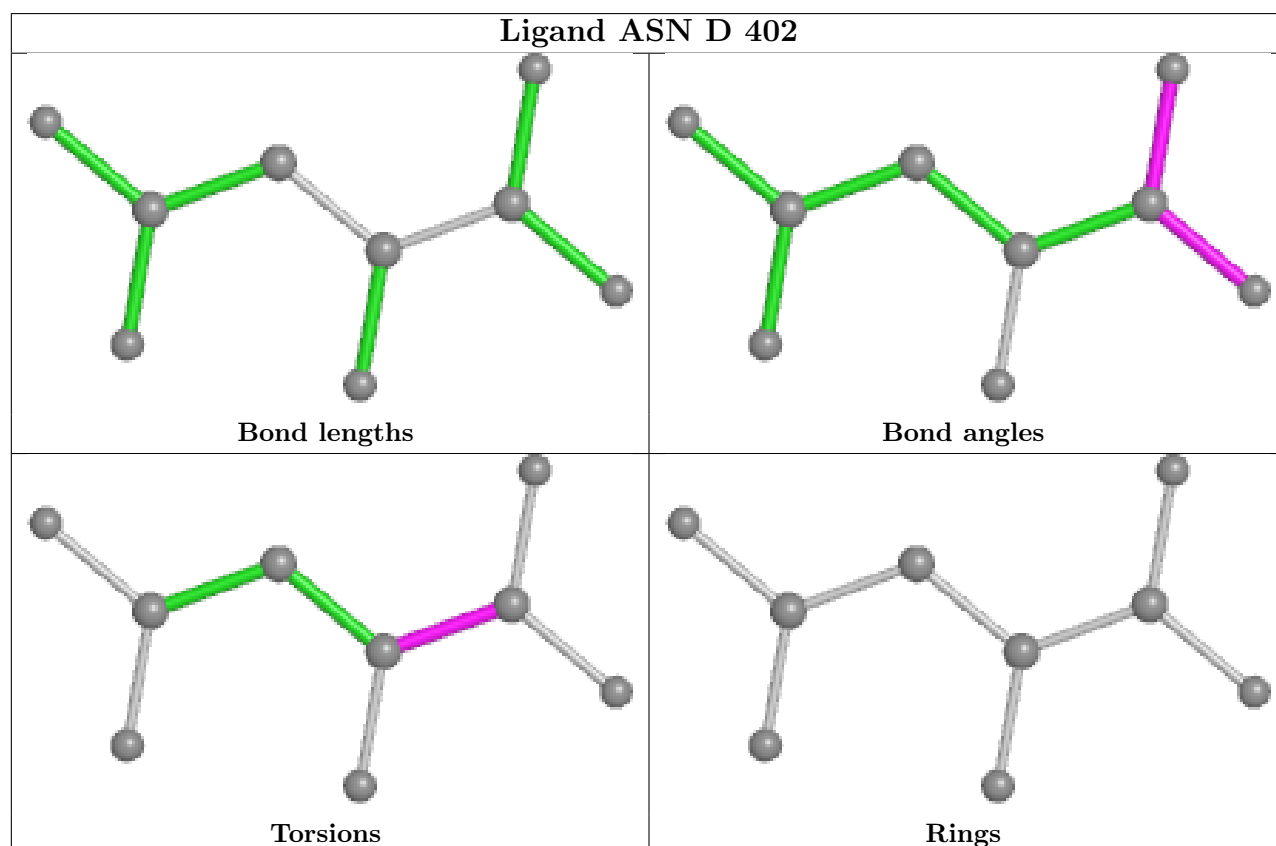
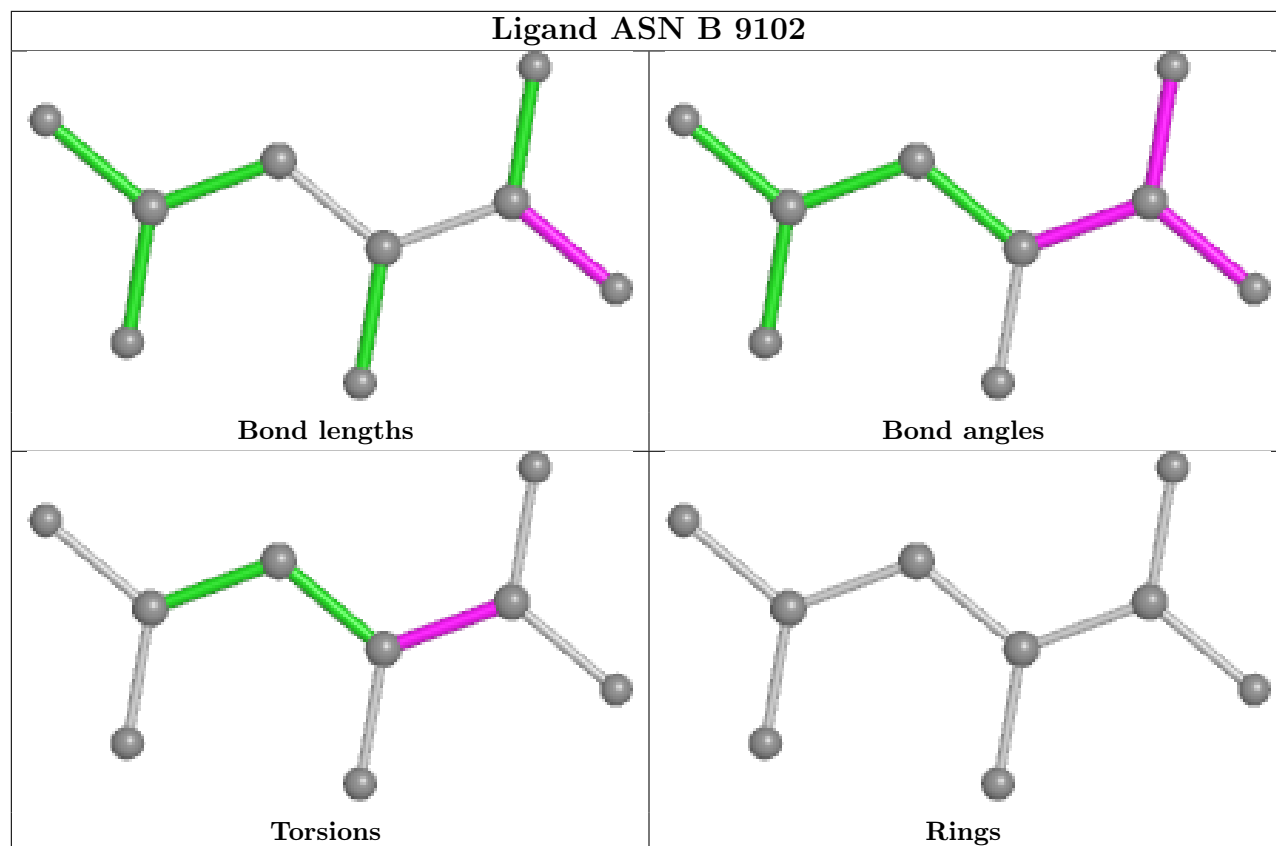

## Ligand CIT D 403

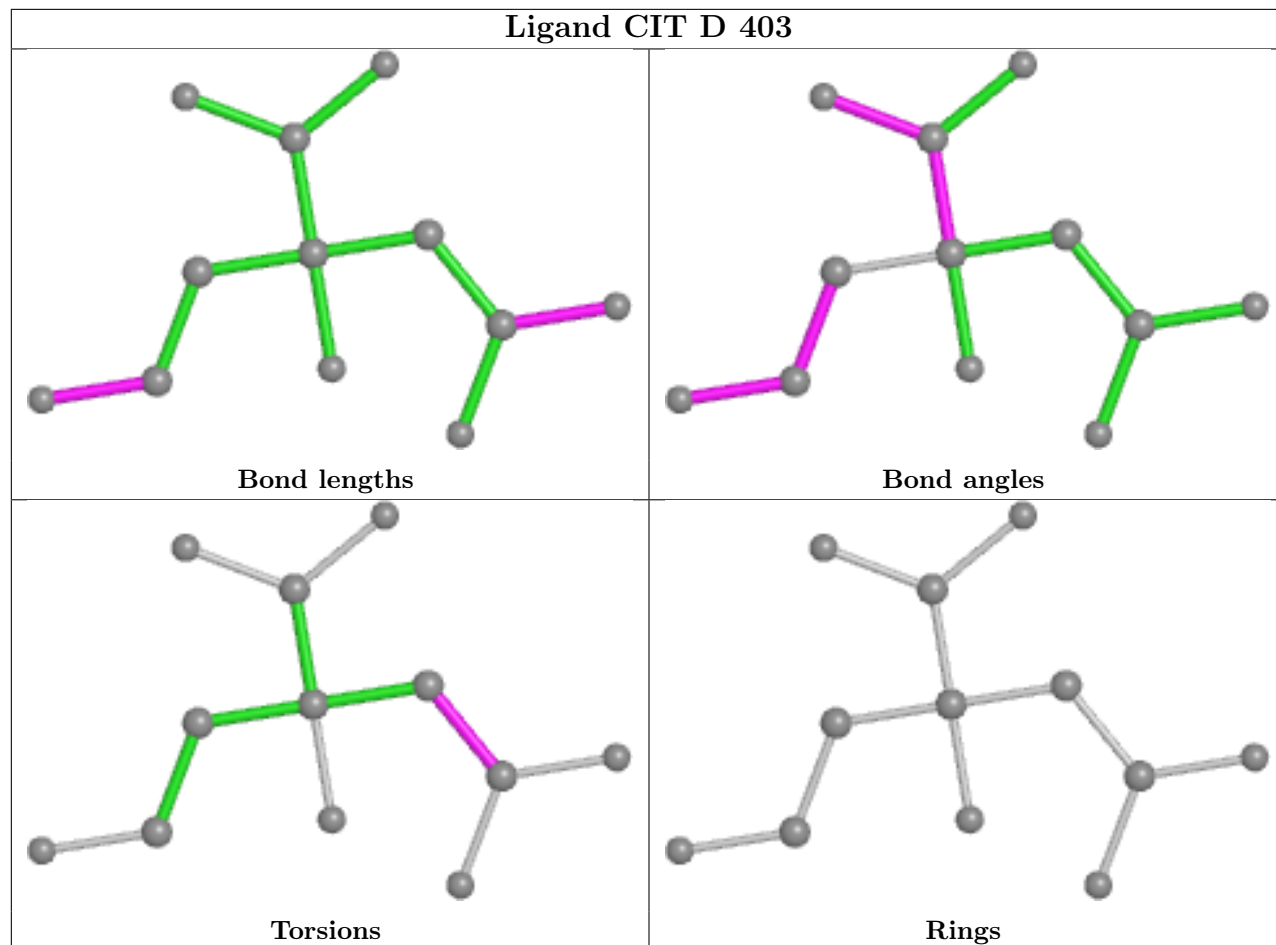

## Ligand ASN A 9109

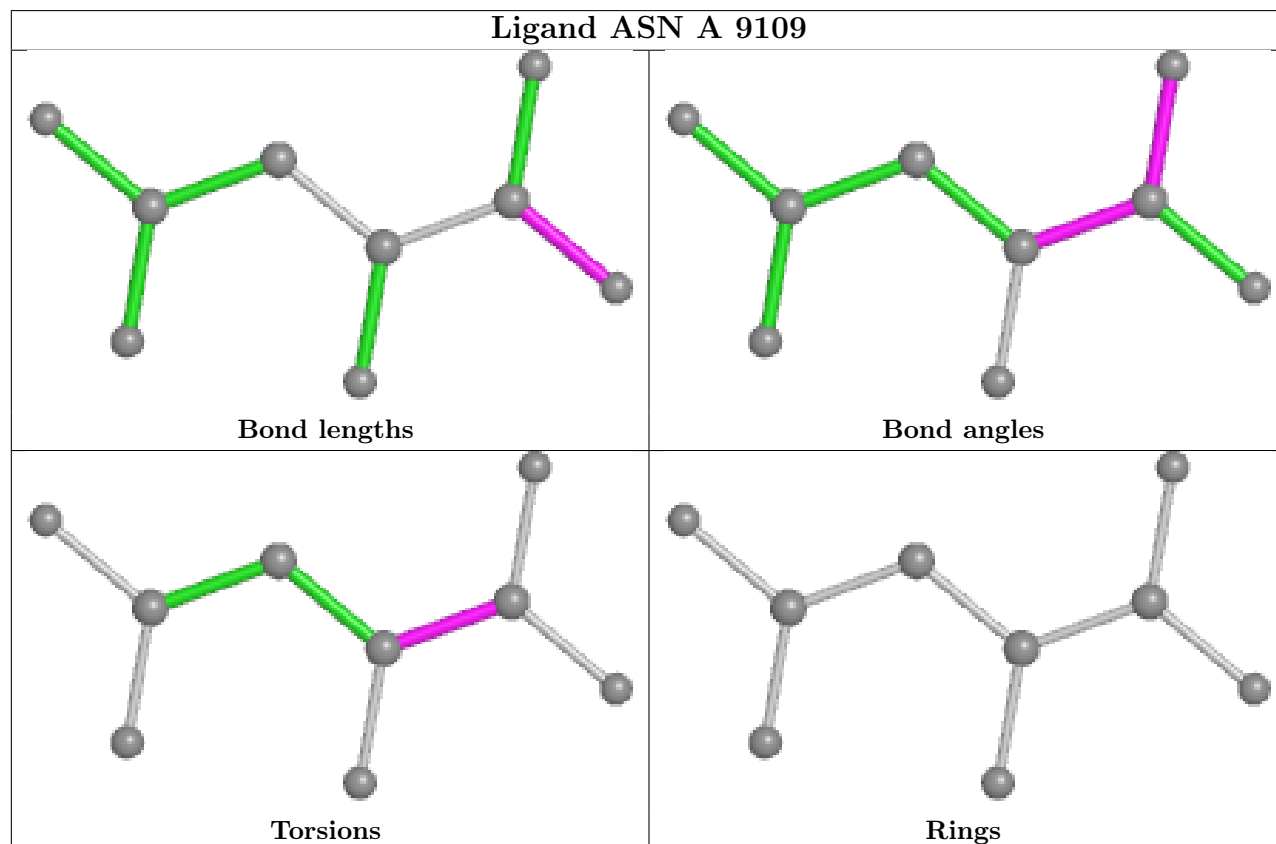

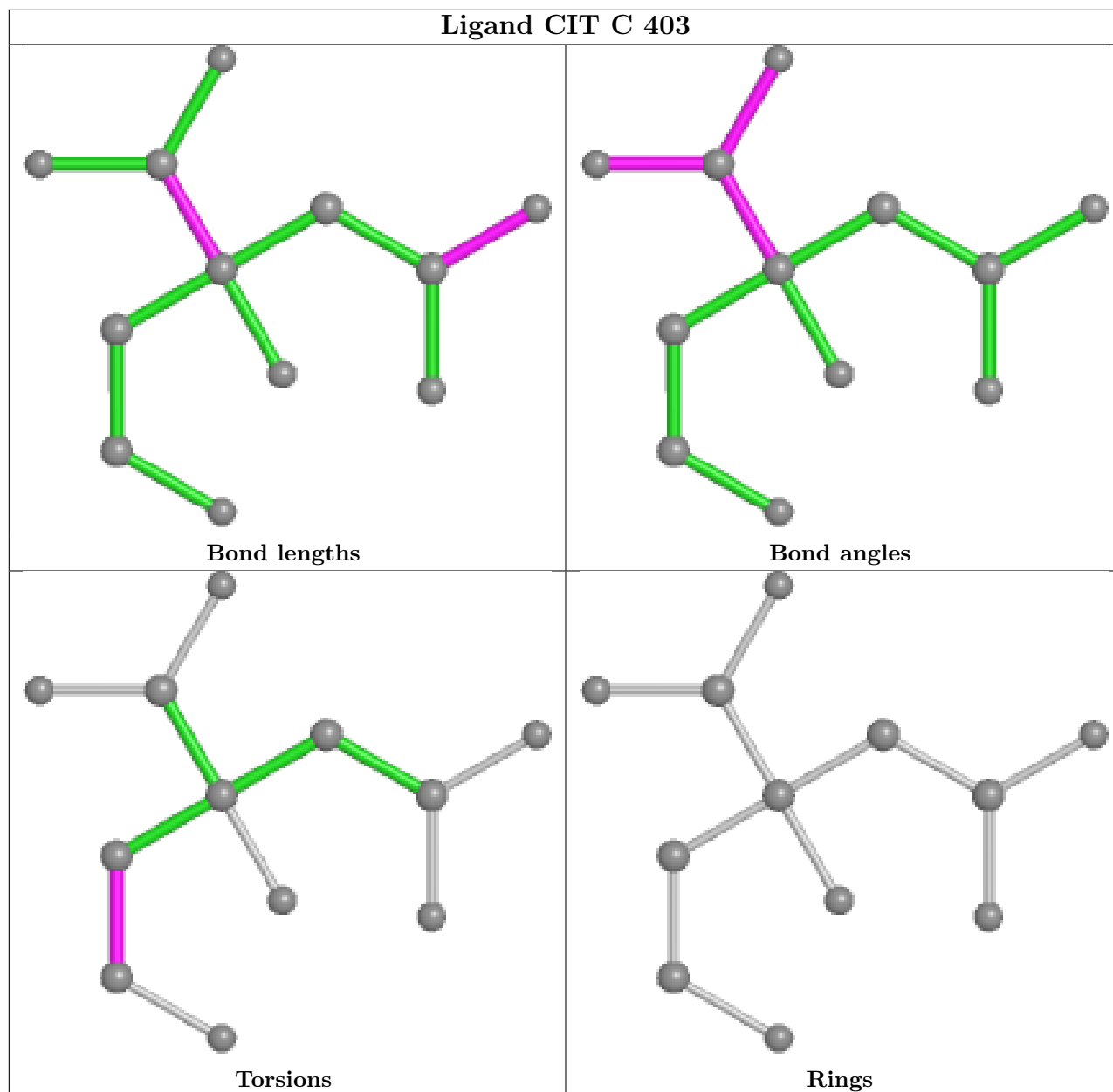

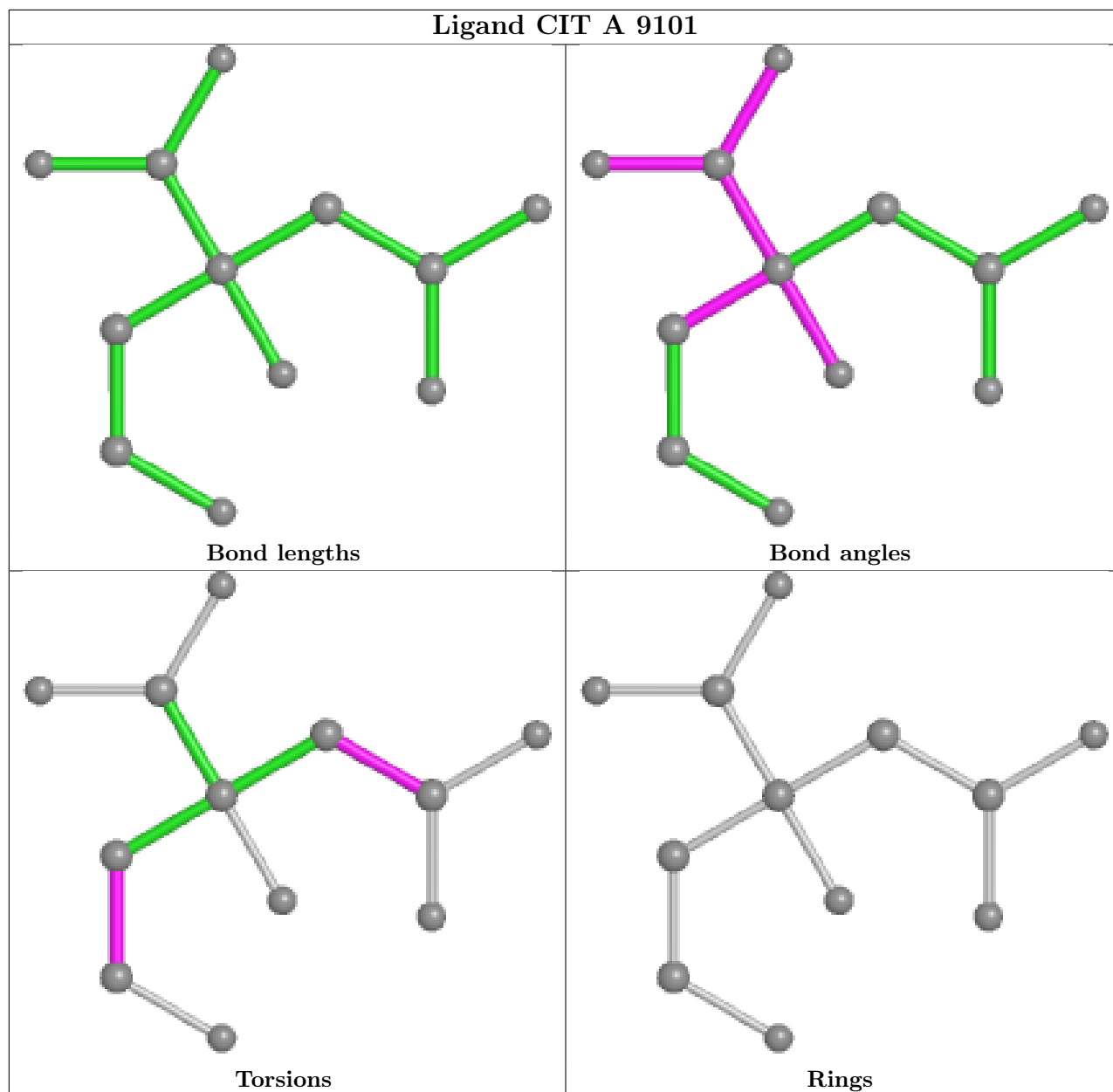

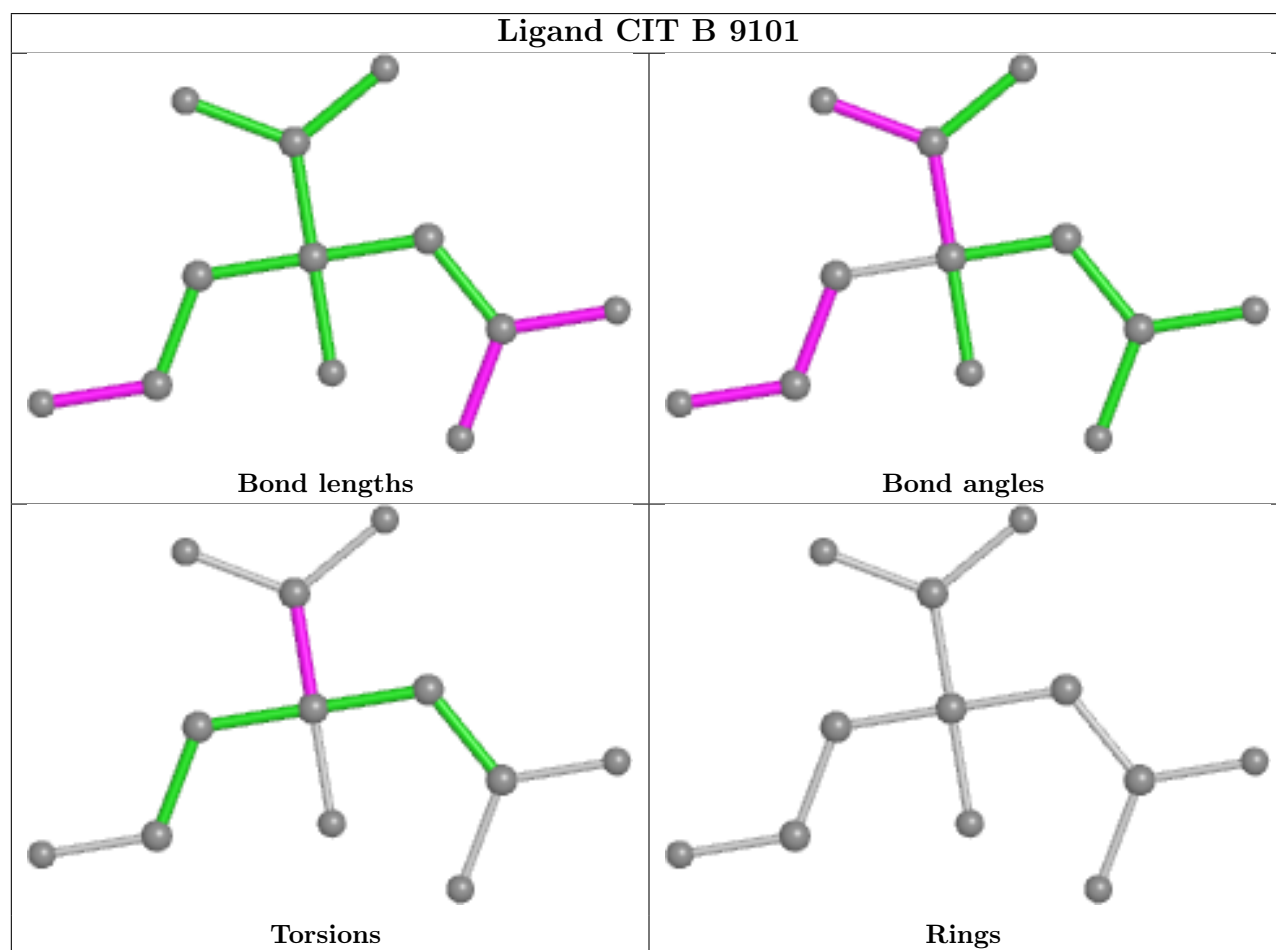
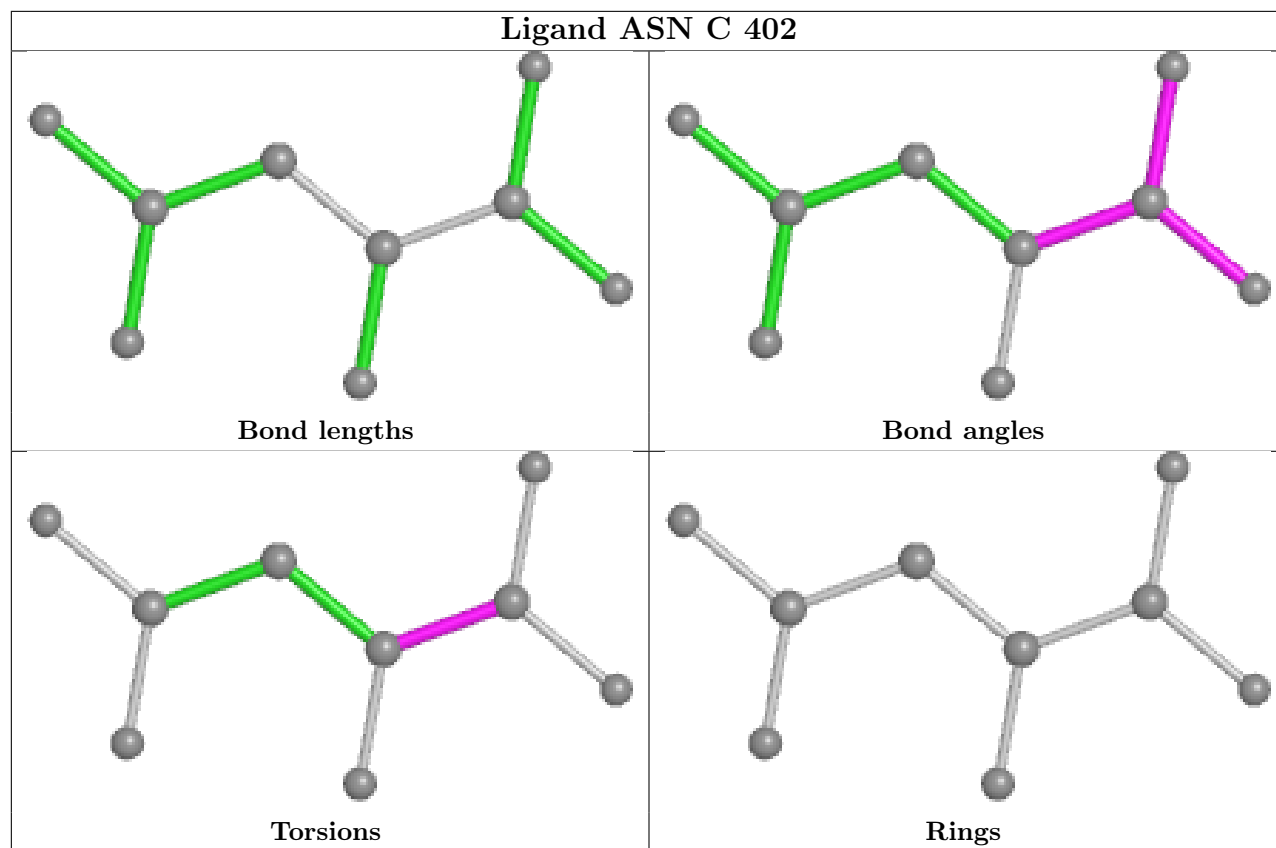

## 5.7 Other polymers [i](#)

There are no such residues in this entry.

## 5.8 Polymer linkage issues [i](#)

There are no chain breaks in this entry.

## 6 Fit of model and data

### 6.1 Protein, DNA and RNA chains

In the following table, the column labelled ‘#RSRZ > 2’ contains the number (and percentage) of RSRZ outliers, followed by percent RSRZ outliers for the chain as percentile scores relative to all X-ray entries and entries of similar resolution. The OWAB column contains the minimum, median, 95<sup>th</sup> percentile and maximum values of the occupancy-weighted average B-factor per residue. The column labelled ‘Q < 0.9’ lists the number of (and percentage) of residues with an average occupancy less than 0.9.

Mol	Chain	Analysed	<RSRZ>	#RSRZ>2	OWAB(Å <sup>2</sup> )	Q<0.9
1	A	326/357 (91%)	0.24	26 (7%) 12 16	14, 24, 54, 80	0
1	B	336/357 (94%)	0.08	23 (6%) 17 21	14, 22, 50, 86	0
1	C	323/357 (90%)	0.29	28 (8%) 10 12	13, 24, 60, 94	0
1	D	334/357 (93%)	-0.06	14 (4%) 36 41	13, 21, 51, 72	0
All	All	1319/1428 (92%)	0.14	91 (6%) 16 21	13, 23, 55, 94	0

All (91) RSRZ outliers are listed below:

Mol	Chain	Res	Type	RSRZ
1	C	39	PRO	8.8
1	B	281	GLY	6.6
1	B	285	THR	5.9
1	A	20	SER	5.8
1	C	26	PRO	5.7
1	A	26	PRO	5.2
1	B	284	ALA	5.2
1	C	286	GLY	4.7
1	C	43	ARG	4.7
1	C	37	LEU	4.7
1	A	229	PHE	4.4
1	A	37	LEU	4.4
1	B	283	TYR	4.4
1	A	231	ARG	4.3
1	C	287	ASN	4.3
1	D	26	PRO	4.2
1	C	30	HIS	4.2
1	A	286	GLY	4.2
1	B	2	GLN	4.1
1	D	-6	LEU	4.1
1	C	291	HIS	4.0

*Continued on next page...*

*Continued from previous page...*

<b>Mol</b>	<b>Chain</b>	<b>Res</b>	<b>Type</b>	<b>RSRZ</b>
1	B	282	GLY	3.9
1	D	122	ALA	3.9
1	A	230	LEU	3.8
1	A	39	PRO	3.8
1	C	31	LEU	3.7
1	A	233	PRO	3.6
1	C	229	PHE	3.5
1	A	226	VAL	3.5
1	C	27	VAL	3.5
1	A	42	HIS	3.5
1	A	227	ARG	3.5
1	A	287	ASN	3.4
1	A	27	VAL	3.4
1	B	225	VAL	3.4
1	A	43	ARG	3.4
1	C	18	GLN	3.4
1	B	122	ALA	3.3
1	C	249	GLN	3.3
1	C	225	VAL	3.3
1	B	14	THR	3.2
1	D	287	ASN	3.2
1	B	232	GLN	3.2
1	C	230	LEU	3.2
1	A	19	ARG	3.1
1	C	227	ARG	3.0
1	D	-1	SER	3.0
1	C	42	HIS	2.9
1	B	286	GLY	2.9
1	B	1	MET	2.9
1	C	44	PRO	2.9
1	A	249	GLN	2.8
1	C	228	ASN	2.8
1	B	233	PRO	2.8
1	A	30	HIS	2.8
1	C	337	ASP	2.7
1	D	280	MET	2.7
1	B	291	HIS	2.7
1	A	31	LEU	2.7
1	D	2	GLN	2.6
1	D	19	ARG	2.6
1	C	33	ARG	2.6
1	C	19	ARG	2.5

*Continued on next page...*



*Continued from previous page...*

Mol	Chain	Res	Type	RSRZ
1	C	28	SER	2.5
1	A	280	MET	2.5
1	D	24	TYR	2.5
1	A	316	GLU	2.5
1	C	45	GLU	2.5
1	A	288	ALA	2.5
1	B	-1	SER	2.4
1	B	-5	VAL	2.4
1	C	288	ALA	2.4
1	D	233	PRO	2.3
1	D	1	MET	2.3
1	B	229	PHE	2.3
1	C	38	MET	2.3
1	B	250	ASN	2.3
1	C	14	THR	2.2
1	A	25	ILE	2.2
1	B	194	PRO	2.2
1	D	25	ILE	2.1
1	D	0	HIS	2.1
1	A	28	SER	2.1
1	B	287	ASN	2.1
1	C	259	GLU	2.1
1	D	-5	VAL	2.1
1	B	-6	LEU	2.1
1	A	33	ARG	2.0
1	B	17	MET	2.0
1	B	30	HIS	2.0
1	A	337	ASP	2.0

## 6.2 Non-standard residues in protein, DNA, RNA chains [i](#)

There are no non-standard protein/DNA/RNA residues in this entry.

## 6.3 Carbohydrates [i](#)

There are no monosaccharides in this entry.

## 6.4 Ligands [i](#)

In the following table, the Atoms column lists the number of modelled atoms in the group and the number defined in the chemical component dictionary. The B-factors column lists the minimum,

median, 95<sup>th</sup> percentile and maximum values of B factors of atoms in the group. The column labelled 'Q< 0.9' lists the number of atoms with occupancy less than 0.9.

Mol	Type	Chain	Res	Atoms	RSCC	RSR	B-factors( $\text{\AA}^2$ )	Q<0.9
3	EDO	A	9107	4/4	0.83	0.16	29,29,35,38	0
3	EDO	B	9105	4/4	0.89	0.14	25,25,32,35	0
3	EDO	A	9102	4/4	0.92	0.11	27,30,32,32	0
3	EDO	C	401	4/4	0.92	0.13	26,37,39,39	0
6	ASN	A	9109	9/9	0.92	0.13	16,22,25,27	0
2	CIT	C	403	12/13	0.93	0.11	17,25,29,34	0
2	CIT	B	9101	12/13	0.93	0.15	19,27,36,36	0
6	ASN	C	402	9/9	0.93	0.11	18,22,28,31	0
6	ASN	D	402	9/9	0.93	0.09	17,20,27,29	0
2	CIT	A	9101	12/13	0.94	0.09	16,24,33,33	0
3	EDO	B	9104	4/4	0.94	0.10	24,26,27,31	0
5	GOL	A	9105	6/6	0.94	0.18	22,35,39,40	0
2	CIT	D	403	12/13	0.95	0.10	19,23,26,33	0
6	ASN	B	9102	9/9	0.95	0.07	18,21,25,28	0
3	EDO	B	9103	4/4	0.95	0.21	31,43,44,45	0
3	EDO	A	9103	4/4	0.95	0.12	22,23,25,26	0
3	EDO	D	407	4/4	0.96	0.08	21,22,26,29	0
3	EDO	C	405	4/4	0.96	0.09	22,23,33,35	0
3	EDO	D	406	4/4	0.96	0.08	26,26,29,30	0
4	CL	D	401	1/1	0.98	0.06	25,25,25,25	0
3	EDO	C	404	4/4	0.98	0.10	22,22,24,27	0
4	CL	A	9104	1/1	0.98	0.06	19,19,19,19	0
4	CL	D	405	1/1	0.99	0.04	29,29,29,29	0
4	CL	A	9108	1/1	0.99	0.06	18,18,18,18	0
4	CL	B	9106	1/1	0.99	0.04	22,22,22,22	0
4	CL	C	406	1/1	0.99	0.03	26,26,26,26	0
4	CL	A	9106	1/1	0.99	0.04	25,25,25,25	0
4	CL	D	404	1/1	0.99	0.03	21,21,21,21	0
4	CL	B	9108	1/1	1.00	0.04	19,19,19,19	0
4	CL	B	9107	1/1	1.00	0.04	18,18,18,18	0

The following is a graphical depiction of the model fit to experimental electron density of all instances of the Ligand of Interest. In addition, ligands with molecular weight > 250 and outliers as shown on the geometry validation Tables will also be included. Each fit is shown from different orientation to approximate a three-dimensional view.

**Electron density around ASN A 9109:**

$2mF_o-DF_c$  (at 0.7 rmsd) in gray  
 $mF_o-DF_c$  (at 3 rmsd) in purple (negative)  
and green (positive)

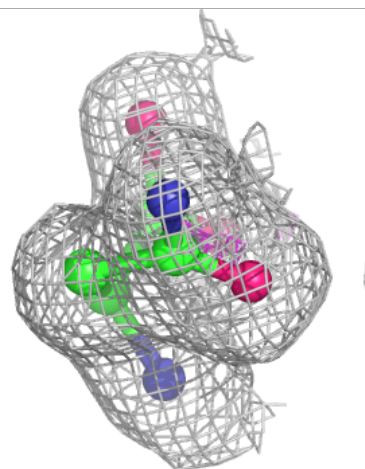
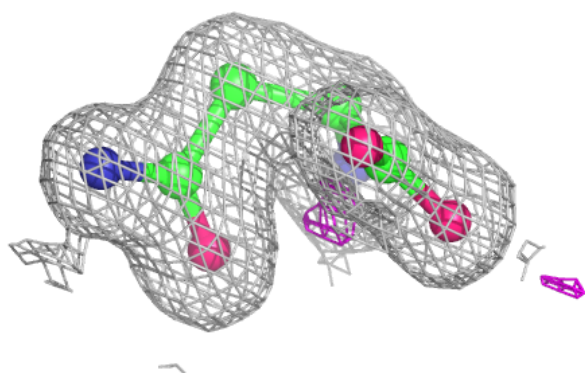
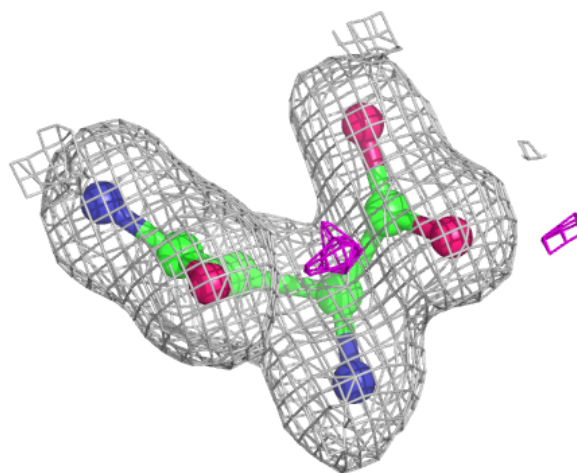

**Electron density around CIT C 403:**

$2mF_o-DF_c$  (at 0.7 rmsd) in gray  
 $mF_o-DF_c$  (at 3 rmsd) in purple (negative)  
and green (positive)

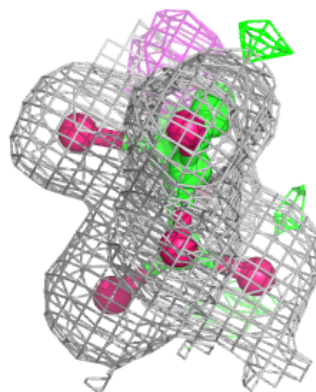
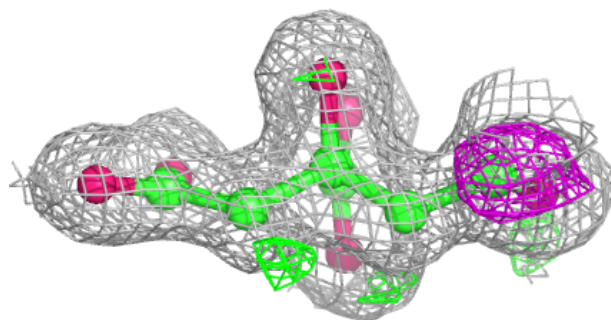
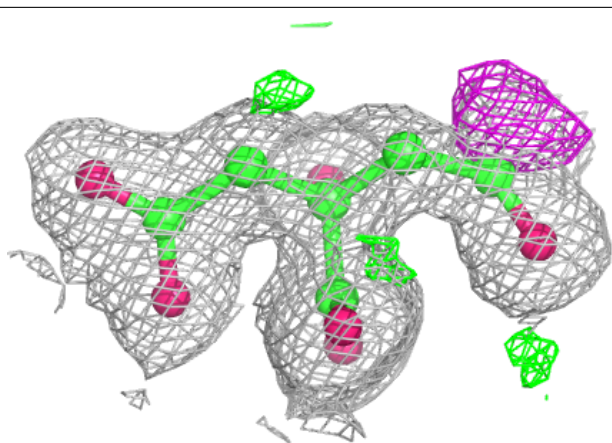
**Electron density around CIT B 9101:**

$2mF_o-DF_c$  (at 0.7 rmsd) in gray  
 $mF_o-DF_c$  (at 3 rmsd) in purple (negative)  
and green (positive)

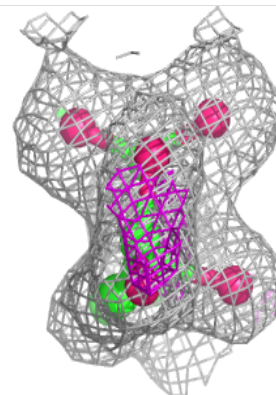
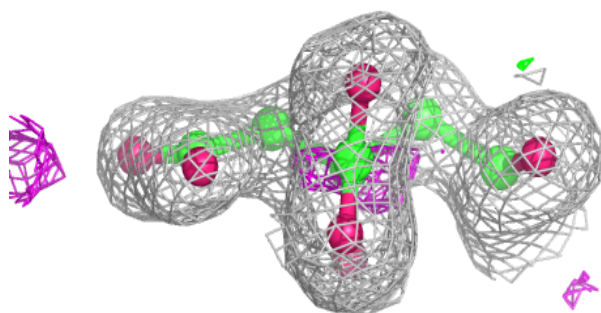
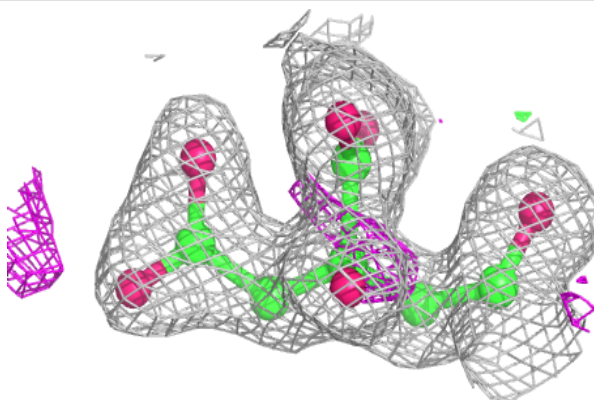

**Electron density around ASN C 402:**

$2mF_o-DF_c$  (at 0.7 rmsd) in gray  
 $mF_o-DF_c$  (at 3 rmsd) in purple (negative)  
and green (positive)

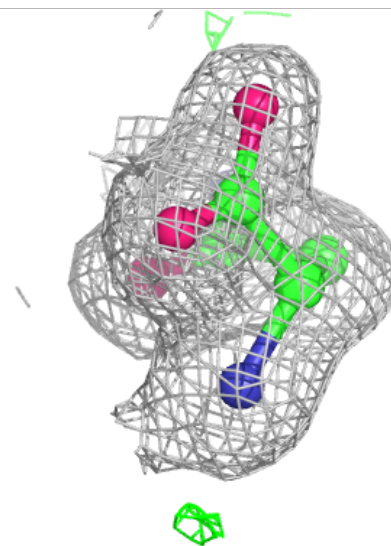
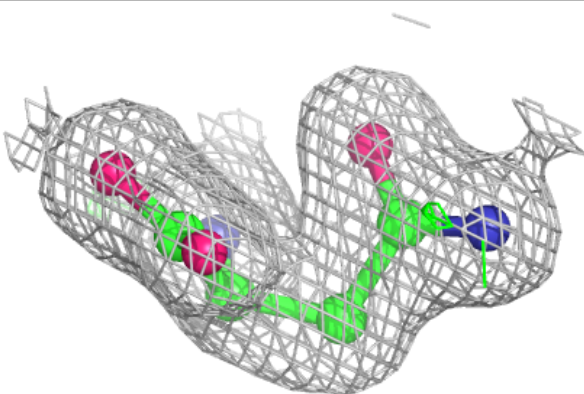
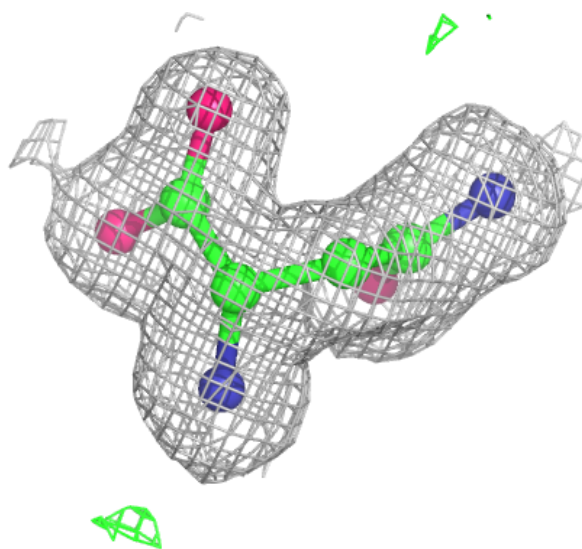

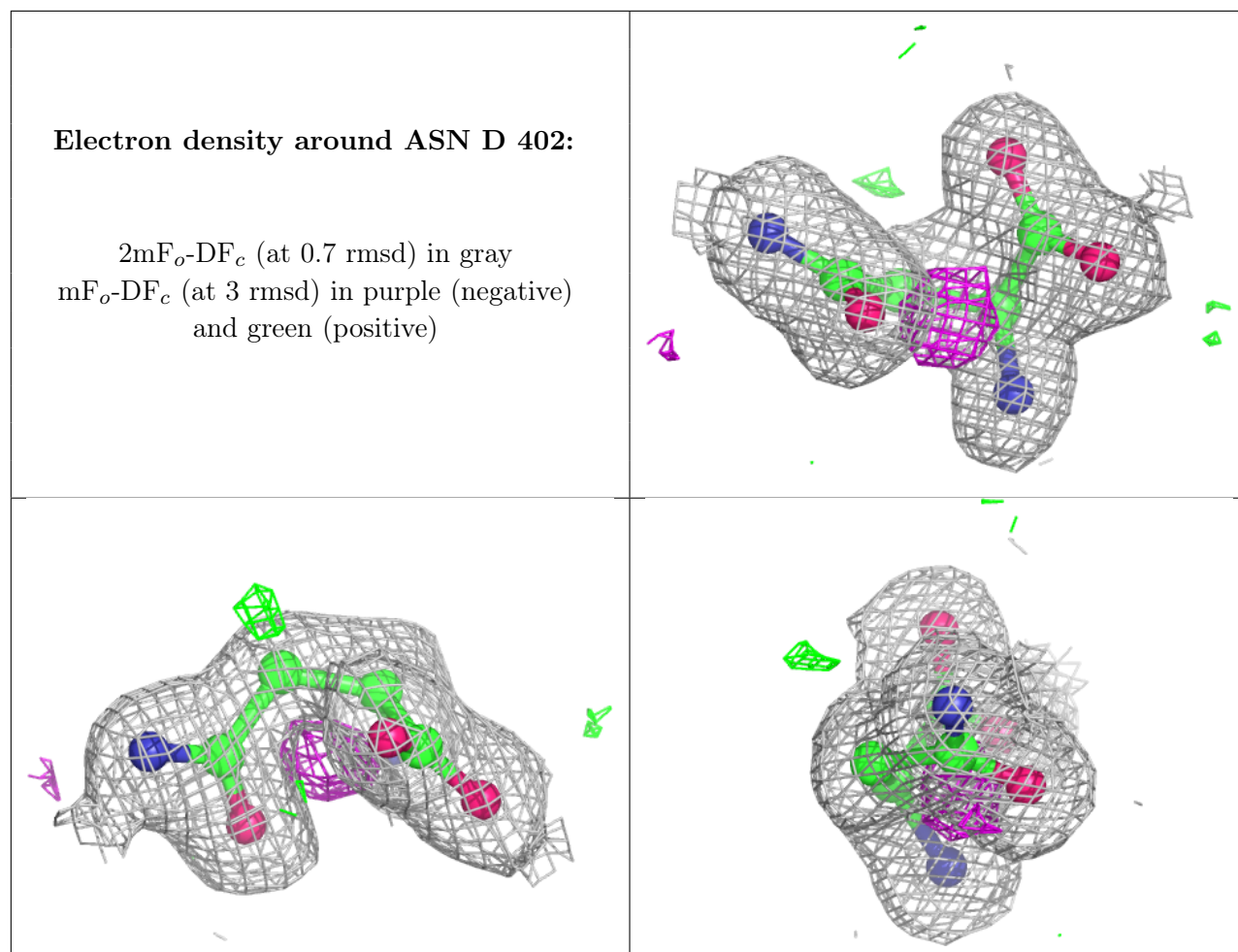

**Electron density around CIT A 9101:**

$2mF_o-DF_c$  (at 0.7 rmsd) in gray  
 $mF_o-DF_c$  (at 3 rmsd) in purple (negative)  
and green (positive)

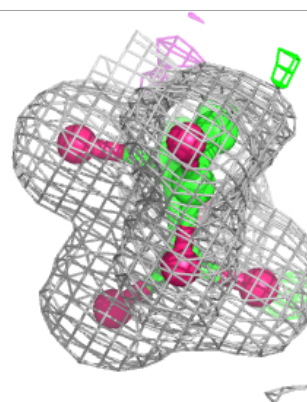
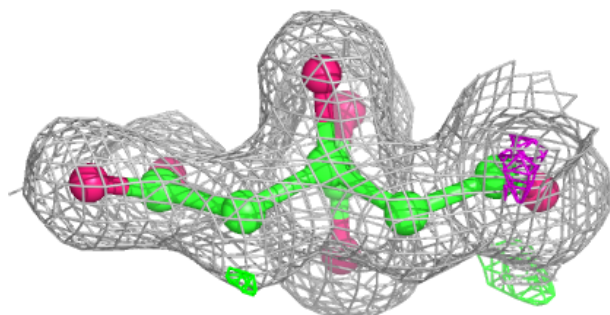
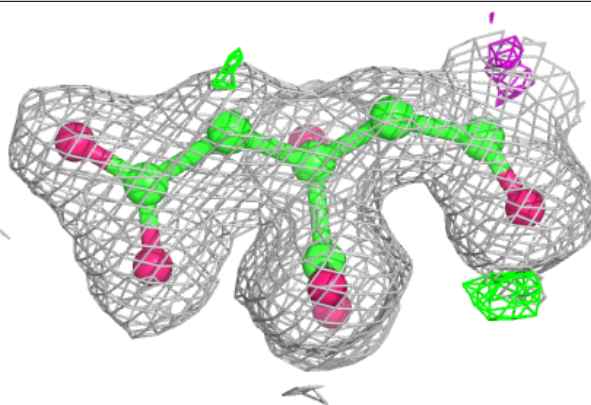
**Electron density around CIT D 403:**

$2mF_o-DF_c$  (at 0.7 rmsd) in gray  
 $mF_o-DF_c$  (at 3 rmsd) in purple (negative)  
and green (positive)

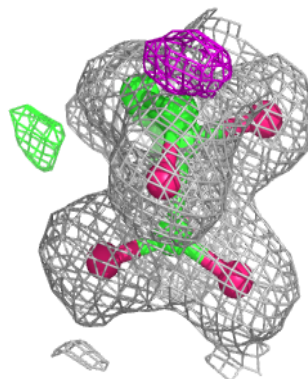
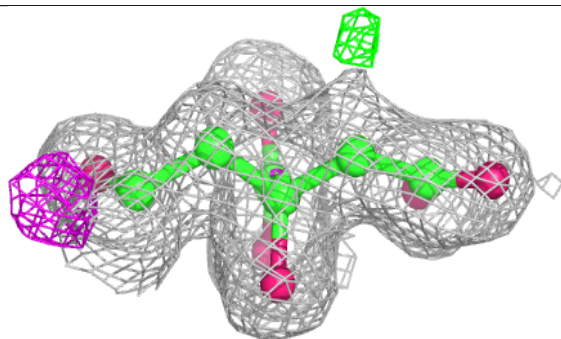
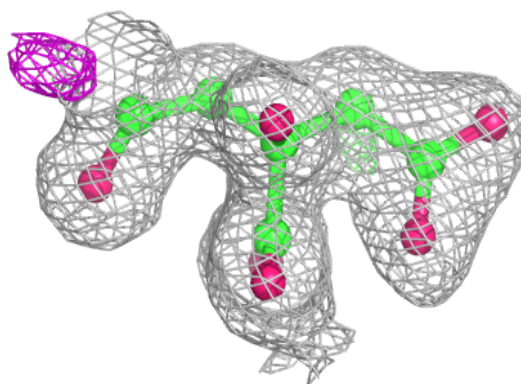

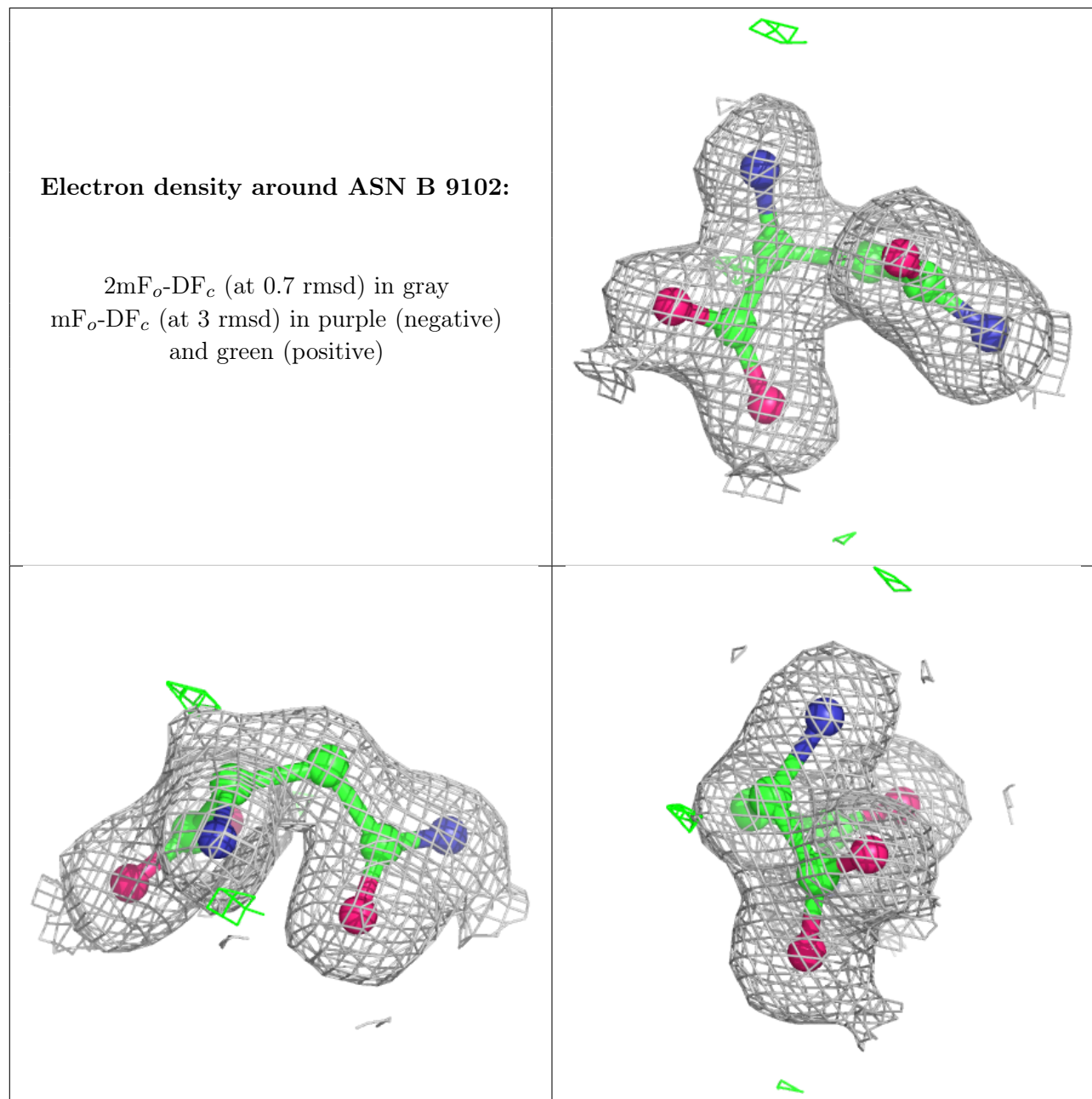

## 6.5 Other polymers [i](#)

There are no such residues in this entry.