



## wwPDB EM Validation Summary Report ⓘ

Mar 9, 2024 – 02:41 PM EST

PDB ID : 6O2T  
EMDB ID : EMD-0615  
Title : Acetylated Microtubules  
Authors : Eshun-Wilson, L.; Zhang, R.; Portran, D.; Nachury, M.V.; Toso, D.; Lohr, T.; Vendruscolo, M.; Bonomi, M.; Fraser, J.S.; Nogales, E.  
Deposited on : 2019-02-24  
Resolution : 4.10 Å(reported)  
Based on initial model : 3JAR

This is a wwPDB EM Validation Summary Report for a publicly released PDB entry.

We welcome your comments at [validation@mail.wwpdb.org](mailto:validation@mail.wwpdb.org)

A user guide is available at

<https://www.wwpdb.org/validation/2017/EMValidationReportHelp>

with specific help available everywhere you see the ⓘ symbol.

The types of validation reports are described at

<http://www.wwpdb.org/validation/2017/FAQs#types>.

---

The following versions of software and data (see [references ⓘ](#)) were used in the production of this report:

EMDB validation analysis : 0.0.1.dev70  
Mogul : 1.8.5 (274361), CSD as541be (2020)  
MolProbity : 4.02b-467  
buster-report : 1.1.7 (2018)  
Percentile statistics : 20191225.v01 (using entries in the PDB archive December 25th 2019)  
MapQ : 1.9.13  
Ideal geometry (proteins) : Engh & Huber (2001)  
Ideal geometry (DNA, RNA) : Parkinson et al. (1996)  
Validation Pipeline (wwPDB-VP) : 2.36

# 1 Overall quality at a glance

The following experimental techniques were used to determine the structure:

*ELECTRON MICROSCOPY*

The reported resolution of this entry is 4.10 Å.

Percentile scores (ranging between 0-100) for global validation metrics of the entry are shown in the following graphic. The table shows the number of entries on which the scores are based.

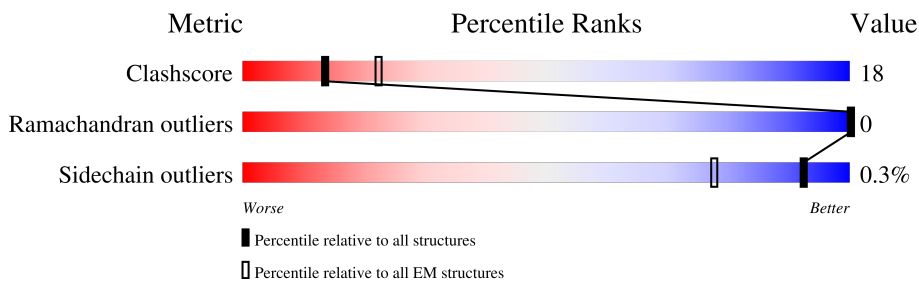

Metric	Whole archive (#Entries)	EM structures (#Entries)
Clashscore	158937	4297
Ramachandran outliers	154571	4023
Sidechain outliers	154315	3826

The table below summarises the geometric issues observed across the polymeric chains and their fit to the map. The red, orange, yellow and green segments of the bar indicate the fraction of residues that contain outliers for  $\geq 3$ , 2, 1 and 0 types of geometric quality criteria respectively. A grey segment represents the fraction of residues that are not modelled. The numeric value for each fraction is indicated below the corresponding segment, with a dot representing fractions  $\leq 5\%$ . The upper red bar (where present) indicates the fraction of residues that have poor fit to the EM map (all-atom inclusion  $< 40\%$ ). The numeric value is given above the bar.

Mol	Chain	Length	Quality of chain
1	1A	451	21% 71% 26% .
1	1B	451	21% 71% 26% .
1	1C	451	23% 70% 27% .
1	1D	451	28% 69% 27% .
1	1E	451	31% 70% 27% .
1	1F	451	31% 69% 28% .
1	1G	451	35% 69% 28% .
1	1I	451	43% 71% 26% .

Continued on next page...

Continued from previous page...

Mol	Chain	Length	Quality of chain
1	1J	451	45% 71% 25%
1	1K	451	49% 72% 25%
1	1L	451	53% 72% 25%
1	1M	451	89% 73% 24%
1	1N	451	22% 73% 24%
1	2A	451	28% 73% 24%
1	2B	451	23% 75% 22%
1	2C	451	21% 74% 23%
1	2D	451	26% 73% 24%
1	2E	451	23% 74% 23%
1	2F	451	24% 73% 24%
1	2G	451	25% 73% 24%
1	2I	451	26% 75% 22%
1	2J	451	26% 73% 24%
1	2K	451	25% 74% 23%
1	2L	451	25% 73% 24%
1	2M	451	35% 74% 23%
1	2N	451	40% 73% 24%
1	3A	451	48% 71% 26%
1	3B	451	51% 72% 25%
1	3C	451	41% 72% 25%
1	3D	451	41% 71% 26%
1	3E	451	34% 72% 25%
1	3F	451	38% 71% 26%
1	3G	451	36% 71% 26%

Continued on next page...

Continued from previous page...

Mol	Chain	Length	Quality of chain
1	3I	451	40% 72% 25%
1	3J	451	35% 73% 24%
1	3K	451	36% 73% 24%
1	3L	451	34% 73% 24%
1	3M	451	41% 73% 24%
1	3N	451	62% 73% 24%
1	4A	451	53% 77% 20%
1	4B	451	50% 78% 19%
1	4C	451	49% 78% 19%
1	4D	451	51% 77% 20%
1	4E	451	51% 78% 19%
1	4F	451	51% 77% 20%
1	4G	451	49% 77% 20%
1	4I	451	51% 79% 18%
1	4J	451	53% 78% 19%
1	4K	451	59% 78% 19%
1	4L	451	85% 78% 18%
1	4M	451	95% 79% 18%
1	4N	451	59% 79% 18%
2	1H	445	20% 71% 26%
2	1O	445	21% 71% 25%
2	1P	445	22% 70% 27%
2	1Q	445	25% 70% 26%
2	1R	445	31% 71% 25%
2	1S	445	36% 71% 26%

Continued on next page...

Continued from previous page...

Mol	Chain	Length	Quality of chain
2	1T	445	41% 71% 26%
2	1U	445	43% 71% 25%
2	1V	445	44% 71% 26%
2	1W	445	49% 71% 26%
2	1X	445	52% 71% 26%
2	1Y	445	67% 70% 26%
2	1Z	445	20% 71% 26%
2	2H	445	33% 70% 27%
2	2O	445	27% 69% 27%
2	2P	445	24% 69% 28%
2	2Q	445	29% 68% 28%
2	2R	445	27% 69% 28%
2	2S	445	26% 69% 28%
2	2T	445	24% 69% 27%
2	2U	445	24% 69% 27%
2	2V	445	28% 69% 27%
2	2W	445	29% 69% 27%
2	2X	445	30% 69% 27%
2	2Y	445	35% 69% 27%
2	2Z	445	44% 70% 27%
2	3H	445	84% 74% 22%
2	3O	445	77% 74% 22%
2	3P	445	68% 74% 23%
2	3Q	445	59% 74% 22%
2	3R	445	50% 75% 22%

Continued on next page...

Continued from previous page...

Mol	Chain	Length	Quality of chain	
2	3S	445	43%	74% 23%
2	3T	445	41%	74% 22%
2	3U	445	39%	74% 22%
2	3V	445	33%	74% 22%
2	3W	445	36%	75% 22%
2	3X	445	38%	75% 22%
2	3Y	445	45%	74% 23%
2	3Z	445	91%	75% 22%
2	4H	445	34%	68% 28%
2	4O	445	36%	68% 29%
2	4P	445	36%	67% 29%
2	4Q	445	39%	67% 30%
2	4R	445	36%	67% 29%
2	4S	445	36%	67% 29%
2	4T	445	36%	68% 28%
2	4U	445	34%	67% 29%
2	4V	445	34%	69% 27%
2	4W	445	36%	69% 27%
2	4X	445	57%	69% 27%
2	4Y	445	92%	69% 28%
2	4Z	445	37%	70% 27%

The following table lists non-polymeric compounds, carbohydrate monomers and non-standard residues in protein, DNA, RNA chains that are outliers for geometric or electron-density-fit criteria:

Mol	Type	Chain	Res	Chirality	Geometry	Clashes	Electron density
5	GDP	4O	501	-	-	X	-
5	GDP	4P	501	-	-	X	-

Continued on next page...

*Continued from previous page...*

<b>Mol</b>	<b>Type</b>	<b>Chain</b>	<b>Res</b>	<b>Chirality</b>	<b>Geometry</b>	<b>Clashes</b>	<b>Electron density</b>
5	GDP	4Q	501	-	-	X	-
5	GDP	4R	501	-	-	X	-

## 2 Entry composition [i](#)

There are 5 unique types of molecules in this entry. The entry contains 355888 atoms, of which 0 are hydrogens and 0 are deuteriums.

In the tables below, the AltConf column contains the number of residues with at least one atom in alternate conformation and the Trace column contains the number of residues modelled with at most 2 atoms.

- Molecule 1 is a protein called Tubulin alpha-1B chain.

Mol	Chain	Residues	Atoms					AltConf	Trace
			Total	C	N	O	S		
1	1A	437	Total 3415	C 2160	N 580	O 654	S 21	0	0
1	1B	437	Total 3415	C 2160	N 580	O 654	S 21	0	0
1	1C	437	Total 3415	C 2160	N 580	O 654	S 21	0	0
1	1D	437	Total 3415	C 2160	N 580	O 654	S 21	0	0
1	1E	437	Total 3415	C 2160	N 580	O 654	S 21	0	0
1	1F	437	Total 3415	C 2160	N 580	O 654	S 21	0	0
1	1G	437	Total 3415	C 2160	N 580	O 654	S 21	0	0
1	1I	437	Total 3415	C 2160	N 580	O 654	S 21	0	0
1	1J	437	Total 3415	C 2160	N 580	O 654	S 21	0	0
1	1K	437	Total 3415	C 2160	N 580	O 654	S 21	0	0
1	1L	437	Total 3415	C 2160	N 580	O 654	S 21	0	0
1	1M	437	Total 3415	C 2160	N 580	O 654	S 21	0	0
1	1N	437	Total 3415	C 2160	N 580	O 654	S 21	0	0
1	2A	437	Total 3415	C 2160	N 580	O 654	S 21	0	0
1	2B	437	Total 3415	C 2160	N 580	O 654	S 21	0	0
1	2C	437	Total 3415	C 2160	N 580	O 654	S 21	0	0
1	2D	437	Total 3415	C 2160	N 580	O 654	S 21	0	0

*Continued on next page...*



*Continued from previous page...*

Mol	Chain	Residues	Atoms					AltConf	Trace
1	2E	437	Total 3415	C 2160	N 580	O 654	S 21	0	0
1	2F	437	Total 3415	C 2160	N 580	O 654	S 21	0	0
1	2G	437	Total 3415	C 2160	N 580	O 654	S 21	0	0
1	2I	437	Total 3415	C 2160	N 580	O 654	S 21	0	0
1	2J	437	Total 3415	C 2160	N 580	O 654	S 21	0	0
1	2K	437	Total 3415	C 2160	N 580	O 654	S 21	0	0
1	2L	437	Total 3415	C 2160	N 580	O 654	S 21	0	0
1	2M	437	Total 3415	C 2160	N 580	O 654	S 21	0	0
1	2N	437	Total 3415	C 2160	N 580	O 654	S 21	0	0
1	3A	437	Total 3415	C 2160	N 580	O 654	S 21	0	0
1	3B	437	Total 3415	C 2160	N 580	O 654	S 21	0	0
1	3C	437	Total 3415	C 2160	N 580	O 654	S 21	0	0
1	3D	437	Total 3415	C 2160	N 580	O 654	S 21	0	0
1	3E	437	Total 3415	C 2160	N 580	O 654	S 21	0	0
1	3F	437	Total 3415	C 2160	N 580	O 654	S 21	0	0
1	3G	437	Total 3415	C 2160	N 580	O 654	S 21	0	0
1	3I	437	Total 3415	C 2160	N 580	O 654	S 21	0	0
1	3J	437	Total 3415	C 2160	N 580	O 654	S 21	0	0
1	3K	437	Total 3415	C 2160	N 580	O 654	S 21	0	0
1	3L	437	Total 3415	C 2160	N 580	O 654	S 21	0	0
1	3M	437	Total 3415	C 2160	N 580	O 654	S 21	0	0

*Continued on next page...*

*Continued from previous page...*

Mol	Chain	Residues	Atoms					AltConf	Trace
1	3N	437	Total	C	N	O	S	0	0
			3415	2160	580	654	21		
1	4A	437	Total	C	N	O	S	0	0
			3415	2160	580	654	21		
1	4B	437	Total	C	N	O	S	0	0
			3415	2160	580	654	21		
1	4C	437	Total	C	N	O	S	0	0
			3415	2160	580	654	21		
1	4D	437	Total	C	N	O	S	0	0
			3415	2160	580	654	21		
1	4E	437	Total	C	N	O	S	0	0
			3415	2160	580	654	21		
1	4F	437	Total	C	N	O	S	0	0
			3415	2160	580	654	21		
1	4G	437	Total	C	N	O	S	0	0
			3415	2160	580	654	21		
1	4I	437	Total	C	N	O	S	0	0
			3415	2160	580	654	21		
1	4J	437	Total	C	N	O	S	0	0
			3415	2160	580	654	21		
1	4K	437	Total	C	N	O	S	0	0
			3415	2160	580	654	21		
1	4L	437	Total	C	N	O	S	0	0
			3415	2160	580	654	21		
1	4M	437	Total	C	N	O	S	0	0
			3415	2160	580	654	21		
1	4N	437	Total	C	N	O	S	0	0
			3415	2160	580	654	21		

- Molecule 2 is a protein called Tubulin beta chain.

Mol	Chain	Residues	Atoms					AltConf	Trace
2	1H	429	Total	C	N	O	S	0	0
			3368	2115	578	650	25		
2	1O	429	Total	C	N	O	S	0	0
			3368	2115	578	650	25		
2	1P	429	Total	C	N	O	S	0	0
			3368	2115	578	650	25		
2	1Q	429	Total	C	N	O	S	0	0
			3368	2115	578	650	25		
2	1R	429	Total	C	N	O	S	0	0
			3368	2115	578	650	25		

*Continued on next page...*

*Continued from previous page...*

Mol	Chain	Residues	Atoms					AltConf	Trace
			Total	C	N	O	S		
2	1S	429	Total 3368	C 2115	N 578	O 650	S 25	0	0
2	1T	429	Total 3368	C 2115	N 578	O 650	S 25	0	0
2	1U	429	Total 3368	C 2115	N 578	O 650	S 25	0	0
2	1V	429	Total 3368	C 2115	N 578	O 650	S 25	0	0
2	1W	429	Total 3368	C 2115	N 578	O 650	S 25	0	0
2	1X	429	Total 3368	C 2115	N 578	O 650	S 25	0	0
2	1Y	429	Total 3368	C 2115	N 578	O 650	S 25	0	0
2	1Z	429	Total 3368	C 2115	N 578	O 650	S 25	0	0
2	2H	429	Total 3368	C 2115	N 578	O 650	S 25	0	0
2	2O	429	Total 3368	C 2115	N 578	O 650	S 25	0	0
2	2P	429	Total 3368	C 2115	N 578	O 650	S 25	0	0
2	2Q	429	Total 3368	C 2115	N 578	O 650	S 25	0	0
2	2R	429	Total 3368	C 2115	N 578	O 650	S 25	0	0
2	2S	429	Total 3368	C 2115	N 578	O 650	S 25	0	0
2	2T	429	Total 3368	C 2115	N 578	O 650	S 25	0	0
2	2U	429	Total 3368	C 2115	N 578	O 650	S 25	0	0
2	2V	429	Total 3368	C 2115	N 578	O 650	S 25	0	0
2	2W	429	Total 3368	C 2115	N 578	O 650	S 25	0	0
2	2X	429	Total 3368	C 2115	N 578	O 650	S 25	0	0
2	2Y	429	Total 3368	C 2115	N 578	O 650	S 25	0	0
2	2Z	429	Total 3368	C 2115	N 578	O 650	S 25	0	0

*Continued on next page...*

*Continued from previous page...*

Mol	Chain	Residues	Atoms					AltConf	Trace
			Total	C	N	O	S		
2	3H	429	Total 3368	C 2115	N 578	O 650	S 25	0	0
2	3O	429	Total 3368	C 2115	N 578	O 650	S 25	0	0
2	3P	429	Total 3368	C 2115	N 578	O 650	S 25	0	0
2	3Q	429	Total 3368	C 2115	N 578	O 650	S 25	0	0
2	3R	429	Total 3368	C 2115	N 578	O 650	S 25	0	0
2	3S	429	Total 3368	C 2115	N 578	O 650	S 25	0	0
2	3T	429	Total 3368	C 2115	N 578	O 650	S 25	0	0
2	3U	429	Total 3368	C 2115	N 578	O 650	S 25	0	0
2	3V	429	Total 3368	C 2115	N 578	O 650	S 25	0	0
2	3W	429	Total 3368	C 2115	N 578	O 650	S 25	0	0
2	3X	429	Total 3368	C 2115	N 578	O 650	S 25	0	0
2	3Y	429	Total 3368	C 2115	N 578	O 650	S 25	0	0
2	3Z	429	Total 3368	C 2115	N 578	O 650	S 25	0	0
2	4H	429	Total 3368	C 2115	N 578	O 650	S 25	0	0
2	4O	429	Total 3368	C 2115	N 578	O 650	S 25	0	0
2	4P	429	Total 3368	C 2115	N 578	O 650	S 25	0	0
2	4Q	429	Total 3368	C 2115	N 578	O 650	S 25	0	0
2	4R	429	Total 3368	C 2115	N 578	O 650	S 25	0	0
2	4S	429	Total 3368	C 2115	N 578	O 650	S 25	0	0
2	4T	429	Total 3368	C 2115	N 578	O 650	S 25	0	0
2	4U	429	Total 3368	C 2115	N 578	O 650	S 25	0	0

*Continued on next page...*

Continued from previous page...

Mol	Chain	Residues	Atoms					AltConf	Trace
2	4V	429	Total	C	N	O	S	0	0
			3368	2115	578	650	25		
2	4W	429	Total	C	N	O	S	0	0
			3368	2115	578	650	25		
2	4X	429	Total	C	N	O	S	0	0
			3368	2115	578	650	25		
2	4Y	429	Total	C	N	O	S	0	0
			3368	2115	578	650	25		
2	4Z	429	Total	C	N	O	S	0	0
			3368	2115	578	650	25		

- Molecule 3 is GUANOSINE-5'-TRIPHOSPHATE (three-letter code: GTP) (formula:  $C_{10}H_{16}N_5O_{14}P_3$ ).

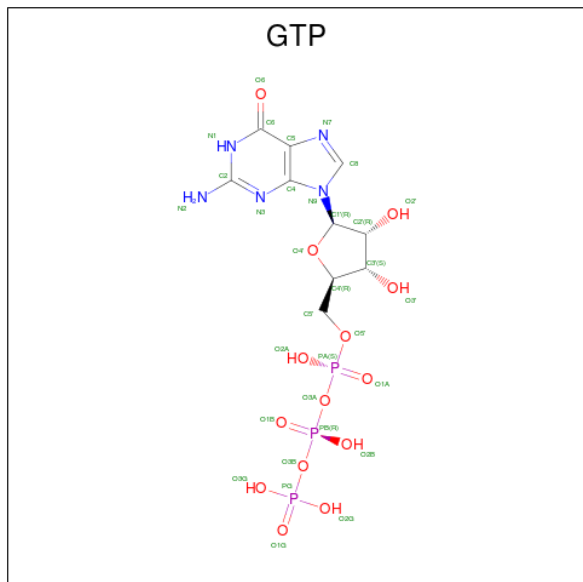

Mol	Chain	Residues	Atoms					AltConf
3	1A	1	Total	C	N	O	P	0
			32	10	5	14	3	
3	1B	1	Total	C	N	O	P	0
			32	10	5	14	3	
3	1C	1	Total	C	N	O	P	0
			32	10	5	14	3	
3	1D	1	Total	C	N	O	P	0
			32	10	5	14	3	
3	1E	1	Total	C	N	O	P	0
			32	10	5	14	3	
3	1F	1	Total	C	N	O	P	0
			32	10	5	14	3	

Continued on next page...

*Continued from previous page...*

Mol	Chain	Residues	Atoms					AltConf
			Total	C	N	O	P	
3	1G	1	Total 32	C 10	N 5	O 14	P 3	0
3	1I	1	Total 32	C 10	N 5	O 14	P 3	0
3	1J	1	Total 32	C 10	N 5	O 14	P 3	0
3	1K	1	Total 32	C 10	N 5	O 14	P 3	0
3	1L	1	Total 32	C 10	N 5	O 14	P 3	0
3	1M	1	Total 32	C 10	N 5	O 14	P 3	0
3	1N	1	Total 32	C 10	N 5	O 14	P 3	0
3	2A	1	Total 32	C 10	N 5	O 14	P 3	0
3	2B	1	Total 32	C 10	N 5	O 14	P 3	0
3	2C	1	Total 32	C 10	N 5	O 14	P 3	0
3	2D	1	Total 32	C 10	N 5	O 14	P 3	0
3	2E	1	Total 32	C 10	N 5	O 14	P 3	0
3	2F	1	Total 32	C 10	N 5	O 14	P 3	0
3	2G	1	Total 32	C 10	N 5	O 14	P 3	0
3	2I	1	Total 32	C 10	N 5	O 14	P 3	0
3	2J	1	Total 32	C 10	N 5	O 14	P 3	0
3	2K	1	Total 32	C 10	N 5	O 14	P 3	0
3	2L	1	Total 32	C 10	N 5	O 14	P 3	0
3	2M	1	Total 32	C 10	N 5	O 14	P 3	0
3	2N	1	Total 32	C 10	N 5	O 14	P 3	0
3	3A	1	Total 32	C 10	N 5	O 14	P 3	0

*Continued on next page...*

*Continued from previous page...*

Mol	Chain	Residues	Atoms					AltConf
			Total	C	N	O	P	
3	3B	1	Total 32	C 10	N 5	O 14	P 3	0
3	3C	1	Total 32	C 10	N 5	O 14	P 3	0
3	3D	1	Total 32	C 10	N 5	O 14	P 3	0
3	3E	1	Total 32	C 10	N 5	O 14	P 3	0
3	3F	1	Total 32	C 10	N 5	O 14	P 3	0
3	3G	1	Total 32	C 10	N 5	O 14	P 3	0
3	3I	1	Total 32	C 10	N 5	O 14	P 3	0
3	3J	1	Total 32	C 10	N 5	O 14	P 3	0
3	3K	1	Total 32	C 10	N 5	O 14	P 3	0
3	3L	1	Total 32	C 10	N 5	O 14	P 3	0
3	3M	1	Total 32	C 10	N 5	O 14	P 3	0
3	3N	1	Total 32	C 10	N 5	O 14	P 3	0
3	4A	1	Total 32	C 10	N 5	O 14	P 3	0
3	4B	1	Total 32	C 10	N 5	O 14	P 3	0
3	4C	1	Total 32	C 10	N 5	O 14	P 3	0
3	4D	1	Total 32	C 10	N 5	O 14	P 3	0
3	4E	1	Total 32	C 10	N 5	O 14	P 3	0
3	4F	1	Total 32	C 10	N 5	O 14	P 3	0
3	4G	1	Total 32	C 10	N 5	O 14	P 3	0
3	4I	1	Total 32	C 10	N 5	O 14	P 3	0
3	4J	1	Total 32	C 10	N 5	O 14	P 3	0

*Continued on next page...*

*Continued from previous page...*

Mol	Chain	Residues	Atoms					AltConf
3	4K	1	Total	C	N	O	P	0
			32	10	5	14	3	
3	4L	1	Total	C	N	O	P	0
			32	10	5	14	3	
3	4M	1	Total	C	N	O	P	0
			32	10	5	14	3	
3	4N	1	Total	C	N	O	P	0
			32	10	5	14	3	

- Molecule 4 is MAGNESIUM ION (three-letter code: MG) (formula: Mg).

Mol	Chain	Residues	Atoms		AltConf
4	1A	1	Total	Mg	0
			1	1	
4	1B	1	Total	Mg	0
			1	1	
4	1C	1	Total	Mg	0
			1	1	
4	1D	1	Total	Mg	0
			1	1	
4	1E	1	Total	Mg	0
			1	1	
4	1F	1	Total	Mg	0
			1	1	
4	1G	1	Total	Mg	0
			1	1	
4	1I	1	Total	Mg	0
			1	1	
4	1J	1	Total	Mg	0
			1	1	
4	1K	1	Total	Mg	0
			1	1	
4	1L	1	Total	Mg	0
			1	1	
4	1M	1	Total	Mg	0
			1	1	
4	1N	1	Total	Mg	0
			1	1	
4	2A	1	Total	Mg	0
			1	1	
4	2B	1	Total	Mg	0
			1	1	

*Continued on next page...*



*Continued from previous page...*

<b>Mol</b>	<b>Chain</b>	<b>Residues</b>	<b>Atoms</b>		<b>AltConf</b>
4	2C	1	Total 1	Mg 1	0
4	2D	1	Total 1	Mg 1	0
4	2E	1	Total 1	Mg 1	0
4	2F	1	Total 1	Mg 1	0
4	2G	1	Total 1	Mg 1	0
4	2I	1	Total 1	Mg 1	0
4	2J	1	Total 1	Mg 1	0
4	2K	1	Total 1	Mg 1	0
4	2L	1	Total 1	Mg 1	0
4	2M	1	Total 1	Mg 1	0
4	2N	1	Total 1	Mg 1	0
4	3A	1	Total 1	Mg 1	0
4	3B	1	Total 1	Mg 1	0
4	3C	1	Total 1	Mg 1	0
4	3D	1	Total 1	Mg 1	0
4	3E	1	Total 1	Mg 1	0
4	3F	1	Total 1	Mg 1	0
4	3G	1	Total 1	Mg 1	0
4	3I	1	Total 1	Mg 1	0
4	3J	1	Total 1	Mg 1	0
4	3K	1	Total 1	Mg 1	0

*Continued on next page...*

*Continued from previous page...*

Mol	Chain	Residues	Atoms		AltConf
4	3L	1	Total 1	Mg 1	0
4	3M	1	Total 1	Mg 1	0
4	3N	1	Total 1	Mg 1	0
4	4A	1	Total 1	Mg 1	0
4	4B	1	Total 1	Mg 1	0
4	4C	1	Total 1	Mg 1	0
4	4D	1	Total 1	Mg 1	0
4	4E	1	Total 1	Mg 1	0
4	4F	1	Total 1	Mg 1	0
4	4G	1	Total 1	Mg 1	0
4	4I	1	Total 1	Mg 1	0
4	4J	1	Total 1	Mg 1	0
4	4K	1	Total 1	Mg 1	0
4	4L	1	Total 1	Mg 1	0
4	4M	1	Total 1	Mg 1	0
4	4N	1	Total 1	Mg 1	0

- Molecule 5 is GUANOSINE-5'-DIPHOSPHATE (three-letter code: GDP) (formula:  $C_{10}H_{15}N_5O_{11}P_2$ ).

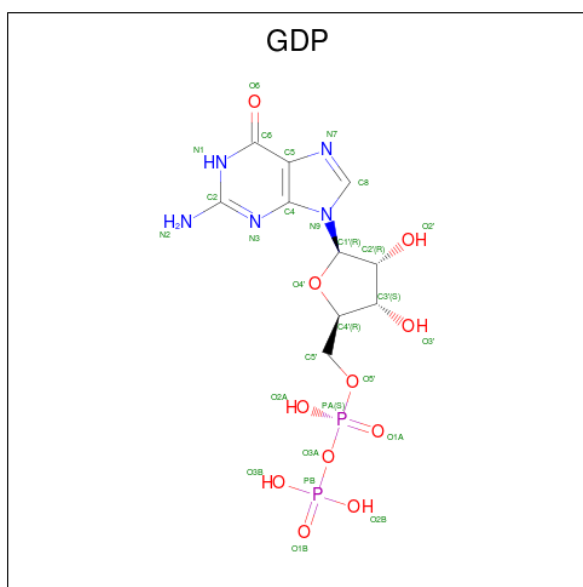

Mol	Chain	Residues	Atoms					AltConf
			Total	C	N	O	P	
5	1H	1	Total	C	N	O	P	0
			28	10	5	11	2	
5	1O	1	Total	C	N	O	P	0
			28	10	5	11	2	
5	1P	1	Total	C	N	O	P	0
			28	10	5	11	2	
5	1Q	1	Total	C	N	O	P	0
			28	10	5	11	2	
5	1R	1	Total	C	N	O	P	0
			28	10	5	11	2	
5	1S	1	Total	C	N	O	P	0
			28	10	5	11	2	
5	1T	1	Total	C	N	O	P	0
			28	10	5	11	2	
5	1U	1	Total	C	N	O	P	0
			28	10	5	11	2	
5	1V	1	Total	C	N	O	P	0
			28	10	5	11	2	
5	1W	1	Total	C	N	O	P	0
			28	10	5	11	2	
5	1X	1	Total	C	N	O	P	0
			28	10	5	11	2	
5	1Y	1	Total	C	N	O	P	0
			28	10	5	11	2	
5	1Z	1	Total	C	N	O	P	0
			28	10	5	11	2	
5	2H	1	Total	C	N	O	P	0
			28	10	5	11	2	

*Continued on next page...*

*Continued from previous page...*

Mol	Chain	Residues	Atoms					AltConf
			Total	C	N	O	P	
5	2O	1	Total 28	C 10	N 5	O 11	P 2	0
5	2P	1	Total 28	C 10	N 5	O 11	P 2	0
5	2Q	1	Total 28	C 10	N 5	O 11	P 2	0
5	2R	1	Total 28	C 10	N 5	O 11	P 2	0
5	2S	1	Total 28	C 10	N 5	O 11	P 2	0
5	2T	1	Total 28	C 10	N 5	O 11	P 2	0
5	2U	1	Total 28	C 10	N 5	O 11	P 2	0
5	2V	1	Total 28	C 10	N 5	O 11	P 2	0
5	2W	1	Total 28	C 10	N 5	O 11	P 2	0
5	2X	1	Total 28	C 10	N 5	O 11	P 2	0
5	2Y	1	Total 28	C 10	N 5	O 11	P 2	0
5	2Z	1	Total 28	C 10	N 5	O 11	P 2	0
5	3H	1	Total 28	C 10	N 5	O 11	P 2	0
5	3O	1	Total 28	C 10	N 5	O 11	P 2	0
5	3P	1	Total 28	C 10	N 5	O 11	P 2	0
5	3Q	1	Total 28	C 10	N 5	O 11	P 2	0
5	3R	1	Total 28	C 10	N 5	O 11	P 2	0
5	3S	1	Total 28	C 10	N 5	O 11	P 2	0
5	3T	1	Total 28	C 10	N 5	O 11	P 2	0
5	3U	1	Total 28	C 10	N 5	O 11	P 2	0
5	3V	1	Total 28	C 10	N 5	O 11	P 2	0

*Continued on next page...*

*Continued from previous page...*

Mol	Chain	Residues	Atoms					AltConf
			Total	C	N	O	P	
5	3W	1	Total 28	C 10	N 5	O 11	P 2	0
5	3X	1	Total 28	C 10	N 5	O 11	P 2	0
5	3Y	1	Total 28	C 10	N 5	O 11	P 2	0
5	3Z	1	Total 28	C 10	N 5	O 11	P 2	0
5	4H	1	Total 28	C 10	N 5	O 11	P 2	0
5	4O	1	Total 28	C 10	N 5	O 11	P 2	0
5	4P	1	Total 28	C 10	N 5	O 11	P 2	0
5	4Q	1	Total 28	C 10	N 5	O 11	P 2	0
5	4R	1	Total 28	C 10	N 5	O 11	P 2	0
5	4S	1	Total 28	C 10	N 5	O 11	P 2	0
5	4T	1	Total 28	C 10	N 5	O 11	P 2	0
5	4U	1	Total 28	C 10	N 5	O 11	P 2	0
5	4V	1	Total 28	C 10	N 5	O 11	P 2	0
5	4W	1	Total 28	C 10	N 5	O 11	P 2	0
5	4X	1	Total 28	C 10	N 5	O 11	P 2	0
5	4Y	1	Total 28	C 10	N 5	O 11	P 2	0
5	4Z	1	Total 28	C 10	N 5	O 11	P 2	0

### 3 Residue-property plots [i](#)

These plots are drawn for all protein, RNA, DNA and oligosaccharide chains in the entry. The first graphic for a chain summarises the proportions of the various outlier classes displayed in the second graphic. The second graphic shows the sequence view annotated by issues in geometry and atom inclusion in map density. Residues are color-coded according to the number of geometric quality criteria for which they contain at least one outlier: green = 0, yellow = 1, orange = 2 and red = 3 or more. A red diamond above a residue indicates a poor fit to the EM map for this residue (all-atom inclusion < 40%). Stretches of 2 or more consecutive residues without any outlier are shown as a green connector. Residues present in the sample, but not in the model, are shown in grey.

- Molecule 1: Tubulin alpha-1B chain

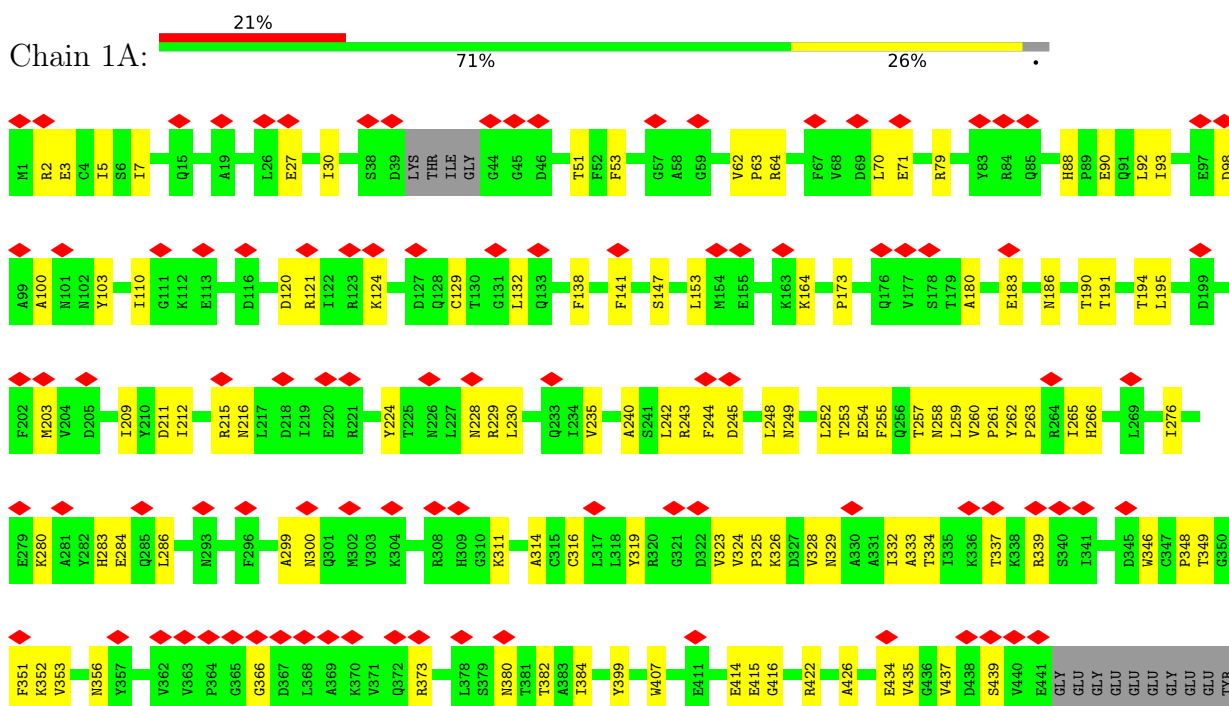

- Molecule 1: Tubulin alpha-1B chain

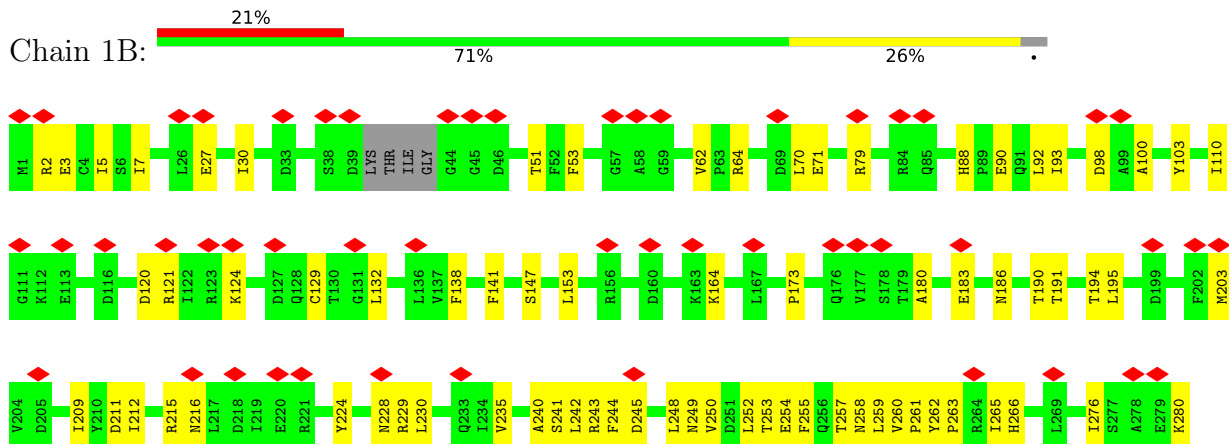

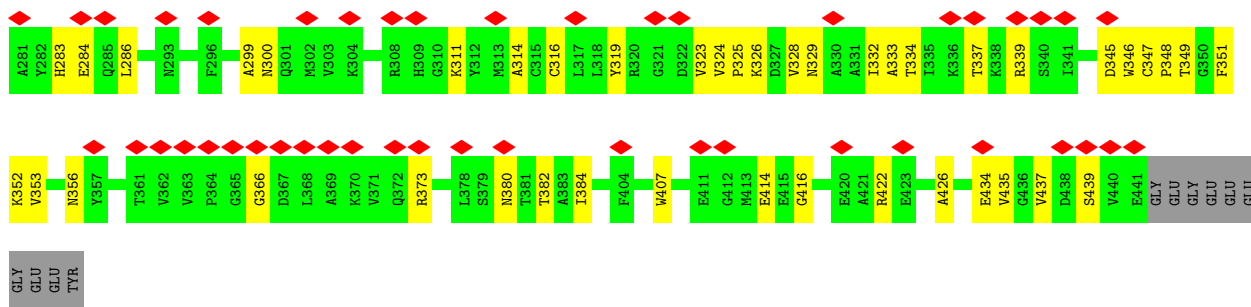

• Molecule 1: Tubulin alpha-1B chain

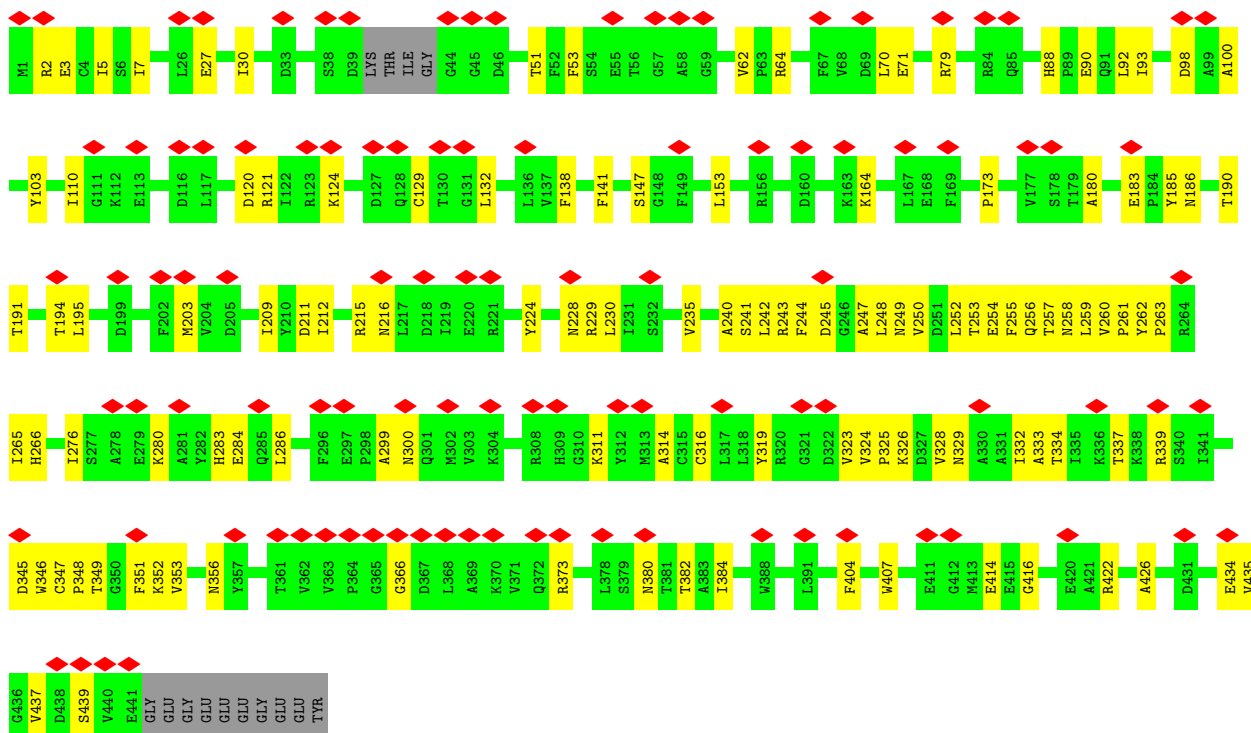

• Molecule 1: Tubulin alpha-1B chain

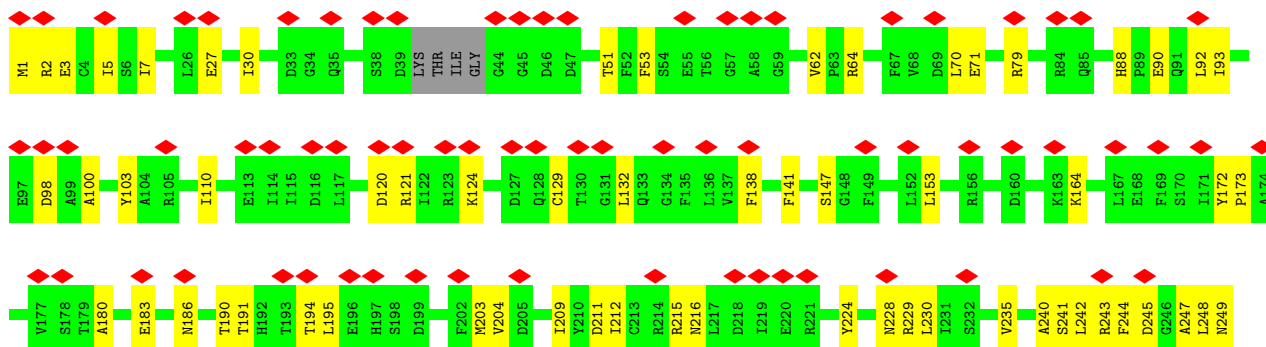





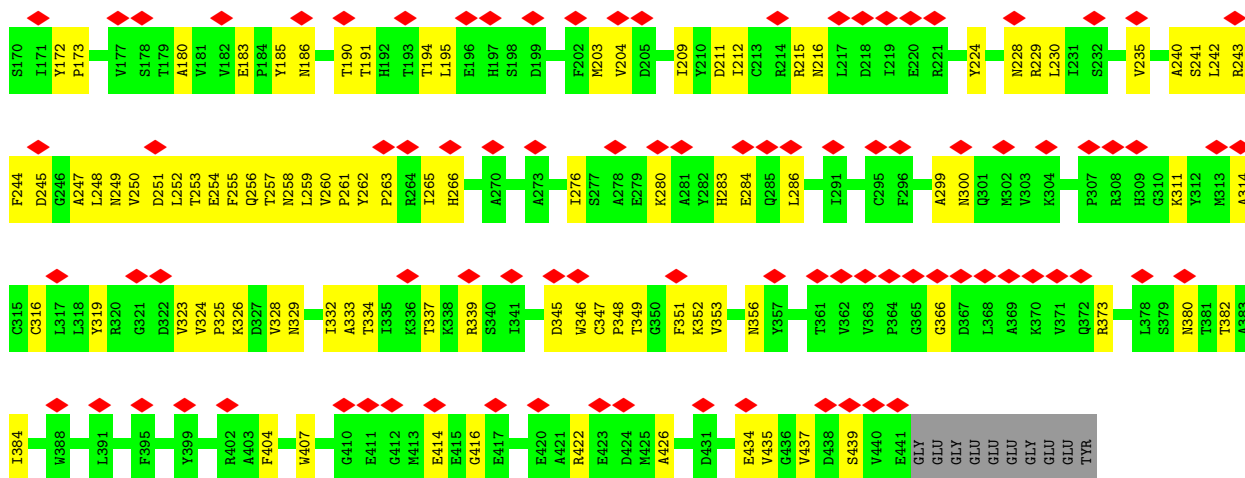

• Molecule 1: Tubulin alpha-1B chain

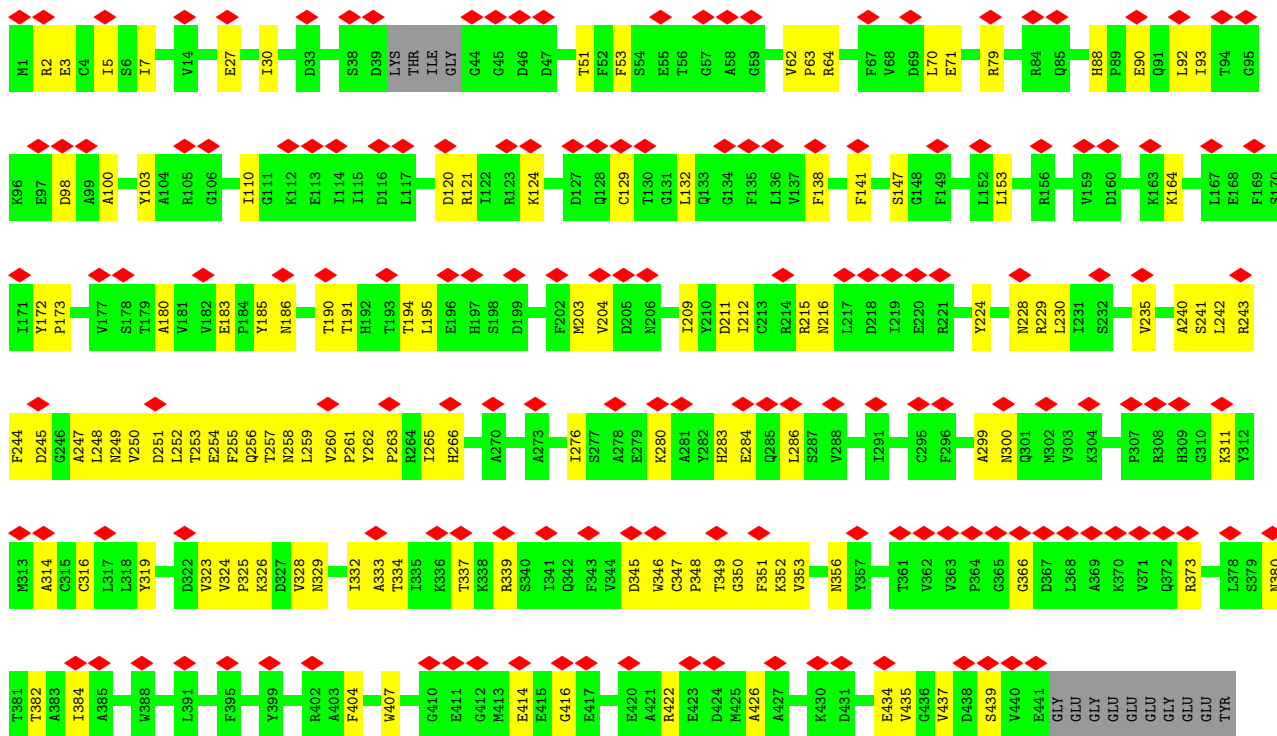

• Molecule 1: Tubulin alpha-1B chain

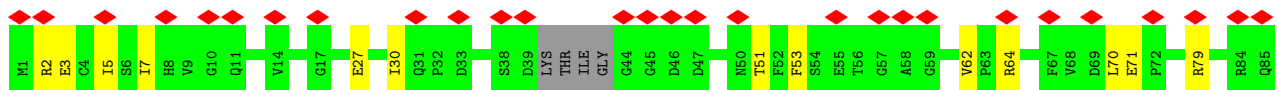
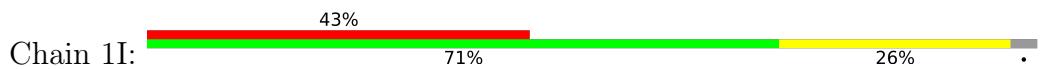



• Molecule 1: Tubulin alpha-1B chain

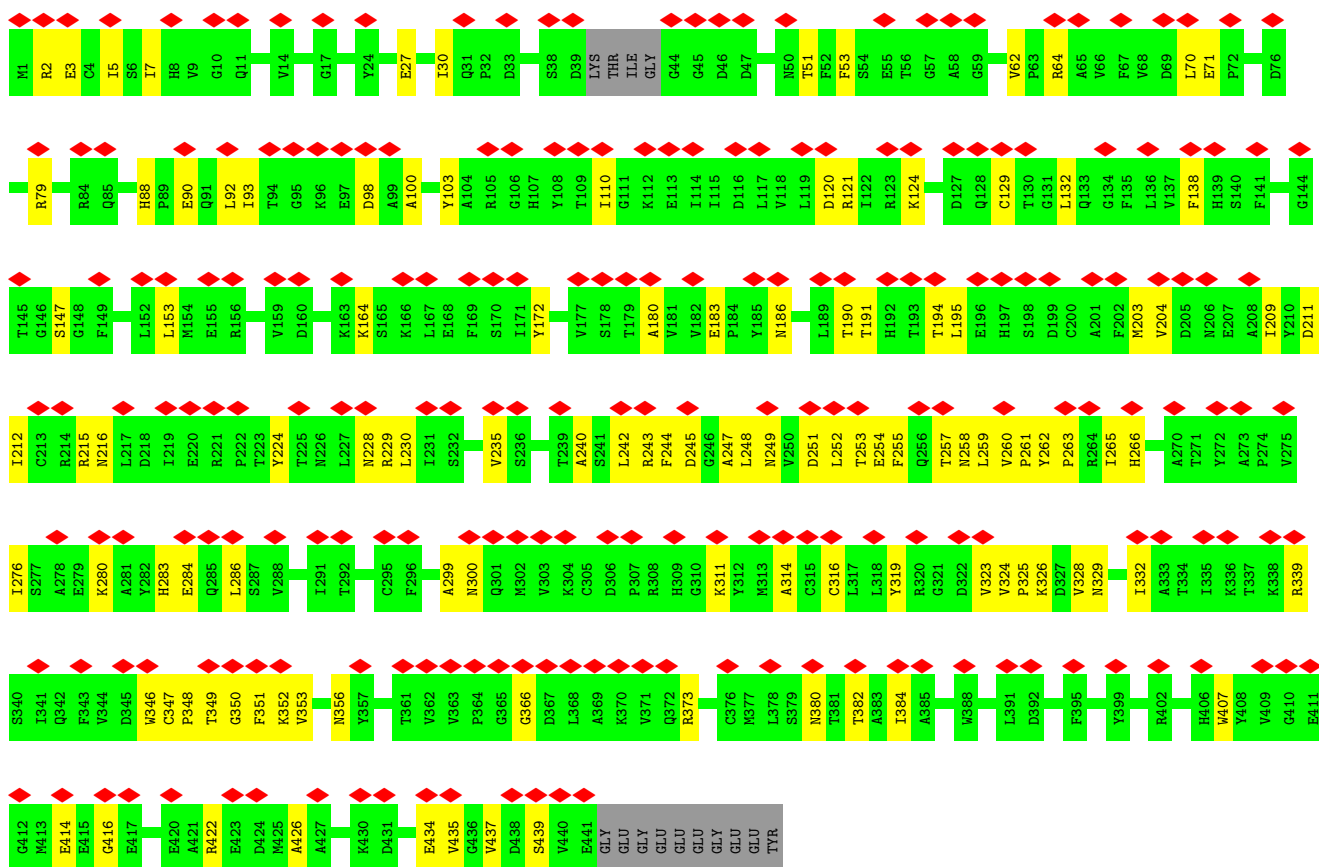
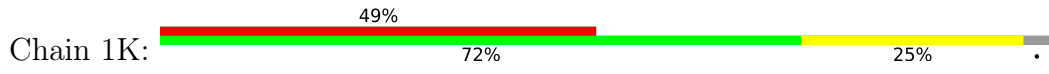



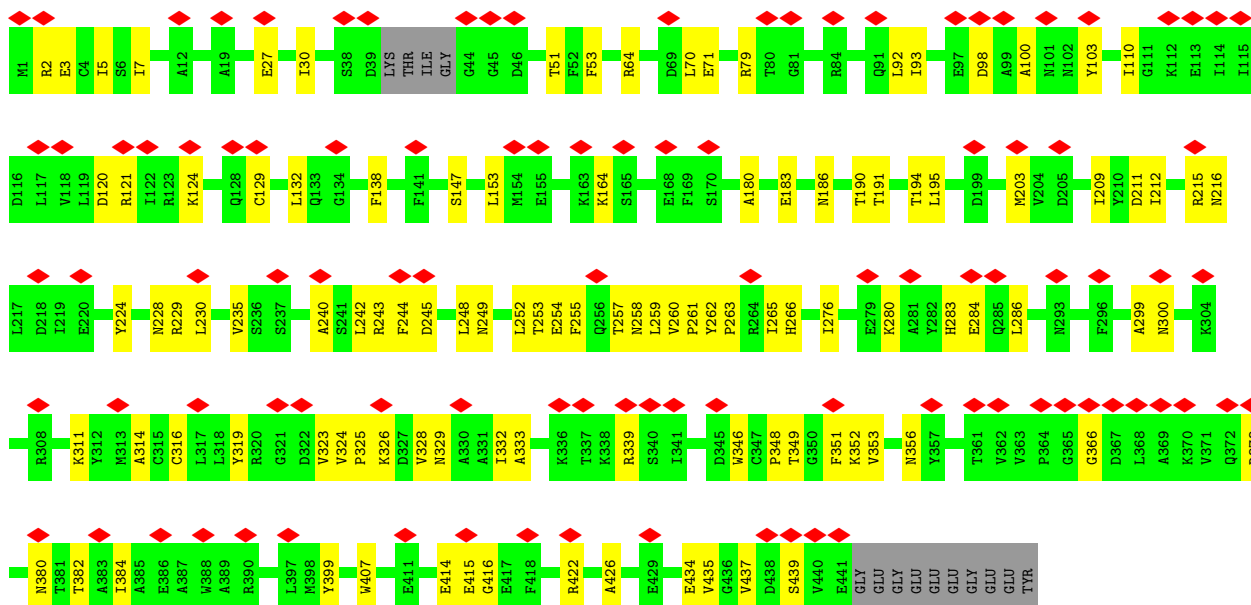

• Molecule 1: Tubulin alpha-1B chain

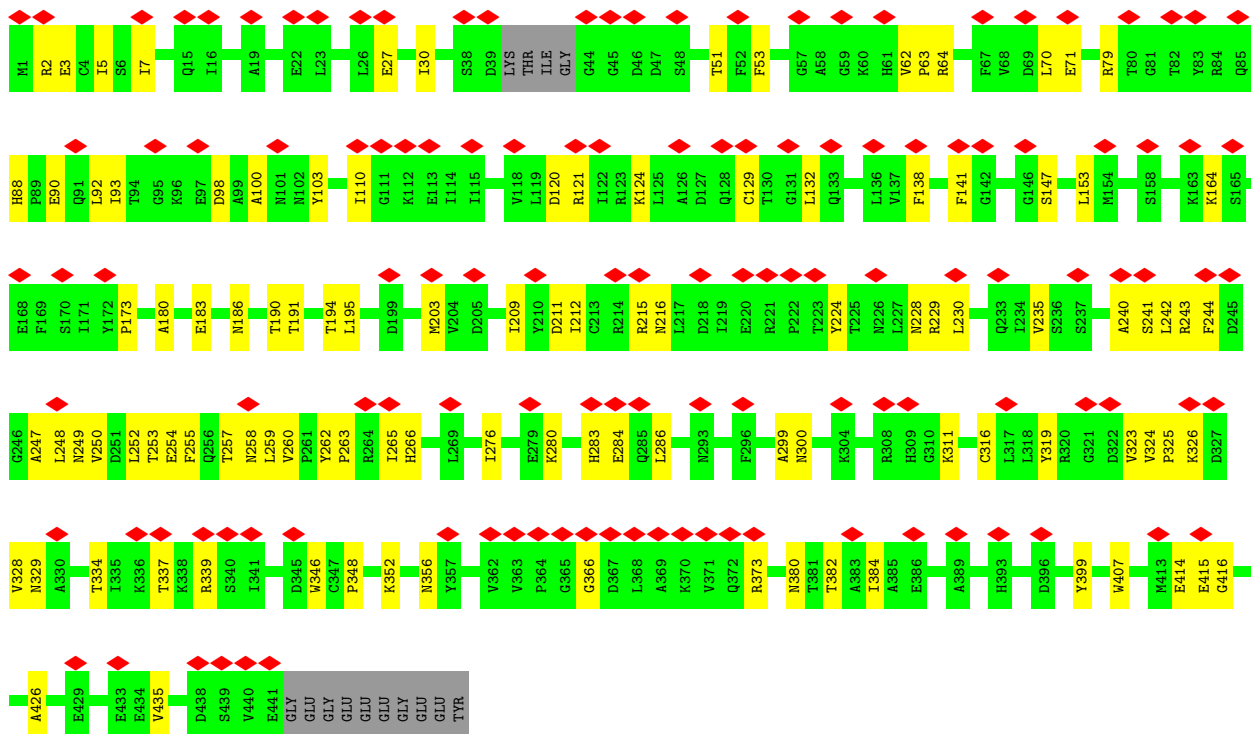
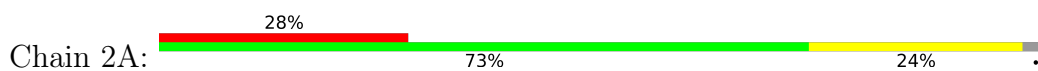

• Molecule 1: Tubulin alpha-1B chain

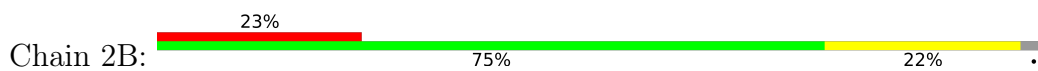

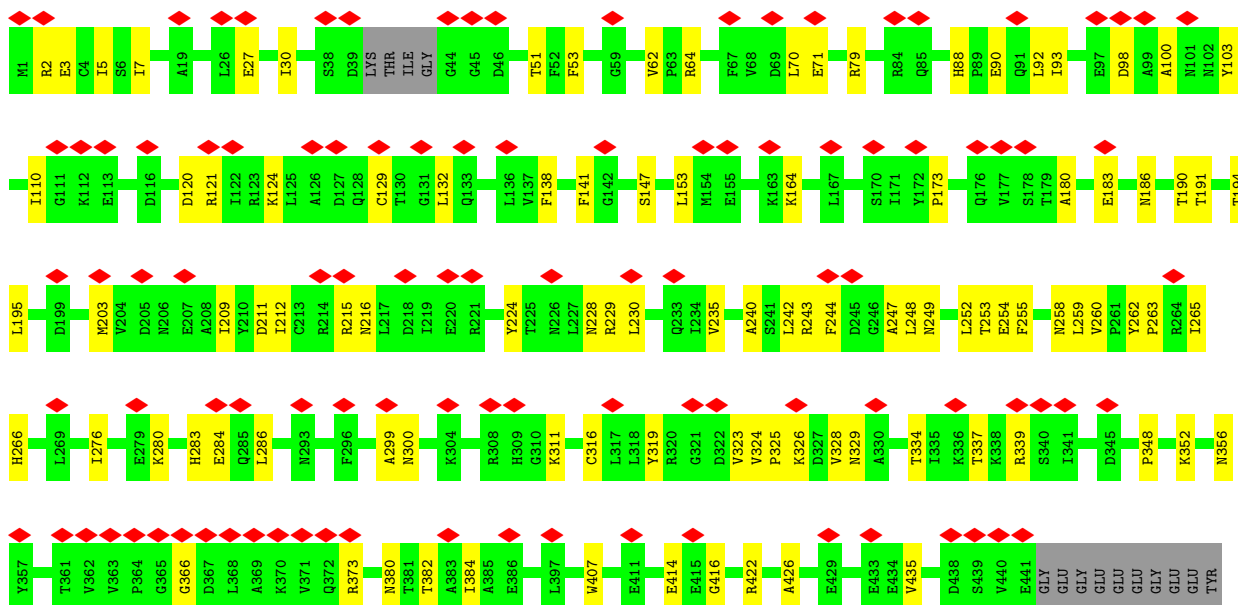

• Molecule 1: Tubulin alpha-1B chain

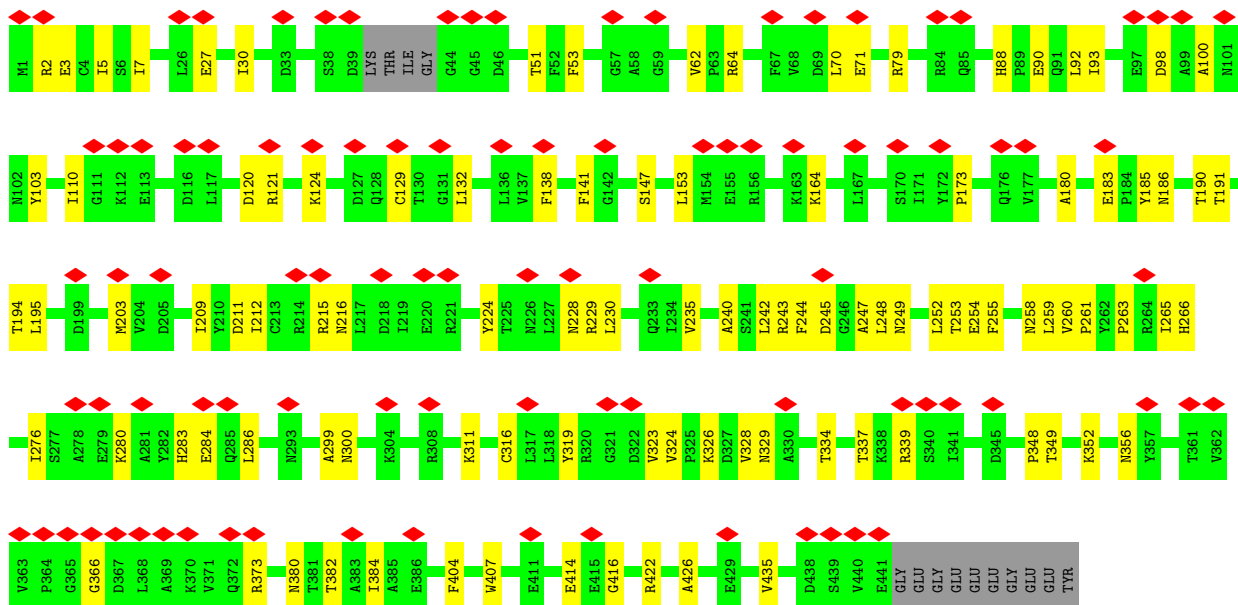
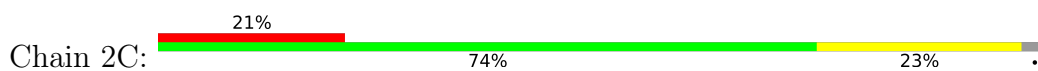

• Molecule 1: Tubulin alpha-1B chain

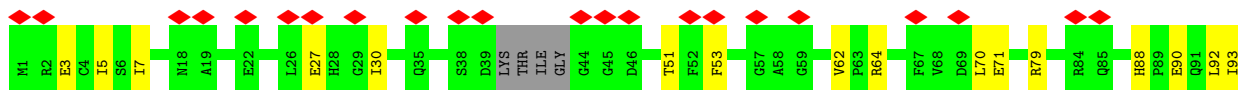
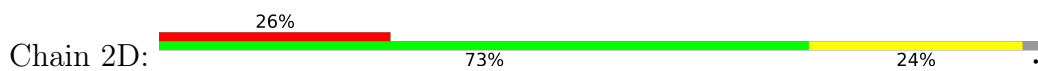

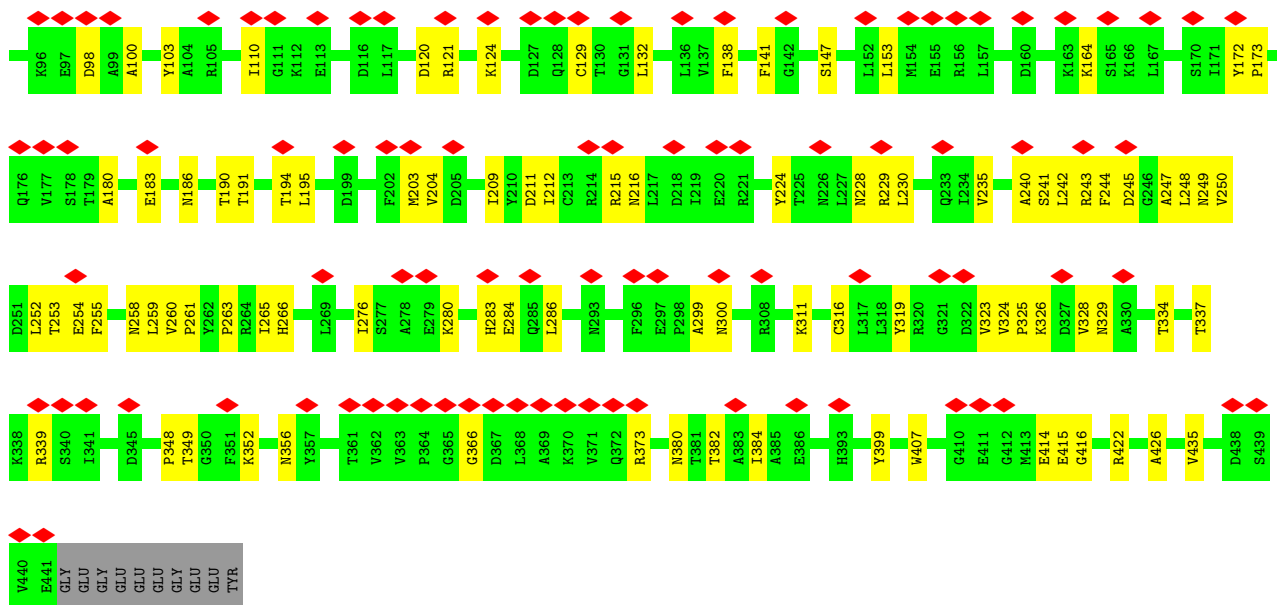

• Molecule 1: Tubulin alpha-1B chain

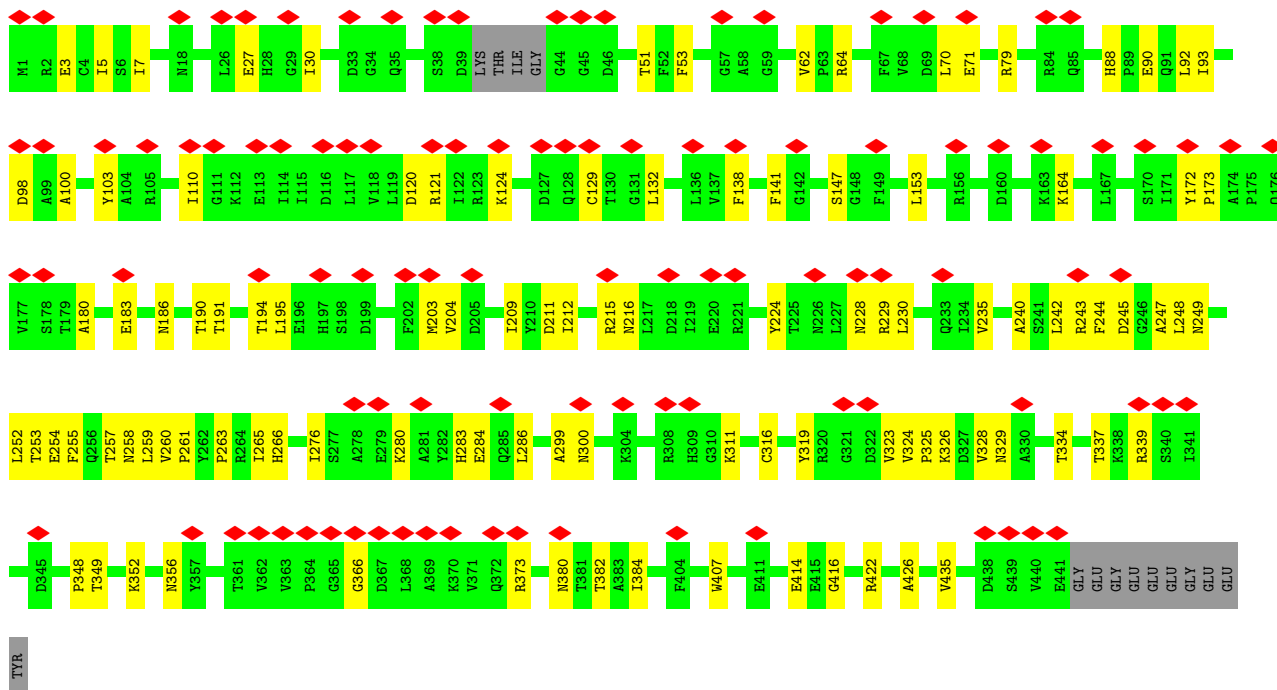
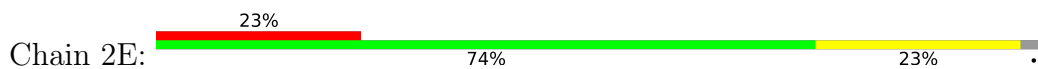

• Molecule 1: Tubulin alpha-1B chain

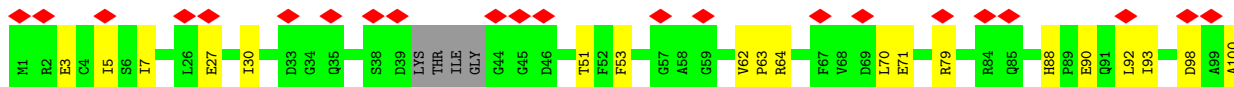
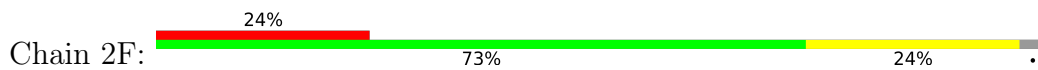

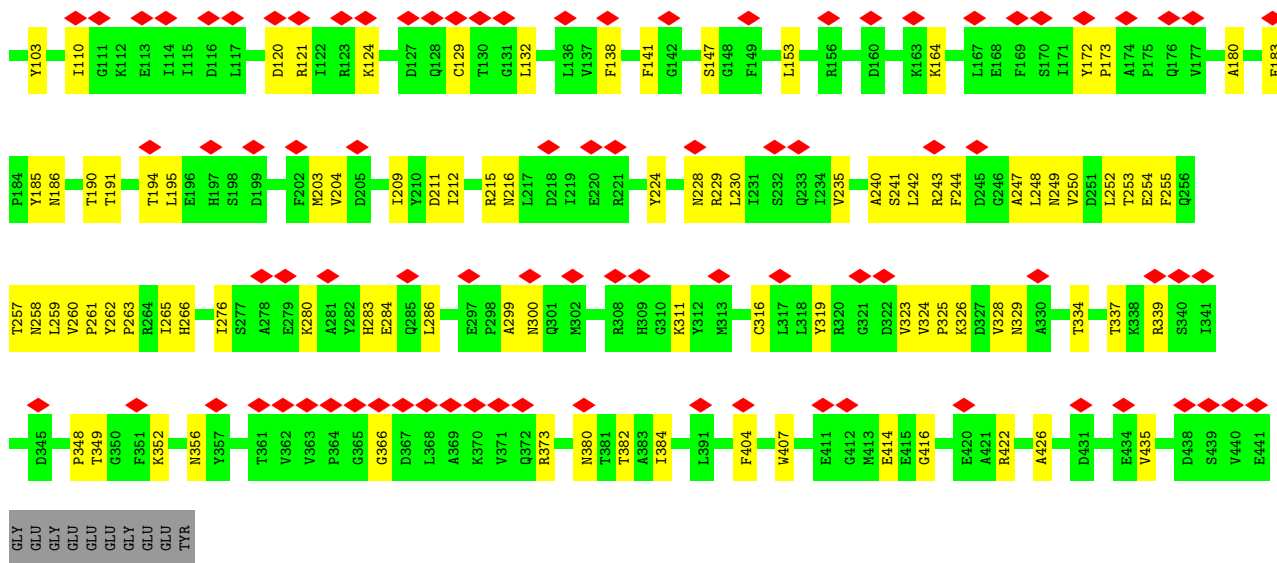

• Molecule 1: Tubulin alpha-1B chain

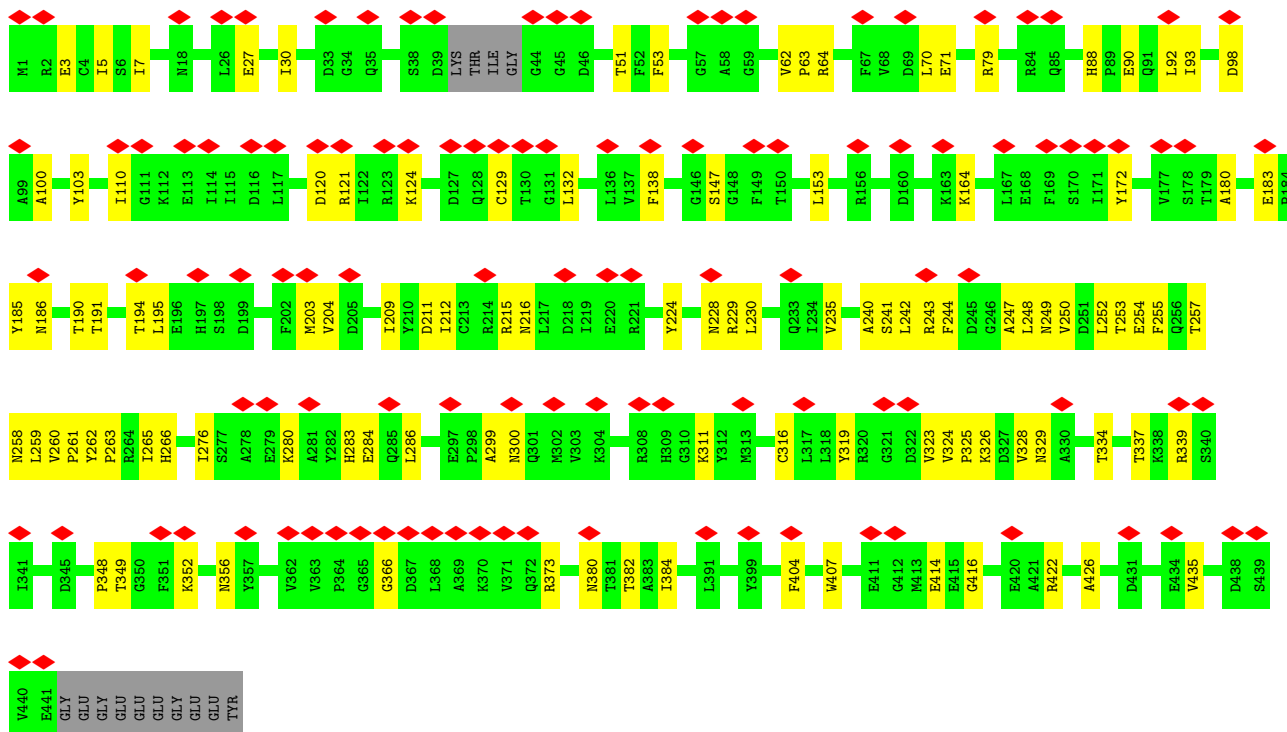
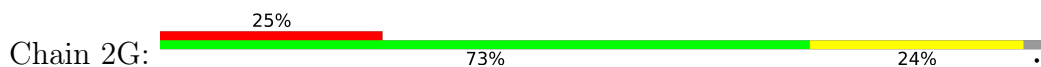

• Molecule 1: Tubulin alpha-1B chain

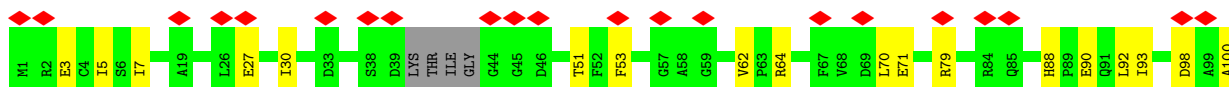
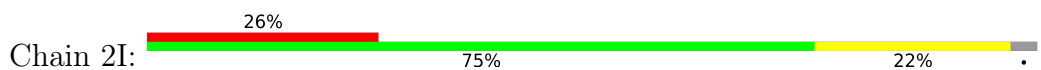



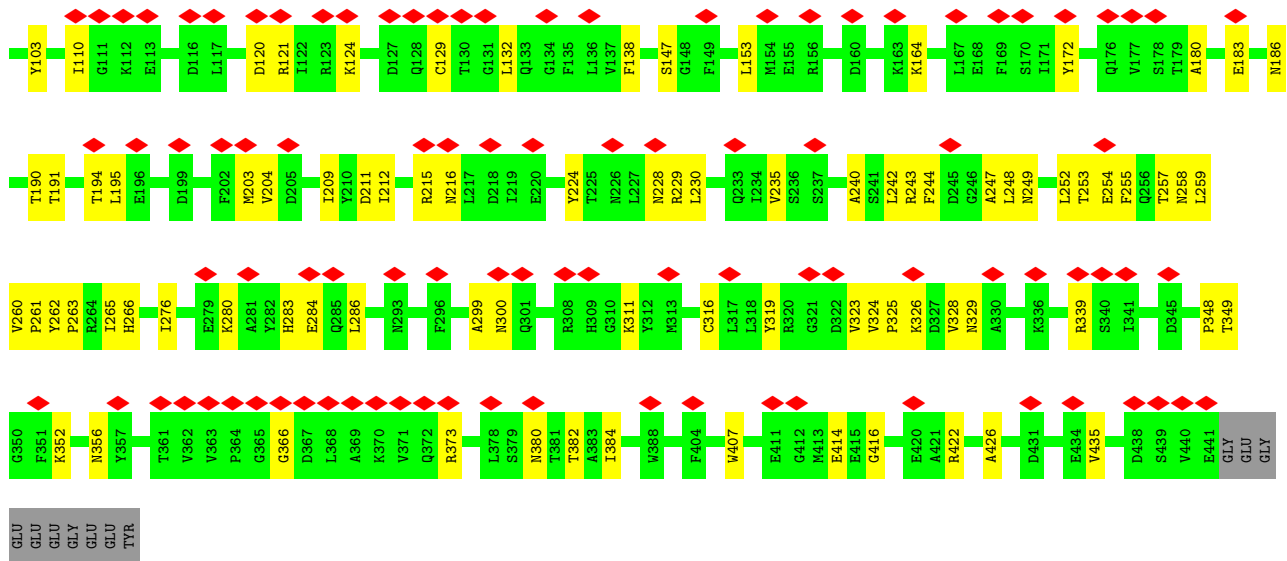

• Molecule 1: Tubulin alpha-1B chain

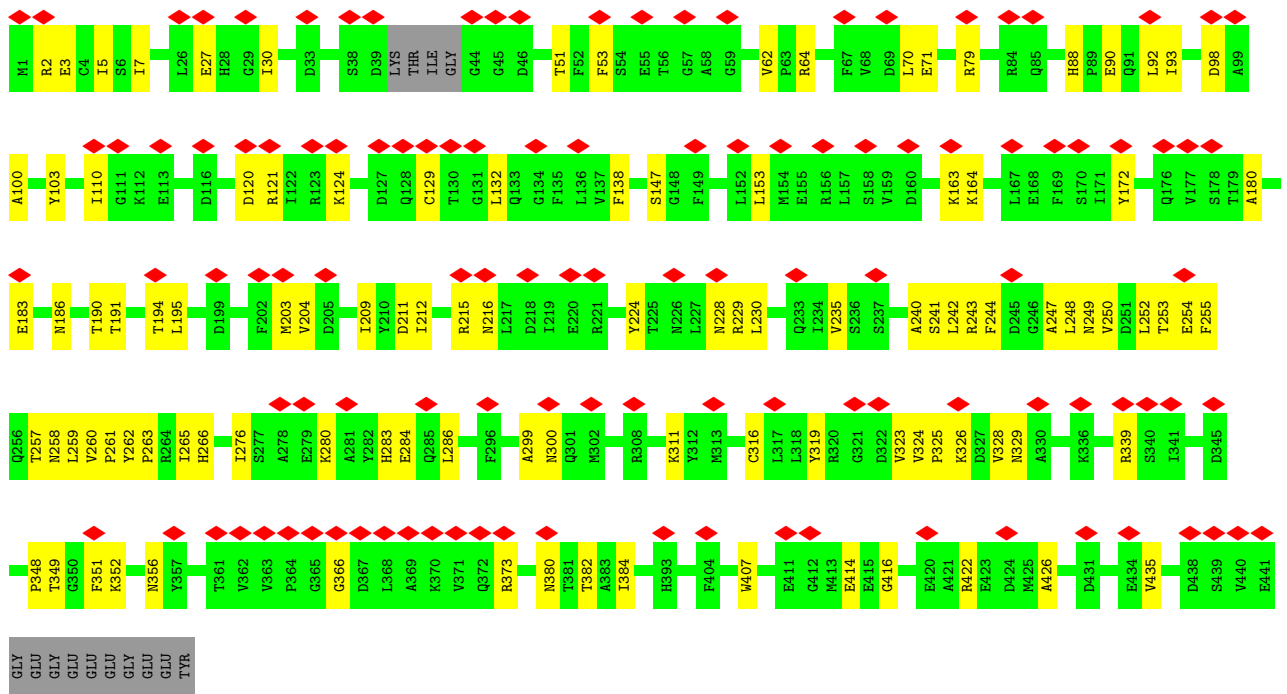
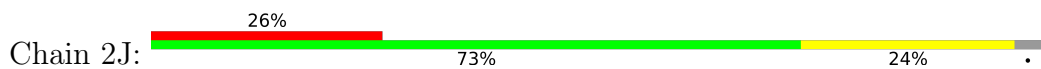

• Molecule 1: Tubulin alpha-1B chain

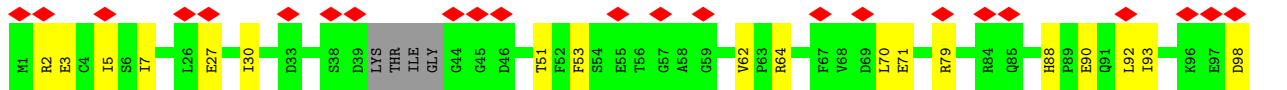
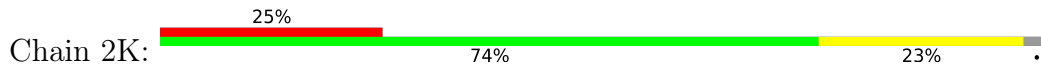

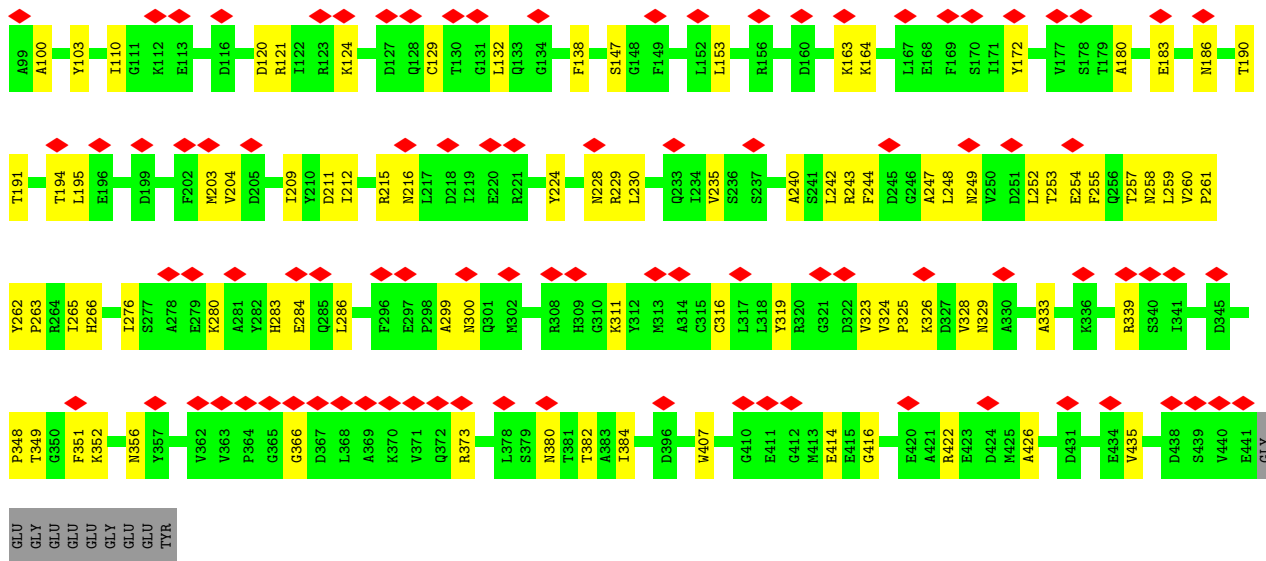

• Molecule 1: Tubulin alpha-1B chain

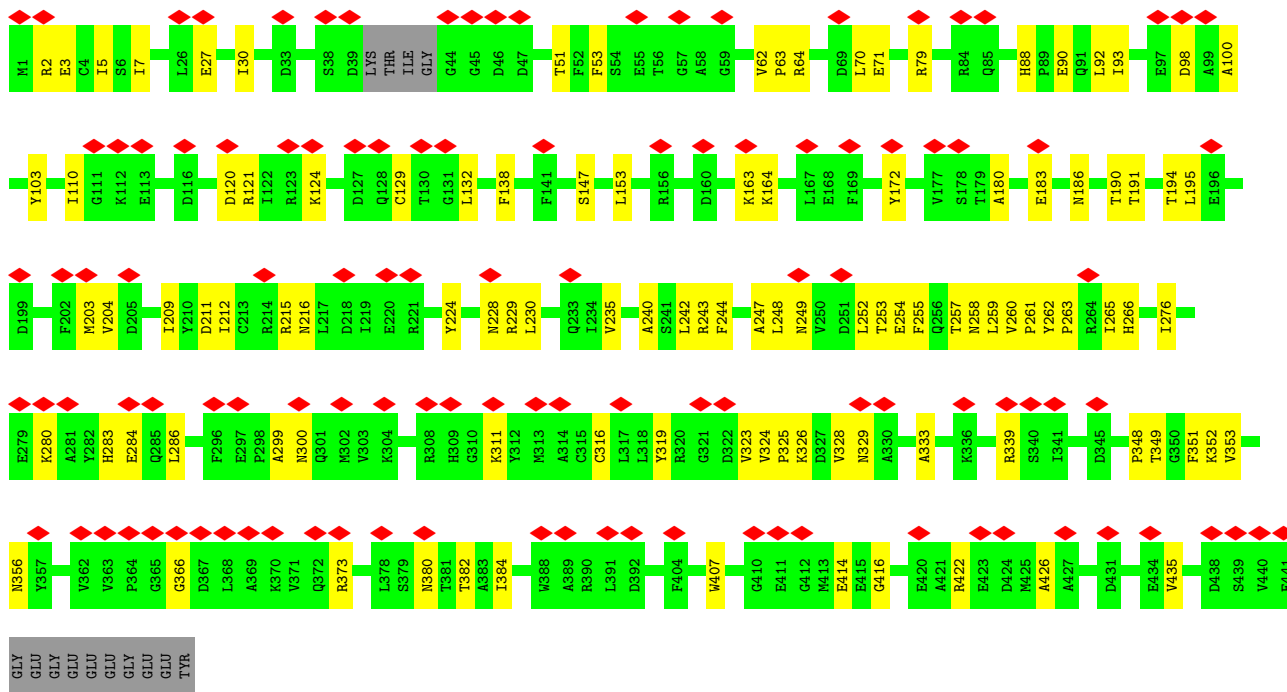
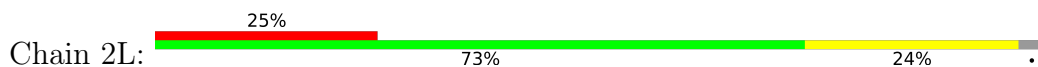

• Molecule 1: Tubulin alpha-1B chain

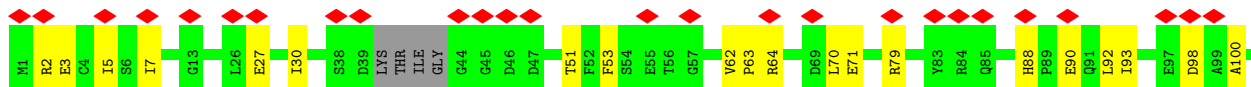
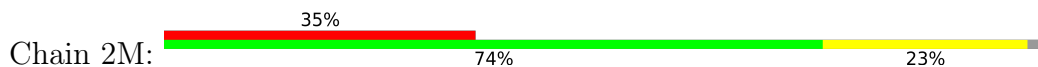

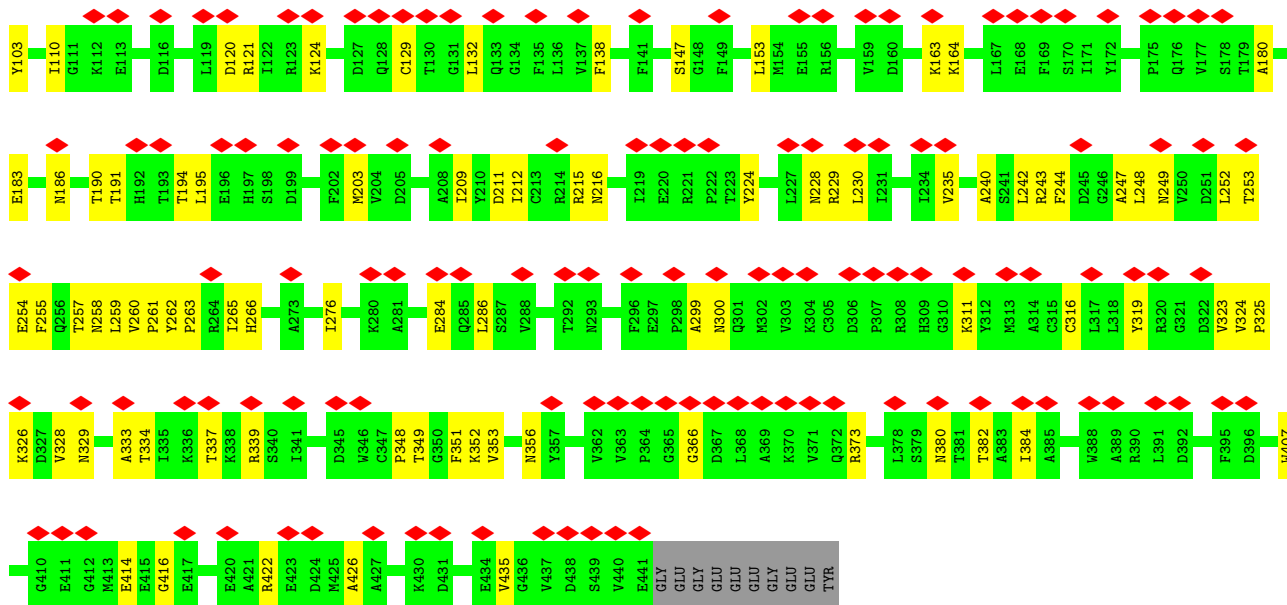

• Molecule 1: Tubulin alpha-1B chain

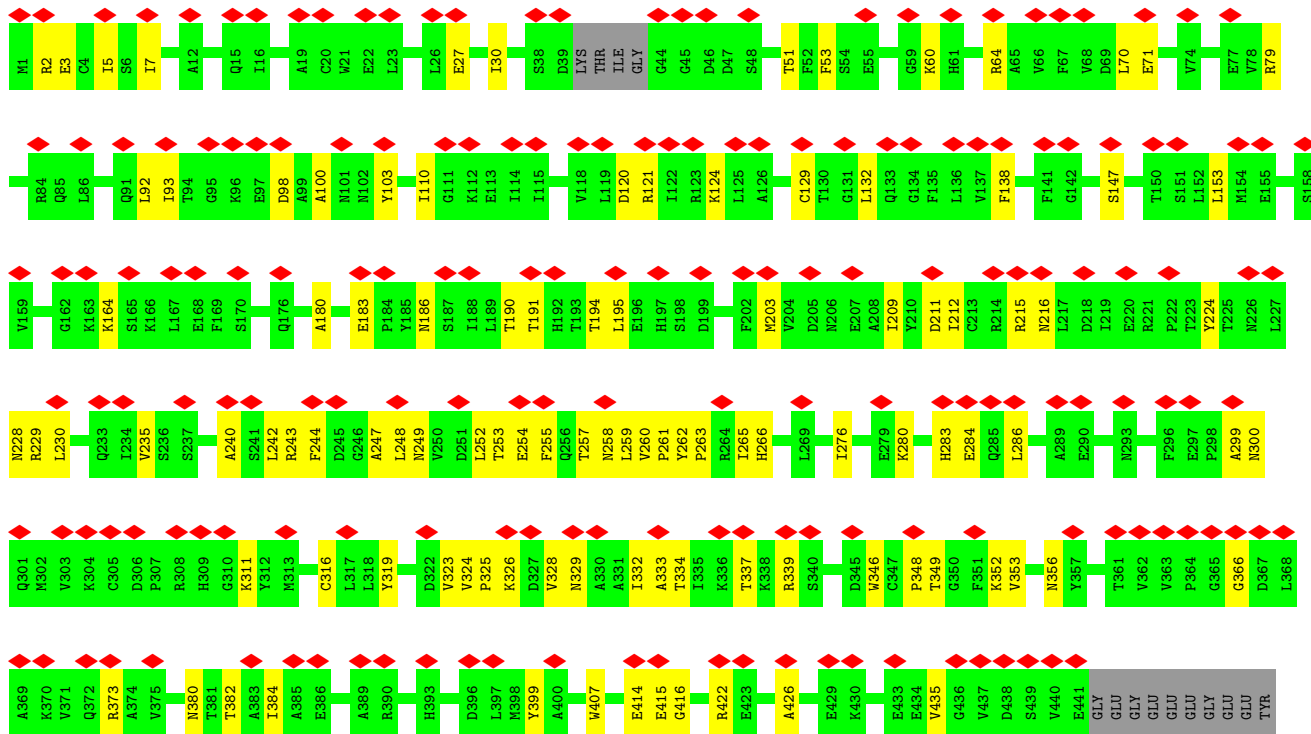
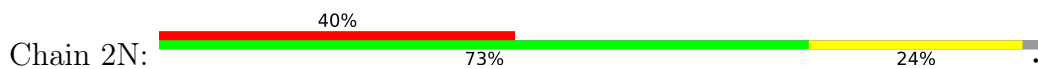

• Molecule 1: Tubulin alpha-1B chain

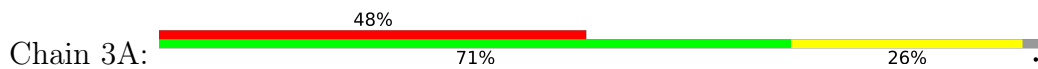

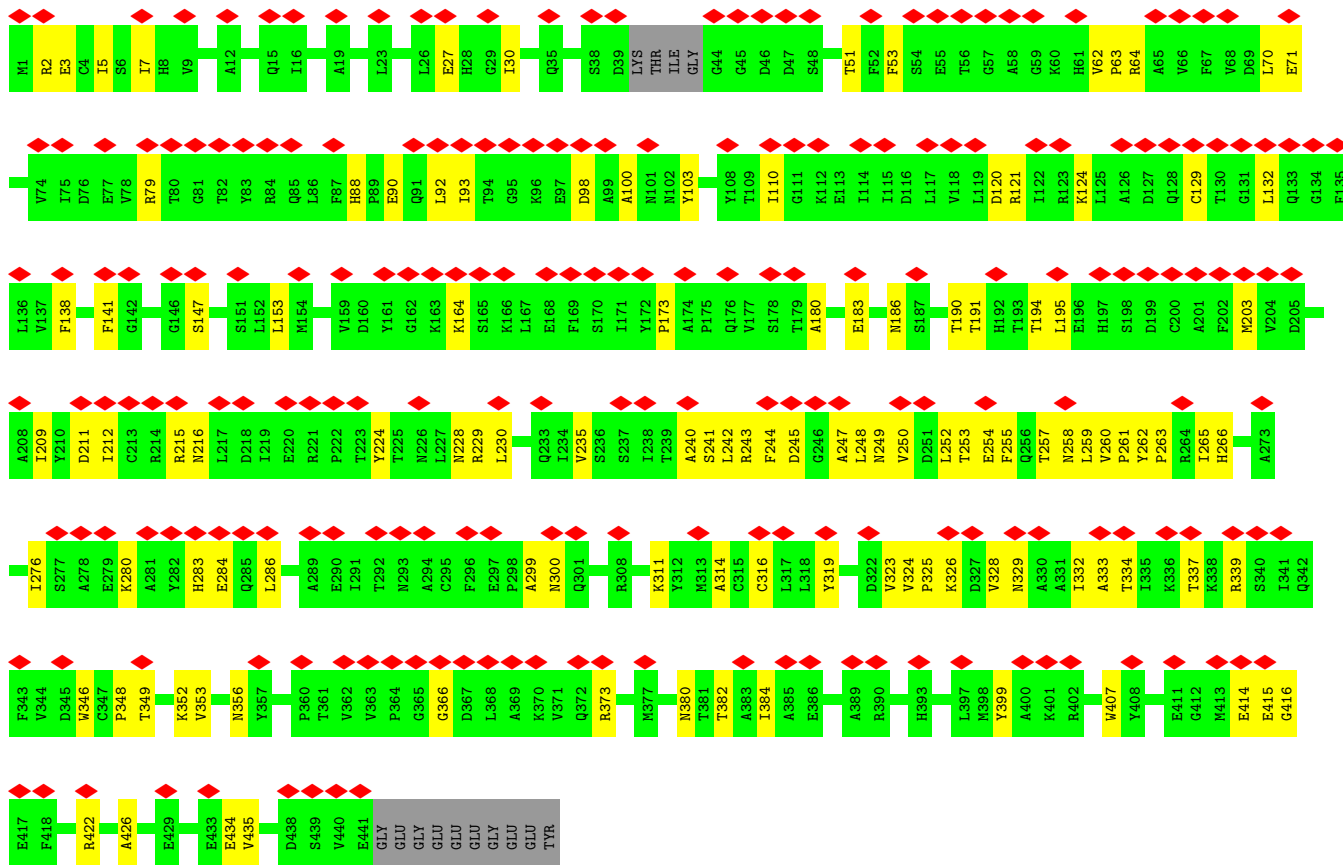

• Molecule 1: Tubulin alpha-1B chain

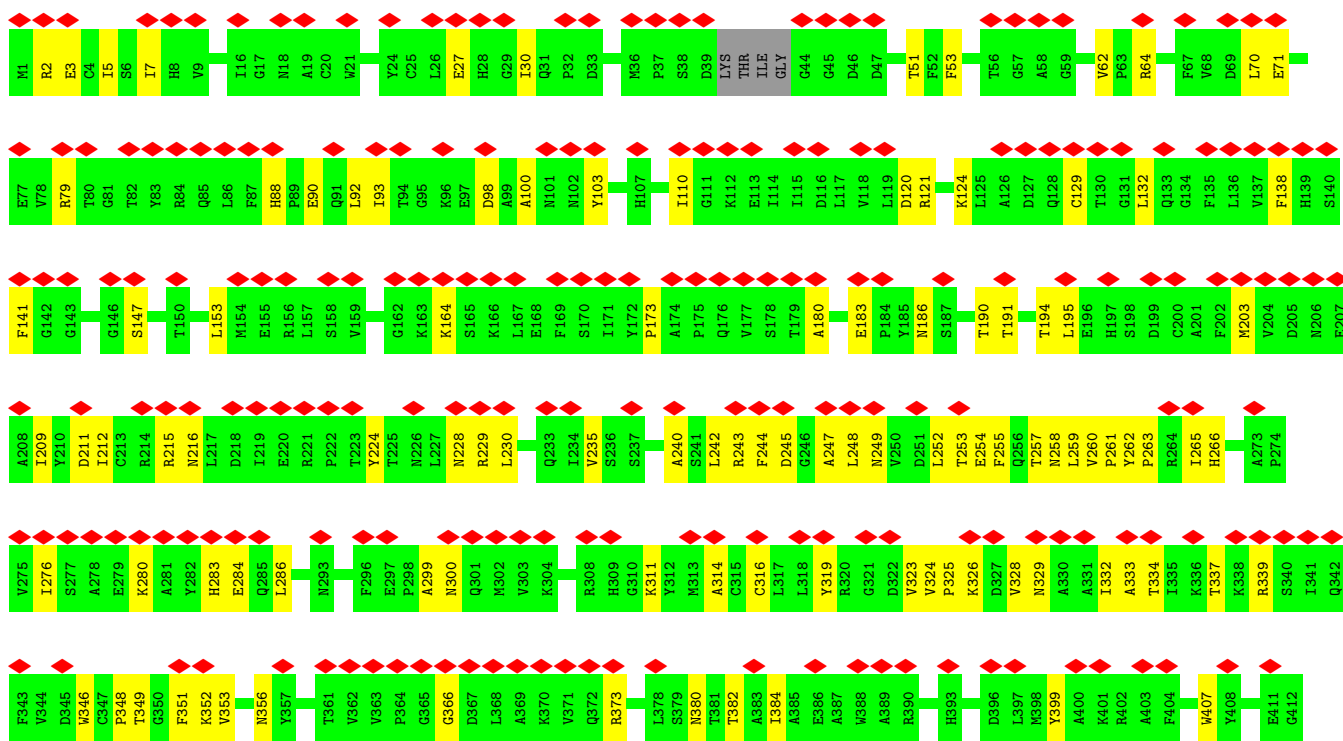
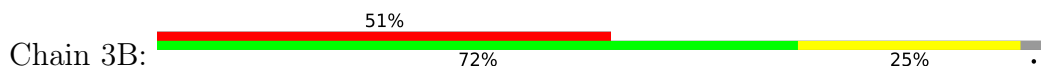



• Molecule 1: Tubulin alpha-1B chain

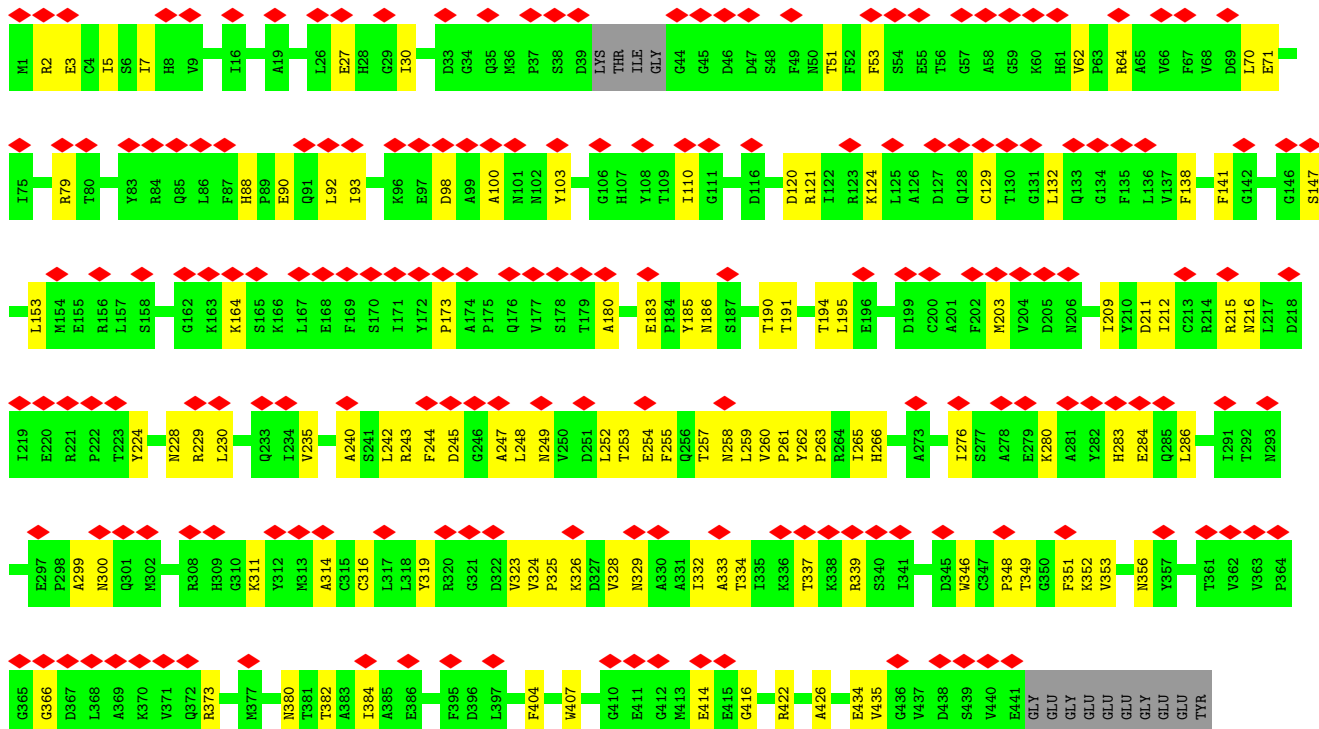
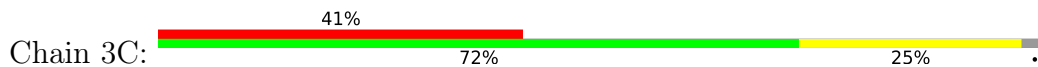

• Molecule 1: Tubulin alpha-1B chain

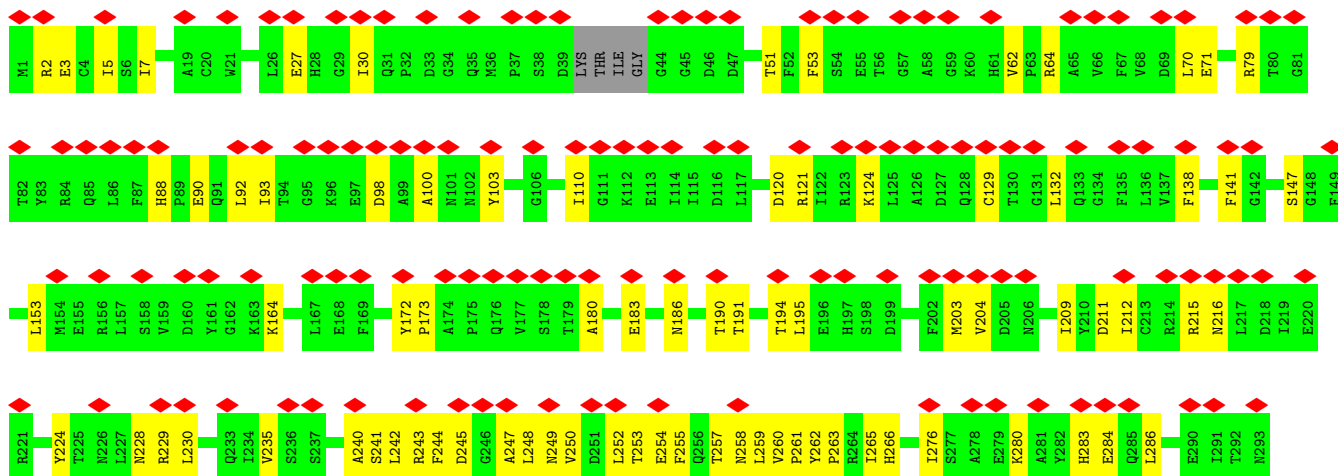
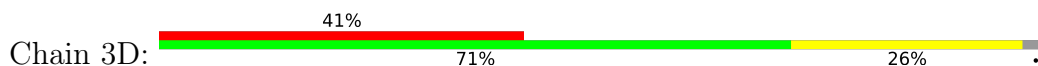

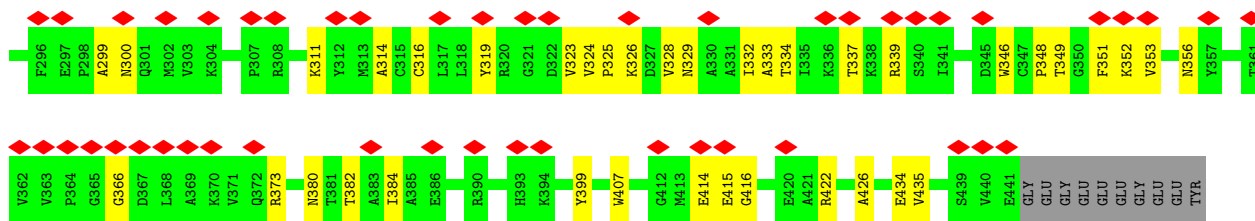

• Molecule 1: Tubulin alpha-1B chain

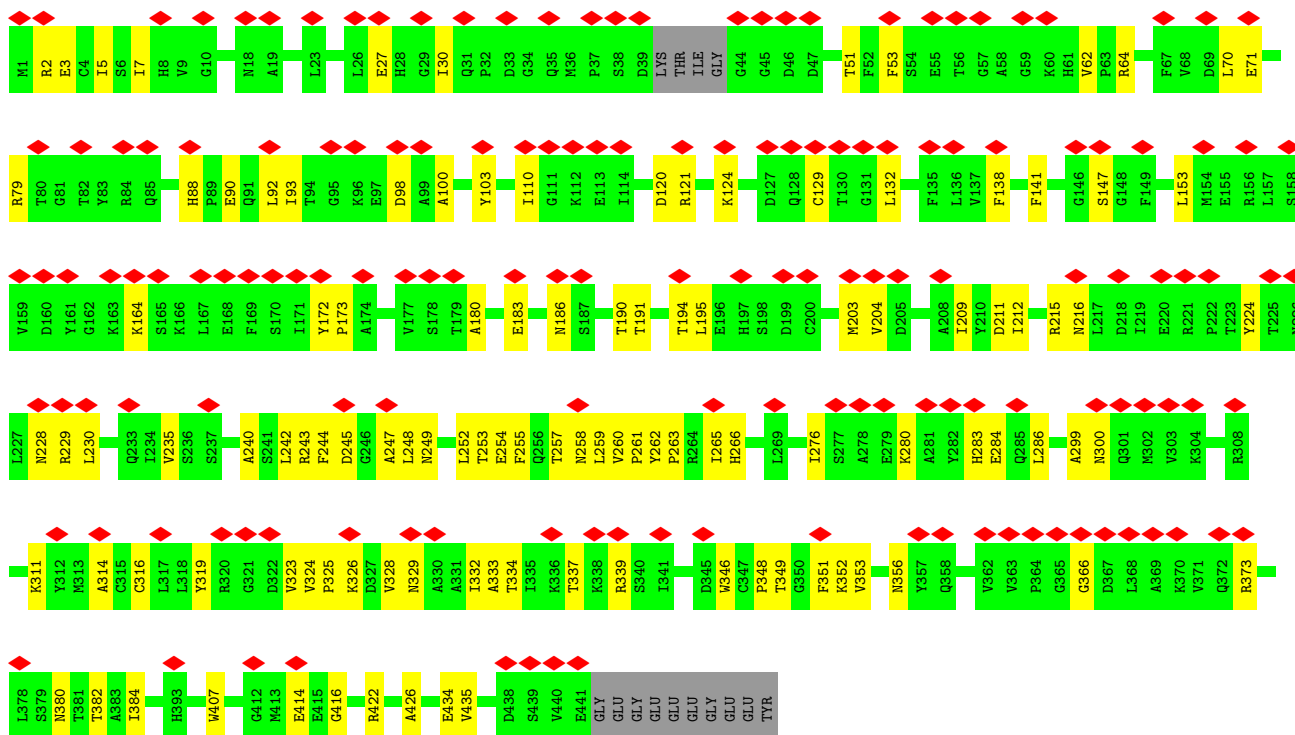
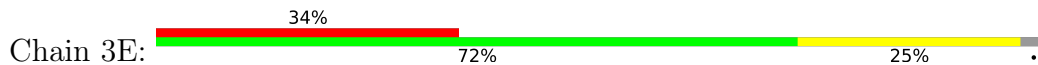

• Molecule 1: Tubulin alpha-1B chain

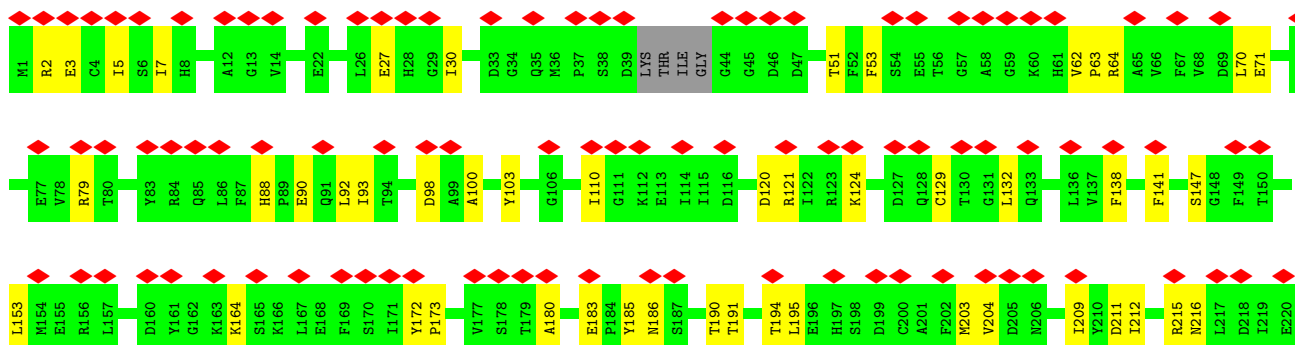
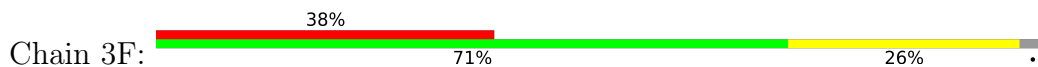

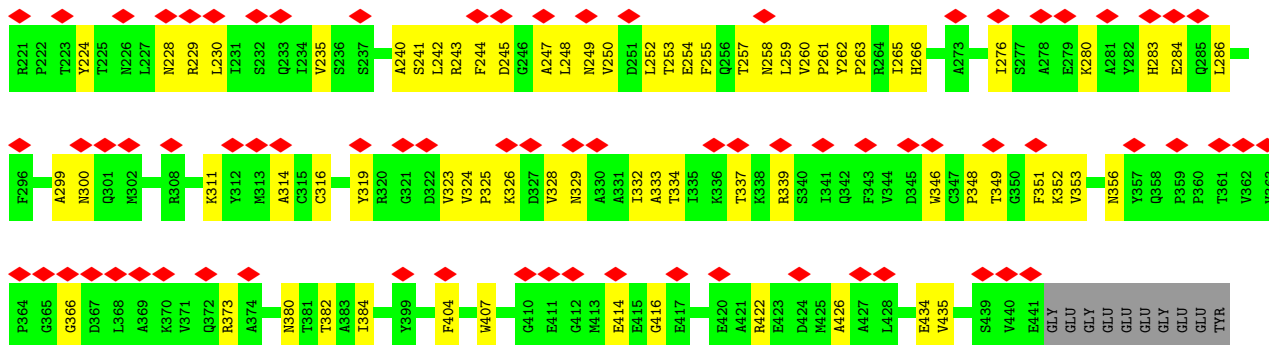

• Molecule 1: Tubulin alpha-1B chain

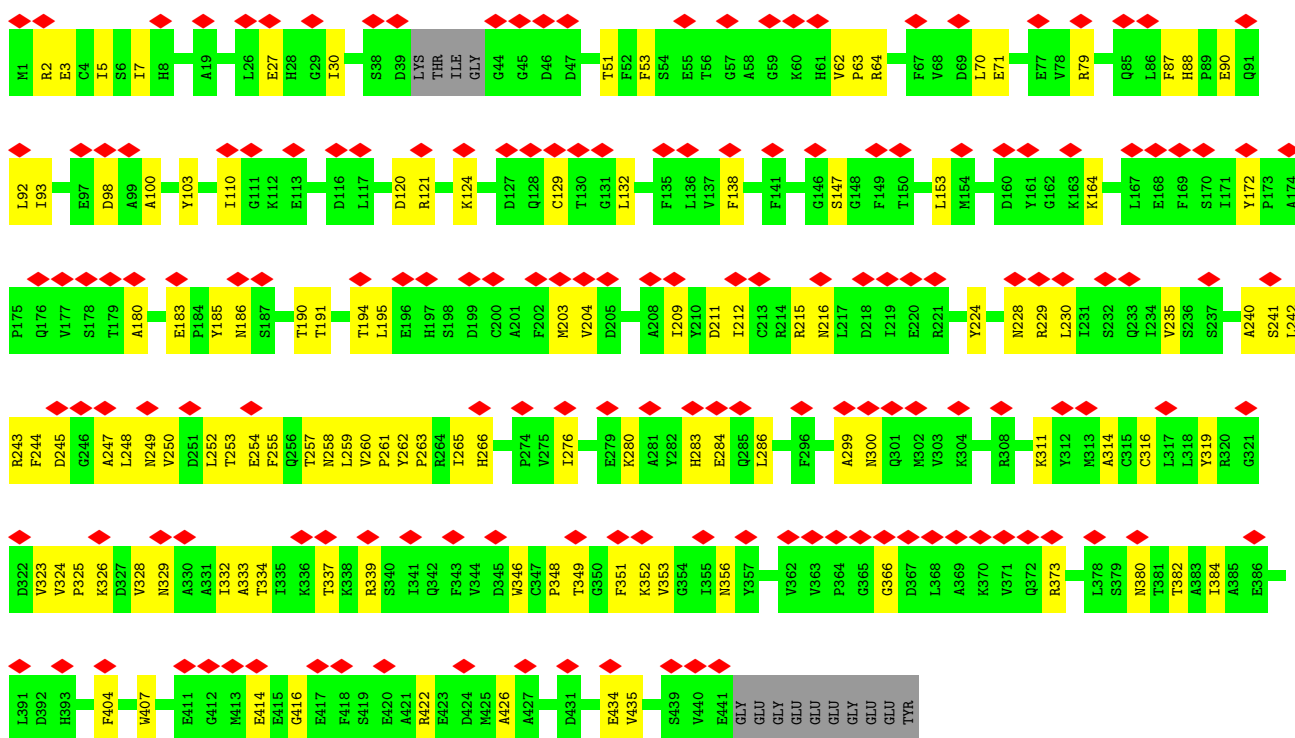
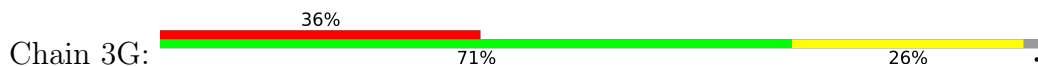

• Molecule 1: Tubulin alpha-1B chain

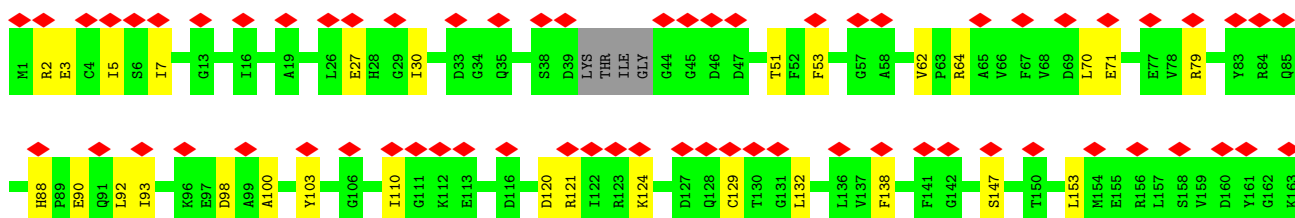

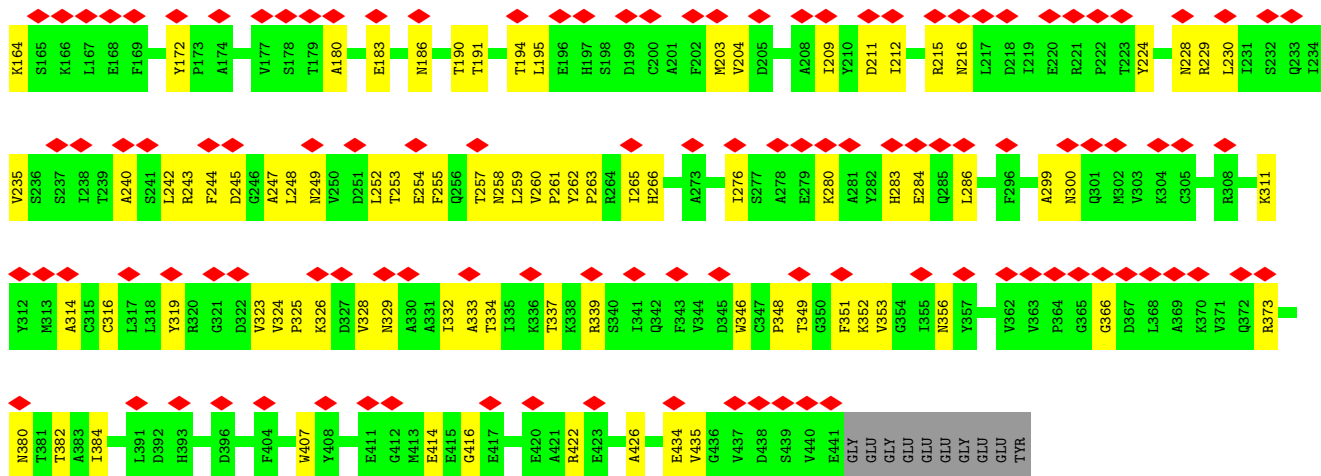

• Molecule 1: Tubulin alpha-1B chain

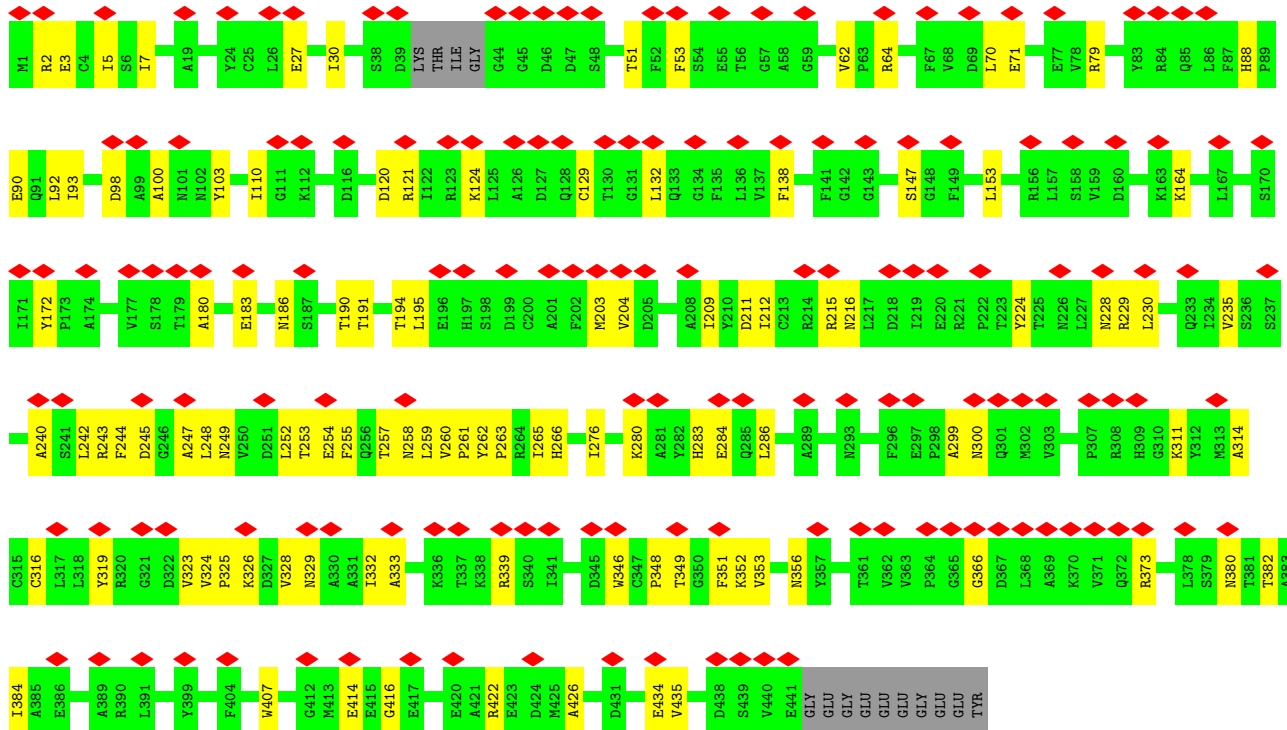
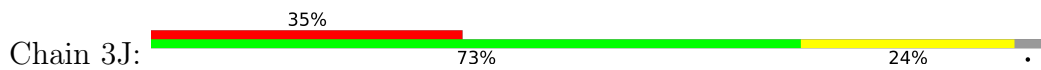

• Molecule 1: Tubulin alpha-1B chain

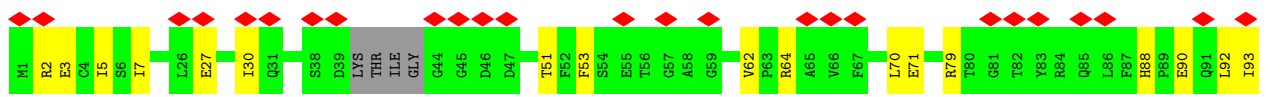
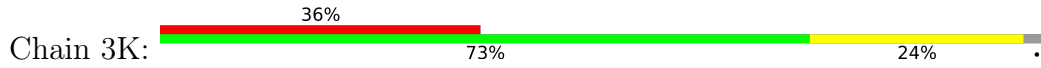



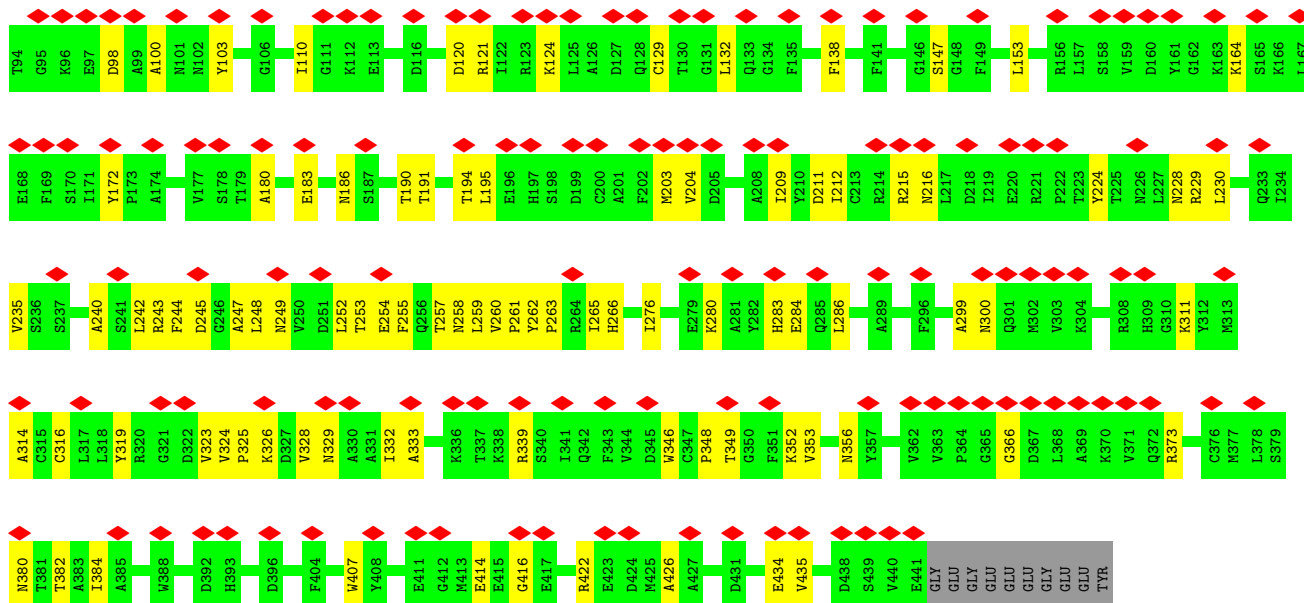

• Molecule 1: Tubulin alpha-1B chain

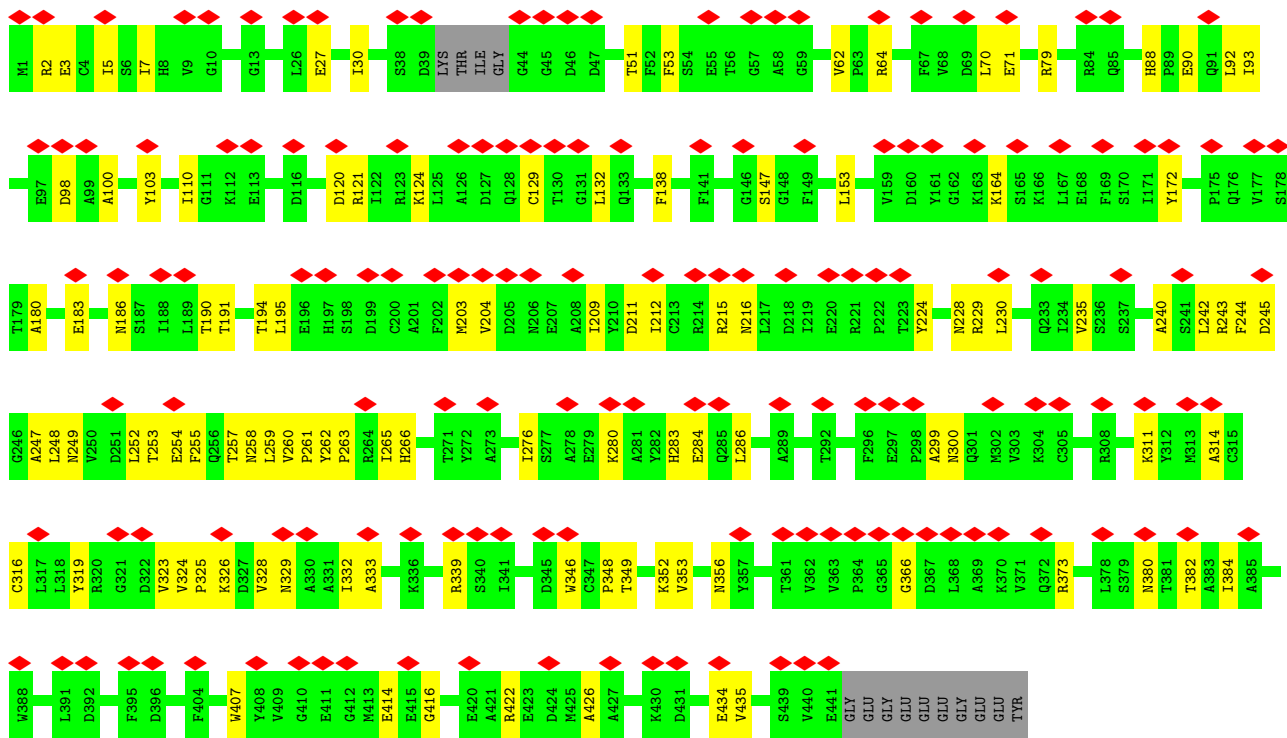
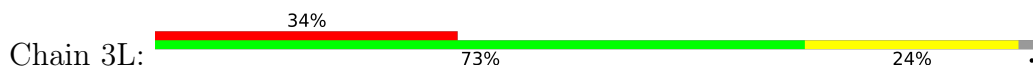

• Molecule 1: Tubulin alpha-1B chain

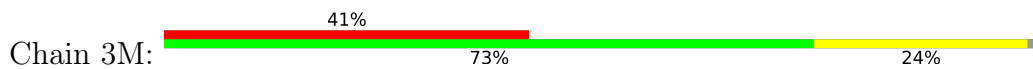

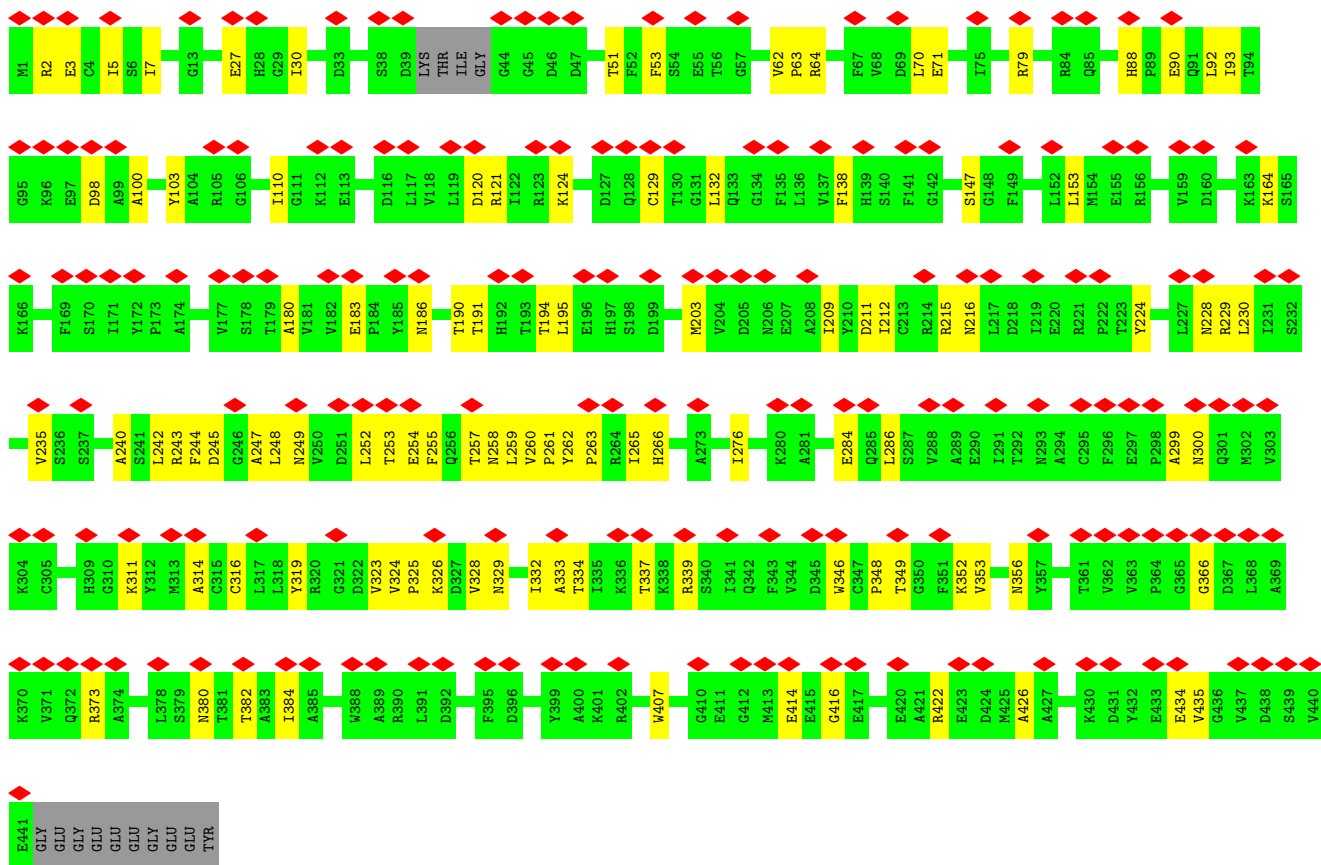

• Molecule 1: Tubulin alpha-1B chain

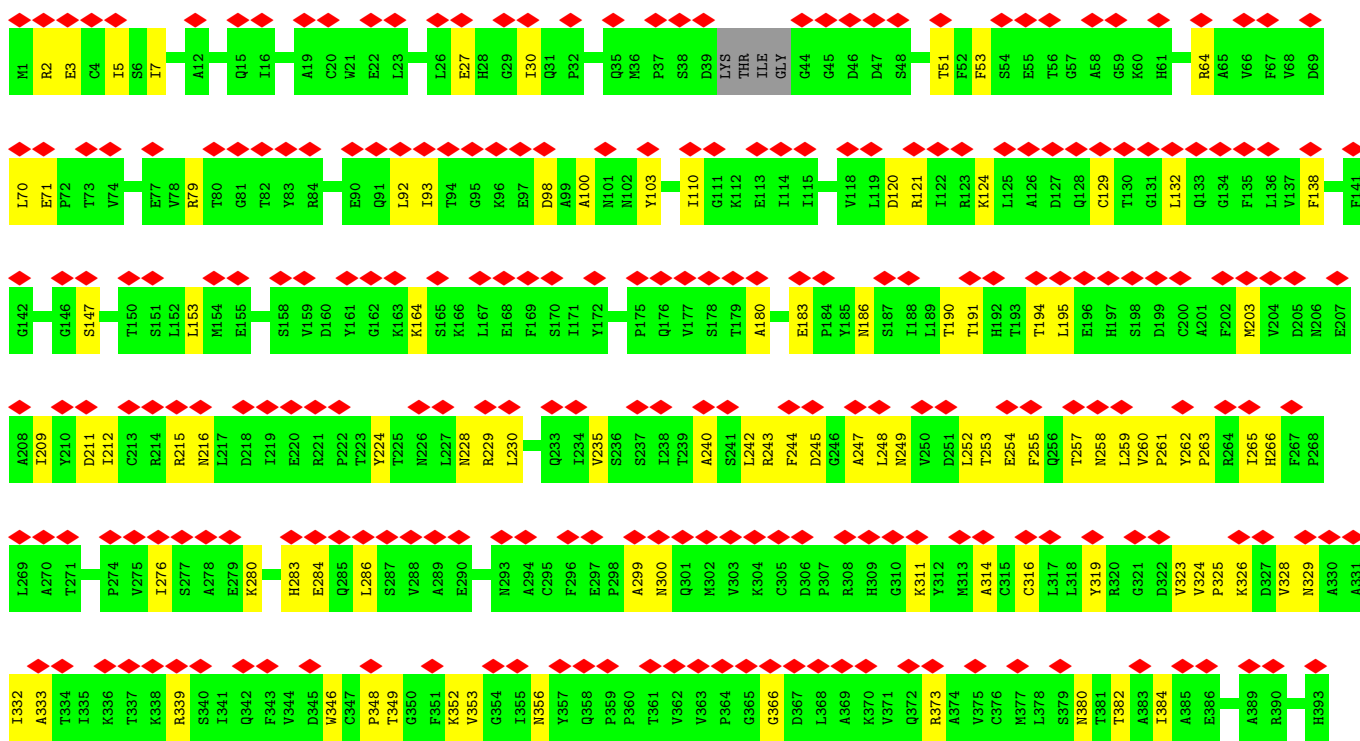
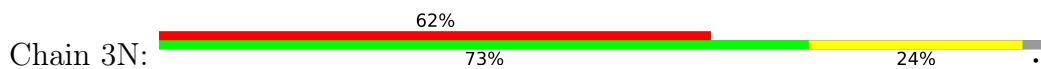

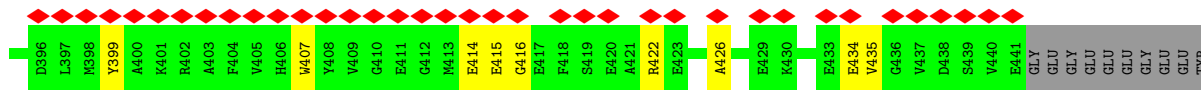

• Molecule 1: Tubulin alpha-1B chain

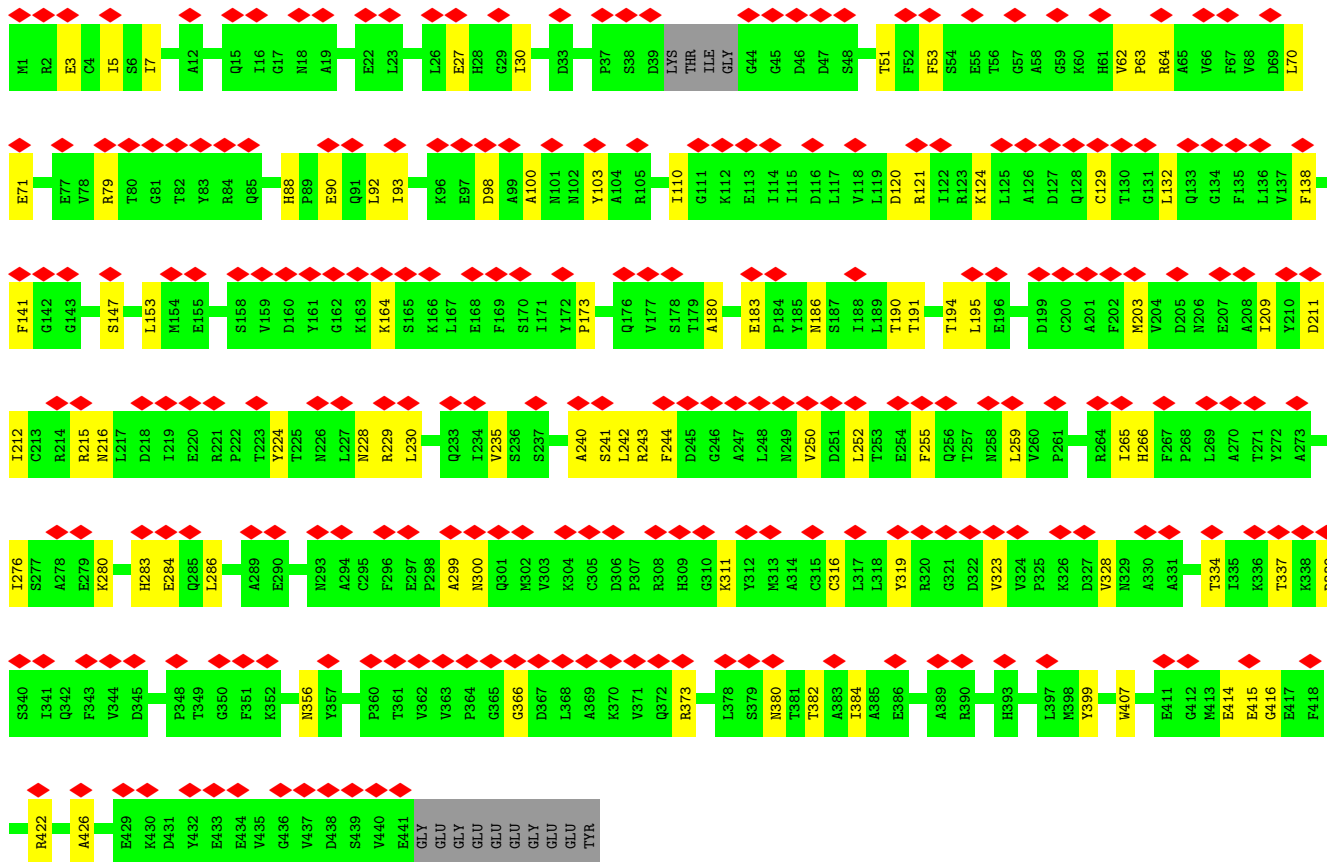
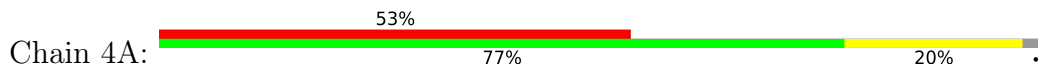

• Molecule 1: Tubulin alpha-1B chain

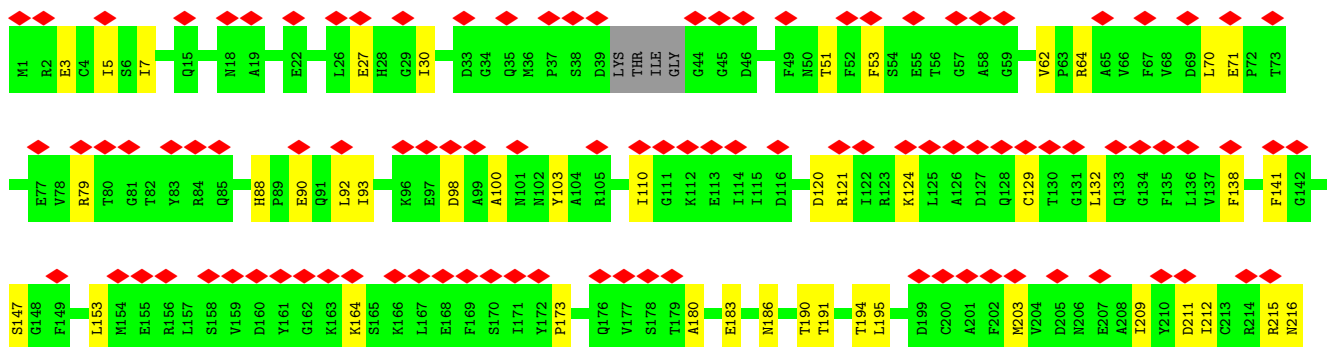
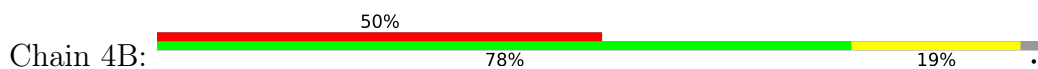

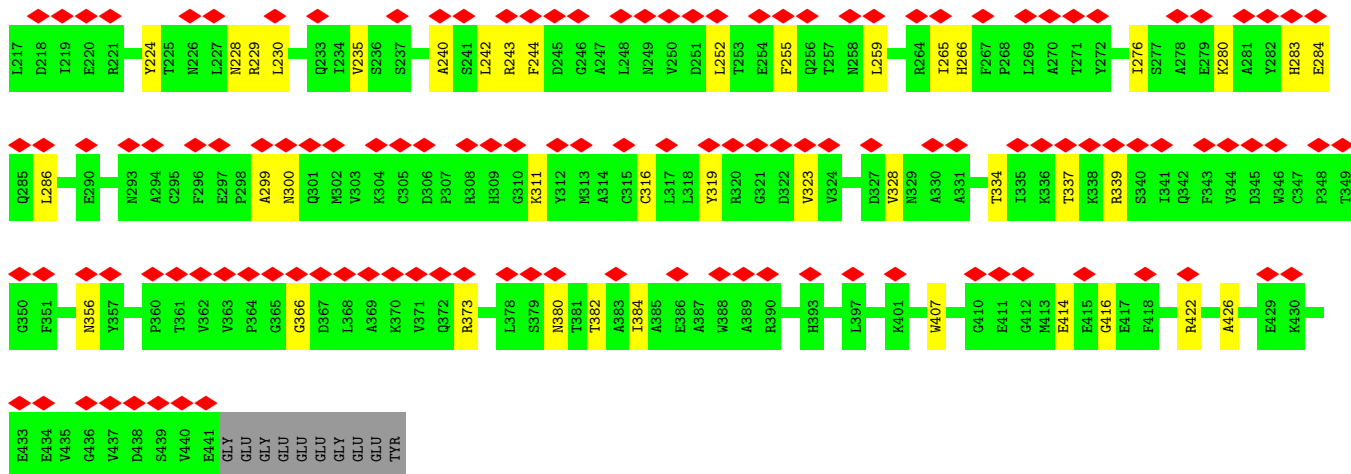

• Molecule 1: Tubulin alpha-1B chain

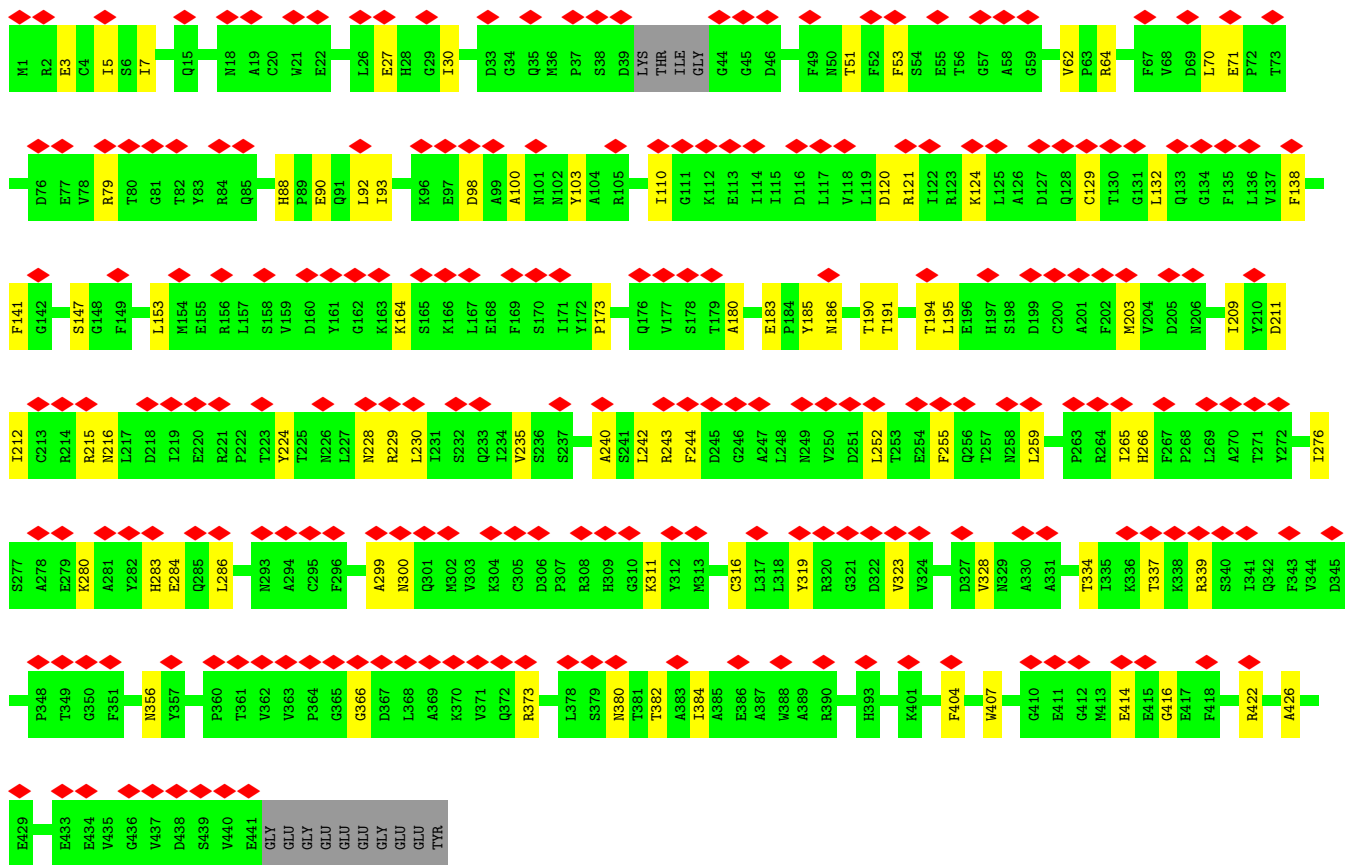
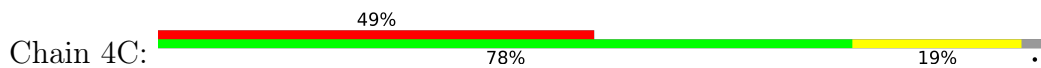

• Molecule 1: Tubulin alpha-1B chain

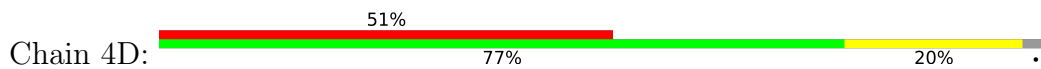





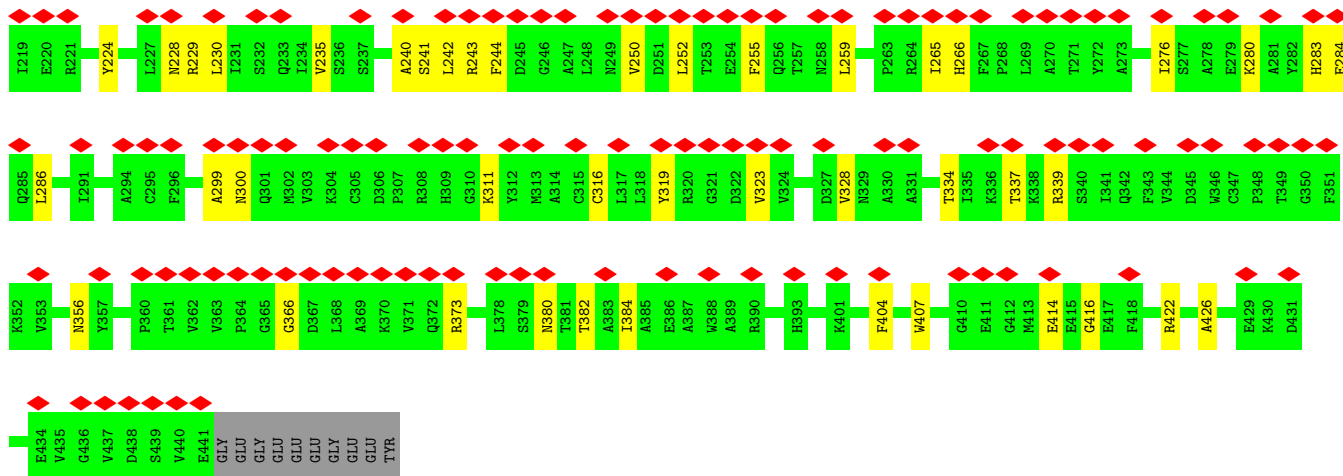

• Molecule 1: Tubulin alpha-1B chain

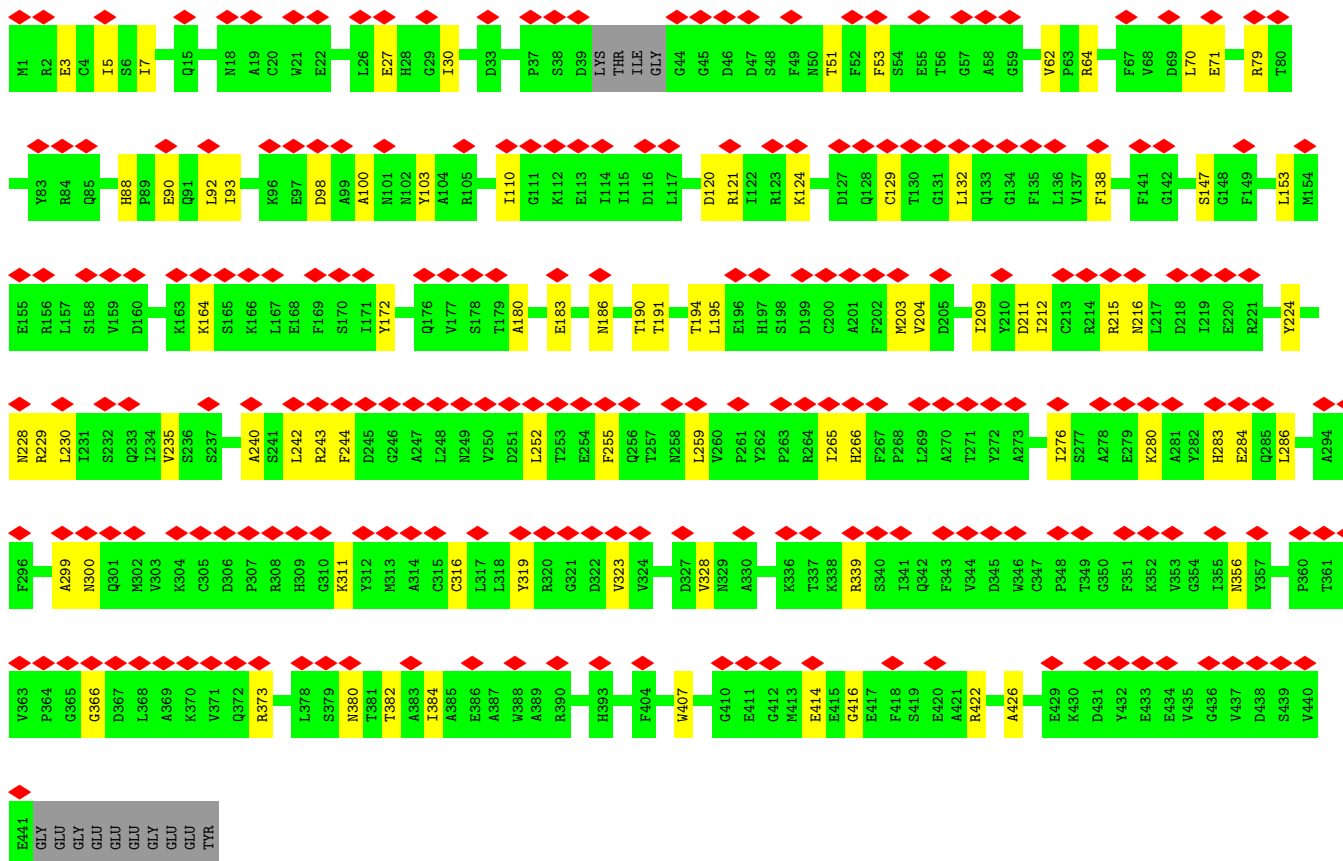
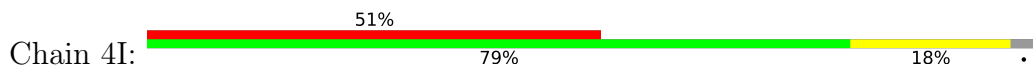

• Molecule 1: Tubulin alpha-1B chain

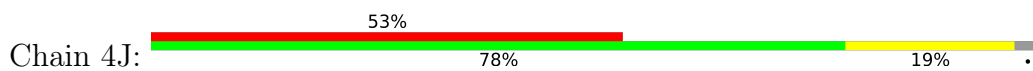

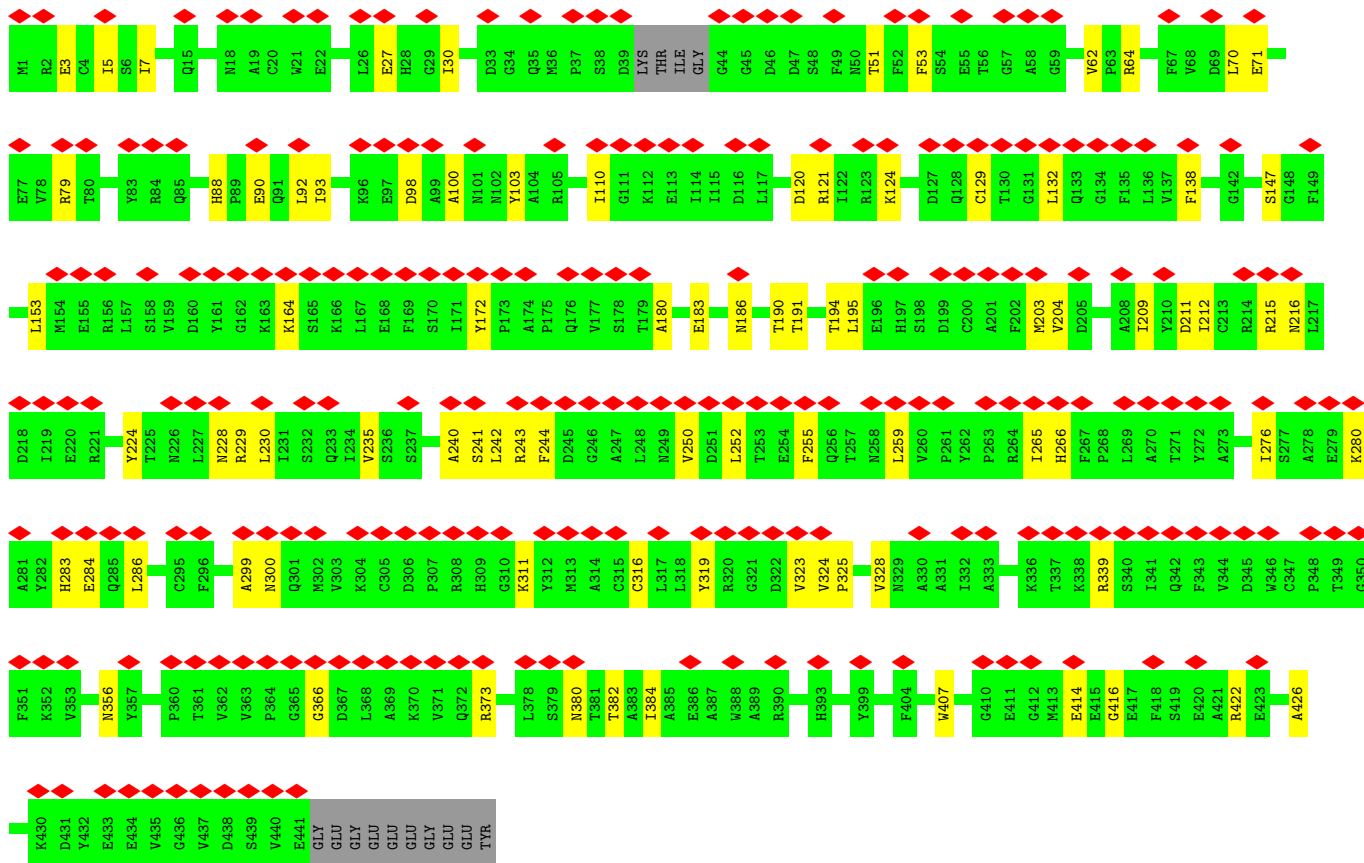

• Molecule 1: Tubulin alpha-1B chain

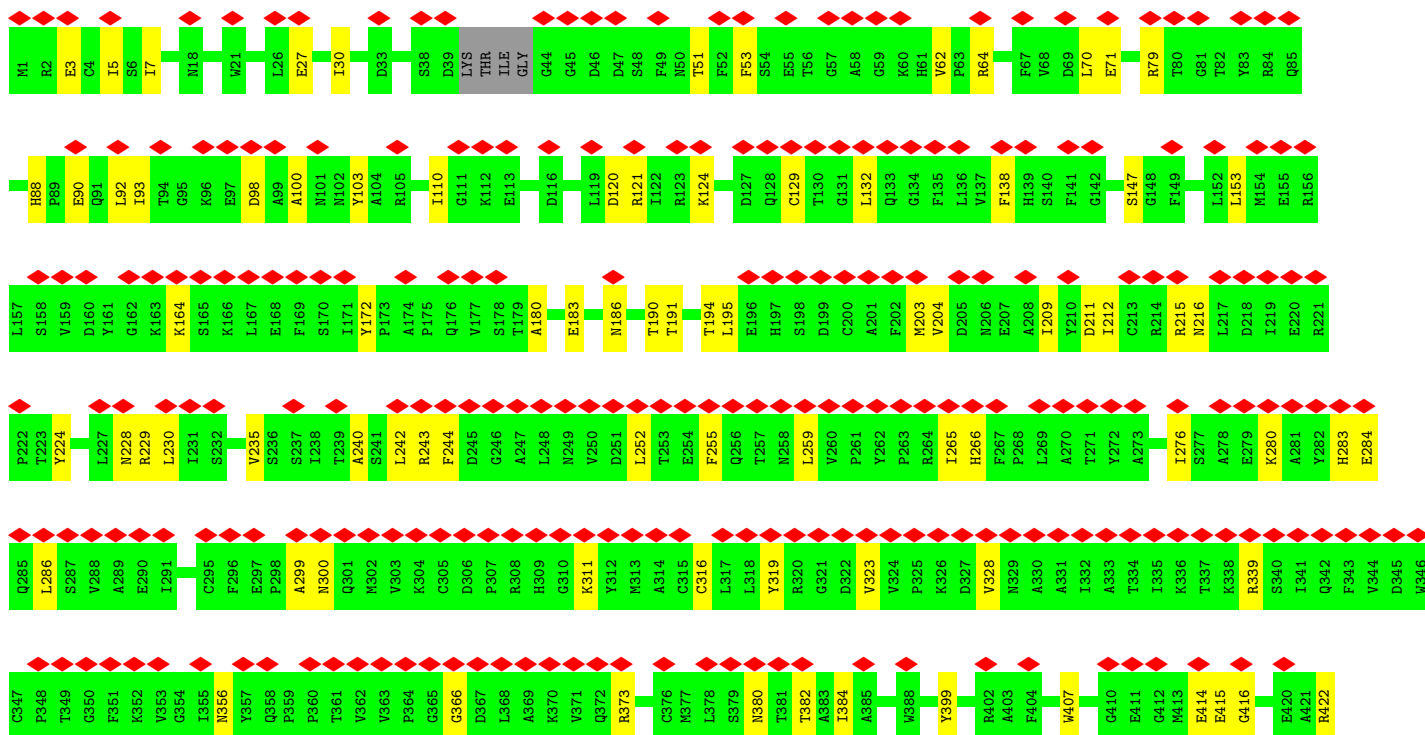
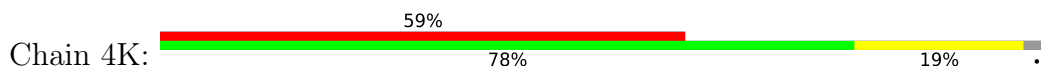



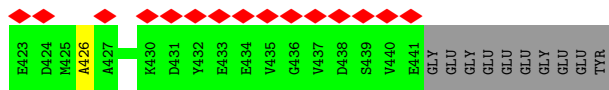

• Molecule 1: Tubulin alpha-1B chain

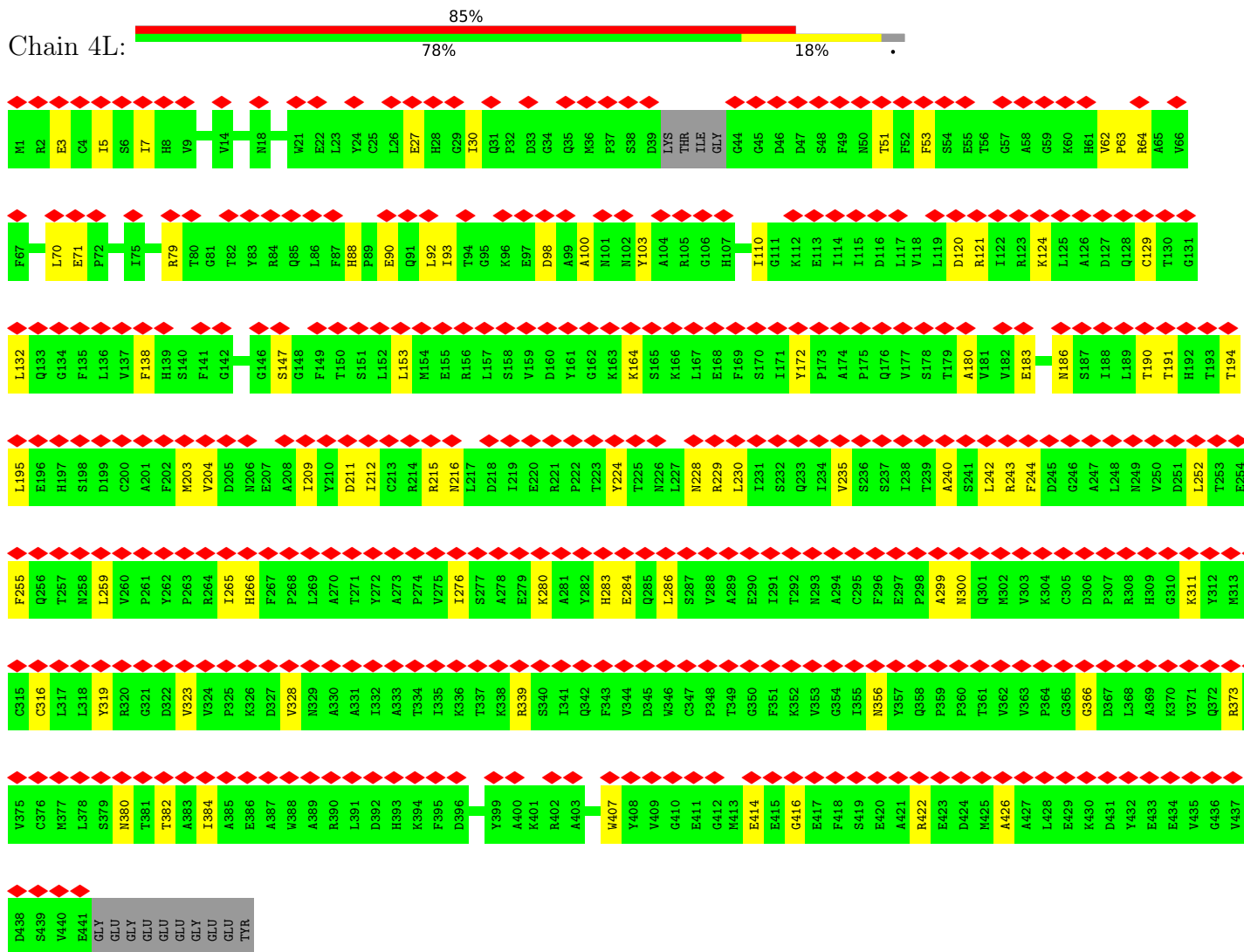

• Molecule 1: Tubulin alpha-1B chain

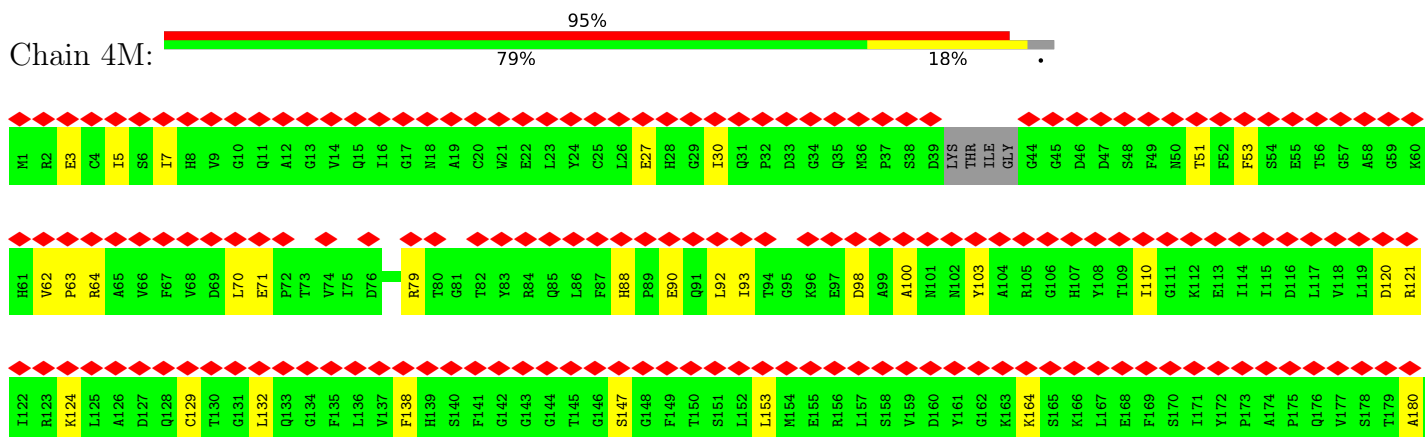

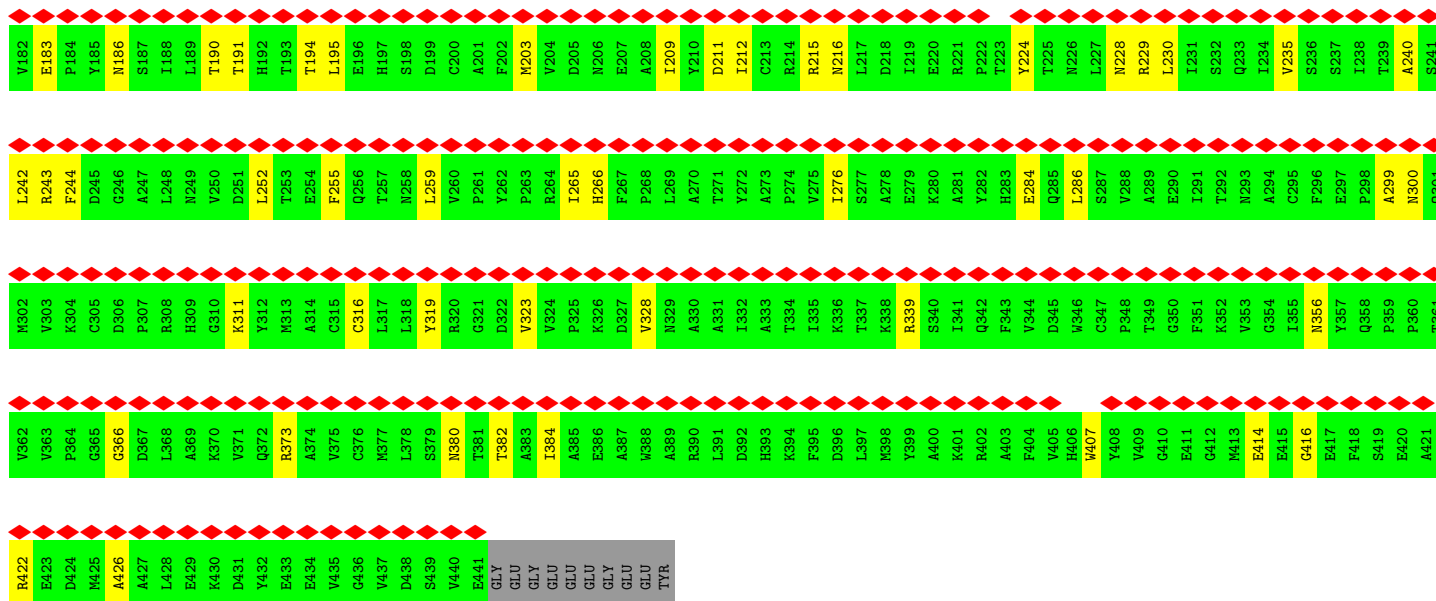

• Molecule 1: Tubulin alpha-1B chain

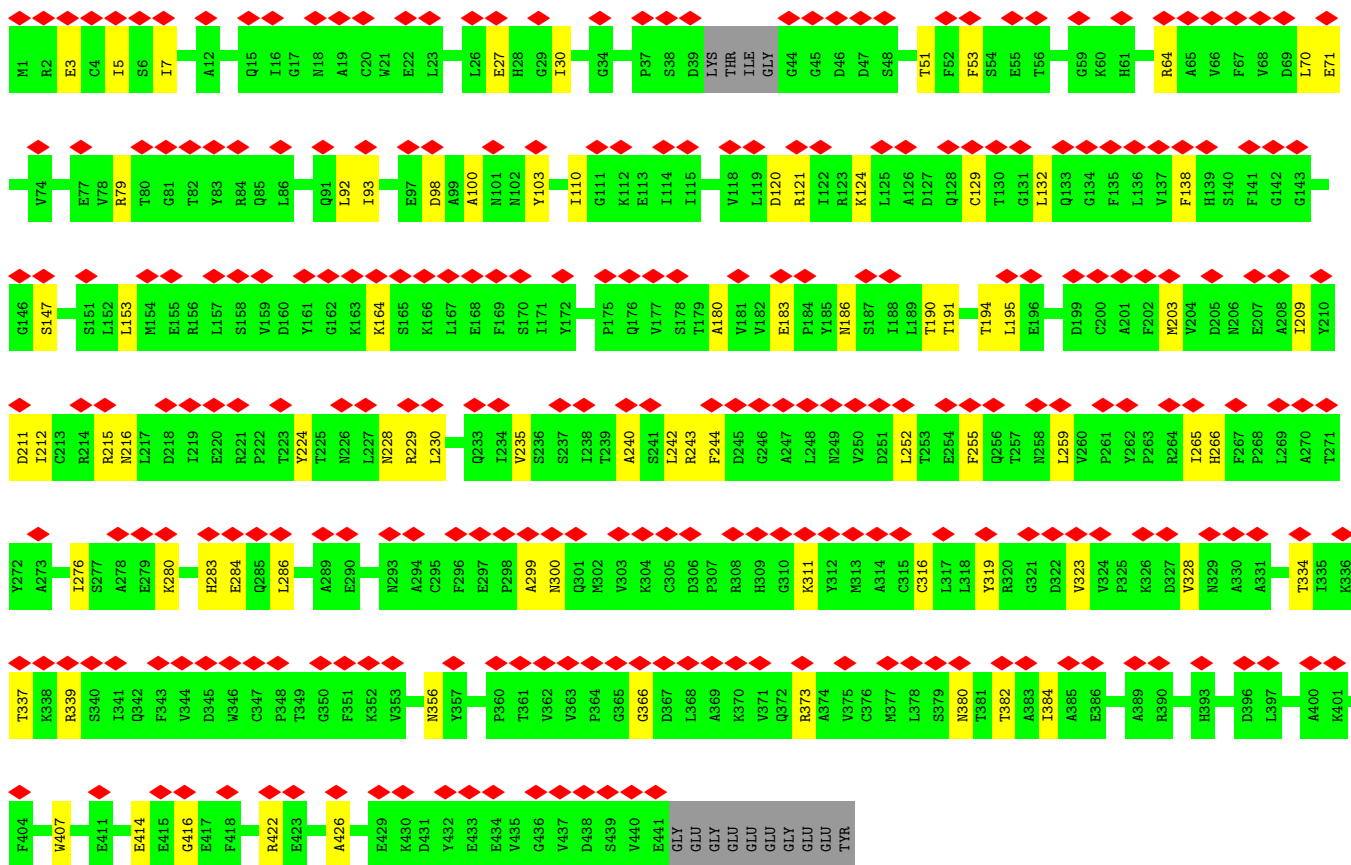
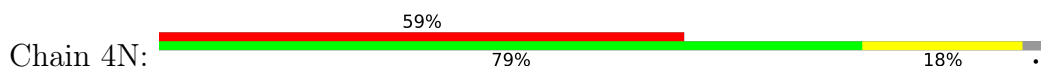

• Molecule 2: Tubulin beta chain

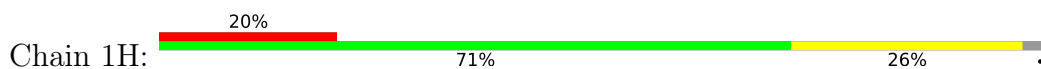

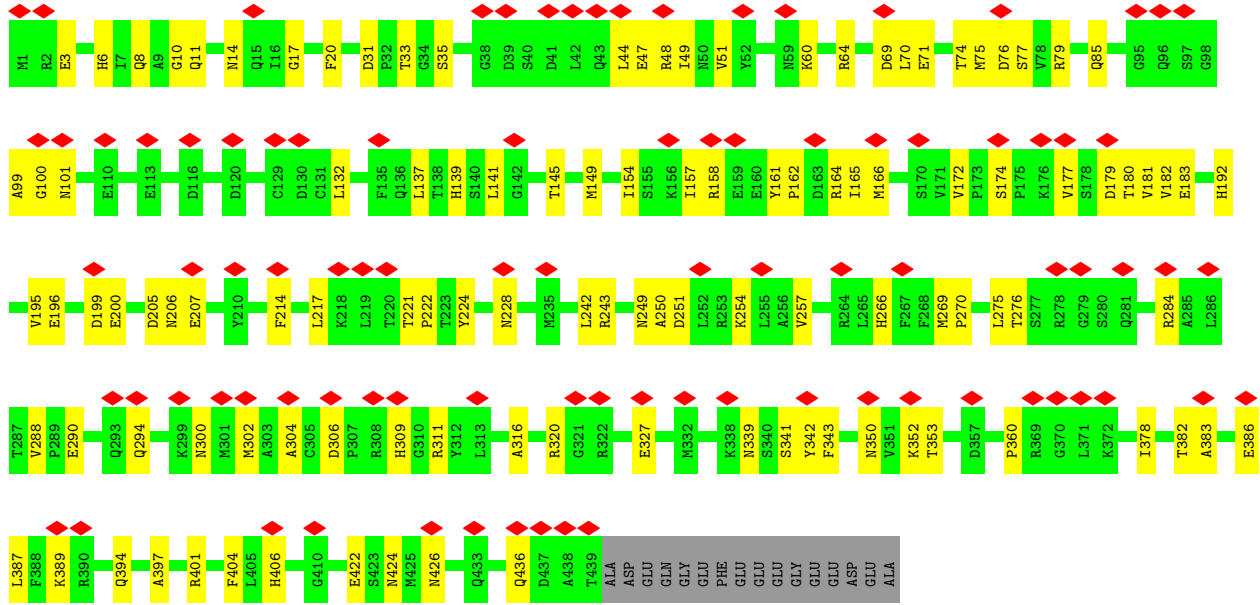

• Molecule 2: Tubulin beta chain

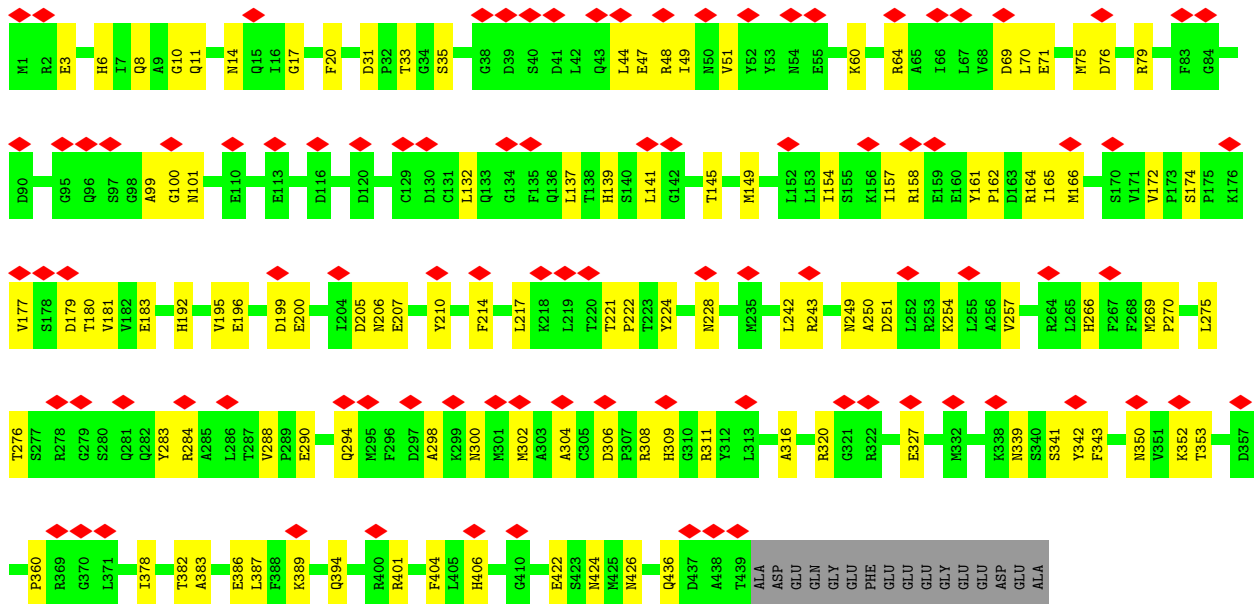
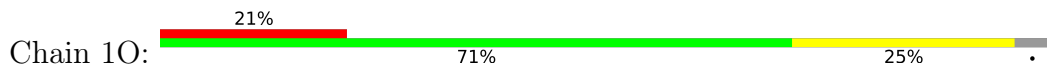

• Molecule 2: Tubulin beta chain

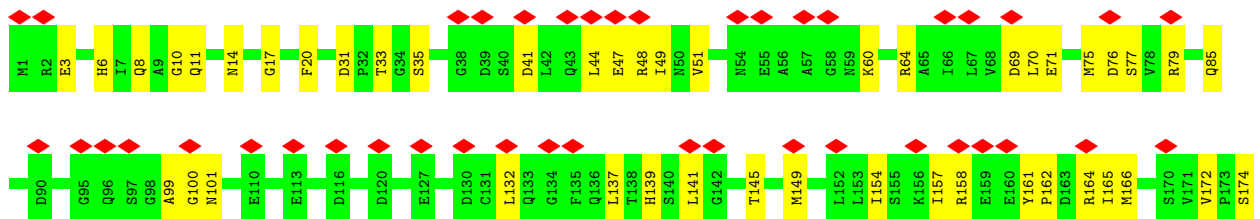

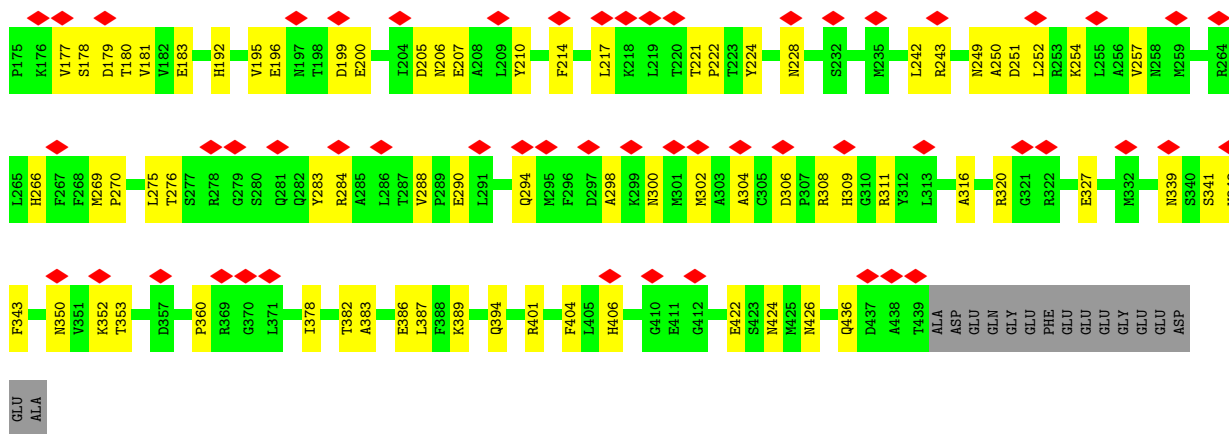

• Molecule 2: Tubulin beta chain

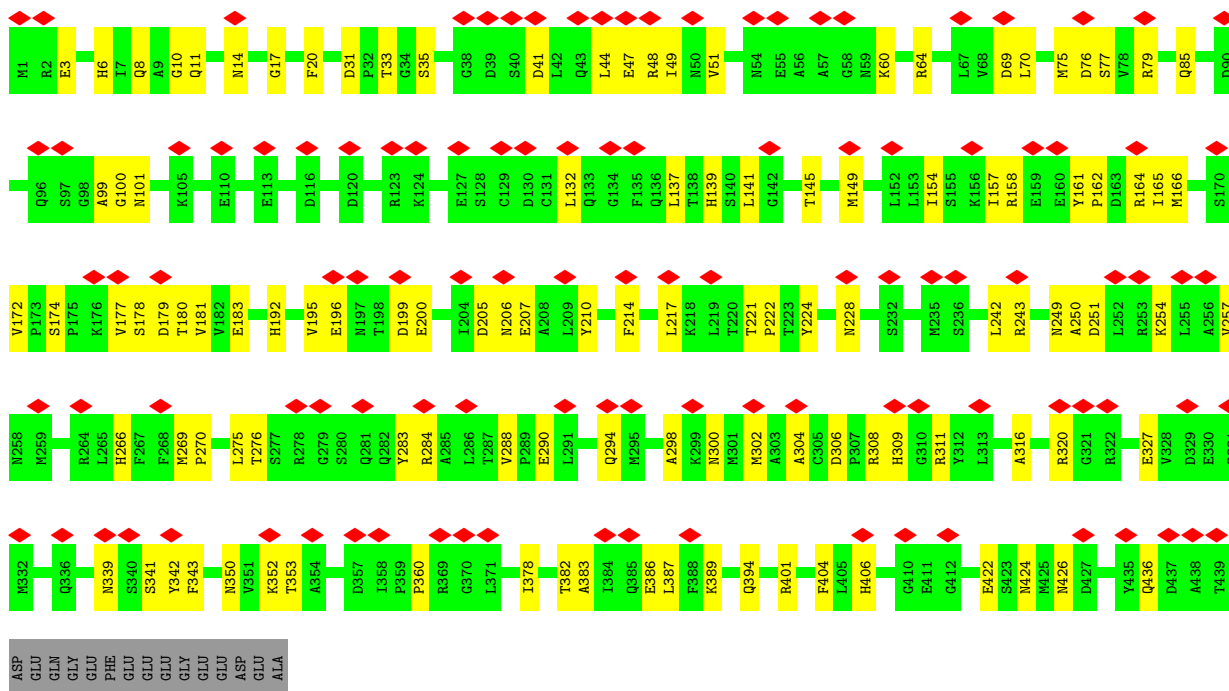

• Molecule 2: Tubulin beta chain

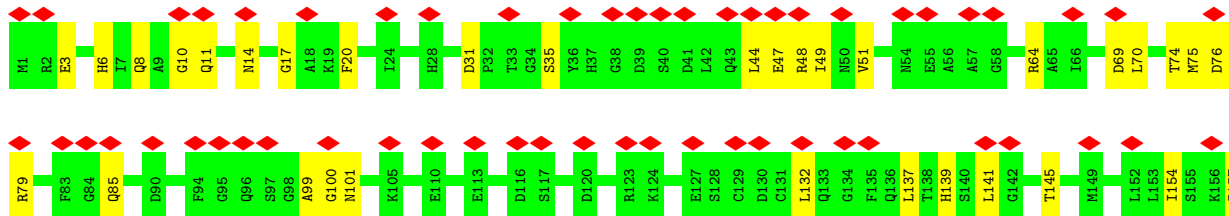
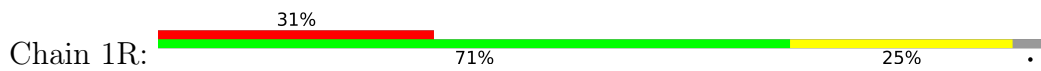



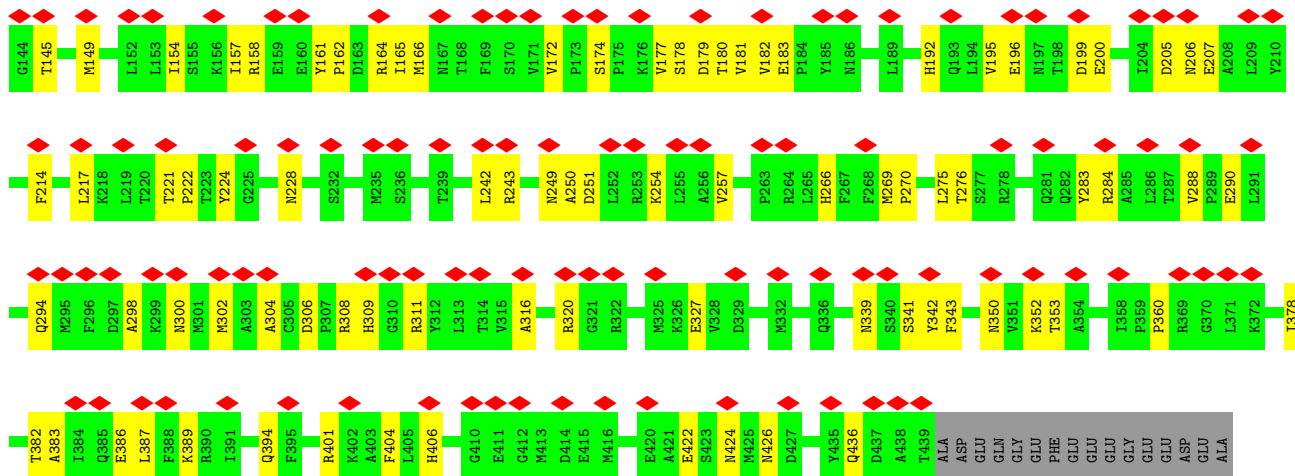

• Molecule 2: Tubulin beta chain

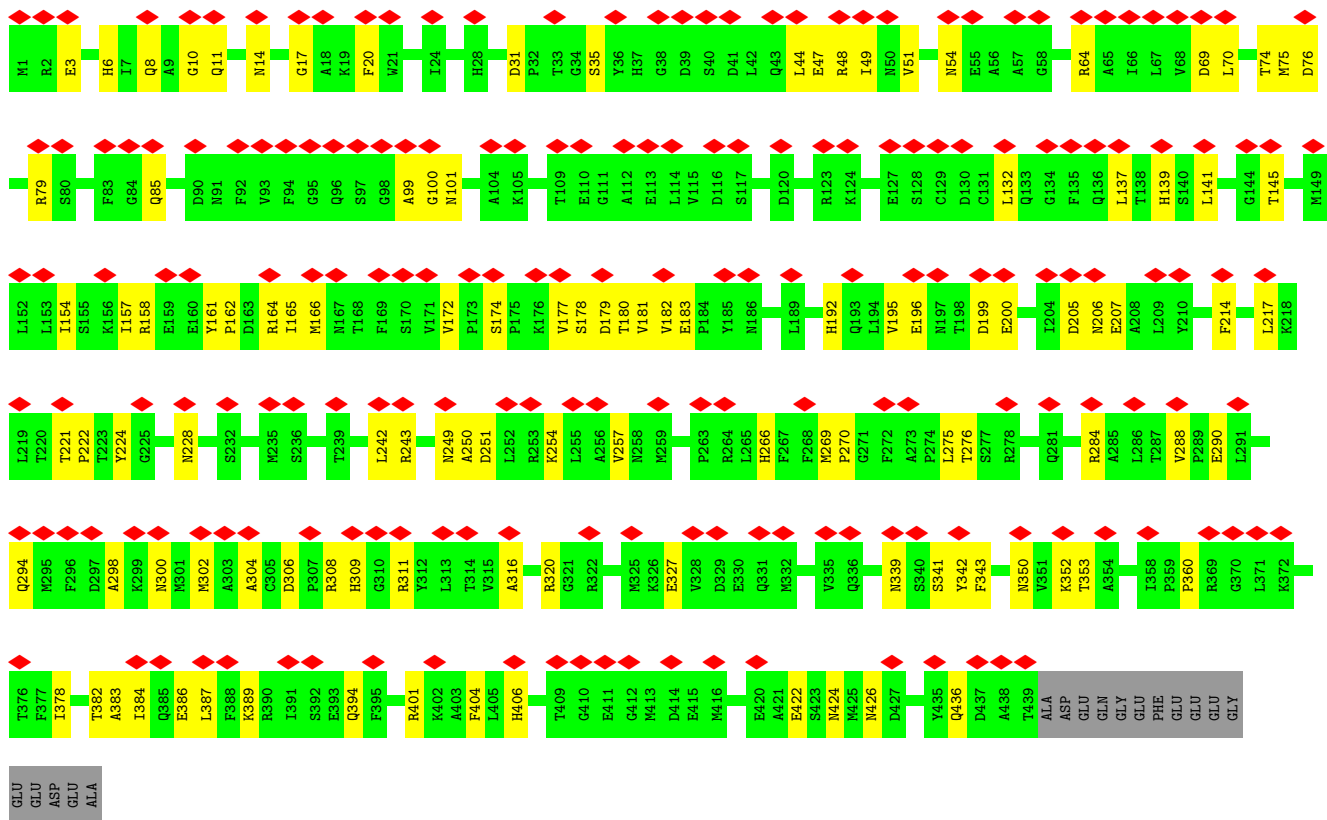
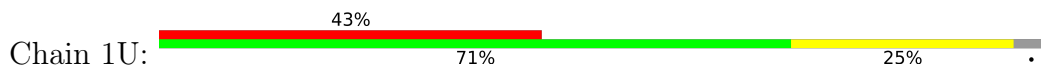

• Molecule 2: Tubulin beta chain

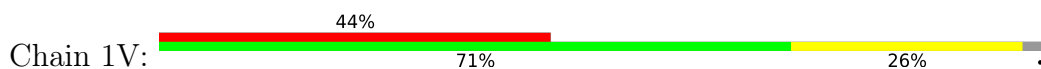

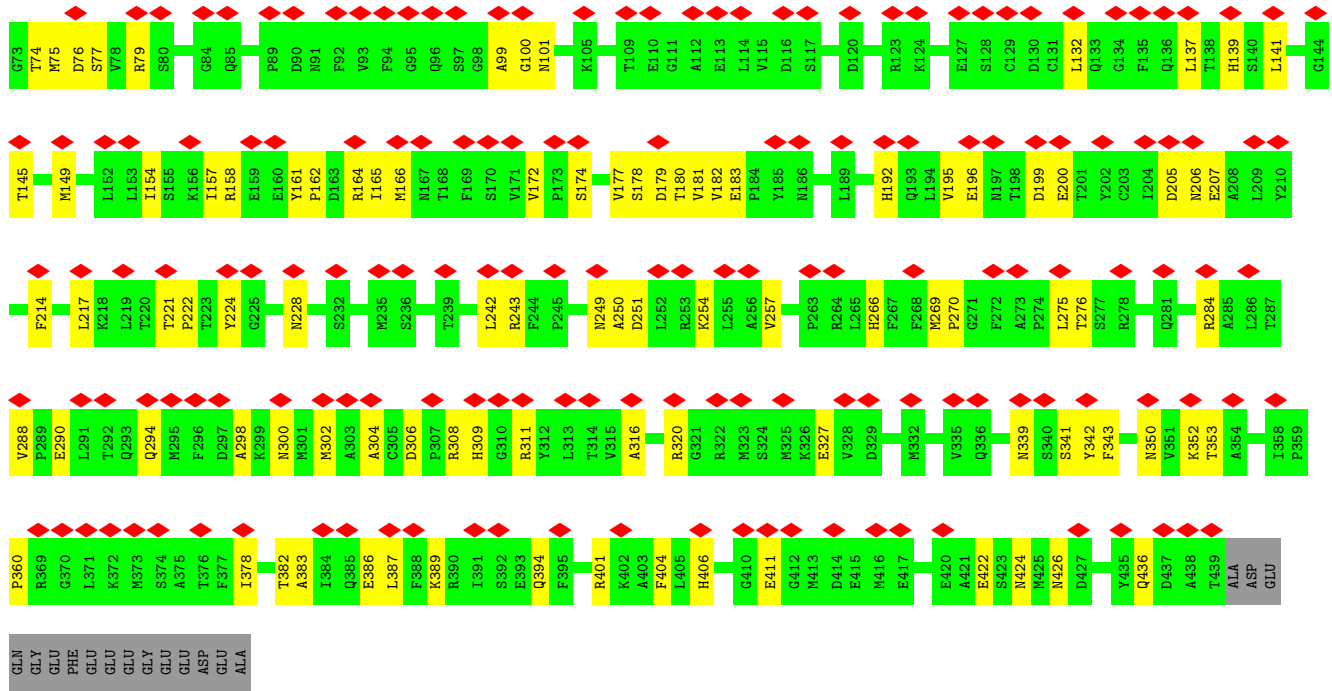

• Molecule 2: Tubulin beta chain

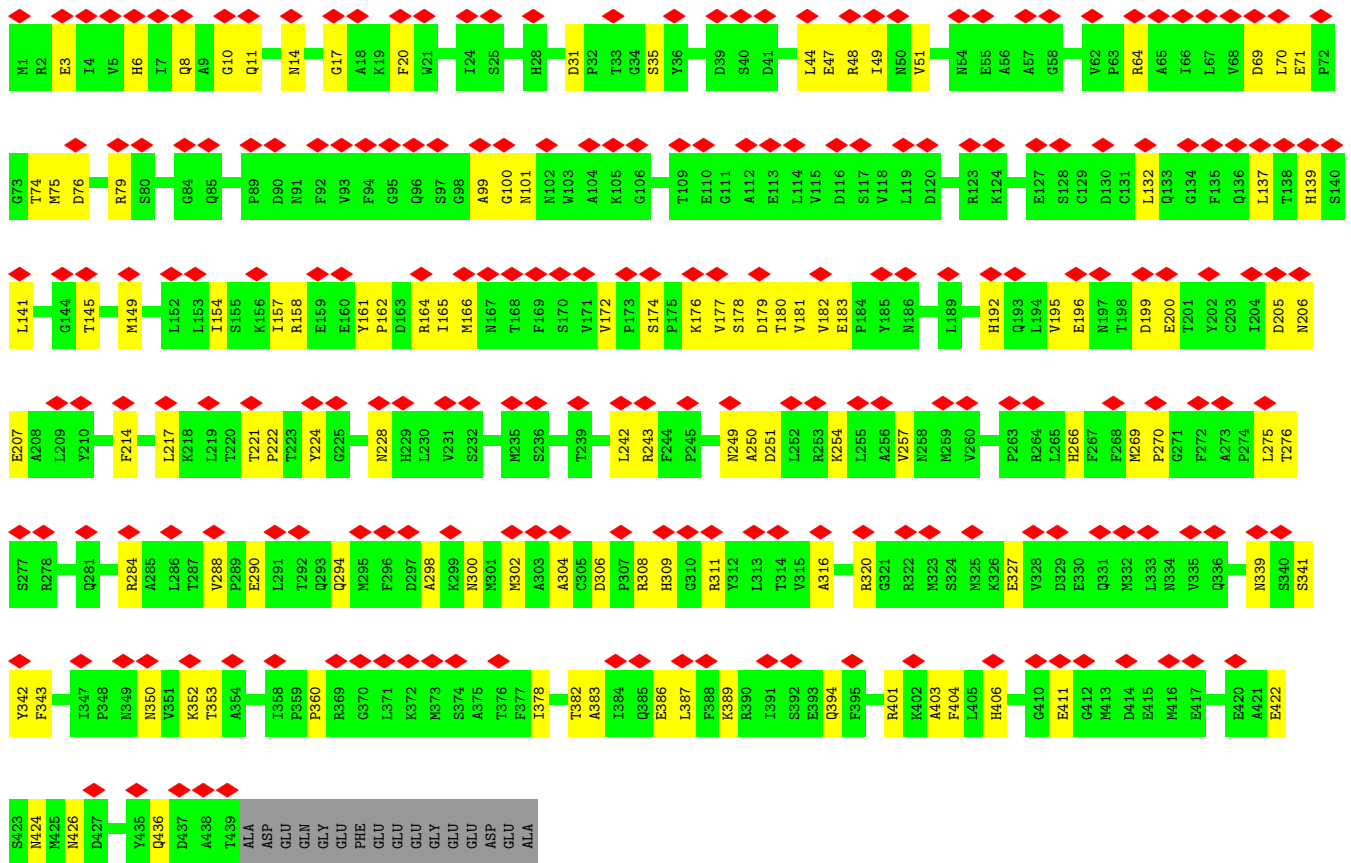
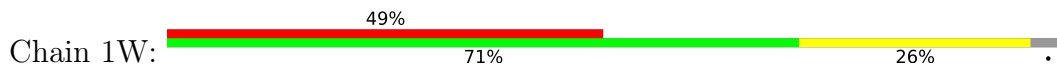

• Molecule 2: Tubulin beta chain

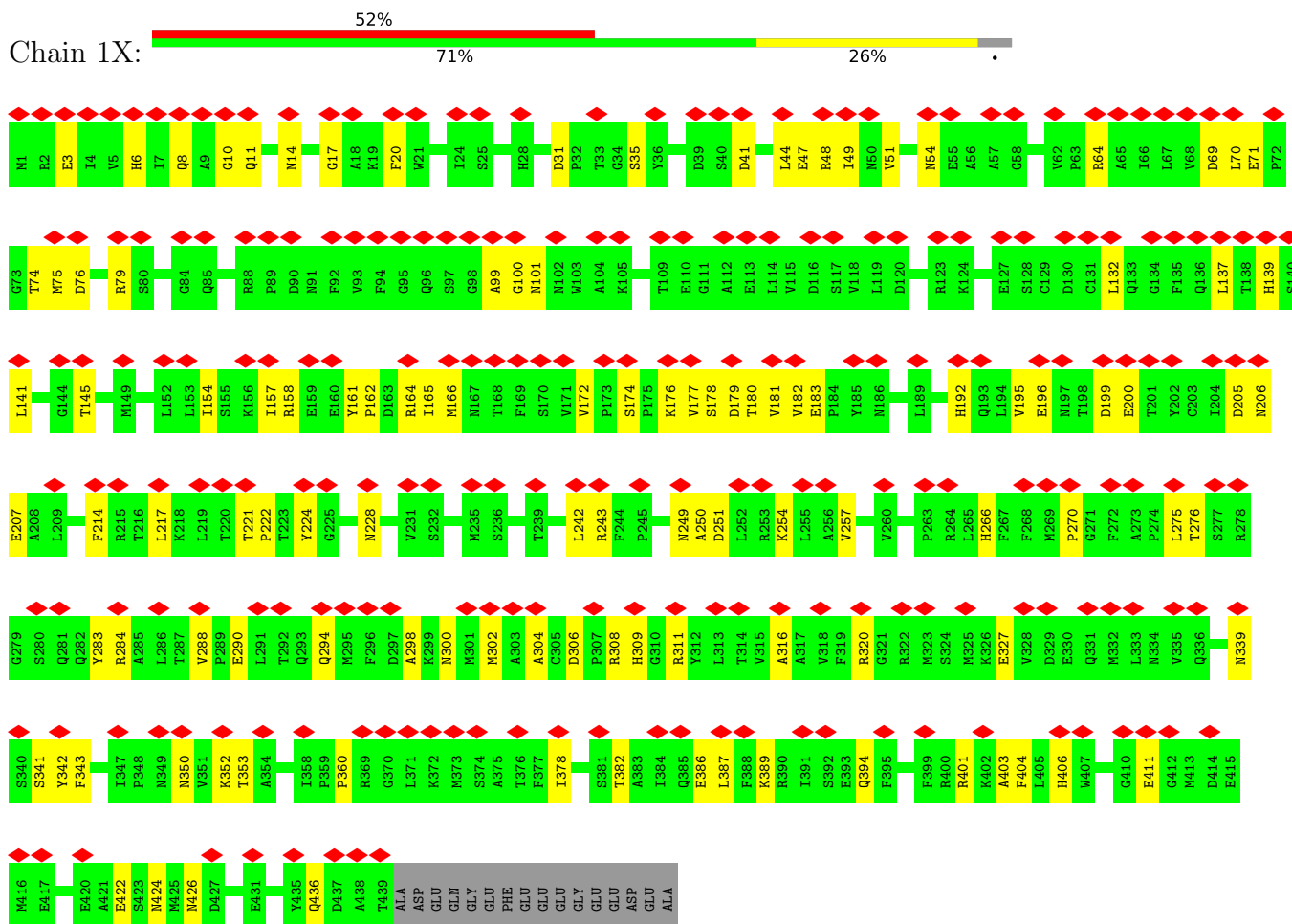

• Molecule 2: Tubulin beta chain

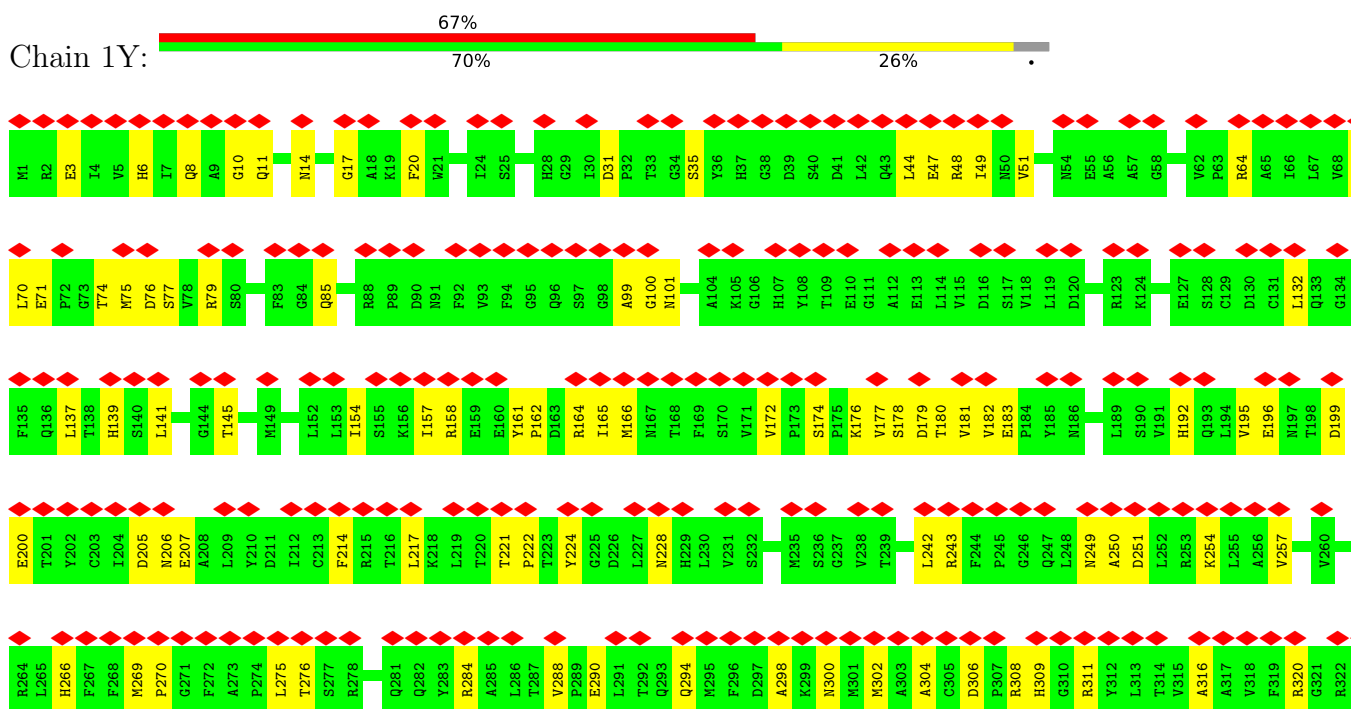



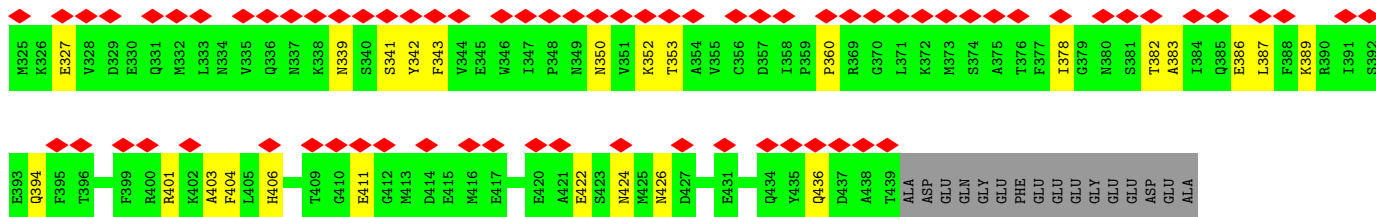

• Molecule 2: Tubulin beta chain

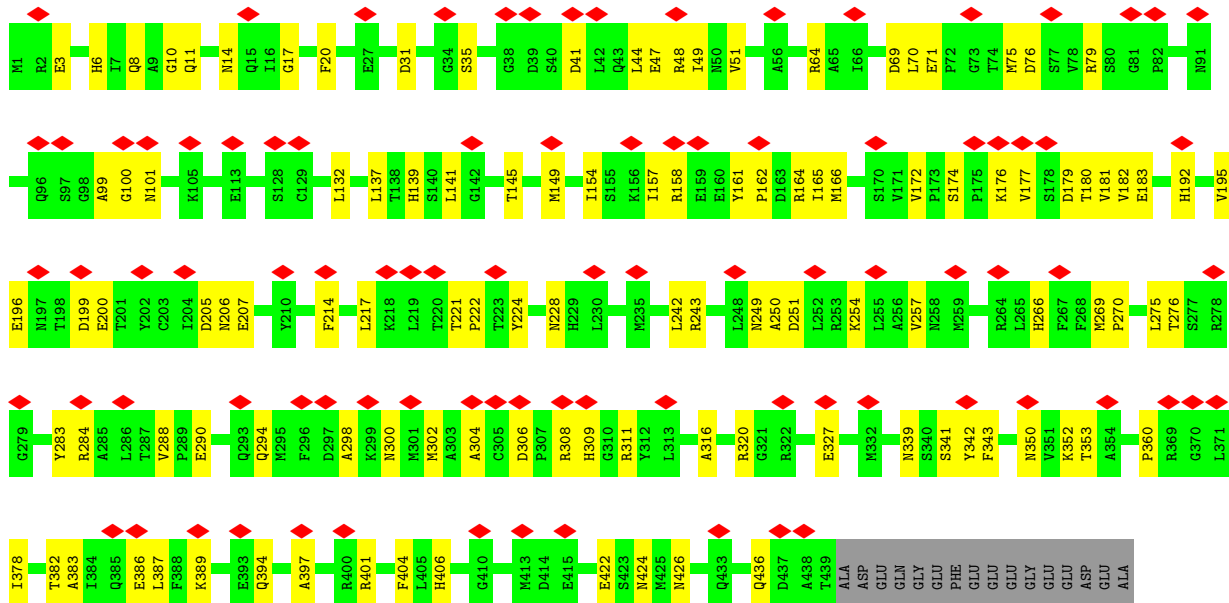

• Molecule 2: Tubulin beta chain

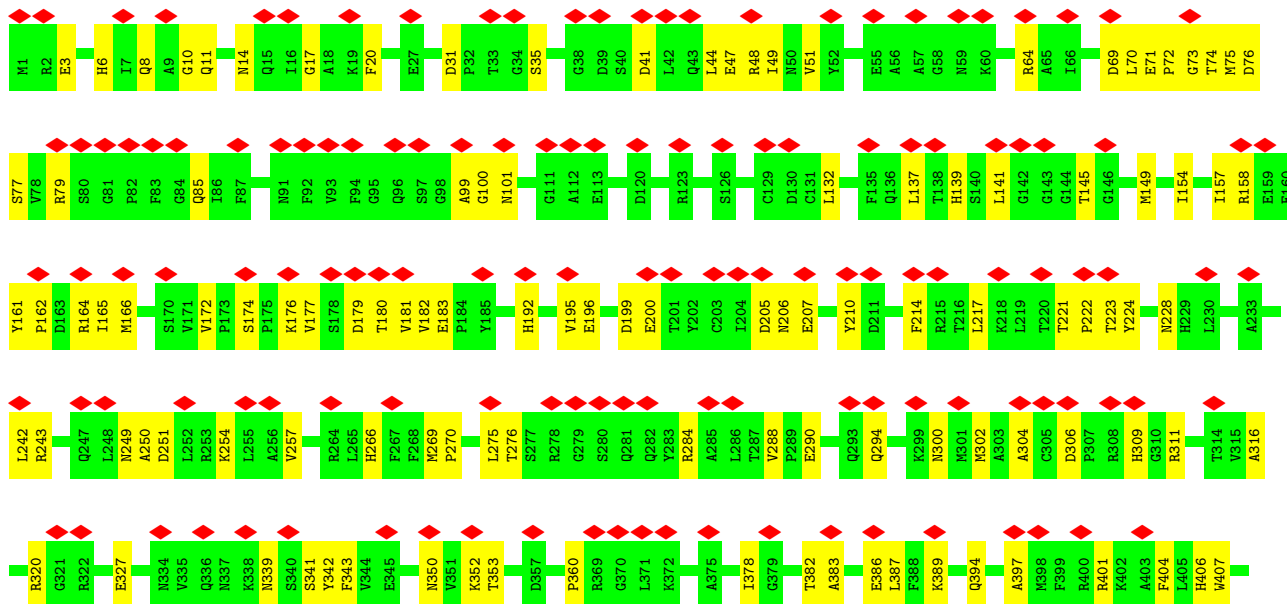



GLU  
PHE  
GLU  
GLU  
GLU  
GLY  
GLU  
GLU  
ASP  
GLU  
ALA

• Molecule 2: Tubulin beta chain



• Molecule 2: Tubulin beta chain

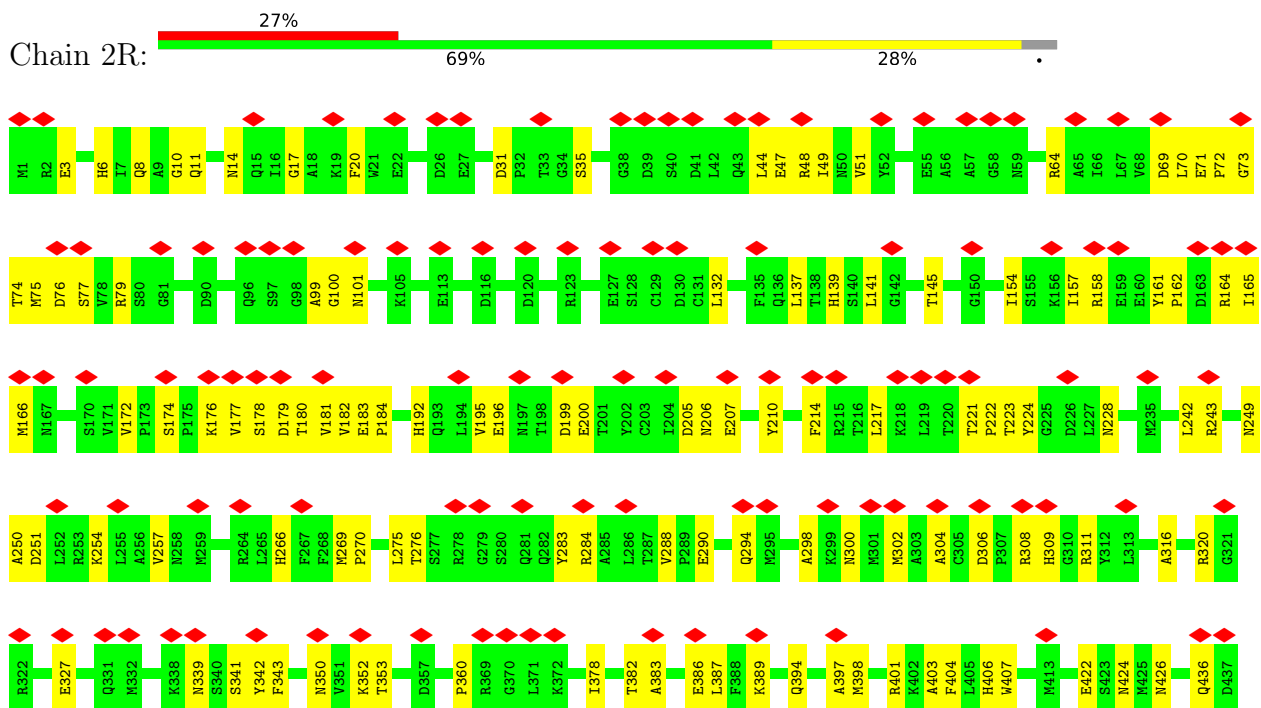

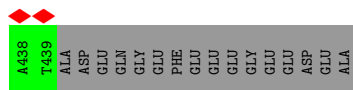

• Molecule 2: Tubulin beta chain

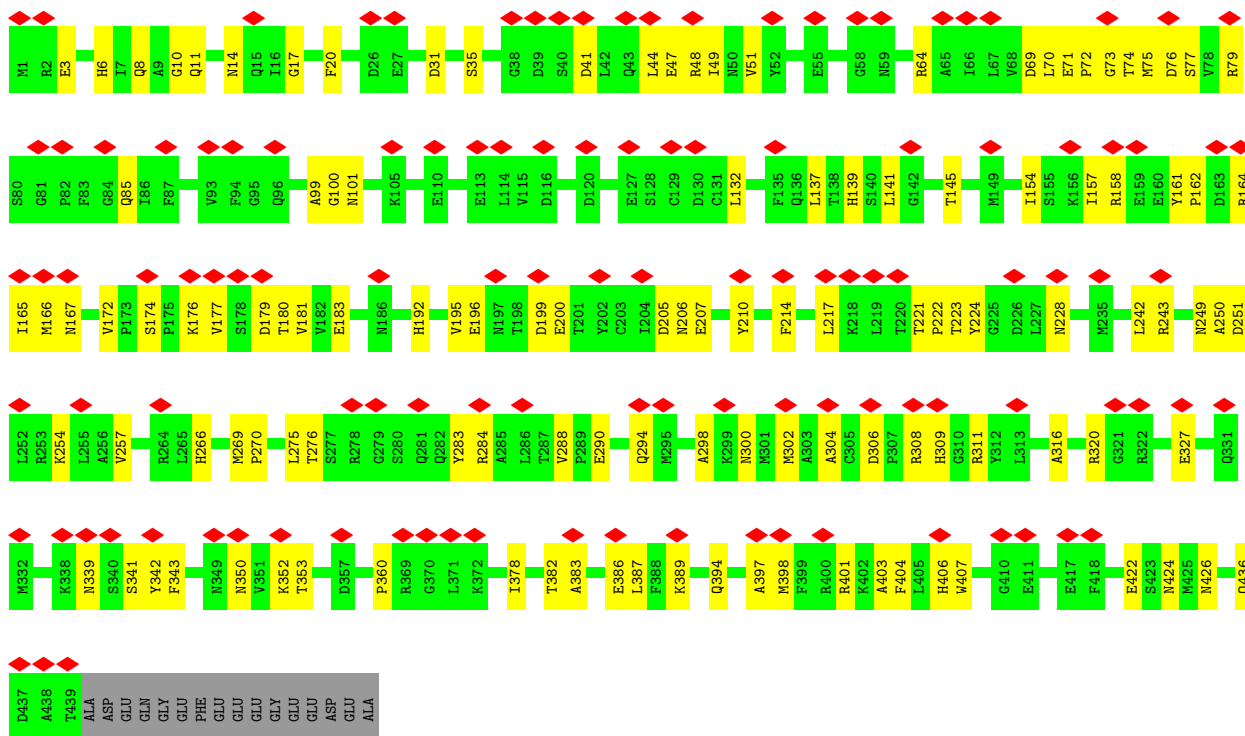

• Molecule 2: Tubulin beta chain

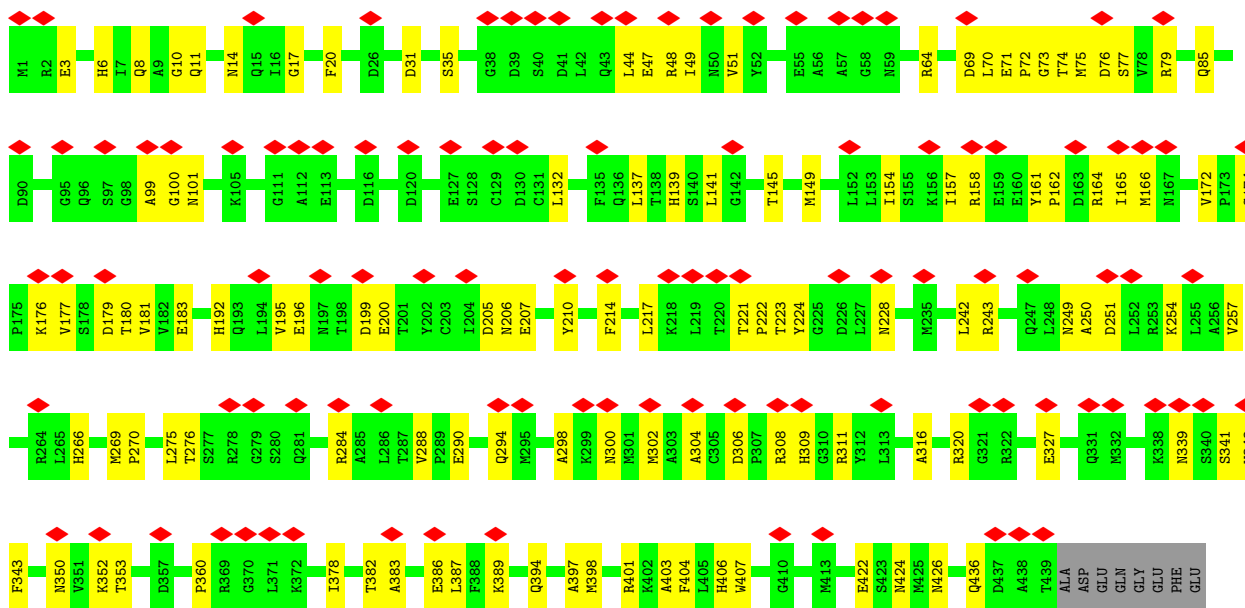

GLU  
GLU  
GLY  
GLU  
ASP  
GLU  
GLU  
ALA

• Molecule 2: Tubulin beta chain

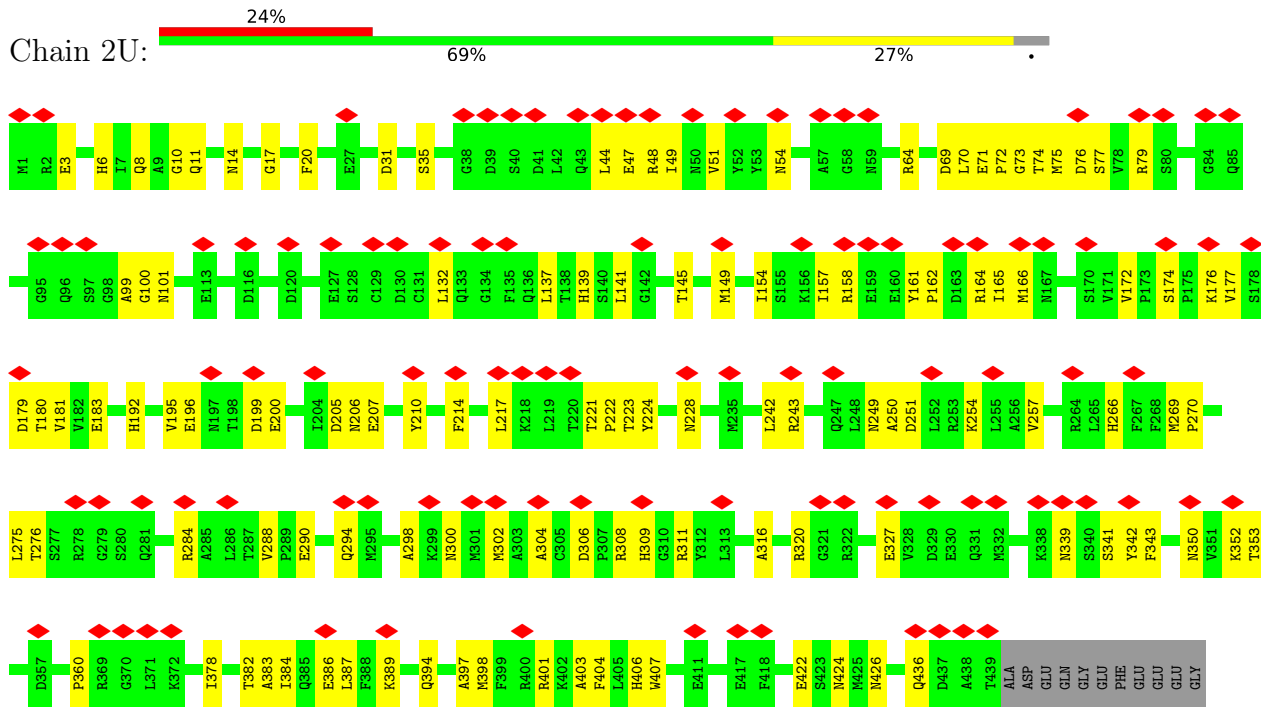

GLU  
GLU  
ASP  
GLU  
ALA

• Molecule 2: Tubulin beta chain

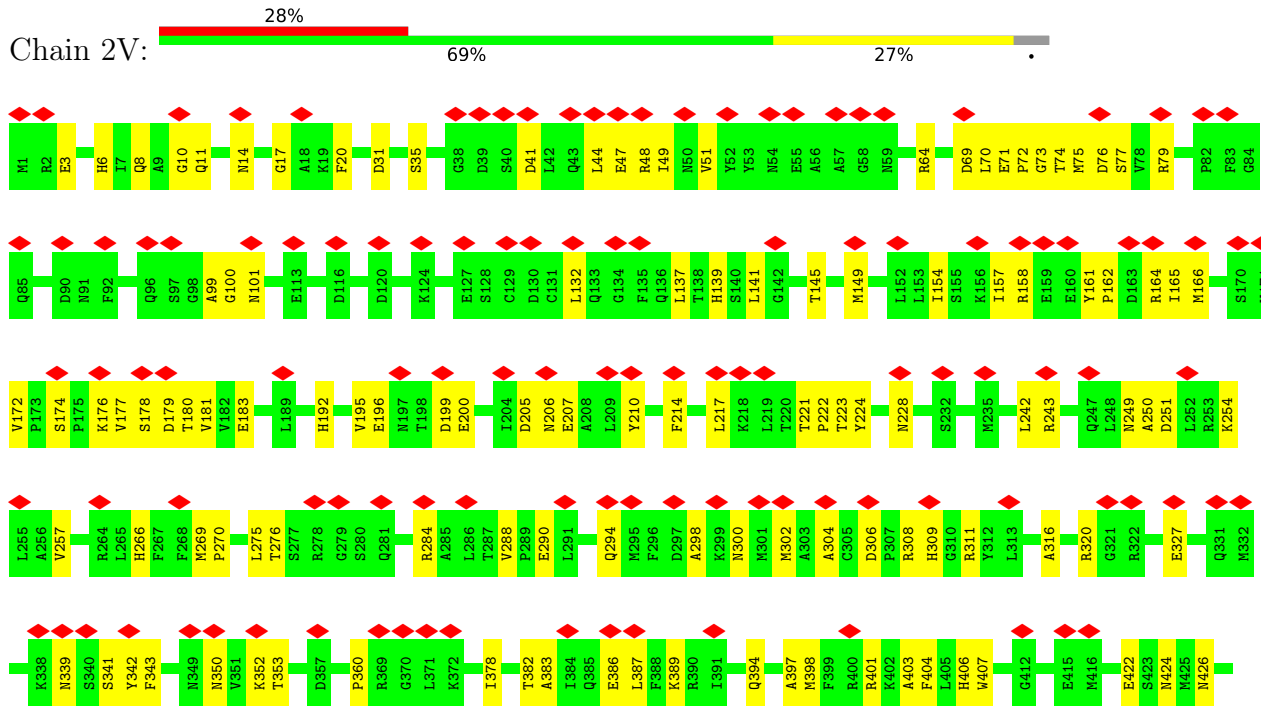





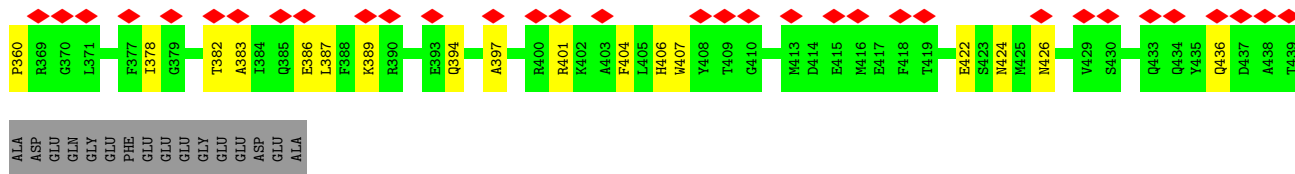

• Molecule 2: Tubulin beta chain

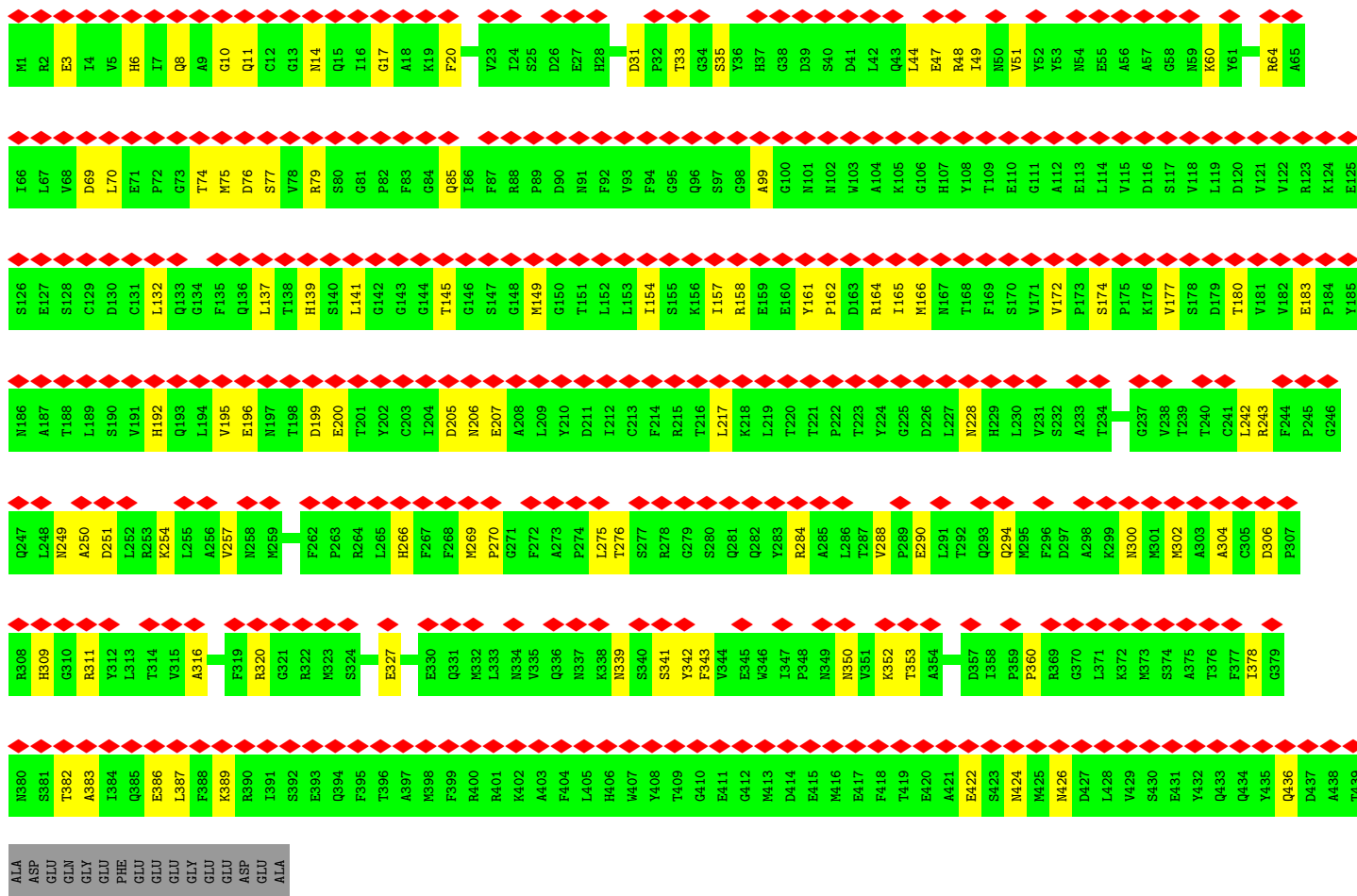
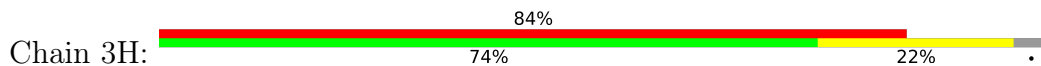

• Molecule 2: Tubulin beta chain

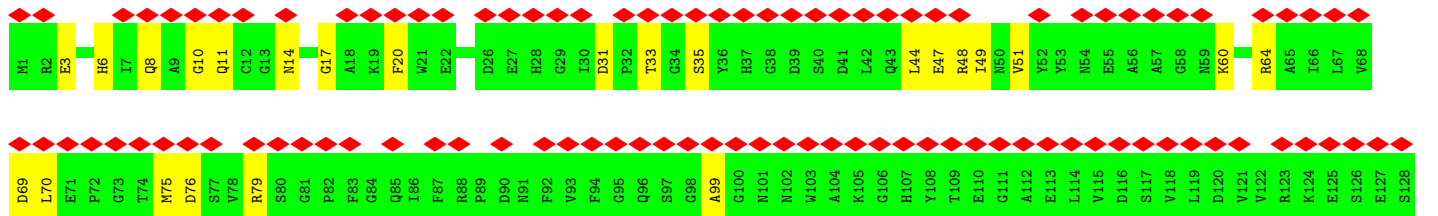
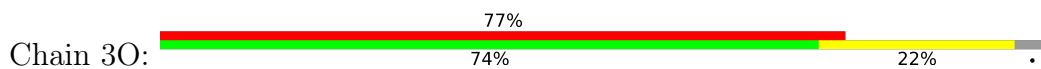



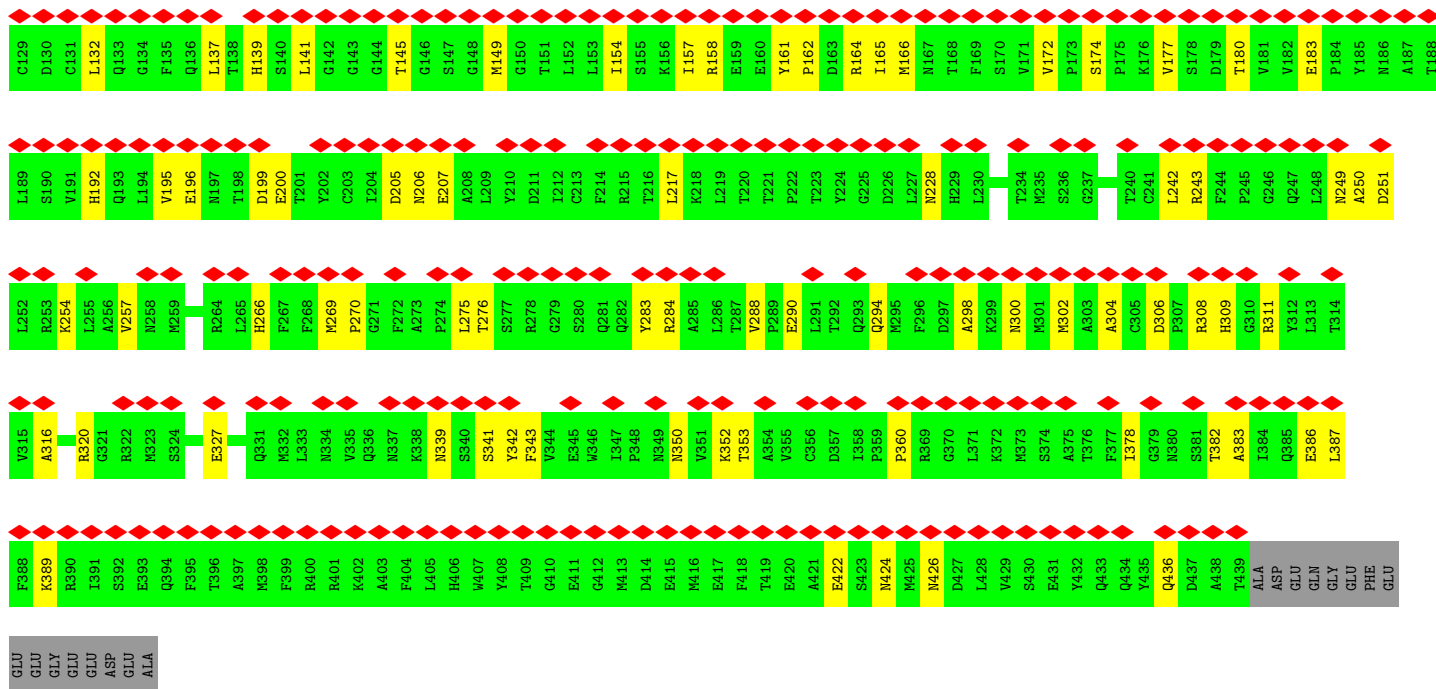

• Molecule 2: Tubulin beta chain

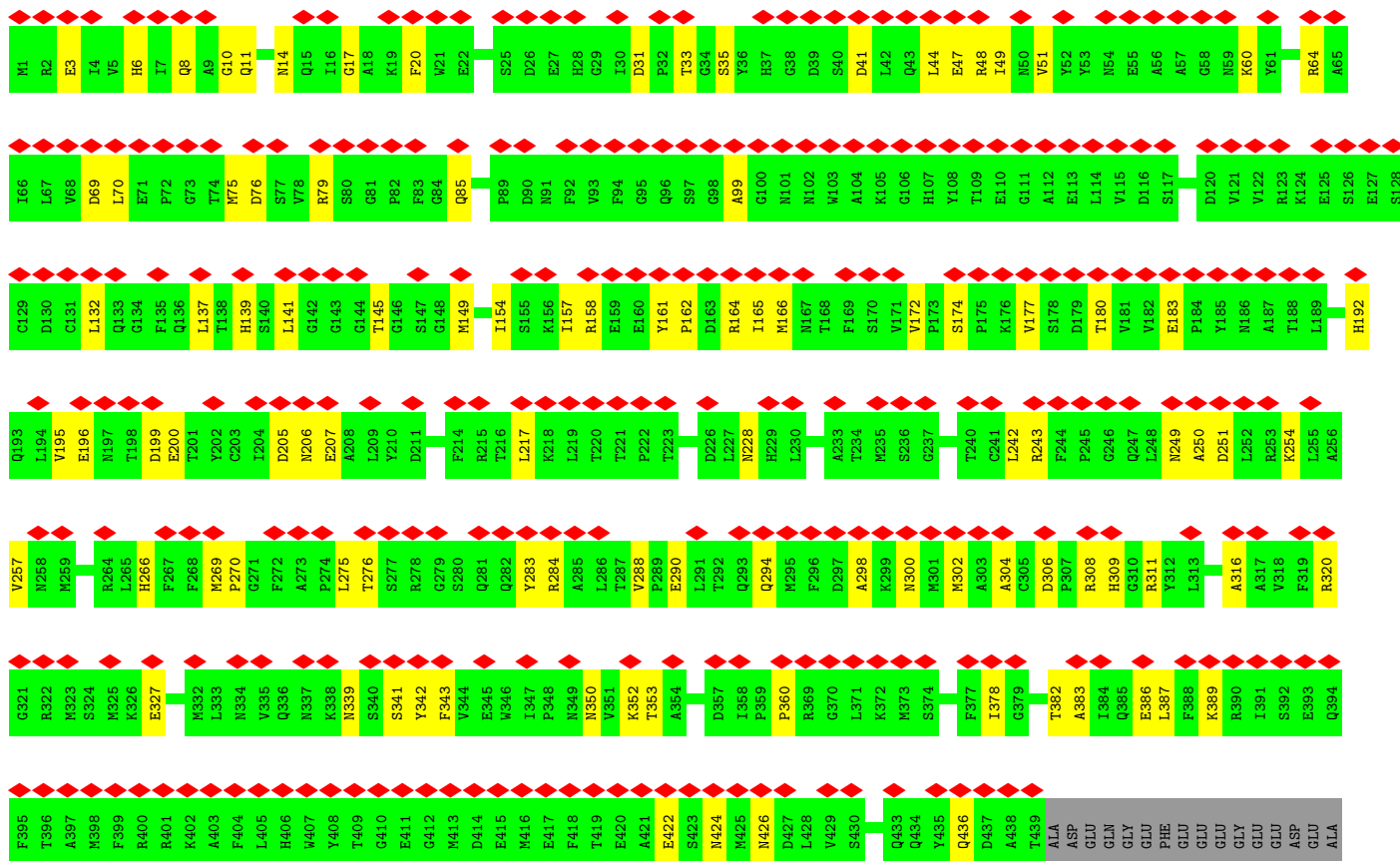
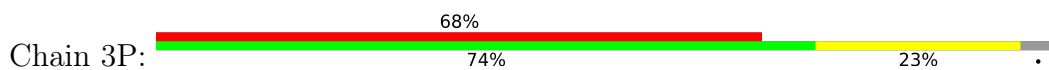

• Molecule 2: Tubulin beta chain

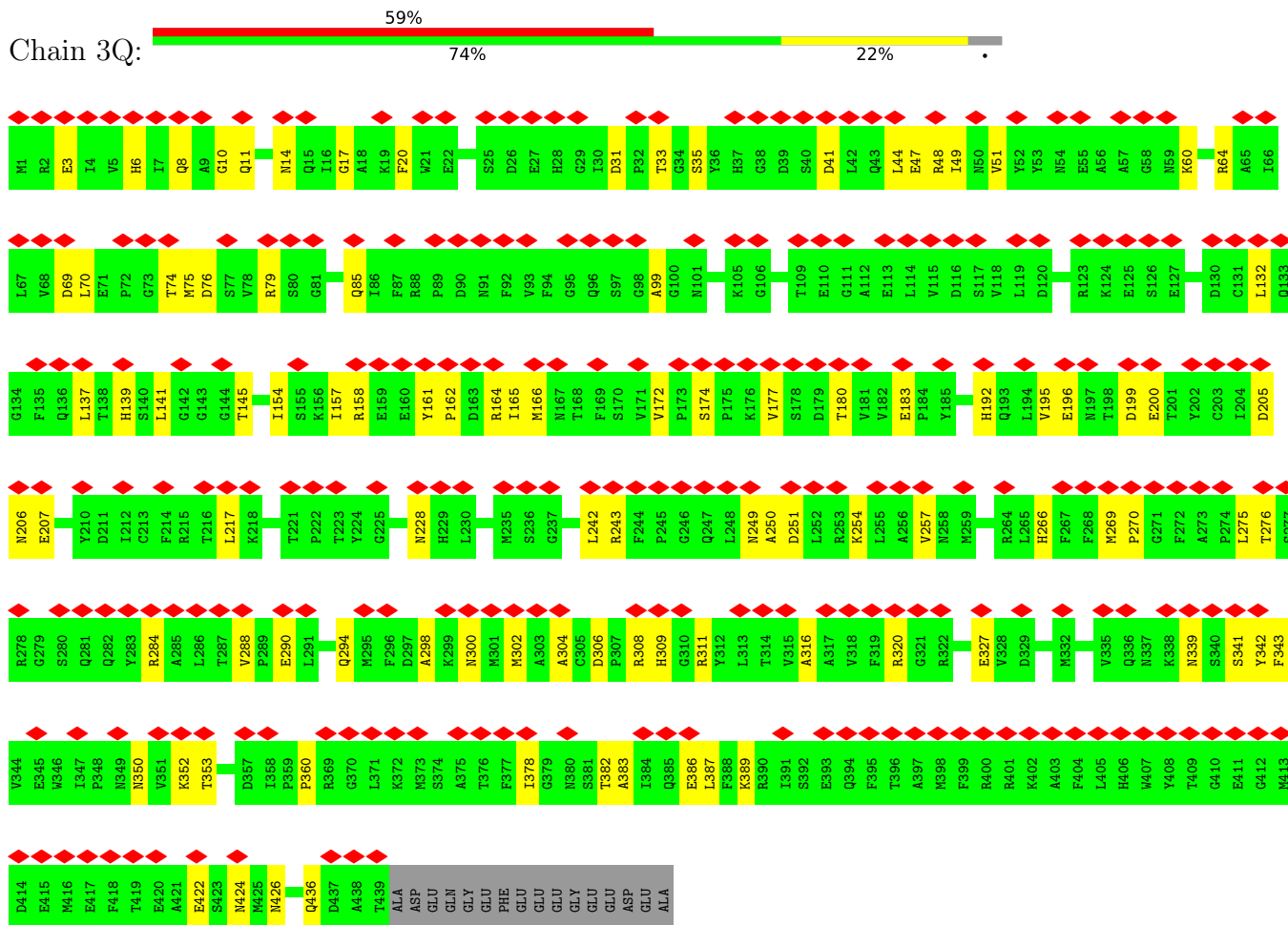

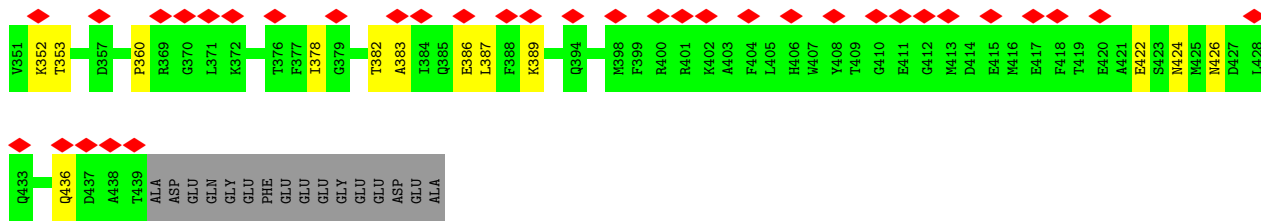

• Molecule 2: Tubulin beta chain

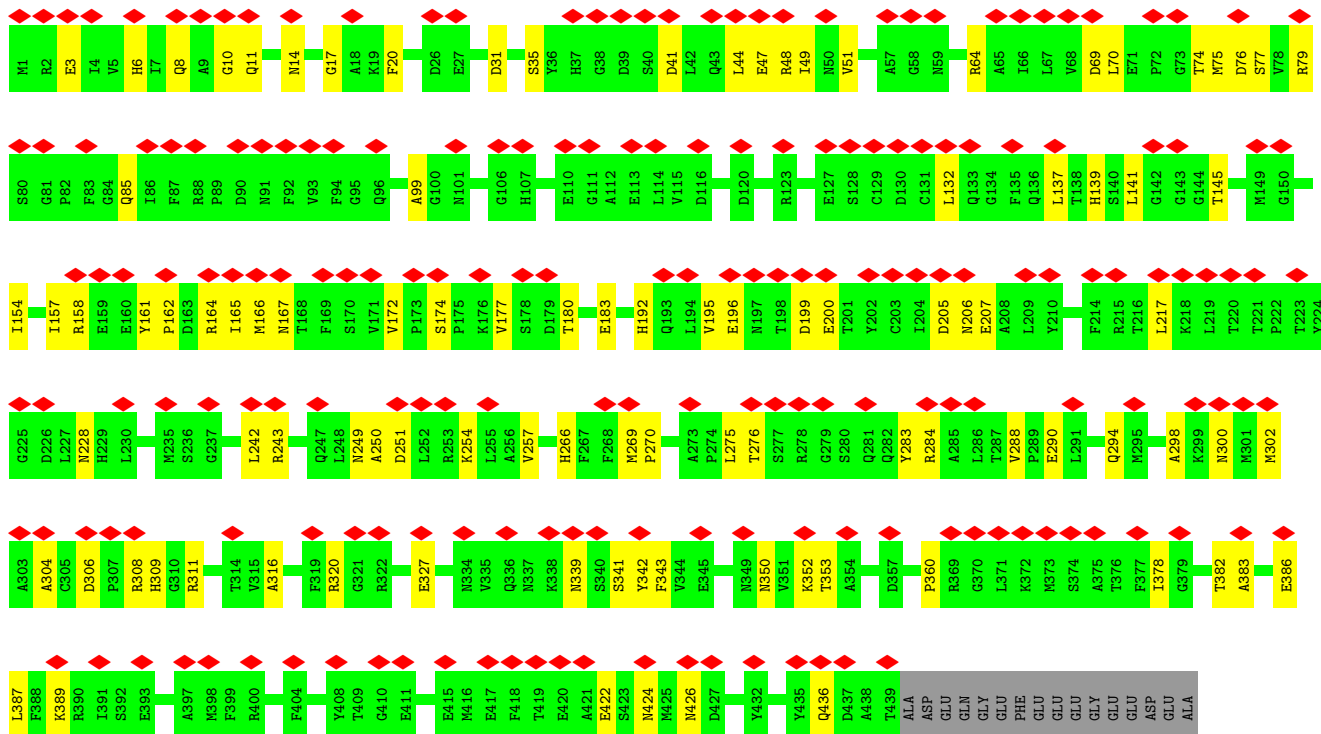
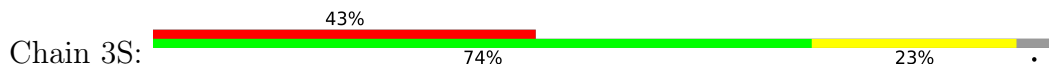

• Molecule 2: Tubulin beta chain

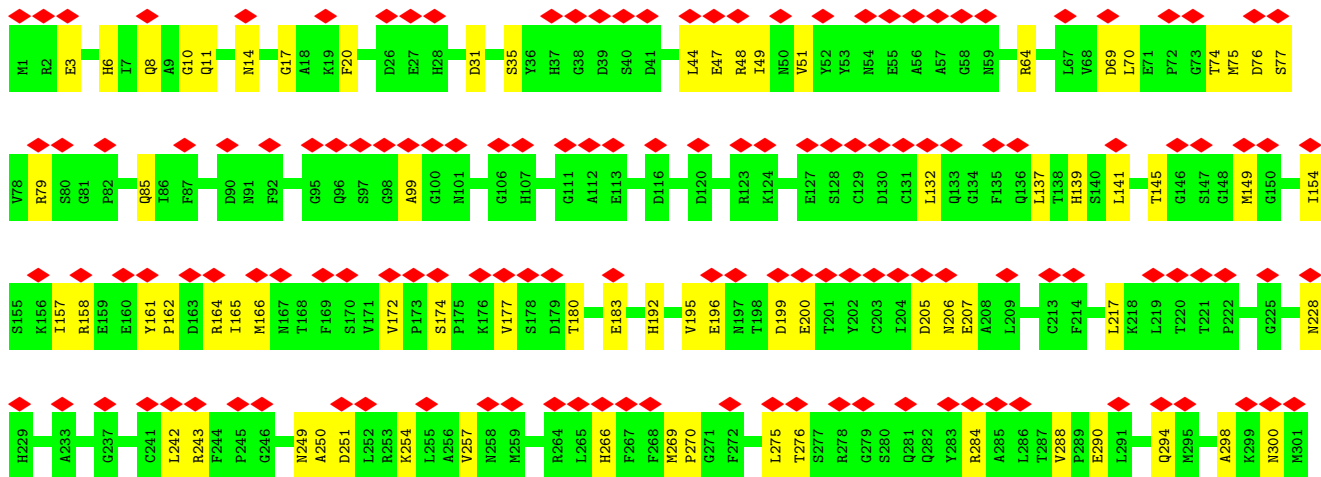
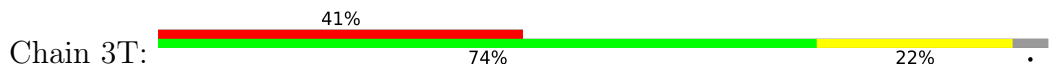

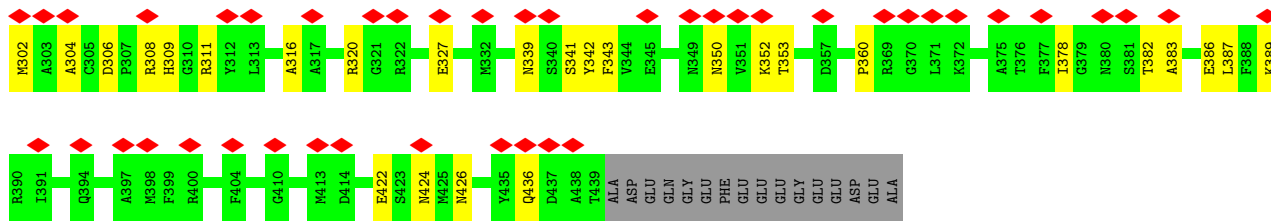

• Molecule 2: Tubulin beta chain

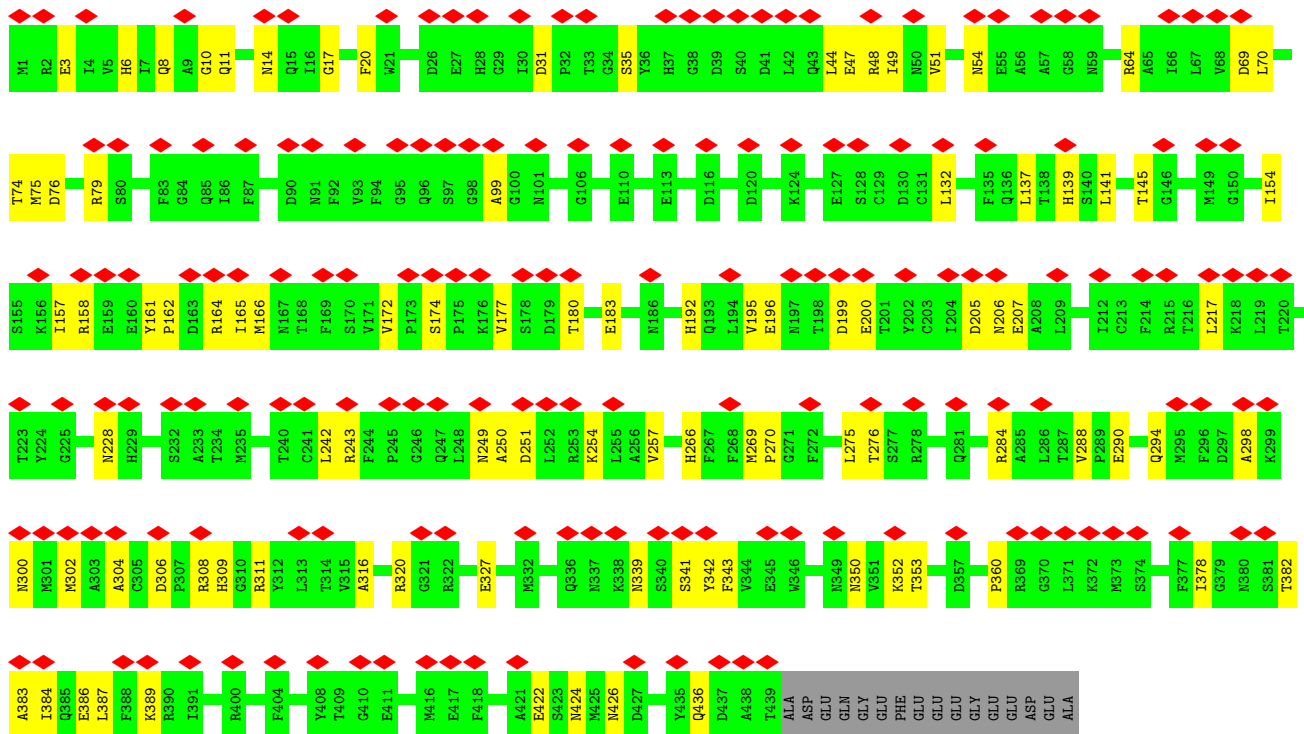
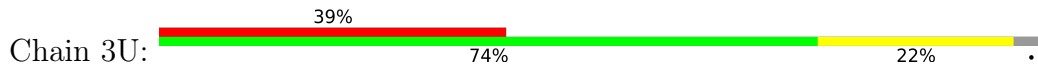

• Molecule 2: Tubulin beta chain

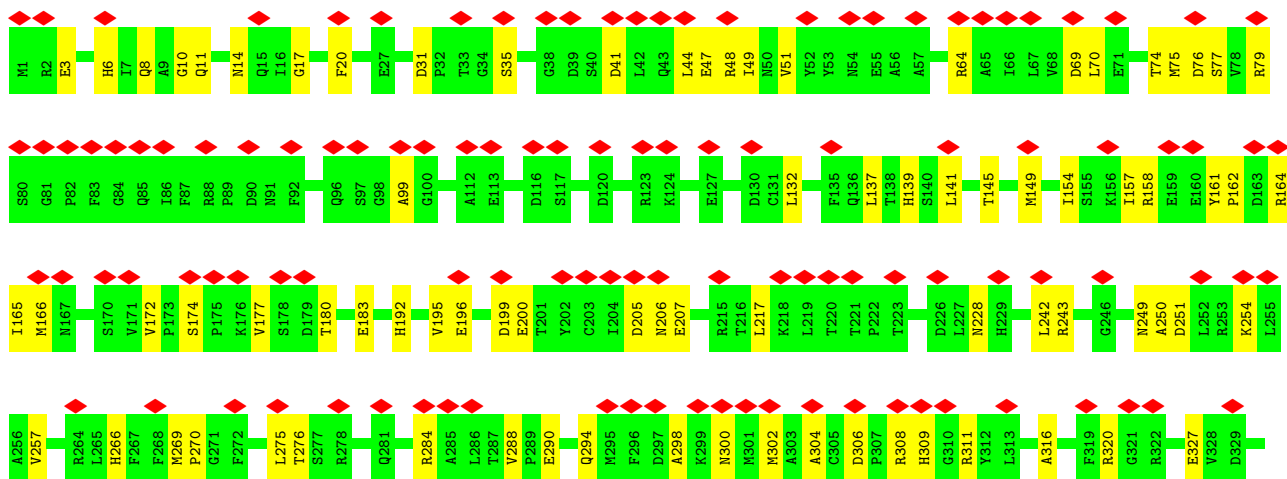
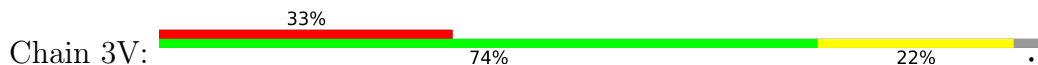





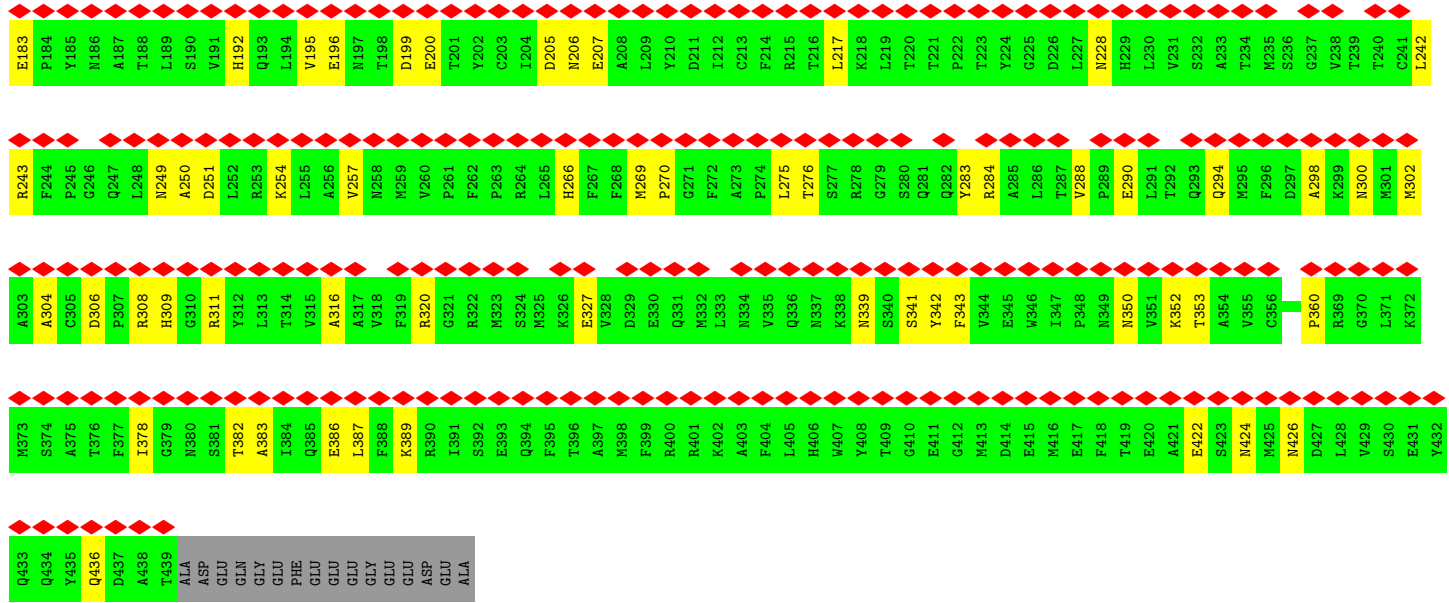

• Molecule 2: Tubulin beta chain

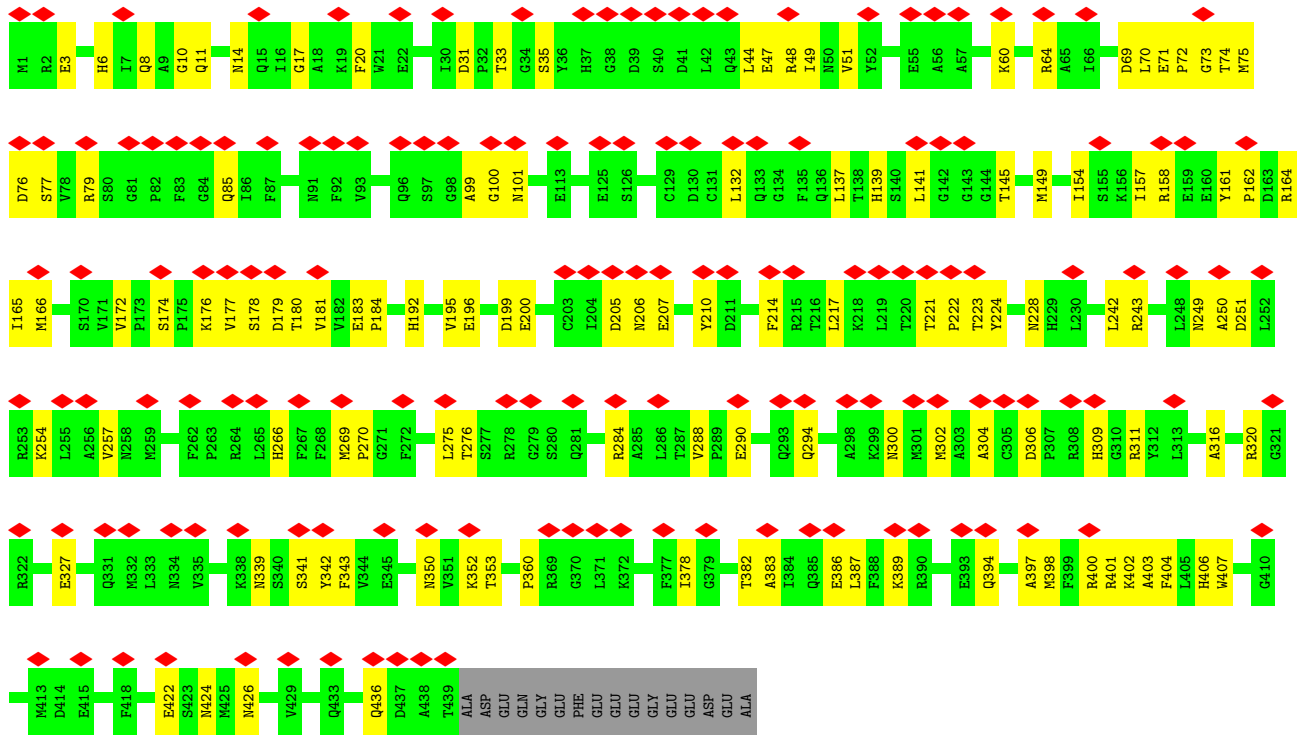

• Molecule 2: Tubulin beta chain

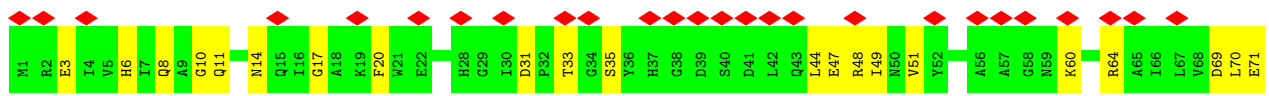

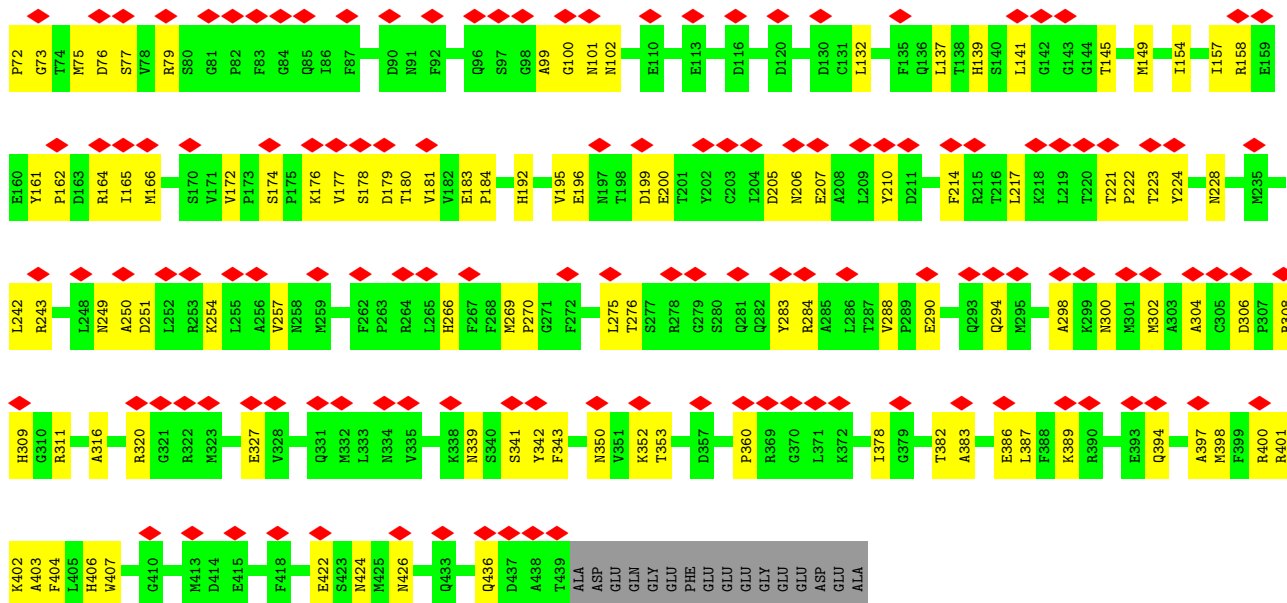

• Molecule 2: Tubulin beta chain



• Molecule 2: Tubulin beta chain

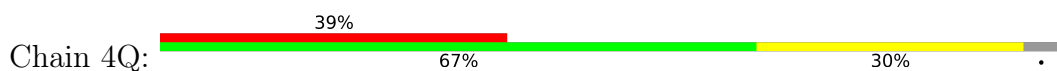



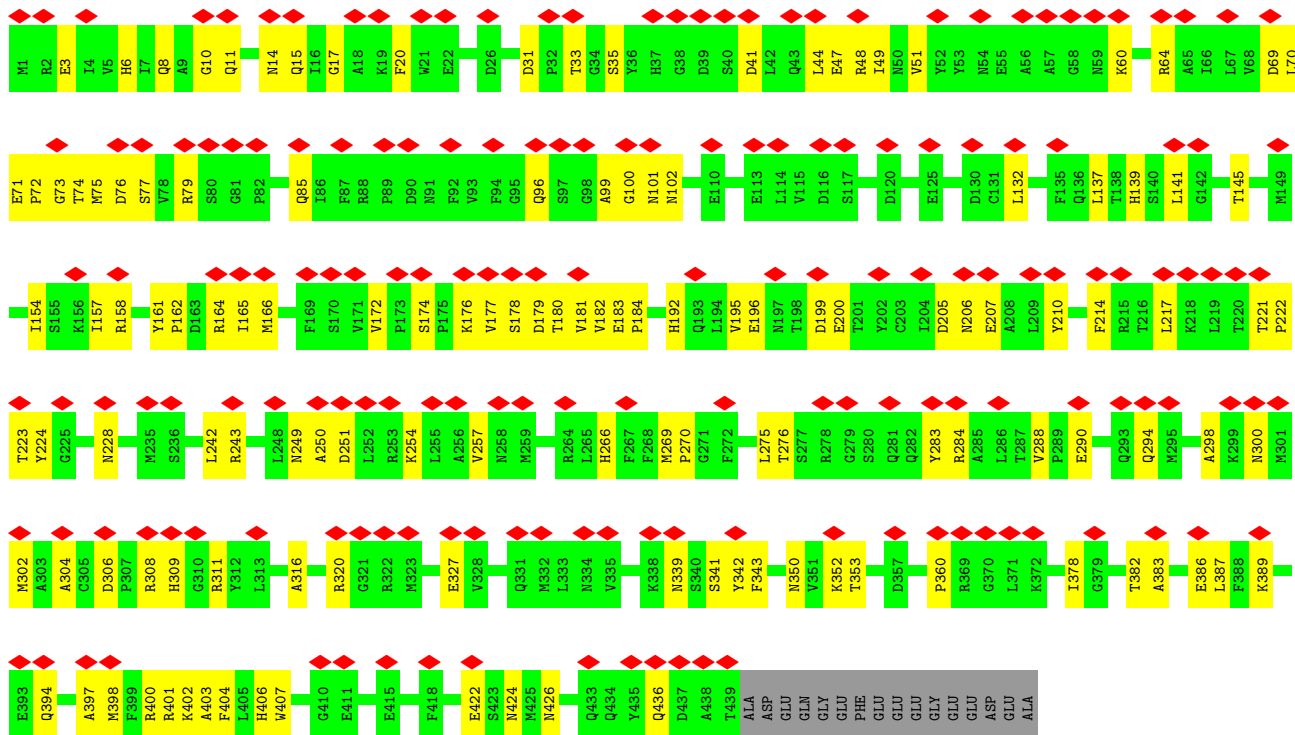

• Molecule 2: Tubulin beta chain

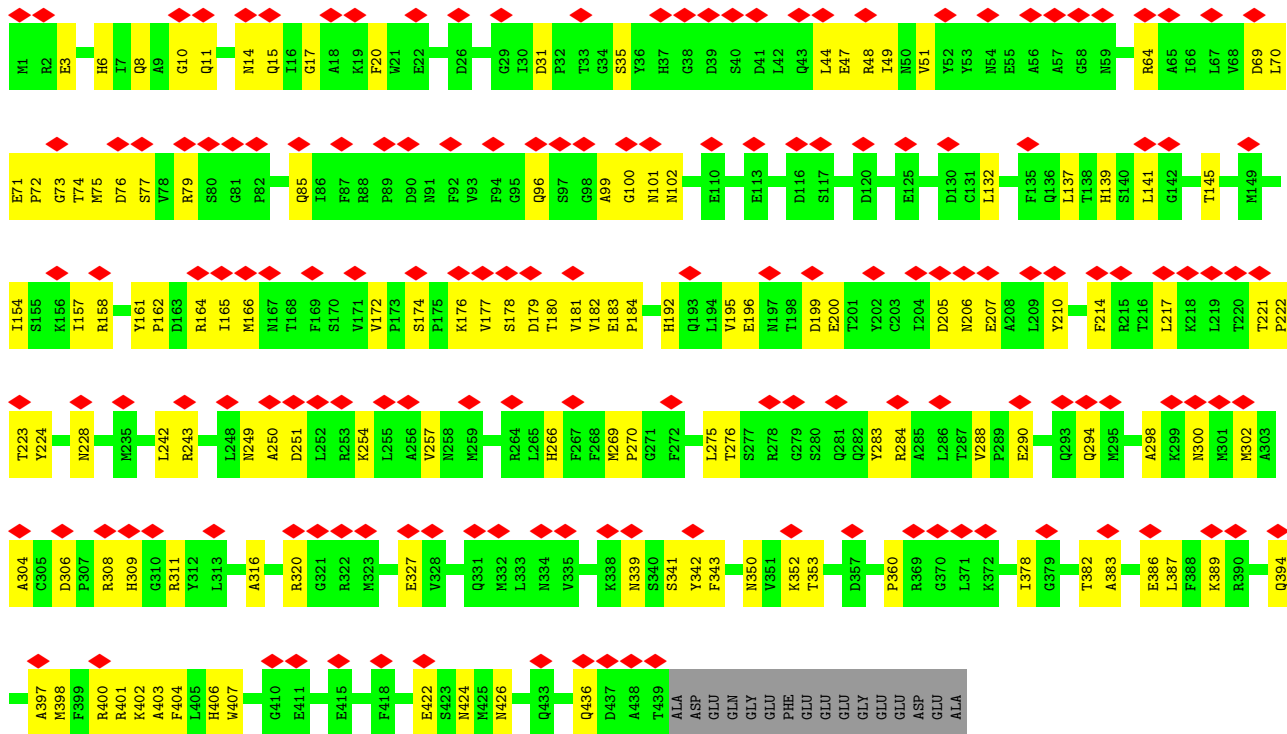

• Molecule 2: Tubulin beta chain



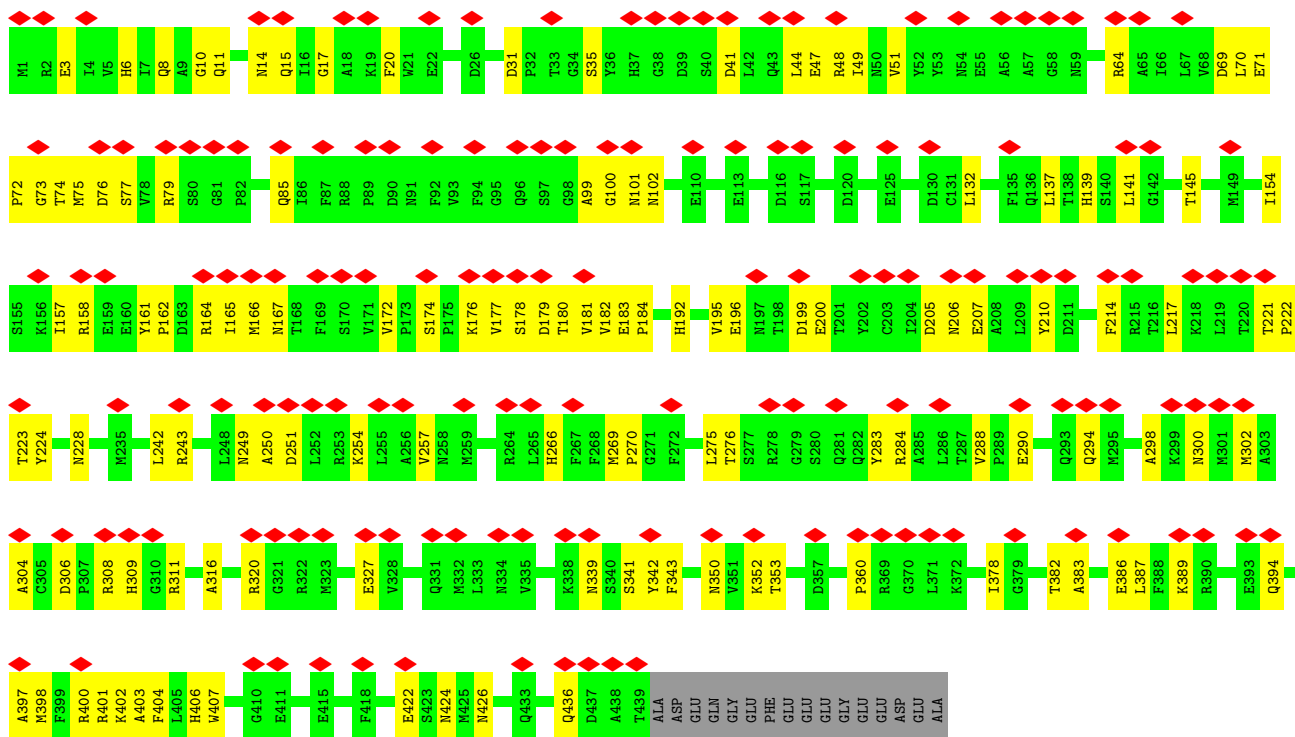

• Molecule 2: Tubulin beta chain

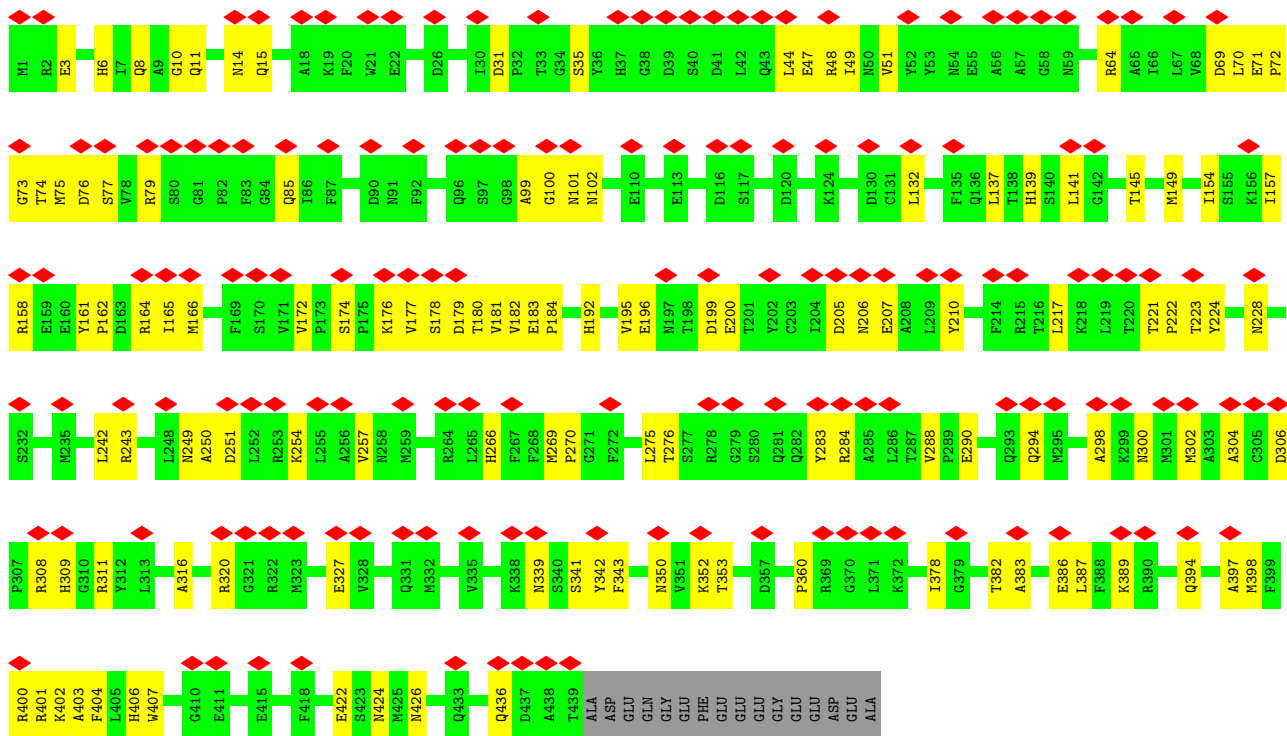

• Molecule 2: Tubulin beta chain



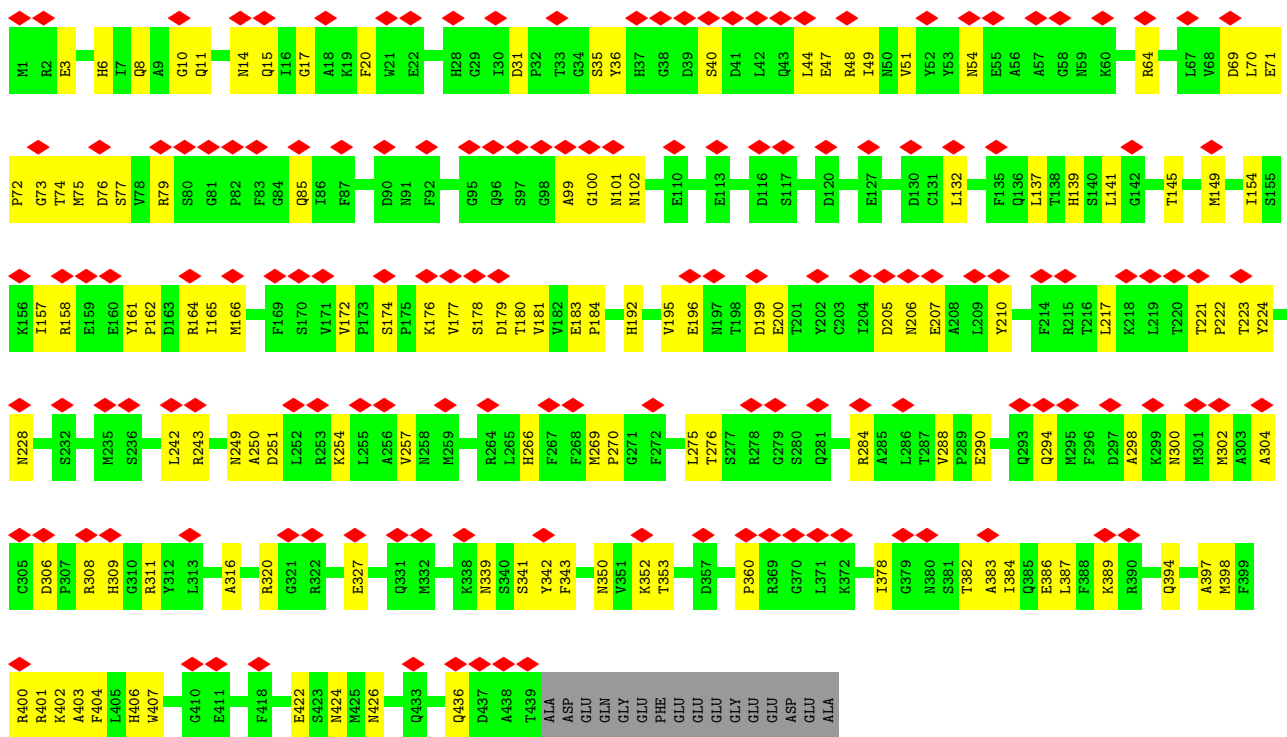

• Molecule 2: Tubulin beta chain

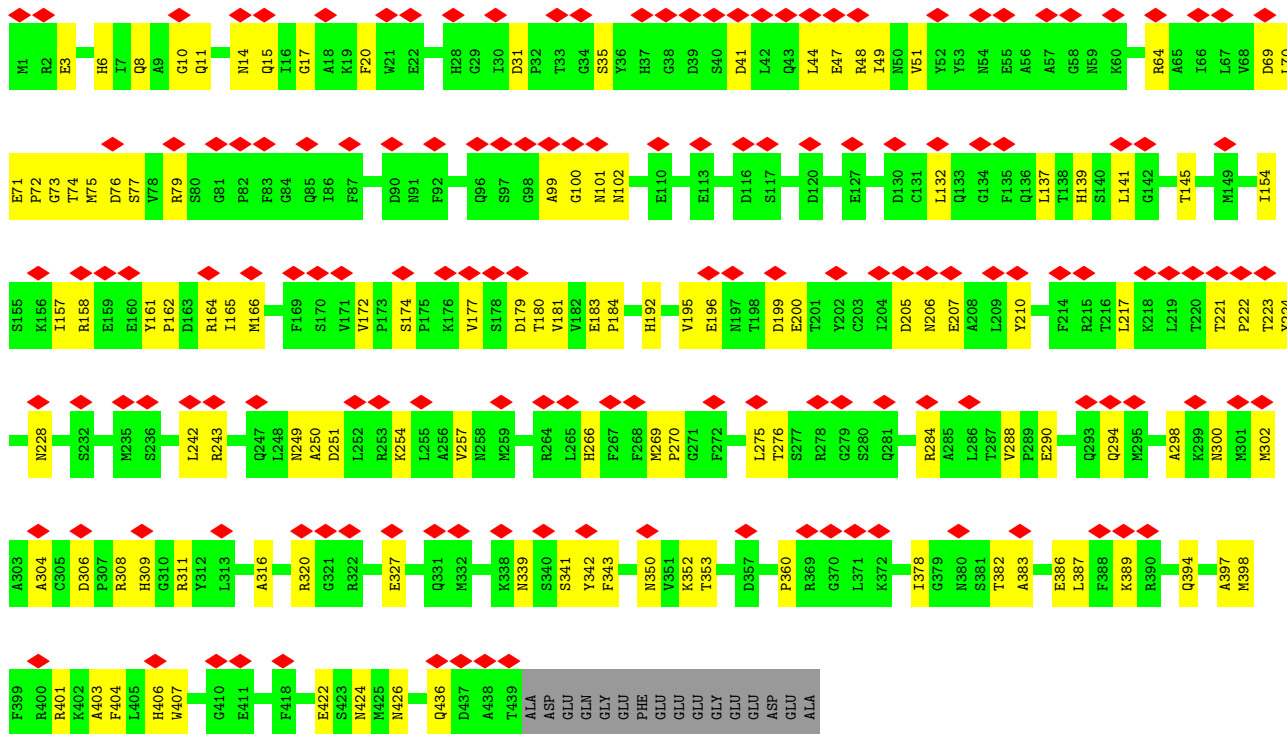

• Molecule 2: Tubulin beta chain

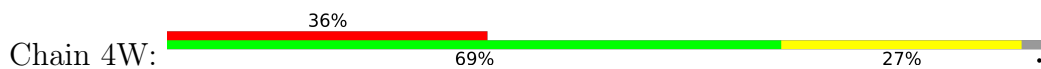

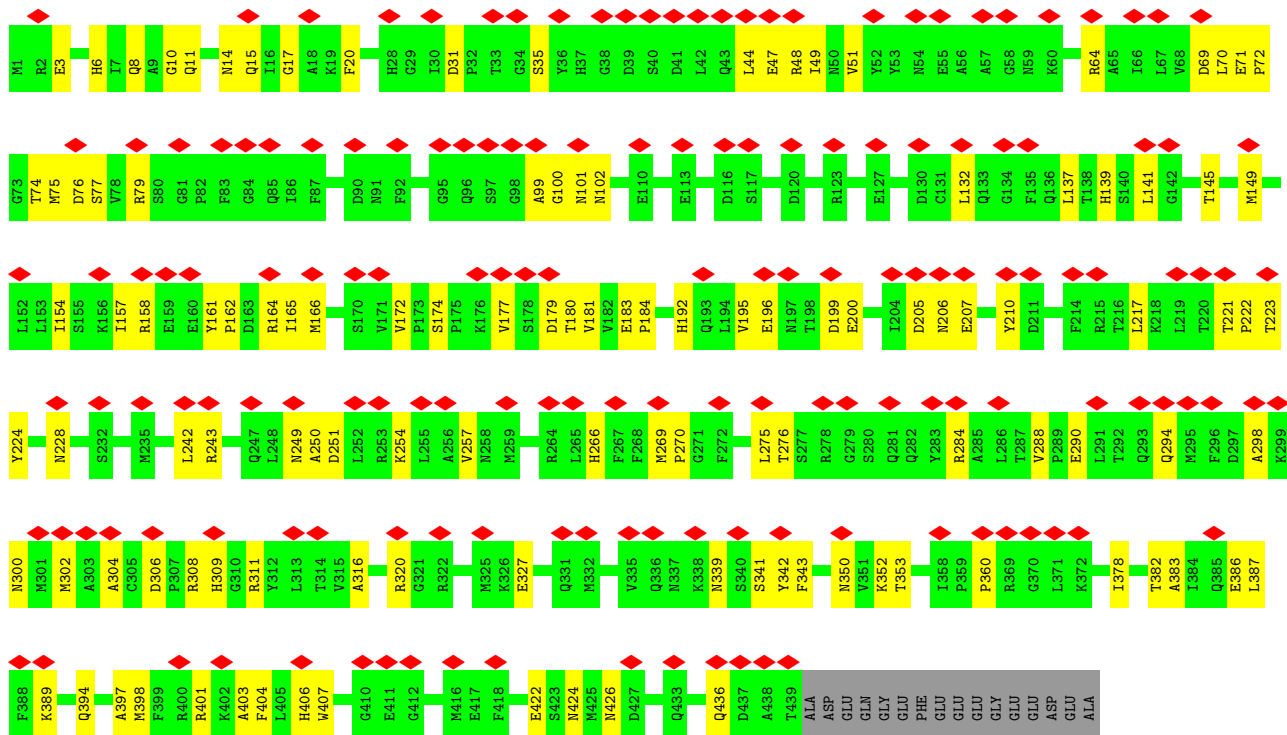

• Molecule 2: Tubulin beta chain

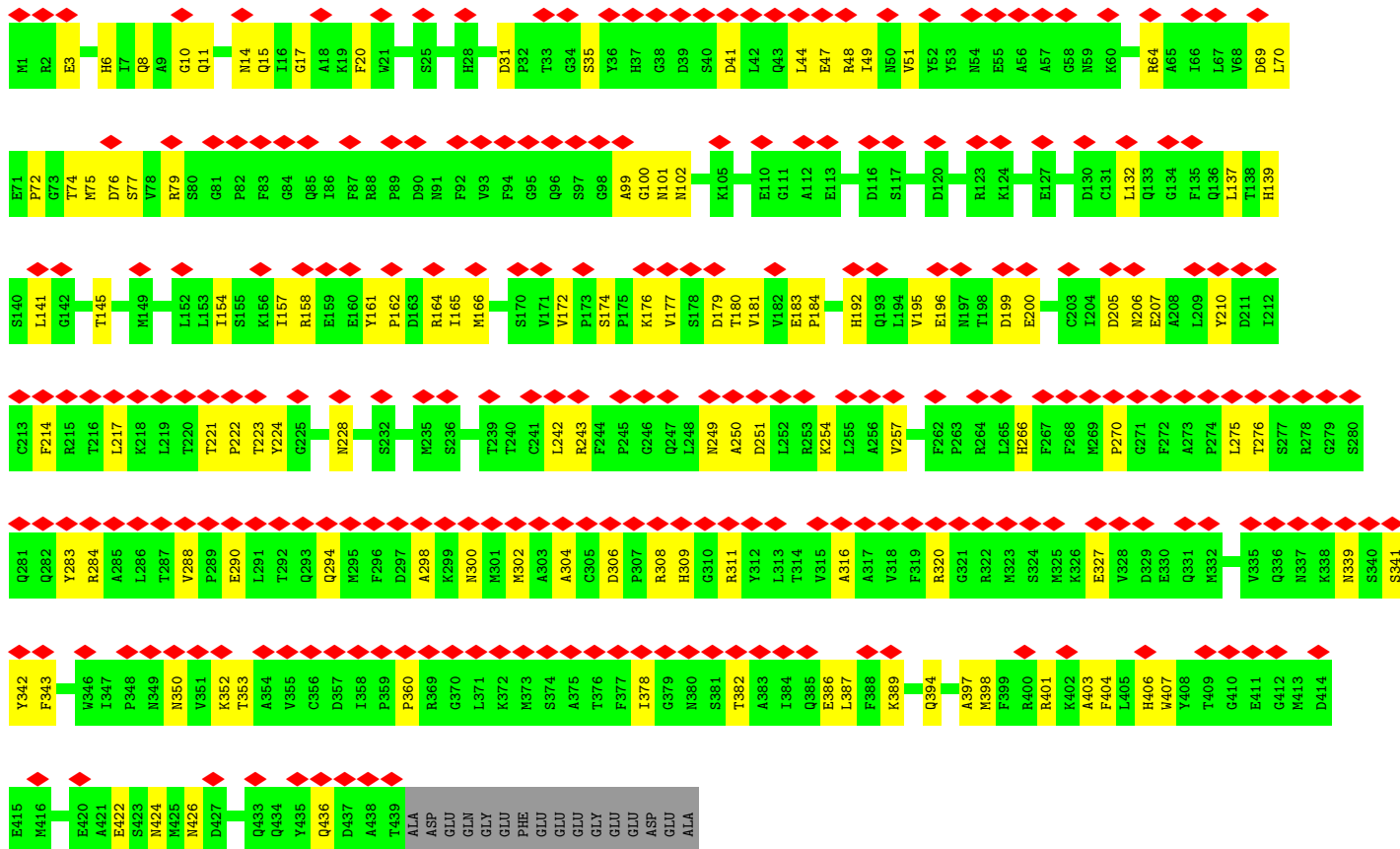



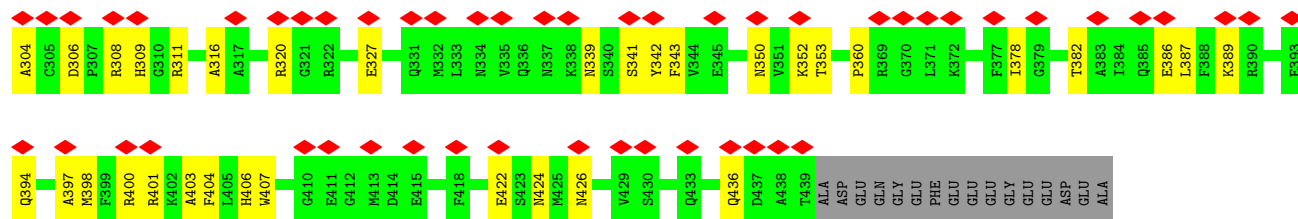

## 4 Experimental information

Property	Value	Source
EM reconstruction method	HELICAL	Depositor
Imposed symmetry	HELICAL, twist=-27.7°, rise=9.3 Å, axial sym=C1	Depositor
Number of segments used	18432	Depositor
Resolution determination method	FSC 0.143 CUT-OFF	Depositor
CTF correction method	PHASE FLIPPING AND AMPLITUDE CORRECTION; CTFFIND4	Depositor
Microscope	FEI TITAN KRIOS	Depositor
Voltage (kV)	300	Depositor
Electron dose ( $e^-/\text{Å}^2$ )	25	Depositor
Minimum defocus (nm)	1422.3	Depositor
Maximum defocus (nm)	2706.1	Depositor
Magnification	23364	Depositor
Image detector	GATAN K2 SUMMIT (4k x 4k)	Depositor
Maximum map value	14.128	Depositor
Minimum map value	-8.846	Depositor
Average map value	-0.000	Depositor
Map value standard deviation	0.928	Depositor
Recommended contour level	4.0	Depositor
Map size (Å)	548.91003, 548.91003, 548.91003	wwPDB
Map dimensions	513, 513, 513	wwPDB
Map angles (°)	90.0, 90.0, 90.0	wwPDB
Pixel spacing (Å)	1.07, 1.07, 1.07	Depositor

## 5 Model quality

### 5.1 Standard geometry

Bond lengths and bond angles in the following residue types are not validated in this section: GDP, GTP, MG

The Z score for a bond length (or angle) is the number of standard deviations the observed value is removed from the expected value. A bond length (or angle) with  $|Z| > 5$  is considered an outlier worth inspection. RMSZ is the root-mean-square of all Z scores of the bond lengths (or angles).

Mol	Chain	Bond lengths		Bond angles	
		RMSZ	# Z  >5	RMSZ	# Z  >5
1	1A	0.35	0/3492	0.52	0/4741
1	1B	0.35	0/3492	0.52	0/4741
1	1C	0.35	0/3492	0.52	0/4741
1	1D	0.35	0/3492	0.52	0/4741
1	1E	0.35	0/3492	0.52	0/4741
1	1F	0.35	0/3492	0.52	0/4741
1	1G	0.35	0/3492	0.52	0/4741
1	1I	0.35	0/3492	0.52	0/4741
1	1J	0.35	0/3492	0.52	0/4741
1	1K	0.35	0/3492	0.52	0/4741
1	1L	0.35	0/3492	0.52	0/4741
1	1M	0.35	0/3492	0.52	0/4741
1	1N	0.35	0/3492	0.52	0/4741
1	2A	0.35	0/3492	0.52	0/4741
1	2B	0.35	0/3492	0.52	0/4741
1	2C	0.35	0/3492	0.52	0/4741
1	2D	0.35	0/3492	0.52	0/4741
1	2E	0.35	0/3492	0.52	0/4741
1	2F	0.35	0/3492	0.52	0/4741
1	2G	0.35	0/3492	0.52	0/4741
1	2I	0.35	0/3492	0.52	0/4741
1	2J	0.35	0/3492	0.52	0/4741
1	2K	0.35	0/3492	0.52	0/4741
1	2L	0.35	0/3492	0.52	0/4741
1	2M	0.35	0/3492	0.52	0/4741
1	2N	0.35	0/3492	0.52	0/4741
1	3A	0.35	0/3492	0.52	0/4741
1	3B	0.35	0/3492	0.52	0/4741
1	3C	0.35	0/3492	0.52	0/4741
1	3D	0.35	0/3492	0.52	0/4741
1	3E	0.35	0/3492	0.52	0/4741
1	3F	0.35	0/3492	0.52	0/4741



Mol	Chain	Bond lengths		Bond angles	
		RMSZ	# Z  >5	RMSZ	# Z  >5
1	3G	0.35	0/3492	0.52	0/4741
1	3I	0.35	0/3492	0.52	0/4741
1	3J	0.35	0/3492	0.52	0/4741
1	3K	0.35	0/3492	0.52	0/4741
1	3L	0.35	0/3492	0.52	0/4741
1	3M	0.35	0/3492	0.52	0/4741
1	3N	0.35	0/3492	0.52	0/4741
1	4A	0.35	0/3492	0.52	0/4741
1	4B	0.35	0/3492	0.52	0/4741
1	4C	0.35	0/3492	0.52	0/4741
1	4D	0.35	0/3492	0.52	0/4741
1	4E	0.35	0/3492	0.52	0/4741
1	4F	0.35	0/3492	0.52	0/4741
1	4G	0.35	0/3492	0.52	0/4741
1	4I	0.35	0/3492	0.52	0/4741
1	4J	0.35	0/3492	0.52	0/4741
1	4K	0.35	0/3492	0.52	0/4741
1	4L	0.35	0/3492	0.52	0/4741
1	4M	0.35	0/3492	0.52	0/4741
1	4N	0.35	0/3492	0.52	0/4741
2	1H	0.35	0/3443	0.52	0/4666
2	1O	0.35	0/3443	0.52	0/4666
2	1P	0.35	0/3443	0.52	0/4666
2	1Q	0.35	0/3443	0.52	0/4666
2	1R	0.35	0/3443	0.52	0/4666
2	1S	0.35	0/3443	0.52	0/4666
2	1T	0.35	0/3443	0.52	0/4666
2	1U	0.35	0/3443	0.52	0/4666
2	1V	0.35	0/3443	0.52	0/4666
2	1W	0.35	0/3443	0.52	0/4666
2	1X	0.35	0/3443	0.52	0/4666
2	1Y	0.35	0/3443	0.52	0/4666
2	1Z	0.35	0/3443	0.52	0/4666
2	2H	0.35	0/3443	0.52	0/4666
2	2O	0.35	0/3443	0.52	0/4666
2	2P	0.35	0/3443	0.52	0/4666
2	2Q	0.35	0/3443	0.52	0/4666
2	2R	0.35	0/3443	0.52	0/4666
2	2S	0.35	0/3443	0.52	0/4666
2	2T	0.35	0/3443	0.52	0/4666
2	2U	0.35	0/3443	0.52	0/4666
2	2V	0.35	0/3443	0.52	0/4666
2	2W	0.35	0/3443	0.52	0/4666

Mol	Chain	Bond lengths		Bond angles	
		RMSZ	# Z  >5	RMSZ	# Z  >5
2	2X	0.35	0/3443	0.52	0/4666
2	2Y	0.35	0/3443	0.52	0/4666
2	2Z	0.35	0/3443	0.52	0/4666
2	3H	0.35	0/3443	0.52	0/4666
2	3O	0.35	0/3443	0.52	0/4666
2	3P	0.35	0/3443	0.52	0/4666
2	3Q	0.35	0/3443	0.52	0/4666
2	3R	0.35	0/3443	0.52	0/4666
2	3S	0.35	0/3443	0.52	0/4666
2	3T	0.35	0/3443	0.52	0/4666
2	3U	0.35	0/3443	0.52	0/4666
2	3V	0.35	0/3443	0.52	0/4666
2	3W	0.35	0/3443	0.52	0/4666
2	3X	0.35	0/3443	0.52	0/4666
2	3Y	0.35	0/3443	0.52	0/4666
2	3Z	0.35	0/3443	0.52	0/4666
2	4H	0.35	0/3443	0.52	0/4666
2	4O	0.35	0/3443	0.52	0/4666
2	4P	0.35	0/3443	0.52	0/4666
2	4Q	0.35	0/3443	0.52	0/4666
2	4R	0.35	0/3443	0.52	0/4666
2	4S	0.35	0/3443	0.52	0/4666
2	4T	0.35	0/3443	0.52	0/4666
2	4U	0.35	0/3443	0.52	0/4666
2	4V	0.35	0/3443	0.52	0/4666
2	4W	0.35	0/3443	0.52	0/4666
2	4X	0.35	0/3443	0.52	0/4666
2	4Y	0.35	0/3443	0.52	0/4666
2	4Z	0.35	0/3443	0.52	0/4666
All	All	0.35	0/360620	0.52	0/489164

There are no bond length outliers.

There are no bond angle outliers.

There are no chirality outliers.

There are no planarity outliers.

## 5.2 Too-close contacts [i](#)

In the following table, the Non-H and H(model) columns list the number of non-hydrogen atoms and hydrogen atoms in the chain respectively. The H(added) column lists the number of hydrogen

atoms added and optimized by MolProbity. The Clashes column lists the number of clashes within the asymmetric unit, whereas Symm-Clashes lists symmetry-related clashes.

Mol	Chain	Non-H	H(model)	H(added)	Clashes	Symm-Clashes
1	1A	3415	0	3313	264	0
1	1B	3415	0	3311	334	0
1	1C	3415	0	3311	397	0
1	1D	3415	0	3310	426	0
1	1E	3415	0	3310	445	0
1	1F	3415	0	3312	428	0
1	1G	3415	0	3313	398	0
1	1I	3415	0	3313	333	0
1	1J	3415	0	3313	275	0
1	1K	3415	0	3313	240	0
1	1L	3415	0	3313	232	0
1	1M	3415	0	3313	247	0
1	1N	3415	0	3313	219	0
1	2A	3415	0	3313	124	0
1	2B	3415	0	3313	104	0
1	2C	3415	0	3313	96	0
1	2D	3415	0	3313	105	0
1	2E	3415	0	3313	121	0
1	2F	3415	0	3313	140	0
1	2G	3415	0	3313	154	0
1	2I	3415	0	3313	170	0
1	2J	3415	0	3313	190	0
1	2K	3415	0	3312	189	0
1	2L	3415	0	3312	194	0
1	2M	3415	0	3312	174	0
1	2N	3415	0	3313	141	0
1	3A	3415	0	3312	199	0
1	3B	3415	0	3312	206	0
1	3C	3415	0	3312	216	0
1	3D	3415	0	3312	221	0
1	3E	3415	0	3313	235	0
1	3F	3415	0	3313	245	0
1	3G	3415	0	3313	237	0
1	3I	3415	0	3313	230	0
1	3J	3415	0	3313	230	0
1	3K	3415	0	3313	219	0
1	3L	3415	0	3313	209	0
1	3M	3415	0	3313	195	0
1	3N	3415	0	3313	193	0
1	4A	3415	0	3313	61	0
1	4B	3415	0	3313	58	0

*Continued on next page...*

*Continued from previous page...*

Mol	Chain	Non-H	H(model)	H(added)	Clashes	Symm-Clashes
1	4C	3415	0	3313	59	0
1	4D	3415	0	3313	61	0
1	4E	3415	0	3313	59	0
1	4F	3415	0	3313	62	0
1	4G	3415	0	3313	62	0
1	4I	3415	0	3313	57	0
1	4J	3415	0	3313	59	0
1	4K	3415	0	3313	58	0
1	4L	3415	0	3313	58	0
1	4M	3415	0	3313	53	0
1	4N	3415	0	3313	53	0
2	1H	3368	0	3246	121	0
2	1O	3368	0	3246	103	0
2	1P	3368	0	3246	98	0
2	1Q	3368	0	3246	104	0
2	1R	3368	0	3246	120	0
2	1S	3368	0	3246	139	0
2	1T	3368	0	3246	155	0
2	1U	3368	0	3246	172	0
2	1V	3368	0	3246	191	0
2	1W	3368	0	3245	189	0
2	1X	3368	0	3245	192	0
2	1Y	3368	0	3245	175	0
2	1Z	3368	0	3246	140	0
2	2H	3368	0	3246	194	0
2	2O	3368	0	3246	201	0
2	2P	3368	0	3246	213	0
2	2Q	3368	0	3246	215	0
2	2R	3368	0	3246	230	0
2	2S	3368	0	3246	238	0
2	2T	3368	0	3246	230	0
2	2U	3368	0	3246	226	0
2	2V	3368	0	3246	227	0
2	2W	3368	0	3246	214	0
2	2X	3368	0	3246	206	0
2	2Y	3368	0	3246	194	0
2	2Z	3368	0	3246	193	0
2	3H	3368	0	3246	59	0
2	3O	3368	0	3246	58	0
2	3P	3368	0	3246	60	0
2	3Q	3368	0	3246	59	0
2	3R	3368	0	3246	57	0

*Continued on next page...*

*Continued from previous page...*

Mol	Chain	Non-H	H(model)	H(added)	Clashes	Symm-Clashes
2	3S	3368	0	3246	61	0
2	3T	3368	0	3246	60	0
2	3U	3368	0	3246	58	0
2	3V	3368	0	3246	60	0
2	3W	3368	0	3246	58	0
2	3X	3368	0	3246	58	0
2	3Y	3368	0	3246	60	0
2	3Z	3368	0	3246	57	0
2	4H	3368	0	3246	258	0
2	4O	3368	0	3246	327	0
2	4P	3368	0	3246	392	0
2	4Q	3368	0	3245	419	0
2	4R	3368	0	3245	438	0
2	4S	3368	0	3246	422	0
2	4T	3368	0	3246	391	0
2	4U	3368	0	3246	332	0
2	4V	3368	0	3246	271	0
2	4W	3368	0	3246	238	0
2	4X	3368	0	3246	230	0
2	4Y	3368	0	3246	249	0
2	4Z	3368	0	3246	218	0
3	1A	32	0	12	2	0
3	1B	32	0	12	2	0
3	1C	32	0	12	2	0
3	1D	32	0	12	2	0
3	1E	32	0	12	2	0
3	1F	32	0	12	2	0
3	1G	32	0	12	2	0
3	1I	32	0	12	2	0
3	1J	32	0	12	2	0
3	1K	32	0	12	2	0
3	1L	32	0	12	2	0
3	1M	32	0	12	2	0
3	1N	32	0	12	2	0
3	2A	32	0	12	2	0
3	2B	32	0	12	2	0
3	2C	32	0	12	2	0
3	2D	32	0	12	2	0
3	2E	32	0	12	2	0
3	2F	32	0	12	2	0
3	2G	32	0	12	2	0
3	2I	32	0	12	2	0

*Continued on next page...*

*Continued from previous page...*

Mol	Chain	Non-H	H(model)	H(added)	Clashes	Symm-Clashes
3	2J	32	0	12	2	0
3	2K	32	0	12	2	0
3	2L	32	0	12	2	0
3	2M	32	0	12	2	0
3	2N	32	0	12	2	0
3	3A	32	0	12	2	0
3	3B	32	0	12	2	0
3	3C	32	0	12	2	0
3	3D	32	0	12	2	0
3	3E	32	0	12	2	0
3	3F	32	0	12	2	0
3	3G	32	0	12	2	0
3	3I	32	0	12	2	0
3	3J	32	0	12	2	0
3	3K	32	0	12	2	0
3	3L	32	0	12	2	0
3	3M	32	0	12	2	0
3	3N	32	0	12	2	0
3	4A	32	0	12	2	0
3	4B	32	0	12	2	0
3	4C	32	0	12	2	0
3	4D	32	0	12	2	0
3	4E	32	0	12	2	0
3	4F	32	0	12	2	0
3	4G	32	0	12	2	0
3	4I	32	0	12	2	0
3	4J	32	0	12	2	0
3	4K	32	0	12	2	0
3	4L	32	0	12	2	0
3	4M	32	0	12	2	0
3	4N	32	0	12	2	0
4	1A	1	0	0	0	0
4	1B	1	0	0	0	0
4	1C	1	0	0	0	0
4	1D	1	0	0	0	0
4	1E	1	0	0	0	0
4	1F	1	0	0	0	0
4	1G	1	0	0	0	0
4	1I	1	0	0	0	0
4	1J	1	0	0	0	0
4	1K	1	0	0	0	0
4	1L	1	0	0	0	0

*Continued on next page...*

*Continued from previous page...*

Mol	Chain	Non-H	H(model)	H(added)	Clashes	Symm-Clashes
4	1M	1	0	0	0	0
4	1N	1	0	0	0	0
4	2A	1	0	0	0	0
4	2B	1	0	0	0	0
4	2C	1	0	0	0	0
4	2D	1	0	0	0	0
4	2E	1	0	0	0	0
4	2F	1	0	0	0	0
4	2G	1	0	0	0	0
4	2I	1	0	0	0	0
4	2J	1	0	0	0	0
4	2K	1	0	0	0	0
4	2L	1	0	0	0	0
4	2M	1	0	0	0	0
4	2N	1	0	0	0	0
4	3A	1	0	0	0	0
4	3B	1	0	0	0	0
4	3C	1	0	0	0	0
4	3D	1	0	0	0	0
4	3E	1	0	0	0	0
4	3F	1	0	0	0	0
4	3G	1	0	0	0	0
4	3I	1	0	0	0	0
4	3J	1	0	0	0	0
4	3K	1	0	0	0	0
4	3L	1	0	0	0	0
4	3M	1	0	0	0	0
4	3N	1	0	0	0	0
4	4A	1	0	0	0	0
4	4B	1	0	0	0	0
4	4C	1	0	0	0	0
4	4D	1	0	0	0	0
4	4E	1	0	0	0	0
4	4F	1	0	0	0	0
4	4G	1	0	0	0	0
4	4I	1	0	0	0	0
4	4J	1	0	0	0	0
4	4K	1	0	0	0	0
4	4L	1	0	0	0	0
4	4M	1	0	0	0	0
4	4N	1	0	0	0	0
5	1H	28	0	12	5	0

*Continued on next page...*

*Continued from previous page...*

Mol	Chain	Non-H	H(model)	H(added)	Clashes	Symm-Clashes
5	1O	28	0	12	4	0
5	1P	28	0	12	3	0
5	1Q	28	0	12	3	0
5	1R	28	0	12	3	0
5	1S	28	0	12	3	0
5	1T	28	0	12	3	0
5	1U	28	0	12	3	0
5	1V	28	0	12	4	0
5	1W	28	0	12	4	0
5	1X	28	0	12	5	0
5	1Y	28	0	12	5	0
5	1Z	28	0	12	6	0
5	2H	28	0	12	7	0
5	2O	28	0	12	7	0
5	2P	28	0	12	7	0
5	2Q	28	0	12	7	0
5	2R	28	0	12	7	0
5	2S	28	0	12	8	0
5	2T	28	0	12	8	0
5	2U	28	0	12	8	0
5	2V	28	0	12	8	0
5	2W	28	0	12	8	0
5	2X	28	0	12	8	0
5	2Y	28	0	12	8	0
5	2Z	28	0	12	7	0
5	3H	28	0	12	3	0
5	3O	28	0	12	3	0
5	3P	28	0	12	3	0
5	3Q	28	0	12	3	0
5	3R	28	0	12	3	0
5	3S	28	0	12	3	0
5	3T	28	0	12	3	0
5	3U	28	0	12	3	0
5	3V	28	0	12	3	0
5	3W	28	0	12	3	0
5	3X	28	0	12	3	0
5	3Y	28	0	12	3	0
5	3Z	28	0	12	3	0
5	4H	28	0	12	8	0
5	4O	28	0	12	9	0
5	4P	28	0	12	9	0
5	4Q	28	0	12	10	0

*Continued on next page...*



Continued from previous page...

Mol	Chain	Non-H	H(model)	H(added)	Clashes	Symm-Clashes
5	4R	28	0	12	9	0
5	4S	28	0	12	7	0
5	4T	28	0	12	7	0
5	4U	28	0	12	7	0
5	4V	28	0	12	7	0
5	4W	28	0	12	6	0
5	4X	28	0	12	6	0
5	4Y	28	0	12	6	0
5	4Z	28	0	12	8	0
All	All	355888	0	342293	12468	0

The all-atom clashscore is defined as the number of clashes found per 1000 atoms (including hydrogen atoms). The all-atom clashscore for this structure is 18.

The worst 5 of 12468 close contacts within the same asymmetric unit are listed below, sorted by their clash magnitude.

Atom-1	Atom-2	Interatomic distance (Å)	Clash overlap (Å)
1:1I:262:TYR:HA	2:4U:406:HIS:CD2	1.37	1.60
1:1F:262:TYR:HA	2:4S:406:HIS:CD2	1.37	1.57
1:1G:262:TYR:HA	2:4T:406:HIS:CD2	1.34	1.56
1:1F:245:ASP:CG	2:4S:77:SER:HB3	1.30	1.51
1:1J:262:TYR:HA	2:4V:406:HIS:CD2	1.45	1.51

There are no symmetry-related clashes.

## 5.3 Torsion angles [i](#)

### 5.3.1 Protein backbone [i](#)

In the following table, the Percentiles column shows the percent Ramachandran outliers of the chain as a percentile score with respect to all PDB entries followed by that with respect to all EM entries.

The Analysed column shows the number of residues for which the backbone conformation was analysed, and the total number of residues.

Mol	Chain	Analysed	Favoured	Allowed	Outliers	Percentiles	
1	1A	433/451 (96%)	415 (96%)	18 (4%)	0	100	100
1	1B	433/451 (96%)	415 (96%)	18 (4%)	0	100	100

Continued on next page...

*Continued from previous page...*

Mol	Chain	Analysed	Favoured	Allowed	Outliers	Percentiles	
1	1C	433/451 (96%)	415 (96%)	18 (4%)	0	100	100
1	1D	433/451 (96%)	415 (96%)	18 (4%)	0	100	100
1	1E	433/451 (96%)	415 (96%)	18 (4%)	0	100	100
1	1F	433/451 (96%)	415 (96%)	18 (4%)	0	100	100
1	1G	433/451 (96%)	415 (96%)	18 (4%)	0	100	100
1	1I	433/451 (96%)	415 (96%)	18 (4%)	0	100	100
1	1J	433/451 (96%)	415 (96%)	18 (4%)	0	100	100
1	1K	433/451 (96%)	415 (96%)	18 (4%)	0	100	100
1	1L	433/451 (96%)	415 (96%)	18 (4%)	0	100	100
1	1M	433/451 (96%)	415 (96%)	18 (4%)	0	100	100
1	1N	433/451 (96%)	415 (96%)	18 (4%)	0	100	100
1	2A	433/451 (96%)	415 (96%)	18 (4%)	0	100	100
1	2B	433/451 (96%)	415 (96%)	18 (4%)	0	100	100
1	2C	433/451 (96%)	415 (96%)	18 (4%)	0	100	100
1	2D	433/451 (96%)	415 (96%)	18 (4%)	0	100	100
1	2E	433/451 (96%)	415 (96%)	18 (4%)	0	100	100
1	2F	433/451 (96%)	415 (96%)	18 (4%)	0	100	100
1	2G	433/451 (96%)	415 (96%)	18 (4%)	0	100	100
1	2I	433/451 (96%)	415 (96%)	18 (4%)	0	100	100
1	2J	433/451 (96%)	415 (96%)	18 (4%)	0	100	100
1	2K	433/451 (96%)	415 (96%)	18 (4%)	0	100	100
1	2L	433/451 (96%)	415 (96%)	18 (4%)	0	100	100
1	2M	433/451 (96%)	415 (96%)	18 (4%)	0	100	100
1	2N	433/451 (96%)	415 (96%)	18 (4%)	0	100	100
1	3A	433/451 (96%)	415 (96%)	18 (4%)	0	100	100
1	3B	433/451 (96%)	415 (96%)	18 (4%)	0	100	100
1	3C	433/451 (96%)	415 (96%)	18 (4%)	0	100	100
1	3D	433/451 (96%)	415 (96%)	18 (4%)	0	100	100
1	3E	433/451 (96%)	415 (96%)	18 (4%)	0	100	100
1	3F	433/451 (96%)	415 (96%)	18 (4%)	0	100	100
1	3G	433/451 (96%)	415 (96%)	18 (4%)	0	100	100

*Continued on next page...*

*Continued from previous page...*

Mol	Chain	Analysed	Favoured	Allowed	Outliers	Percentiles	
1	3I	433/451 (96%)	415 (96%)	18 (4%)	0	100	100
1	3J	433/451 (96%)	415 (96%)	18 (4%)	0	100	100
1	3K	433/451 (96%)	415 (96%)	18 (4%)	0	100	100
1	3L	433/451 (96%)	415 (96%)	18 (4%)	0	100	100
1	3M	433/451 (96%)	415 (96%)	18 (4%)	0	100	100
1	3N	433/451 (96%)	415 (96%)	18 (4%)	0	100	100
1	4A	433/451 (96%)	415 (96%)	18 (4%)	0	100	100
1	4B	433/451 (96%)	415 (96%)	18 (4%)	0	100	100
1	4C	433/451 (96%)	415 (96%)	18 (4%)	0	100	100
1	4D	433/451 (96%)	415 (96%)	18 (4%)	0	100	100
1	4E	433/451 (96%)	415 (96%)	18 (4%)	0	100	100
1	4F	433/451 (96%)	415 (96%)	18 (4%)	0	100	100
1	4G	433/451 (96%)	415 (96%)	18 (4%)	0	100	100
1	4I	433/451 (96%)	415 (96%)	18 (4%)	0	100	100
1	4J	433/451 (96%)	415 (96%)	18 (4%)	0	100	100
1	4K	433/451 (96%)	415 (96%)	18 (4%)	0	100	100
1	4L	433/451 (96%)	415 (96%)	18 (4%)	0	100	100
1	4M	433/451 (96%)	415 (96%)	18 (4%)	0	100	100
1	4N	433/451 (96%)	415 (96%)	18 (4%)	0	100	100
2	1H	427/445 (96%)	409 (96%)	18 (4%)	0	100	100
2	1O	427/445 (96%)	409 (96%)	18 (4%)	0	100	100
2	1P	427/445 (96%)	409 (96%)	18 (4%)	0	100	100
2	1Q	427/445 (96%)	409 (96%)	18 (4%)	0	100	100
2	1R	427/445 (96%)	409 (96%)	18 (4%)	0	100	100
2	1S	427/445 (96%)	409 (96%)	18 (4%)	0	100	100
2	1T	427/445 (96%)	409 (96%)	18 (4%)	0	100	100
2	1U	427/445 (96%)	409 (96%)	18 (4%)	0	100	100
2	1V	427/445 (96%)	409 (96%)	18 (4%)	0	100	100
2	1W	427/445 (96%)	409 (96%)	18 (4%)	0	100	100
2	1X	427/445 (96%)	409 (96%)	18 (4%)	0	100	100
2	1Y	427/445 (96%)	409 (96%)	18 (4%)	0	100	100

*Continued on next page...*

*Continued from previous page...*

Mol	Chain	Analysed	Favoured	Allowed	Outliers	Percentiles	
2	1Z	427/445 (96%)	409 (96%)	18 (4%)	0	100	100
2	2H	427/445 (96%)	409 (96%)	18 (4%)	0	100	100
2	2O	427/445 (96%)	409 (96%)	18 (4%)	0	100	100
2	2P	427/445 (96%)	409 (96%)	18 (4%)	0	100	100
2	2Q	427/445 (96%)	409 (96%)	18 (4%)	0	100	100
2	2R	427/445 (96%)	409 (96%)	18 (4%)	0	100	100
2	2S	427/445 (96%)	409 (96%)	18 (4%)	0	100	100
2	2T	427/445 (96%)	409 (96%)	18 (4%)	0	100	100
2	2U	427/445 (96%)	409 (96%)	18 (4%)	0	100	100
2	2V	427/445 (96%)	409 (96%)	18 (4%)	0	100	100
2	2W	427/445 (96%)	409 (96%)	18 (4%)	0	100	100
2	2X	427/445 (96%)	409 (96%)	18 (4%)	0	100	100
2	2Y	427/445 (96%)	409 (96%)	18 (4%)	0	100	100
2	2Z	427/445 (96%)	409 (96%)	18 (4%)	0	100	100
2	3H	427/445 (96%)	409 (96%)	18 (4%)	0	100	100
2	3O	427/445 (96%)	409 (96%)	18 (4%)	0	100	100
2	3P	427/445 (96%)	409 (96%)	18 (4%)	0	100	100
2	3Q	427/445 (96%)	409 (96%)	18 (4%)	0	100	100
2	3R	427/445 (96%)	409 (96%)	18 (4%)	0	100	100
2	3S	427/445 (96%)	409 (96%)	18 (4%)	0	100	100
2	3T	427/445 (96%)	409 (96%)	18 (4%)	0	100	100
2	3U	427/445 (96%)	409 (96%)	18 (4%)	0	100	100
2	3V	427/445 (96%)	409 (96%)	18 (4%)	0	100	100
2	3W	427/445 (96%)	409 (96%)	18 (4%)	0	100	100
2	3X	427/445 (96%)	409 (96%)	18 (4%)	0	100	100
2	3Y	427/445 (96%)	409 (96%)	18 (4%)	0	100	100
2	3Z	427/445 (96%)	409 (96%)	18 (4%)	0	100	100
2	4H	427/445 (96%)	409 (96%)	18 (4%)	0	100	100
2	4O	427/445 (96%)	409 (96%)	18 (4%)	0	100	100
2	4P	427/445 (96%)	409 (96%)	18 (4%)	0	100	100
2	4Q	427/445 (96%)	409 (96%)	18 (4%)	0	100	100

*Continued on next page...*

Continued from previous page...

Mol	Chain	Analysed	Favoured	Allowed	Outliers	Percentiles	
2	4R	427/445 (96%)	409 (96%)	18 (4%)	0	100	100
2	4S	427/445 (96%)	409 (96%)	18 (4%)	0	100	100
2	4T	427/445 (96%)	409 (96%)	18 (4%)	0	100	100
2	4U	427/445 (96%)	409 (96%)	18 (4%)	0	100	100
2	4V	427/445 (96%)	409 (96%)	18 (4%)	0	100	100
2	4W	427/445 (96%)	409 (96%)	18 (4%)	0	100	100
2	4X	427/445 (96%)	409 (96%)	18 (4%)	0	100	100
2	4Y	427/445 (96%)	409 (96%)	18 (4%)	0	100	100
2	4Z	427/445 (96%)	409 (96%)	18 (4%)	0	100	100
All	All	44720/46592 (96%)	42848 (96%)	1872 (4%)	0	100	100

There are no Ramachandran outliers to report.

### 5.3.2 Protein sidechains [i](#)

In the following table, the Percentiles column shows the percent sidechain outliers of the chain as a percentile score with respect to all PDB entries followed by that with respect to all EM entries.

The Analysed column shows the number of residues for which the sidechain conformation was analysed, and the total number of residues.

Mol	Chain	Analysed	Rotameric	Outliers	Percentiles	
1	1A	368/379 (97%)	367 (100%)	1 (0%)	92	95
1	1B	368/379 (97%)	367 (100%)	1 (0%)	92	95
1	1C	368/379 (97%)	367 (100%)	1 (0%)	92	95
1	1D	368/379 (97%)	367 (100%)	1 (0%)	92	95
1	1E	368/379 (97%)	367 (100%)	1 (0%)	92	95
1	1F	368/379 (97%)	367 (100%)	1 (0%)	92	95
1	1G	368/379 (97%)	367 (100%)	1 (0%)	92	95
1	1I	368/379 (97%)	367 (100%)	1 (0%)	92	95
1	1J	368/379 (97%)	367 (100%)	1 (0%)	92	95
1	1K	368/379 (97%)	367 (100%)	1 (0%)	92	95
1	1L	368/379 (97%)	367 (100%)	1 (0%)	92	95
1	1M	368/379 (97%)	367 (100%)	1 (0%)	92	95

Continued on next page...

*Continued from previous page...*

Mol	Chain	Analysed	Rotameric	Outliers	Percentiles	
1	1N	368/379 (97%)	367 (100%)	1 (0%)	92	95
1	2A	368/379 (97%)	367 (100%)	1 (0%)	92	95
1	2B	368/379 (97%)	367 (100%)	1 (0%)	92	95
1	2C	368/379 (97%)	367 (100%)	1 (0%)	92	95
1	2D	368/379 (97%)	367 (100%)	1 (0%)	92	95
1	2E	368/379 (97%)	367 (100%)	1 (0%)	92	95
1	2F	368/379 (97%)	367 (100%)	1 (0%)	92	95
1	2G	368/379 (97%)	367 (100%)	1 (0%)	92	95
1	2I	368/379 (97%)	367 (100%)	1 (0%)	92	95
1	2J	368/379 (97%)	367 (100%)	1 (0%)	92	95
1	2K	368/379 (97%)	367 (100%)	1 (0%)	92	95
1	2L	368/379 (97%)	367 (100%)	1 (0%)	92	95
1	2M	368/379 (97%)	367 (100%)	1 (0%)	92	95
1	2N	368/379 (97%)	367 (100%)	1 (0%)	92	95
1	3A	368/379 (97%)	367 (100%)	1 (0%)	92	95
1	3B	368/379 (97%)	367 (100%)	1 (0%)	92	95
1	3C	368/379 (97%)	367 (100%)	1 (0%)	92	95
1	3D	368/379 (97%)	367 (100%)	1 (0%)	92	95
1	3E	368/379 (97%)	367 (100%)	1 (0%)	92	95
1	3F	368/379 (97%)	367 (100%)	1 (0%)	92	95
1	3G	368/379 (97%)	367 (100%)	1 (0%)	92	95
1	3I	368/379 (97%)	367 (100%)	1 (0%)	92	95
1	3J	368/379 (97%)	367 (100%)	1 (0%)	92	95
1	3K	368/379 (97%)	367 (100%)	1 (0%)	92	95
1	3L	368/379 (97%)	367 (100%)	1 (0%)	92	95
1	3M	368/379 (97%)	367 (100%)	1 (0%)	92	95
1	3N	368/379 (97%)	367 (100%)	1 (0%)	92	95
1	4A	368/379 (97%)	367 (100%)	1 (0%)	92	95
1	4B	368/379 (97%)	367 (100%)	1 (0%)	92	95
1	4C	368/379 (97%)	367 (100%)	1 (0%)	92	95
1	4D	368/379 (97%)	367 (100%)	1 (0%)	92	95

*Continued on next page...*

*Continued from previous page...*

Mol	Chain	Analysed	Rotameric	Outliers	Percentiles	
1	4E	368/379 (97%)	367 (100%)	1 (0%)	92	95
1	4F	368/379 (97%)	367 (100%)	1 (0%)	92	95
1	4G	368/379 (97%)	367 (100%)	1 (0%)	92	95
1	4I	368/379 (97%)	367 (100%)	1 (0%)	92	95
1	4J	368/379 (97%)	367 (100%)	1 (0%)	92	95
1	4K	368/379 (97%)	367 (100%)	1 (0%)	92	95
1	4L	368/379 (97%)	367 (100%)	1 (0%)	92	95
1	4M	368/379 (97%)	367 (100%)	1 (0%)	92	95
1	4N	368/379 (97%)	367 (100%)	1 (0%)	92	95
2	1H	368/381 (97%)	367 (100%)	1 (0%)	92	95
2	1O	368/381 (97%)	367 (100%)	1 (0%)	92	95
2	1P	368/381 (97%)	367 (100%)	1 (0%)	92	95
2	1Q	368/381 (97%)	367 (100%)	1 (0%)	92	95
2	1R	368/381 (97%)	367 (100%)	1 (0%)	92	95
2	1S	368/381 (97%)	367 (100%)	1 (0%)	92	95
2	1T	368/381 (97%)	367 (100%)	1 (0%)	92	95
2	1U	368/381 (97%)	367 (100%)	1 (0%)	92	95
2	1V	368/381 (97%)	367 (100%)	1 (0%)	92	95
2	1W	368/381 (97%)	367 (100%)	1 (0%)	92	95
2	1X	368/381 (97%)	367 (100%)	1 (0%)	92	95
2	1Y	368/381 (97%)	367 (100%)	1 (0%)	92	95
2	1Z	368/381 (97%)	367 (100%)	1 (0%)	92	95
2	2H	368/381 (97%)	367 (100%)	1 (0%)	92	95
2	2O	368/381 (97%)	367 (100%)	1 (0%)	92	95
2	2P	368/381 (97%)	367 (100%)	1 (0%)	92	95
2	2Q	368/381 (97%)	367 (100%)	1 (0%)	92	95
2	2R	368/381 (97%)	367 (100%)	1 (0%)	92	95
2	2S	368/381 (97%)	367 (100%)	1 (0%)	92	95
2	2T	368/381 (97%)	367 (100%)	1 (0%)	92	95
2	2U	368/381 (97%)	367 (100%)	1 (0%)	92	95
2	2V	368/381 (97%)	367 (100%)	1 (0%)	92	95

*Continued on next page...*

*Continued from previous page...*

Mol	Chain	Analysed	Rotameric	Outliers	Percentiles	
2	2W	368/381 (97%)	367 (100%)	1 (0%)	92	95
2	2X	368/381 (97%)	367 (100%)	1 (0%)	92	95
2	2Y	368/381 (97%)	367 (100%)	1 (0%)	92	95
2	2Z	368/381 (97%)	367 (100%)	1 (0%)	92	95
2	3H	368/381 (97%)	367 (100%)	1 (0%)	92	95
2	3O	368/381 (97%)	367 (100%)	1 (0%)	92	95
2	3P	368/381 (97%)	367 (100%)	1 (0%)	92	95
2	3Q	368/381 (97%)	367 (100%)	1 (0%)	92	95
2	3R	368/381 (97%)	367 (100%)	1 (0%)	92	95
2	3S	368/381 (97%)	367 (100%)	1 (0%)	92	95
2	3T	368/381 (97%)	367 (100%)	1 (0%)	92	95
2	3U	368/381 (97%)	367 (100%)	1 (0%)	92	95
2	3V	368/381 (97%)	367 (100%)	1 (0%)	92	95
2	3W	368/381 (97%)	367 (100%)	1 (0%)	92	95
2	3X	368/381 (97%)	367 (100%)	1 (0%)	92	95
2	3Y	368/381 (97%)	367 (100%)	1 (0%)	92	95
2	3Z	368/381 (97%)	367 (100%)	1 (0%)	92	95
2	4H	368/381 (97%)	367 (100%)	1 (0%)	92	95
2	4O	368/381 (97%)	367 (100%)	1 (0%)	92	95
2	4P	368/381 (97%)	367 (100%)	1 (0%)	92	95
2	4Q	368/381 (97%)	367 (100%)	1 (0%)	92	95
2	4R	368/381 (97%)	367 (100%)	1 (0%)	92	95
2	4S	368/381 (97%)	367 (100%)	1 (0%)	92	95
2	4T	368/381 (97%)	367 (100%)	1 (0%)	92	95
2	4U	368/381 (97%)	367 (100%)	1 (0%)	92	95
2	4V	368/381 (97%)	367 (100%)	1 (0%)	92	95
2	4W	368/381 (97%)	367 (100%)	1 (0%)	92	95
2	4X	368/381 (97%)	367 (100%)	1 (0%)	92	95
2	4Y	368/381 (97%)	367 (100%)	1 (0%)	92	95
2	4Z	368/381 (97%)	367 (100%)	1 (0%)	92	95
All	All	38272/39520 (97%)	38168 (100%)	104 (0%)	92	95



5 of 104 residues with a non-rotameric sidechain are listed below:

Mol	Chain	Res	Type
1	3F	339	ARG
2	3T	300	ASN
2	4V	300	ASN
1	3I	339	ARG
2	3H	300	ASN

Sometimes sidechains can be flipped to improve hydrogen bonding and reduce clashes. 5 of 768 such sidechains are listed below:

Mol	Chain	Res	Type
1	3K	8	HIS
2	3Z	294	GLN
1	3L	258	ASN
1	3J	258	ASN
2	3R	294	GLN

### 5.3.3 RNA [i](#)

There are no RNA molecules in this entry.

## 5.4 Non-standard residues in protein, DNA, RNA chains [i](#)

There are no non-standard protein/DNA/RNA residues in this entry.

## 5.5 Carbohydrates [i](#)

There are no monosaccharides in this entry.

## 5.6 Ligand geometry [i](#)

Of 156 ligands modelled in this entry, 52 are monoatomic - leaving 104 for Mogul analysis.

In the following table, the Counts columns list the number of bonds (or angles) for which Mogul statistics could be retrieved, the number of bonds (or angles) that are observed in the model and the number of bonds (or angles) that are defined in the Chemical Component Dictionary. The Link column lists molecule types, if any, to which the group is linked. The Z score for a bond length (or angle) is the number of standard deviations the observed value is removed from the expected value. A bond length (or angle) with  $|Z| > 2$  is considered an outlier worth inspection. RMSZ is the root-mean-square of all Z scores of the bond lengths (or angles).

Mol	Type	Chain	Res	Link	Bond lengths			Bond angles		
					Counts	RMSZ	# Z  > 2	Counts	RMSZ	# Z  > 2
3	GTP	4J	501	4	26,34,34	1.20	1 (3%)	32,54,54	1.67	6 (18%)
5	GDP	1O	501	-	24,30,30	0.97	1 (4%)	30,47,47	1.36	4 (13%)
5	GDP	3Q	501	-	24,30,30	0.98	1 (4%)	30,47,47	1.36	4 (13%)
3	GTP	4A	501	4	26,34,34	1.19	1 (3%)	32,54,54	1.66	6 (18%)
3	GTP	2F	501	4	26,34,34	1.19	1 (3%)	32,54,54	1.66	6 (18%)
5	GDP	1W	501	-	24,30,30	0.97	1 (4%)	30,47,47	1.36	4 (13%)
3	GTP	1K	501	4	26,34,34	1.19	2 (7%)	32,54,54	1.66	6 (18%)
5	GDP	3Y	501	-	24,30,30	0.98	1 (4%)	30,47,47	1.36	4 (13%)
3	GTP	3A	501	4	26,34,34	1.19	1 (3%)	32,54,54	1.66	6 (18%)
5	GDP	4R	501	-	24,30,30	0.98	1 (4%)	30,47,47	1.36	4 (13%)
3	GTP	4B	501	4	26,34,34	1.20	1 (3%)	32,54,54	1.66	6 (18%)
5	GDP	1Y	501	-	24,30,30	0.97	1 (4%)	30,47,47	1.36	4 (13%)
3	GTP	1E	501	4	26,34,34	1.20	1 (3%)	32,54,54	1.66	6 (18%)
5	GDP	4Q	501	-	24,30,30	0.97	1 (4%)	30,47,47	1.36	4 (13%)
5	GDP	1S	501	-	24,30,30	0.98	1 (4%)	30,47,47	1.36	4 (13%)
5	GDP	2T	501	-	24,30,30	0.97	1 (4%)	30,47,47	1.36	4 (13%)
3	GTP	3D	501	4	26,34,34	1.19	1 (3%)	32,54,54	1.66	7 (21%)
3	GTP	1G	501	4	26,34,34	1.20	1 (3%)	32,54,54	1.66	6 (18%)
3	GTP	4C	501	4	26,34,34	1.19	1 (3%)	32,54,54	1.66	6 (18%)
3	GTP	3E	501	4	26,34,34	1.19	1 (3%)	32,54,54	1.66	6 (18%)
5	GDP	2V	501	-	24,30,30	0.98	1 (4%)	30,47,47	1.36	4 (13%)
5	GDP	2U	501	-	24,30,30	0.98	1 (4%)	30,47,47	1.36	4 (13%)
5	GDP	4U	501	-	24,30,30	0.98	1 (4%)	30,47,47	1.36	4 (13%)
3	GTP	1F	501	4	26,34,34	1.19	1 (3%)	32,54,54	1.67	7 (21%)
3	GTP	4I	501	4	26,34,34	1.20	1 (3%)	32,54,54	1.66	6 (18%)
3	GTP	3F	501	4	26,34,34	1.19	1 (3%)	32,54,54	1.66	6 (18%)
3	GTP	3K	501	4	26,34,34	1.20	1 (3%)	32,54,54	1.66	6 (18%)
5	GDP	4W	501	-	24,30,30	0.97	1 (4%)	30,47,47	1.36	4 (13%)
3	GTP	4L	501	4	26,34,34	1.19	1 (3%)	32,54,54	1.66	6 (18%)
3	GTP	3G	501	4	26,34,34	1.20	2 (7%)	32,54,54	1.66	6 (18%)
5	GDP	2W	501	-	24,30,30	0.99	1 (4%)	30,47,47	1.36	4 (13%)
5	GDP	3R	501	-	24,30,30	0.97	1 (4%)	30,47,47	1.35	4 (13%)
5	GDP	4T	501	-	24,30,30	0.97	1 (4%)	30,47,47	1.36	4 (13%)
3	GTP	3L	501	4	26,34,34	1.20	1 (3%)	32,54,54	1.66	6 (18%)
5	GDP	2O	501	-	24,30,30	0.97	1 (4%)	30,47,47	1.36	4 (13%)

Mol	Type	Chain	Res	Link	Bond lengths			Bond angles		
					Counts	RMSZ	# Z  > 2	Counts	RMSZ	# Z  > 2
3	GTP	1J	501	4	26,34,34	1.19	2 (7%)	32,54,54	1.66	6 (18%)
3	GTP	2K	501	4	26,34,34	1.19	1 (3%)	32,54,54	1.66	7 (21%)
3	GTP	4D	501	4	26,34,34	1.20	2 (7%)	32,54,54	1.66	6 (18%)
3	GTP	2B	501	4	26,34,34	1.20	1 (3%)	32,54,54	1.66	6 (18%)
5	GDP	2S	501	-	24,30,30	0.98	1 (4%)	30,47,47	1.36	4 (13%)
5	GDP	3Z	501	-	24,30,30	0.97	1 (4%)	30,47,47	1.36	4 (13%)
3	GTP	2N	501	4	26,34,34	1.20	2 (7%)	32,54,54	1.66	6 (18%)
3	GTP	3B	501	4	26,34,34	1.19	1 (3%)	32,54,54	1.66	6 (18%)
3	GTP	2I	501	4	26,34,34	1.19	1 (3%)	32,54,54	1.66	6 (18%)
3	GTP	1I	501	4	26,34,34	1.19	1 (3%)	32,54,54	1.66	6 (18%)
5	GDP	4S	501	-	24,30,30	0.97	1 (4%)	30,47,47	1.35	4 (13%)
3	GTP	4F	501	4	26,34,34	1.19	1 (3%)	32,54,54	1.66	6 (18%)
3	GTP	1A	501	4	26,34,34	1.20	1 (3%)	32,54,54	1.66	6 (18%)
3	GTP	3J	501	4	26,34,34	1.19	1 (3%)	32,54,54	1.66	6 (18%)
5	GDP	3P	501	-	24,30,30	0.98	1 (4%)	30,47,47	1.36	4 (13%)
5	GDP	4V	501	-	24,30,30	0.98	1 (4%)	30,47,47	1.36	4 (13%)
5	GDP	1Z	501	-	24,30,30	0.97	1 (4%)	30,47,47	1.36	4 (13%)
5	GDP	3W	501	-	24,30,30	0.99	1 (4%)	30,47,47	1.36	4 (13%)
5	GDP	4H	501	-	24,30,30	0.98	1 (4%)	30,47,47	1.36	4 (13%)
3	GTP	1B	501	4	26,34,34	1.19	1 (3%)	32,54,54	1.66	6 (18%)
5	GDP	1Q	501	-	24,30,30	0.98	1 (4%)	30,47,47	1.36	4 (13%)
3	GTP	2E	501	4	26,34,34	1.20	1 (3%)	32,54,54	1.67	6 (18%)
5	GDP	1P	501	-	24,30,30	0.97	1 (4%)	30,47,47	1.36	4 (13%)
3	GTP	4N	501	4	26,34,34	1.19	1 (3%)	32,54,54	1.66	6 (18%)
3	GTP	1L	501	4	26,34,34	1.20	2 (7%)	32,54,54	1.66	6 (18%)
3	GTP	3C	501	4	26,34,34	1.20	1 (3%)	32,54,54	1.66	6 (18%)
5	GDP	4Z	501	-	24,30,30	0.98	1 (4%)	30,47,47	1.36	4 (13%)
5	GDP	1T	501	-	24,30,30	0.98	1 (4%)	30,47,47	1.36	4 (13%)
3	GTP	4K	501	4	26,34,34	1.20	2 (7%)	32,54,54	1.66	6 (18%)
5	GDP	2H	501	-	24,30,30	0.98	1 (4%)	30,47,47	1.36	4 (13%)
5	GDP	1X	501	-	24,30,30	0.99	1 (4%)	30,47,47	1.36	4 (13%)
3	GTP	1D	501	4	26,34,34	1.20	2 (7%)	32,54,54	1.67	6 (18%)
5	GDP	3O	501	-	24,30,30	0.98	1 (4%)	30,47,47	1.36	4 (13%)
5	GDP	4P	501	-	24,30,30	0.98	1 (4%)	30,47,47	1.36	4 (13%)
3	GTP	1N	501	4	26,34,34	1.20	1 (3%)	32,54,54	1.66	6 (18%)

Mol	Type	Chain	Res	Link	Bond lengths			Bond angles		
					Counts	RMSZ	# Z  > 2	Counts	RMSZ	# Z  > 2
3	GTP	2L	501	4	26,34,34	1.20	1 (3%)	32,54,54	1.66	6 (18%)
3	GTP	2D	501	4	26,34,34	1.19	1 (3%)	32,54,54	1.66	6 (18%)
3	GTP	1M	501	4	26,34,34	1.20	2 (7%)	32,54,54	1.66	7 (21%)
5	GDP	1U	501	-	24,30,30	0.98	1 (4%)	30,47,47	1.36	4 (13%)
3	GTP	4E	501	4	26,34,34	1.20	1 (3%)	32,54,54	1.66	6 (18%)
5	GDP	3U	501	-	24,30,30	0.98	1 (4%)	30,47,47	1.36	4 (13%)
3	GTP	2M	501	4	26,34,34	1.20	2 (7%)	32,54,54	1.66	6 (18%)
3	GTP	3N	501	4	26,34,34	1.19	1 (3%)	32,54,54	1.66	7 (21%)
5	GDP	4X	501	-	24,30,30	0.98	1 (4%)	30,47,47	1.35	4 (13%)
5	GDP	2Y	501	-	24,30,30	0.98	1 (4%)	30,47,47	1.36	4 (13%)
5	GDP	2Q	501	-	24,30,30	0.98	1 (4%)	30,47,47	1.35	4 (13%)
3	GTP	3M	501	4	26,34,34	1.19	1 (3%)	32,54,54	1.66	6 (18%)
5	GDP	4Y	501	-	24,30,30	0.99	1 (4%)	30,47,47	1.36	4 (13%)
3	GTP	2J	501	4	26,34,34	1.20	2 (7%)	32,54,54	1.66	6 (18%)
3	GTP	2G	501	4	26,34,34	1.19	1 (3%)	32,54,54	1.66	6 (18%)
5	GDP	2R	501	-	24,30,30	0.98	1 (4%)	30,47,47	1.36	4 (13%)
5	GDP	1R	501	-	24,30,30	0.99	1 (4%)	30,47,47	1.36	4 (13%)
5	GDP	3T	501	-	24,30,30	0.98	1 (4%)	30,47,47	1.36	4 (13%)
3	GTP	2C	501	4	26,34,34	1.19	1 (3%)	32,54,54	1.66	6 (18%)
3	GTP	3I	501	4	26,34,34	1.19	1 (3%)	32,54,54	1.66	6 (18%)
5	GDP	3H	501	-	24,30,30	0.97	1 (4%)	30,47,47	1.36	4 (13%)
5	GDP	2P	501	-	24,30,30	0.98	1 (4%)	30,47,47	1.36	4 (13%)
5	GDP	3V	501	-	24,30,30	0.98	1 (4%)	30,47,47	1.36	4 (13%)
5	GDP	3X	501	-	24,30,30	0.98	1 (4%)	30,47,47	1.36	4 (13%)
3	GTP	2A	501	4	26,34,34	1.20	2 (7%)	32,54,54	1.66	6 (18%)
5	GDP	2X	501	-	24,30,30	0.97	1 (4%)	30,47,47	1.36	4 (13%)
3	GTP	1C	501	4	26,34,34	1.20	1 (3%)	32,54,54	1.66	6 (18%)
5	GDP	2Z	501	-	24,30,30	0.97	1 (4%)	30,47,47	1.36	4 (13%)
5	GDP	1H	501	-	24,30,30	0.97	1 (4%)	30,47,47	1.36	4 (13%)
3	GTP	4M	501	4	26,34,34	1.19	1 (3%)	32,54,54	1.66	7 (21%)
5	GDP	4O	501	-	24,30,30	0.98	1 (4%)	30,47,47	1.36	4 (13%)
5	GDP	3S	501	-	24,30,30	0.97	1 (4%)	30,47,47	1.36	4 (13%)
5	GDP	1V	501	-	24,30,30	0.98	1 (4%)	30,47,47	1.36	4 (13%)
3	GTP	4G	501	4	26,34,34	1.20	1 (3%)	32,54,54	1.67	7 (21%)

In the following table, the Chirals column lists the number of chiral outliers, the number of chiral centers analysed, the number of these observed in the model and the number defined in the Chemical Component Dictionary. Similar counts are reported in the Torsion and Rings columns. '-' means no outliers of that kind were identified.

Mol	Type	Chain	Res	Link	Chirals	Torsions	Rings
3	GTP	4J	501	4	-	6/18/38/38	0/3/3/3
5	GDP	1O	501	-	-	4/12/32/32	0/3/3/3
5	GDP	3Q	501	-	-	4/12/32/32	0/3/3/3
3	GTP	4A	501	4	-	6/18/38/38	0/3/3/3
3	GTP	2F	501	4	-	6/18/38/38	0/3/3/3
5	GDP	1W	501	-	-	4/12/32/32	0/3/3/3
3	GTP	1K	501	4	-	6/18/38/38	0/3/3/3
5	GDP	3Y	501	-	-	4/12/32/32	0/3/3/3
3	GTP	3A	501	4	-	6/18/38/38	0/3/3/3
5	GDP	4R	501	-	-	4/12/32/32	0/3/3/3
3	GTP	4B	501	4	-	6/18/38/38	0/3/3/3
5	GDP	1Y	501	-	-	4/12/32/32	0/3/3/3
3	GTP	1E	501	4	-	6/18/38/38	0/3/3/3
5	GDP	4Q	501	-	-	4/12/32/32	0/3/3/3
5	GDP	1S	501	-	-	4/12/32/32	0/3/3/3
5	GDP	2T	501	-	-	4/12/32/32	0/3/3/3
3	GTP	3D	501	4	-	6/18/38/38	0/3/3/3
3	GTP	1G	501	4	-	6/18/38/38	0/3/3/3
3	GTP	4C	501	4	-	6/18/38/38	0/3/3/3
3	GTP	3E	501	4	-	6/18/38/38	0/3/3/3
5	GDP	2V	501	-	-	4/12/32/32	0/3/3/3
5	GDP	2U	501	-	-	4/12/32/32	0/3/3/3
5	GDP	4U	501	-	-	4/12/32/32	0/3/3/3
3	GTP	1F	501	4	-	6/18/38/38	0/3/3/3
3	GTP	4I	501	4	-	6/18/38/38	0/3/3/3
3	GTP	3F	501	4	-	6/18/38/38	0/3/3/3
3	GTP	3K	501	4	-	6/18/38/38	0/3/3/3
5	GDP	4W	501	-	-	4/12/32/32	0/3/3/3
3	GTP	4L	501	4	-	6/18/38/38	0/3/3/3
3	GTP	3G	501	4	-	6/18/38/38	0/3/3/3
5	GDP	2W	501	-	-	4/12/32/32	0/3/3/3

*Continued on next page...*

*Continued from previous page...*

Mol	Type	Chain	Res	Link	Chirals	Torsions	Rings
5	GDP	3R	501	-	-	4/12/32/32	0/3/3/3
5	GDP	4T	501	-	-	4/12/32/32	0/3/3/3
3	GTP	3L	501	4	-	6/18/38/38	0/3/3/3
5	GDP	2O	501	-	-	4/12/32/32	0/3/3/3
3	GTP	1J	501	4	-	6/18/38/38	0/3/3/3
3	GTP	2K	501	4	-	6/18/38/38	0/3/3/3
3	GTP	4D	501	4	-	6/18/38/38	0/3/3/3
3	GTP	2B	501	4	-	6/18/38/38	0/3/3/3
5	GDP	2S	501	-	-	4/12/32/32	0/3/3/3
5	GDP	3Z	501	-	-	4/12/32/32	0/3/3/3
3	GTP	2N	501	4	-	6/18/38/38	0/3/3/3
3	GTP	3B	501	4	-	6/18/38/38	0/3/3/3
3	GTP	2I	501	4	-	6/18/38/38	0/3/3/3
3	GTP	1I	501	4	-	6/18/38/38	0/3/3/3
5	GDP	4S	501	-	-	4/12/32/32	0/3/3/3
3	GTP	4F	501	4	-	6/18/38/38	0/3/3/3
3	GTP	1A	501	4	-	6/18/38/38	0/3/3/3
3	GTP	3J	501	4	-	6/18/38/38	0/3/3/3
5	GDP	3P	501	-	-	4/12/32/32	0/3/3/3
5	GDP	4V	501	-	-	4/12/32/32	0/3/3/3
5	GDP	1Z	501	-	-	4/12/32/32	0/3/3/3
5	GDP	3W	501	-	-	4/12/32/32	0/3/3/3
5	GDP	4H	501	-	-	4/12/32/32	0/3/3/3
3	GTP	1B	501	4	-	6/18/38/38	0/3/3/3
5	GDP	1Q	501	-	-	4/12/32/32	0/3/3/3
3	GTP	2E	501	4	-	6/18/38/38	0/3/3/3
5	GDP	1P	501	-	-	4/12/32/32	0/3/3/3
3	GTP	4N	501	4	-	6/18/38/38	0/3/3/3
3	GTP	1L	501	4	-	6/18/38/38	0/3/3/3
3	GTP	3C	501	4	-	6/18/38/38	0/3/3/3
5	GDP	4Z	501	-	-	4/12/32/32	0/3/3/3
5	GDP	1T	501	-	-	4/12/32/32	0/3/3/3
3	GTP	4K	501	4	-	6/18/38/38	0/3/3/3
5	GDP	2H	501	-	-	4/12/32/32	0/3/3/3

*Continued on next page...*

*Continued from previous page...*

Mol	Type	Chain	Res	Link	Chirals	Torsions	Rings
5	GDP	1X	501	-	-	4/12/32/32	0/3/3/3
3	GTP	1D	501	4	-	6/18/38/38	0/3/3/3
5	GDP	3O	501	-	-	4/12/32/32	0/3/3/3
5	GDP	4P	501	-	-	4/12/32/32	0/3/3/3
3	GTP	1N	501	4	-	6/18/38/38	0/3/3/3
3	GTP	2L	501	4	-	6/18/38/38	0/3/3/3
3	GTP	2D	501	4	-	6/18/38/38	0/3/3/3
3	GTP	1M	501	4	-	6/18/38/38	0/3/3/3
5	GDP	1U	501	-	-	4/12/32/32	0/3/3/3
3	GTP	4E	501	4	-	6/18/38/38	0/3/3/3
5	GDP	3U	501	-	-	4/12/32/32	0/3/3/3
3	GTP	2M	501	4	-	6/18/38/38	0/3/3/3
3	GTP	3N	501	4	-	6/18/38/38	0/3/3/3
5	GDP	4X	501	-	-	4/12/32/32	0/3/3/3
5	GDP	2Y	501	-	-	4/12/32/32	0/3/3/3
5	GDP	2Q	501	-	-	4/12/32/32	0/3/3/3
3	GTP	3M	501	4	-	6/18/38/38	0/3/3/3
5	GDP	4Y	501	-	-	4/12/32/32	0/3/3/3
3	GTP	2J	501	4	-	6/18/38/38	0/3/3/3
3	GTP	2G	501	4	-	6/18/38/38	0/3/3/3
5	GDP	2R	501	-	-	4/12/32/32	0/3/3/3
5	GDP	1R	501	-	-	4/12/32/32	0/3/3/3
5	GDP	3T	501	-	-	4/12/32/32	0/3/3/3
3	GTP	2C	501	4	-	6/18/38/38	0/3/3/3
3	GTP	3I	501	4	-	6/18/38/38	0/3/3/3
5	GDP	3H	501	-	-	4/12/32/32	0/3/3/3
5	GDP	2P	501	-	-	4/12/32/32	0/3/3/3
5	GDP	3V	501	-	-	4/12/32/32	0/3/3/3
5	GDP	3X	501	-	-	4/12/32/32	0/3/3/3
3	GTP	2A	501	4	-	6/18/38/38	0/3/3/3
5	GDP	2X	501	-	-	4/12/32/32	0/3/3/3
3	GTP	1C	501	4	-	6/18/38/38	0/3/3/3
5	GDP	2Z	501	-	-	4/12/32/32	0/3/3/3
5	GDP	1H	501	-	-	4/12/32/32	0/3/3/3

*Continued on next page...*

*Continued from previous page...*

Mol	Type	Chain	Res	Link	Chirals	Torsions	Rings
3	GTP	4M	501	4	-	6/18/38/38	0/3/3/3
5	GDP	4O	501	-	-	4/12/32/32	0/3/3/3
5	GDP	3S	501	-	-	4/12/32/32	0/3/3/3
5	GDP	1V	501	-	-	4/12/32/32	0/3/3/3
3	GTP	4G	501	4	-	6/18/38/38	0/3/3/3

The worst 5 of 116 bond length outliers are listed below:

Mol	Chain	Res	Type	Atoms	Z	Observed(Å)	Ideal(Å)
3	4J	501	GTP	C5-C6	-4.19	1.38	1.47
3	1A	501	GTP	C5-C6	-4.19	1.38	1.47
3	4I	501	GTP	C5-C6	-4.18	1.38	1.47
3	2N	501	GTP	C5-C6	-4.17	1.38	1.47
3	1N	501	GTP	C5-C6	-4.17	1.38	1.47

The worst 5 of 527 bond angle outliers are listed below:

Mol	Chain	Res	Type	Atoms	Z	Observed(°)	Ideal(°)
3	2D	501	GTP	PB-O3B-PG	-4.35	117.91	132.83
3	4F	501	GTP	PB-O3B-PG	-4.35	117.91	132.83
3	1C	501	GTP	PB-O3B-PG	-4.34	117.92	132.83
3	4I	501	GTP	PB-O3B-PG	-4.34	117.92	132.83
3	4J	501	GTP	PB-O3B-PG	-4.34	117.92	132.83

There are no chirality outliers.

5 of 520 torsion outliers are listed below:

Mol	Chain	Res	Type	Atoms
3	1A	501	GTP	C5'-O5'-PA-O1A
3	1A	501	GTP	C5'-O5'-PA-O2A
3	1B	501	GTP	C5'-O5'-PA-O1A
3	1B	501	GTP	C5'-O5'-PA-O2A
3	1C	501	GTP	C5'-O5'-PA-O1A

There are no ring outliers.

104 monomers are involved in 391 short contacts:

Mol	Chain	Res	Type	Clashes	Symm-Clashes
3	4J	501	GTP	2	0
5	1O	501	GDP	4	0

*Continued on next page...*



*Continued from previous page...*

Mol	Chain	Res	Type	Clashes	Symm-Clashes
5	3Q	501	GDP	3	0
3	4A	501	GTP	2	0
3	2F	501	GTP	2	0
5	1W	501	GDP	4	0
3	1K	501	GTP	2	0
5	3Y	501	GDP	3	0
3	3A	501	GTP	2	0
5	4R	501	GDP	9	0
3	4B	501	GTP	2	0
5	1Y	501	GDP	5	0
3	1E	501	GTP	2	0
5	4Q	501	GDP	10	0
5	1S	501	GDP	3	0
5	2T	501	GDP	8	0
3	3D	501	GTP	2	0
3	1G	501	GTP	2	0
3	4C	501	GTP	2	0
3	3E	501	GTP	2	0
5	2V	501	GDP	8	0
5	2U	501	GDP	8	0
5	4U	501	GDP	7	0
3	1F	501	GTP	2	0
3	4I	501	GTP	2	0
3	3F	501	GTP	2	0
3	3K	501	GTP	2	0
5	4W	501	GDP	6	0
3	4L	501	GTP	2	0
3	3G	501	GTP	2	0
5	2W	501	GDP	8	0
5	3R	501	GDP	3	0
5	4T	501	GDP	7	0
3	3L	501	GTP	2	0
5	2O	501	GDP	7	0
3	1J	501	GTP	2	0
3	2K	501	GTP	2	0
3	4D	501	GTP	2	0
3	2B	501	GTP	2	0
5	2S	501	GDP	8	0
5	3Z	501	GDP	3	0
3	2N	501	GTP	2	0
3	3B	501	GTP	2	0
3	2I	501	GTP	2	0

*Continued on next page...*

*Continued from previous page...*

Mol	Chain	Res	Type	Clashes	Symm-Clashes
3	1I	501	GTP	2	0
5	4S	501	GDP	7	0
3	4F	501	GTP	2	0
3	1A	501	GTP	2	0
3	3J	501	GTP	2	0
5	3P	501	GDP	3	0
5	4V	501	GDP	7	0
5	1Z	501	GDP	6	0
5	3W	501	GDP	3	0
5	4H	501	GDP	8	0
3	1B	501	GTP	2	0
5	1Q	501	GDP	3	0
3	2E	501	GTP	2	0
5	1P	501	GDP	3	0
3	4N	501	GTP	2	0
3	1L	501	GTP	2	0
3	3C	501	GTP	2	0
5	4Z	501	GDP	8	0
5	1T	501	GDP	3	0
3	4K	501	GTP	2	0
5	2H	501	GDP	7	0
5	1X	501	GDP	5	0
3	1D	501	GTP	2	0
5	3O	501	GDP	3	0
5	4P	501	GDP	9	0
3	1N	501	GTP	2	0
3	2L	501	GTP	2	0
3	2D	501	GTP	2	0
3	1M	501	GTP	2	0
5	1U	501	GDP	3	0
3	4E	501	GTP	2	0
5	3U	501	GDP	3	0
3	2M	501	GTP	2	0
3	3N	501	GTP	2	0
5	4X	501	GDP	6	0
5	2Y	501	GDP	8	0
5	2Q	501	GDP	7	0
3	3M	501	GTP	2	0
5	4Y	501	GDP	6	0
3	2J	501	GTP	2	0
3	2G	501	GTP	2	0
5	2R	501	GDP	7	0

*Continued on next page...*

*Continued from previous page...*

Mol	Chain	Res	Type	Clashes	Symm-Clashes
5	1R	501	GDP	3	0
5	3T	501	GDP	3	0
3	2C	501	GTP	2	0
3	3I	501	GTP	2	0
5	3H	501	GDP	3	0
5	2P	501	GDP	7	0
5	3V	501	GDP	3	0
5	3X	501	GDP	3	0
3	2A	501	GTP	2	0
5	2X	501	GDP	8	0
3	1C	501	GTP	2	0
5	2Z	501	GDP	7	0
5	1H	501	GDP	5	0
3	4M	501	GTP	2	0
5	4O	501	GDP	9	0
5	3S	501	GDP	3	0
5	1V	501	GDP	4	0
3	4G	501	GTP	2	0

The following is a two-dimensional graphical depiction of Mogul quality analysis of bond lengths, bond angles, torsion angles, and ring geometry for all instances of the Ligand of Interest. In addition, ligands with molecular weight > 250 and outliers as shown on the validation Tables will also be included. For torsion angles, if less than 5% of the Mogul distribution of torsion angles is within 10 degrees of the torsion angle in question, then that torsion angle is considered an outlier. Any bond that is central to one or more torsion angles identified as an outlier by Mogul will be highlighted in the graph. For rings, the root-mean-square deviation (RMSD) between the ring in question and similar rings identified by Mogul is calculated over all ring torsion angles. If the average RMSD is greater than 60 degrees and the minimal RMSD between the ring in question and any Mogul-identified rings is also greater than 60 degrees, then that ring is considered an outlier. The outliers are highlighted in purple. The color gray indicates Mogul did not find sufficient equivalents in the CSD to analyse the geometry.

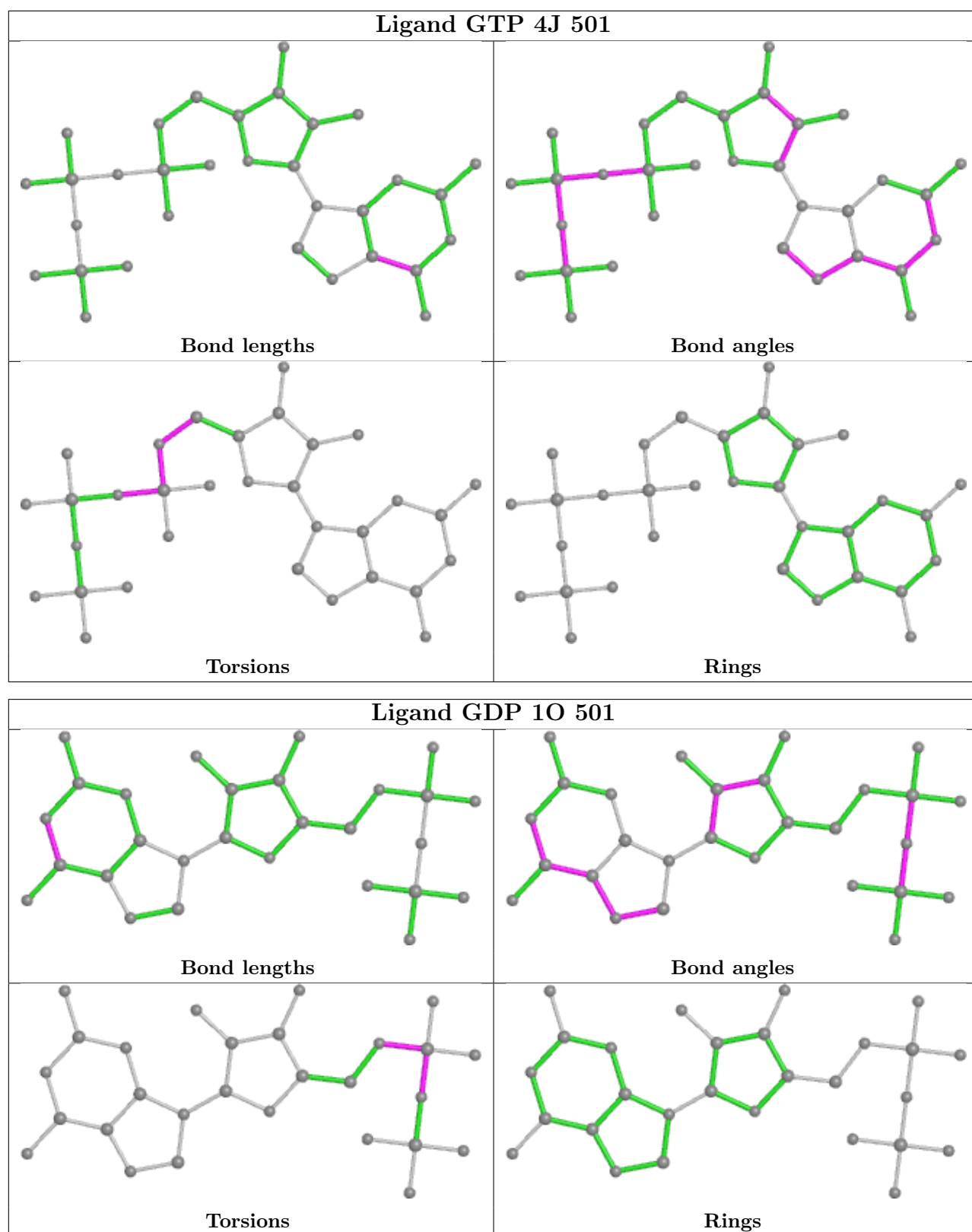

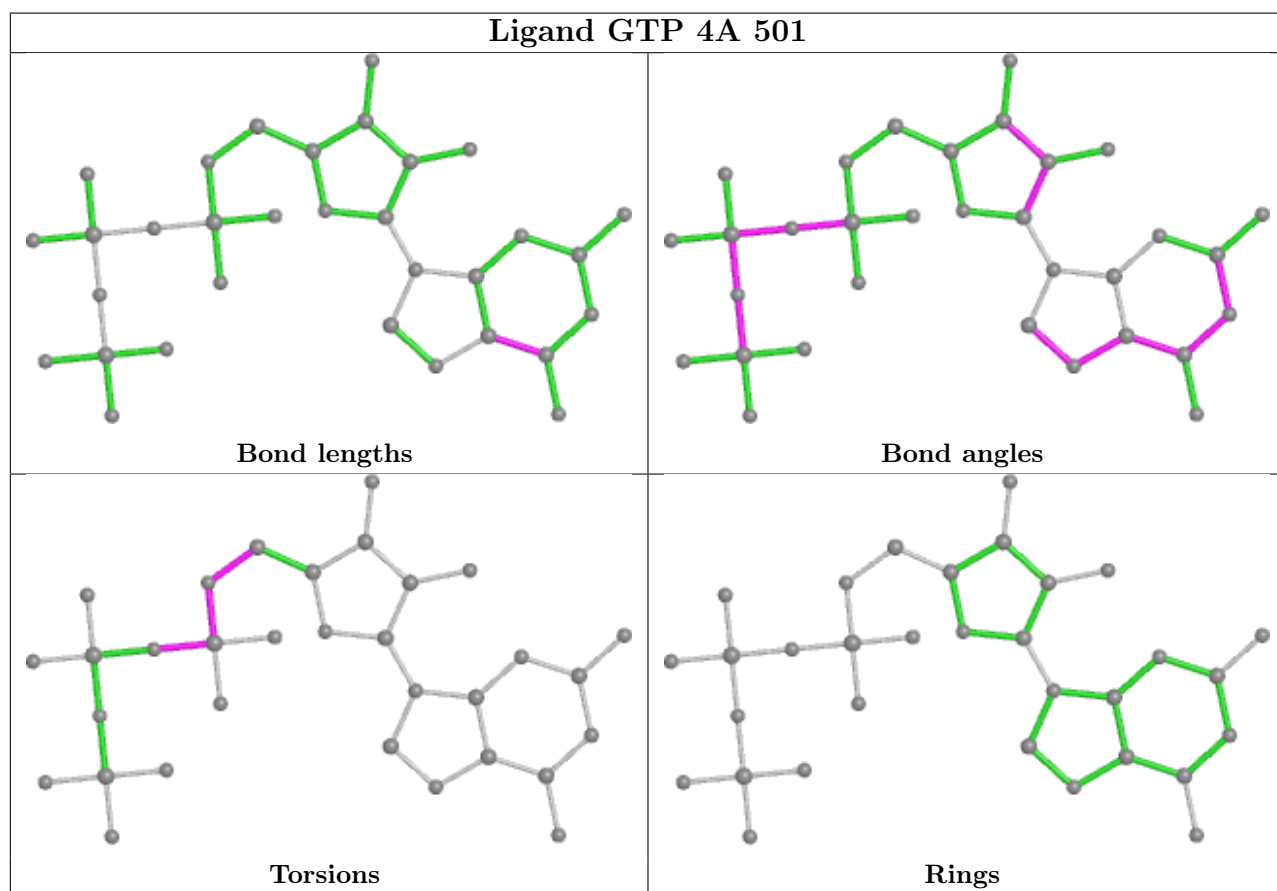
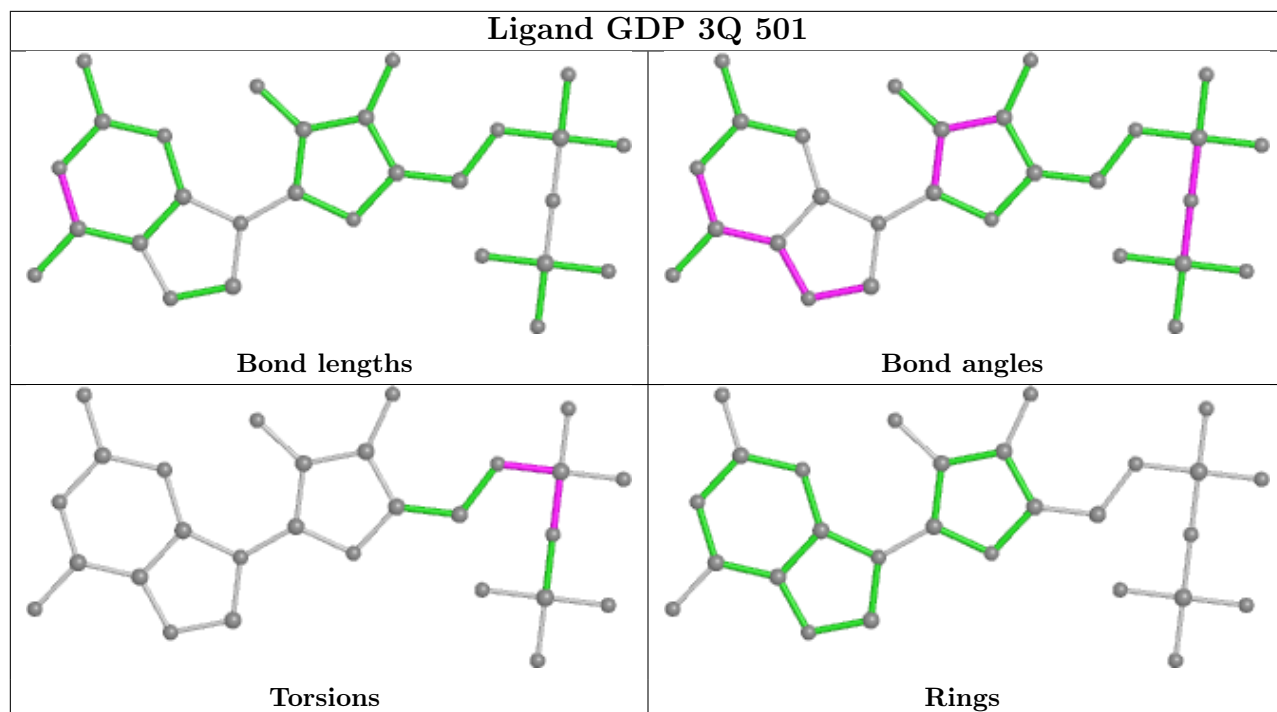

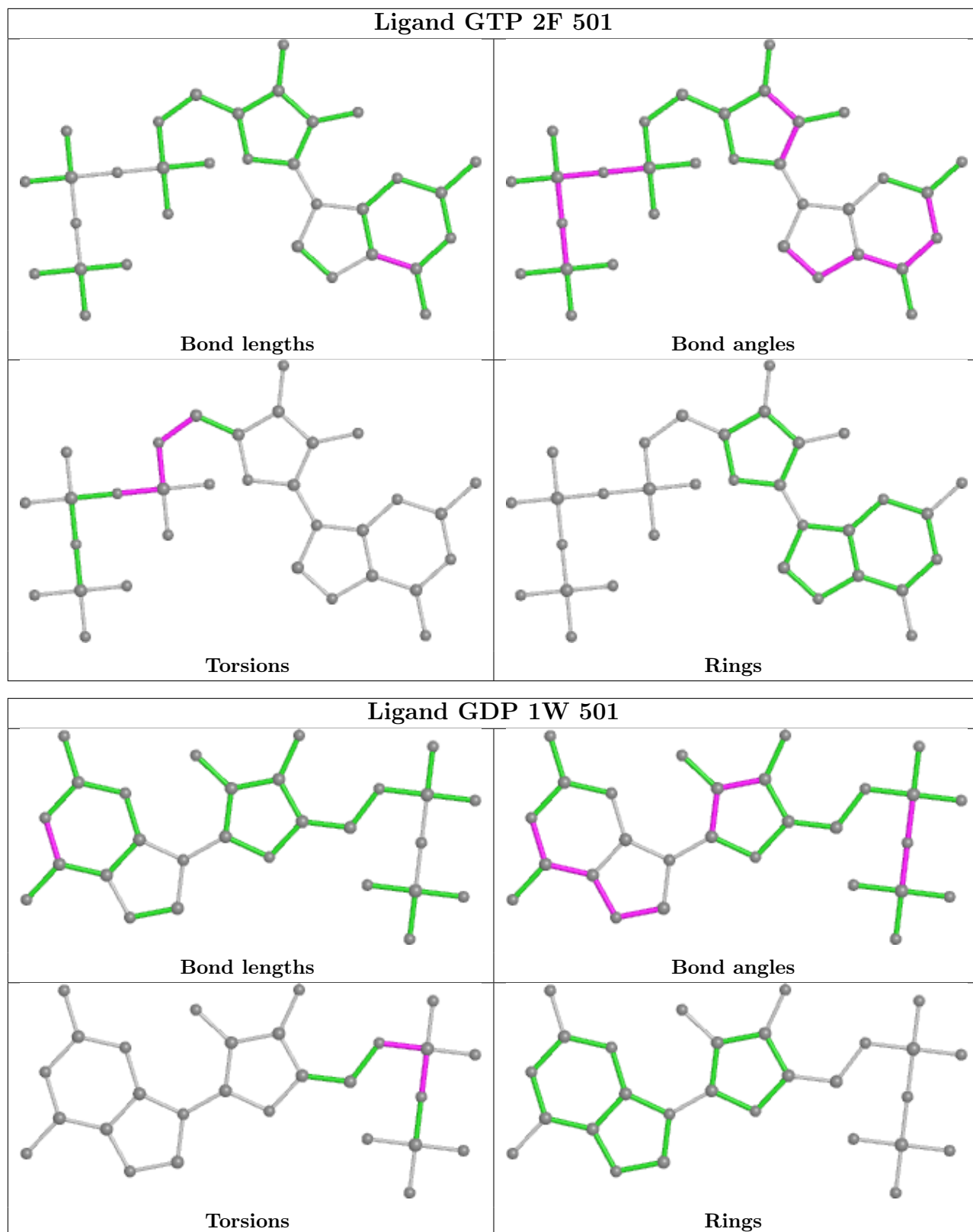

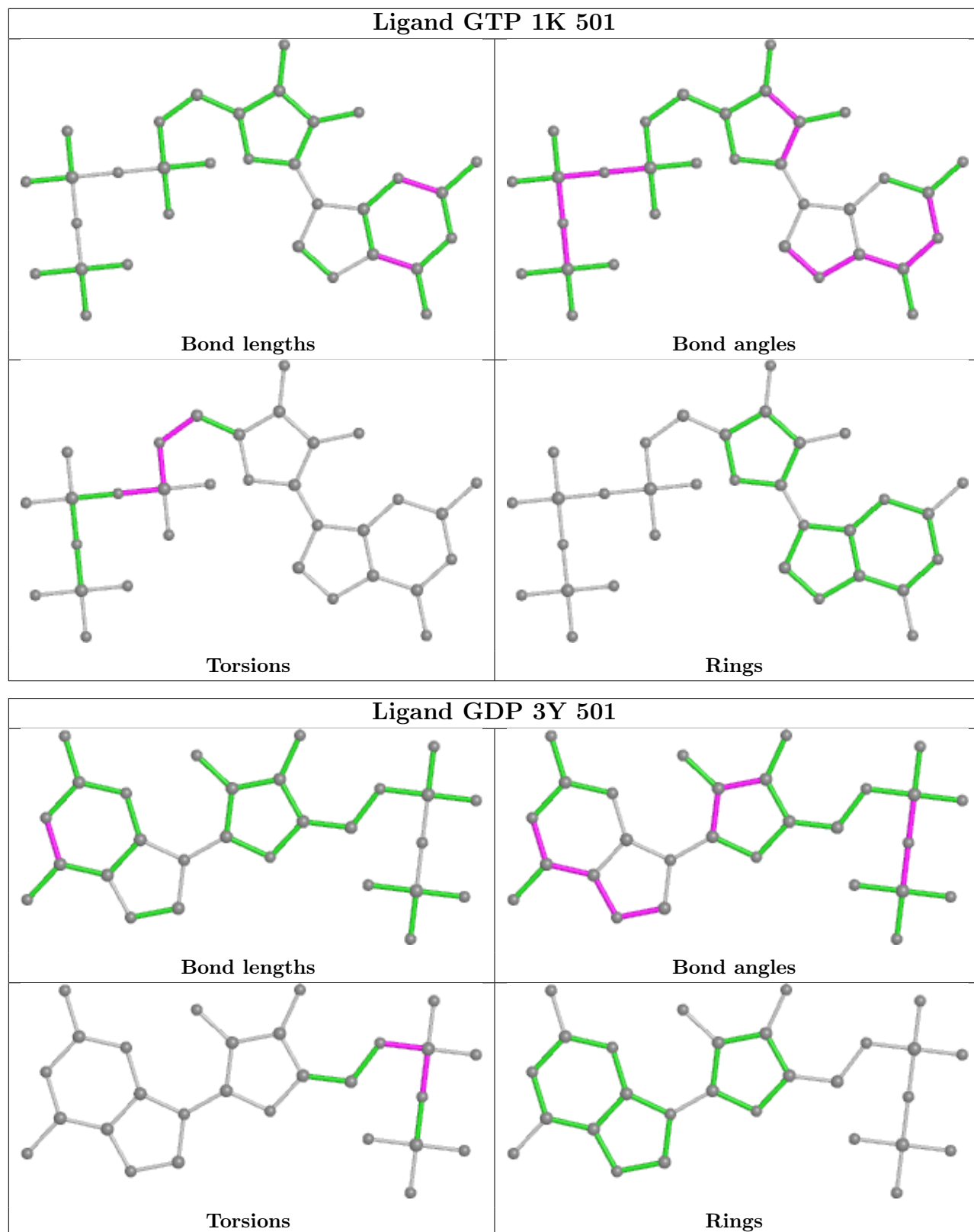

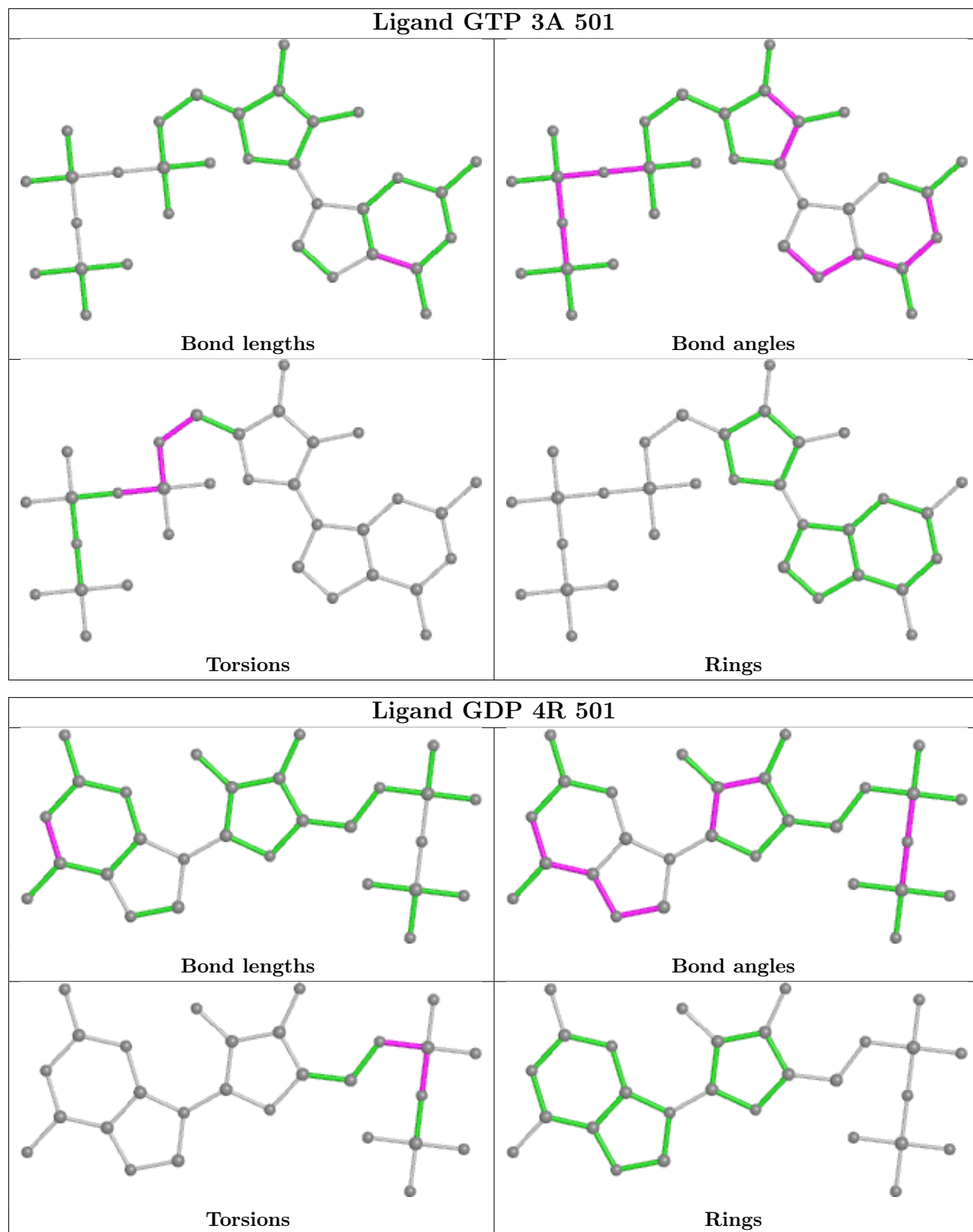



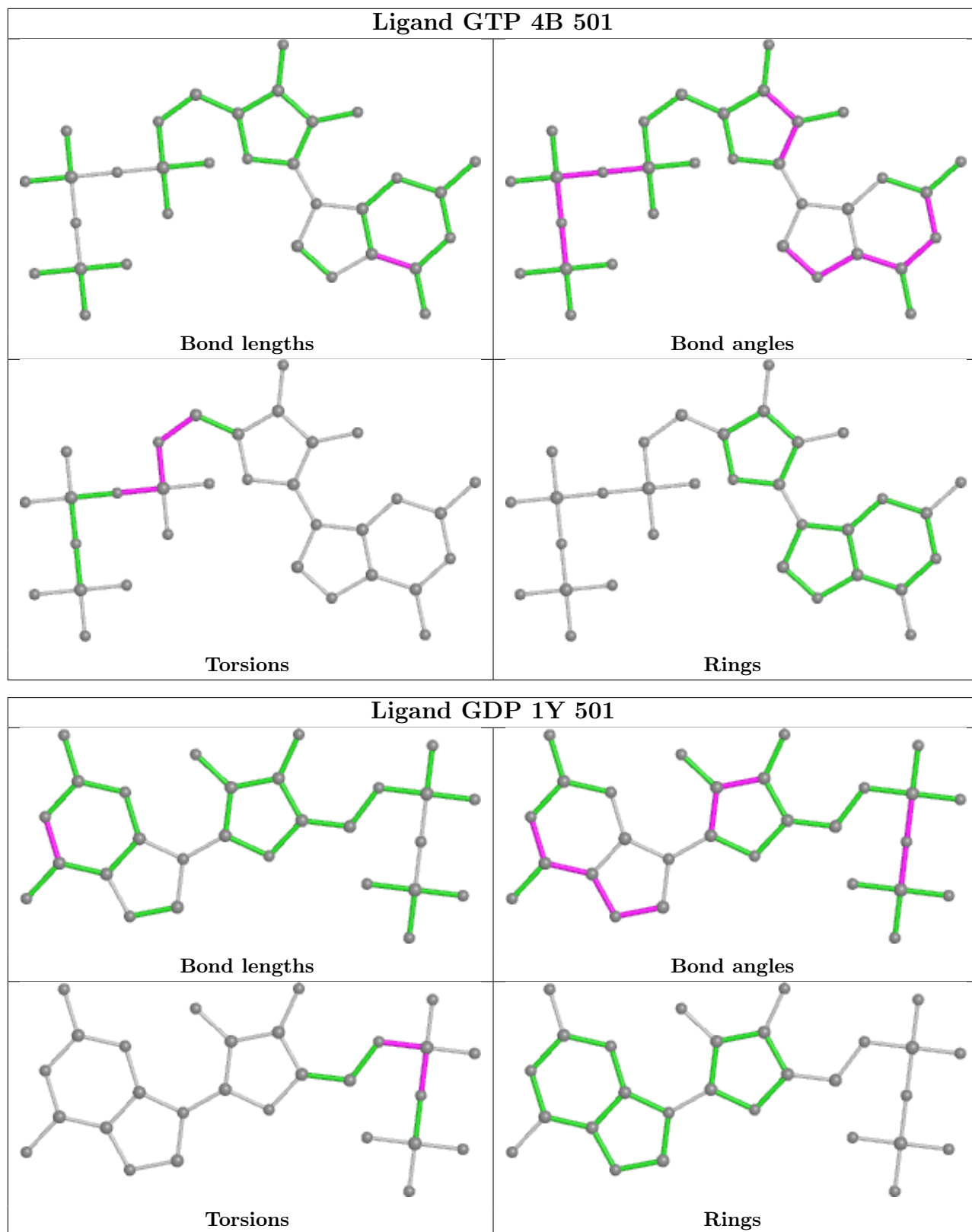

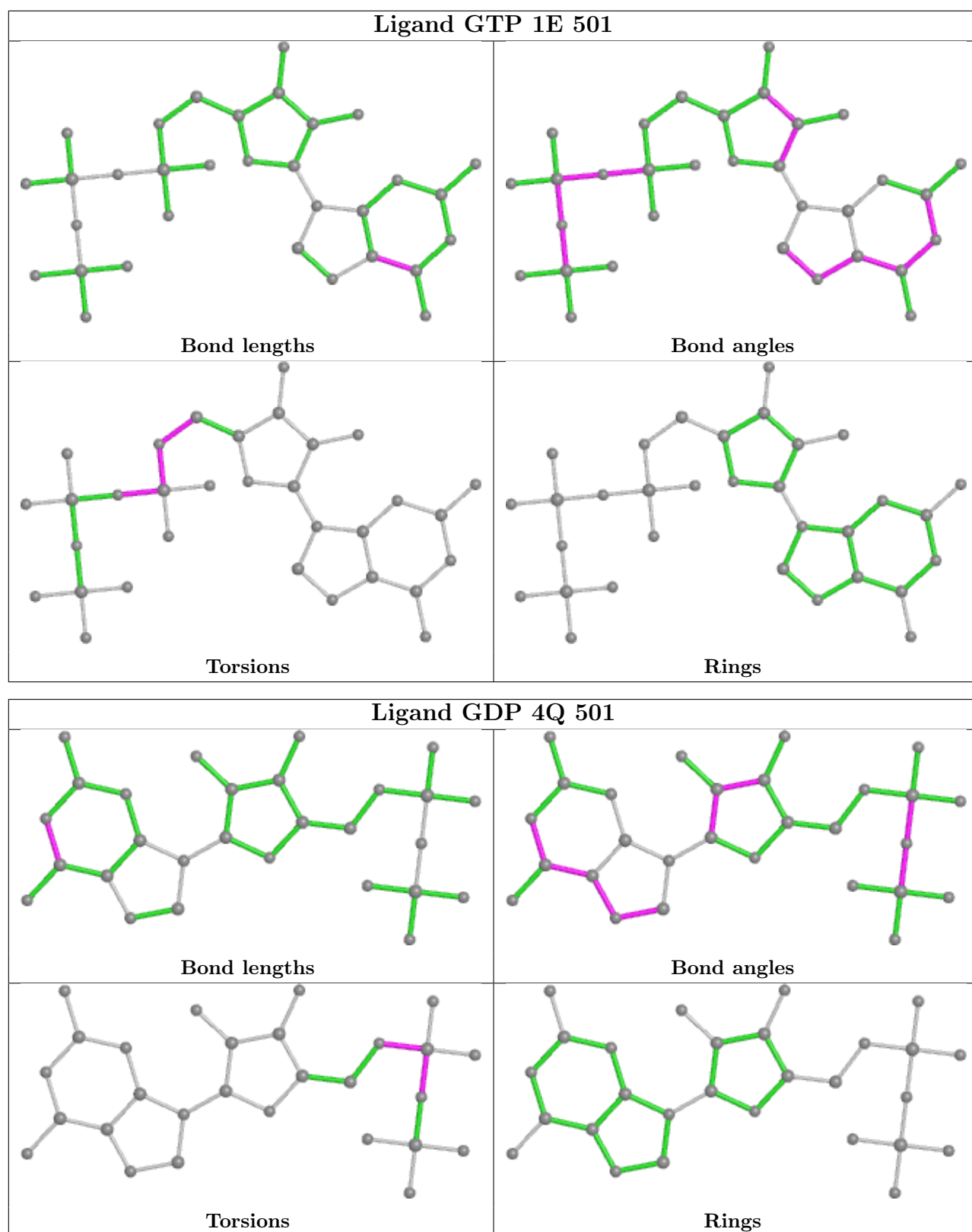

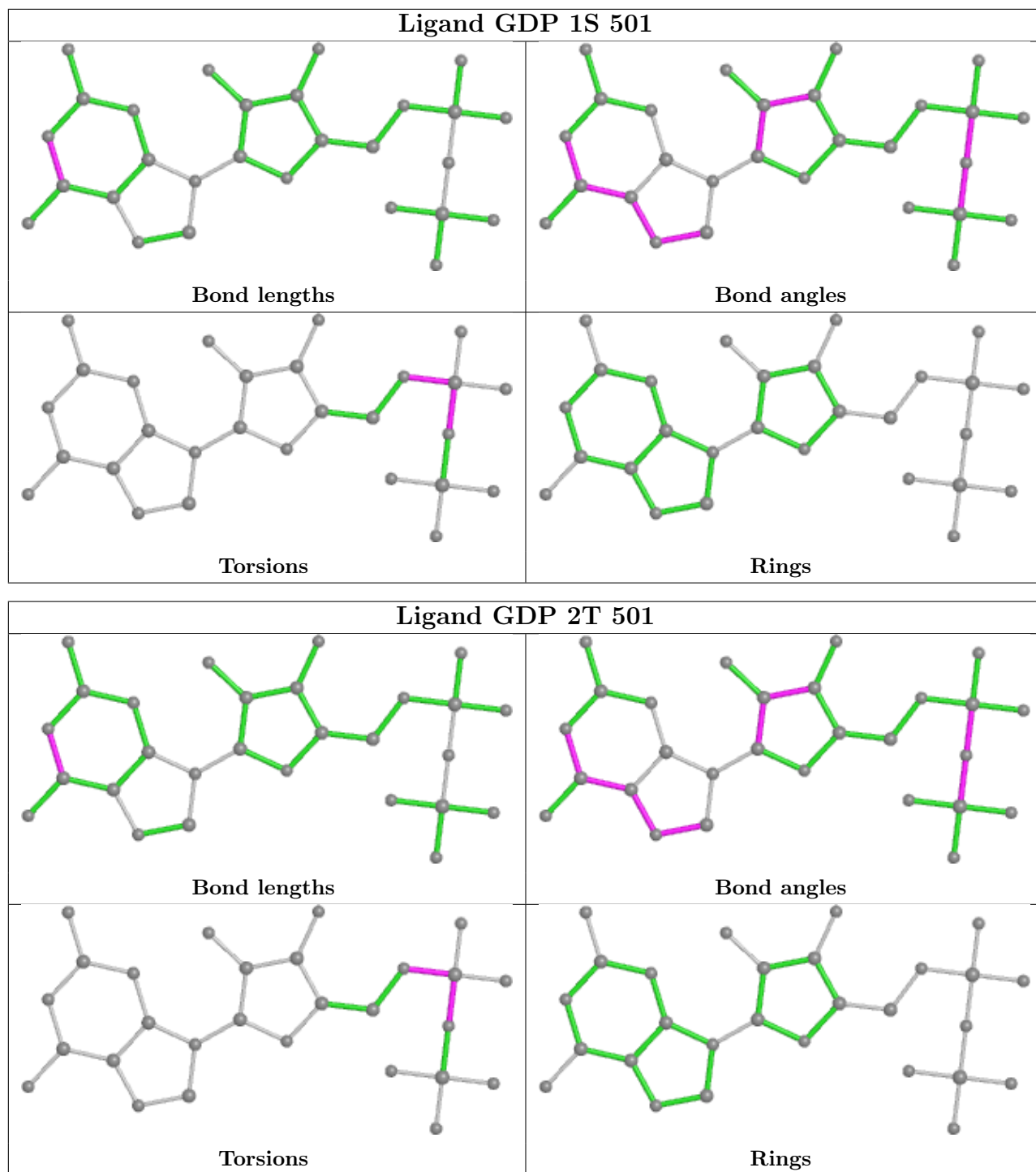

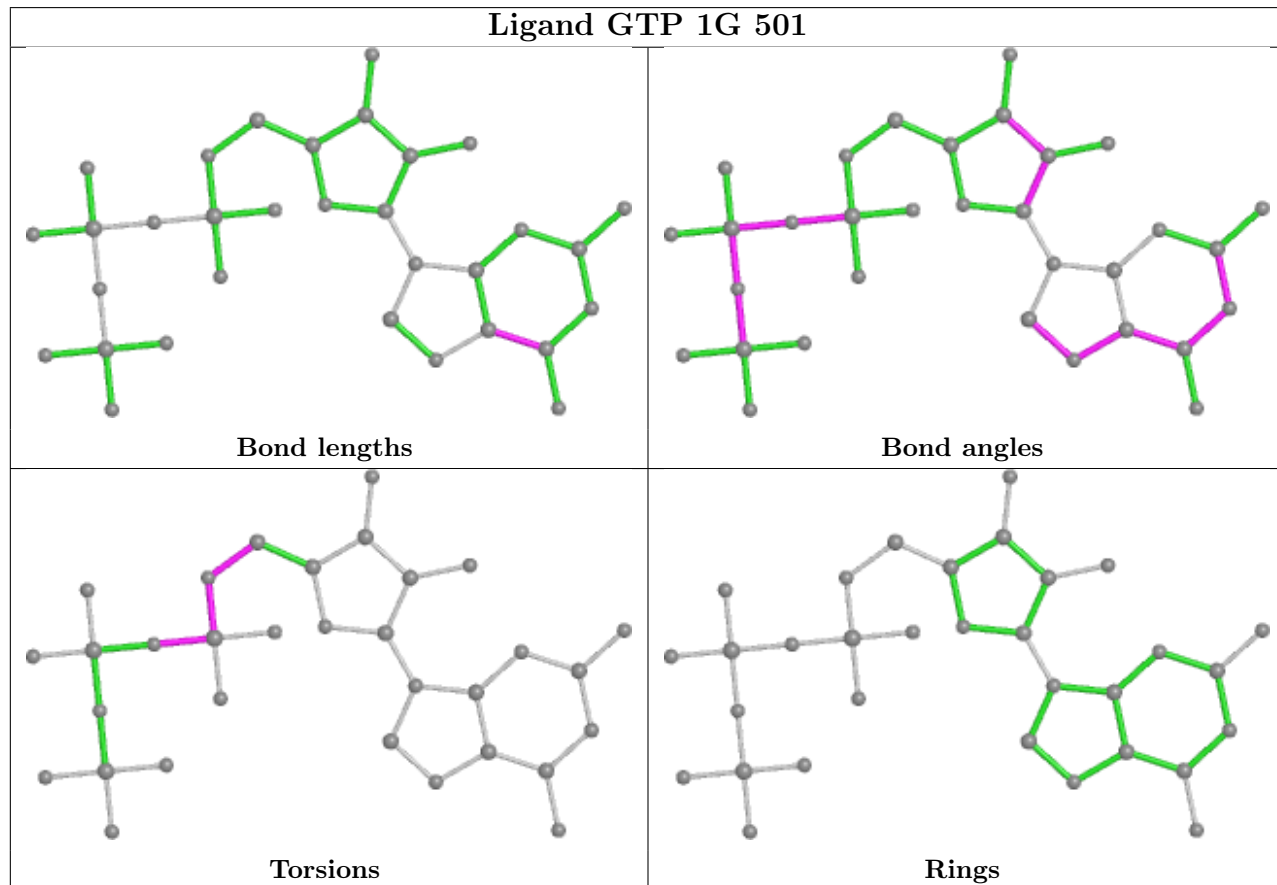
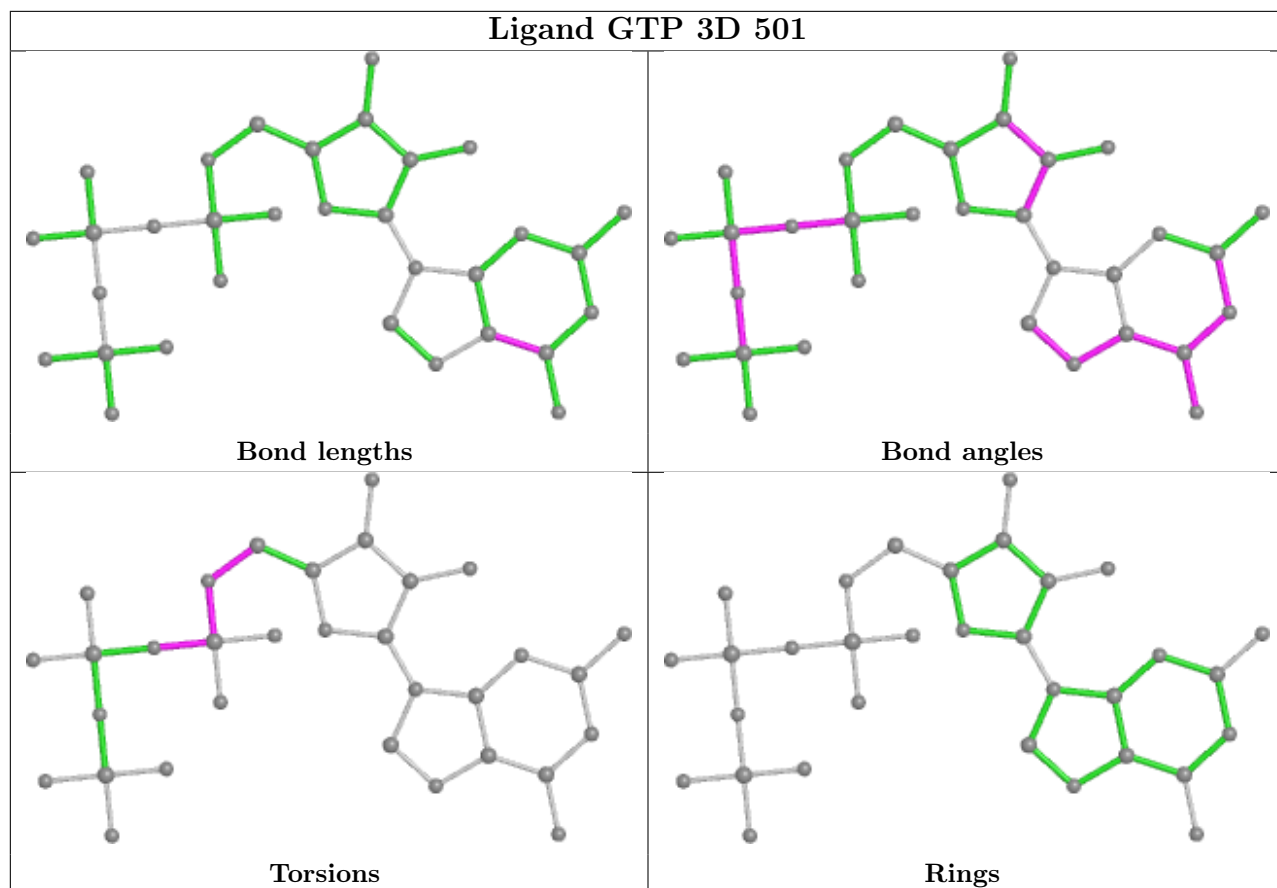

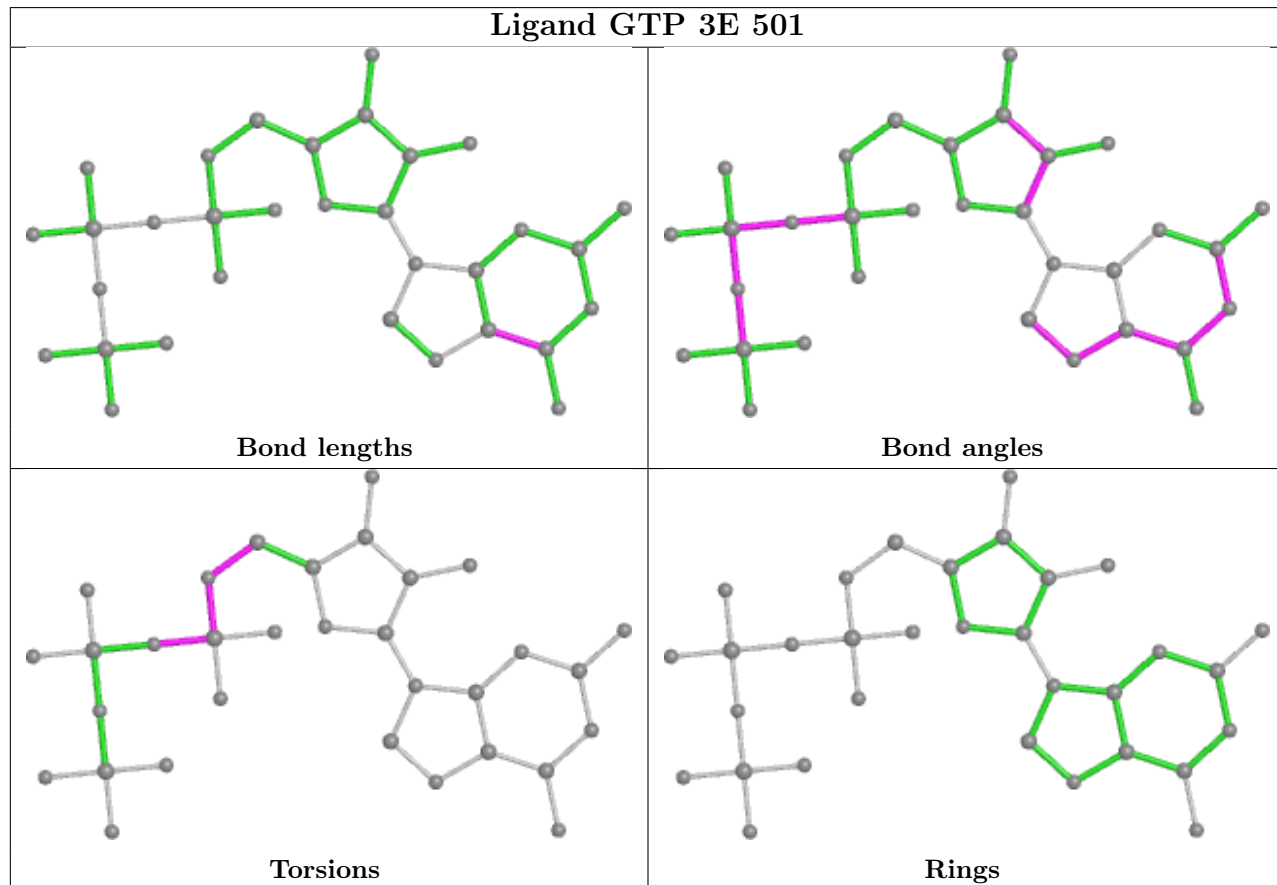
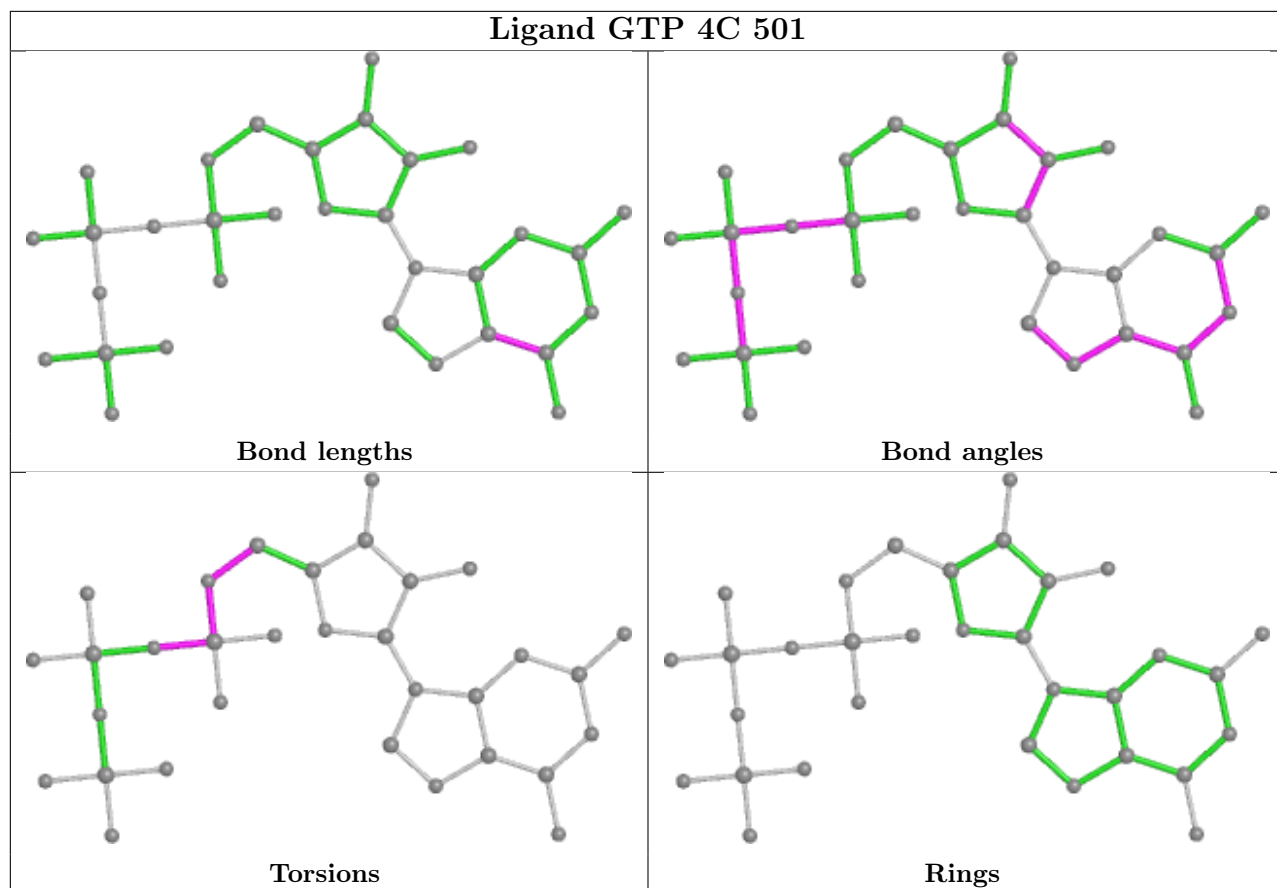

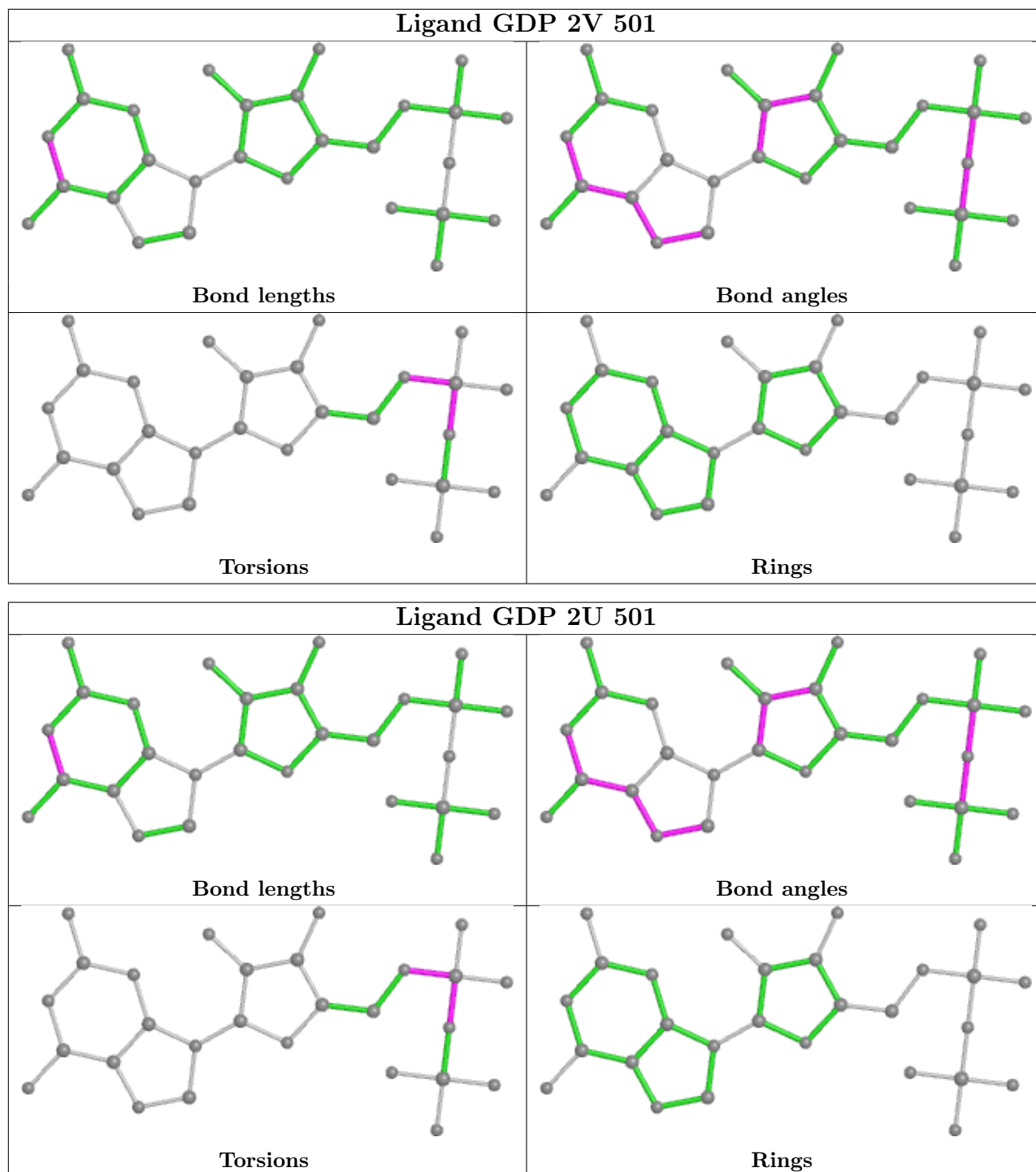

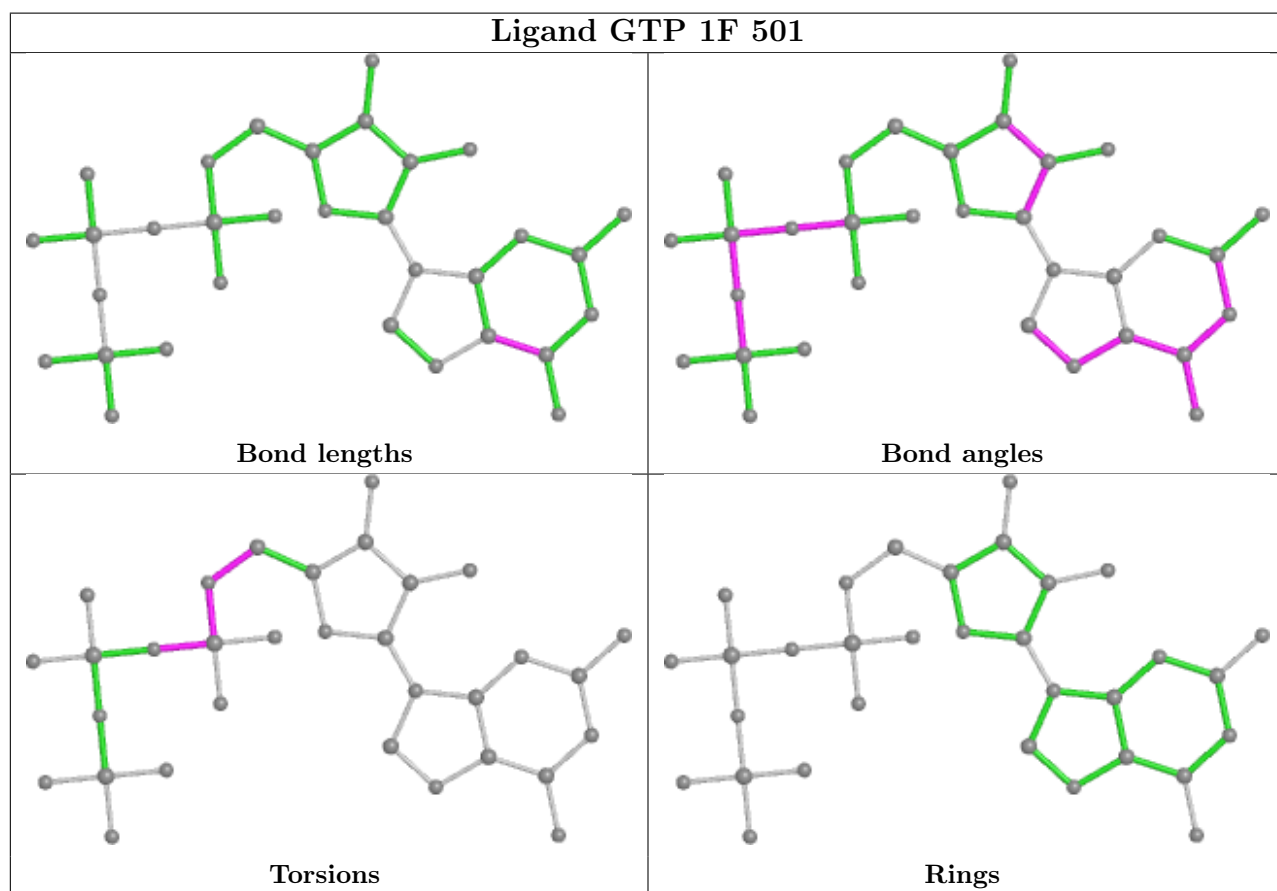
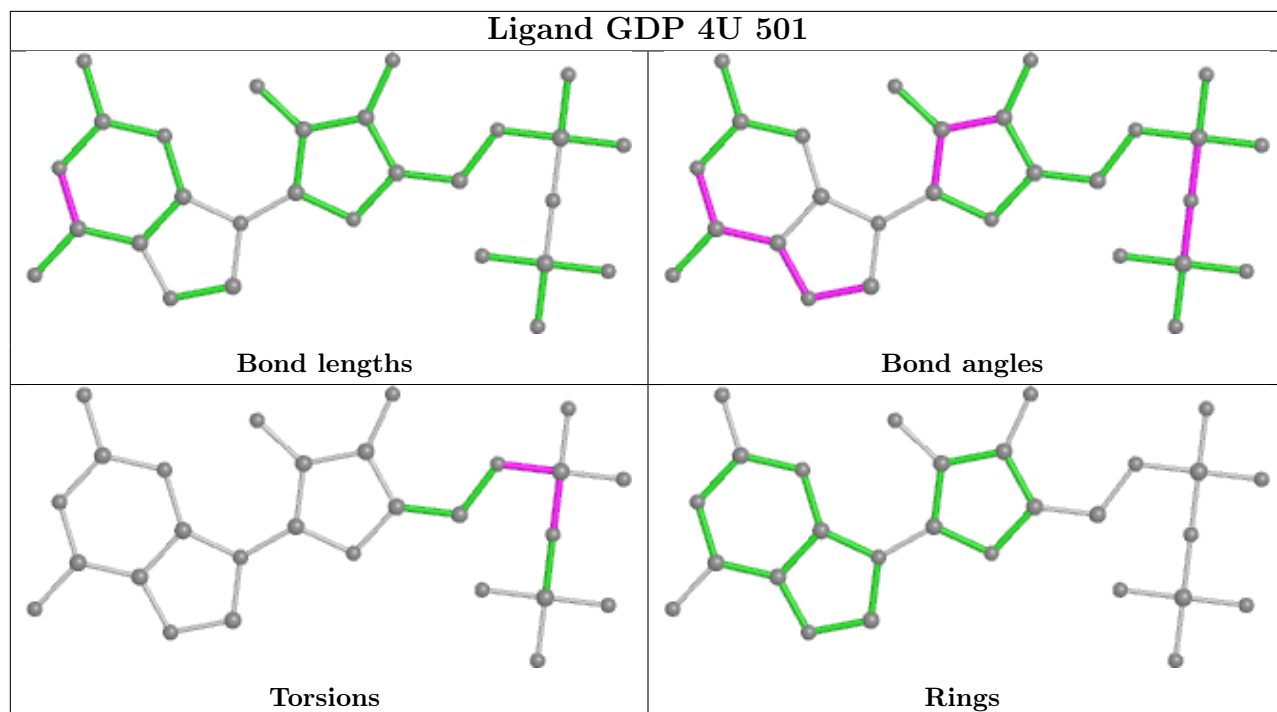

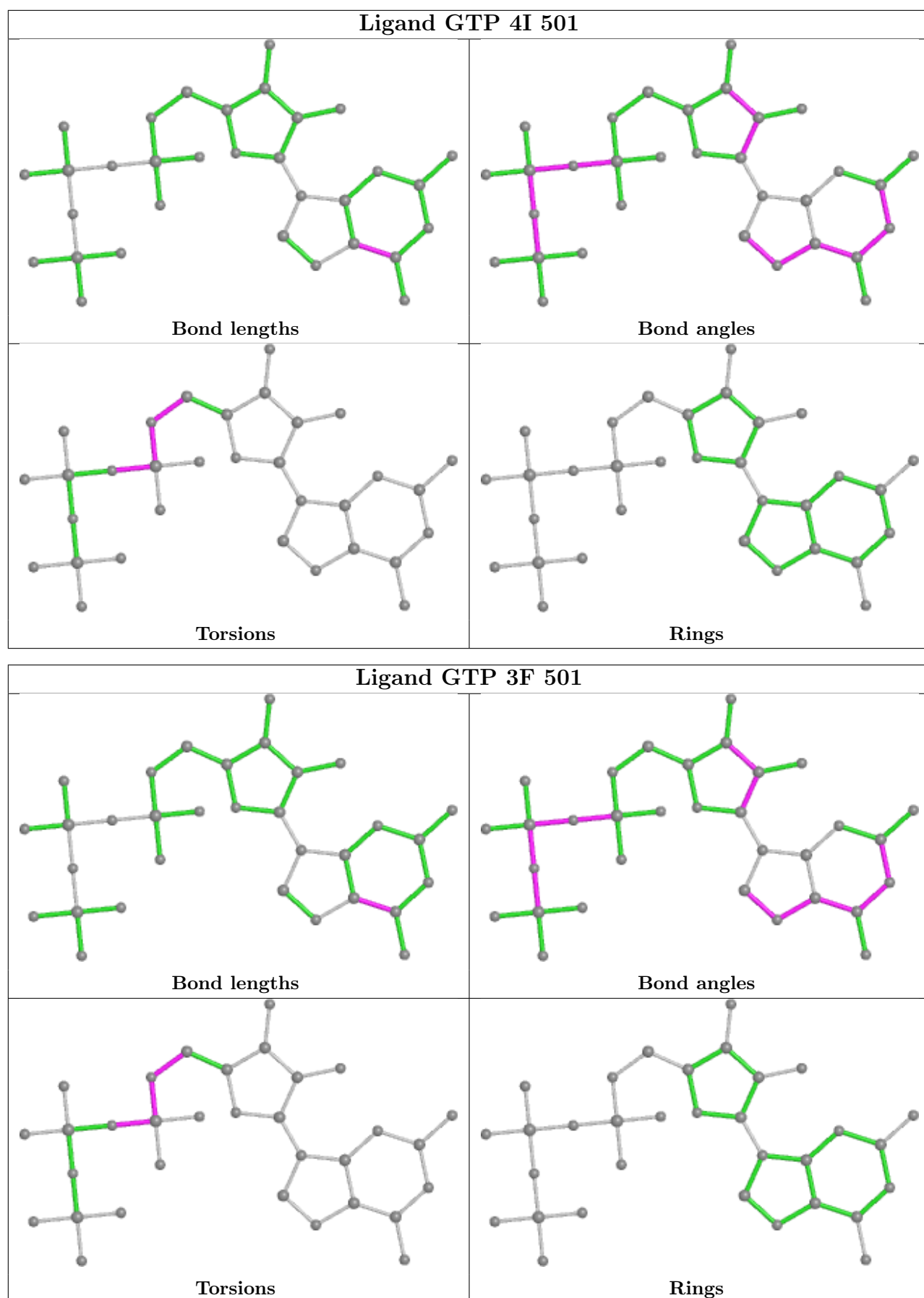



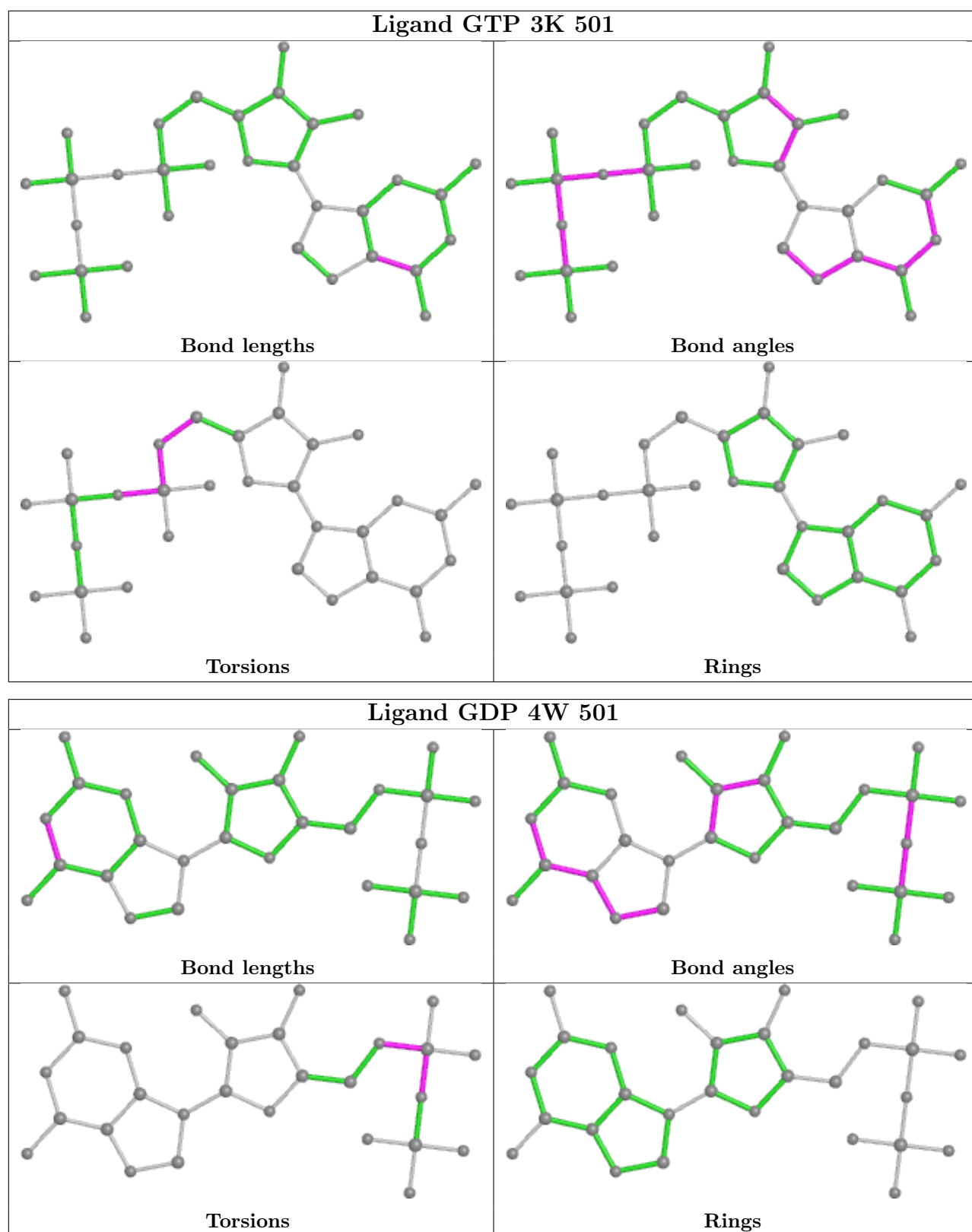

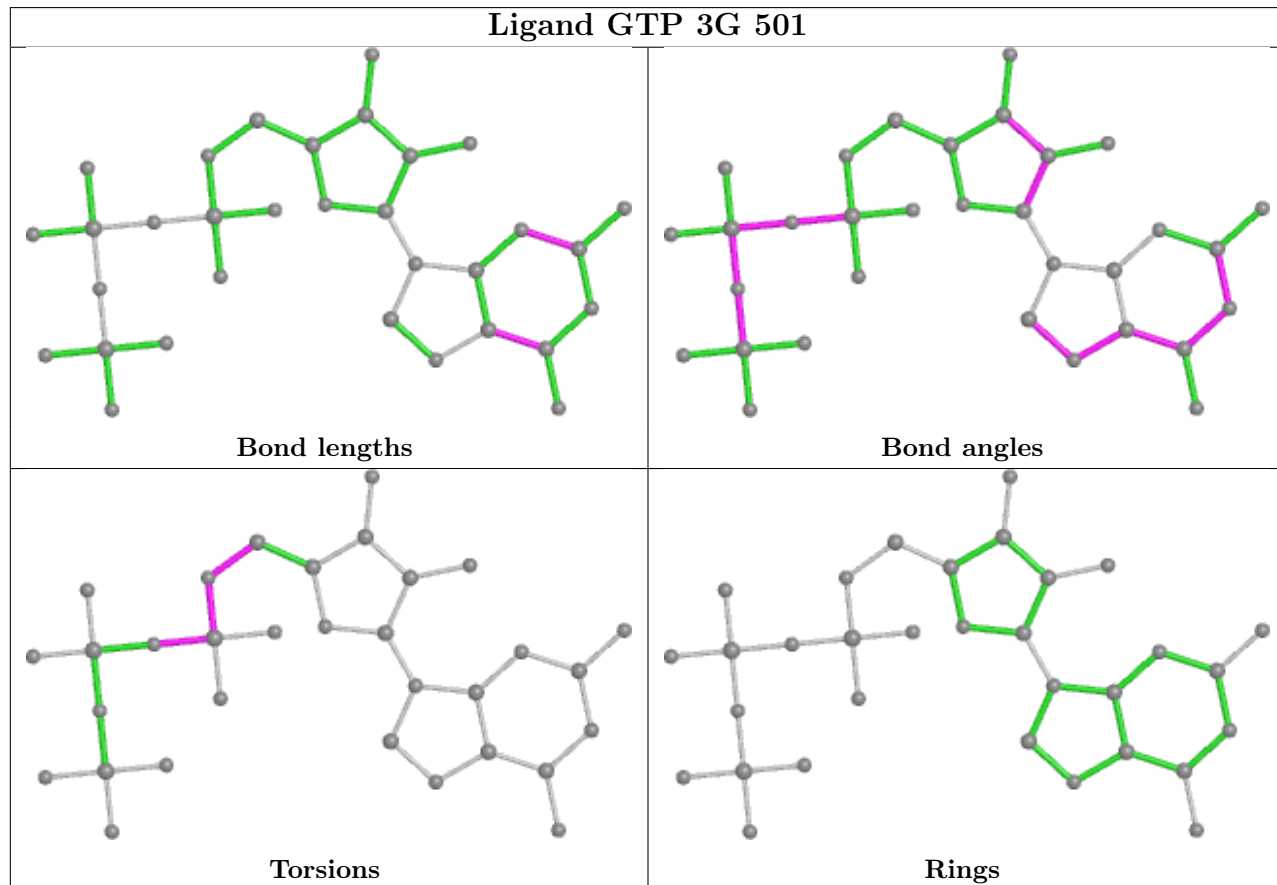
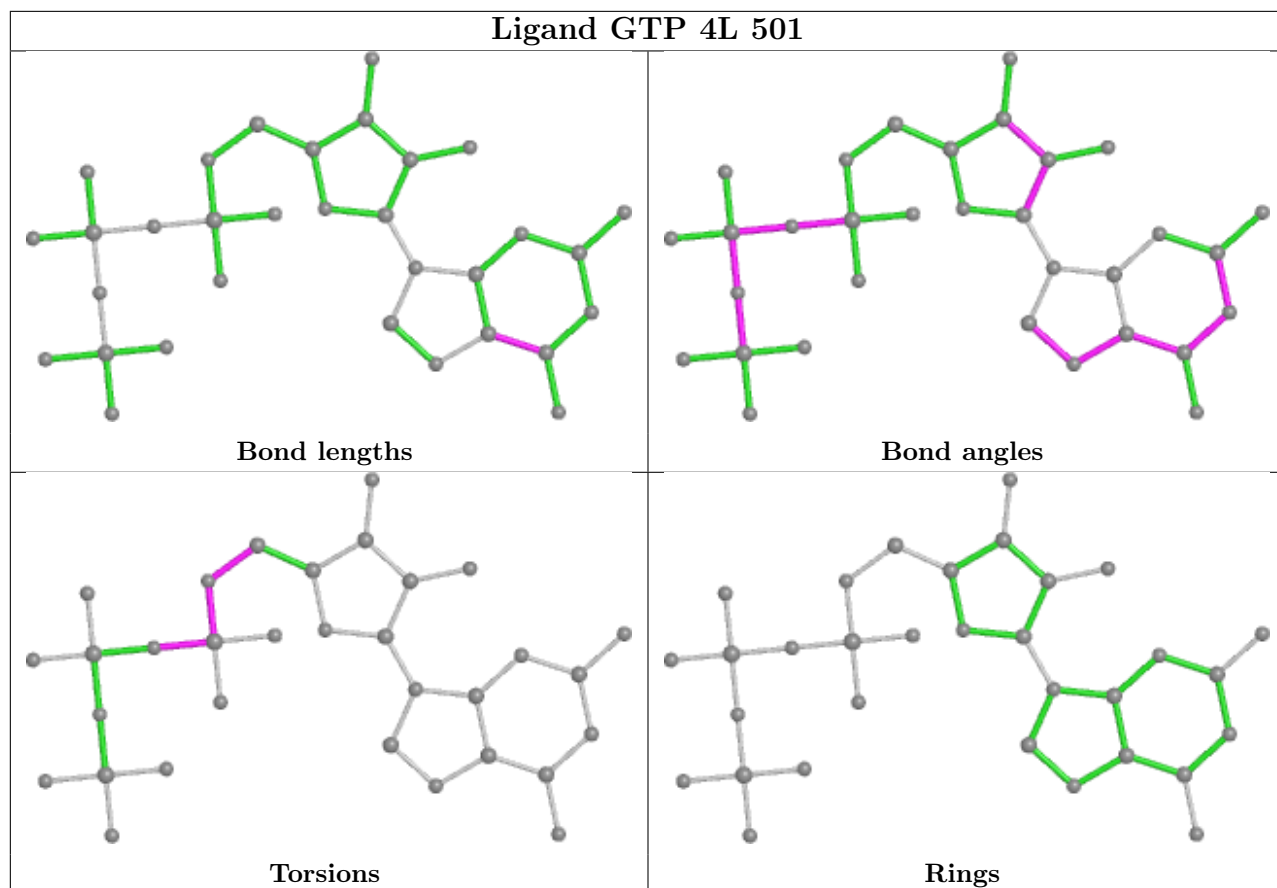

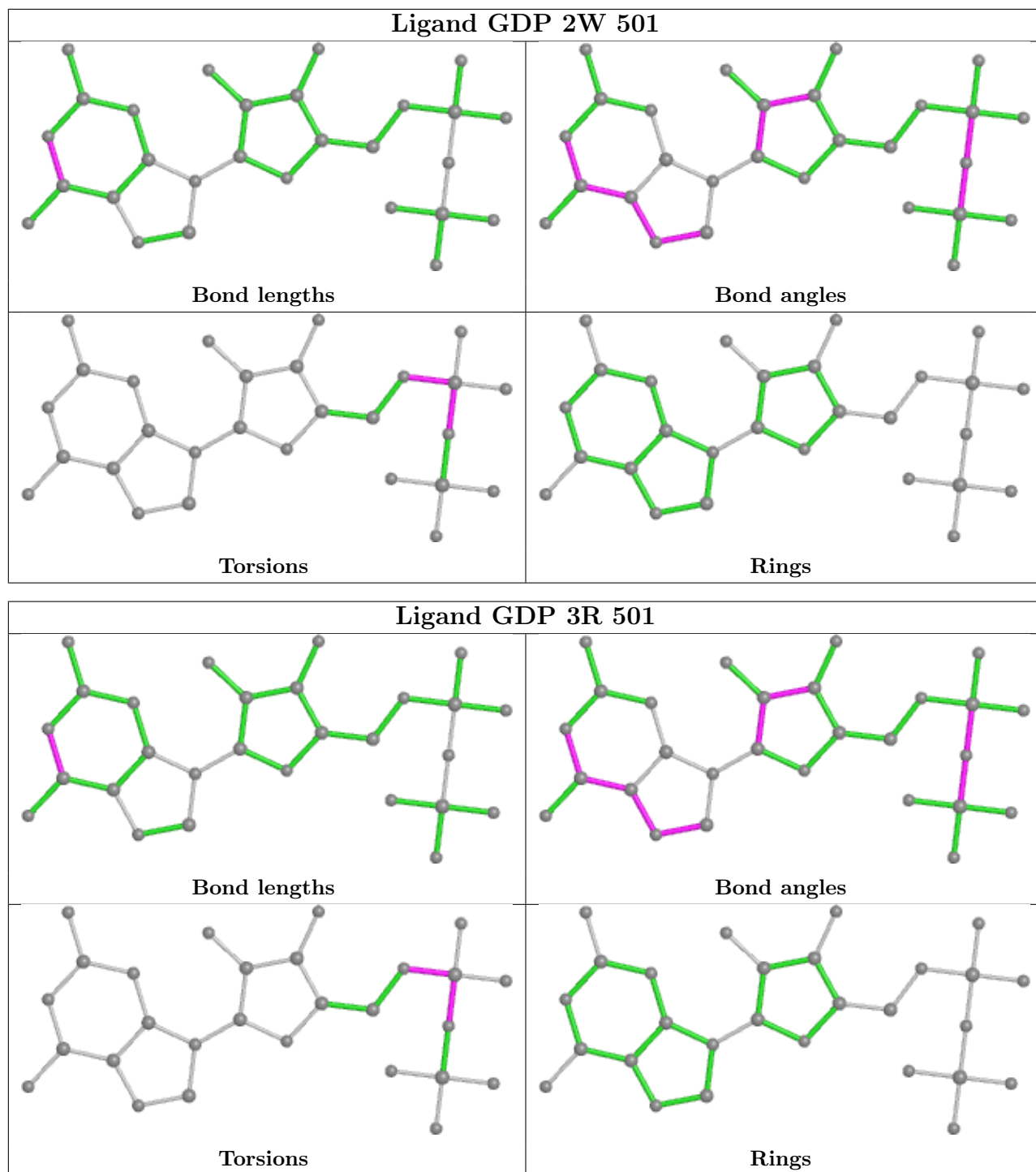

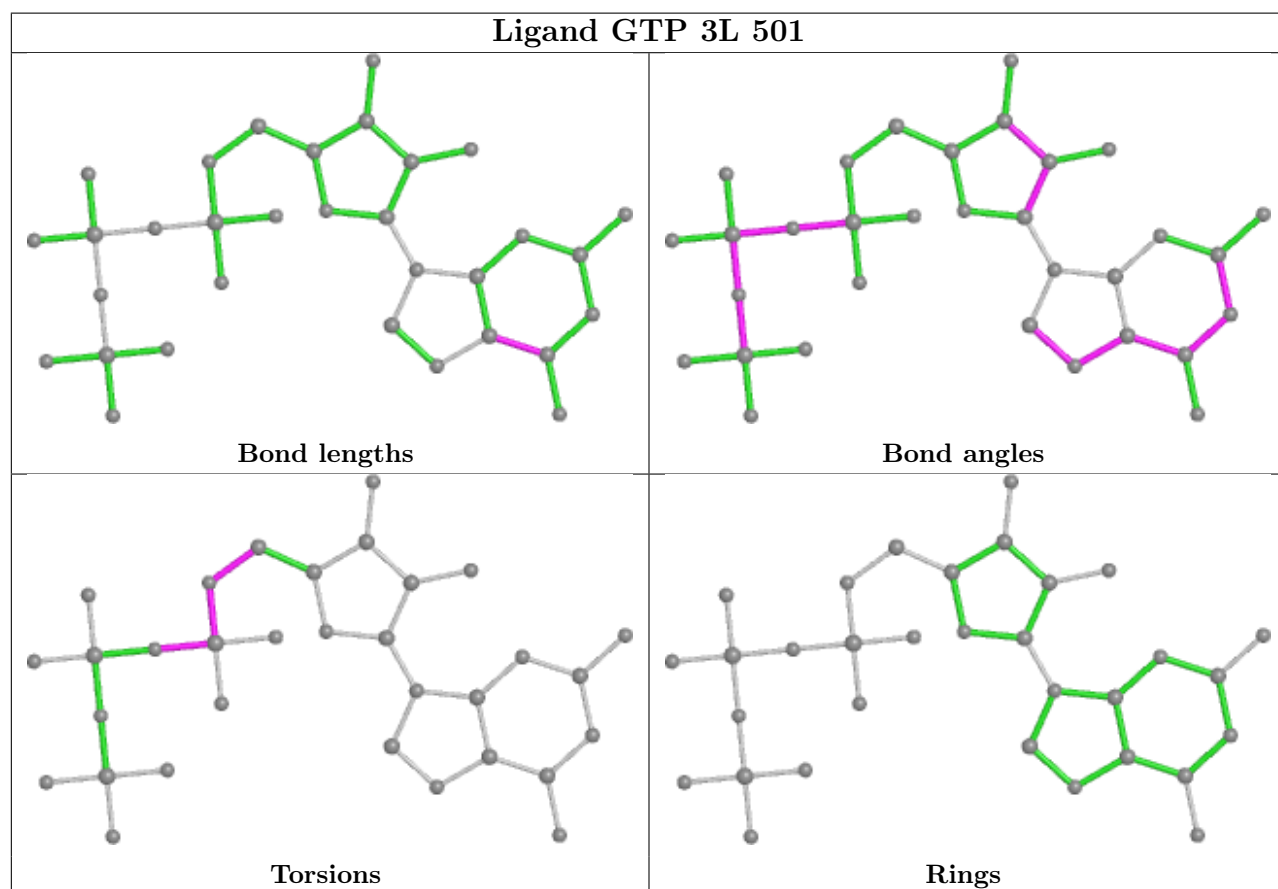
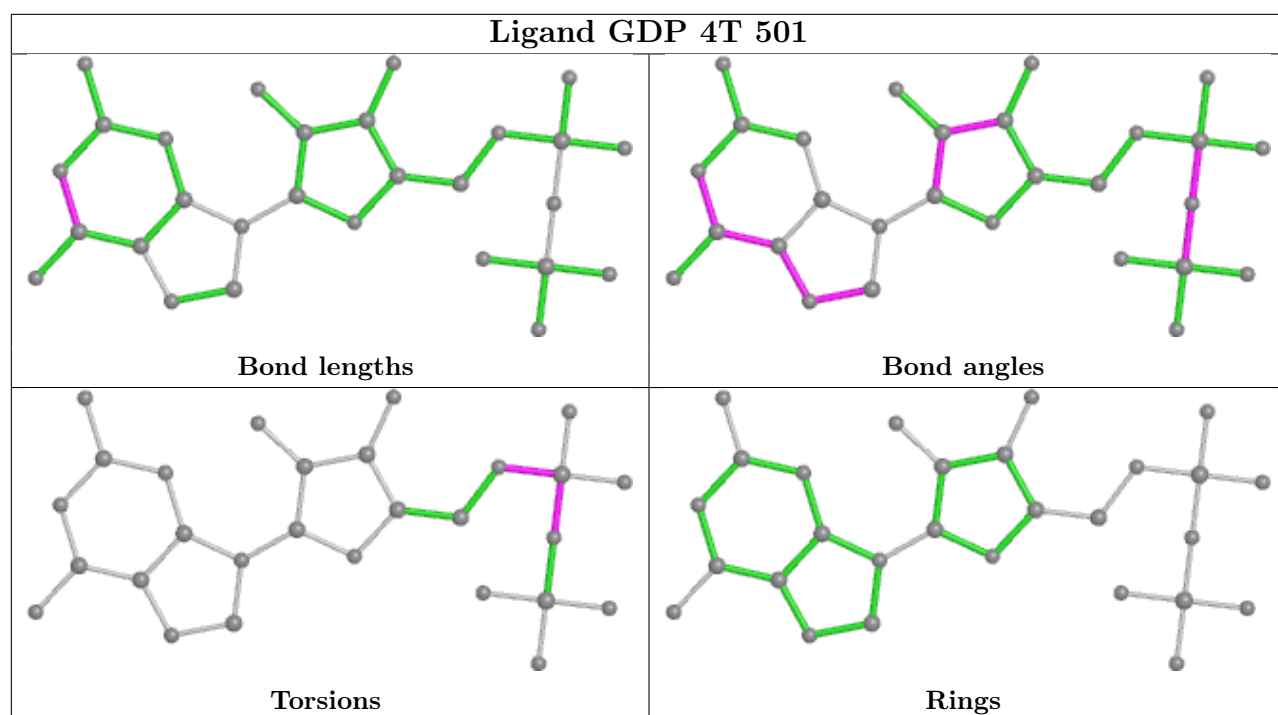

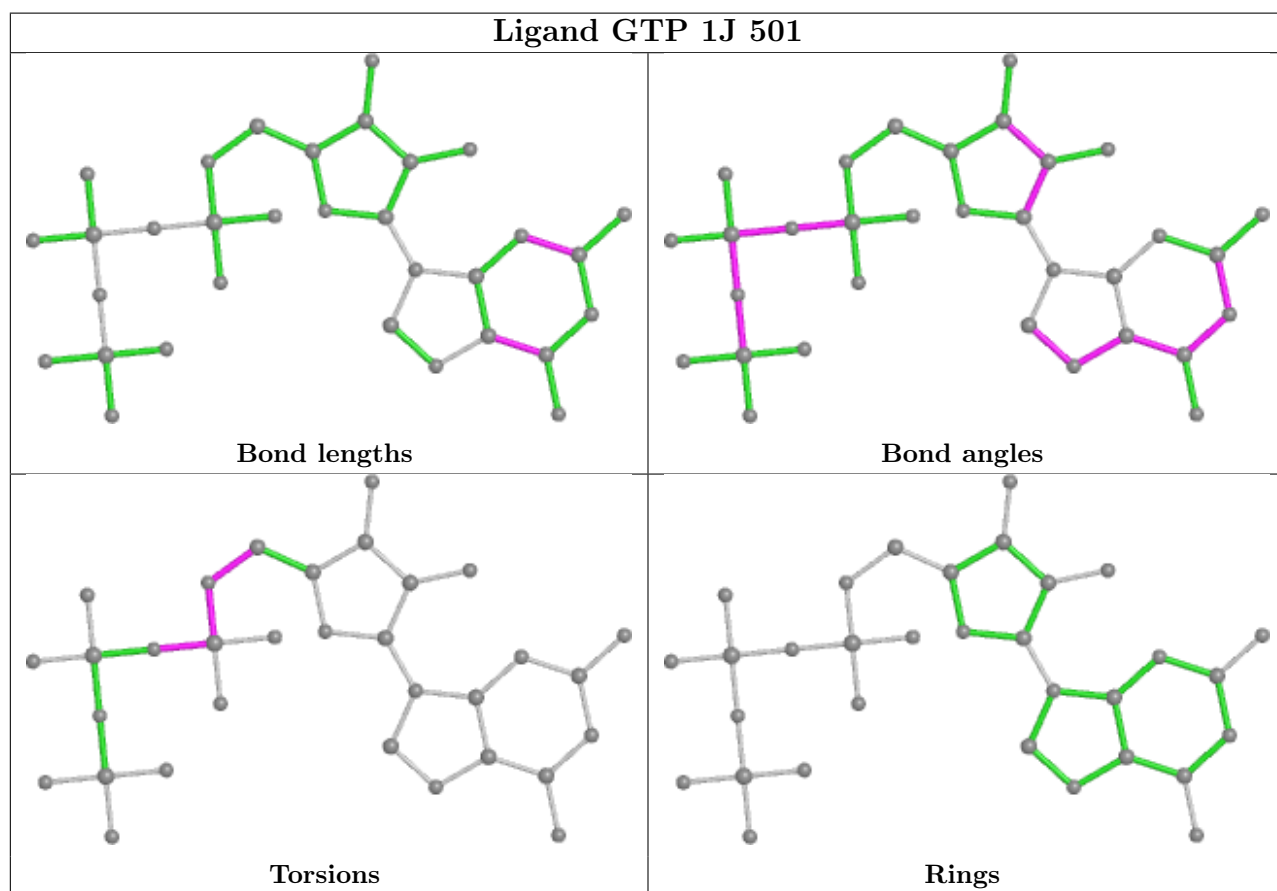
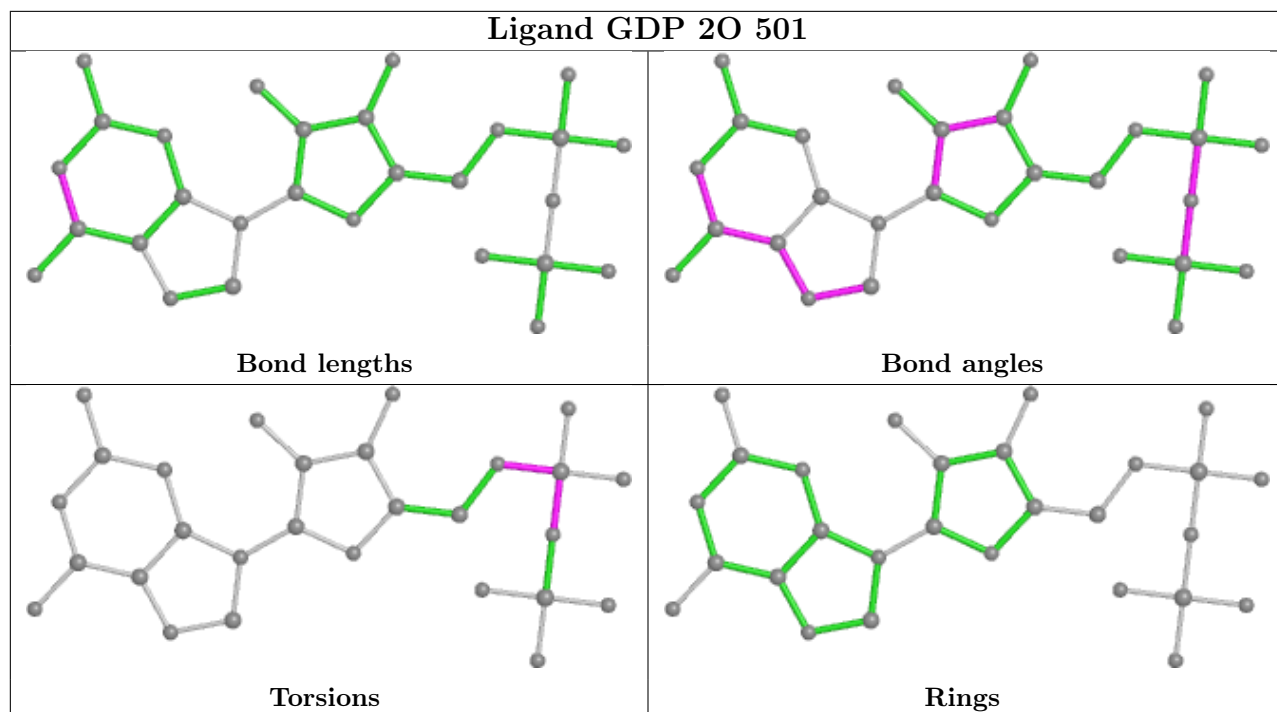

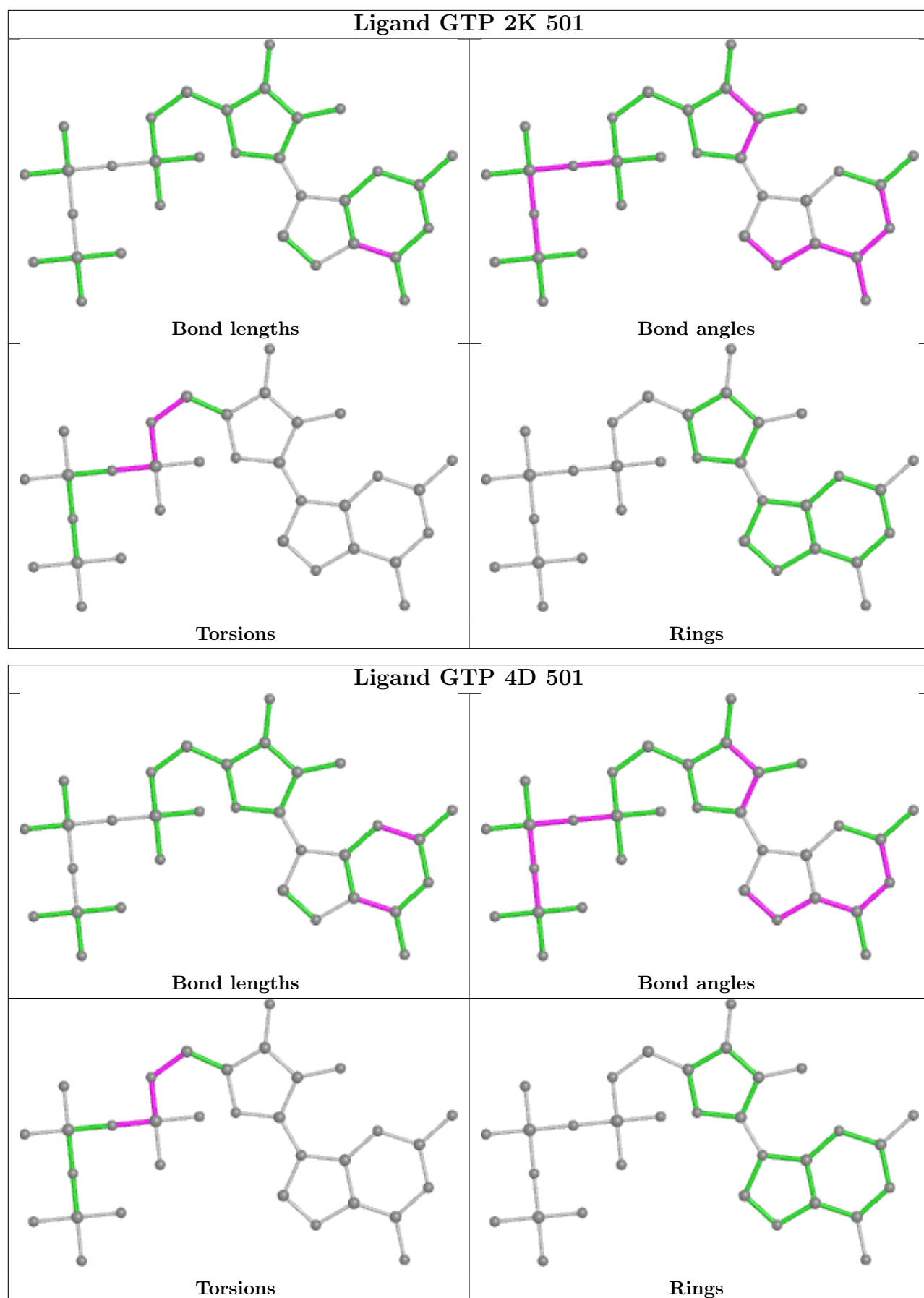

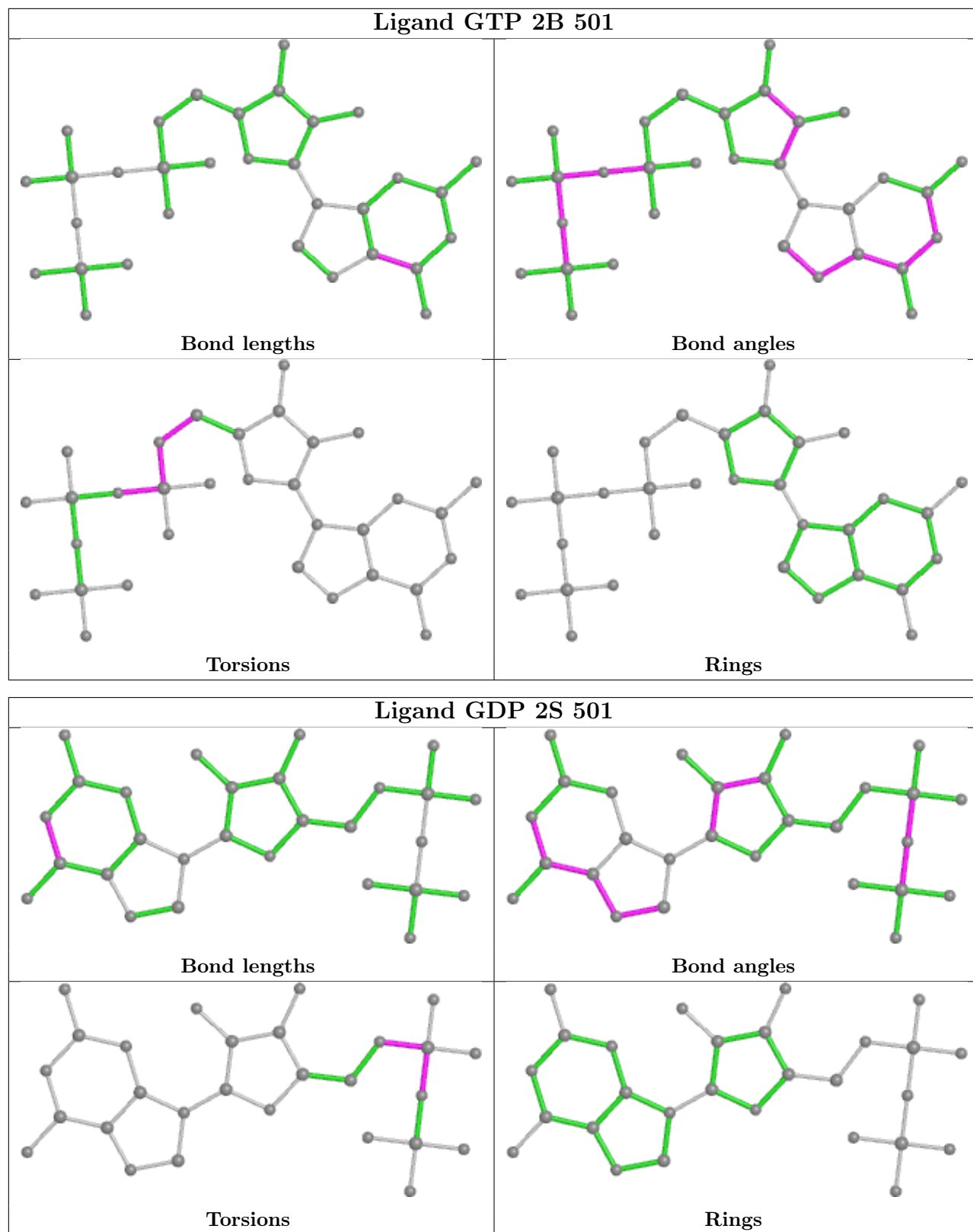

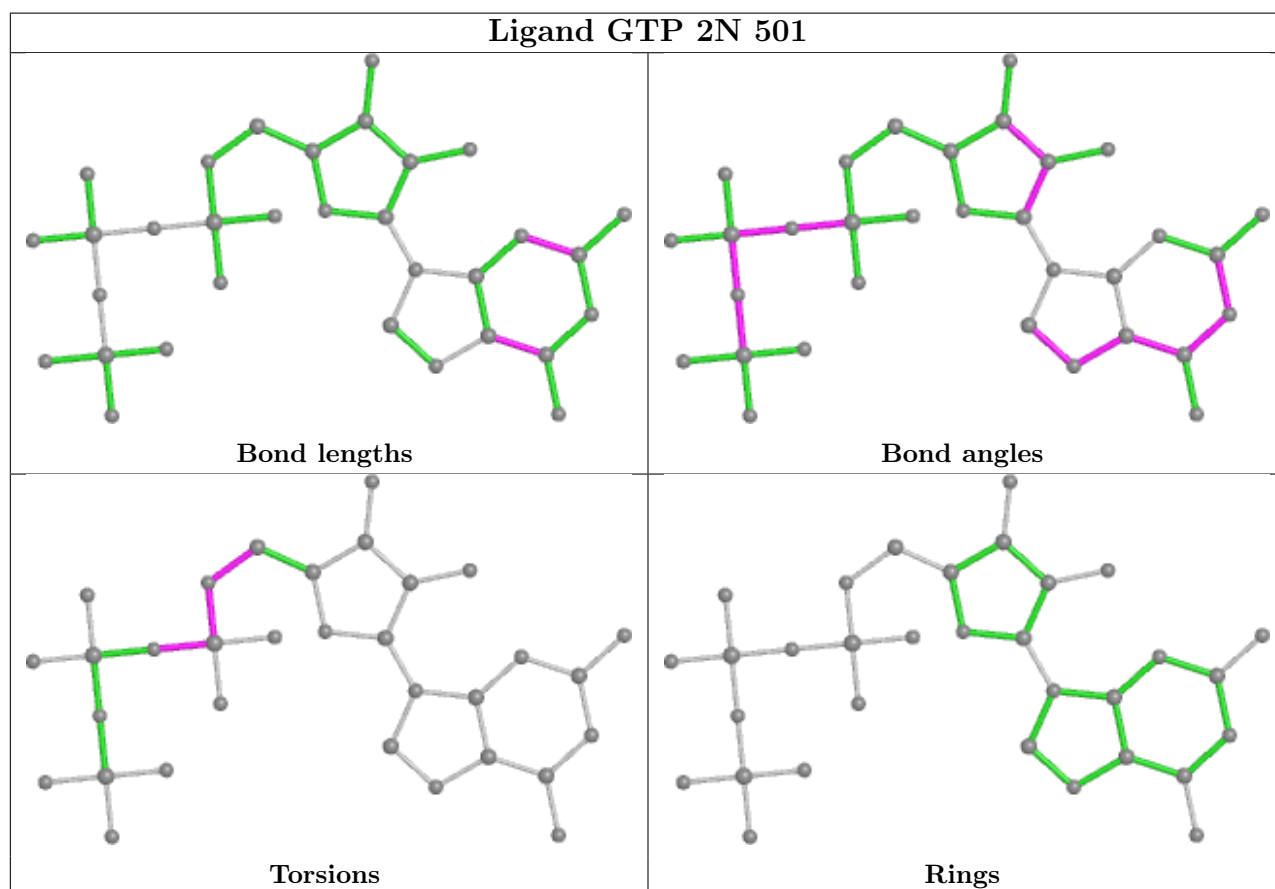
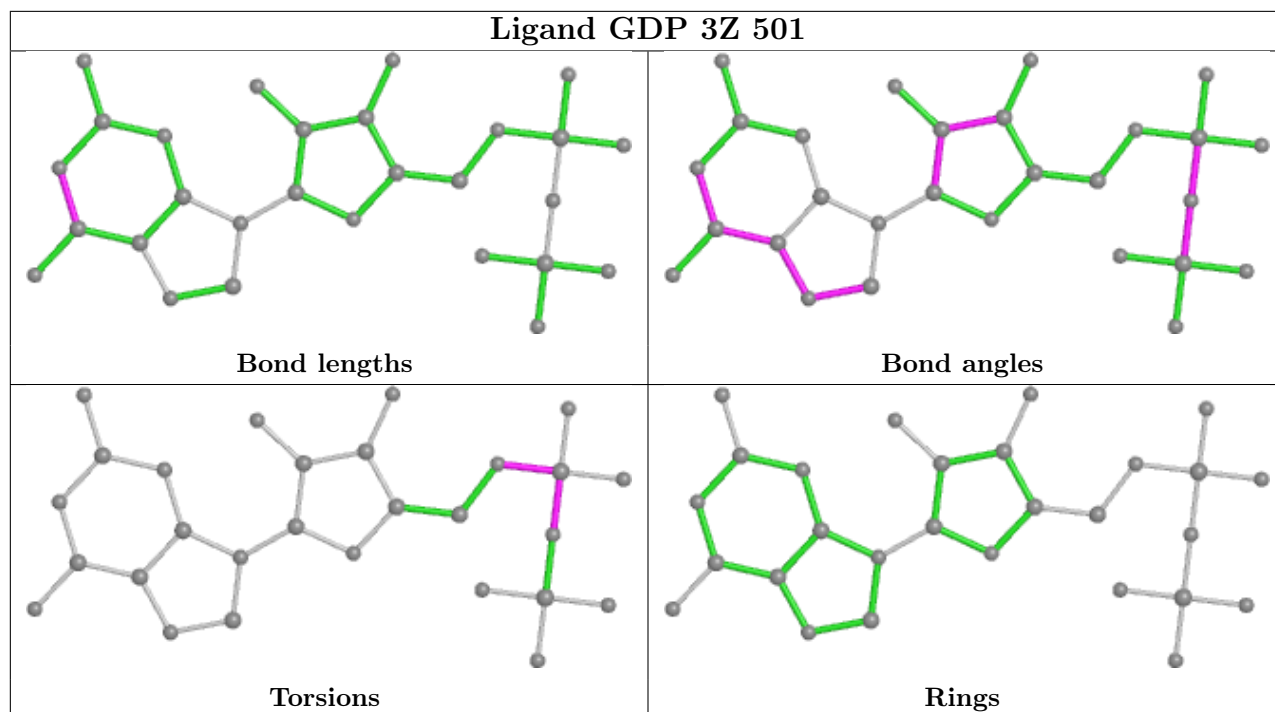



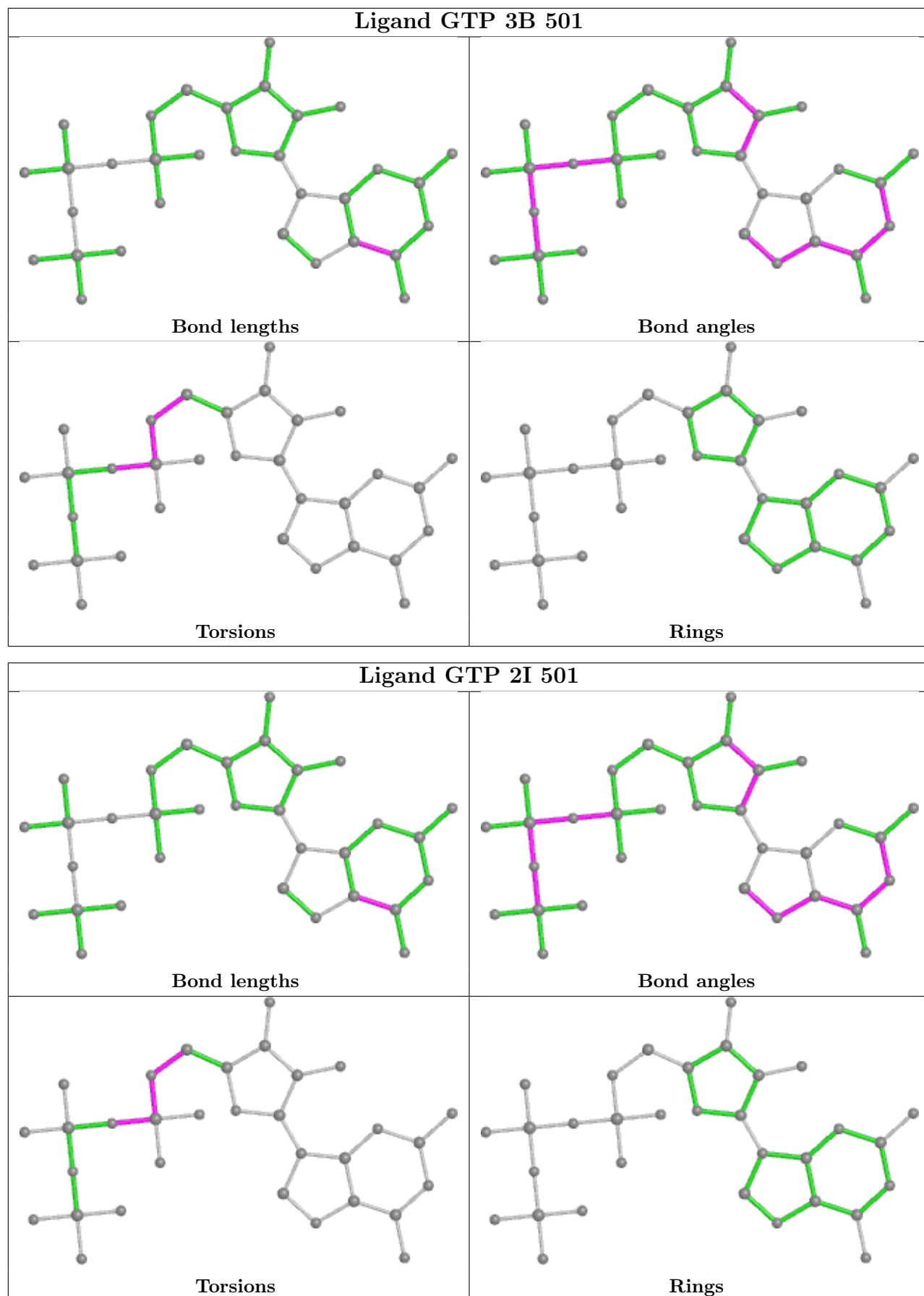

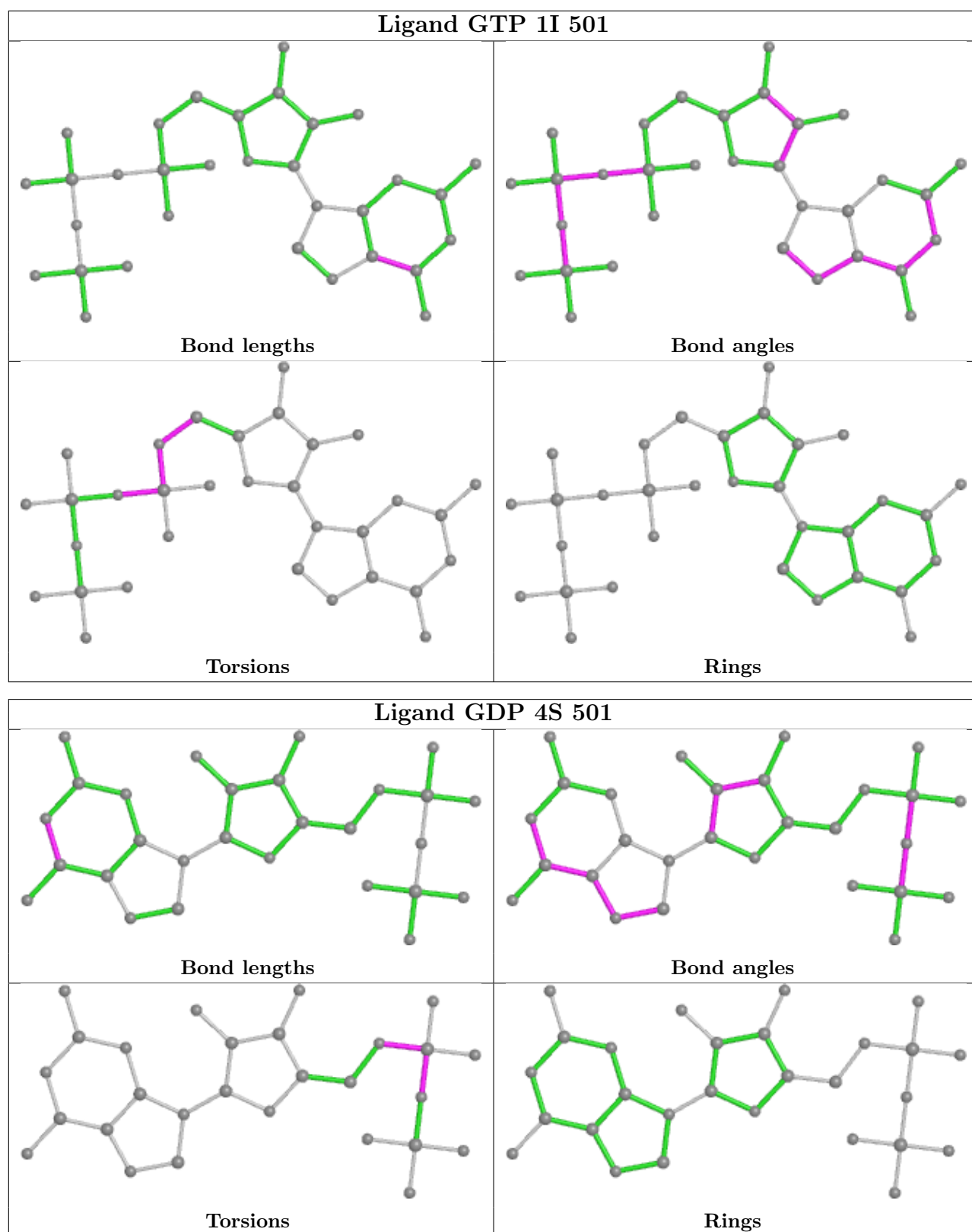

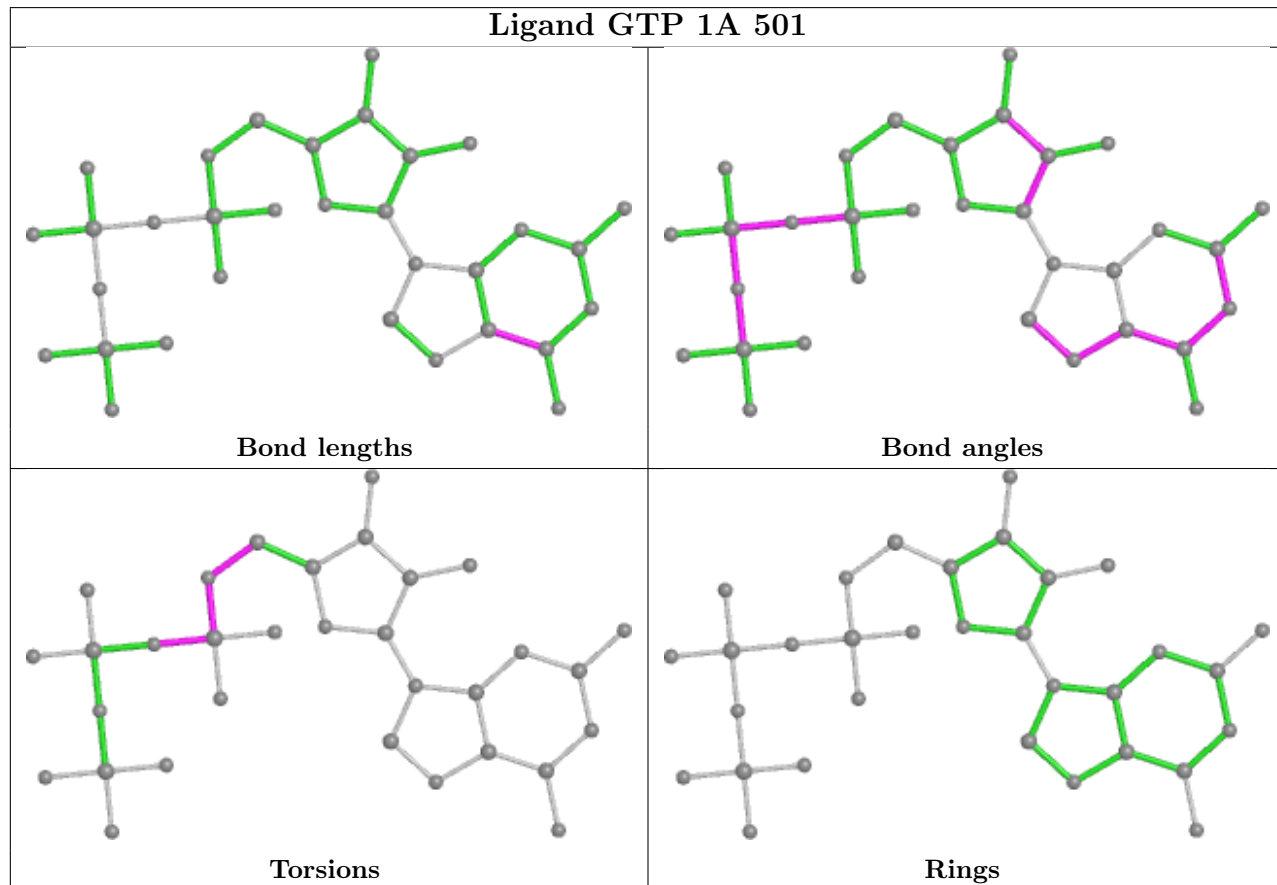
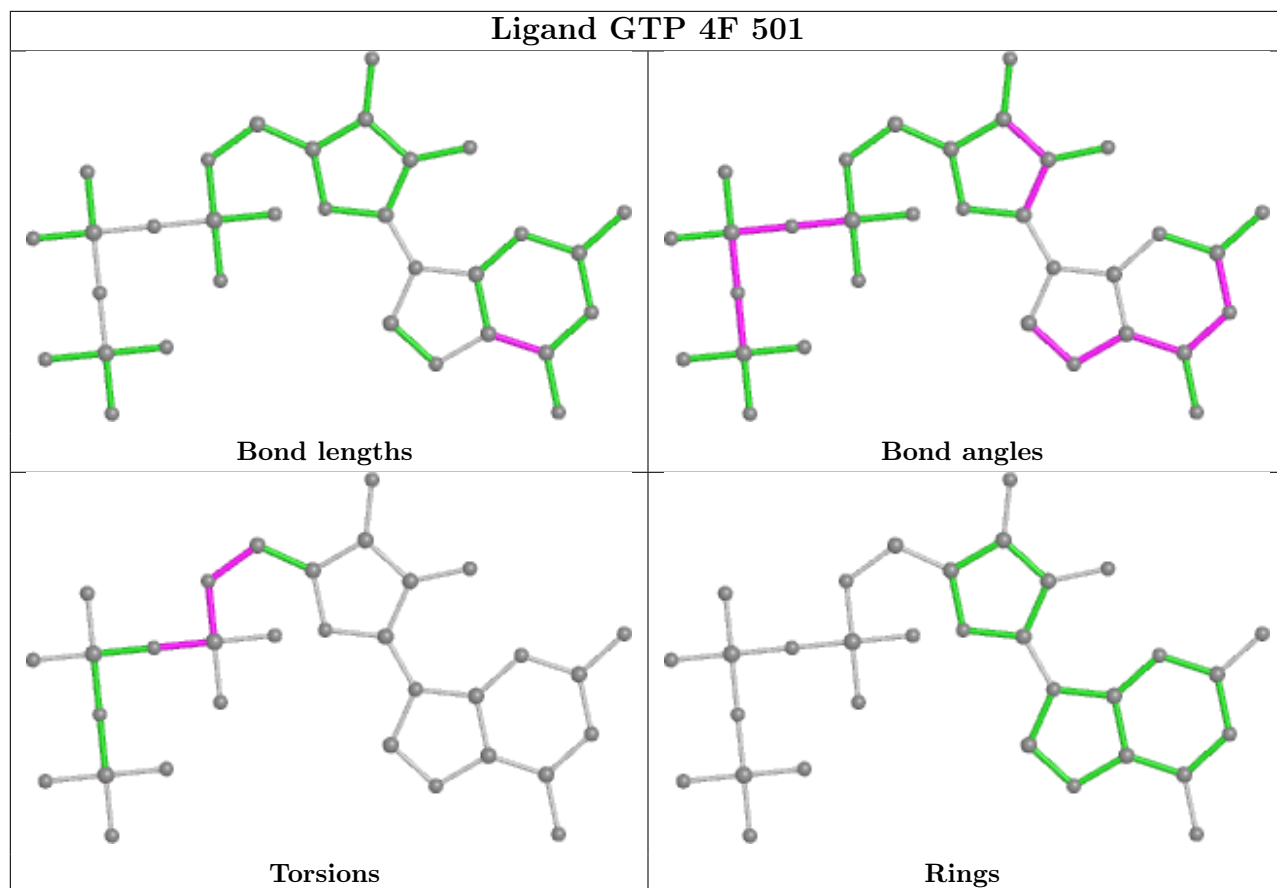

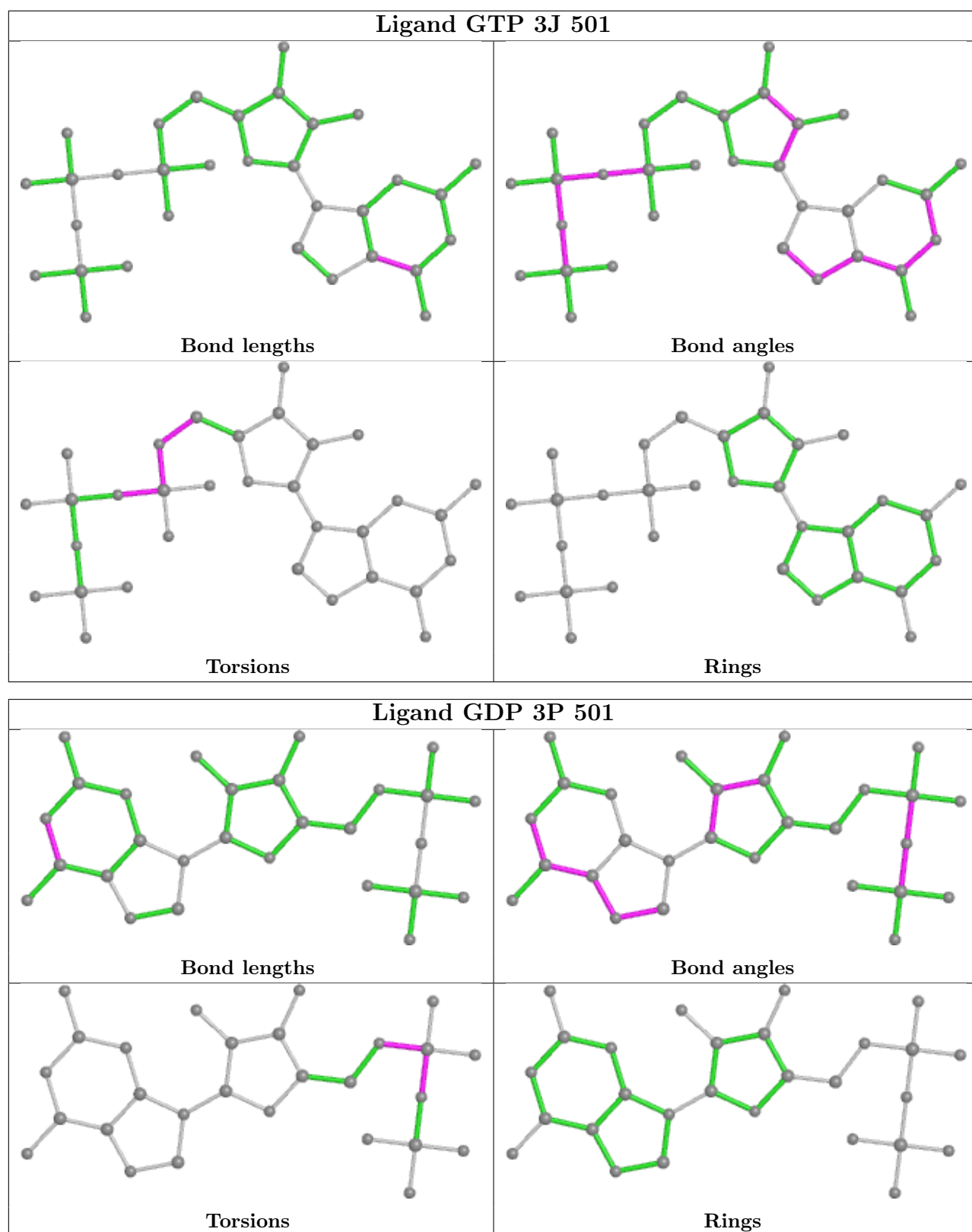

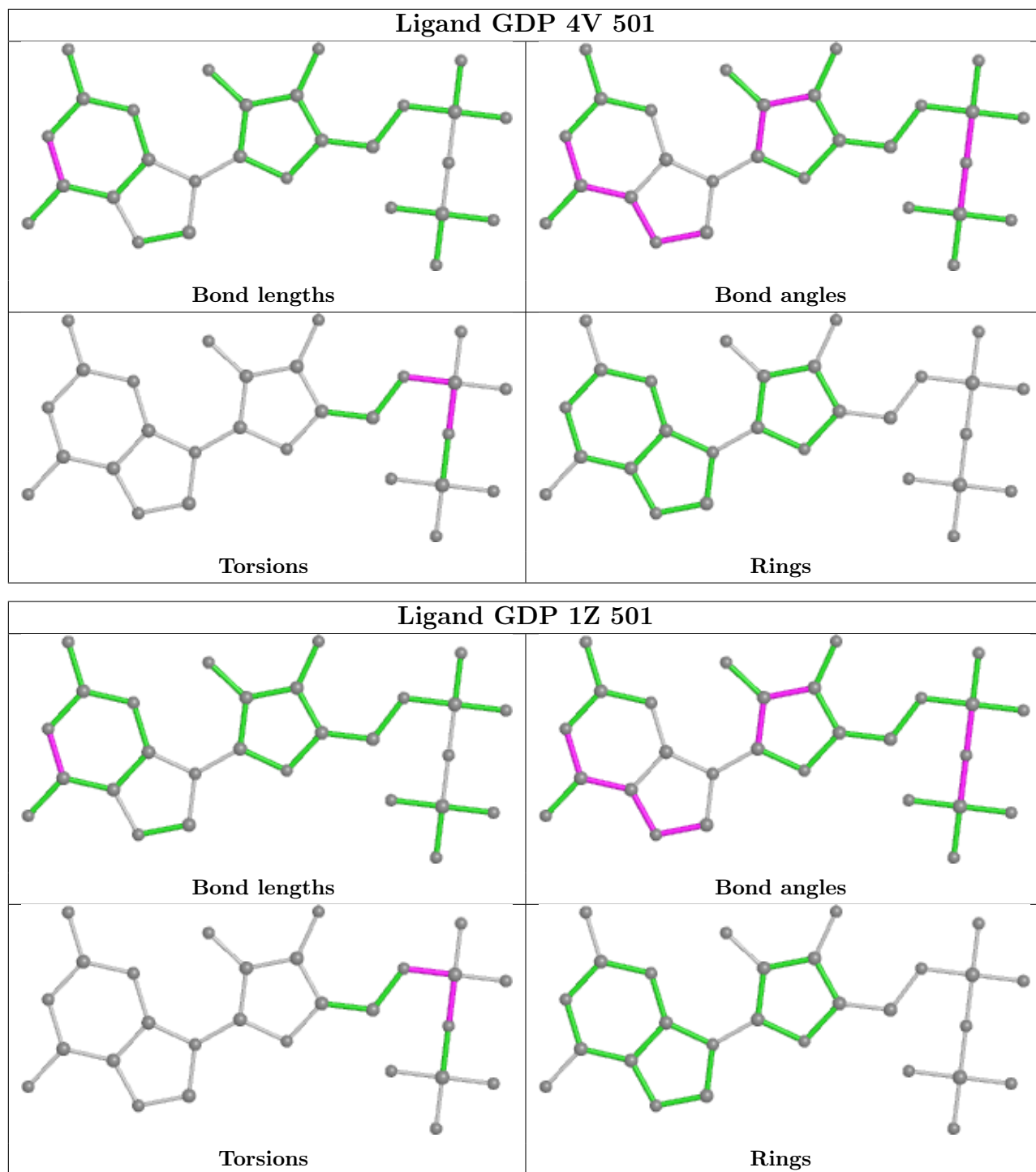

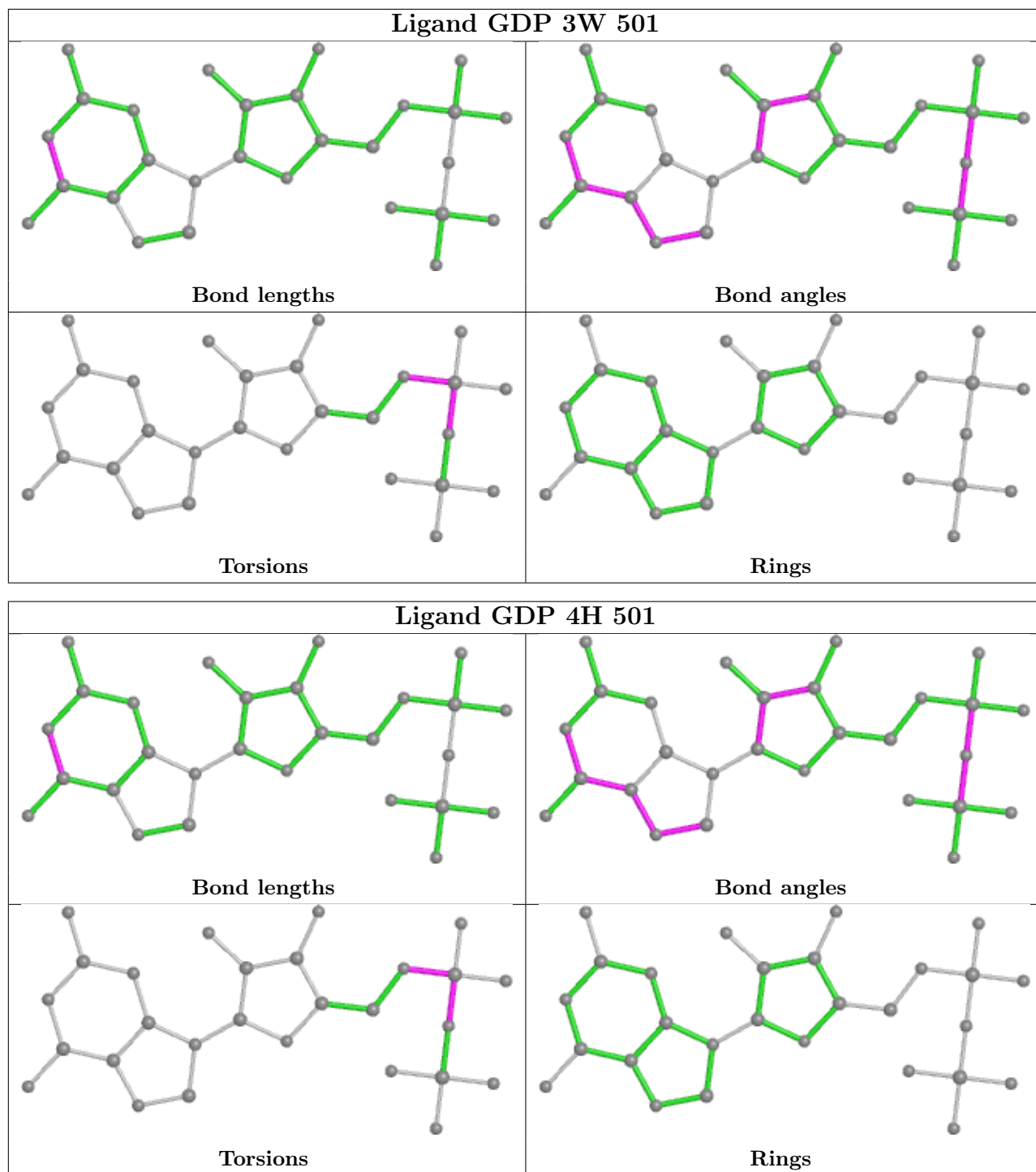

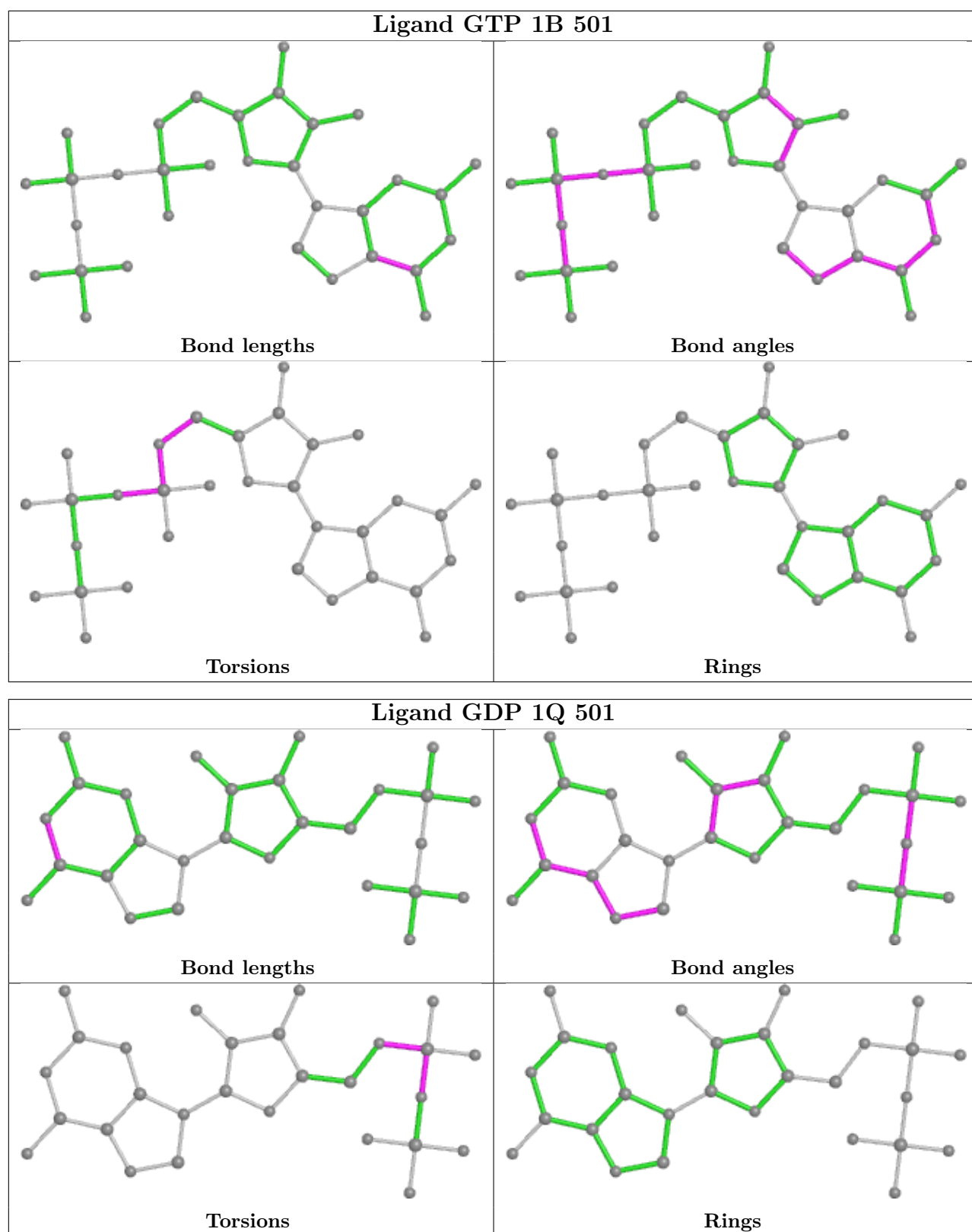

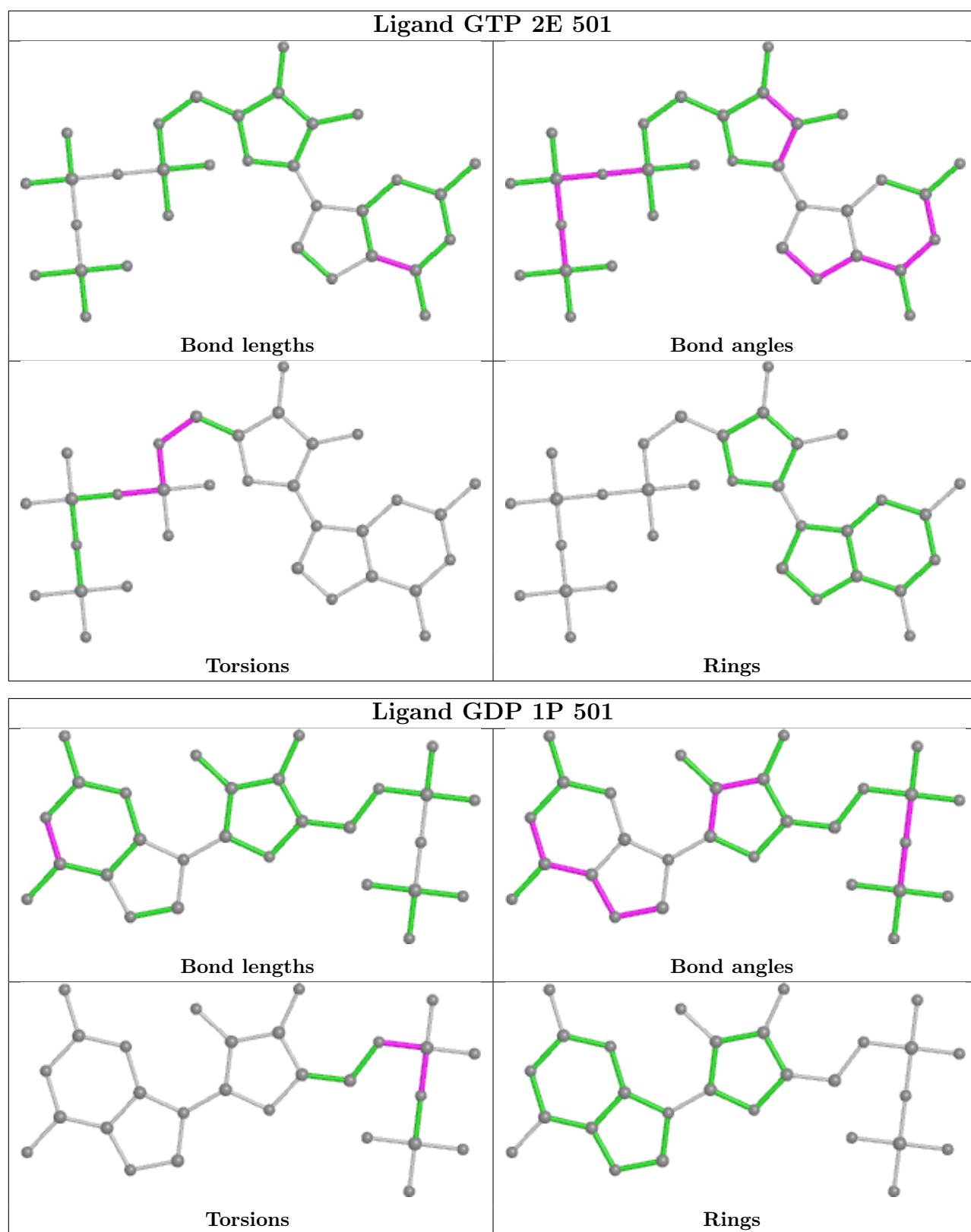



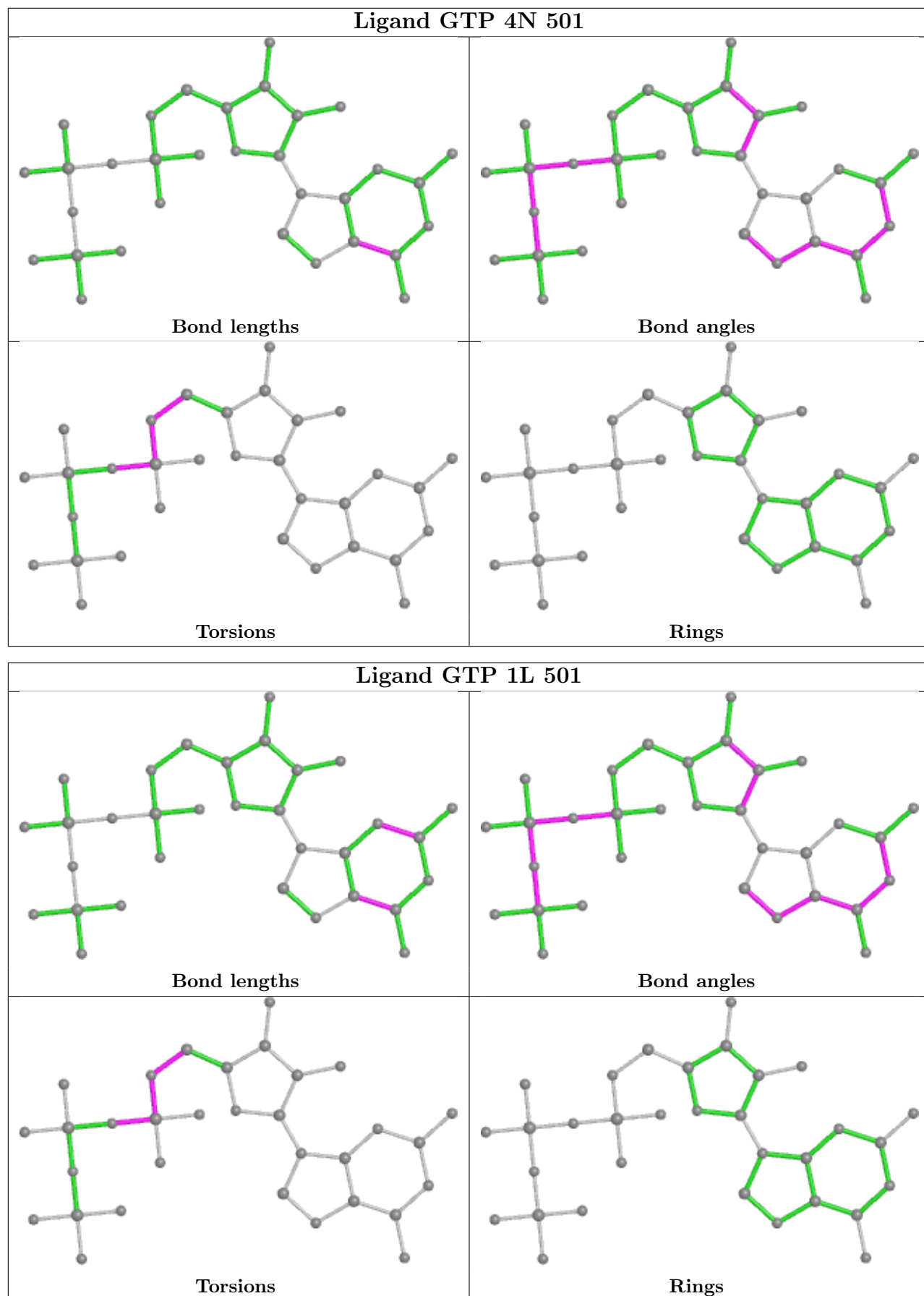

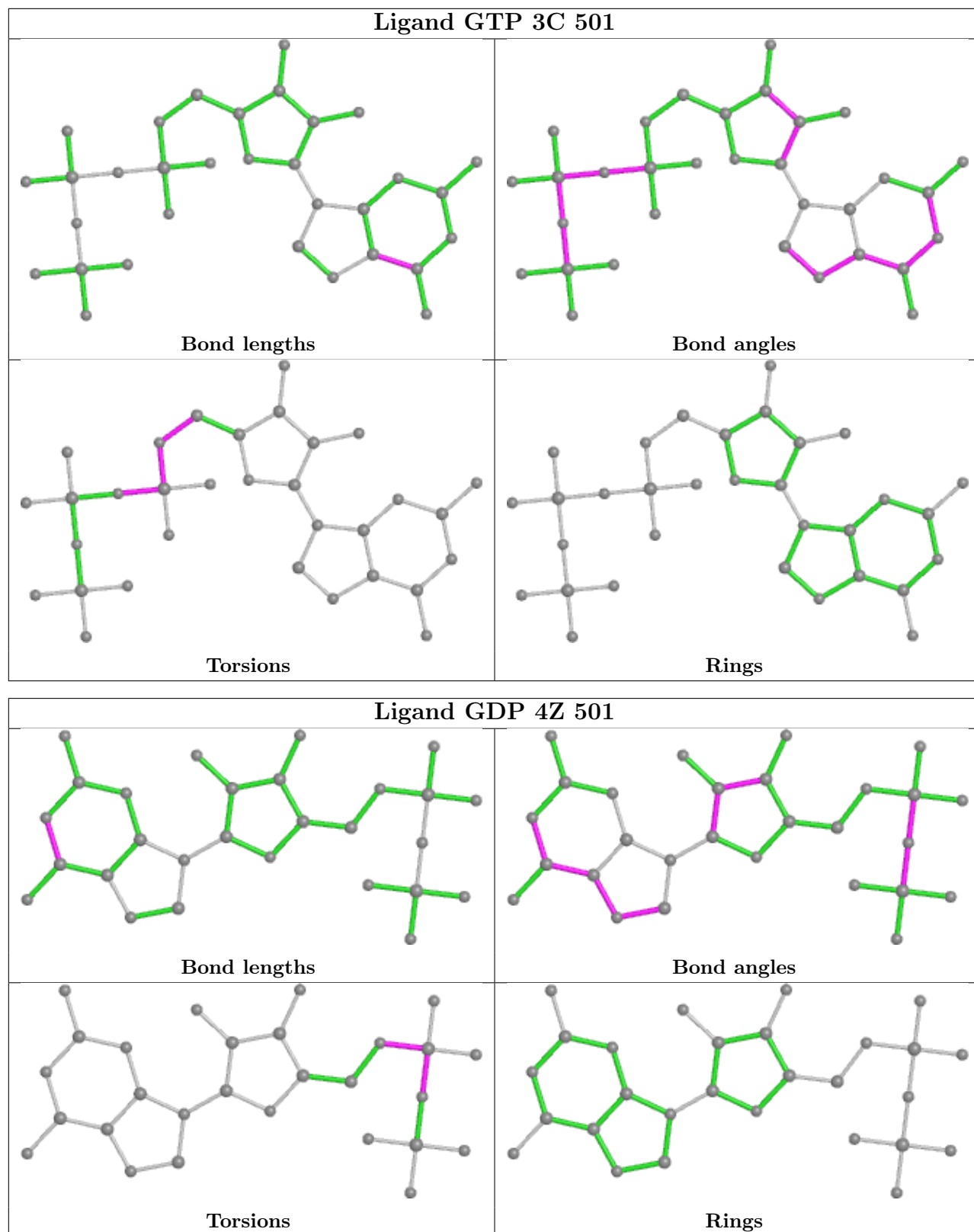

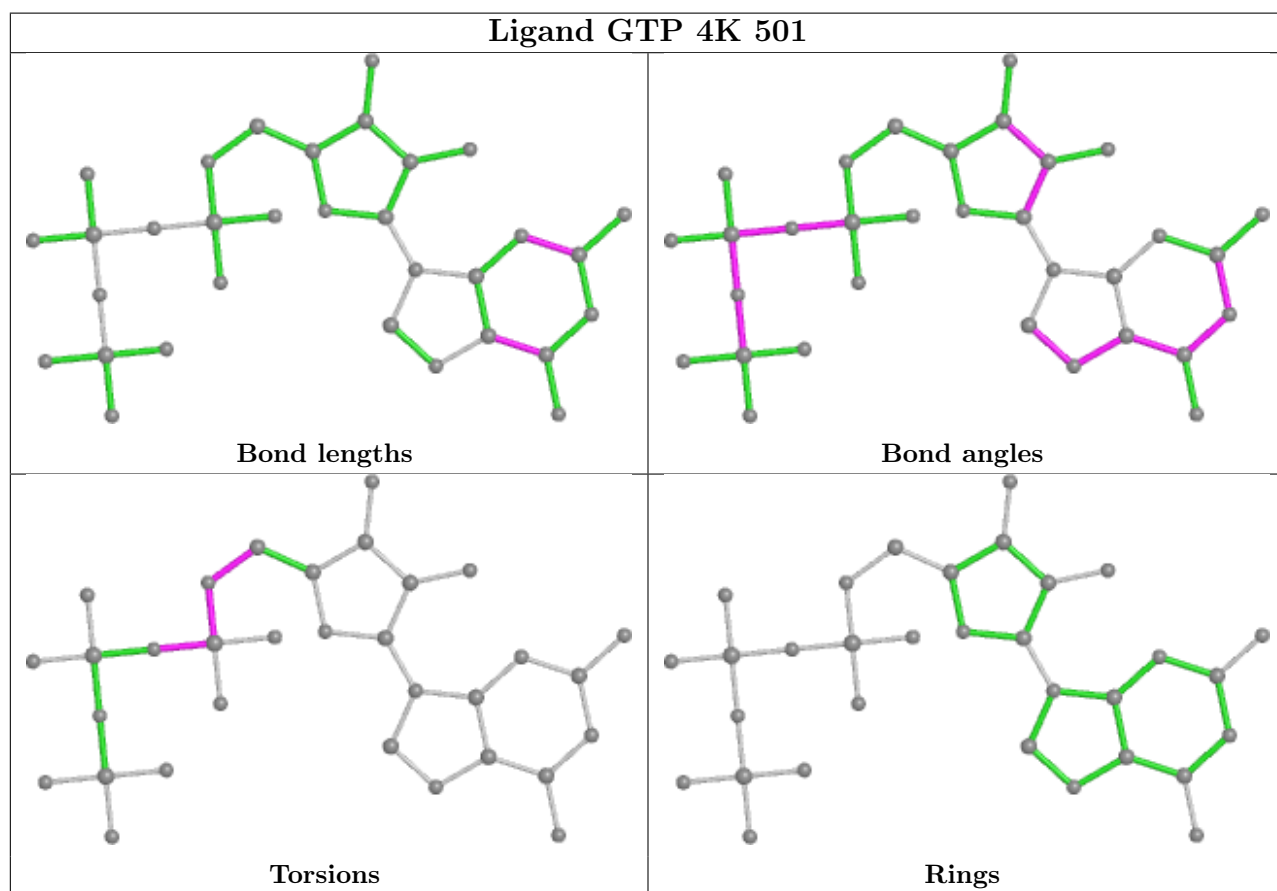
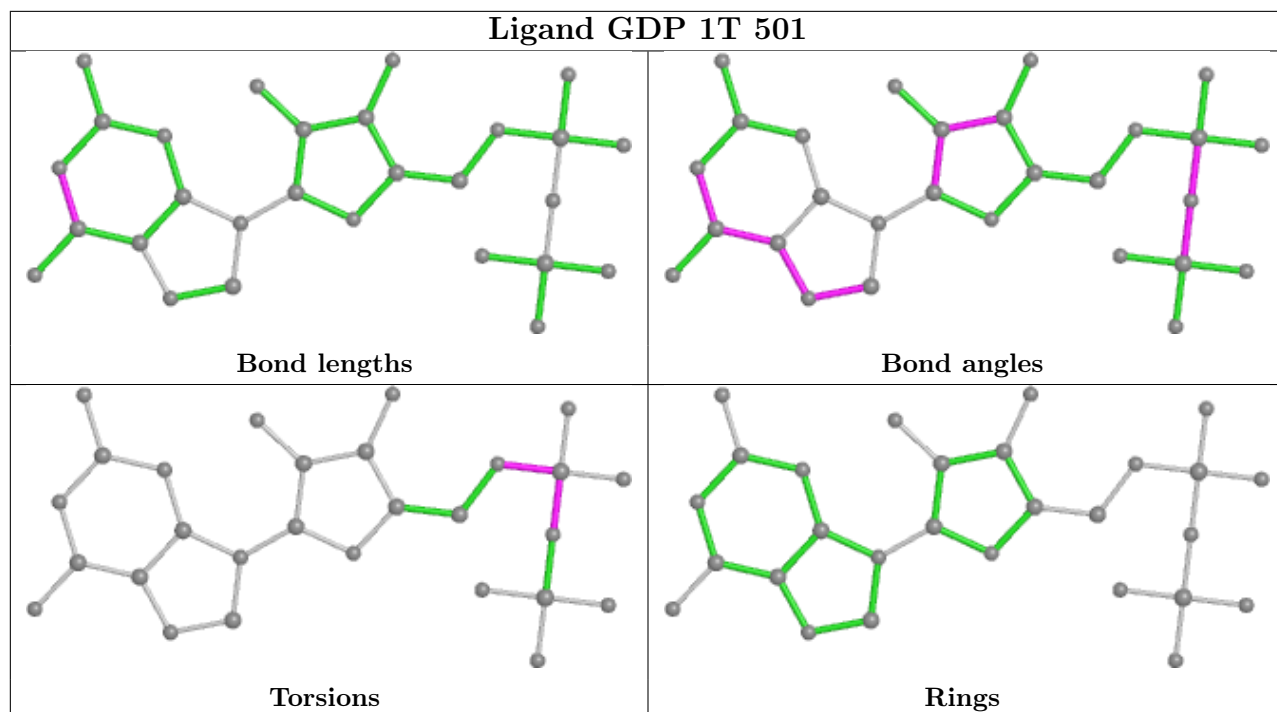

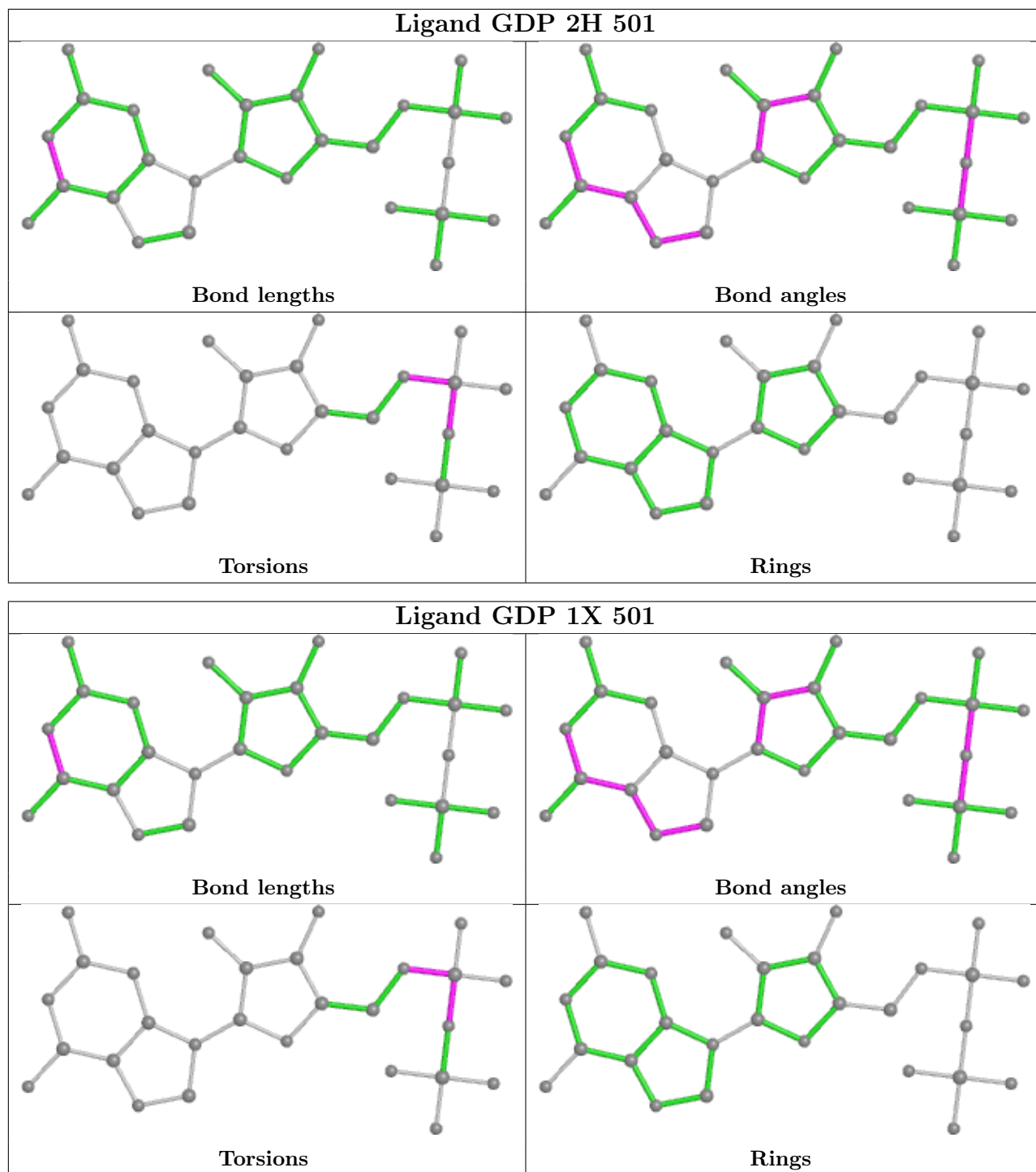

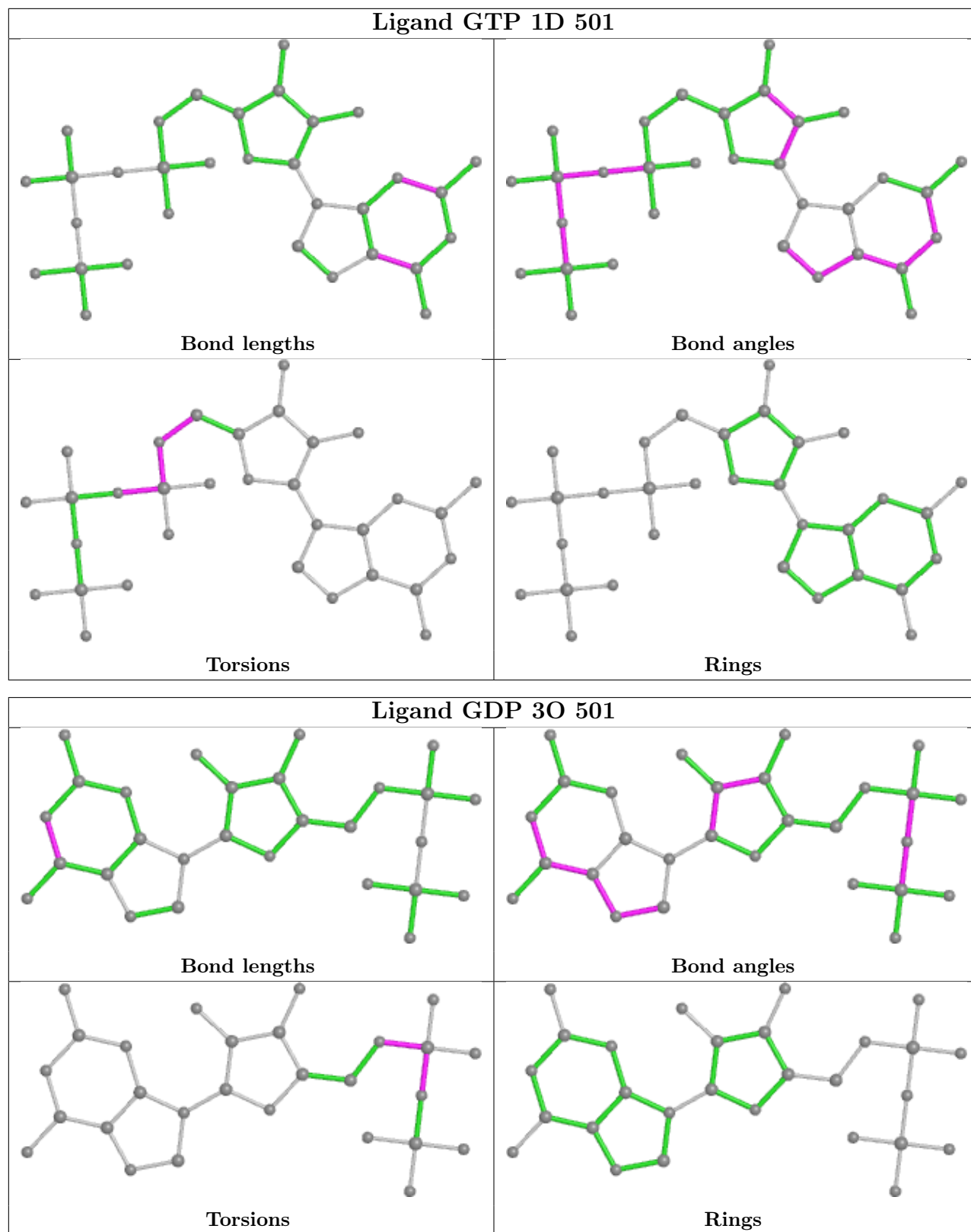

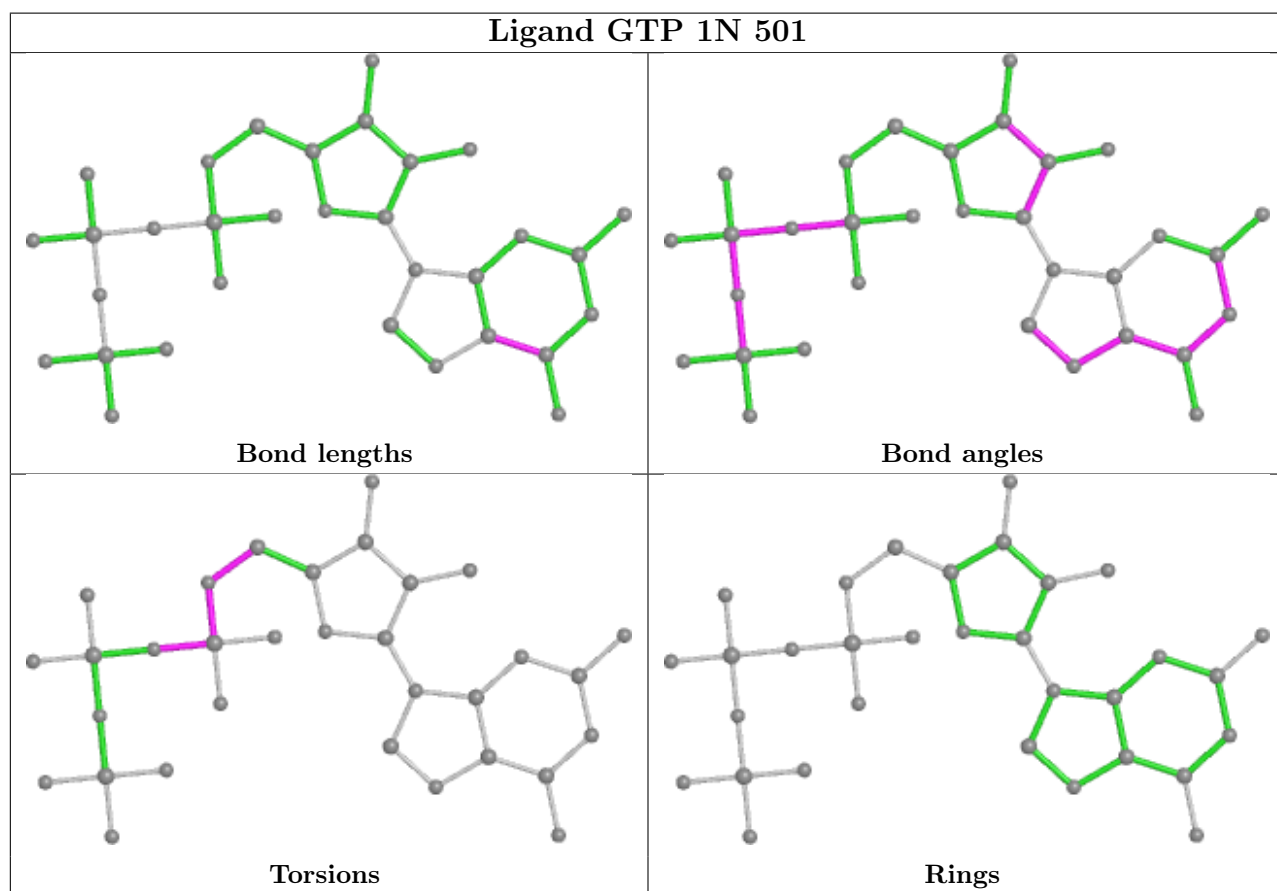
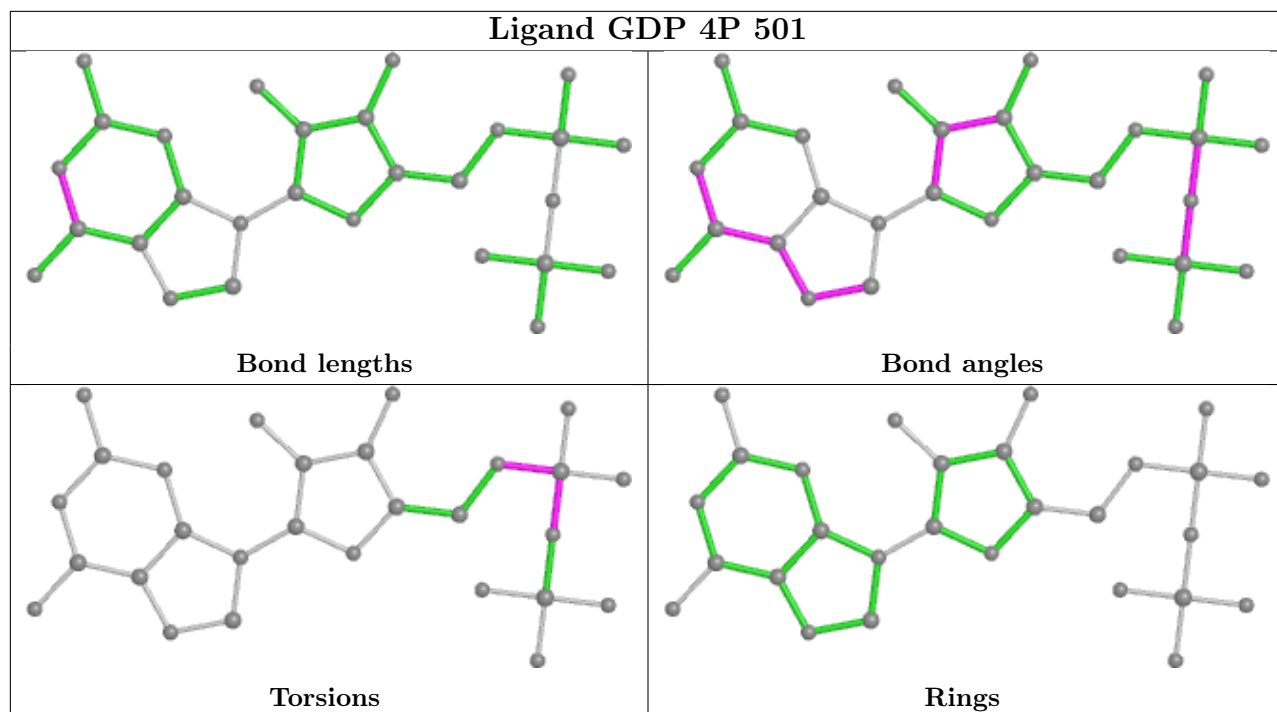

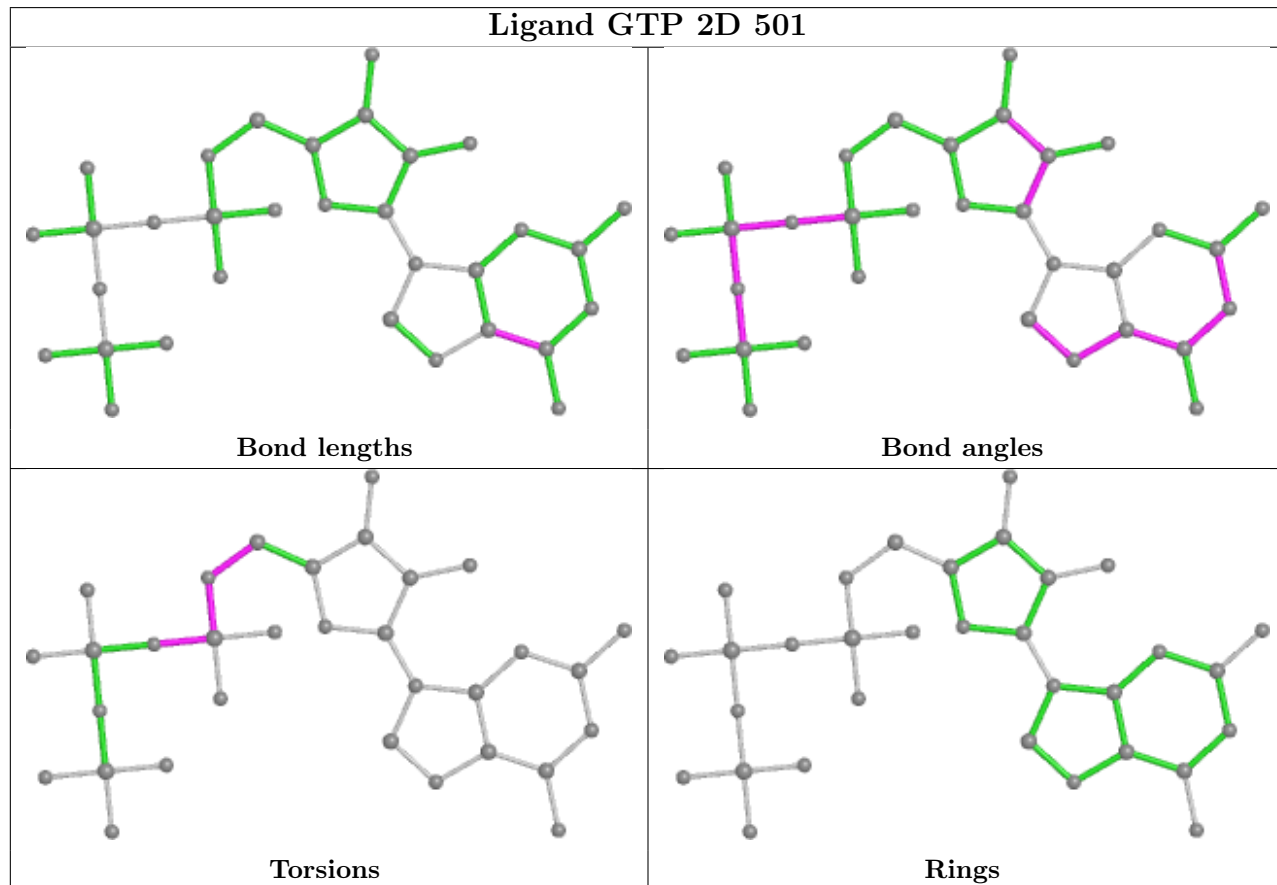
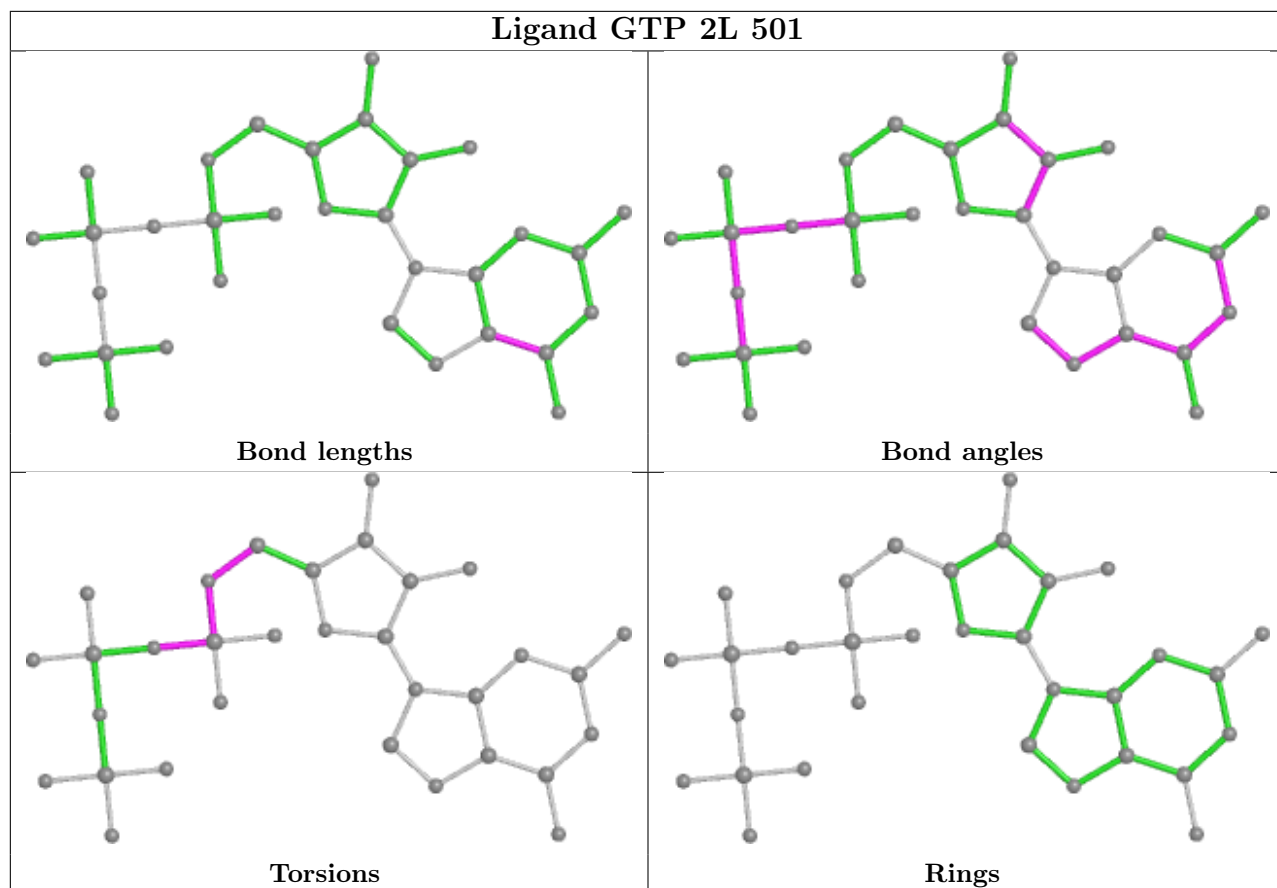

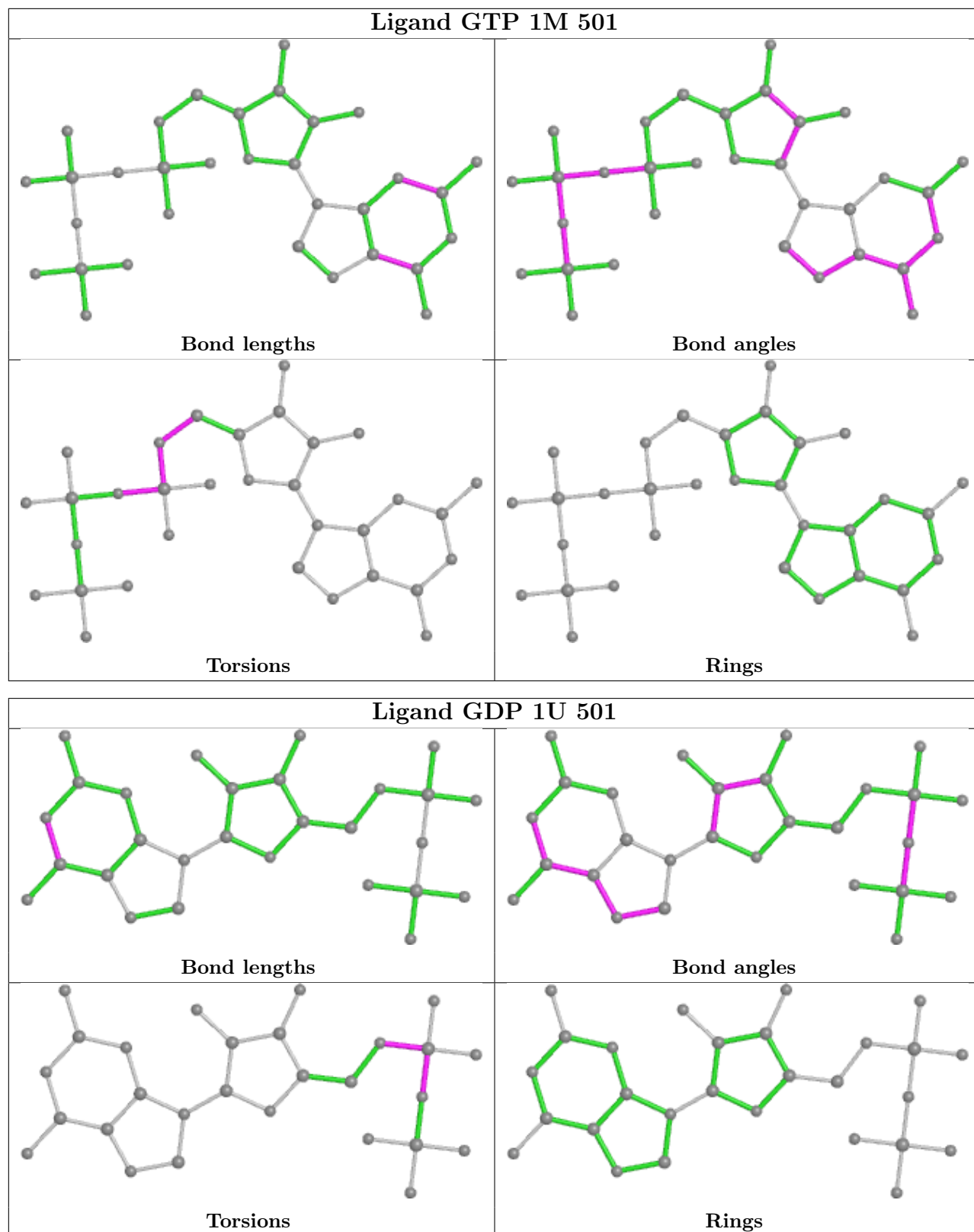



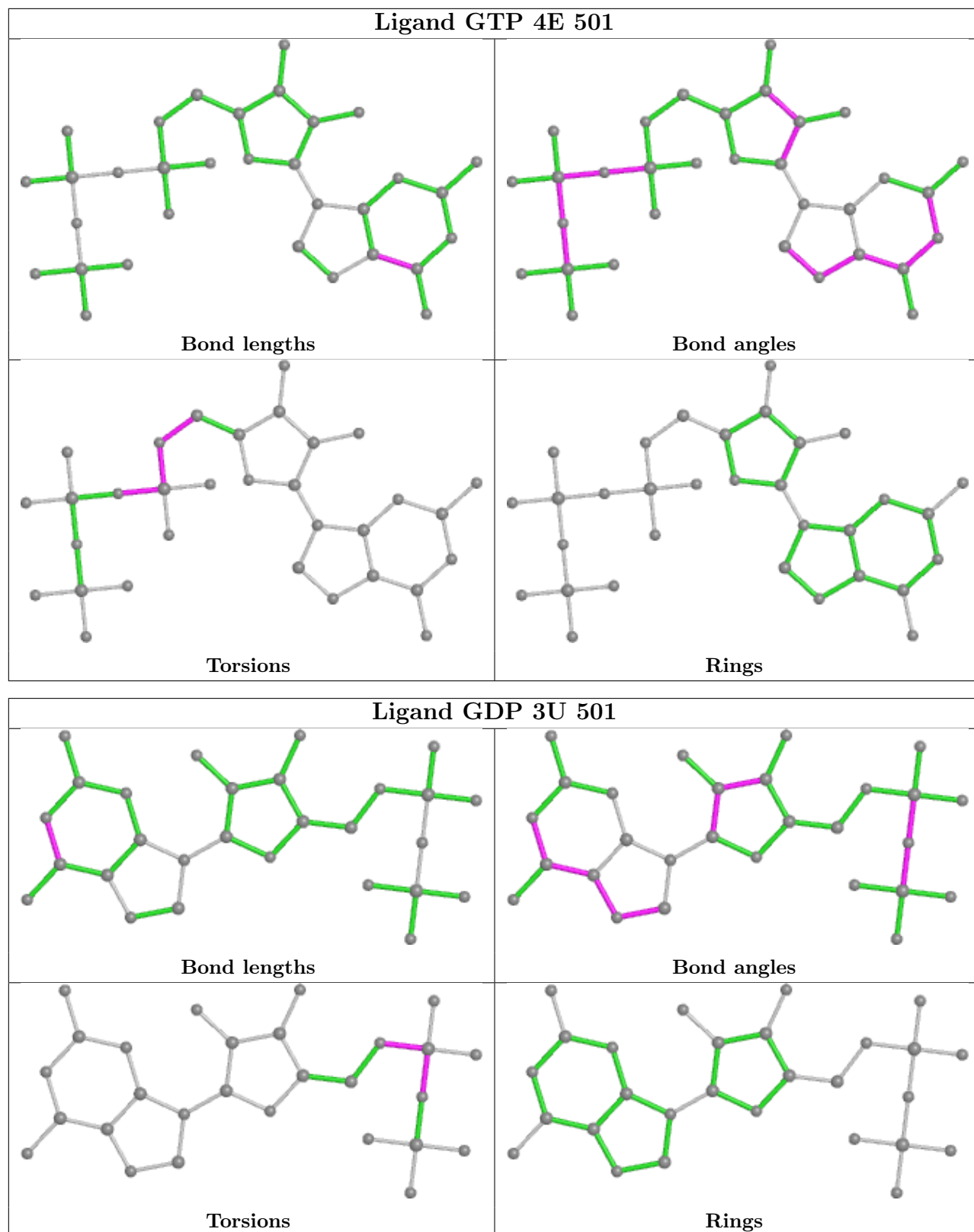

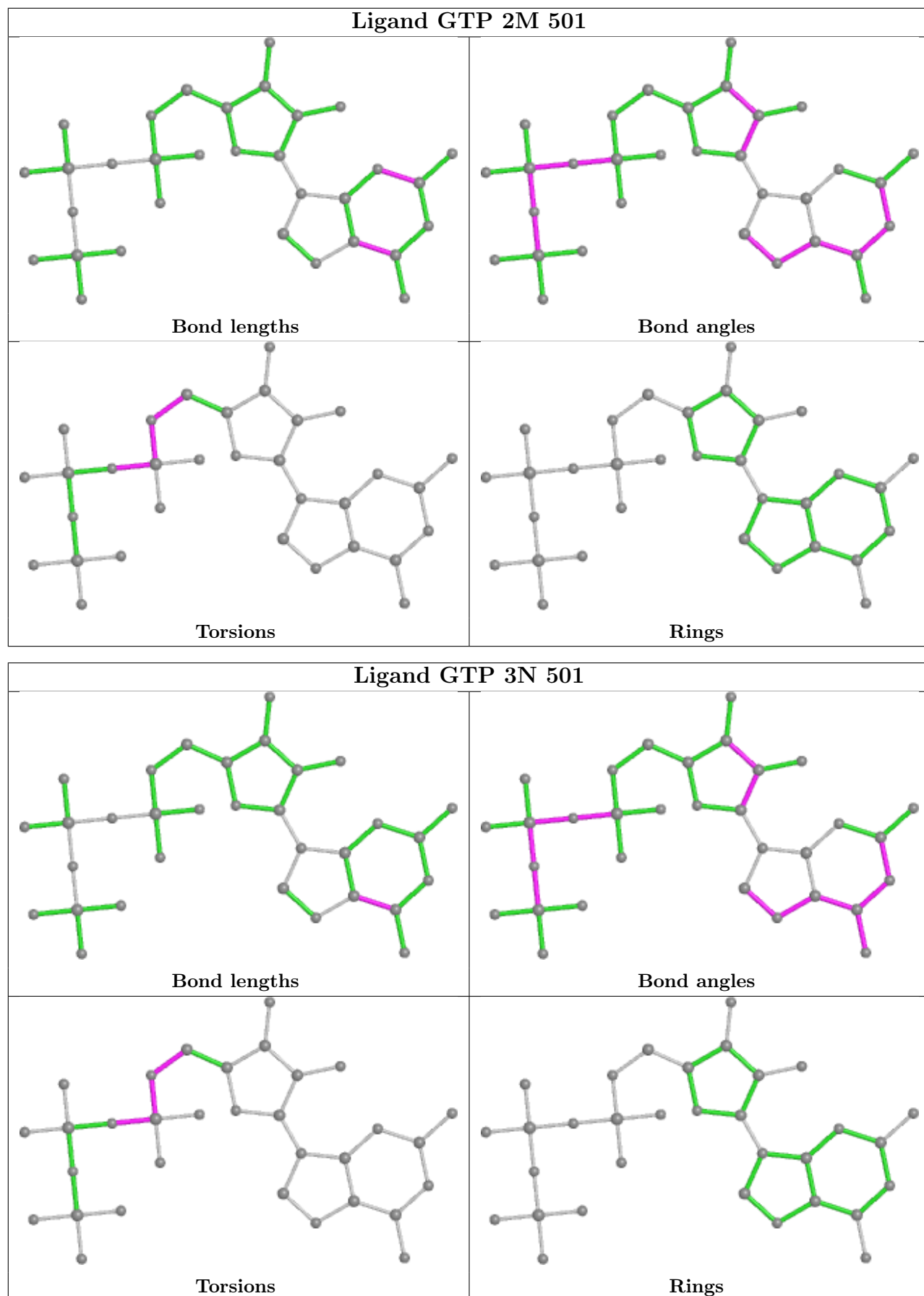

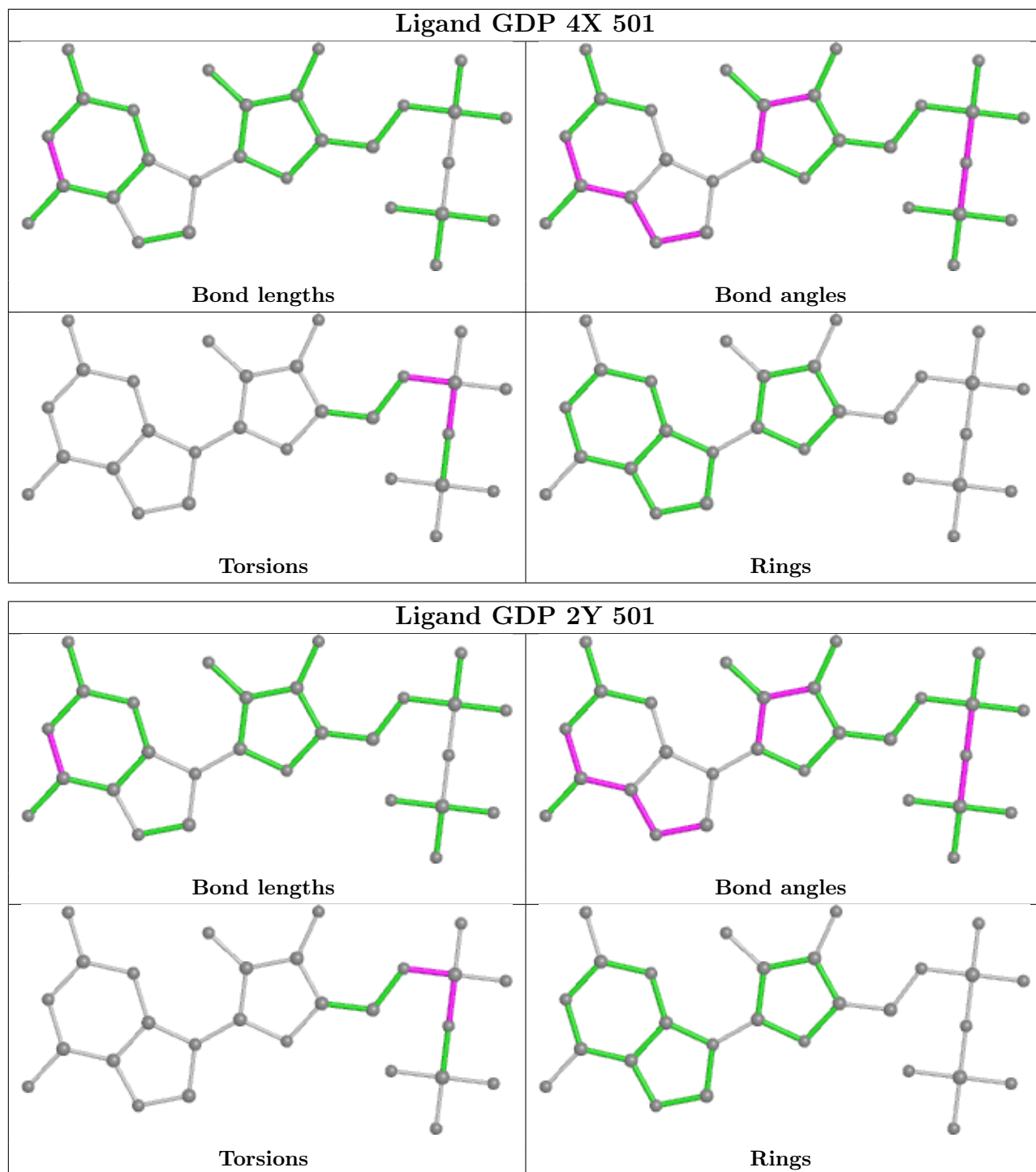

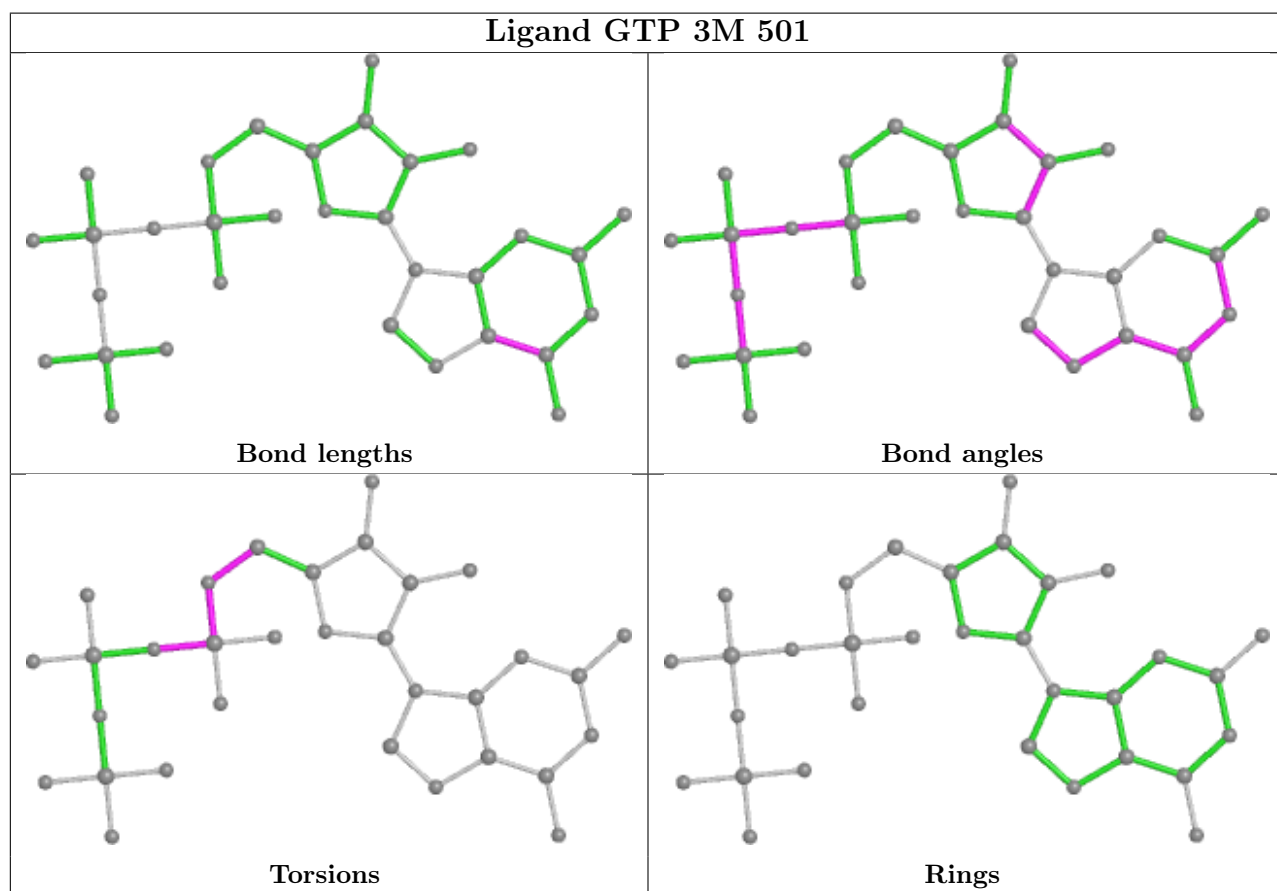
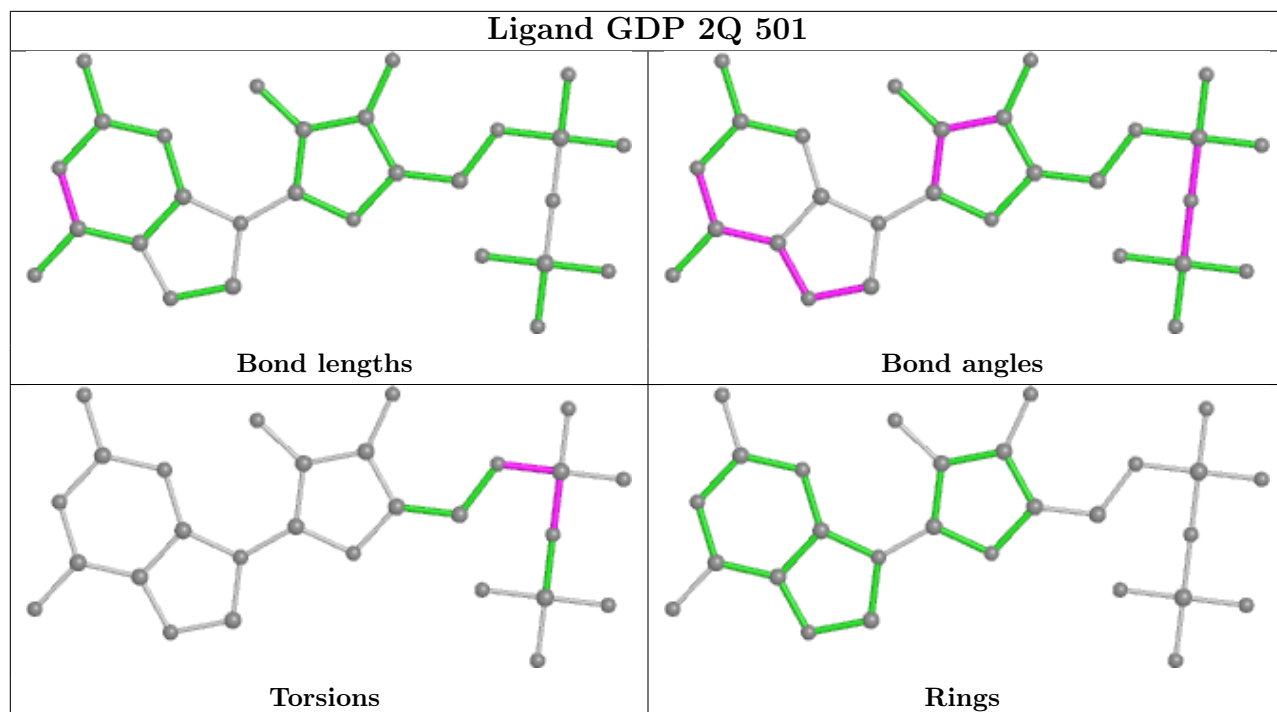

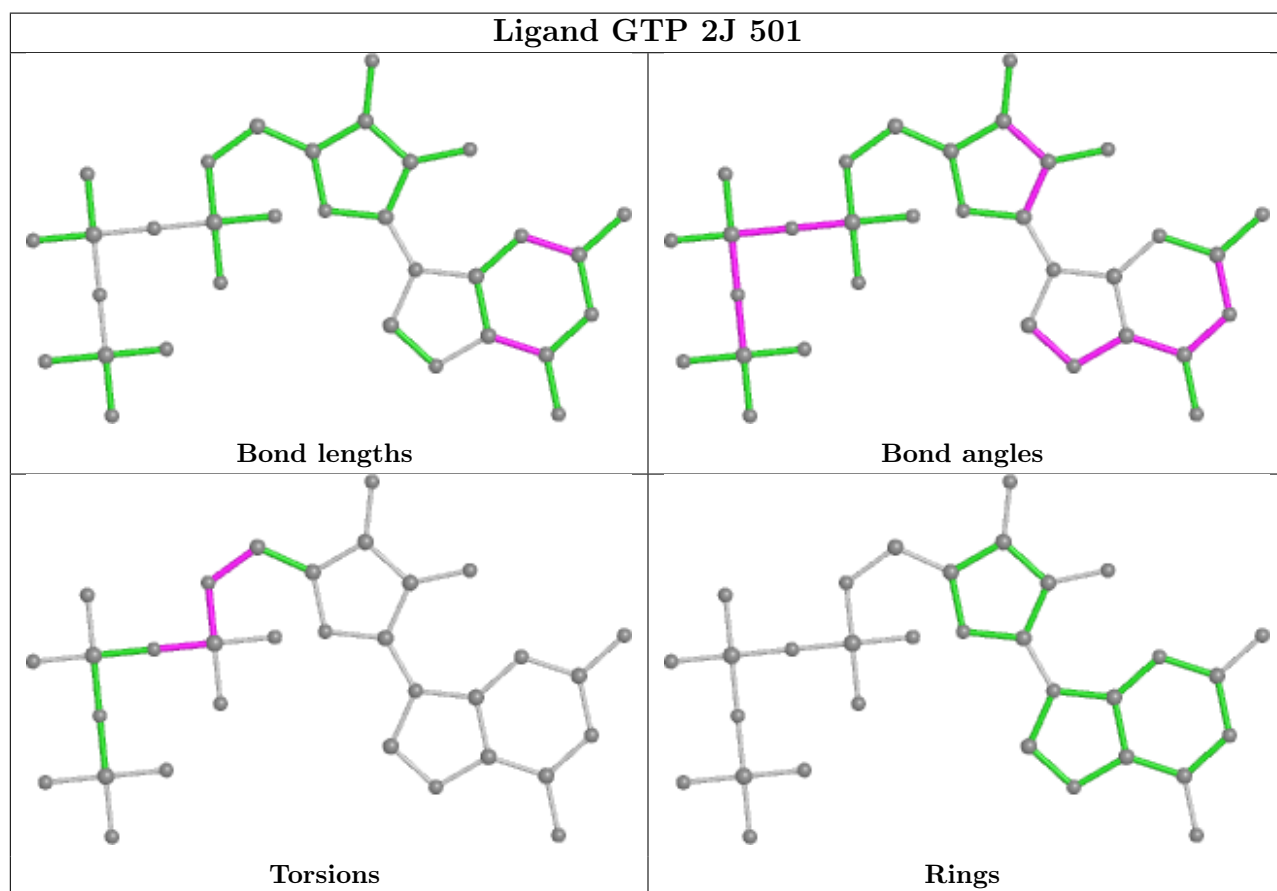
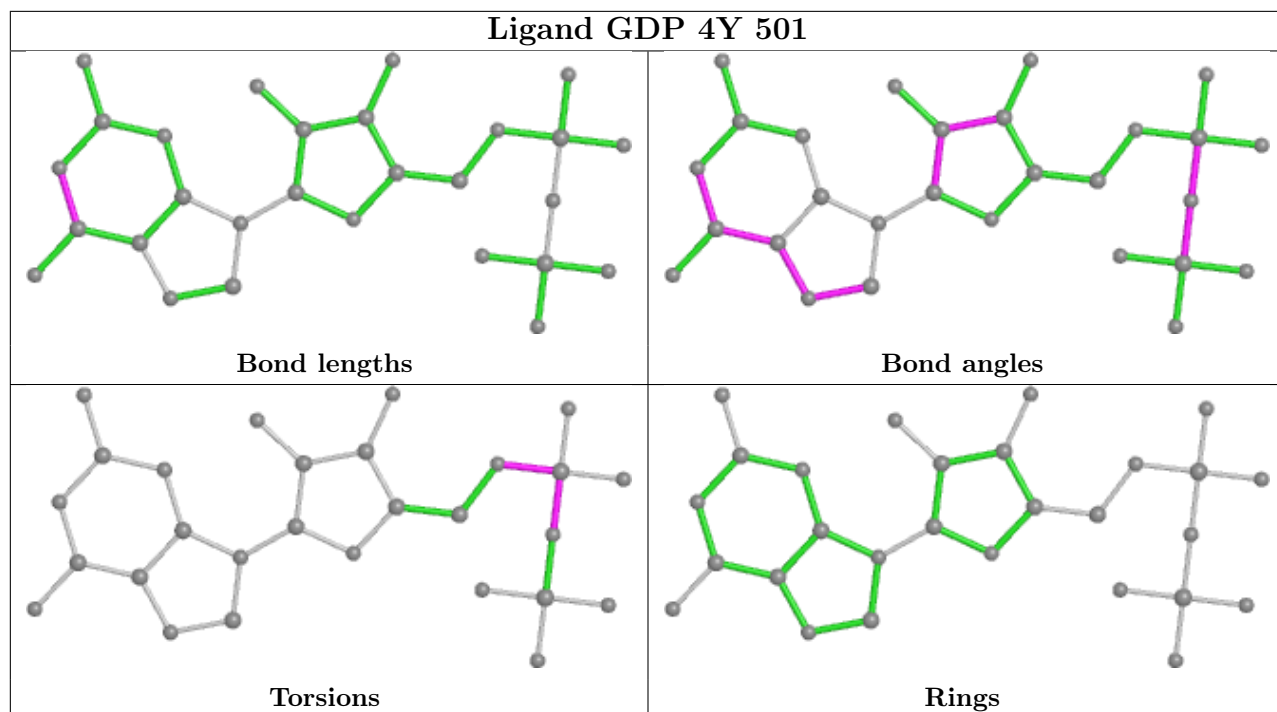

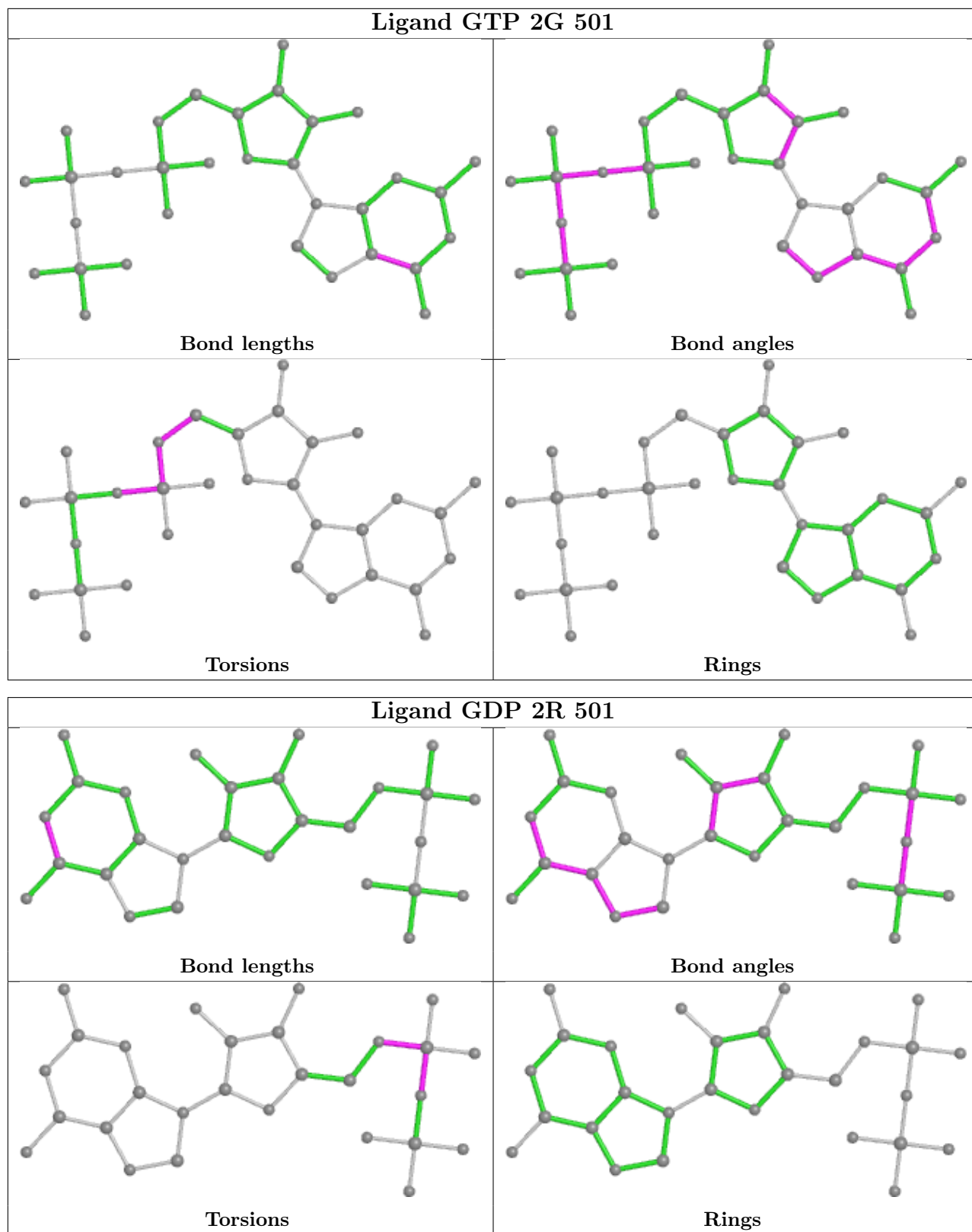

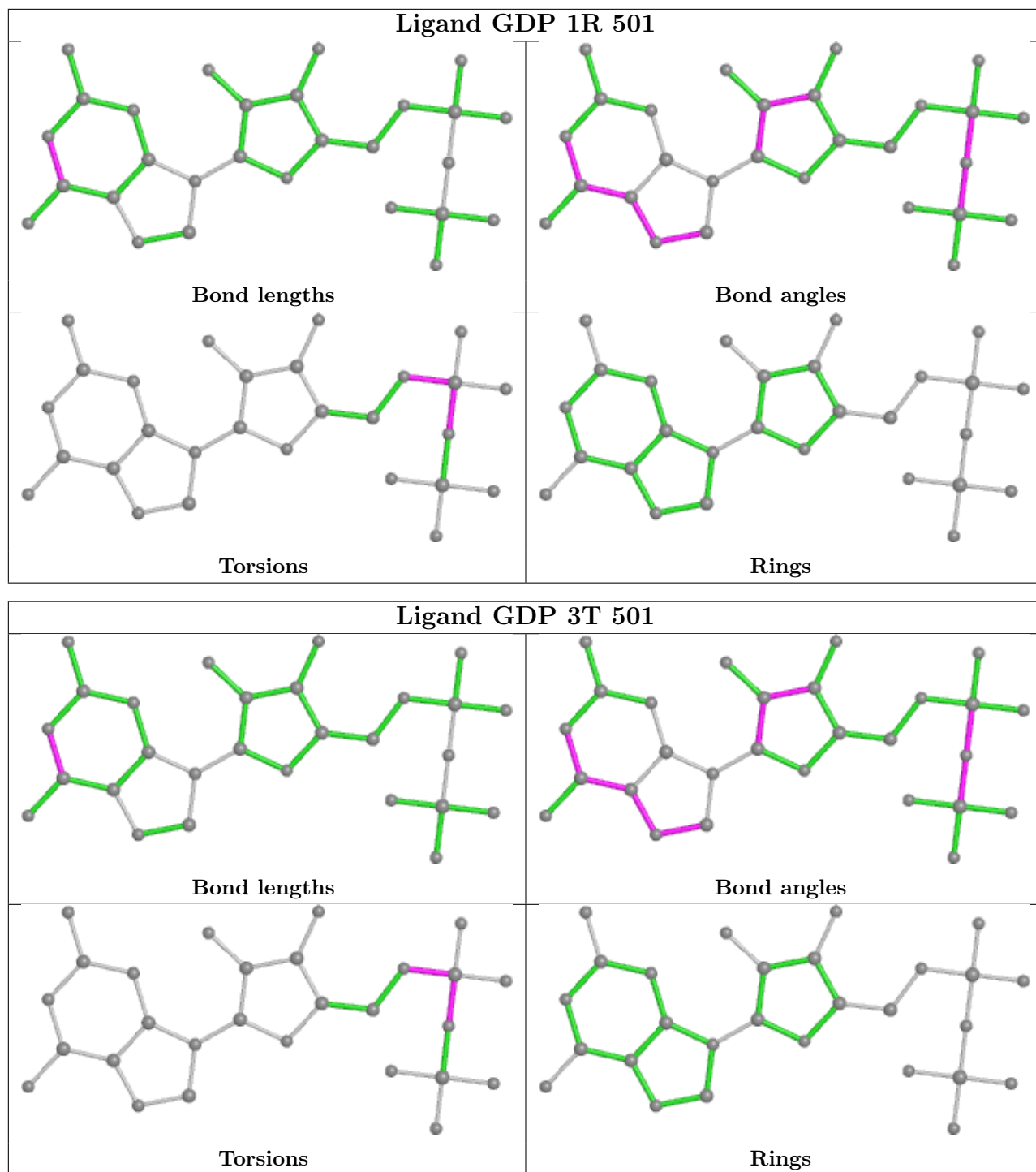

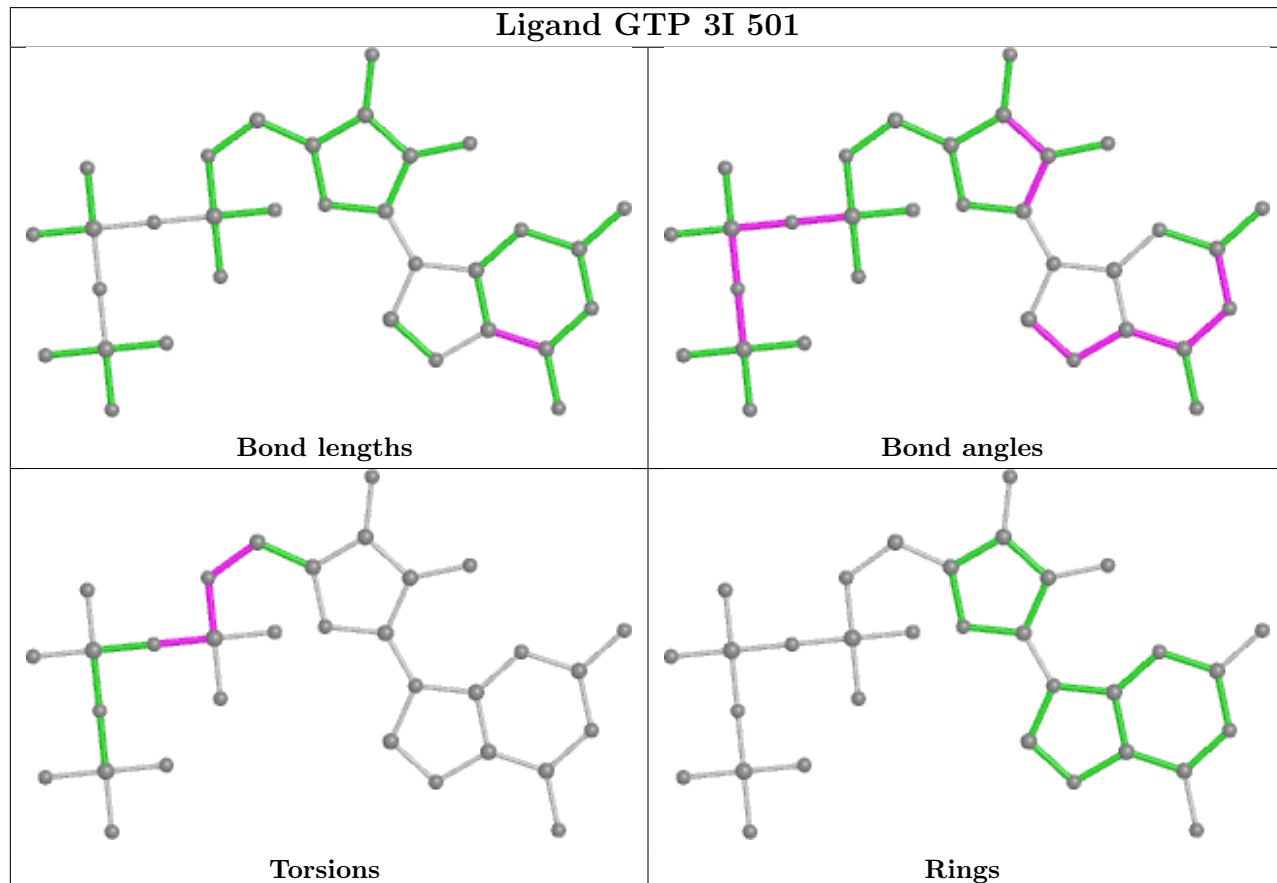
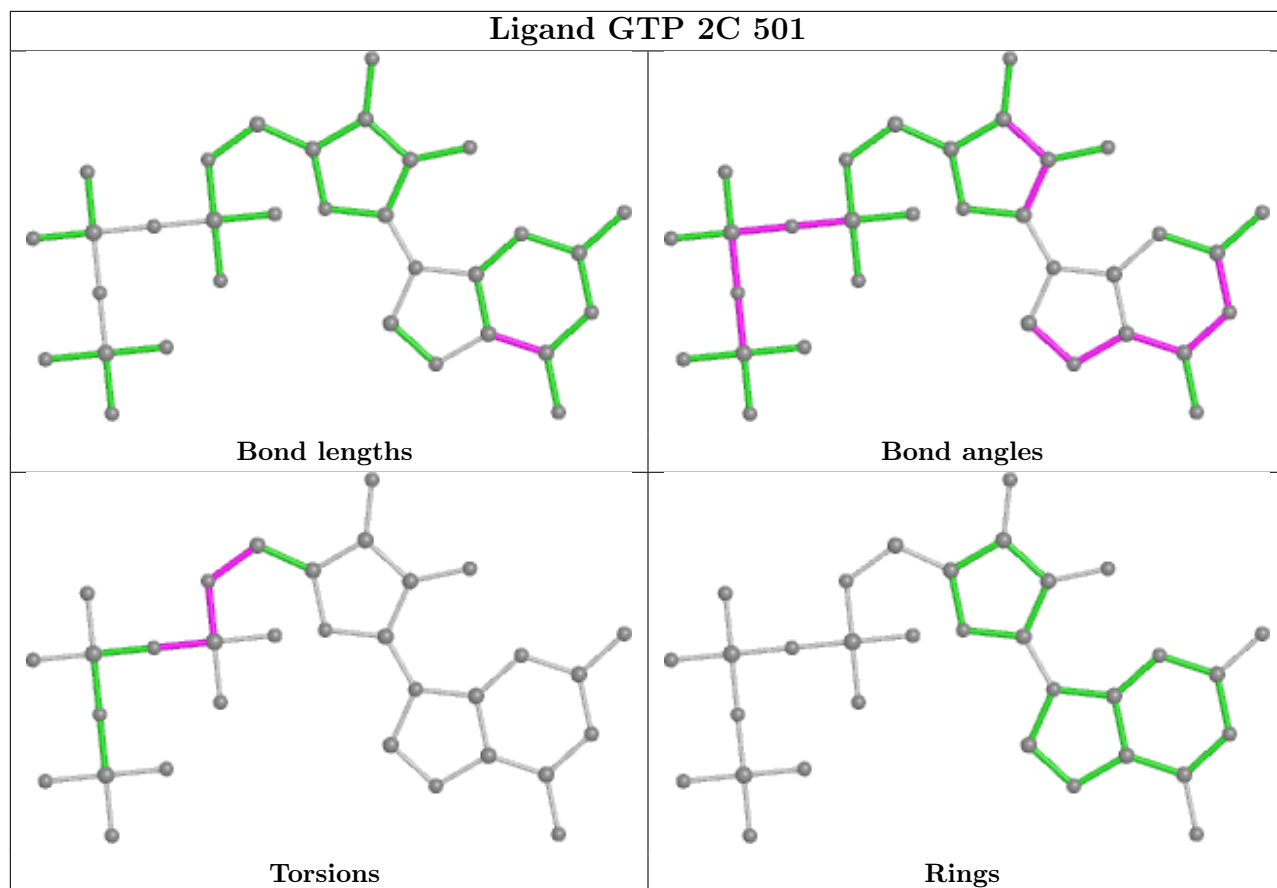



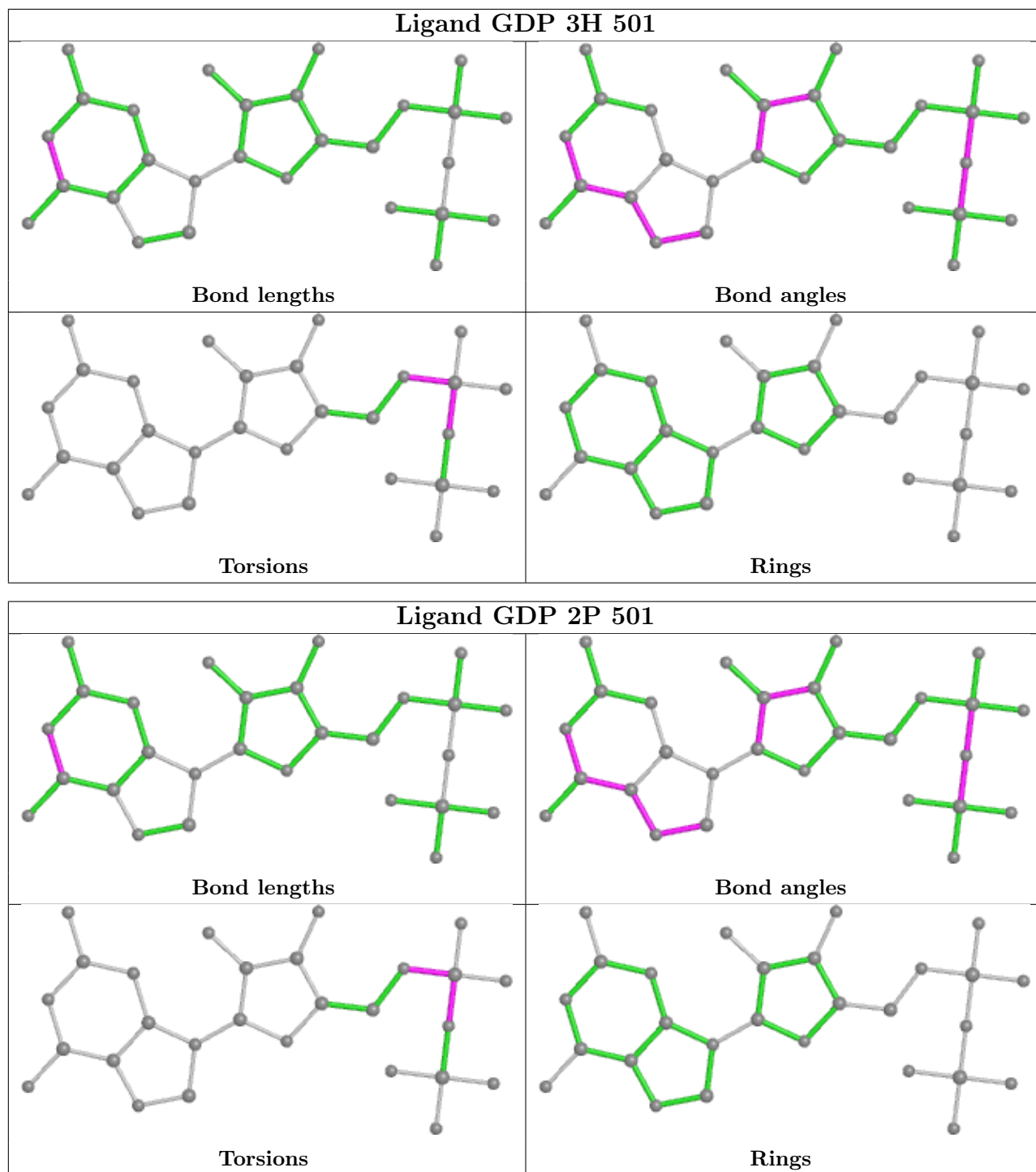

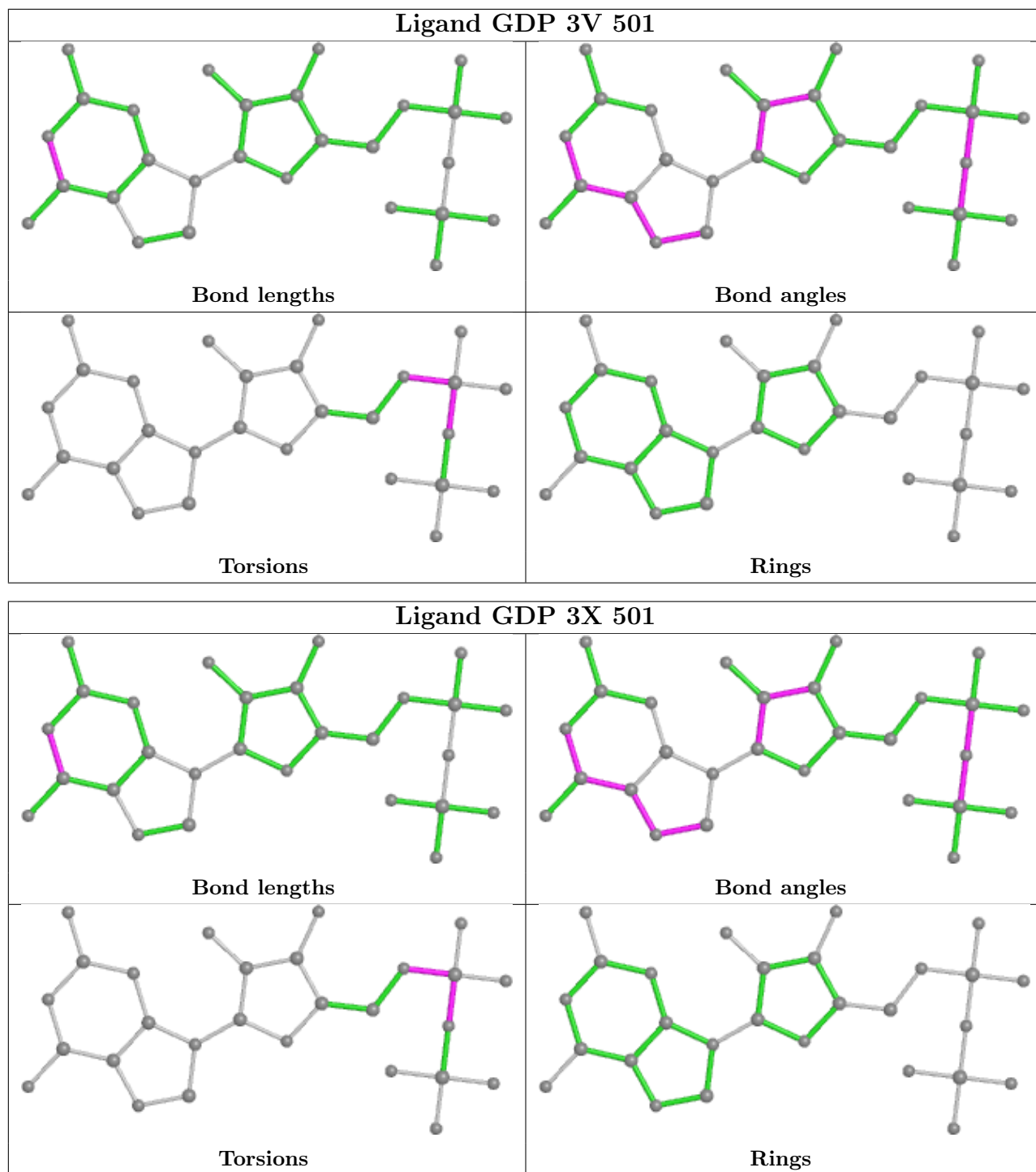

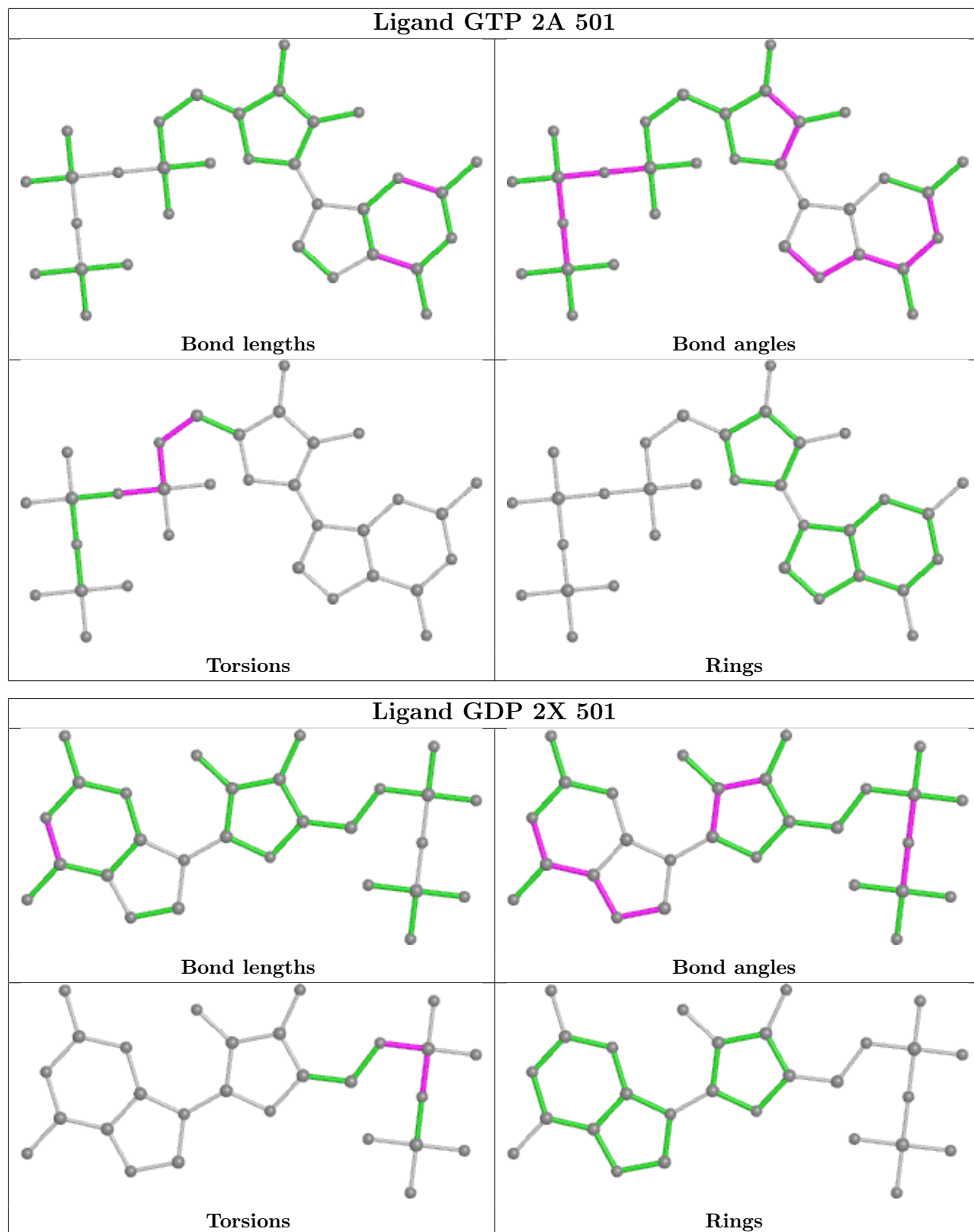

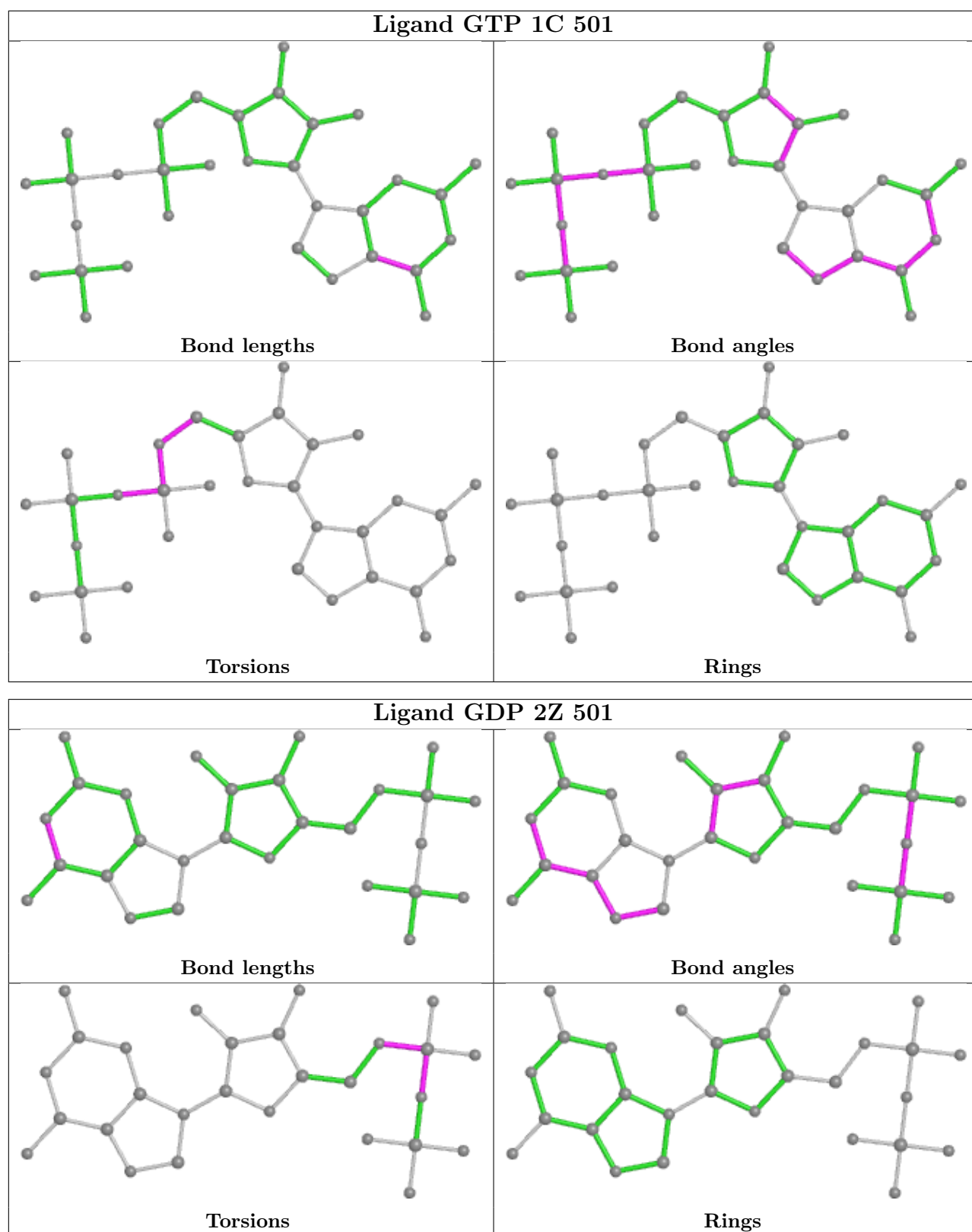

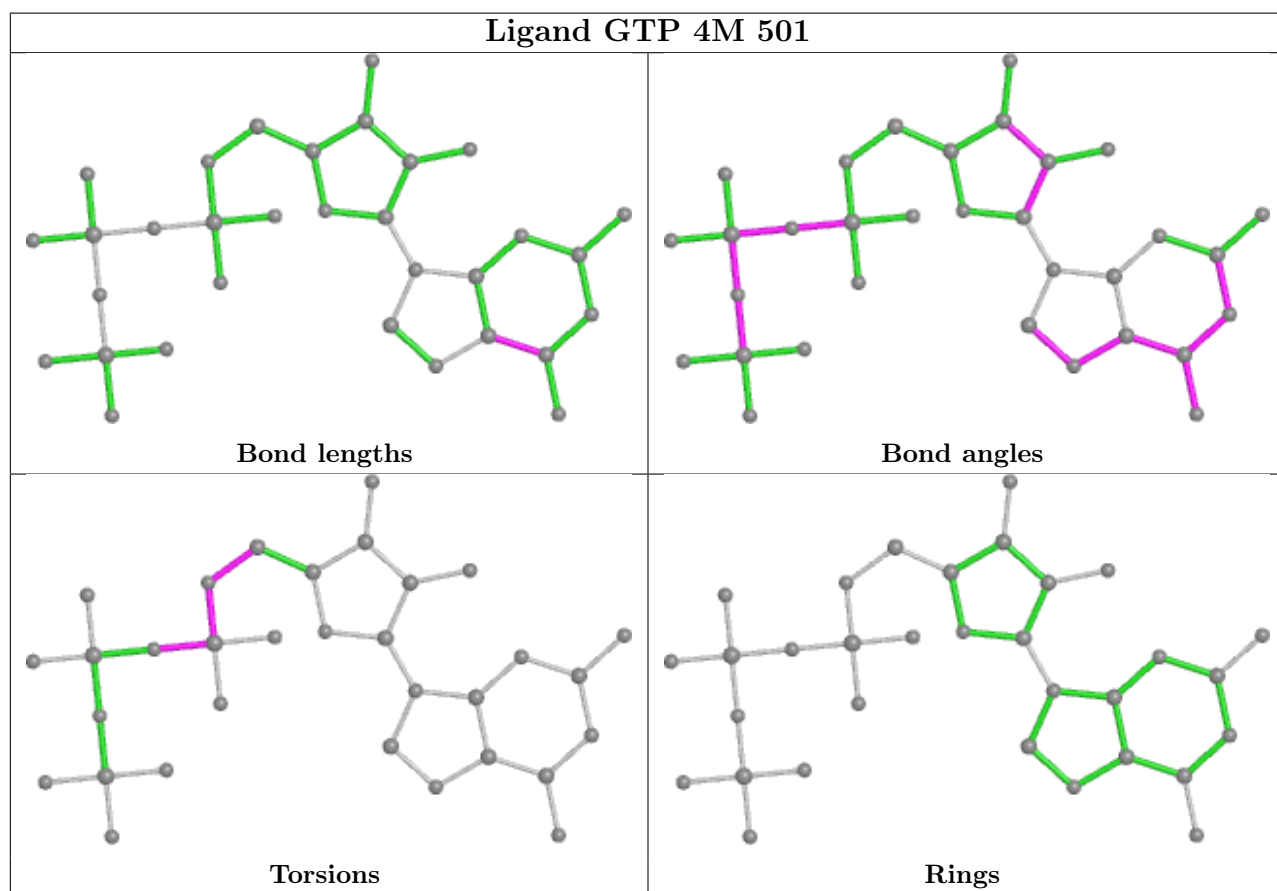
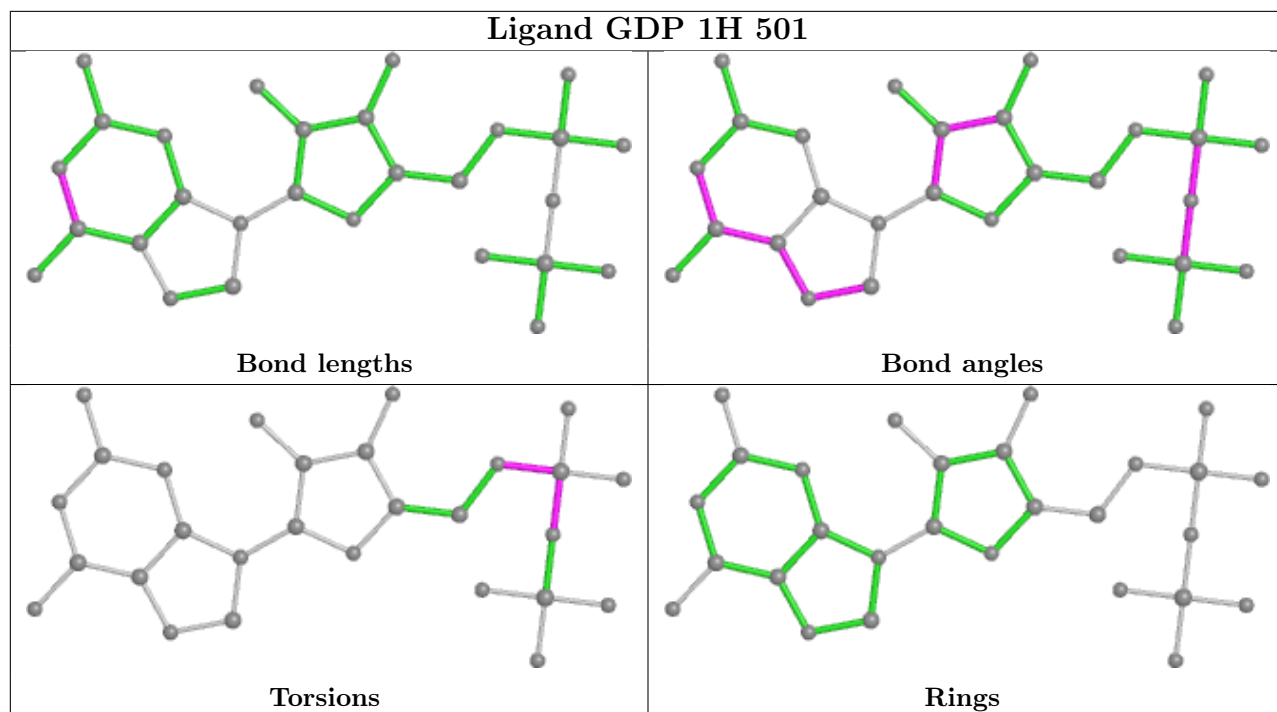

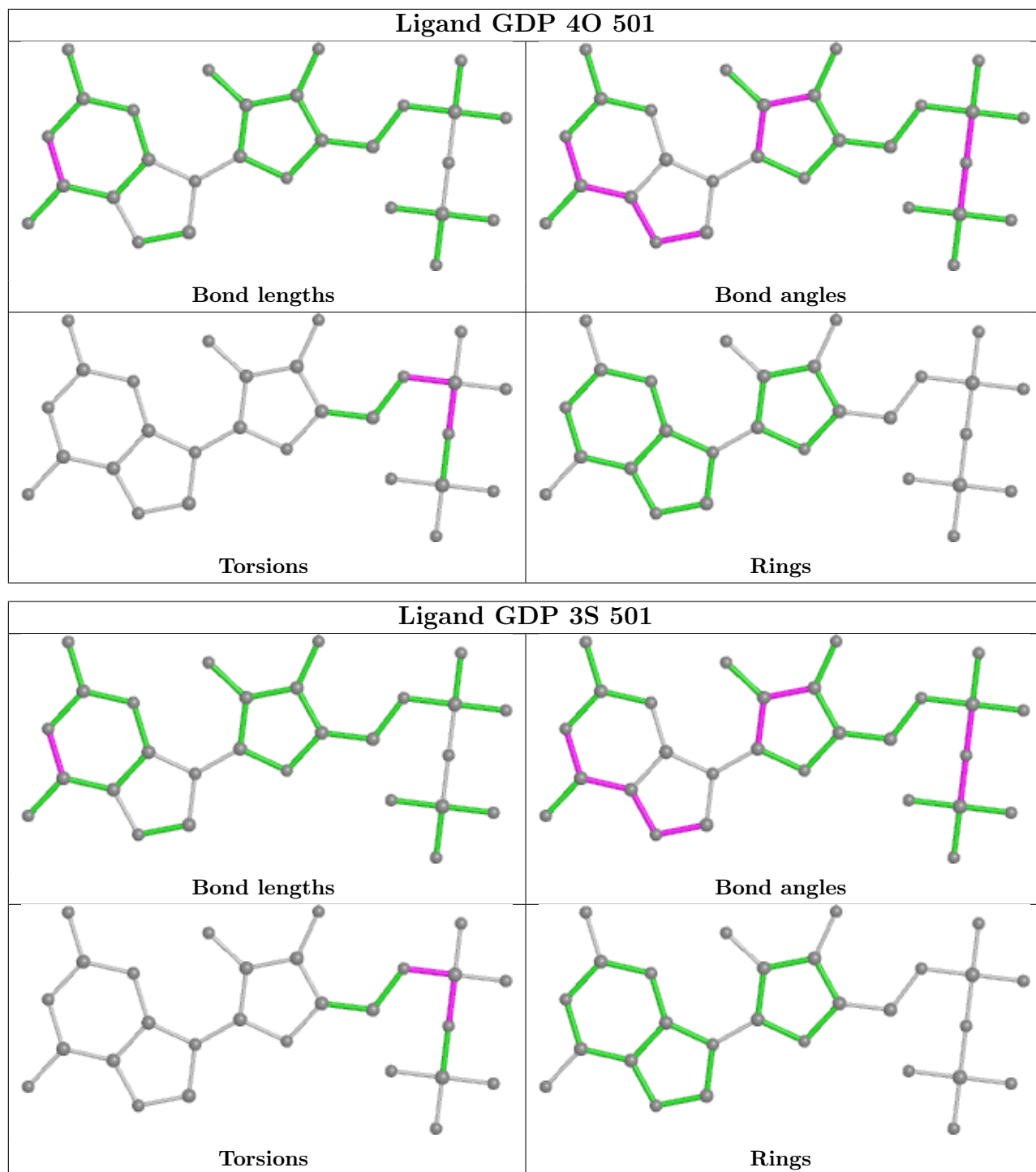

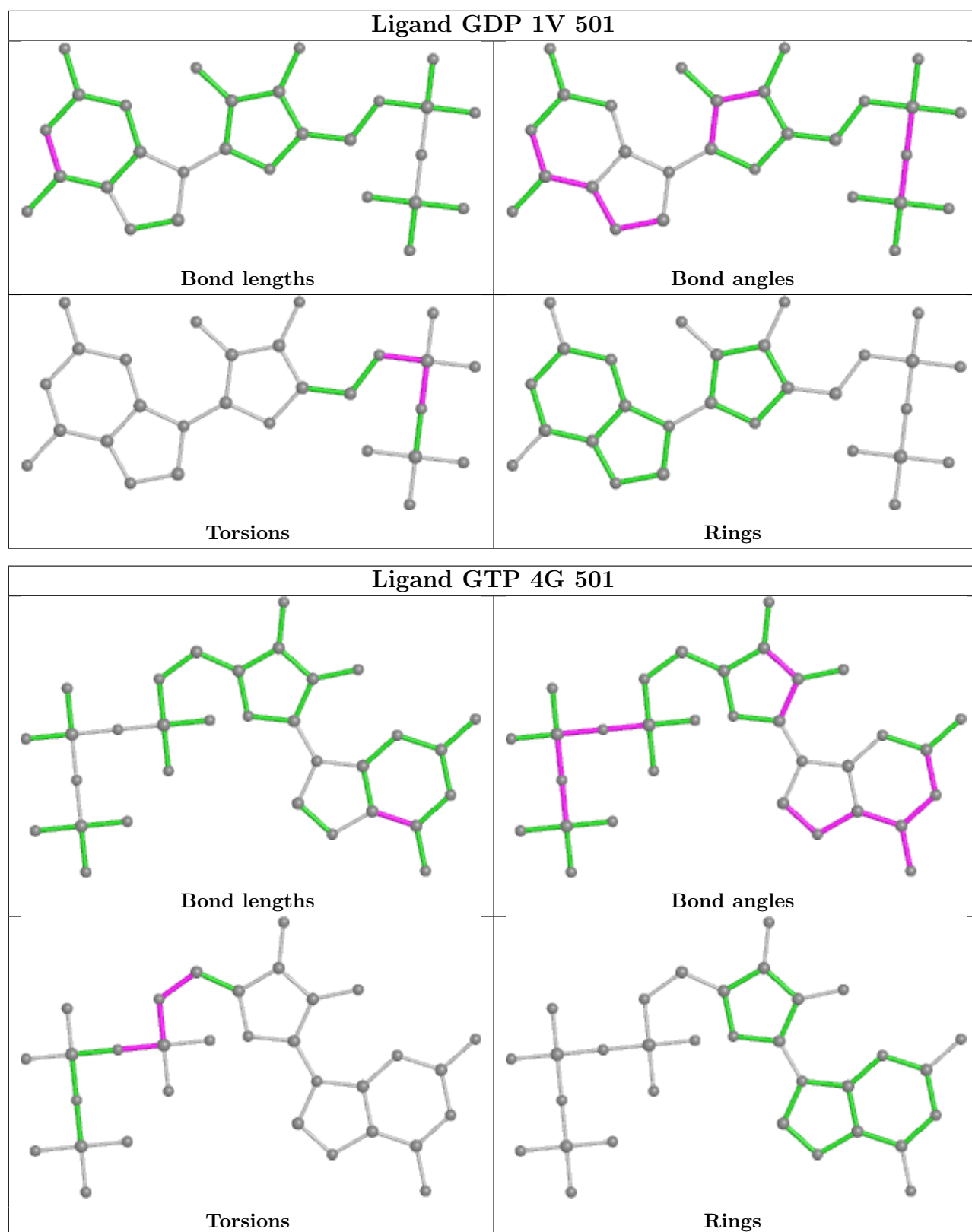

## 5.7 Other polymers [i](#)

There are no such residues in this entry.

## 5.8 Polymer linkage issues

There are no chain breaks in this entry.



## 6 Map visualisation [i](#)

This section contains visualisations of the EMDB entry EMD-0615. These allow visual inspection of the internal detail of the map and identification of artifacts.

Images derived from a raw map, generated by summing the deposited half-maps, are presented below the corresponding image components of the primary map to allow further visual inspection and comparison with those of the primary map.

### 6.1 Orthogonal projections [i](#)

#### 6.1.1 Primary map

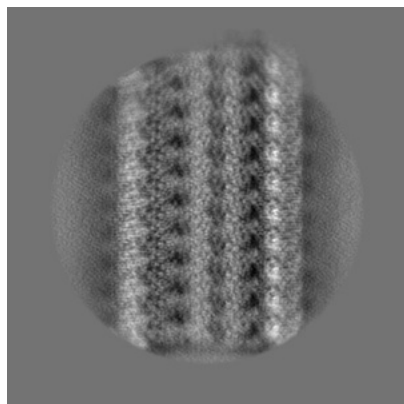

X

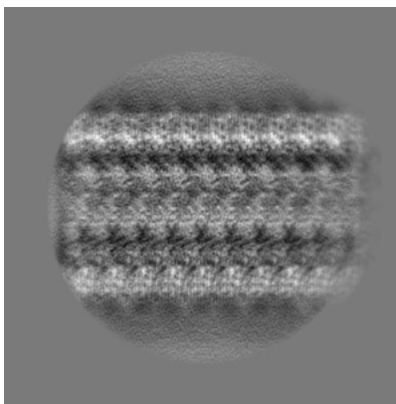

Y

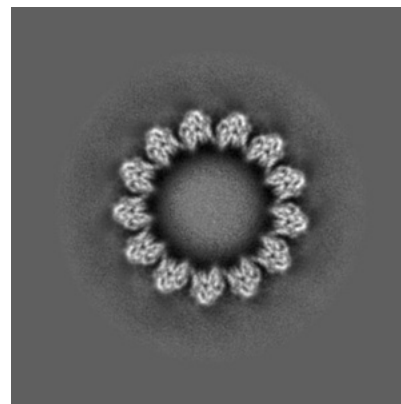

Z

#### 6.1.2 Raw map

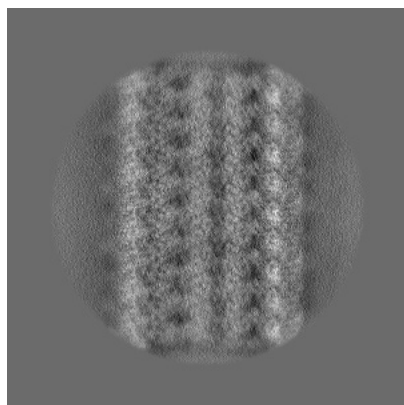

X

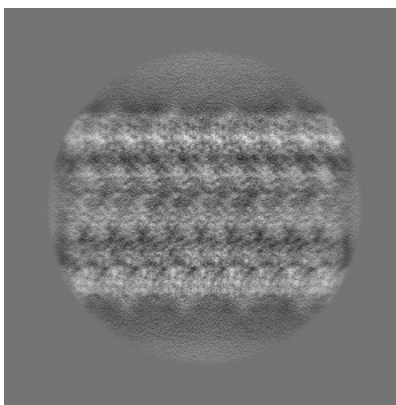

Y

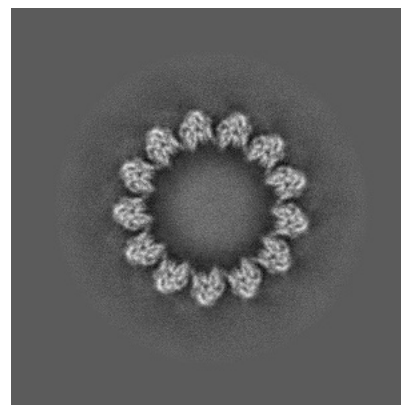

Z

The images above show the map projected in three orthogonal directions.

## 6.2 Central slices [i](#)

### 6.2.1 Primary map

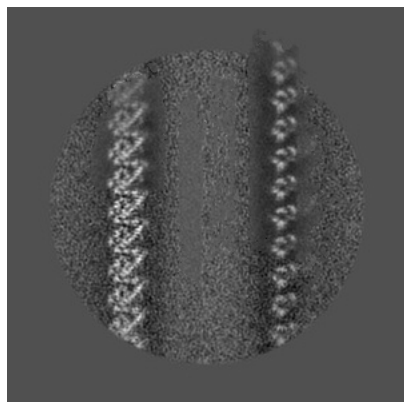

X Index: 256

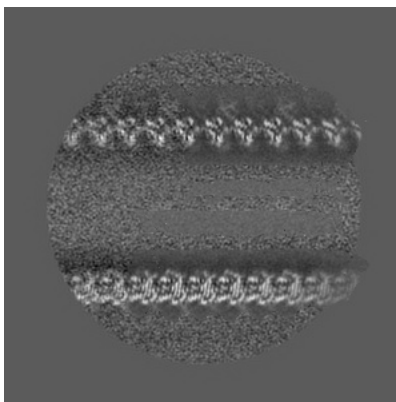

Y Index: 256

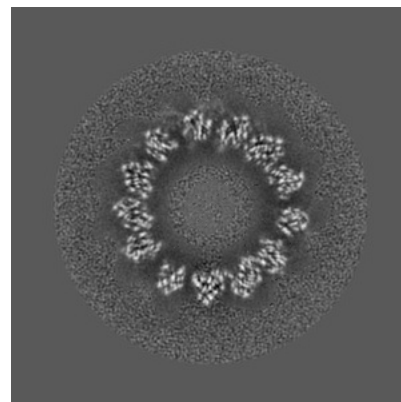

Z Index: 256

### 6.2.2 Raw map

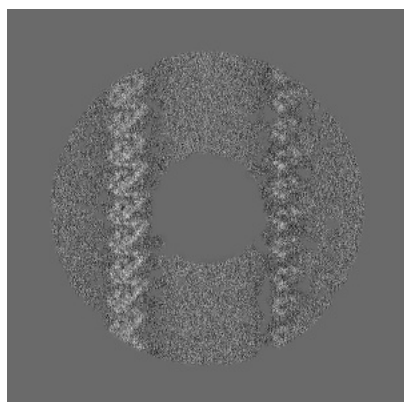

X Index: 256

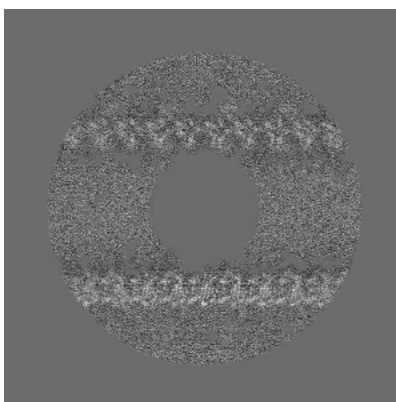

Y Index: 256

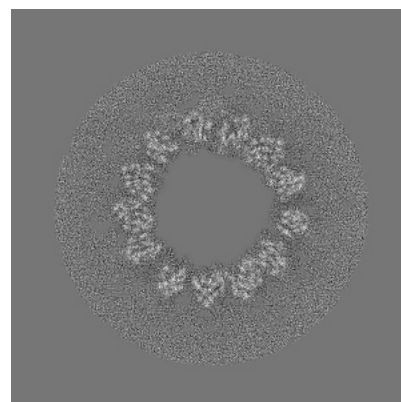

Z Index: 256

The images above show central slices of the map in three orthogonal directions.

## 6.3 Largest variance slices [i](#)

### 6.3.1 Primary map

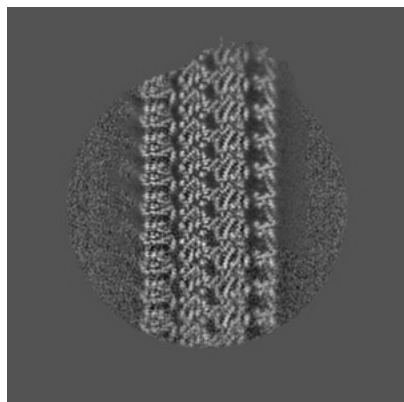

X Index: 346

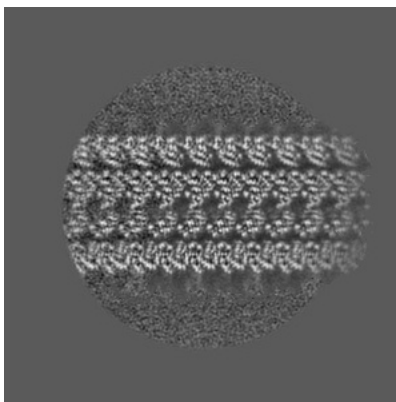

Y Index: 343

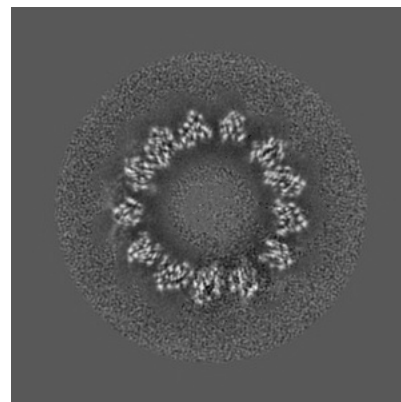

Z Index: 232

### 6.3.2 Raw map

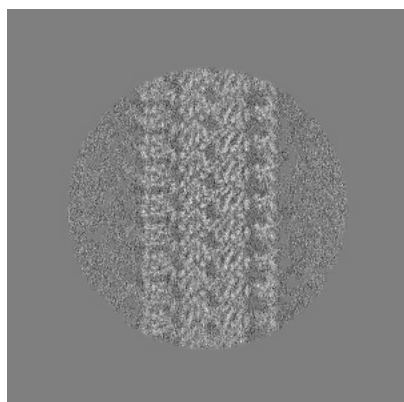

X Index: 346

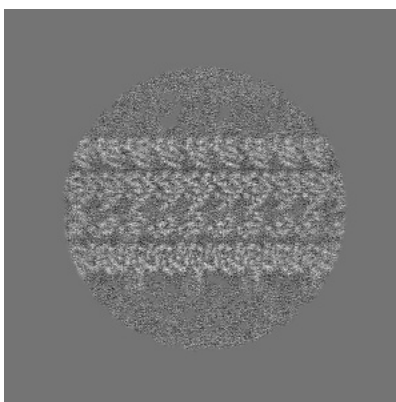

Y Index: 343

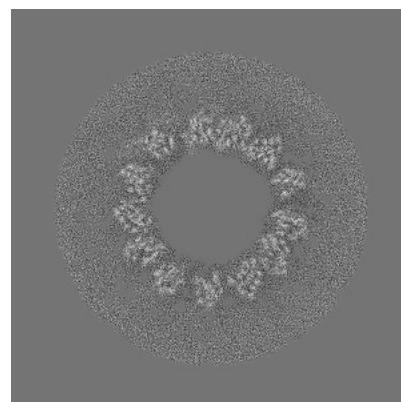

Z Index: 250

The images above show the largest variance slices of the map in three orthogonal directions.

## 6.4 Orthogonal standard-deviation projections (False-color) [i](#)

### 6.4.1 Primary map

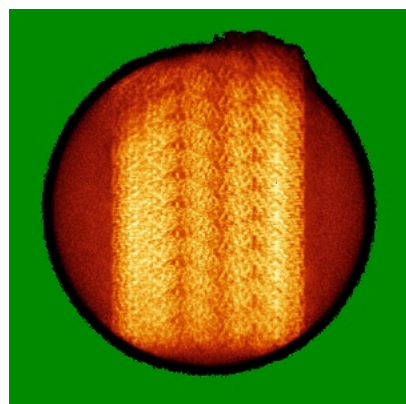

X

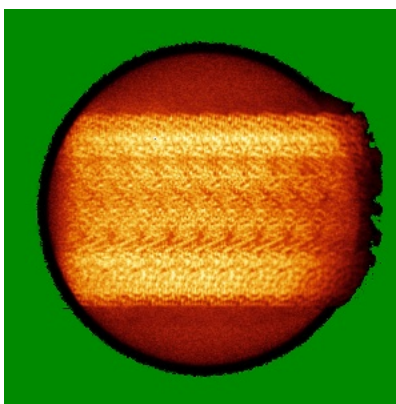

Y

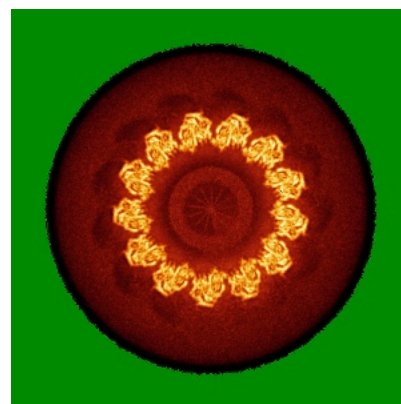

Z

### 6.4.2 Raw map

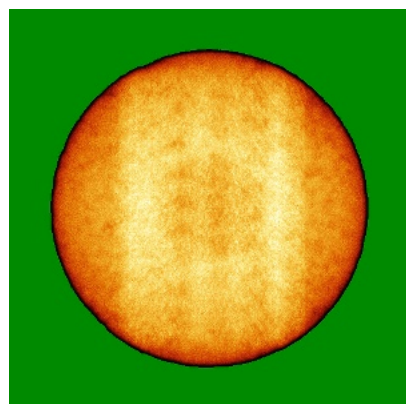

X

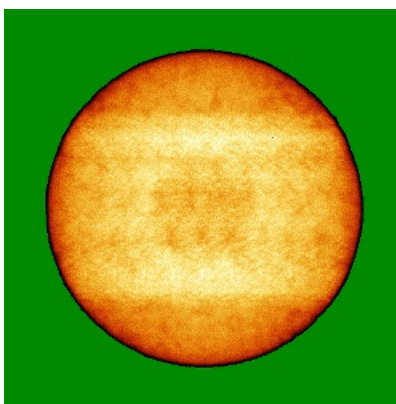

Y

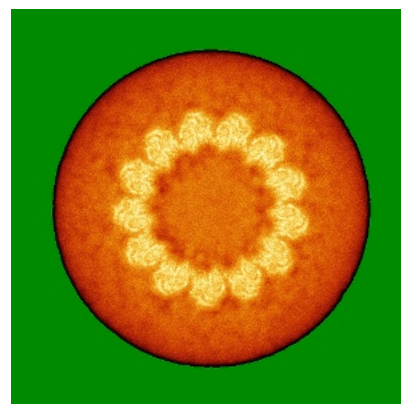

Z

The images above show the map standard deviation projections with false color in three orthogonal directions. Minimum values are shown in green, max in blue, and dark to light orange shades represent small to large values respectively.

## 6.5 Orthogonal surface views [i](#)

### 6.5.1 Primary map

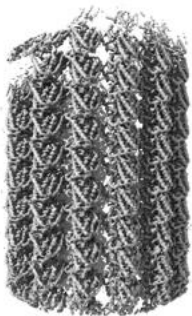

X

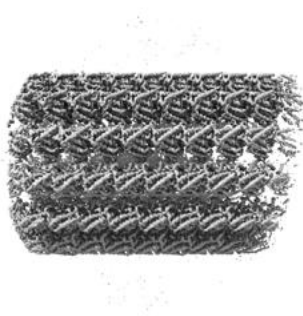

Y

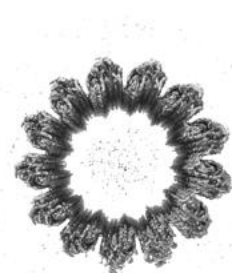

Z

The images above show the 3D surface view of the map at the recommended contour level 4.0. These images, in conjunction with the slice images, may facilitate assessment of whether an appropriate contour level has been provided.

### 6.5.2 Raw map

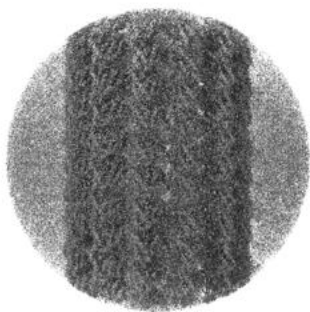

X

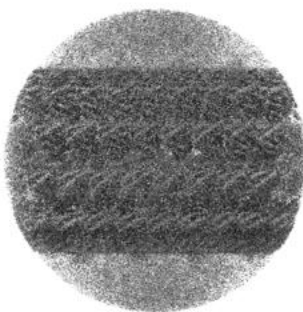

Y

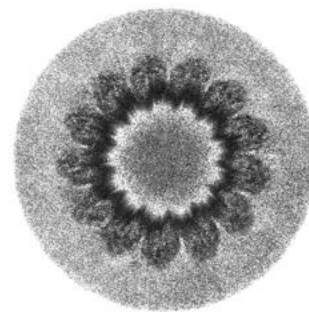

Z

These images show the 3D surface of the raw map. The raw map's contour level was selected so that its surface encloses the same volume as the primary map does at its recommended contour level.

## 6.6 Mask visualisation [i](#)

This section was not generated. No masks/segmentation were deposited.

## 7 Map analysis [i](#)

This section contains the results of statistical analysis of the map.

### 7.1 Map-value distribution [i](#)

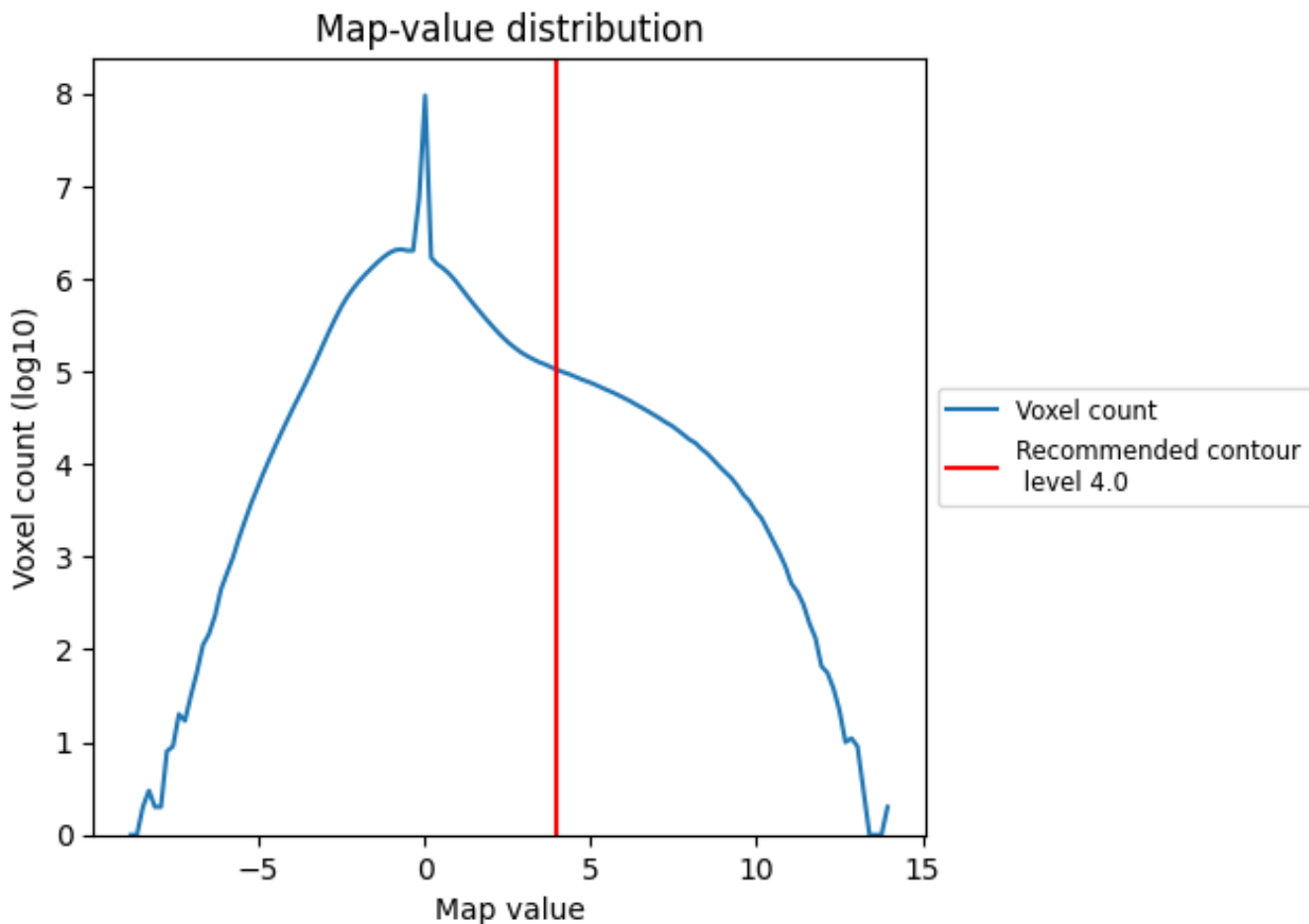

The map-value distribution is plotted in 128 intervals along the x-axis. The y-axis is logarithmic. A spike in this graph at zero usually indicates that the volume has been masked.

## 7.2 Volume estimate [\(i\)](#)

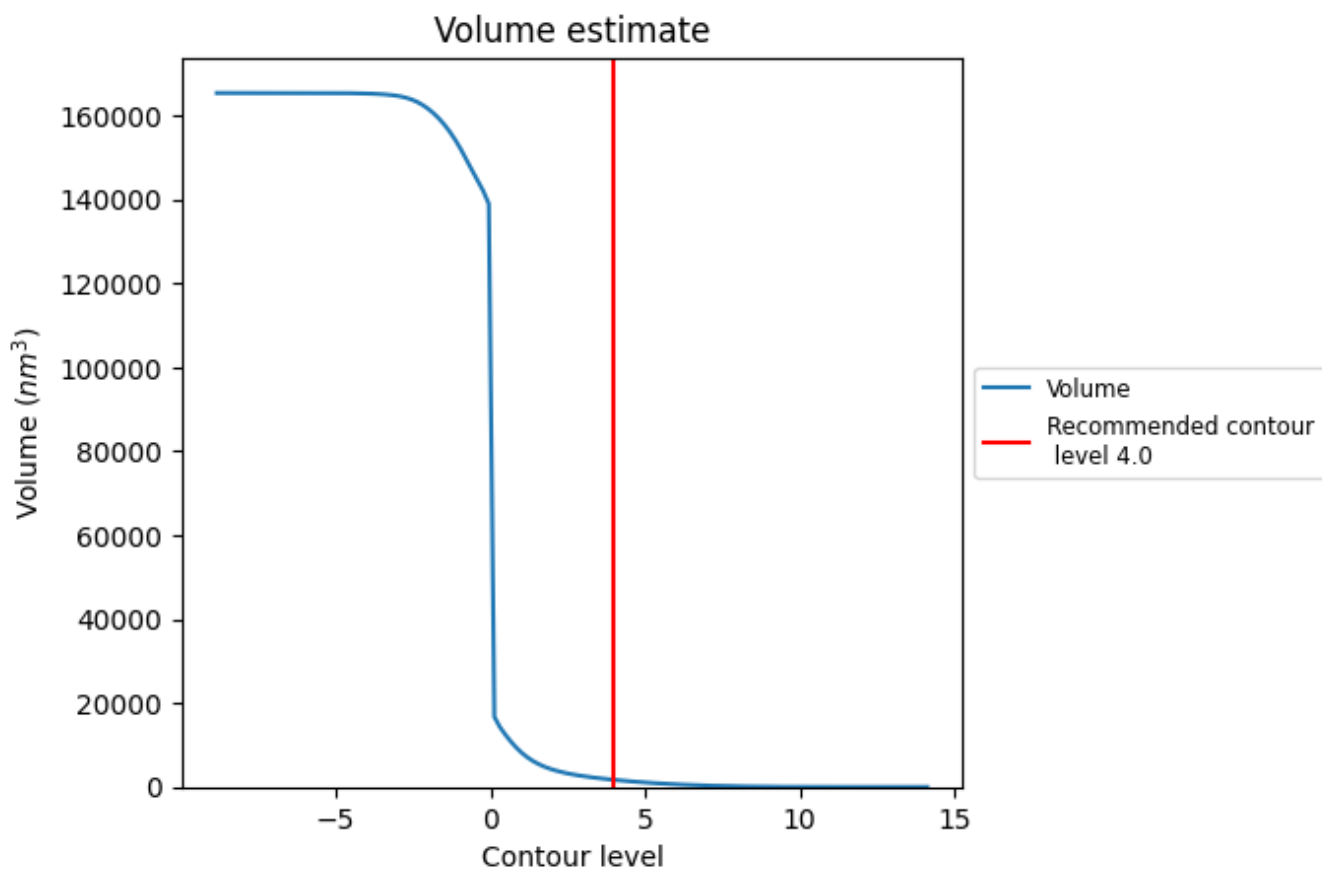

The volume at the recommended contour level is 1693  $\text{nm}^3$ ; this corresponds to an approximate mass of 1529 kDa.

The volume estimate graph shows how the enclosed volume varies with the contour level. The recommended contour level is shown as a vertical line and the intersection between the line and the curve gives the volume of the enclosed surface at the given level.

### 7.3 Rotationally averaged power spectrum i

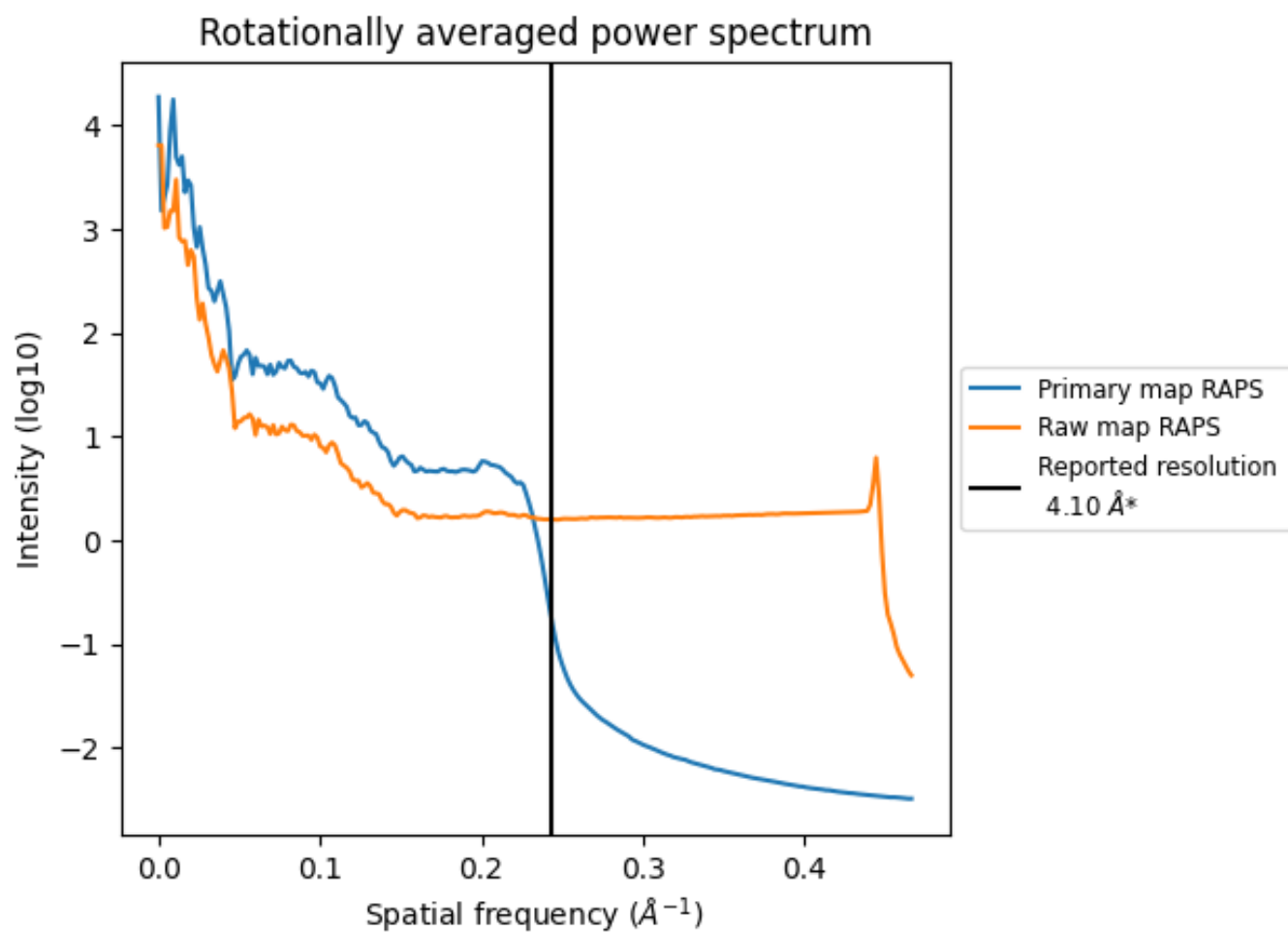

\*Reported resolution corresponds to spatial frequency of 0.244 Å<sup>-1</sup>



## 8 Fourier-Shell correlation [i](#)

Fourier-Shell Correlation (FSC) is the most commonly used method to estimate the resolution of single-particle and subtomogram-averaged maps. The shape of the curve depends on the imposed symmetry, mask and whether or not the two 3D reconstructions used were processed from a common reference. The reported resolution is shown as a black line. A curve is displayed for the half-bit criterion in addition to lines showing the 0.143 gold standard cut-off and 0.5 cut-off.

### 8.1 FSC [i](#)

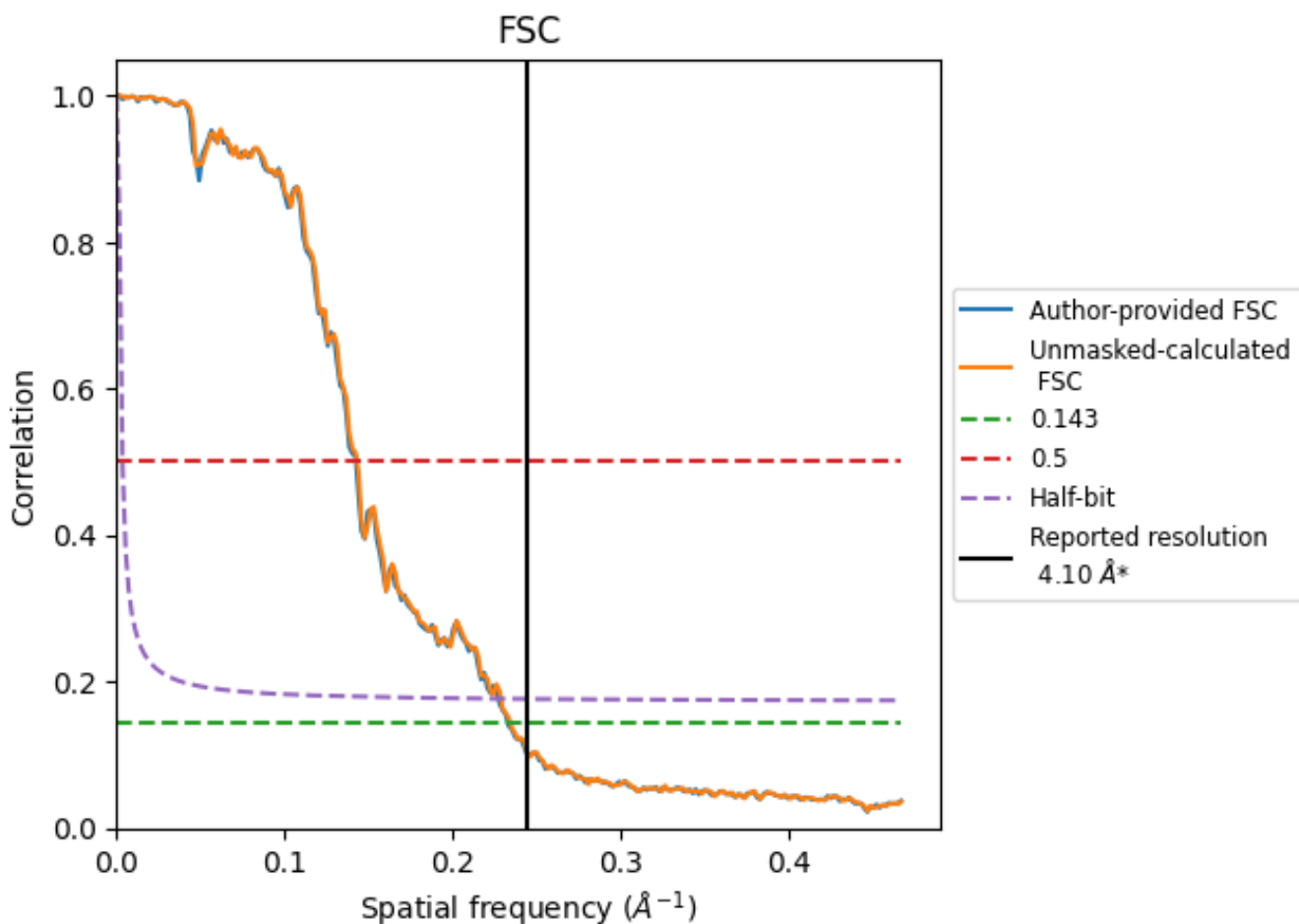

\*Reported resolution corresponds to spatial frequency of 0.244 Å<sup>-1</sup>

## 8.2 Resolution estimates [i](#)

Resolution estimate (Å)	Estimation criterion (FSC cut-off)		
	0.143	0.5	Half-bit
Reported by author	4.10	-	-
Author-provided FSC curve	4.29	7.01	4.39
Unmasked-calculated*	4.26	6.98	4.37

\*Resolution estimate based on FSC curve calculated by comparison of deposited half-maps.

## 9 Map-model fit [i](#)

This section contains information regarding the fit between EMDB map EMD-0615 and PDB model 6O2T. Per-residue inclusion information can be found in section 3 on page 22.

### 9.1 Map-model overlay [i](#)

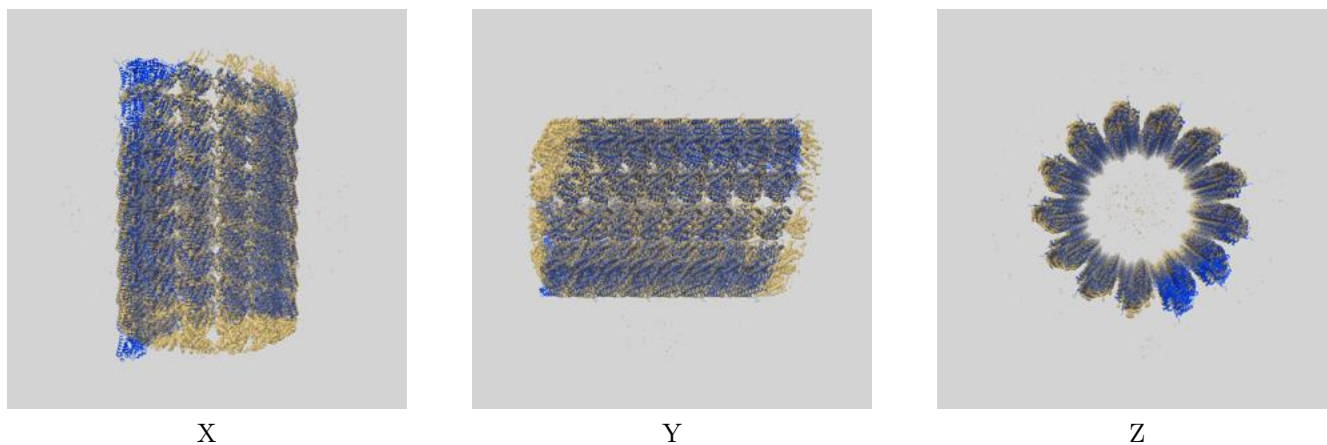

The images above show the 3D surface view of the map at the recommended contour level 4.0 at 50% transparency in yellow overlaid with a ribbon representation of the model coloured in blue. These images allow for the visual assessment of the quality of fit between the atomic model and the map.

## 9.2 Q-score mapped to coordinate model [i](#)

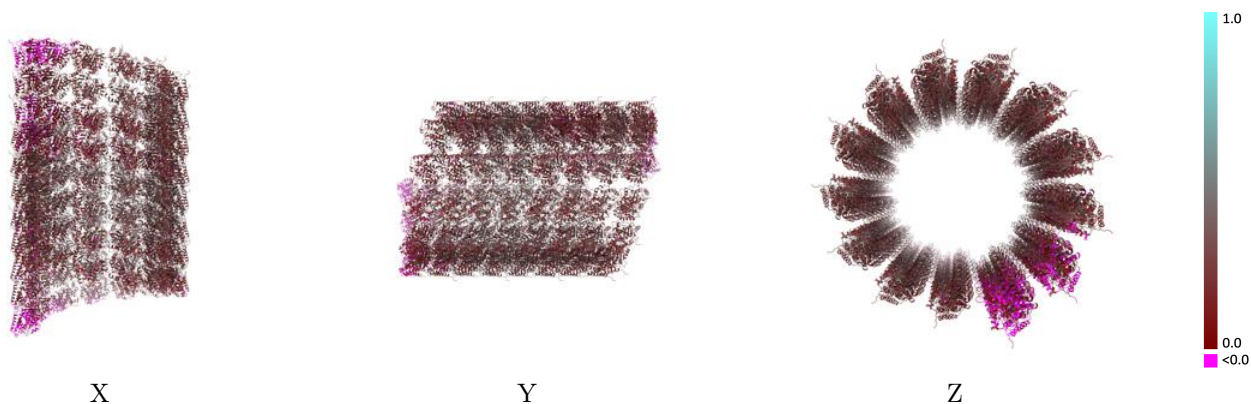

The images above show the model with each residue coloured according to its Q-score. This shows their resolvability in the map with higher Q-score values reflecting better resolvability. Please note: Q-score is calculating the resolvability of atoms, and thus high values are only expected at resolutions at which atoms can be resolved. Low Q-score values may therefore be expected for many entries.

## 9.3 Atom inclusion mapped to coordinate model [i](#)

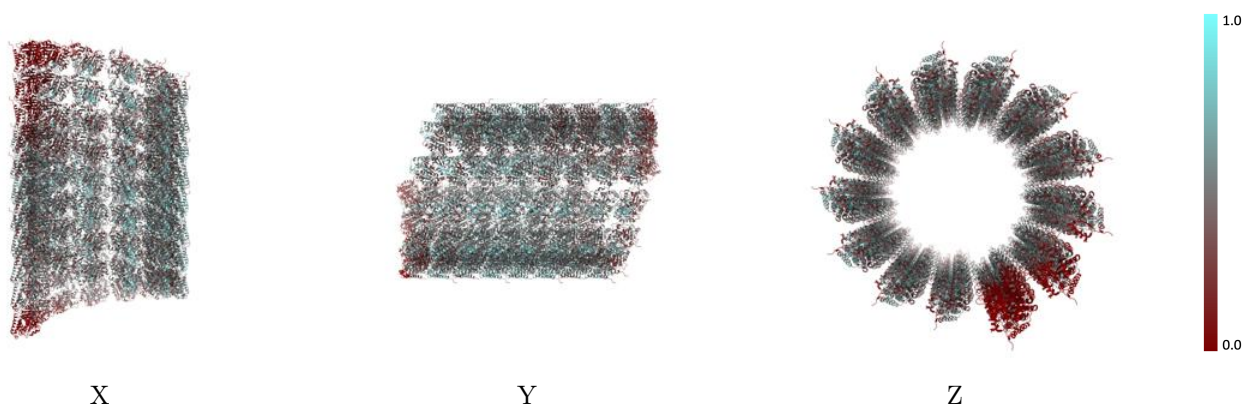

The images above show the model with each residue coloured according to its atom inclusion. This shows to what extent they are inside the map at the recommended contour level (4.0).



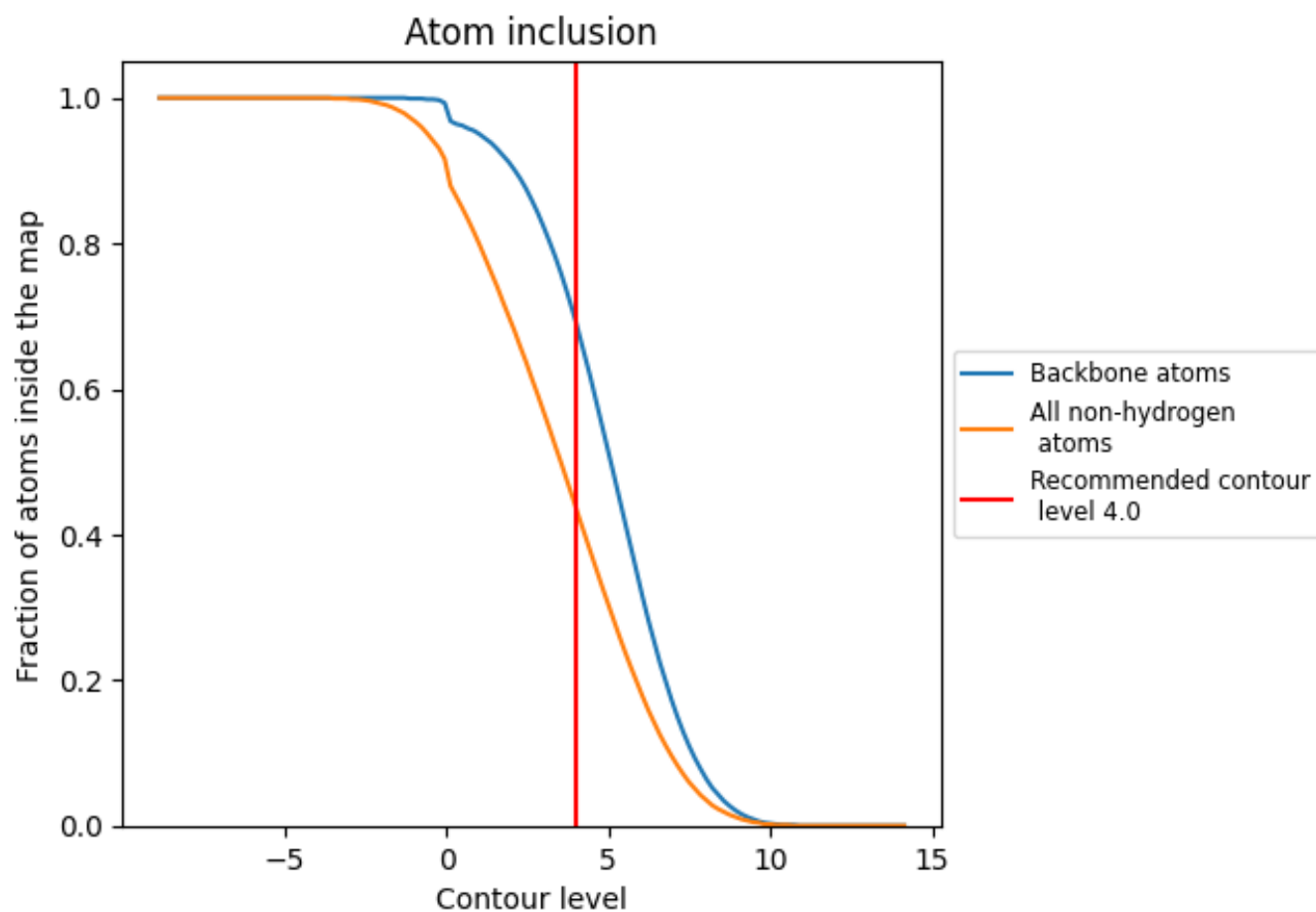



































































## 9.4 Atom inclusion [i](#)



At the recommended contour level, 69% of all backbone atoms, 44% of all non-hydrogen atoms, are inside the map.

## 9.5 Map-model fit summary

The table lists the average atom inclusion at the recommended contour level (4.0) and Q-score for the entire model and for each chain.

Chain	Atom inclusion	Q-score
All	 0.4370	 0.2520
1A	 0.5330	 0.3280
1B	 0.5300	 0.3240
1C	 0.5270	 0.3090
1D	 0.5080	 0.2960
1E	 0.4940	 0.2760
1F	 0.4850	 0.2680
1G	 0.4730	 0.2560
1H	 0.5500	 0.3230
1I	 0.4500	 0.2330
1J	 0.4390	 0.2160
1K	 0.4240	 0.2030
1L	 0.3840	 0.1670
1M	 0.0980	 0.0820
1N	 0.5380	 0.3080
1O	 0.5400	 0.3230
1P	 0.5400	 0.3190
1Q	 0.5310	 0.3080
1R	 0.5030	 0.2770
1S	 0.4870	 0.2560
1T	 0.4600	 0.2340
1U	 0.4460	 0.2200
1V	 0.4340	 0.2010
1W	 0.4110	 0.1800
1X	 0.3930	 0.1610
1Y	 0.2960	 0.0920
1Z	 0.5450	 0.2890
2A	 0.5160	 0.2910
2B	 0.5270	 0.3340
2C	 0.5390	 0.3360
2D	 0.5220	 0.3250
2E	 0.5300	 0.3340
2F	 0.5240	 0.3280
2G	 0.5230	 0.3270
2H	 0.4840	 0.2240



*Continued on next page...*

*Continued from previous page...*

Chain	Atom inclusion	Q-score
2I	0.5200	0.3190
2J	0.5090	0.3170
2K	0.5150	0.3160
2L	0.5150	0.3140
2M	0.4750	0.2600
2N	0.4560	0.2170
2O	0.5160	0.2870
2P	0.5230	0.3040
2Q	0.5020	0.2800
2R	0.5180	0.3030
2S	0.5200	0.3100
2T	0.5220	0.3180
2U	0.5220	0.3200
2V	0.5190	0.3170
2W	0.5000	0.2830
2X	0.5000	0.2970
2Y	0.4750	0.2530
2Z	0.4210	0.1820
3A	0.4260	0.2130
3B	0.4000	0.2530
3C	0.4380	0.2540
3D	0.4470	0.2550
3E	0.4760	0.2650
3F	0.4600	0.2550
3G	0.4720	0.2530
3H	0.1380	0.0620
3I	0.4590	0.2530
3J	0.4740	0.2550
3K	0.4650	0.2560
3L	0.4750	0.2600
3M	0.4580	0.2310
3N	0.3220	0.1580
3O	0.2000	0.1110
3P	0.2780	0.1480
3Q	0.3310	0.1770
3R	0.4000	0.2050
3S	0.4260	0.2250
3T	0.4380	0.2340
3U	0.4540	0.2530
3V	0.4780	0.2630
3W	0.4660	0.2660
3X	0.4490	0.2470

*Continued on next page...*

*Continued from previous page...*

Chain	Atom inclusion	Q-score
3Y	■ 0.4310	■ 0.2070
3Z	■ 0.0640	■ 0.0130
4A	■ 0.3910	■ 0.2670
4B	■ 0.4050	■ 0.2890
4C	■ 0.4030	■ 0.2790
4D	■ 0.3890	■ 0.2700
4E	■ 0.3900	■ 0.2670
4F	■ 0.3920	■ 0.2730
4G	■ 0.3990	■ 0.2810
4H	■ 0.4720	■ 0.2730
4I	■ 0.3870	■ 0.2670
4J	■ 0.3750	■ 0.2670
4K	■ 0.3380	■ 0.2440
4L	■ 0.1220	■ 0.0690
4M	■ 0.0250	■ 0.0010
4N	■ 0.3510	■ 0.2250
4O	■ 0.4730	■ 0.2770
4P	■ 0.4680	■ 0.2700
4Q	■ 0.4620	■ 0.2690
4R	■ 0.4640	■ 0.2760
4S	■ 0.4660	■ 0.2830
4T	■ 0.4740	■ 0.2930
4U	■ 0.4740	■ 0.2960
4V	■ 0.4740	■ 0.3020
4W	■ 0.4680	■ 0.2890
4X	■ 0.3510	■ 0.2370
4Y	■ 0.0540	■ 0.1630
4Z	■ 0.4550	■ 0.2530