



# Full wwPDB X-ray Structure Validation Report ⓘ

Jan 7, 2024 – 08:32 am GMT

PDB ID : 5OCH  
Title : The crystal structure of human ABCB8 in an outward-facing state  
Authors : Faust, B.; Pike, A.C.W.; Shintre, C.A.; Quiqley, A.M.; Chu, A.; Barr, A.; Shrestha, L.; Mukhopadhyay, S.; Borkowska, O.; Chalk, R.; Burgess-Brown, N.A.; Arrowsmith, C.H.; Edwards, A.M.; Bountra, C.; Carpenter, E.P.; Structural Genomics Consortium (SGC)  
Deposited on : 2017-06-30  
Resolution : 3.40 Å(reported)

This is a Full wwPDB X-ray Structure Validation Report for a publicly released PDB entry.

We welcome your comments at [validation@mail.wwpdb.org](mailto:validation@mail.wwpdb.org)

A user guide is available at

<https://www.wwpdb.org/validation/2017/XrayValidationReportHelp>

with specific help available everywhere you see the ⓘ symbol.

The types of validation reports are described at

<http://www.wwpdb.org/validation/2017/FAQs#types>.

---

The following versions of software and data (see [references](#) ①) were used in the production of this report:

MolProbity : 4.02b-467  
Mogul : 1.8.4, CSD as541be (2020)  
Xtrriage (Phenix) : 1.13  
EDS : 2.36  
buster-report : 1.1.7 (2018)  
Percentile statistics : 20191225.v01 (using entries in the PDB archive December 25th 2019)  
Refmac : 5.8.0158  
CCP4 : 7.0.044 (Gargrove)  
Ideal geometry (proteins) : Engh & Huber (2001)  
Ideal geometry (DNA, RNA) : Parkinson et al. (1996)  
Validation Pipeline (wwPDB-VP) : 2.36

# 1 Overall quality at a glance i

The following experimental techniques were used to determine the structure:

*X-RAY DIFFRACTION*

The reported resolution of this entry is 3.40 Å.

Percentile scores (ranging between 0-100) for global validation metrics of the entry are shown in the following graphic. The table shows the number of entries on which the scores are based.

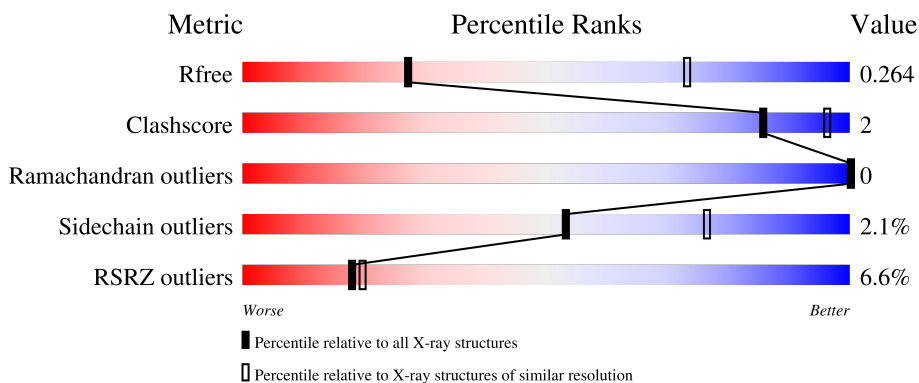



Metric	Whole archive (#Entries)	Similar resolution (#Entries, resolution range(Å))
$R_{free}$	130704	1026 (3.48-3.32)
Clashscore	141614	1055 (3.48-3.32)
Ramachandran outliers	138981	1038 (3.48-3.32)
Sidechain outliers	138945	1038 (3.48-3.32)
RSRZ outliers	127900	2173 (3.50-3.30)

The table below summarises the geometric issues observed across the polymeric chains and their fit to the electron density. The red, orange, yellow and green segments of the lower bar indicate the fraction of residues that contain outliers for  $\geq 3$ , 2, 1 and 0 types of geometric quality criteria respectively. A grey segment represents the fraction of residues that are not modelled. The numeric value for each fraction is indicated below the corresponding segment, with a dot representing fractions  $\leq 5\%$ . The upper red bar (where present) indicates the fraction of residues that have poor fit to the electron density. The numeric value is given above the bar.

Mol	Chain	Length	Quality of chain
1	A	612	 3% 83% 7% 10%
1	C	612	 10% 84% 12%
1	D	612	 5% 88% 6% 6%
2	B	612	 3% 88% 6% 6%
3	E	612	 12% 89% 5% 6%

*Continued on next page...*

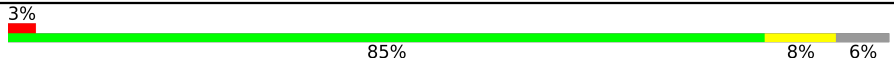
*Continued from previous page...*

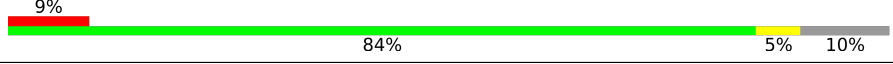
Mol	Chain	Length	Quality of chain
4	F	612	
4	G	612	
5	H	612	

## 2 Entry composition i

There are 8 unique types of molecules in this entry. The entry contains 31278 atoms, of which 0 are hydrogens and 0 are deuteriums.

In the tables below, the ZeroOcc column contains the number of atoms modelled with zero occupancy, the AltConf column contains the number of residues with at least one atom in alternate conformation and the Trace column contains the number of residues modelled with at most 2 atoms.

- Molecule 1 is a protein called ATP-binding cassette sub-family B member 8, mitochondrial.

Mol	Chain	Residues	Atoms					ZeroOcc	AltConf	Trace
			Total	C	N	O	S			
1	A	552	Total 3910	C 2479	N 676	O 733	S 22	0	0	0
1	C	537	Total 3541	C 2229	N 626	O 670	S 16	0	0	0
1	D	573	Total 3937	C 2502	N 682	O 731	S 22	0	0	0

There are 24 discrepancies between the modelled and reference sequences:

Chain	Residue	Modelled	Actual	Comment	Reference
A	110	MET	-	initiating methionine	UNP Q9NUT2
A	715	ALA	-	expression tag	UNP Q9NUT2
A	716	GLU	-	expression tag	UNP Q9NUT2
A	717	ASN	-	expression tag	UNP Q9NUT2
A	718	LEU	-	expression tag	UNP Q9NUT2
A	719	TYR	-	expression tag	UNP Q9NUT2
A	720	PHE	-	expression tag	UNP Q9NUT2
A	721	GLN	-	expression tag	UNP Q9NUT2
C	110	MET	-	initiating methionine	UNP Q9NUT2
C	715	ALA	-	expression tag	UNP Q9NUT2
C	716	GLU	-	expression tag	UNP Q9NUT2
C	717	ASN	-	expression tag	UNP Q9NUT2
C	718	LEU	-	expression tag	UNP Q9NUT2
C	719	TYR	-	expression tag	UNP Q9NUT2
C	720	PHE	-	expression tag	UNP Q9NUT2
C	721	GLN	-	expression tag	UNP Q9NUT2
D	110	MET	-	initiating methionine	UNP Q9NUT2
D	715	ALA	-	expression tag	UNP Q9NUT2
D	716	GLU	-	expression tag	UNP Q9NUT2
D	717	ASN	-	expression tag	UNP Q9NUT2
D	718	LEU	-	expression tag	UNP Q9NUT2
D	719	TYR	-	expression tag	UNP Q9NUT2
D	720	PHE	-	expression tag	UNP Q9NUT2

*Continued on next page...*

*Continued from previous page...*

Chain	Residue	Modelled	Actual	Comment	Reference
D	721	GLN	-	expression tag	UNP Q9NUT2

- Molecule 2 is a protein called ATP-binding cassette sub-family B member 8, mitochondrial.

Mol	Chain	Residues	Atoms					ZeroOcc	AltConf	Trace
			Total	C	N	O	S			
2	B	573	4051	2562	715	753	21	0	0	0

There are 8 discrepancies between the modelled and reference sequences:

Chain	Residue	Modelled	Actual	Comment	Reference
B	110	MET	-	initiating methionine	UNP Q9NUT2
B	715	ALA	-	expression tag	UNP Q9NUT2
B	716	GLU	-	expression tag	UNP Q9NUT2
B	717	ASN	-	expression tag	UNP Q9NUT2
B	718	LEU	-	expression tag	UNP Q9NUT2
B	719	TYR	-	expression tag	UNP Q9NUT2
B	720	PHE	-	expression tag	UNP Q9NUT2
B	721	GLN	-	expression tag	UNP Q9NUT2

- Molecule 3 is a protein called ATP-binding cassette sub-family B member 8, mitochondrial.

Mol	Chain	Residues	Atoms					ZeroOcc	AltConf	Trace
			Total	C	N	O	S			
3	E	576	3947	2495	697	734	21	0	0	0

There are 8 discrepancies between the modelled and reference sequences:

Chain	Residue	Modelled	Actual	Comment	Reference
E	110	MET	-	initiating methionine	UNP Q9NUT2
E	715	ALA	-	expression tag	UNP Q9NUT2
E	716	GLU	-	expression tag	UNP Q9NUT2
E	717	ASN	-	expression tag	UNP Q9NUT2
E	718	LEU	-	expression tag	UNP Q9NUT2
E	719	TYR	-	expression tag	UNP Q9NUT2
E	720	PHE	-	expression tag	UNP Q9NUT2
E	721	GLN	-	expression tag	UNP Q9NUT2

- Molecule 4 is a protein called ATP-binding cassette sub-family B member 8, mitochondrial.

Mol	Chain	Residues	Atoms					ZeroOcc	AltConf	Trace
			Total	C	N	O	S			
4	F	573	4047	2567	700	756	24	0	0	0
4	G	552	3812	2409	663	720	20	0	0	0

There are 16 discrepancies between the modelled and reference sequences:

Chain	Residue	Modelled	Actual	Comment	Reference
F	110	MET	-	initiating methionine	UNP Q9NUT2
F	715	ALA	-	expression tag	UNP Q9NUT2
F	716	GLU	-	expression tag	UNP Q9NUT2
F	717	ASN	-	expression tag	UNP Q9NUT2
F	718	LEU	-	expression tag	UNP Q9NUT2
F	719	TYR	-	expression tag	UNP Q9NUT2
F	720	PHE	-	expression tag	UNP Q9NUT2
F	721	GLN	-	expression tag	UNP Q9NUT2
G	110	MET	-	initiating methionine	UNP Q9NUT2
G	715	ALA	-	expression tag	UNP Q9NUT2
G	716	GLU	-	expression tag	UNP Q9NUT2
G	717	ASN	-	expression tag	UNP Q9NUT2
G	718	LEU	-	expression tag	UNP Q9NUT2
G	719	TYR	-	expression tag	UNP Q9NUT2
G	720	PHE	-	expression tag	UNP Q9NUT2
G	721	GLN	-	expression tag	UNP Q9NUT2

- Molecule 5 is a protein called ATP-binding cassette sub-family B member 8, mitochondrial.

Mol	Chain	Residues	Atoms					ZeroOcc	AltConf	Trace
			Total	C	N	O	S			
5	H	548	3606	2255	639	691	21	0	0	0

There are 8 discrepancies between the modelled and reference sequences:

Chain	Residue	Modelled	Actual	Comment	Reference
H	110	MET	-	initiating methionine	UNP Q9NUT2
H	715	ALA	-	expression tag	UNP Q9NUT2
H	716	GLU	-	expression tag	UNP Q9NUT2
H	717	ASN	-	expression tag	UNP Q9NUT2
H	718	LEU	-	expression tag	UNP Q9NUT2
H	719	TYR	-	expression tag	UNP Q9NUT2
H	720	PHE	-	expression tag	UNP Q9NUT2
H	721	GLN	-	expression tag	UNP Q9NUT2

- Molecule 6 is ADENOSINE-5'-DIPHOSPHATE (three-letter code: ADP) (formula:  $C_{10}H_{15}N_5O_{10}P_2$ ).

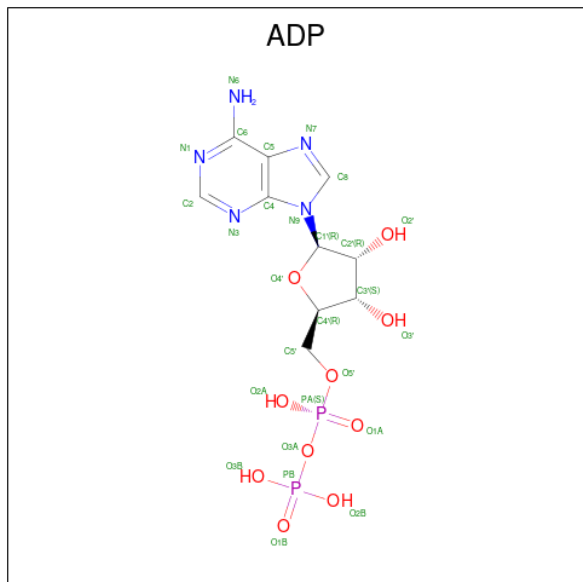

Mol	Chain	Residues	Atoms					ZeroOcc	AltConf
			Total	C	N	O	P		
6	A	1	Total	C	N	O	P	0	0
			27	10	5	10	2		
6	B	1	Total	C	N	O	P	0	0
			27	10	5	10	2		
6	C	1	Total	C	N	O	P	0	0
			27	10	5	10	2		
6	D	1	Total	C	N	O	P	0	0
			27	10	5	10	2		
6	E	1	Total	C	N	O	P	0	0
			27	10	5	10	2		
6	F	1	Total	C	N	O	P	0	0
			27	10	5	10	2		
6	G	1	Total	C	N	O	P	0	0
			27	10	5	10	2		
6	H	1	Total	C	N	O	P	0	0
			27	10	5	10	2		

- Molecule 7 is MAGNESIUM ION (three-letter code: MG) (formula: Mg).

Mol	Chain	Residues	Atoms		ZeroOcc	AltConf
			Total	Mg		
7	A	1	Total	Mg	0	0
			1	1		
7	B	1	Total	Mg	0	0
			1	1		

*Continued on next page...*



Continued from previous page...

Mol	Chain	Residues	Atoms	ZeroOcc	AltConf
7	C	1	Total Mg 1 1	0	0
7	D	1	Total Mg 1 1	0	0
7	E	1	Total Mg 1 1	0	0
7	F	1	Total Mg 1 1	0	0
7	G	1	Total Mg 1 1	0	0
7	H	1	Total Mg 1 1	0	0

- Molecule 8 is CHOLESTEROL HEMISUCCINATE (three-letter code: Y01) (formula:  $C_{31}H_{50}O_4$ ).

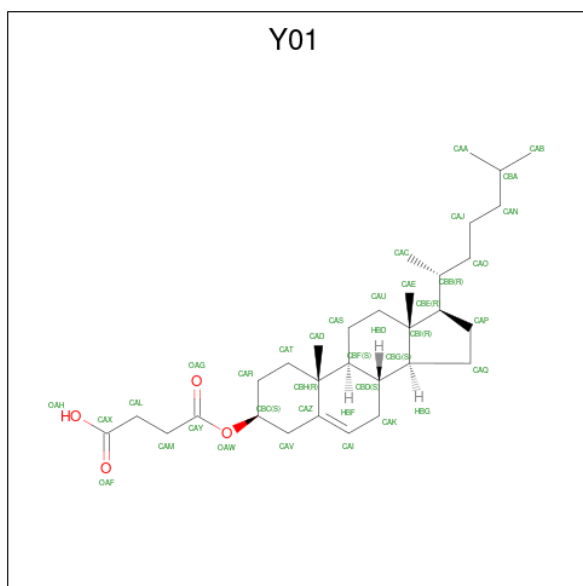

Mol	Chain	Residues	Atoms	ZeroOcc	AltConf
8	A	1	Total C O 30 26 4	0	0
8	B	1	Total C O 35 31 4	0	0
8	D	1	Total C O 26 24 2	0	0
8	E	1	Total C O 28 24 4	0	0
8	F	1	Total C O 35 31 4	0	0

Continued on next page...

*Continued from previous page...*

Mol	Chain	Residues	Atoms			ZeroOcc	AltConf
8	G	1	Total	C	O	0	0
			21	20	1		
8	H	1	Total	C	O	0	0
			28	24	4		

### 3 Residue-property plots i

These plots are drawn for all protein, RNA, DNA and oligosaccharide chains in the entry. The first graphic for a chain summarises the proportions of the various outlier classes displayed in the second graphic. The second graphic shows the sequence view annotated by issues in geometry and electron density. Residues are color-coded according to the number of geometric quality criteria for which they contain at least one outlier: green = 0, yellow = 1, orange = 2 and red = 3 or more. A red dot above a residue indicates a poor fit to the electron density ( $RSRZ > 2$ ). Stretches of 2 or more consecutive residues without any outlier are shown as a green connector. Residues present in the sample, but not in the model, are shown in grey.

- Molecule 1: ATP-binding cassette sub-family B member 8, mitochondrial

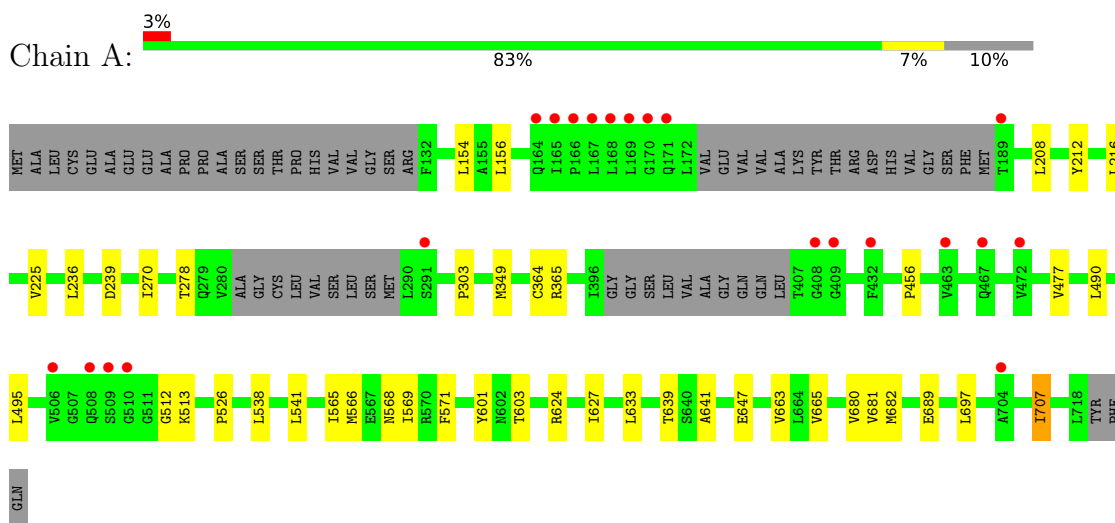

- Molecule 1: ATP-binding cassette sub-family B member 8, mitochondrial

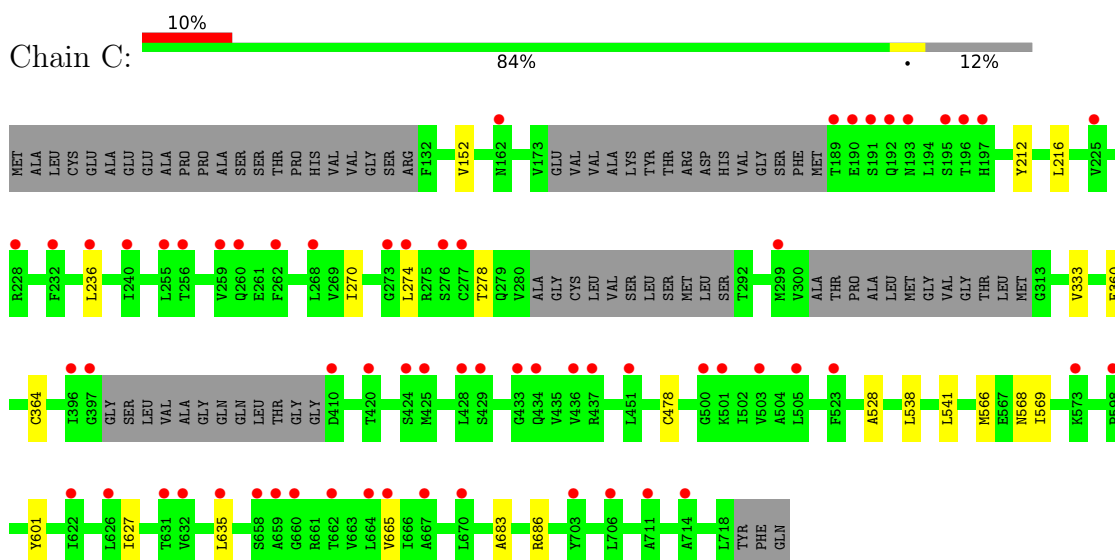

- Molecule 1: ATP-binding cassette sub-family B member 8, mitochondrial

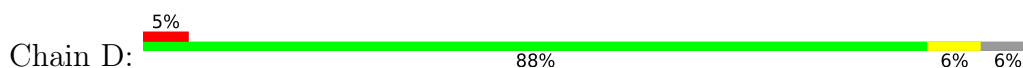

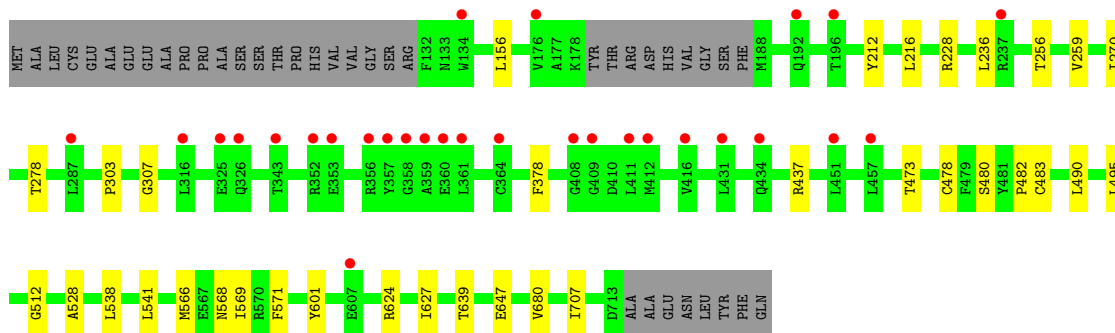

• Molecule 2: ATP-binding cassette sub-family B member 8, mitochondrial

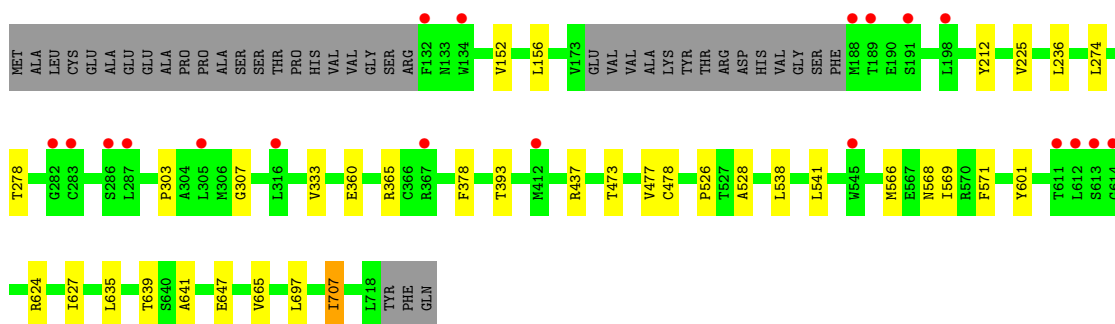
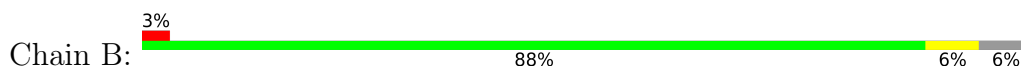

• Molecule 3: ATP-binding cassette sub-family B member 8, mitochondrial

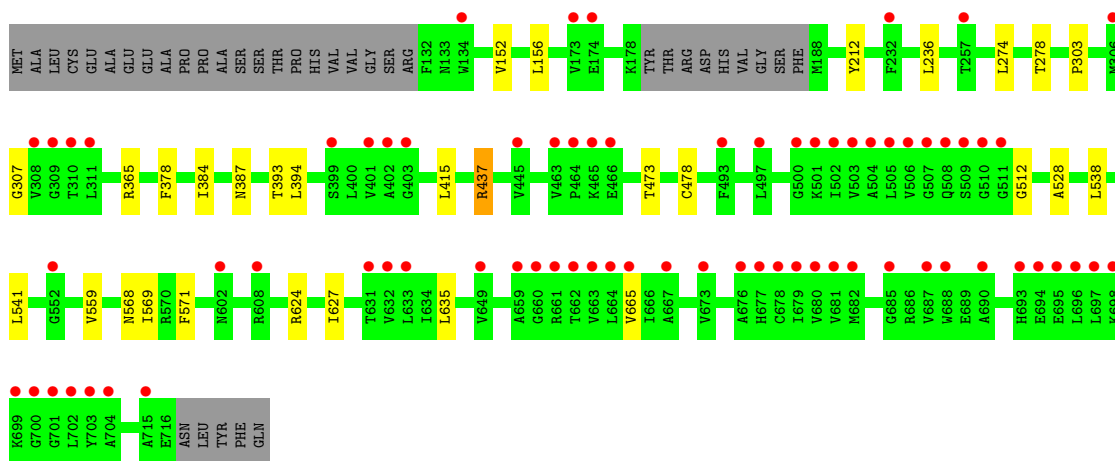
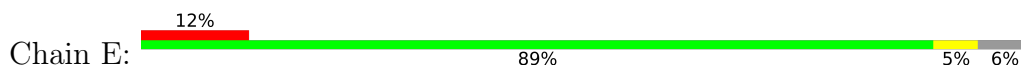

• Molecule 4: ATP-binding cassette sub-family B member 8, mitochondrial

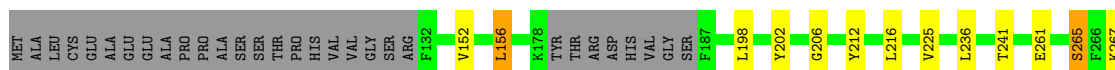
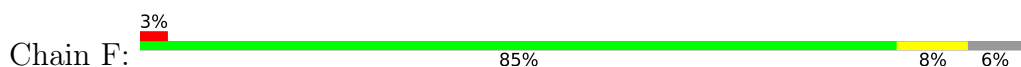

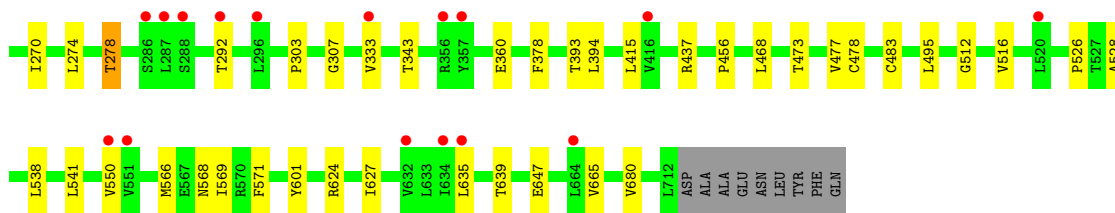

- Molecule 4: ATP-binding cassette sub-family B member 8, mitochondrial

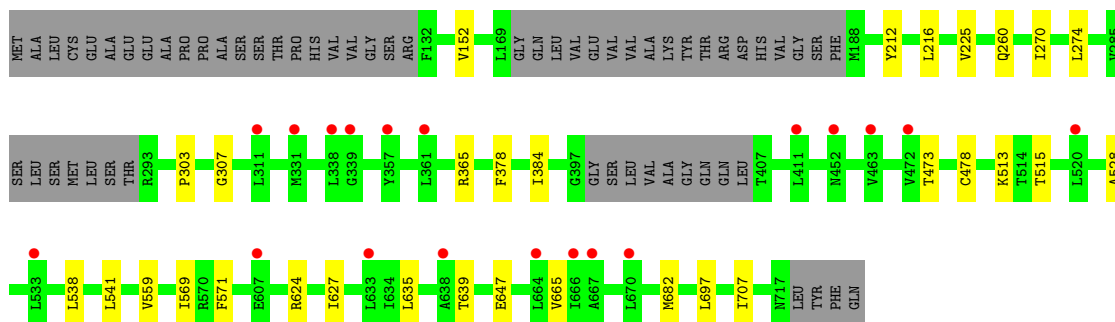
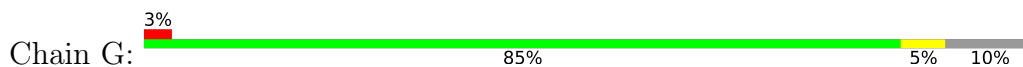

- Molecule 5: ATP-binding cassette sub-family B member 8, mitochondrial

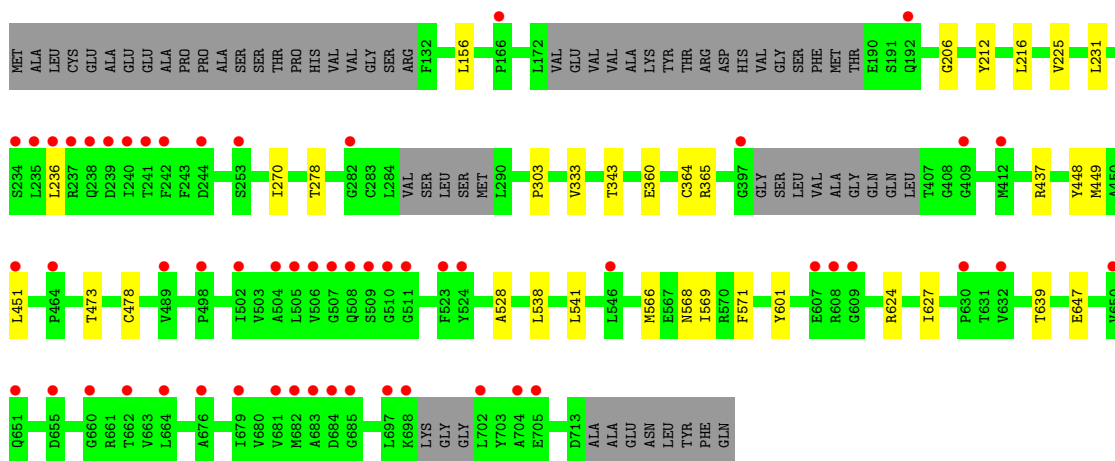
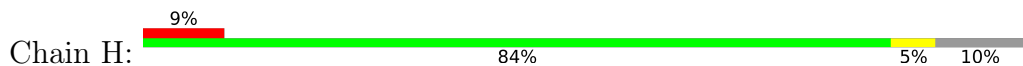

## 4 Data and refinement statistics i

Property	Value	Source
Space group	P 1 21 1	Depositor
Cell constants a, b, c, $\alpha$ , $\beta$ , $\gamma$	181.08Å 98.50Å 214.87Å 90.00° 90.50° 90.00°	Depositor
Resolution (Å)	72.61 – 3.40 72.60 – 3.40	Depositor EDS
% Data completeness (in resolution range)	61.9 (72.61-3.40) 60.6 (72.60-3.40)	Depositor EDS
$R_{merge}$	0.22	Depositor
$R_{sym}$	(Not available)	Depositor
$\langle I/\sigma(I) \rangle$ <sup>1</sup>	1.70 (at 3.41Å)	Xtrriage
Refinement program	BUSTER 2.10.2	Depositor
R, $R_{free}$	0.231 , 0.251 0.249 , 0.264	Depositor DCC
$R_{free}$ test set	3147 reflections (4.85%)	wwPDB-VP
Wilson B-factor (Å <sup>2</sup> )	107.9	Xtrriage
Anisotropy	0.150	Xtrriage
Bulk solvent $k_{sol}$ (e/Å <sup>3</sup> ), $B_{sol}$ (Å <sup>2</sup> )	0.27 , 98.9	EDS
L-test for twinning <sup>2</sup>	$\langle  L  \rangle = 0.41$ , $\langle L^2 \rangle = 0.24$	Xtrriage
Estimated twinning fraction	0.104 for h,-k,-l	Xtrriage
$F_o, F_c$ correlation	0.87	EDS
Total number of atoms	31278	wwPDB-VP
Average B, all atoms (Å <sup>2</sup> )	137.0	wwPDB-VP

Xtrriage's analysis on translational NCS is as follows: *The largest off-origin peak in the Patterson function is 5.58% of the height of the origin peak. No significant pseudotranslation is detected.*

<sup>1</sup>Intensities estimated from amplitudes.

<sup>2</sup>Theoretical values of  $\langle |L| \rangle$ ,  $\langle L^2 \rangle$  for acentric reflections are 0.5, 0.333 respectively for untwinned datasets, and 0.375, 0.2 for perfectly twinned datasets.

## 5 Model quality [i](#)

### 5.1 Standard geometry [i](#)

Bond lengths and bond angles in the following residue types are not validated in this section: YCM, MG, Y01, ADP

The Z score for a bond length (or angle) is the number of standard deviations the observed value is removed from the expected value. A bond length (or angle) with  $|Z| > 5$  is considered an outlier worth inspection. RMSZ is the root-mean-square of all Z scores of the bond lengths (or angles).

Mol	Chain	Bond lengths		Bond angles	
		RMSZ	# Z  >5	RMSZ	# Z  >5
1	A	0.40	0/3960	0.55	0/5387
1	C	0.40	0/3577	0.54	0/4893
1	D	0.40	0/3988	0.55	0/5443
2	B	0.39	0/4091	0.54	0/5565
3	E	0.41	0/3983	0.55	0/5429
4	F	0.40	0/4086	0.55	0/5561
4	G	0.40	0/3847	0.55	0/5243
5	H	0.40	0/3654	0.54	0/4986
All	All	0.40	0/31186	0.55	0/42507

There are no bond length outliers.

There are no bond angle outliers.

There are no chirality outliers.

There are no planarity outliers.

### 5.2 Too-close contacts [i](#)

In the following table, the Non-H and H(model) columns list the number of non-hydrogen atoms and hydrogen atoms in the chain respectively. The H(added) column lists the number of hydrogen atoms added and optimized by MolProbity. The Clashes column lists the number of clashes within the asymmetric unit, whereas Symm-Clashes lists symmetry-related clashes.

Mol	Chain	Non-H	H(model)	H(added)	Clashes	Symm-Clashes
1	A	3910	0	3649	23	0
1	C	3541	0	3039	9	0
1	D	3937	0	3601	15	0
2	B	4051	0	3806	19	0
3	E	3947	0	3630	18	0

*Continued on next page...*

Continued from previous page...

Mol	Chain	Non-H	H(model)	H(added)	Clashes	Symm-Clashes
4	F	4047	0	3827	27	0
4	G	3812	0	3478	17	0
5	H	3606	0	3072	16	0
6	A	27	0	12	1	0
6	B	27	0	12	0	0
6	C	27	0	12	0	0
6	D	27	0	12	1	0
6	E	27	0	12	1	0
6	F	27	0	12	1	0
6	G	27	0	12	0	0
6	H	27	0	12	0	0
7	A	1	0	0	0	0
7	B	1	0	0	0	0
7	C	1	0	0	0	0
7	D	1	0	0	0	0
7	E	1	0	0	0	0
7	F	1	0	0	0	0
7	G	1	0	0	0	0
7	H	1	0	0	0	0
8	A	30	0	36	1	0
8	B	35	0	49	1	0
8	D	26	0	32	1	0
8	E	28	0	32	1	0
8	F	35	0	49	1	0
8	G	21	0	28	1	0
8	H	28	0	32	1	0
All	All	31278	0	28456	131	0

The all-atom clashscore is defined as the number of clashes found per 1000 atoms (including hydrogen atoms). The all-atom clashscore for this structure is 2.

All (131) close contacts within the same asymmetric unit are listed below, sorted by their clash magnitude.

Atom-1	Atom-2	Interatomic distance (Å)	Clash overlap (Å)
1:A:569:ILE:HG22	1:A:627:ILE:HD11	1.77	0.67
1:D:569:ILE:HG22	1:D:627:ILE:HD11	1.75	0.67
3:E:569:ILE:HG22	3:E:627:ILE:HD11	1.78	0.65
5:H:569:ILE:HG22	5:H:627:ILE:HD11	1.79	0.65
2:B:569:ILE:HG22	2:B:627:ILE:HD11	1.78	0.65
4:F:569:ILE:HG22	4:F:627:ILE:HD11	1.78	0.64
1:C:569:ILE:HG22	1:C:627:ILE:HD11	1.80	0.63

Continued on next page...



*Continued from previous page...*

Atom-1	Atom-2	Interatomic distance (Å)	Clash overlap (Å)
4:G:569:ILE:HG22	4:G:627:ILE:HD11	1.83	0.61
4:F:241:THR:HA	4:F:483:YCM:NZ2	2.21	0.56
5:H:448:TYR:HA	5:H:451:LEU:HD12	1.88	0.55
4:F:394:LEU:HD13	4:F:415:LEU:HD21	1.88	0.54
4:F:566:MET:HB2	4:F:601:TYR:HB3	1.88	0.54
5:H:538:LEU:HA	5:H:541:LEU:HD12	1.90	0.54
1:D:639:THR:HB	1:D:647:GLU:HG3	1.89	0.54
4:F:639:THR:HB	4:F:647:GLU:HG3	1.89	0.54
1:C:566:MET:HB2	1:C:601:TYR:HB3	1.89	0.53
2:B:566:MET:HB2	2:B:601:TYR:HB3	1.89	0.53
5:H:639:THR:HB	5:H:647:GLU:HG3	1.90	0.53
1:A:639:THR:HB	1:A:647:GLU:HG3	1.91	0.53
1:A:566:MET:HB2	1:A:601:TYR:HB3	1.89	0.53
2:B:639:THR:HB	2:B:647:GLU:HG3	1.91	0.53
1:D:538:LEU:HA	1:D:541:LEU:HD12	1.91	0.53
5:H:566:MET:HB2	5:H:601:TYR:HB3	1.89	0.53
1:A:697:LEU:HD21	1:A:707:ILE:HG21	1.92	0.52
4:G:639:THR:HB	4:G:647:GLU:HG3	1.90	0.52
3:E:437:ARG:HH22	4:F:267:LYS:HZ3	1.56	0.52
1:D:216:LEU:HD21	1:D:270:ILE:HB	1.92	0.52
2:B:333:VAL:HG21	2:B:360:GLU:HG3	1.92	0.52
1:A:513:LYS:HG2	1:A:682:MET:HE3	1.92	0.51
1:C:333:VAL:HG21	1:C:360:GLU:HG3	1.93	0.51
4:G:513:LYS:HG2	4:G:682:MET:HE3	1.93	0.50
5:H:333:VAL:HG21	5:H:360:GLU:HG3	1.92	0.50
4:F:333:VAL:HG21	4:F:360:GLU:HG3	1.93	0.50
2:B:538:LEU:HA	2:B:541:LEU:HD12	1.93	0.50
4:G:384:ILE:HD11	5:H:206:GLY:HA3	1.93	0.50
1:D:478:CYS:HB2	1:D:528:ALA:HB3	1.93	0.50
4:F:495:LEU:HD13	4:F:680:VAL:HG21	1.94	0.50
1:A:495:LEU:HD13	1:A:680:VAL:HG21	1.94	0.49
1:A:565:ILE:HD12	1:A:603:THR:HB	1.95	0.49
2:B:478:CYS:HB2	2:B:528:ALA:HB3	1.93	0.49
1:A:681:VAL:HB	1:A:689:GLU:HB2	1.93	0.49
1:A:303:PRO:HB2	8:A:1003:Y01:HBC	1.95	0.49
1:A:633:LEU:HB3	1:A:663:VAL:HG22	1.94	0.49
2:B:635:LEU:HD12	2:B:665:VAL:HG22	1.95	0.49
5:H:231:LEU:HA	5:H:449:MET:HG3	1.93	0.49
2:B:303:PRO:HB2	8:B:1003:Y01:HBC	1.95	0.49
1:C:635:LEU:HD12	1:C:665:VAL:HG22	1.95	0.49
4:F:303:PRO:HB2	8:F:1003:Y01:HBC	1.95	0.49

*Continued on next page...*

*Continued from previous page...*

Atom-1	Atom-2	Interatomic distance (Å)	Clash overlap (Å)
1:A:663:VAL:HG12	1:A:665:VAL:HG23	1.96	0.48
4:G:303:PRO:HB2	8:G:1003:Y01:HBC	1.96	0.48
5:H:303:PRO:HB2	8:H:1003:Y01:HBC	1.96	0.48
1:A:477:VAL:HG13	1:A:526:PRO:HB3	1.95	0.48
4:F:156:LEU:HA	4:F:278:THR:HG21	1.96	0.48
4:G:635:LEU:HD12	4:G:665:VAL:HG22	1.96	0.48
4:G:559:VAL:HB	5:H:343:THR:HG21	1.96	0.48
1:C:683:ALA:O	1:C:686:ARG:HG2	2.14	0.48
1:D:495:LEU:HD13	1:D:680:VAL:HG21	1.94	0.48
4:G:307:GLY:HA2	4:G:378:PHE:HZ	1.79	0.48
3:E:478:CYS:HB2	3:E:528:ALA:HB3	1.95	0.48
1:A:216:LEU:HD21	1:A:270:ILE:HB	1.95	0.47
1:D:156:LEU:HA	1:D:278:THR:HG21	1.95	0.47
1:C:216:LEU:HD21	1:C:270:ILE:HB	1.97	0.47
1:A:365:ARG:HB2	2:B:225:VAL:HG21	1.95	0.47
1:C:478:CYS:HB2	1:C:528:ALA:HB3	1.95	0.47
1:D:228:ARG:HG3	1:D:259:VAL:HG11	1.95	0.47
1:A:641:ALA:HB2	2:B:641:ALA:HB2	1.96	0.47
2:B:156:LEU:HD23	2:B:278:THR:HG23	1.96	0.47
4:F:635:LEU:HD12	4:F:665:VAL:HG22	1.96	0.47
1:A:513:LYS:HG2	1:A:682:MET:CE	2.43	0.47
3:E:365:ARG:HB2	4:F:225:VAL:HG21	1.96	0.47
5:H:478:CYS:HB2	5:H:528:ALA:HB3	1.96	0.47
1:D:512:GLY:HA2	6:D:1001:ADP:H5'1	1.97	0.47
1:D:566:MET:HB2	1:D:601:TYR:HB3	1.96	0.47
4:G:365:ARG:HB2	5:H:225:VAL:HG21	1.97	0.46
1:D:303:PRO:HB2	8:D:1003:Y01:HBC	1.97	0.46
4:G:225:VAL:HG21	5:H:365:ARG:HB2	1.96	0.46
3:E:635:LEU:HD12	3:E:665:VAL:HG22	1.98	0.46
3:E:303:PRO:HB2	8:E:1003:Y01:HBC	1.98	0.46
4:F:512:GLY:O	4:F:516:VAL:HG23	2.15	0.46
5:H:216:LEU:HD21	5:H:270:ILE:HB	1.98	0.46
4:F:477:VAL:HG13	4:F:526:PRO:HB3	1.98	0.45
4:F:478:YCM:HB3	4:F:528:ALA:HB3	1.98	0.45
1:C:152:VAL:HA	1:C:274:LEU:HD21	1.98	0.45
2:B:307:GLY:HA2	2:B:378:PHE:HZ	1.82	0.45
4:G:307:GLY:HA2	4:G:378:PHE:CZ	2.52	0.45
3:E:538:LEU:HA	3:E:541:LEU:HD12	1.98	0.44
4:G:697:LEU:HD21	4:G:707:ILE:HG21	2.00	0.44
2:B:152:VAL:HA	2:B:274:LEU:HD21	1.99	0.44
3:E:512:GLY:HA2	6:E:1001:ADP:H5'1	2.00	0.43

*Continued on next page...*

*Continued from previous page...*

Atom-1	Atom-2	Interatomic distance (Å)	Clash overlap (Å)
4:G:216:LEU:HD21	4:G:270:ILE:HB	1.99	0.43
4:G:478:YCM:HB3	4:G:528:ALA:HB3	2.00	0.43
1:A:349:MET:HG3	2:B:571:PHE:O	2.18	0.43
4:F:307:GLY:HA2	4:F:378:PHE:HZ	1.83	0.43
1:A:512:GLY:HA2	6:A:1001:ADP:H5'1	2.01	0.43
2:B:571:PHE:HB3	2:B:624:ARG:HD2	1.99	0.43
4:G:152:VAL:HA	4:G:274:LEU:HD21	2.00	0.43
2:B:307:GLY:HA2	2:B:378:PHE:CZ	2.54	0.43
1:D:307:GLY:HA2	1:D:378:PHE:HZ	1.84	0.43
4:F:512:GLY:HA2	6:F:1001:ADP:H5'1	2.01	0.43
3:E:152:VAL:HA	3:E:274:LEU:HD21	2.00	0.42
4:F:307:GLY:HA2	4:F:378:PHE:CZ	2.54	0.42
3:E:156:LEU:HA	3:E:278:THR:HG21	2.02	0.42
4:F:152:VAL:HA	4:F:274:LEU:HD21	2.01	0.42
5:H:571:PHE:HB3	5:H:624:ARG:HD2	2.01	0.42
4:F:468:LEU:HD21	4:F:550:VAL:HG13	2.01	0.42
1:A:538:LEU:HA	1:A:541:LEU:HD12	2.01	0.42
1:A:154:LEU:HD23	1:A:208:LEU:HD23	2.00	0.42
1:A:571:PHE:HB3	1:A:624:ARG:HD2	2.00	0.42
4:F:216:LEU:HD21	4:F:270:ILE:HB	2.00	0.42
5:H:156:LEU:HD23	5:H:278:THR:HG23	2.02	0.42
3:E:156:LEU:HD23	3:E:278:THR:HG23	2.02	0.41
1:C:538:LEU:HA	1:C:541:LEU:HD12	2.03	0.41
3:E:307:GLY:HA2	3:E:378:PHE:HZ	1.85	0.41
4:F:571:PHE:HB3	4:F:624:ARG:HD2	2.02	0.41
4:G:571:PHE:HB3	4:G:624:ARG:HD2	2.01	0.41
1:D:482:PRO:HD2	1:D:483:YCM:HZ21	1.85	0.41
1:D:571:PHE:HB3	1:D:624:ARG:HD2	2.02	0.41
3:E:559:VAL:HB	4:F:343:THR:HG21	2.02	0.41
3:E:571:PHE:HB3	3:E:624:ARG:HD2	2.01	0.41
4:G:538:LEU:HA	4:G:541:LEU:HD12	2.01	0.41
1:A:156:LEU:HD23	1:A:278:THR:HG23	2.03	0.41
1:D:307:GLY:HA2	1:D:378:PHE:CZ	2.55	0.41
3:E:387:ASN:HB3	4:F:202:TYR:CE1	2.55	0.41
3:E:307:GLY:HA2	3:E:378:PHE:CZ	2.55	0.41
2:B:697:LEU:HD21	2:B:707:ILE:HG21	2.03	0.41
4:F:261:GLU:O	4:F:265:SER:HB2	2.21	0.41
1:A:225:VAL:HG21	2:B:365:ARG:HB2	2.03	0.40
3:E:384:ILE:HD11	4:F:206:GLY:HA3	2.03	0.40
4:F:538:LEU:HD23	4:F:541:LEU:HD12	2.02	0.40
2:B:477:VAL:HG13	2:B:526:PRO:HB3	2.03	0.40

*Continued on next page...*

Continued from previous page...

Atom-1	Atom-2	Interatomic distance (Å)	Clash overlap (Å)
3:E:394:LEU:HD13	3:E:415:LEU:HD21	2.04	0.40

There are no symmetry-related clashes.

## 5.3 Torsion angles [i](#)

### 5.3.1 Protein backbone [i](#)

In the following table, the Percentiles column shows the percent Ramachandran outliers of the chain as a percentile score with respect to all X-ray entries followed by that with respect to entries of similar resolution.

The Analysed column shows the number of residues for which the backbone conformation was analysed, and the total number of residues.

Mol	Chain	Analysed	Favoured	Allowed	Outliers	Percentiles	
1	A	543/612 (89%)	525 (97%)	18 (3%)	0	100	100
1	C	526/612 (86%)	509 (97%)	17 (3%)	0	100	100
1	D	568/612 (93%)	550 (97%)	18 (3%)	0	100	100
2	B	567/612 (93%)	546 (96%)	21 (4%)	0	100	100
3	E	570/612 (93%)	549 (96%)	21 (4%)	0	100	100
4	F	567/612 (93%)	547 (96%)	20 (4%)	0	100	100
4	G	542/612 (89%)	524 (97%)	18 (3%)	0	100	100
5	H	538/612 (88%)	522 (97%)	16 (3%)	0	100	100
All	All	4421/4896 (90%)	4272 (97%)	149 (3%)	0	100	100

There are no Ramachandran outliers to report.

### 5.3.2 Protein sidechains [i](#)

In the following table, the Percentiles column shows the percent sidechain outliers of the chain as a percentile score with respect to all X-ray entries followed by that with respect to entries of similar resolution.

The Analysed column shows the number of residues for which the sidechain conformation was analysed, and the total number of residues.

Mol	Chain	Analysed	Rotameric	Outliers	Percentiles	
1	A	359/497 (72%)	351 (98%)	8 (2%)	52	75
1	C	271/497 (54%)	266 (98%)	5 (2%)	59	79
1	D	340/497 (68%)	331 (97%)	9 (3%)	46	72
2	B	368/496 (74%)	361 (98%)	7 (2%)	57	78
3	E	344/496 (69%)	338 (98%)	6 (2%)	60	80
4	F	375/496 (76%)	363 (97%)	12 (3%)	39	67
4	G	333/496 (67%)	329 (99%)	4 (1%)	71	85
5	H	280/498 (56%)	274 (98%)	6 (2%)	53	76
All	All	2670/3973 (67%)	2613 (98%)	57 (2%)	53	76

All (57) residues with a non-rotameric sidechain are listed below:

Mol	Chain	Res	Type
1	A	212	TYR
1	A	236	LEU
1	A	239	ASP
1	A	364	CYS
1	A	456	PRO
1	A	490	LEU
1	A	568	ASN
1	A	707	ILE
2	B	212	TYR
2	B	236	LEU
2	B	393	THR
2	B	437	ARG
2	B	473	THR
2	B	568	ASN
2	B	707	ILE
1	C	212	TYR
1	C	236	LEU
1	C	278	THR
1	C	364	CYS
1	C	568	ASN
1	D	212	TYR
1	D	236	LEU
1	D	256	THR
1	D	437	ARG
1	D	473	THR
1	D	480	SER
1	D	490	LEU

*Continued on next page...*

*Continued from previous page...*

Mol	Chain	Res	Type
1	D	568	ASN
1	D	707	ILE
3	E	212	TYR
3	E	236	LEU
3	E	393	THR
3	E	437	ARG
3	E	473	THR
3	E	568	ASN
4	F	156	LEU
4	F	198	LEU
4	F	212	TYR
4	F	236	LEU
4	F	265	SER
4	F	278	THR
4	F	292	THR
4	F	393	THR
4	F	437	ARG
4	F	456	PRO
4	F	473	THR
4	F	568	ASN
4	G	212	TYR
4	G	260	GLN
4	G	473	THR
4	G	515	THR
5	H	212	TYR
5	H	236	LEU
5	H	364	CYS
5	H	437	ARG
5	H	473	THR
5	H	568	ASN

Sometimes sidechains can be flipped to improve hydrogen bonding and reduce clashes. All (5) such sidechains are listed below:

Mol	Chain	Res	Type
3	E	387	ASN
3	E	422	GLN
4	F	162	ASN
4	F	205	GLN
4	G	238	GLN

### 5.3.3 RNA [i](#)

There are no RNA molecules in this entry.

## 5.4 Non-standard residues in protein, DNA, RNA chains [i](#)

11 non-standard protein/DNA/RNA residues are modelled in this entry.

In the following table, the Counts columns list the number of bonds (or angles) for which Mogul statistics could be retrieved, the number of bonds (or angles) that are observed in the model and the number of bonds (or angles) that are defined in the Chemical Component Dictionary. The Link column lists molecule types, if any, to which the group is linked. The Z score for a bond length (or angle) is the number of standard deviations the observed value is removed from the expected value. A bond length (or angle) with  $|Z| > 2$  is considered an outlier worth inspection. RMSZ is the root-mean-square of all Z scores of the bond lengths (or angles).

Mol	Type	Chain	Res	Link	Bond lengths			Bond angles		
					Counts	RMSZ	# Z  > 2	Counts	RMSZ	# Z  > 2
1	YCM	A	483	1	7,9,10	0.40	0	4,10,12	0.26	0
4	YCM	F	478	4	7,9,10	0.51	0	4,10,12	0.26	0
2	YCM	B	461	2	7,9,10	0.42	0	4,10,12	0.54	0
2	YCM	B	483	2	7,9,10	0.38	0	4,10,12	0.29	0
4	YCM	G	478	4	7,9,10	0.43	0	4,10,12	0.38	0
3	YCM	E	483	3	7,9,10	0.40	0	4,10,12	0.24	0
1	YCM	D	483	1	7,9,10	0.40	0	4,10,12	0.35	0
3	YCM	E	366	3	7,9,10	0.41	0	4,10,12	0.23	0
4	YCM	F	483	4	7,9,10	0.38	0	4,10,12	0.46	0
1	YCM	C	483	1	7,9,10	0.40	0	4,10,12	0.26	0
4	YCM	G	483	4	7,9,10	0.40	0	4,10,12	0.25	0

In the following table, the Chirals column lists the number of chiral outliers, the number of chiral centers analysed, the number of these observed in the model and the number defined in the Chemical Component Dictionary. Similar counts are reported in the Torsion and Rings columns. '-' means no outliers of that kind were identified.

Mol	Type	Chain	Res	Link	Chirals	Torsions	Rings
1	YCM	A	483	1	-	1/6/8/10	-
4	YCM	F	478	4	-	1/6/8/10	-
2	YCM	B	461	2	-	3/6/8/10	-
2	YCM	B	483	2	-	1/6/8/10	-
4	YCM	G	478	4	-	0/6/8/10	-
3	YCM	E	483	3	-	1/6/8/10	-
1	YCM	D	483	1	-	1/6/8/10	-
3	YCM	E	366	3	-	1/6/8/10	-

*Continued on next page...*

*Continued from previous page...*

Mol	Type	Chain	Res	Link	Chirals	Torsions	Rings
4	YCM	F	483	4	-	3/6/8/10	-
1	YCM	C	483	1	-	1/6/8/10	-
4	YCM	G	483	4	-	1/6/8/10	-

There are no bond length outliers.

There are no bond angle outliers.

There are no chirality outliers.

All (14) torsion outliers are listed below:

Mol	Chain	Res	Type	Atoms
1	A	483	YCM	SG-CD-CE-NZ2
2	B	461	YCM	SG-CD-CE-OZ1
2	B	461	YCM	SG-CD-CE-NZ2
2	B	483	YCM	SG-CD-CE-NZ2
1	C	483	YCM	SG-CD-CE-NZ2
1	D	483	YCM	SG-CD-CE-NZ2
3	E	366	YCM	SG-CD-CE-NZ2
3	E	483	YCM	SG-CD-CE-NZ2
4	F	483	YCM	SG-CD-CE-OZ1
4	F	483	YCM	SG-CD-CE-NZ2
4	G	483	YCM	SG-CD-CE-NZ2
2	B	461	YCM	CA-CB-SG-CD
4	F	478	YCM	CA-CB-SG-CD
4	F	483	YCM	CE-CD-SG-CB

There are no ring outliers.

4 monomers are involved in 4 short contacts:

Mol	Chain	Res	Type	Clashes	Symm-Clashes
4	F	478	YCM	1	0
4	G	478	YCM	1	0
1	D	483	YCM	1	0
4	F	483	YCM	1	0

## 5.5 Carbohydrates [i](#)

There are no monosaccharides in this entry.



## 5.6 Ligand geometry

Of 23 ligands modelled in this entry, 8 are monoatomic - leaving 15 for Mogul analysis.

In the following table, the Counts columns list the number of bonds (or angles) for which Mogul statistics could be retrieved, the number of bonds (or angles) that are observed in the model and the number of bonds (or angles) that are defined in the Chemical Component Dictionary. The Link column lists molecule types, if any, to which the group is linked. The Z score for a bond length (or angle) is the number of standard deviations the observed value is removed from the expected value. A bond length (or angle) with  $|Z| > 2$  is considered an outlier worth inspection. RMSZ is the root-mean-square of all Z scores of the bond lengths (or angles).

Mol	Type	Chain	Res	Link	Bond lengths			Bond angles		
					Counts	RMSZ	# Z  > 2	Counts	RMSZ	# Z  > 2
6	ADP	E	1001	7	24,29,29	0.74	0	29,45,45	0.76	1 (3%)
8	Y01	D	1003	-	29,29,38	0.39	0	46,46,57	0.51	0
8	Y01	A	1003	-	33,33,38	0.35	0	51,51,57	0.47	0
8	Y01	B	1003	-	38,38,38	0.33	0	57,57,57	0.43	0
8	Y01	G	1003	-	24,24,38	0.46	0	37,39,57	0.64	1 (2%)
8	Y01	H	1003	-	31,31,38	0.36	0	46,48,57	0.55	1 (2%)
6	ADP	D	1001	7	24,29,29	0.57	0	29,45,45	0.71	1 (3%)
6	ADP	H	1001	7	24,29,29	0.61	0	29,45,45	0.65	1 (3%)
6	ADP	F	1001	7	24,29,29	0.72	0	29,45,45	0.79	1 (3%)
6	ADP	G	1001	7	24,29,29	0.55	0	29,45,45	0.67	1 (3%)
6	ADP	A	1001	7	24,29,29	0.59	0	29,45,45	0.67	1 (3%)
8	Y01	E	1003	-	31,31,38	0.37	0	46,48,57	0.51	1 (2%)
8	Y01	F	1003	-	38,38,38	0.32	0	57,57,57	0.43	0
6	ADP	B	1001	7	24,29,29	0.60	0	29,45,45	0.65	1 (3%)
6	ADP	C	1001	7	24,29,29	0.58	0	29,45,45	0.67	1 (3%)

In the following table, the Chirals column lists the number of chiral outliers, the number of chiral centers analysed, the number of these observed in the model and the number defined in the Chemical Component Dictionary. Similar counts are reported in the Torsion and Rings columns. '-' means no outliers of that kind were identified.

Mol	Type	Chain	Res	Link	Chirals	Torsions	Rings
6	ADP	E	1001	7	-	0/12/32/32	0/3/3/3
8	Y01	D	1003	-	-	1/8/66/77	0/4/4/4
8	Y01	A	1003	-	-	2/13/71/77	0/4/4/4
8	Y01	B	1003	-	-	7/19/77/77	0/4/4/4
8	Y01	G	1003	-	-	-	0/4/4/4
8	Y01	H	1003	-	-	2/9/67/77	0/4/4/4

*Continued on next page...*

Continued from previous page...

Mol	Type	Chain	Res	Link	Chirals	Torsions	Rings
6	ADP	D	1001	7	-	0/12/32/32	0/3/3/3
6	ADP	H	1001	7	-	0/12/32/32	0/3/3/3
6	ADP	F	1001	7	-	0/12/32/32	0/3/3/3
6	ADP	G	1001	7	-	0/12/32/32	0/3/3/3
6	ADP	A	1001	7	-	0/12/32/32	0/3/3/3
8	Y01	E	1003	-	-	2/9/67/77	0/4/4/4
8	Y01	F	1003	-	-	6/19/77/77	0/4/4/4
6	ADP	B	1001	7	-	0/12/32/32	0/3/3/3
6	ADP	C	1001	7	-	0/12/32/32	0/3/3/3

There are no bond length outliers.

All (11) bond angle outliers are listed below:

Mol	Chain	Res	Type	Atoms	Z	Observed(°)	Ideal(°)
6	D	1001	ADP	C5-C6-N6	2.44	124.07	120.35
8	H	1003	Y01	CBB-CBE-CBI	2.29	120.31	115.89
8	G	1003	Y01	CBB-CBE-CBI	2.28	120.28	115.89
6	C	1001	ADP	C5-C6-N6	2.27	123.80	120.35
6	A	1001	ADP	C5-C6-N6	2.27	123.80	120.35
6	B	1001	ADP	C5-C6-N6	2.21	123.72	120.35
6	G	1001	ADP	C5-C6-N6	2.20	123.69	120.35
8	E	1003	Y01	CBB-CBE-CBI	2.19	120.11	115.89
6	H	1001	ADP	C5-C6-N6	2.18	123.66	120.35
6	F	1001	ADP	C5-C6-N6	2.14	123.60	120.35
6	E	1001	ADP	C5-C6-N6	2.01	123.41	120.35

There are no chirality outliers.

All (20) torsion outliers are listed below:

Mol	Chain	Res	Type	Atoms
8	B	1003	Y01	CAJ-CAO-CBB-CBE
8	F	1003	Y01	CAJ-CAO-CBB-CBE
8	B	1003	Y01	CAJ-CAO-CBB-CAC
8	F	1003	Y01	CAJ-CAO-CBB-CAC
8	B	1003	Y01	CAJ-CAN-CBA-CAA
8	F	1003	Y01	CAJ-CAN-CBA-CAB
8	B	1003	Y01	CAJ-CAN-CBA-CAB
8	F	1003	Y01	CAJ-CAN-CBA-CAA
8	B	1003	Y01	CAN-CAJ-CAO-CBB
8	D	1003	Y01	CAM-CAY-OAW-CBC
8	B	1003	Y01	CAM-CAL-CAX-OAH

Continued on next page...

*Continued from previous page...*

Mol	Chain	Res	Type	Atoms
8	H	1003	Y01	CAM-CAL-CAX-OAH
8	A	1003	Y01	CAM-CAL-CAX-OAH
8	E	1003	Y01	CAM-CAL-CAX-OAH
8	F	1003	Y01	CAM-CAL-CAX-OAH
8	A	1003	Y01	CAM-CAL-CAX-OAF
8	H	1003	Y01	CAM-CAL-CAX-OAF
8	E	1003	Y01	CAM-CAL-CAX-OAF
8	B	1003	Y01	CAM-CAL-CAX-OAF
8	F	1003	Y01	CAM-CAL-CAX-OAF

There are no ring outliers.

11 monomers are involved in 11 short contacts:

Mol	Chain	Res	Type	Clashes	Symm-Clashes
6	E	1001	ADP	1	0
8	D	1003	Y01	1	0
8	A	1003	Y01	1	0
8	B	1003	Y01	1	0
8	G	1003	Y01	1	0
8	H	1003	Y01	1	0
6	D	1001	ADP	1	0
6	F	1001	ADP	1	0
6	A	1001	ADP	1	0
8	E	1003	Y01	1	0
8	F	1003	Y01	1	0

The following is a two-dimensional graphical depiction of Mogul quality analysis of bond lengths, bond angles, torsion angles, and ring geometry for all instances of the Ligand of Interest. In addition, ligands with molecular weight > 250 and outliers as shown on the validation Tables will also be included. For torsion angles, if less than 5% of the Mogul distribution of torsion angles is within 10 degrees of the torsion angle in question, then that torsion angle is considered an outlier. Any bond that is central to one or more torsion angles identified as an outlier by Mogul will be highlighted in the graph. For rings, the root-mean-square deviation (RMSD) between the ring in question and similar rings identified by Mogul is calculated over all ring torsion angles. If the average RMSD is greater than 60 degrees and the minimal RMSD between the ring in question and any Mogul-identified rings is also greater than 60 degrees, then that ring is considered an outlier. The outliers are highlighted in purple. The color gray indicates Mogul did not find sufficient equivalents in the CSD to analyse the geometry.

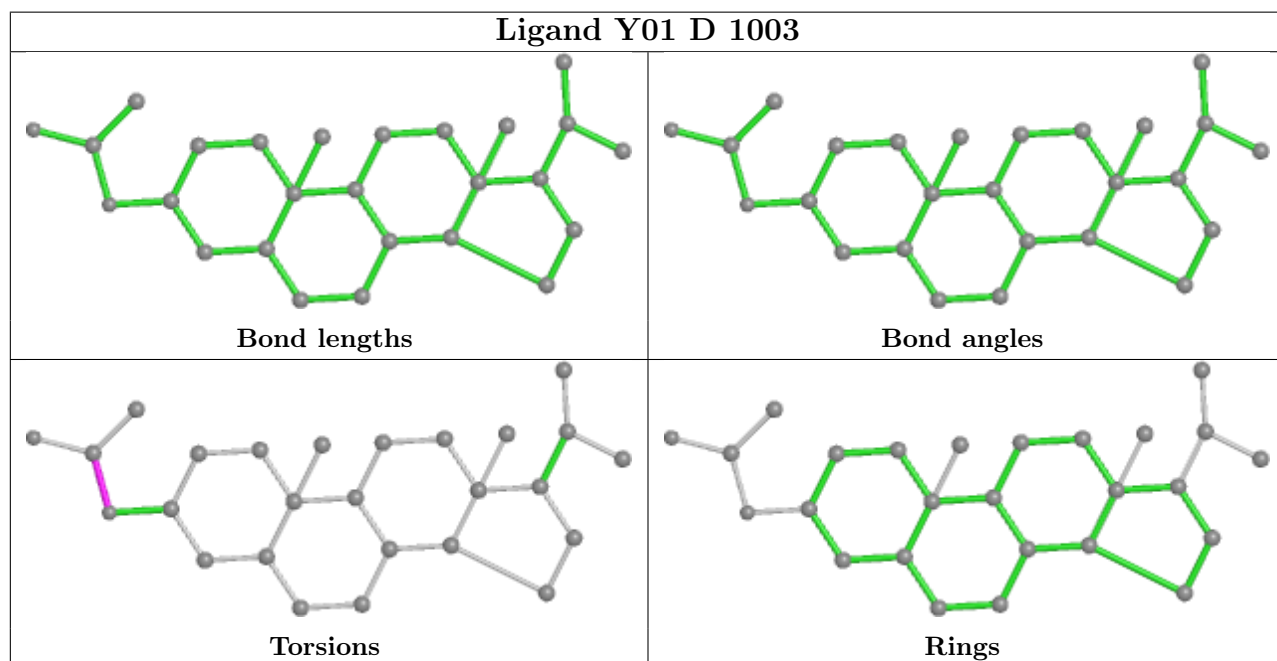
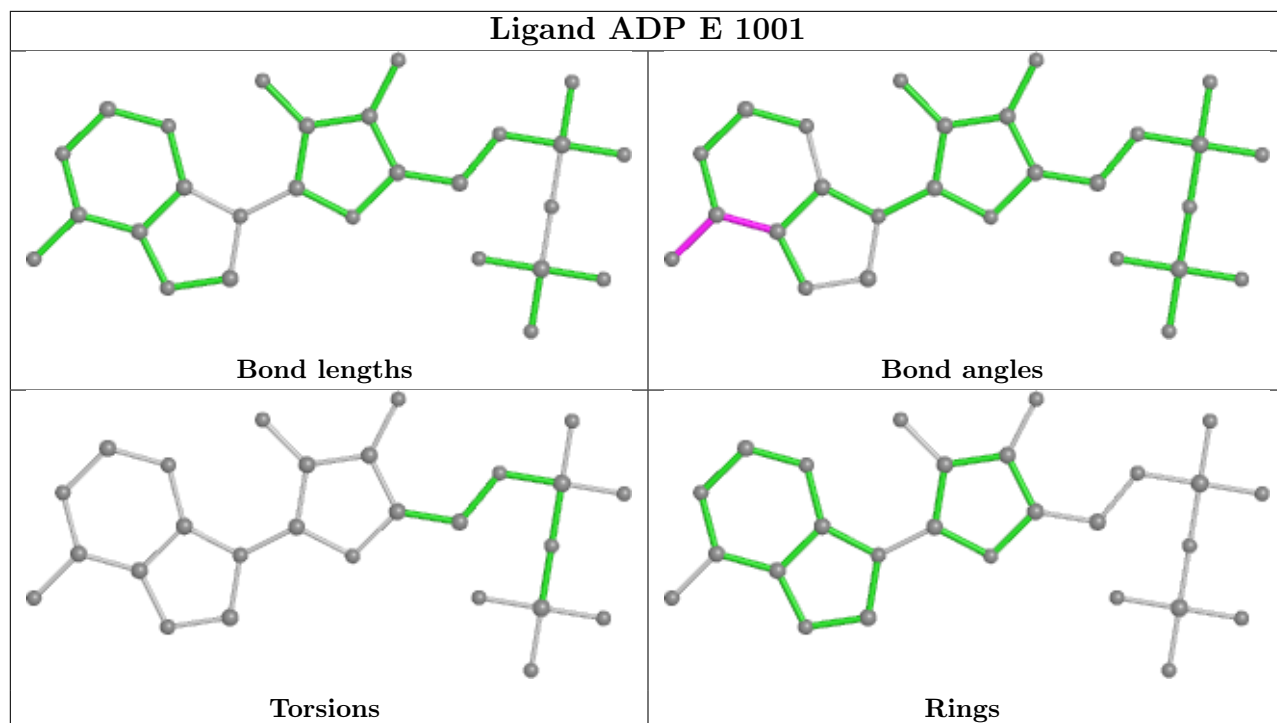

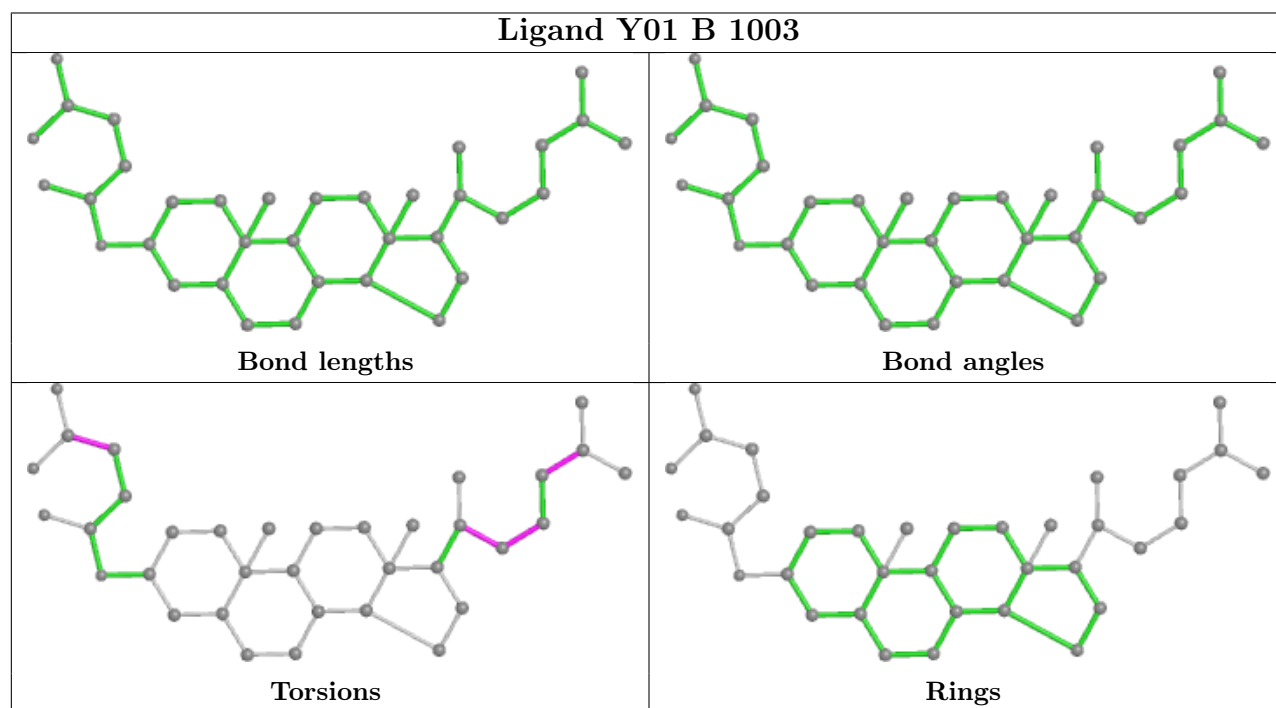
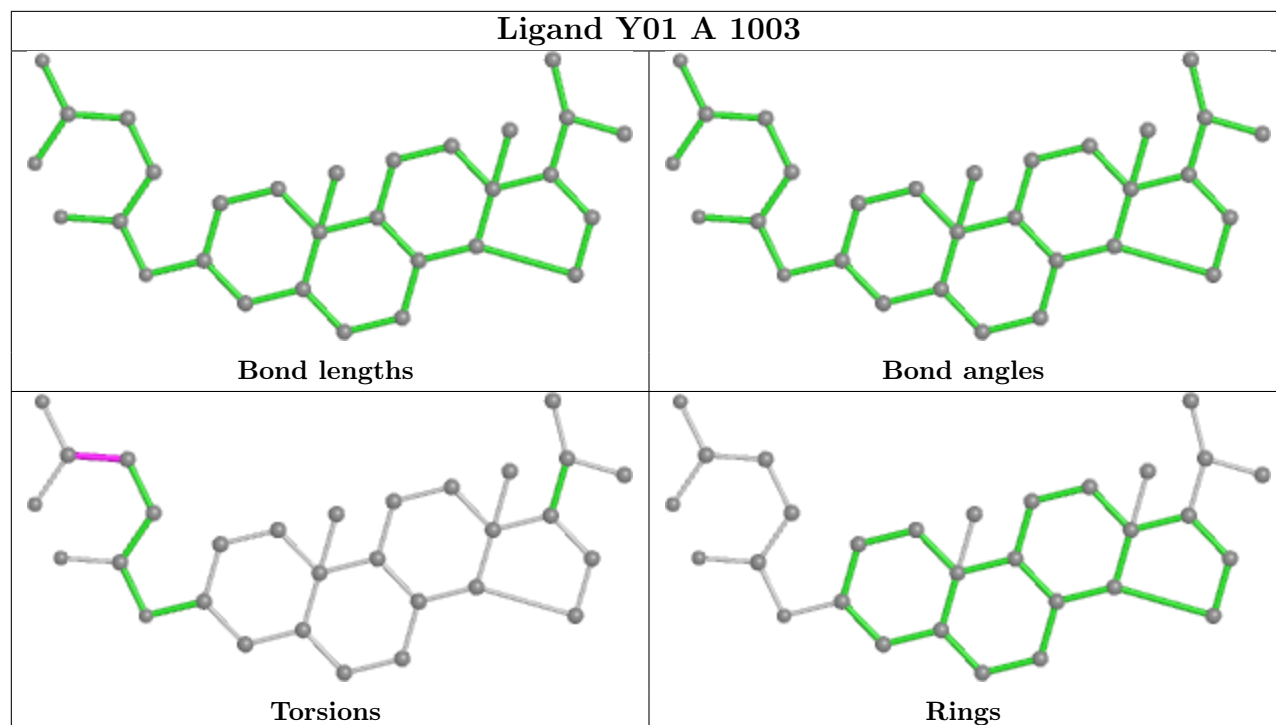

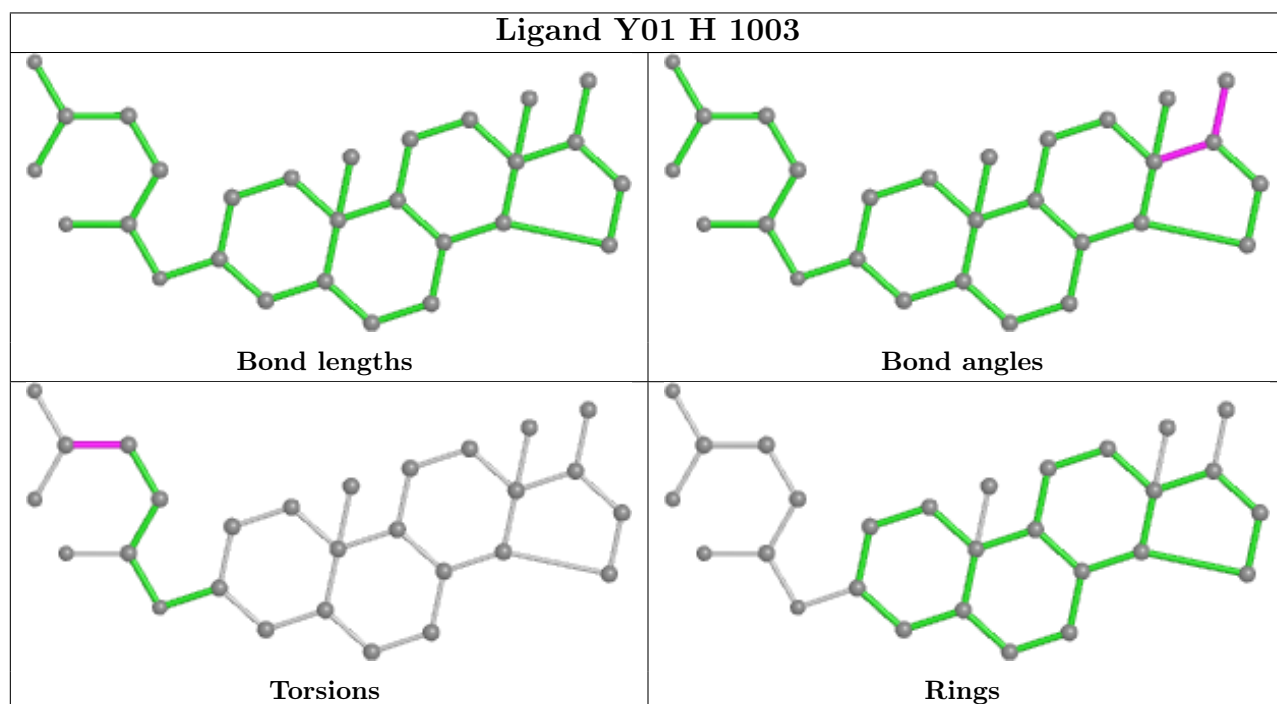
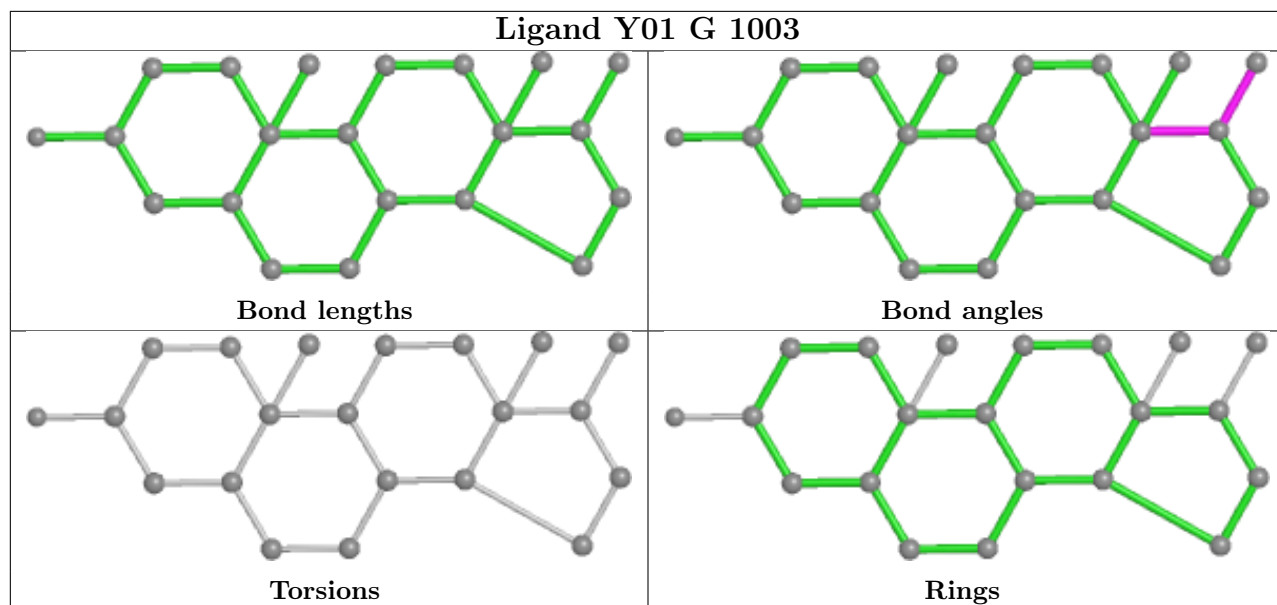

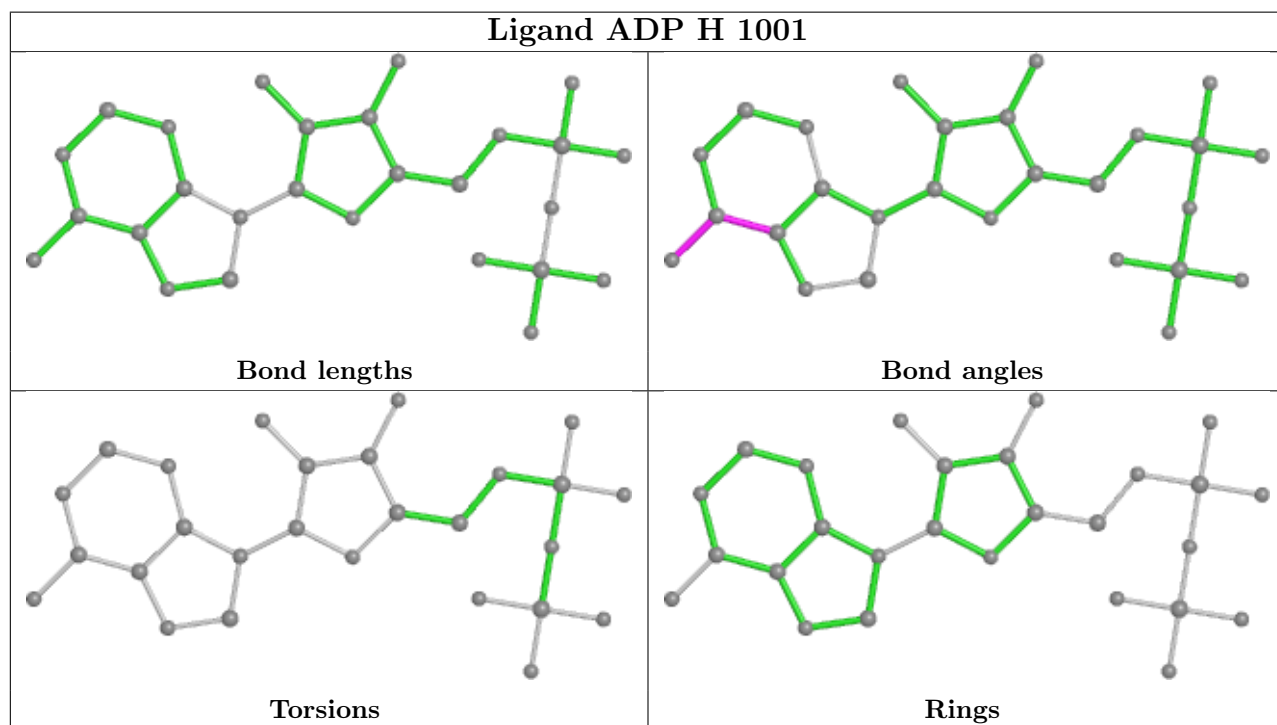
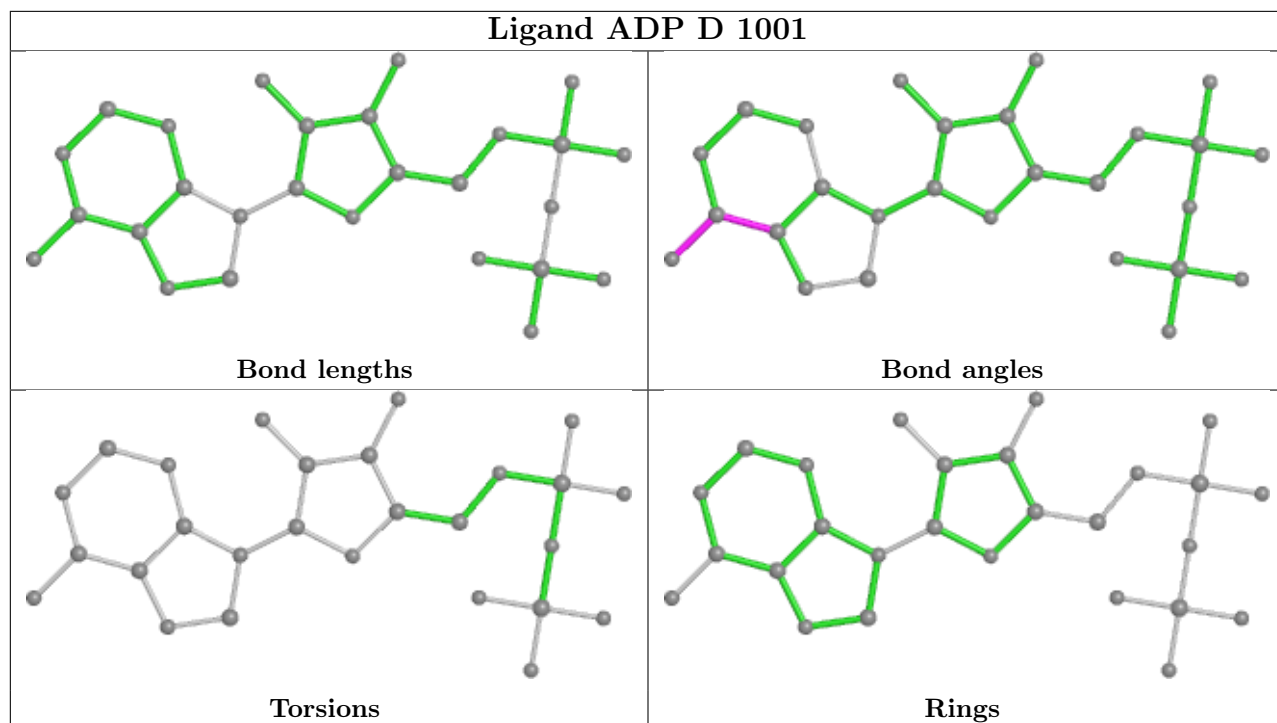

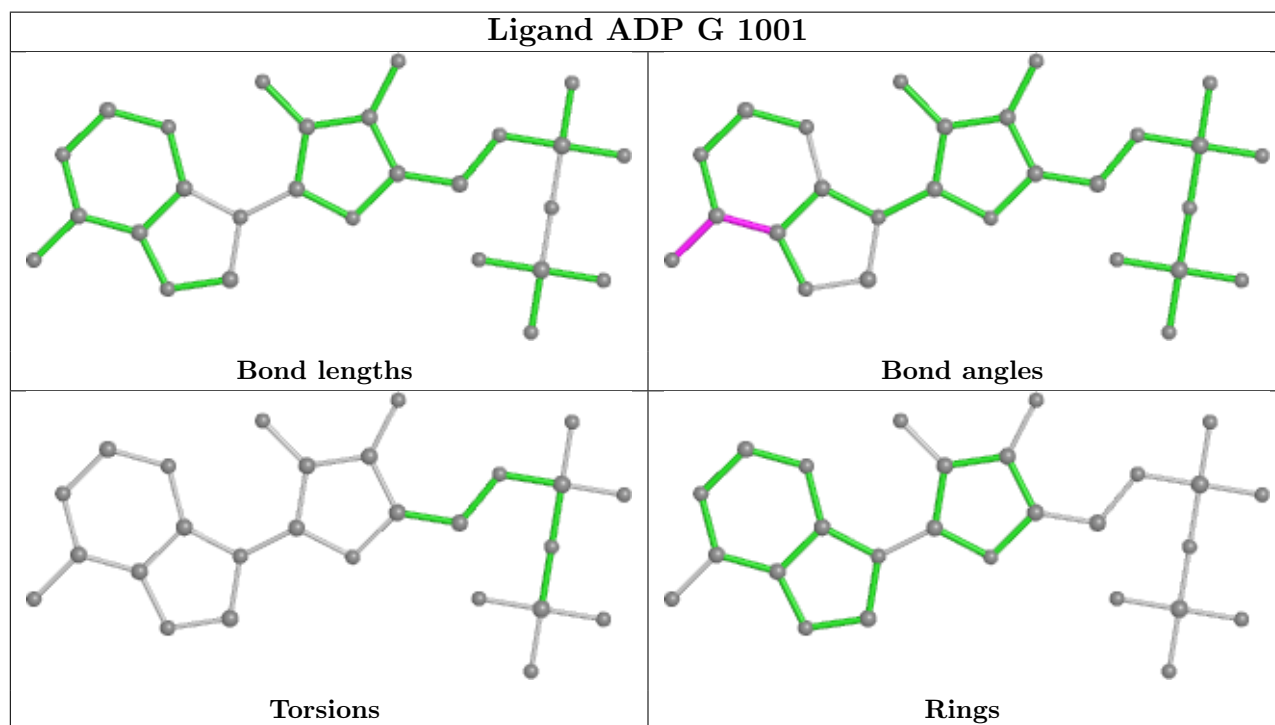
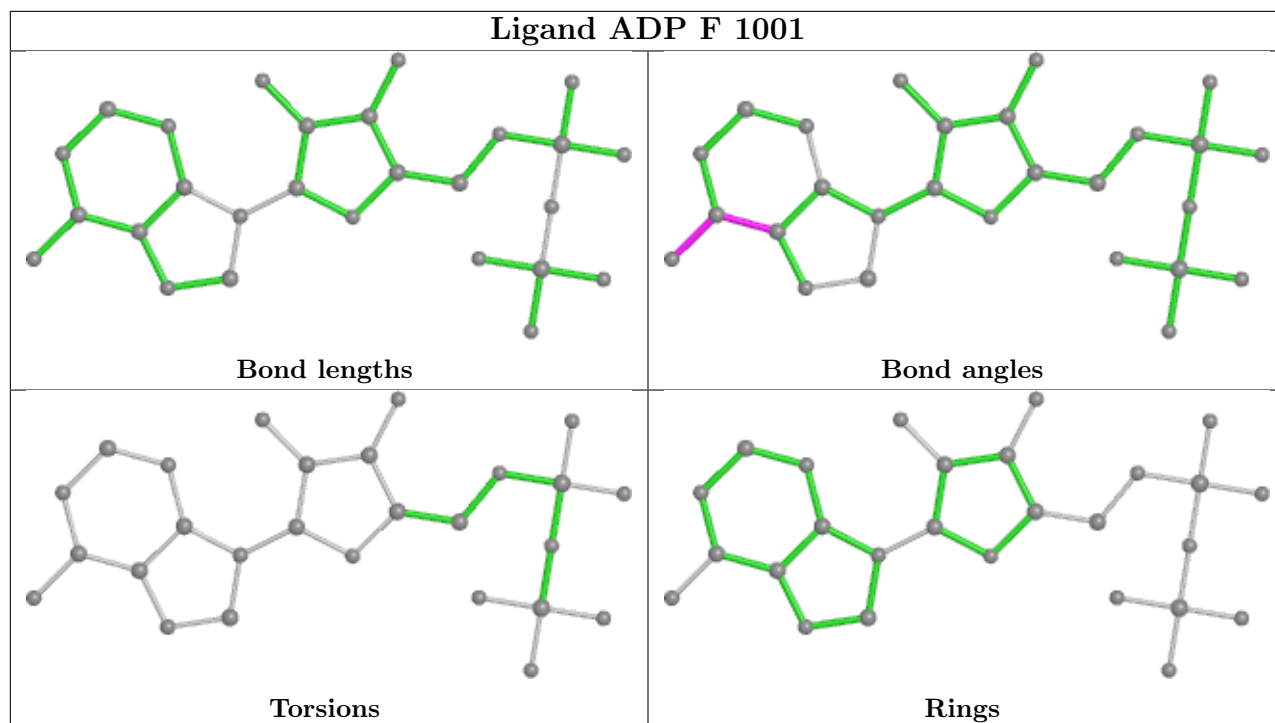



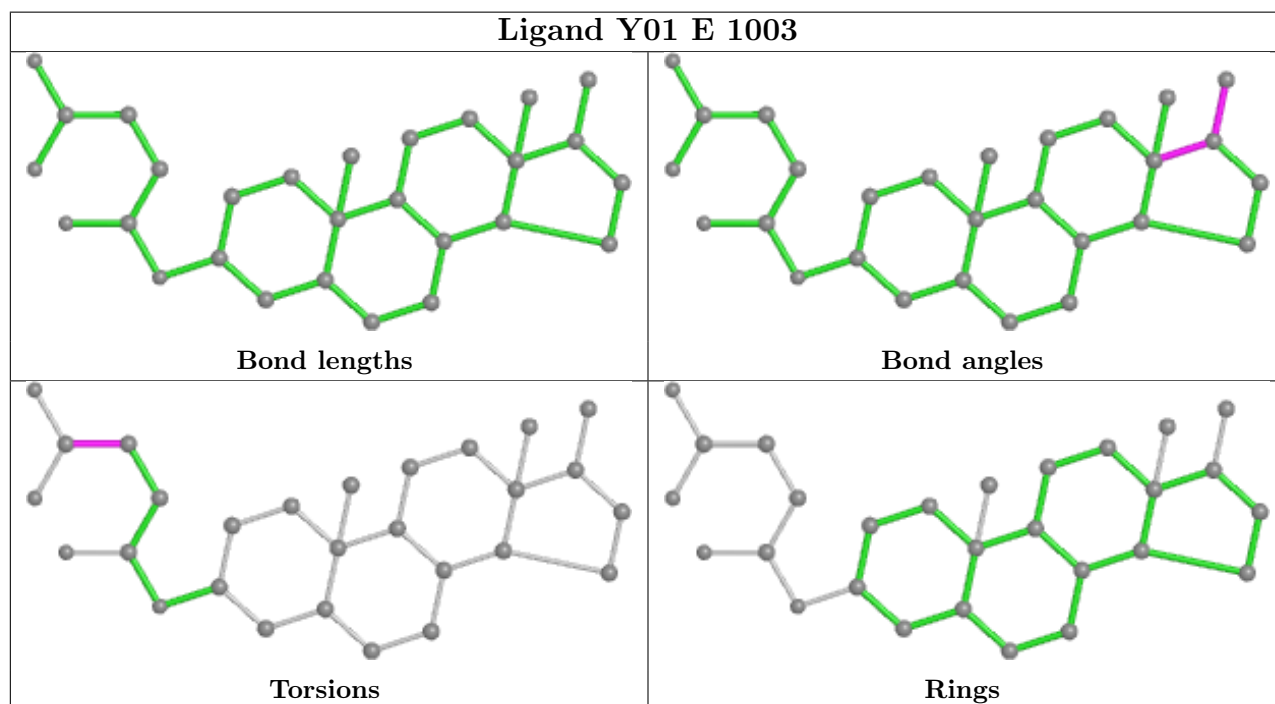
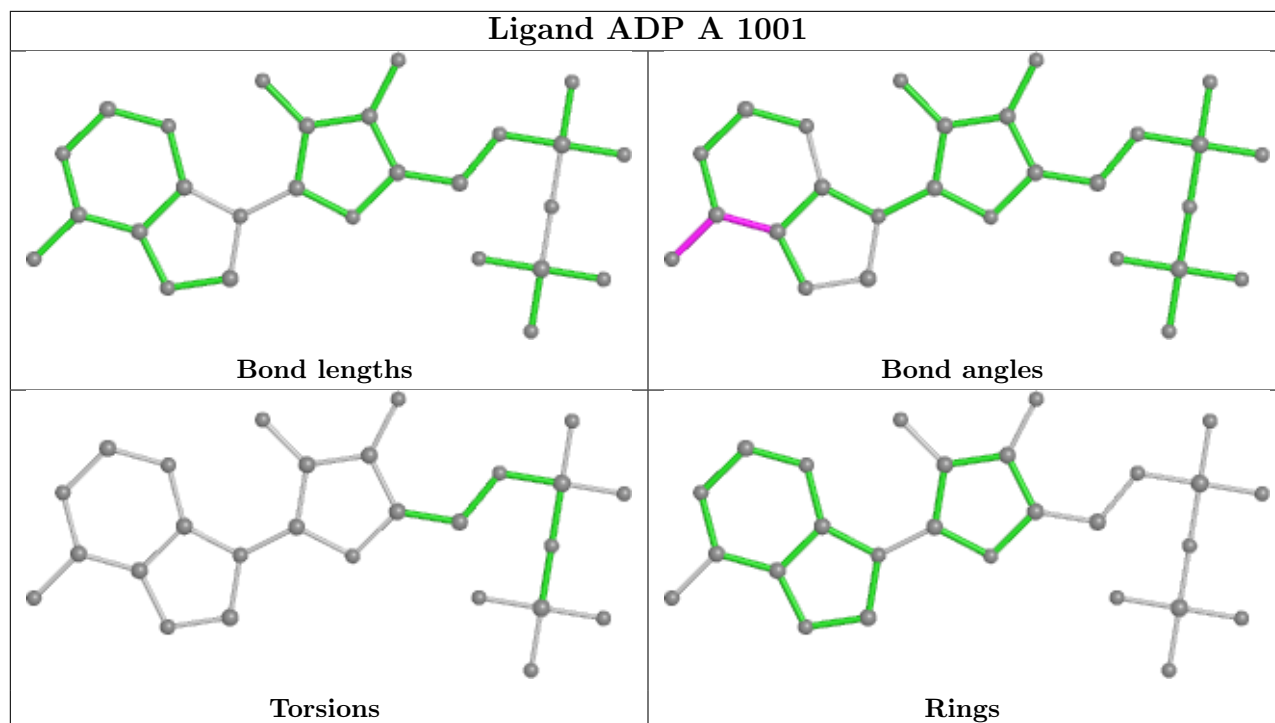

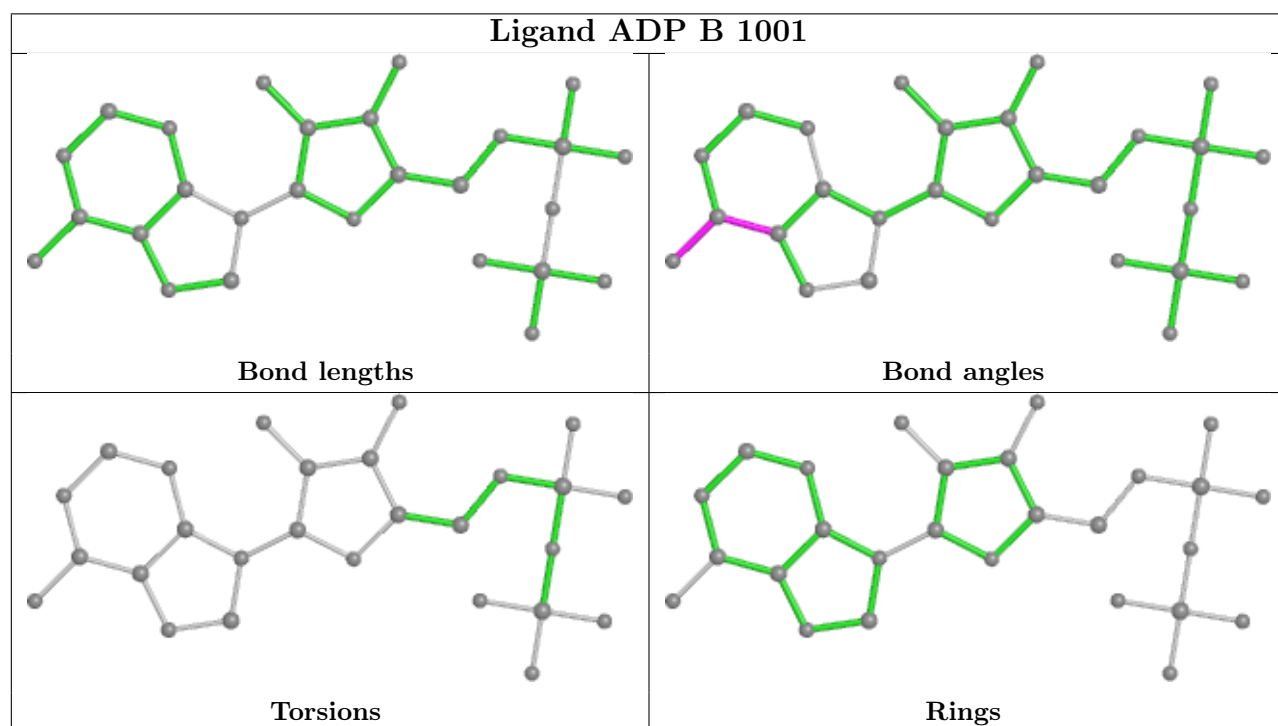
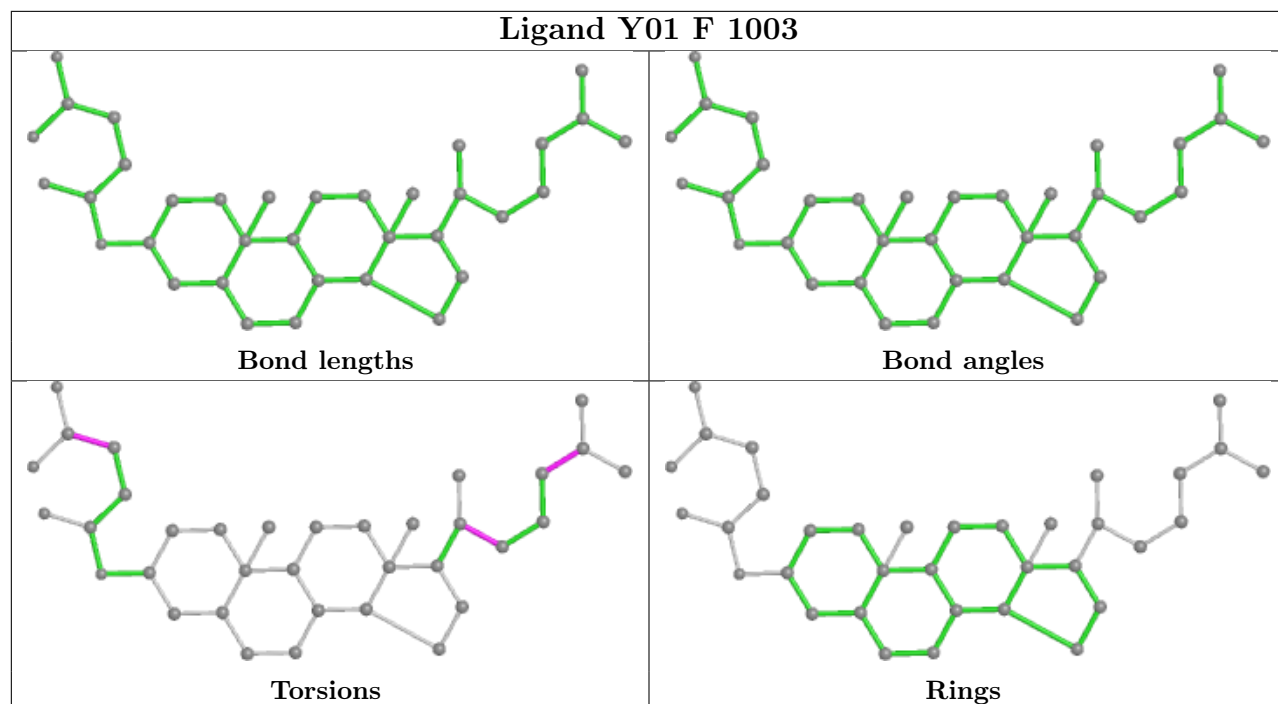

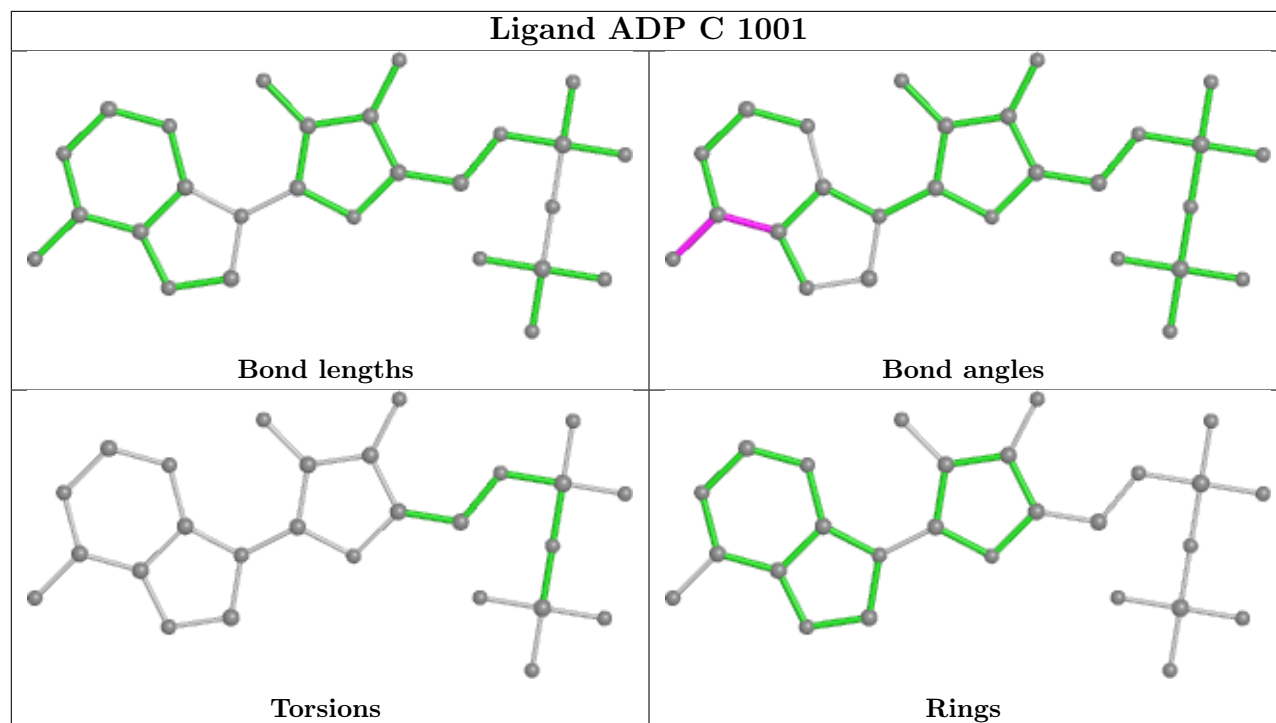

## 5.7 Other polymers [i](#)

There are no such residues in this entry.

## 5.8 Polymer linkage issues [i](#)

There are no chain breaks in this entry.

## 6 Fit of model and data

### 6.1 Protein, DNA and RNA chains

In the following table, the column labelled ‘#RSRZ> 2’ contains the number (and percentage) of RSRZ outliers, followed by percent RSRZ outliers for the chain as percentile scores relative to all X-ray entries and entries of similar resolution. The OWAB column contains the minimum, median, 95<sup>th</sup> percentile and maximum values of the occupancy-weighted average B-factor per residue. The column labelled ‘Q< 0.9’ lists the number of (and percentage) of residues with an average occupancy less than 0.9.

Mol	Chain	Analysed	<RSRZ>	#RSRZ>2	OWAB(Å <sup>2</sup> )	Q<0.9
1	A	551/612 (90%)	0.07	21 (3%) 40 39	63, 111, 196, 250	0
1	C	536/612 (87%)	0.30	62 (11%) 4 5	87, 172, 227, 255	0
1	D	572/612 (93%)	0.06	29 (5%) 28 28	57, 130, 213, 239	0
2	B	571/612 (93%)	0.18	19 (3%) 46 45	46, 102, 208, 253	0
3	E	574/612 (93%)	0.41	73 (12%) 3 4	76, 161, 214, 233	0
4	F	571/612 (93%)	-0.01	16 (2%) 53 51	62, 116, 183, 204	0
4	G	550/612 (89%)	0.05	19 (3%) 44 43	74, 134, 200, 244	0
5	H	548/612 (89%)	0.32	56 (10%) 6 8	85, 173, 234, 260	0
All	All	4473/4896 (91%)	0.17	295 (6%) 18 20	46, 137, 215, 260	0

All (295) RSRZ outliers are listed below:

Mol	Chain	Res	Type	RSRZ
1	C	189	THR	9.0
1	C	397	GLY	8.6
3	E	632	VAL	8.5
3	E	662	THR	8.5
3	E	700	GLY	8.4
3	E	702	LEU	8.2
2	B	188	MET	8.1
2	B	286	SER	7.3
3	E	631	THR	7.2
5	H	683	ALA	7.1
5	H	676	ALA	7.1
3	E	507	GLY	7.0
5	H	504	ALA	6.4
5	H	608	ARG	6.2
5	H	511	GLY	6.1
4	F	287	LEU	6.1

*Continued on next page...*

*Continued from previous page...*

<b>Mol</b>	<b>Chain</b>	<b>Res</b>	<b>Type</b>	<b>RSRZ</b>
1	C	433	GLY	5.9
3	E	701	GLY	5.9
5	H	235	LEU	5.8
5	H	684	ASP	5.8
1	C	500	GLY	5.8
3	E	310	THR	5.7
5	H	505	LEU	5.6
5	H	609	GLY	5.6
1	A	409	GLY	5.6
3	E	502	ILE	5.6
1	C	193	ASN	5.5
3	E	698	LYS	5.3
5	H	238	GLN	5.3
4	F	288	SER	5.3
4	F	286	SER	5.2
1	D	192	GLN	5.2
1	A	189	THR	5.1
1	C	425	MET	5.1
3	E	508	GLN	5.0
5	H	704	ALA	5.0
5	H	234	SER	5.0
1	C	660	GLY	5.0
4	G	607	GLU	5.0
5	H	702	LEU	5.0
1	D	357	TYR	5.0
3	E	694	GLU	4.9
3	E	688	TRP	4.9
1	D	356	ARG	4.9
3	E	501	LYS	4.8
3	E	402	ALA	4.8
1	C	659	ALA	4.7
1	C	190	GLU	4.6
1	C	667	ALA	4.6
1	C	191	SER	4.6
2	B	191	SER	4.6
5	H	508	GLN	4.6
3	E	693	HIS	4.6
3	E	703	TYR	4.5
5	H	697	LEU	4.5
2	B	412	MET	4.5
5	H	607	GLU	4.5
1	C	195	SER	4.5

*Continued on next page...*

*Continued from previous page...*

<b>Mol</b>	<b>Chain</b>	<b>Res</b>	<b>Type</b>	<b>RSRZ</b>
3	E	680	VAL	4.4
1	C	501	LYS	4.4
2	B	612	LEU	4.4
1	C	664	LEU	4.3
3	E	697	LEU	4.3
3	E	504	ALA	4.3
1	C	714	ALA	4.2
3	E	173	VAL	4.2
3	E	509	SER	4.2
5	H	510	GLY	4.2
3	E	663	VAL	4.2
3	E	309	GLY	4.2
4	F	632	VAL	4.2
3	E	510	GLY	4.1
5	H	679	ILE	4.1
1	C	626	LEU	4.1
5	H	502	ILE	4.1
3	E	679	ILE	4.1
3	E	511	GLY	4.1
5	H	509	SER	4.1
5	H	662	THR	4.0
3	E	503	VAL	4.0
5	H	412	MET	4.0
1	D	326	GLN	4.0
5	H	244	ASP	4.0
3	E	677	HIS	4.0
4	F	634	ILE	4.0
5	H	397	GLY	4.0
1	D	408	GLY	3.9
4	G	338	LEU	3.9
3	E	399	SER	3.9
2	B	287	LEU	3.8
3	E	687	VAL	3.8
3	E	681	VAL	3.8
1	C	632	VAL	3.8
2	B	613	SER	3.7
1	C	662	THR	3.7
1	D	353	GLU	3.7
1	C	711	ALA	3.6
3	E	660	GLY	3.6
1	D	361	LEU	3.6
3	E	699	LYS	3.6

*Continued on next page...*

*Continued from previous page...*

<b>Mol</b>	<b>Chain</b>	<b>Res</b>	<b>Type</b>	<b>RSRZ</b>
3	E	685	GLY	3.6
3	E	506	VAL	3.6
1	C	236	LEU	3.5
5	H	630	PRO	3.5
4	G	411	LEU	3.5
1	A	291	SER	3.5
1	C	232	PHE	3.5
4	F	356	ARG	3.5
5	H	282	GLY	3.5
2	B	198	LEU	3.5
2	B	283	CYS	3.5
3	E	308	VAL	3.4
1	C	240	ILE	3.4
1	C	429	SER	3.4
5	H	632	VAL	3.4
4	G	357	TYR	3.4
3	E	257	THR	3.3
4	G	666	ILE	3.3
1	C	197	HIS	3.3
2	B	134	TRP	3.3
1	C	192	GLN	3.3
5	H	192	GLN	3.3
1	C	273	GLY	3.3
1	A	509	SER	3.3
5	H	681	VAL	3.2
1	C	706	LEU	3.2
3	E	465	LYS	3.2
1	C	256	THR	3.2
5	H	241	THR	3.2
1	C	437	ARG	3.2
3	E	497	LEU	3.2
1	A	171	GLN	3.2
5	H	705	GLU	3.2
2	B	611	THR	3.1
3	E	682	MET	3.1
5	H	524	TYR	3.1
1	C	703	TYR	3.1
1	A	170	GLY	3.1
3	E	505	LEU	3.1
3	E	715	ALA	3.1
1	D	607	GLU	3.1
1	C	228	ARG	3.1

*Continued on next page...*

*Continued from previous page...*

<b>Mol</b>	<b>Chain</b>	<b>Res</b>	<b>Type</b>	<b>RSRZ</b>
2	B	282	GLY	3.0
1	C	665	VAL	3.0
5	H	237	ARG	3.0
1	A	165	ILE	3.0
1	C	420	THR	3.0
1	C	396	ILE	3.0
4	F	292	THR	3.0
5	H	698	LYS	3.0
5	H	651	GLN	3.0
3	E	174	GLU	3.0
4	F	664	LEU	2.9
1	A	408	GLY	2.9
1	C	434	GLN	2.9
1	A	167	LEU	2.9
1	D	412	MET	2.9
1	C	436	VAL	2.9
1	C	428	LEU	2.9
5	H	166	PRO	2.9
1	A	510	GLY	2.9
3	E	667	ALA	2.9
1	A	463	VAL	2.9
1	D	360	GLU	2.9
3	E	552	GLY	2.9
1	C	631	THR	2.9
1	A	166	PRO	2.9
1	D	364	CYS	2.9
1	A	164	GLN	2.9
3	E	676	ALA	2.9
3	E	696	LEU	2.9
5	H	660	GLY	2.9
3	E	134	TRP	2.8
1	D	176	VAL	2.8
2	B	132	PHE	2.8
1	C	277	CYS	2.8
1	C	670	LEU	2.8
1	C	262	PHE	2.8
4	F	296	LEU	2.8
5	H	240	ILE	2.8
4	F	520	LEU	2.8
3	E	633	LEU	2.8
1	C	503	VAL	2.7
1	A	169	LEU	2.7

*Continued on next page...*



*Continued from previous page...*

<b>Mol</b>	<b>Chain</b>	<b>Res</b>	<b>Type</b>	<b>RSRZ</b>
3	E	678	CYS	2.7
1	A	168	LEU	2.7
1	C	658	SER	2.7
3	E	311	LEU	2.7
3	E	306	MET	2.7
3	E	466	GLU	2.7
1	D	352	ARG	2.6
5	H	523	PHE	2.6
4	G	667	ALA	2.6
1	C	255	LEU	2.6
2	B	367	ARG	2.6
1	C	598	PRO	2.6
5	H	253	SER	2.6
4	G	452	ASN	2.6
4	F	551	VAL	2.6
3	E	464	PRO	2.6
3	E	493	PHE	2.6
5	H	664	LEU	2.5
1	D	196	THR	2.5
5	H	409	GLY	2.5
1	D	237	ARG	2.5
5	H	451	LEU	2.5
1	C	299	MET	2.5
5	H	682	MET	2.5
1	D	316	LEU	2.5
1	C	260	GLN	2.5
4	F	357	TYR	2.5
4	F	635	LEU	2.5
1	D	416	VAL	2.5
1	D	431	LEU	2.4
2	B	316	LEU	2.4
3	E	661	ARG	2.4
1	C	523	PHE	2.4
1	A	508	GLN	2.4
3	E	602	ASN	2.4
5	H	498	PRO	2.4
4	G	311	LEU	2.4
1	C	622	ILE	2.4
5	H	239	ASP	2.4
4	G	339	GLY	2.4
1	A	472	VAL	2.4
1	C	276	SER	2.4

*Continued on next page...*

*Continued from previous page...*

<b>Mol</b>	<b>Chain</b>	<b>Res</b>	<b>Type</b>	<b>RSRZ</b>
4	G	664	LEU	2.4
4	F	333	VAL	2.3
4	G	361	LEU	2.3
5	H	489	VAL	2.3
1	C	196	THR	2.3
5	H	464	PRO	2.3
1	C	274	LEU	2.3
2	B	614	GLY	2.3
3	E	403	GLY	2.3
3	E	664	LEU	2.3
4	F	416	VAL	2.3
3	E	500	GLY	2.2
4	G	670	LEU	2.2
3	E	673	VAL	2.2
3	E	659	ALA	2.2
5	H	655	ASP	2.2
4	G	638	ALA	2.2
1	D	411	LEU	2.2
4	G	520	LEU	2.2
4	G	633	LEU	2.2
4	G	472	VAL	2.2
5	H	685	GLY	2.2
3	E	704	ALA	2.2
1	C	505	LEU	2.2
5	H	650	VAL	2.2
1	C	410	ASP	2.2
1	C	225	VAL	2.2
1	D	134	TRP	2.2
5	H	546	LEU	2.2
3	E	232	PHE	2.2
1	D	343	THR	2.2
3	E	695	GLU	2.2
1	D	358	GLY	2.2
4	G	533	LEU	2.1
3	E	649	VAL	2.1
1	A	467	GLN	2.1
1	A	506	VAL	2.1
1	C	424	SER	2.1
2	B	305	LEU	2.1
2	B	545	TRP	2.1
1	C	259	VAL	2.1
3	E	665	VAL	2.1

*Continued on next page...*

*Continued from previous page...*

Mol	Chain	Res	Type	RSRZ
1	D	409	GLY	2.1
4	G	463	VAL	2.1
1	C	268	LEU	2.1
1	C	162	ASN	2.1
1	D	287	LEU	2.1
1	D	359	ALA	2.1
3	E	690	ALA	2.1
3	E	401	VAL	2.1
5	H	236	LEU	2.1
1	C	573	LYS	2.1
1	D	451	LEU	2.1
3	E	608	ARG	2.1
5	H	507	GLY	2.1
3	E	445	VAL	2.1
5	H	506	VAL	2.1
4	G	331	MET	2.1
5	H	242	PHE	2.0
1	A	704	ALA	2.0
3	E	463	VAL	2.0
1	D	457	LEU	2.0
4	F	550	VAL	2.0
2	B	189	THR	2.0
1	D	325	GLU	2.0
1	D	434	GLN	2.0
1	C	635	LEU	2.0
1	A	432	PHE	2.0
1	C	451	LEU	2.0

## 6.2 Non-standard residues in protein, DNA, RNA chains [i](#)

In the following table, the Atoms column lists the number of modelled atoms in the group and the number defined in the chemical component dictionary. The B-factors column lists the minimum, median, 95<sup>th</sup> percentile and maximum values of B factors of atoms in the group. The column labelled 'Q< 0.9' lists the number of atoms with occupancy less than 0.9.

Mol	Type	Chain	Res	Atoms	RSCC	RSR	B-factors(Å <sup>2</sup> )	Q<0.9
1	YCM	C	483	10/11	0.85	0.17	169,172,178,178	0
4	YCM	G	483	10/11	0.87	0.26	105,113,114,114	0
3	YCM	E	483	10/11	0.88	0.15	159,162,171,171	0
1	YCM	A	483	10/11	0.88	0.30	116,122,125,126	0
4	YCM	G	478	10/11	0.90	0.25	93,100,118,119	0
4	YCM	F	478	10/11	0.91	0.18	93,102,124,124	0

*Continued on next page...*

Continued from previous page...

Mol	Type	Chain	Res	Atoms	RSCC	RSR	B-factors( $\text{\AA}^2$ )	Q<0.9
2	YCM	B	461	10/11	0.92	0.18	95,104,116,116	0
1	YCM	D	483	10/11	0.92	0.21	95,99,104,106	0
2	YCM	B	483	10/11	0.93	0.19	83,85,91,93	0
3	YCM	E	366	10/11	0.94	0.17	101,111,126,129	0
4	YCM	F	483	10/11	0.97	0.17	96,99,105,107	0

### 6.3 Carbohydrates [i](#)

There are no monosaccharides in this entry.

### 6.4 Ligands [i](#)

In the following table, the Atoms column lists the number of modelled atoms in the group and the number defined in the chemical component dictionary. The B-factors column lists the minimum, median, 95<sup>th</sup> percentile and maximum values of B factors of atoms in the group. The column labelled 'Q< 0.9' lists the number of atoms with occupancy less than 0.9.

Mol	Type	Chain	Res	Atoms	RSCC	RSR	B-factors( $\text{\AA}^2$ )	Q<0.9
8	Y01	G	1003	21/35	0.87	0.56	117,119,120,120	0
6	ADP	H	1001	27/27	0.88	0.24	195,196,201,201	0
8	Y01	B	1003	35/35	0.90	0.29	109,116,129,130	0
6	ADP	C	1001	27/27	0.91	0.17	151,160,165,166	0
8	Y01	D	1003	26/35	0.92	0.27	110,114,118,118	0
6	ADP	E	1001	27/27	0.92	0.26	144,153,160,160	0
7	MG	D	1002	1/1	0.93	0.26	48,48,48,48	0
6	ADP	D	1001	27/27	0.93	0.20	102,106,110,112	0
7	MG	H	1002	1/1	0.94	0.10	99,99,99,99	0
8	Y01	E	1003	28/35	0.94	0.34	102,106,116,117	0
6	ADP	G	1001	27/27	0.94	0.24	124,132,136,136	0
7	MG	C	1002	1/1	0.95	0.10	97,97,97,97	0
6	ADP	A	1001	27/27	0.95	0.21	94,105,114,114	0
6	ADP	F	1001	27/27	0.95	0.15	108,113,118,119	0
8	Y01	A	1003	30/35	0.95	0.27	96,101,115,116	0
8	Y01	F	1003	35/35	0.96	0.29	76,80,93,95	0
7	MG	G	1002	1/1	0.96	0.09	75,75,75,75	0
8	Y01	H	1003	28/35	0.96	0.23	96,100,110,112	0
6	ADP	B	1001	27/27	0.97	0.20	92,100,104,104	0
7	MG	B	1002	1/1	0.98	0.16	34,34,34,34	0
7	MG	E	1002	1/1	0.98	0.13	109,109,109,109	0
7	MG	F	1002	1/1	0.98	0.21	52,52,52,52	0
7	MG	A	1002	1/1	0.99	0.16	51,51,51,51	0

The following is a graphical depiction of the model fit to experimental electron density of all instances of the Ligand of Interest. In addition, ligands with molecular weight > 250 and outliers as shown on the geometry validation Tables will also be included. Each fit is shown from different orientation to approximate a three-dimensional view.

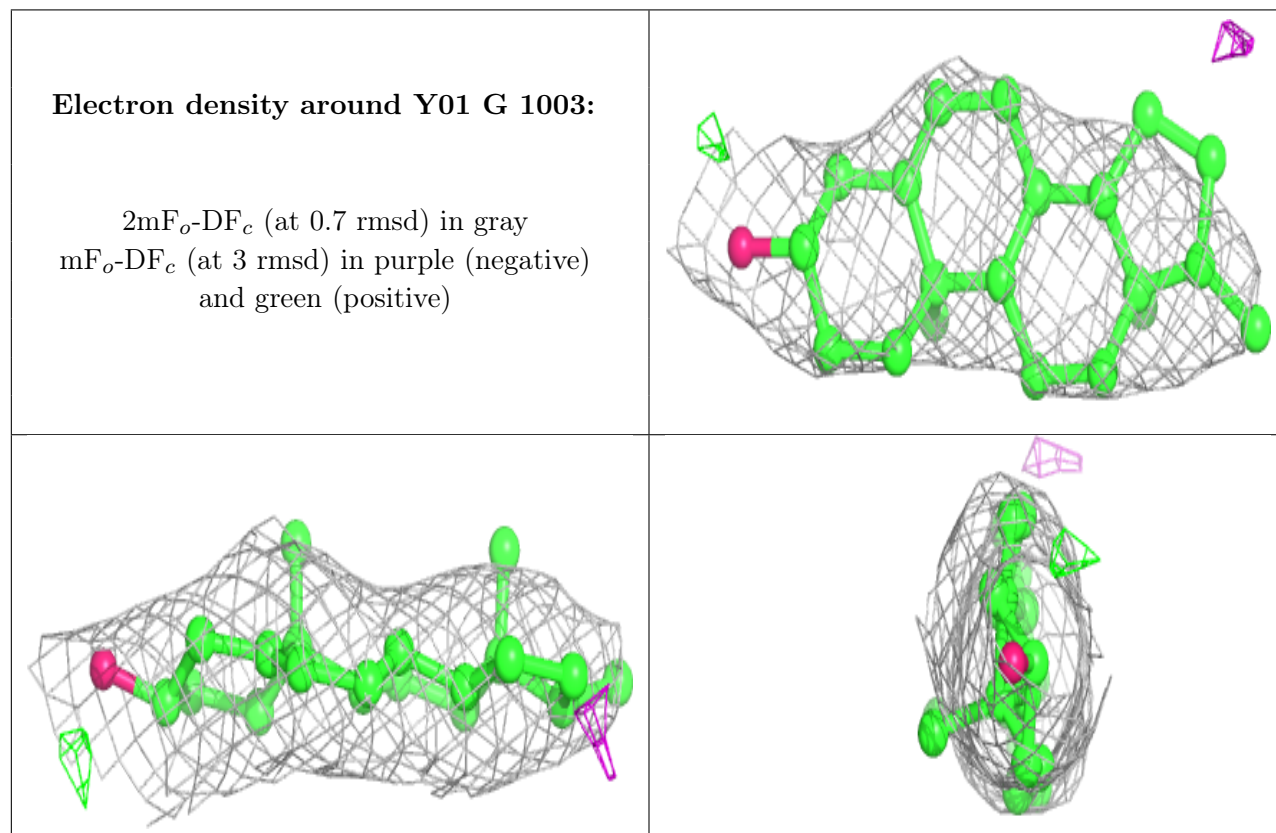

**Electron density around ADP H 1001:**

$2mF_o-DF_c$  (at 0.7 rmsd) in gray  
 $mF_o-DF_c$  (at 3 rmsd) in purple (negative)  
and green (positive)

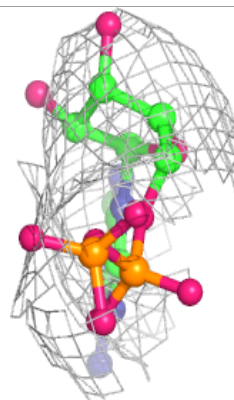
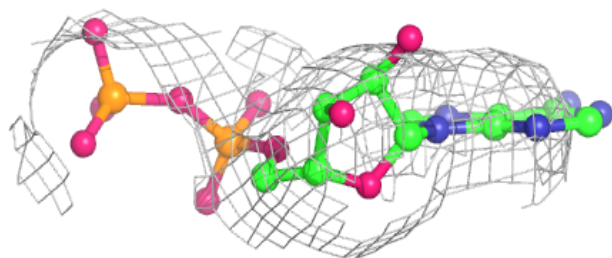
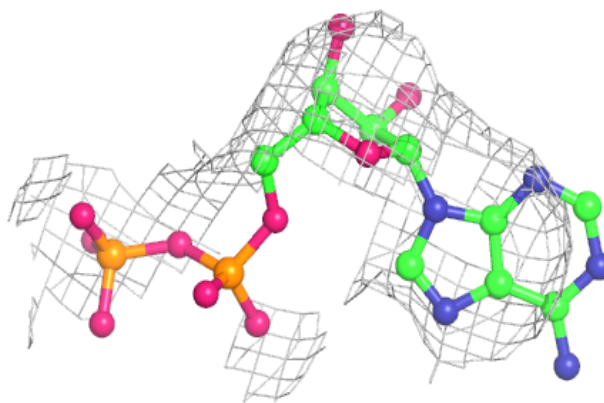
**Electron density around Y01 B 1003:**

$2mF_o-DF_c$  (at 0.7 rmsd) in gray  
 $mF_o-DF_c$  (at 3 rmsd) in purple (negative)  
and green (positive)

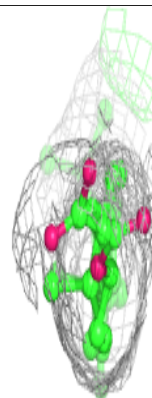
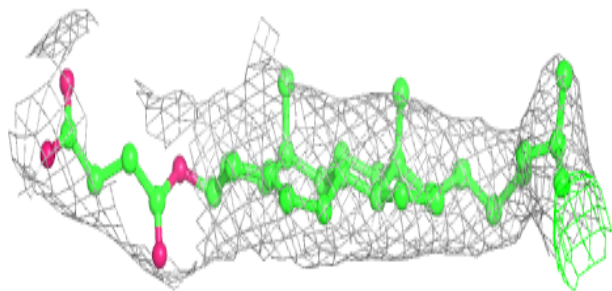
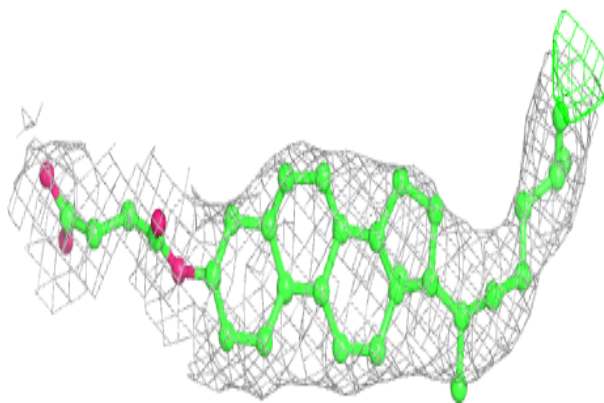

**Electron density around ADP C 1001:**

$2mF_o-DF_c$  (at 0.7 rmsd) in gray  
 $mF_o-DF_c$  (at 3 rmsd) in purple (negative)  
and green (positive)

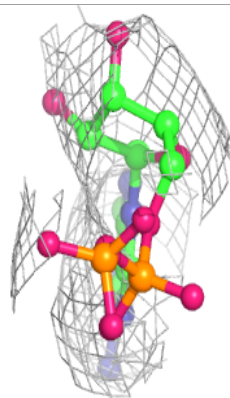
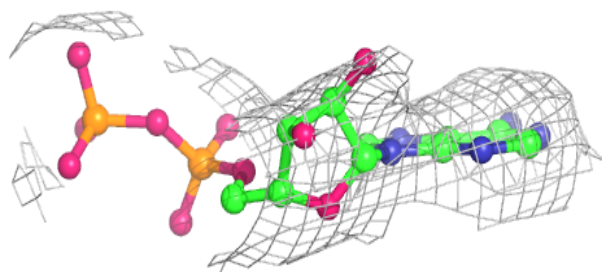
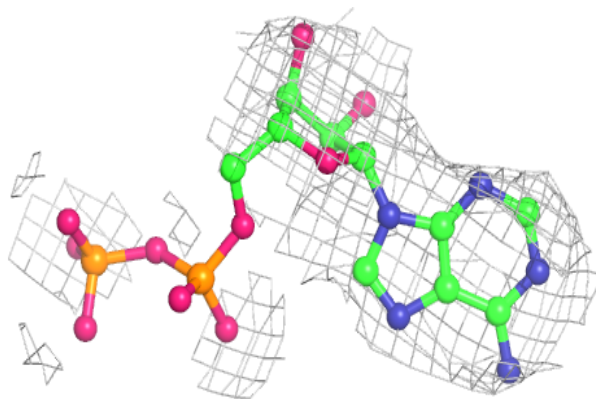
**Electron density around Y01 D 1003:**

$2mF_o-DF_c$  (at 0.7 rmsd) in gray  
 $mF_o-DF_c$  (at 3 rmsd) in purple (negative)  
and green (positive)

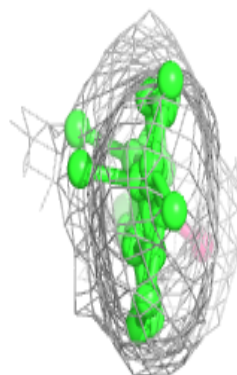
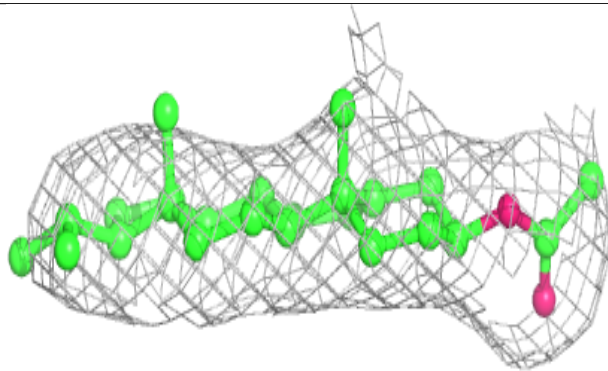
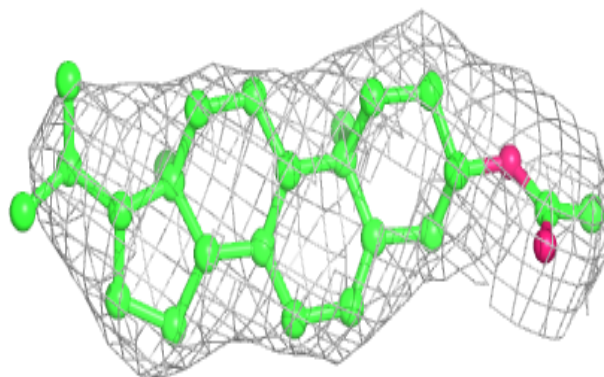

**Electron density around ADP E 1001:**

$2mF_o-DF_c$  (at 0.7 rmsd) in gray  
 $mF_o-DF_c$  (at 3 rmsd) in purple (negative)  
and green (positive)

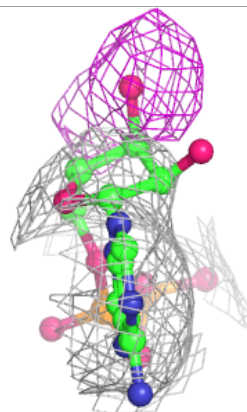
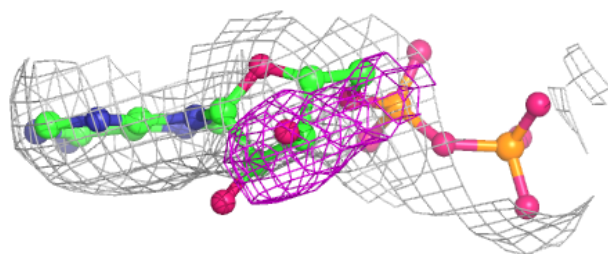
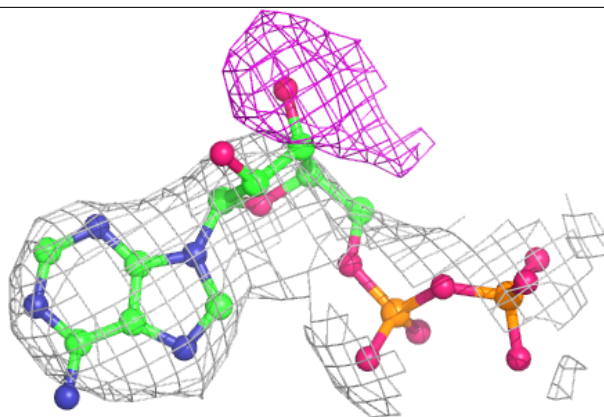
**Electron density around ADP D 1001:**

$2mF_o-DF_c$  (at 0.7 rmsd) in gray  
 $mF_o-DF_c$  (at 3 rmsd) in purple (negative)  
and green (positive)

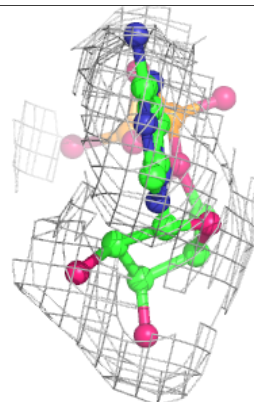
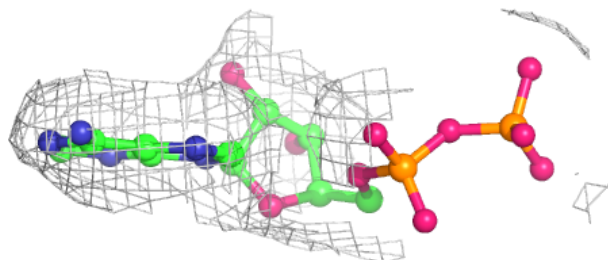
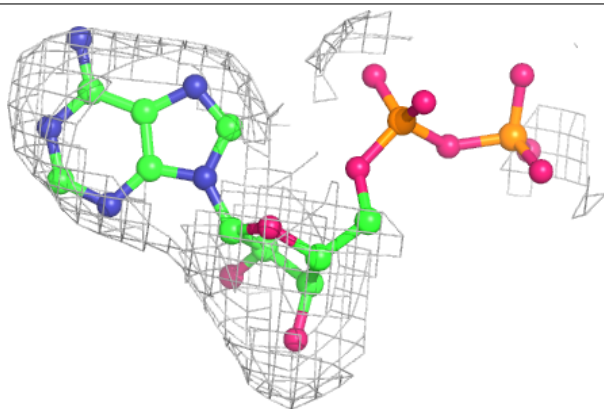



**Electron density around Y01 E 1003:**

$2mF_o-DF_c$  (at 0.7 rmsd) in gray  
 $mF_o-DF_c$  (at 3 rmsd) in purple (negative)  
and green (positive)

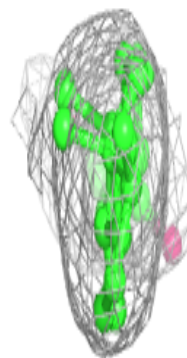
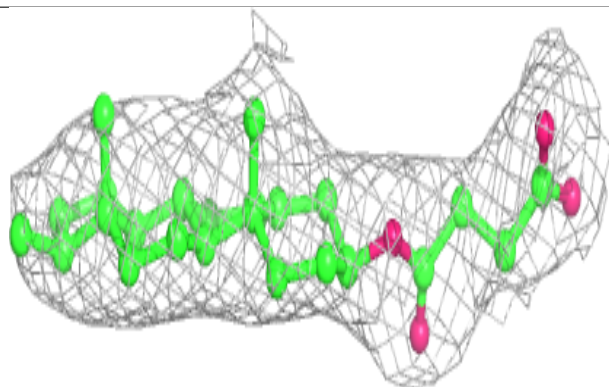
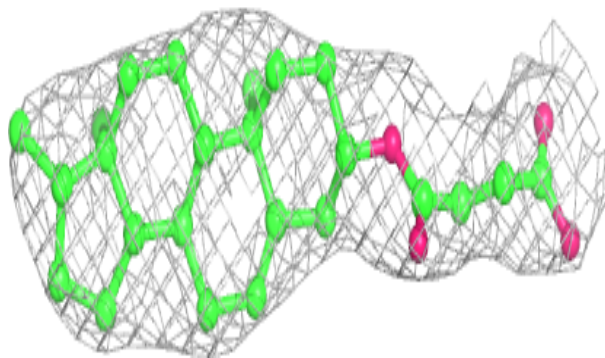
**Electron density around ADP G 1001:**

$2mF_o-DF_c$  (at 0.7 rmsd) in gray  
 $mF_o-DF_c$  (at 3 rmsd) in purple (negative)  
and green (positive)

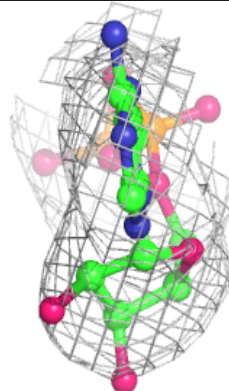
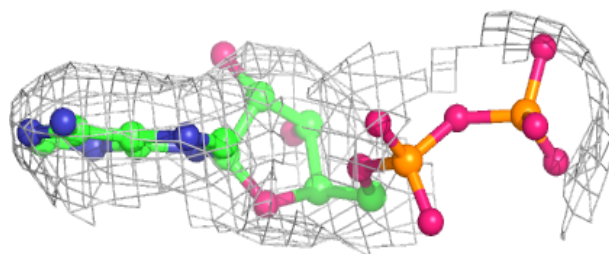
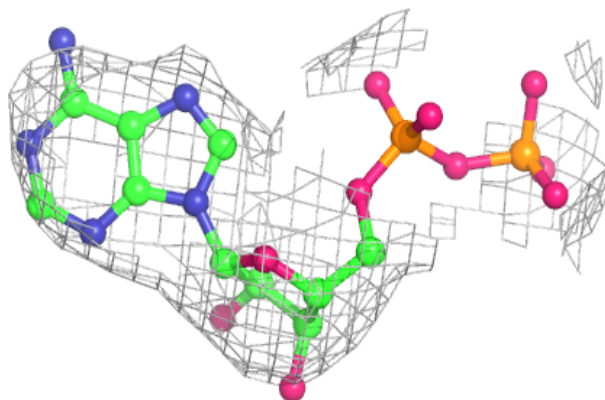

**Electron density around ADP A 1001:**

$2mF_o-DF_c$  (at 0.7 rmsd) in gray  
 $mF_o-DF_c$  (at 3 rmsd) in purple (negative)  
and green (positive)

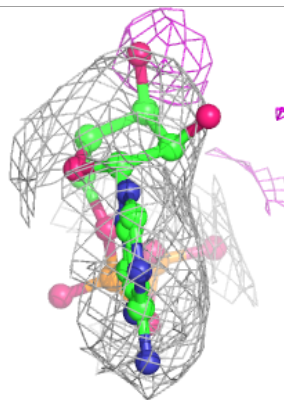
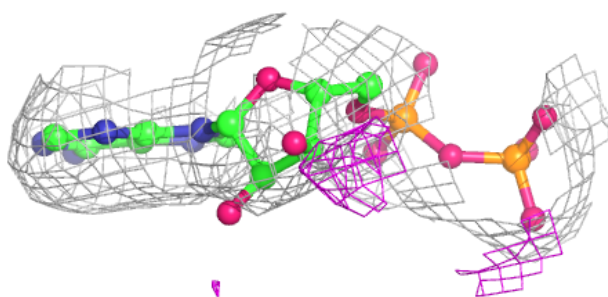
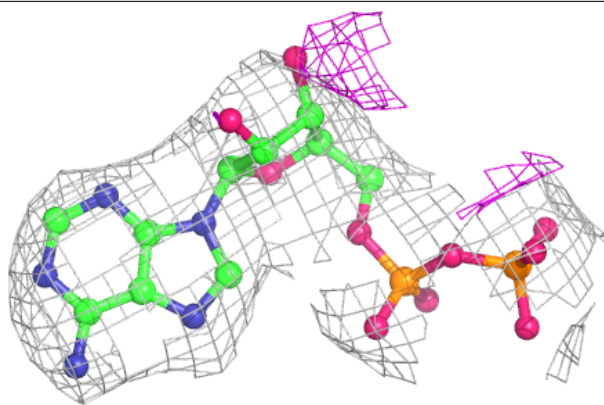
**Electron density around ADP F 1001:**

$2mF_o-DF_c$  (at 0.7 rmsd) in gray  
 $mF_o-DF_c$  (at 3 rmsd) in purple (negative)  
and green (positive)

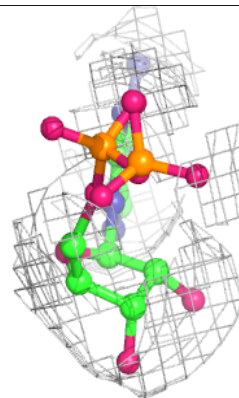
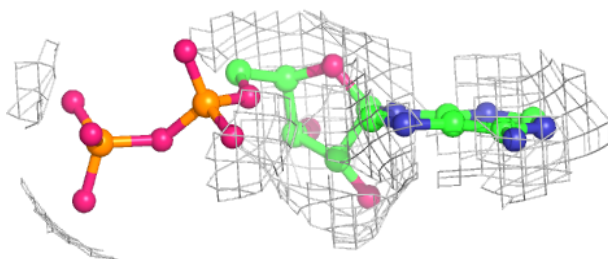
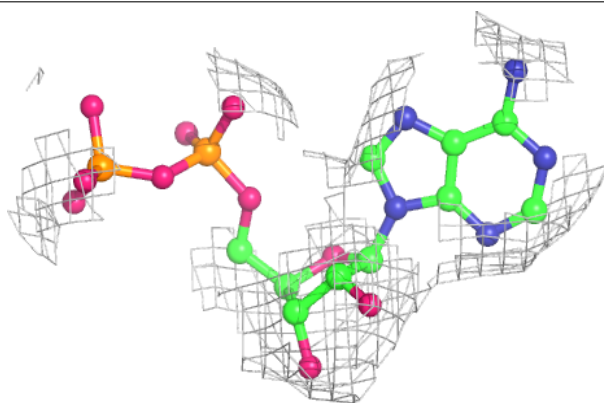

**Electron density around Y01 A 1003:**

$2mF_o-DF_c$  (at 0.7 rmsd) in gray  
 $mF_o-DF_c$  (at 3 rmsd) in purple (negative)  
and green (positive)

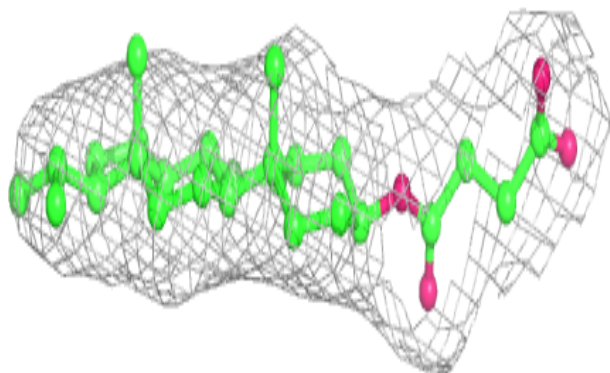
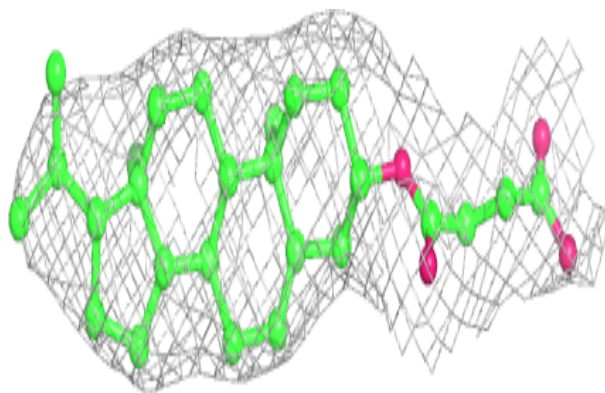
**Electron density around Y01 F 1003:**

$2mF_o-DF_c$  (at 0.7 rmsd) in gray  
 $mF_o-DF_c$  (at 3 rmsd) in purple (negative)  
and green (positive)

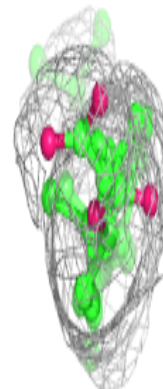
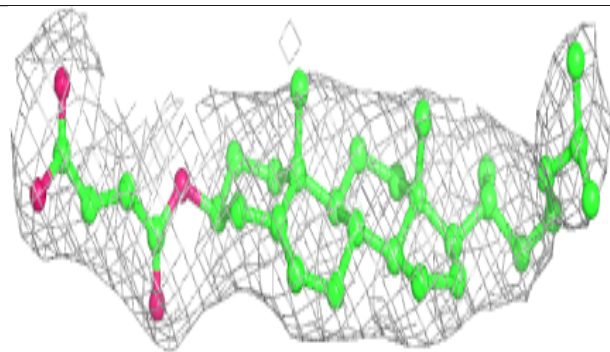
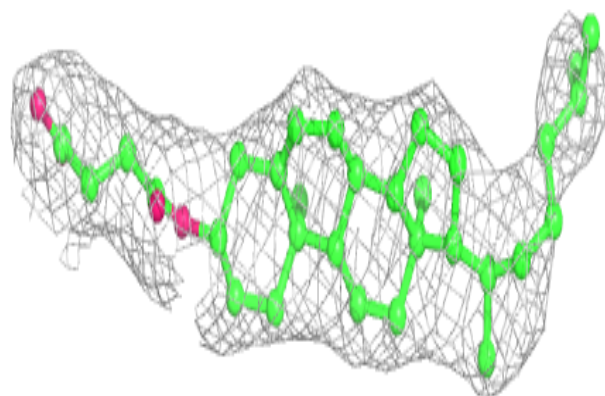

**Electron density around Y01 H 1003:**

$2mF_o-DF_c$  (at 0.7 rmsd) in gray  
 $mF_o-DF_c$  (at 3 rmsd) in purple (negative)  
and green (positive)

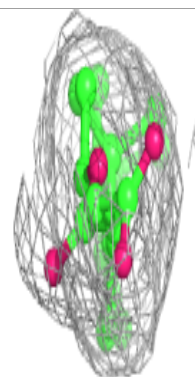
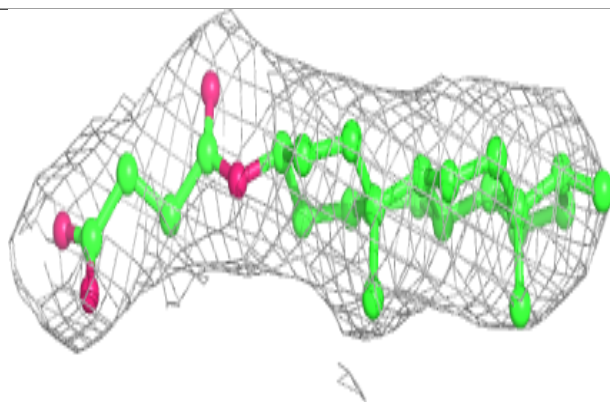
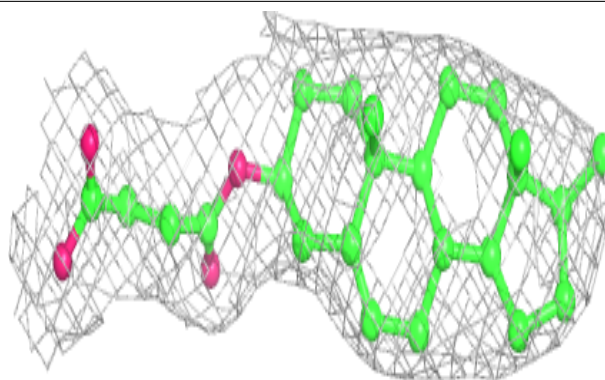
**Electron density around ADP B 1001:**

$2mF_o-DF_c$  (at 0.7 rmsd) in gray  
 $mF_o-DF_c$  (at 3 rmsd) in purple (negative)  
and green (positive)

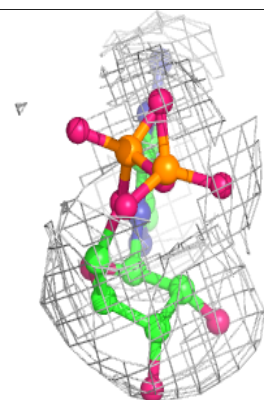
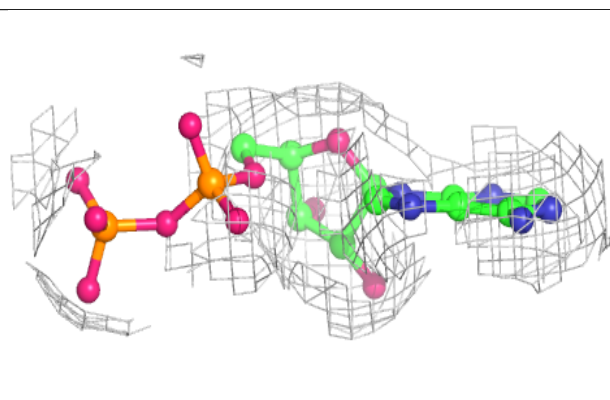
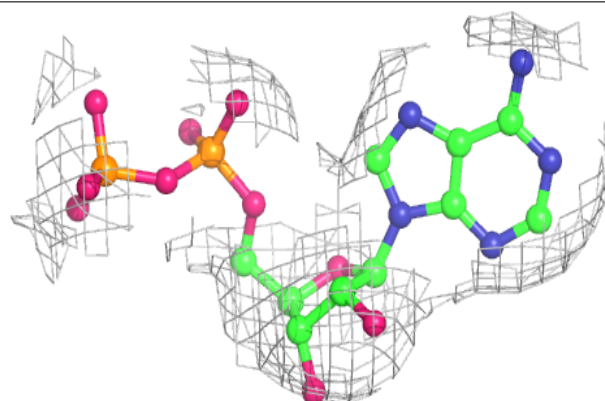

## 6.5 Other polymers [i](#)

There are no such residues in this entry.