



Full wwPDB X-ray Structure Validation Report ⓘ

May 29, 2020 – 09:15 pm BST

PDB ID : 3OM3
Title : Catalytic core subunits (I and II) of cytochrome C oxidase from *Rhodobacter sphaeroides* with K362M mutation in the reduced state
Authors : Liu, J.; Qin, L.; Ferguson-Miller, S.
Deposited on : 2010-08-26
Resolution : 2.60 Å(reported)

This is a Full wwPDB X-ray Structure Validation Report for a publicly released PDB entry.

We welcome your comments at validation@mail.wwpdb.org

A user guide is available at

<https://www.wwpdb.org/validation/2017/XrayValidationReportHelp>

with specific help available everywhere you see the ⓘ symbol.

The following versions of software and data (see [references ⓘ](#)) were used in the production of this report:

MolProbity : 4.02b-467
Mogul : 1.8.5 (274361), CSD as541be (2020)
Xtriage (Phenix) : 1.13
EDS : 2.11
buster-report : 1.1.7 (2018)
Percentile statistics : 20191225.v01 (using entries in the PDB archive December 25th 2019)
Refmac : 5.8.0158
CCP4 : 7.0.044 (Gargrove)
Ideal geometry (proteins) : Engh & Huber (2001)
Ideal geometry (DNA, RNA) : Parkinson et al. (1996)
Validation Pipeline (wwPDB-VP) : 2.11

1 Overall quality at a glance

The following experimental techniques were used to determine the structure:

X-RAY DIFFRACTION

The reported resolution of this entry is 2.60 Å.

Percentile scores (ranging between 0-100) for global validation metrics of the entry are shown in the following graphic. The table shows the number of entries on which the scores are based.

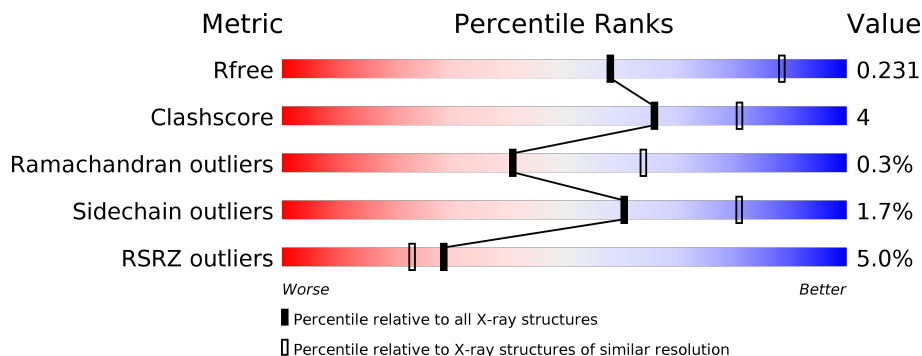

Metric	Whole archive (#Entries)	Similar resolution (#Entries, resolution range(Å))
R_{free}	130704	3163 (2.60-2.60)
Clashscore	141614	3518 (2.60-2.60)
Ramachandran outliers	138981	3455 (2.60-2.60)
Sidechain outliers	138945	3455 (2.60-2.60)
RSRZ outliers	127900	3104 (2.60-2.60)

The table below summarises the geometric issues observed across the polymeric chains and their fit to the electron density. The red, orange, yellow and green segments on the lower bar indicate the fraction of residues that contain outliers for ≥ 3 , 2, 1 and 0 types of geometric quality criteria respectively. A grey segment represents the fraction of residues that are not modelled. The numeric value for each fraction is indicated below the corresponding segment, with a dot representing fractions $\leq 5\%$. The upper red bar (where present) indicates the fraction of residues that have poor fit to the electron density. The numeric value is given above the bar.

Mol	Chain	Length	Quality of chain
1	A	535	<p>4% 88% 11%</p>
1	C	535	<p>8% 87% 12%</p>
2	B	256	<p>3% 93% 7%</p>
2	D	256	<p>3% 91% 8%</p>

The following table lists non-polymeric compounds, carbohydrate monomers and non-standard residues in protein, DNA, RNA chains that are outliers for geometric or electron-density-fit crite-

ria:

Mol	Type	Chain	Res	Chirality	Geometry	Clashes	Electron density
3	DMU	C	9	X	-	-	-
5	HEA	A	1	X	-	-	-
5	HEA	A	2	X	-	-	-
5	HEA	C	1	X	-	-	-
5	HEA	C	2	X	-	-	-

2 Entry composition [i](#)

There are 11 unique types of molecules in this entry. The entry contains 13203 atoms, of which 0 are hydrogens and 0 are deuteriums.

In the tables below, the ZeroOcc column contains the number of atoms modelled with zero occupancy, the AltConf column contains the number of residues with at least one atom in alternate conformation and the Trace column contains the number of residues modelled with at most 2 atoms.

- Molecule 1 is a protein called Cytochrome c oxidase, aa3 type, subunit I.

Mol	Chain	Residues	Atoms					ZeroOcc	AltConf	Trace
			Total	C	N	O	S			
1	A	535	Total	C	N	O	S	0	0	0
			4166	2790	655	689	32			
1	C	531	Total	C	N	O	S	0	0	0
			4095	2742	638	685	30			

There are 2 discrepancies between the modelled and reference sequences:

Chain	Residue	Modelled	Actual	Comment	Reference
A	362	MET	LYS	ENGINEERED MUTATION	UNP Q3J5A7
C	362	MET	LYS	ENGINEERED MUTATION	UNP Q3J5A7

- Molecule 2 is a protein called Cytochrome c oxidase subunit 2.

Mol	Chain	Residues	Atoms					ZeroOcc	AltConf	Trace
			Total	C	N	O	S			
2	B	256	Total	C	N	O	S	0	0	0
			2014	1314	332	362	6			
2	D	256	Total	C	N	O	S	0	0	0
			2013	1313	331	363	6			

There are 8 discrepancies between the modelled and reference sequences:

Chain	Residue	Modelled	Actual	Comment	Reference
B	282	HIS	-	EXPRESSION TAG	UNP Q3J5G0
B	283	HIS	-	EXPRESSION TAG	UNP Q3J5G0
B	284	HIS	-	EXPRESSION TAG	UNP Q3J5G0
B	285	HIS	-	EXPRESSION TAG	UNP Q3J5G0
D	282	HIS	-	EXPRESSION TAG	UNP Q3J5G0
D	283	HIS	-	EXPRESSION TAG	UNP Q3J5G0
D	284	HIS	-	EXPRESSION TAG	UNP Q3J5G0
D	285	HIS	-	EXPRESSION TAG	UNP Q3J5G0

- Molecule 3 is DECYL-BETA-D-MALTOPYRANOSIDE (three-letter code: DMU) (formula:

C₂₂H₄₂O₁₁).

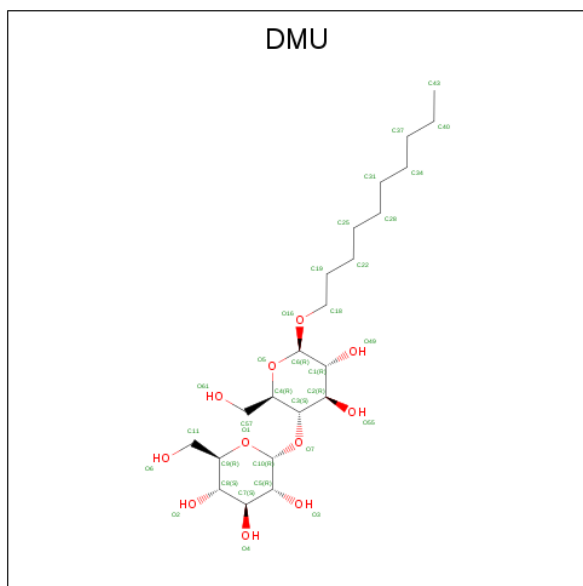

Mol	Chain	Residues	Atoms			ZeroOcc	AltConf
3	A	1	Total	C	O	0	0
			22	16	6		
3	A	1	Total	C	O	0	0
			22	16	6		
3	B	1	Total	C	O	0	0
			33	22	11		
3	B	1	Total	C	O	0	0
			33	22	11		
3	B	1	Total	C	O	0	0
			23	12	11		
3	C	1	Total	C	O	0	0
			33	22	11		
3	C	1	Total	C	O	0	0
			23	12	11		
3	C	1	Total	C	O	0	0
			12	6	6		
3	D	1	Total	C	O	0	0
			23	12	11		
3	D	1	Total	C	O	0	0
			23	12	11		

- Molecule 4 is TRIDECANE (three-letter code: TRD) (formula: C₁₃H₂₈).

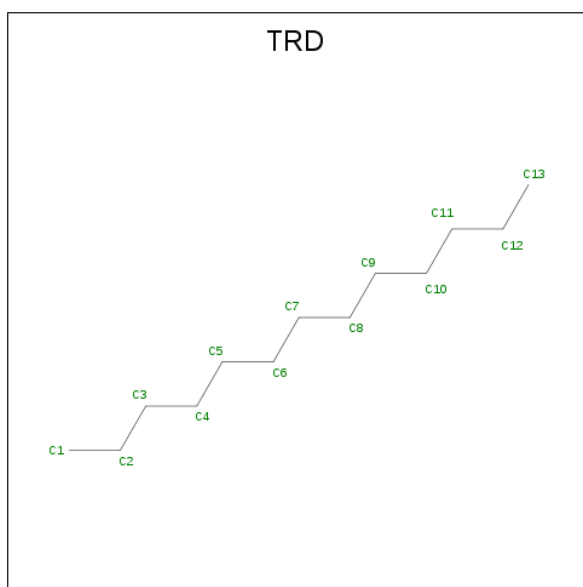

Mol	Chain	Residues	Atoms	ZeroOcc	AltConf
4	A	1	Total C 7 7	0	0
4	A	1	Total C 7 7	0	0
4	A	1	Total C 7 7	0	0
4	A	1	Total C 13 13	0	0
4	A	1	Total C 13 13	0	0
4	B	1	Total C 9 9	0	0
4	C	1	Total C 13 13	0	0
4	C	1	Total C 13 13	0	0
4	D	1	Total C 7 7	0	0

- Molecule 5 is HEME-A (three-letter code: HEA) (formula: $C_{49}H_{56}FeN_4O_6$).

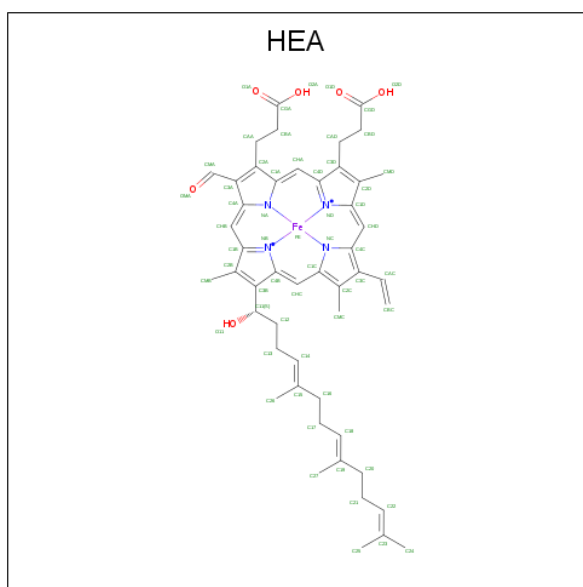

Mol	Chain	Residues	Atoms				ZeroOcc	AltConf	
			Total	C	Fe	N			O
5	A	1	Total	C	Fe	N	O	0	0
			60	49	1	4	6		
5	A	1	Total	C	Fe	N	O	0	0
			60	49	1	4	6		
5	C	1	Total	C	Fe	N	O	0	0
			60	49	1	4	6		
5	C	1	Total	C	Fe	N	O	0	0
			60	49	1	4	6		

- Molecule 6 is COPPER (I) ION (three-letter code: CU1) (formula: Cu).

Mol	Chain	Residues	Atoms		ZeroOcc	AltConf
			Total	Cu		
6	B	2	Total	Cu	0	0
			2	2		
6	A	1	Total	Cu	0	0
			1	1		
6	D	2	Total	Cu	0	0
			2	2		
6	C	1	Total	Cu	0	0
			1	1		

- Molecule 7 is MAGNESIUM ION (three-letter code: MG) (formula: Mg).

Mol	Chain	Residues	Atoms		ZeroOcc	AltConf
			Total	Mg		
7	A	1	Total	Mg	0	0
			1	1		

Continued on next page...

Continued from previous page...

Mol	Chain	Residues	Atoms	ZeroOcc	AltConf
7	C	1	Total Mg 1 1	0	0

- Molecule 8 is CALCIUM ION (three-letter code: CA) (formula: Ca).

Mol	Chain	Residues	Atoms	ZeroOcc	AltConf
8	A	1	Total Ca 1 1	0	0
8	C	1	Total Ca 1 1	0	0

- Molecule 9 is (2S,3R)-heptane-1,2,3-triol (three-letter code: HTH) (formula: C₇H₁₆O₃).

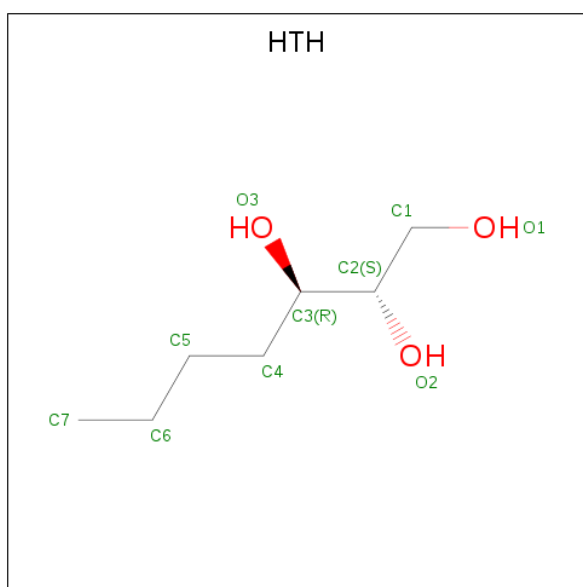

Mol	Chain	Residues	Atoms	ZeroOcc	AltConf
9	B	1	Total C O 10 7 3	0	0

- Molecule 10 is CADMIUM ION (three-letter code: CD) (formula: Cd).

Mol	Chain	Residues	Atoms	ZeroOcc	AltConf
10	B	2	Total Cd 2 2	0	0
10	D	2	Total Cd 2 2	0	0

- Molecule 11 is water.

Mol	Chain	Residues	Atoms		ZeroOcc	AltConf
11	A	91	Total 91	O 91	0	0
11	B	91	Total 91	O 91	0	0
11	C	46	Total 46	O 46	0	0
11	D	54	Total 54	O 54	0	0

3 Residue-property plots [i](#)

These plots are drawn for all protein, RNA and DNA chains in the entry. The first graphic for a chain summarises the proportions of the various outlier classes displayed in the second graphic. The second graphic shows the sequence view annotated by issues in geometry and electron density. Residues are color-coded according to the number of geometric quality criteria for which they contain at least one outlier: green = 0, yellow = 1, orange = 2 and red = 3 or more. A red dot above a residue indicates a poor fit to the electron density ($RSRZ > 2$). Stretches of 2 or more consecutive residues without any outlier are shown as a green connector. Residues present in the sample, but not in the model, are shown in grey.

- Molecule 1: Cytochrome c oxidase, aa3 type, subunit I

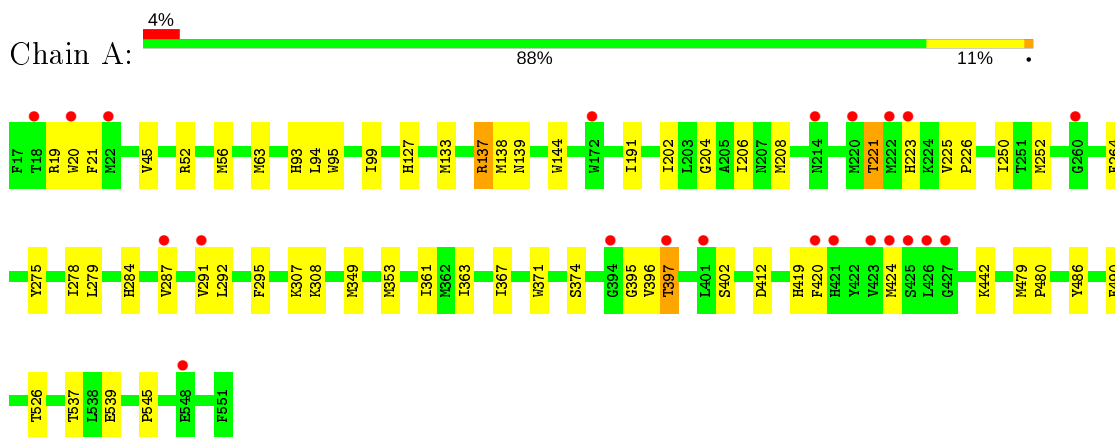

- Molecule 1: Cytochrome c oxidase, aa3 type, subunit I

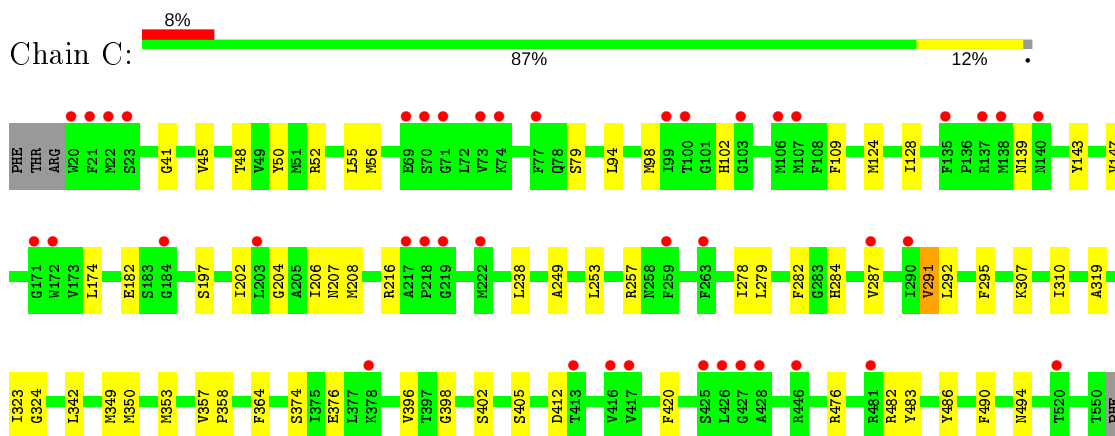

- Molecule 2: Cytochrome c oxidase subunit 2

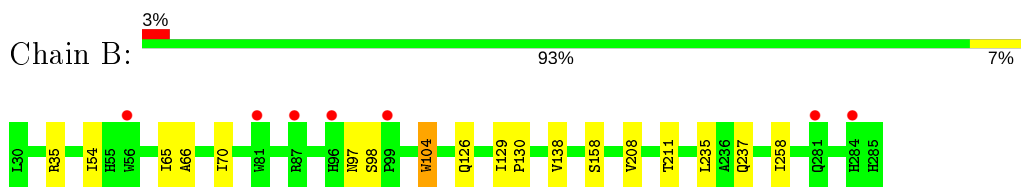

- Molecule 2: Cytochrome c oxidase subunit 2

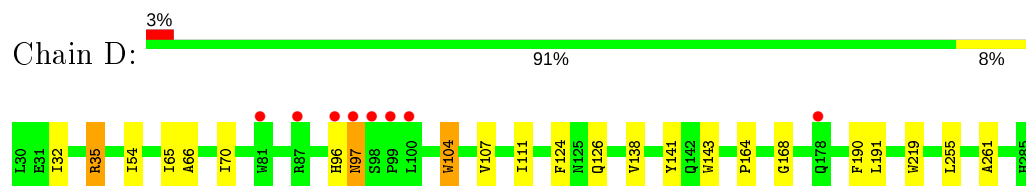

4 Data and refinement statistics

Property	Value	Source
Space group	P 21 21 21	Depositor
Cell constants a, b, c, α , β , γ	124.65Å 132.37Å 178.01Å 90.00° 90.00° 90.00°	Depositor
Resolution (Å)	40.46 – 2.60 40.46 – 2.60	Depositor EDS
% Data completeness (in resolution range)	95.7 (40.46-2.60) 95.7 (40.46-2.60)	Depositor EDS
R_{merge}	0.06	Depositor
R_{sym}	(Not available)	Depositor
$\langle I/\sigma(I) \rangle$ ¹	4.08 (at 2.61Å)	Xtrriage
Refinement program	REFMAC	Depositor
R, R_{free}	0.198 , 0.229 0.199 , 0.231	Depositor DCC
R_{free} test set	2630 reflections (3.02%)	wwPDB-VP
Wilson B-factor (Å ²)	54.3	Xtrriage
Anisotropy	0.034	Xtrriage
Bulk solvent k_{sol} (e/Å ³), B_{sol} (Å ²)	0.33 , 52.7	EDS
L-test for twinning ²	$\langle L \rangle = 0.50$, $\langle L^2 \rangle = 0.33$	Xtrriage
Estimated twinning fraction	No twinning to report.	Xtrriage
F_o, F_c correlation	0.94	EDS
Total number of atoms	13203	wwPDB-VP
Average B, all atoms (Å ²)	55.0	wwPDB-VP

Xtrriage's analysis on translational NCS is as follows: *The largest off-origin peak in the Patterson function is 3.34% of the height of the origin peak. No significant pseudotranslation is detected.*

¹Intensities estimated from amplitudes.

²Theoretical values of $\langle |L| \rangle$, $\langle L^2 \rangle$ for acentric reflections are 0.5, 0.333 respectively for untwinned datasets, and 0.375, 0.2 for perfectly twinned datasets.

5 Model quality [i](#)

5.1 Standard geometry [i](#)

Bond lengths and bond angles in the following residue types are not validated in this section: MG, CU1, CA, TRD, CD, DMU, HTH, HEA

The Z score for a bond length (or angle) is the number of standard deviations the observed value is removed from the expected value. A bond length (or angle) with $|Z| > 5$ is considered an outlier worth inspection. RMSZ is the root-mean-square of all Z scores of the bond lengths (or angles).

Mol	Chain	Bond lengths		Bond angles	
		RMSZ	# Z >5	RMSZ	# Z >5
1	A	0.52	0/4320	0.56	0/5902
1	C	0.47	0/4244	0.52	0/5803
2	B	0.51	0/2076	0.57	0/2843
2	D	0.47	0/2074	0.51	0/2840
All	All	0.49	0/12714	0.54	0/17388

There are no bond length outliers.

There are no bond angle outliers.

There are no chirality outliers.

There are no planarity outliers.

5.2 Too-close contacts [i](#)

In the following table, the Non-H and H(model) columns list the number of non-hydrogen atoms and hydrogen atoms in the chain respectively. The H(added) column lists the number of hydrogen atoms added and optimized by MolProbity. The Clashes column lists the number of clashes within the asymmetric unit, whereas Symm-Clashes lists symmetry related clashes.

Mol	Chain	Non-H	H(model)	H(added)	Clashes	Symm-Clashes
1	A	4166	0	4051	39	0
1	C	4095	0	3967	39	0
2	B	2014	0	1963	10	0
2	D	2013	0	1964	17	0
3	A	44	0	62	1	0
3	B	122	0	147	0	0
3	C	68	0	74	1	0
3	D	46	0	42	1	0
4	A	47	0	92	0	0

Continued on next page...

Continued from previous page...

Mol	Chain	Non-H	H(model)	H(added)	Clashes	Symm-Clashes
4	B	9	0	17	0	0
4	C	26	0	56	1	0
4	D	7	0	13	0	0
5	A	120	0	108	10	0
5	C	120	0	108	7	0
6	A	1	0	0	0	0
6	B	2	0	0	0	0
6	C	1	0	0	0	0
6	D	2	0	0	0	0
7	A	1	0	0	0	0
7	C	1	0	0	0	0
8	A	1	0	0	0	0
8	C	1	0	0	0	0
9	B	10	0	16	0	0
10	B	2	0	0	0	0
10	D	2	0	0	0	0
11	A	91	0	0	0	0
11	B	91	0	0	0	0
11	C	46	0	0	0	0
11	D	54	0	0	0	0
All	All	13203	0	12680	103	0

The all-atom clashscore is defined as the number of clashes found per 1000 atoms (including hydrogen atoms). The all-atom clashscore for this structure is 4.

All (103) close contacts within the same asymmetric unit are listed below, sorted by their clash magnitude.

Atom-1	Atom-2	Interatomic distance (Å)	Clash overlap (Å)
1:A:21:PHE:HB3	1:A:144:TRP:HZ2	1.35	0.89
5:C:1:HEA:HBC1	5:C:1:HEA:HMC1	1.54	0.87
1:A:21:PHE:HB3	1:A:144:TRP:CZ2	2.21	0.75
5:A:2:HEA:HMD1	5:A:2:HEA:HBD2	1.68	0.75
2:B:66:ALA:O	2:B:70:ILE:HG12	1.88	0.74
1:A:138:MET:HE3	1:A:206:ILE:HB	1.71	0.72
1:C:56:MET:HE1	3:C:10:DMU:H6	1.72	0.71
1:A:397:THR:CG2	1:A:419:HIS:HB2	2.20	0.70
5:A:1:HEA:HBC1	5:A:1:HEA:HMC1	1.73	0.68
2:B:54:ILE:HD11	2:B:126:GLN:NE2	2.11	0.66
1:A:396:VAL:HB	2:B:65:ILE:HB	1.81	0.63
1:A:204:GLY:O	1:A:208:MET:HG2	2.02	0.60
1:C:319:ALA:O	1:C:323:ILE:HG12	2.02	0.60

Continued on next page...

Continued from previous page...

Atom-1	Atom-2	Interatomic distance (Å)	Clash overlap (Å)
1:A:284:HIS:CD2	1:A:284:HIS:C	2.76	0.59
1:A:138:MET:CE	1:A:206:ILE:HB	2.33	0.58
1:A:397:THR:HG22	1:A:419:HIS:ND1	2.19	0.58
1:A:397:THR:HG22	1:A:419:HIS:HD1	1.69	0.57
1:A:56:MET:HE1	3:A:1005:DMU:H6	1.86	0.57
1:C:204:GLY:O	1:C:208:MET:HG2	2.05	0.56
2:D:66:ALA:O	2:D:70:ILE:HG12	2.05	0.56
1:A:307:LYS:HE2	1:A:374:SER:HB3	1.88	0.55
2:D:32:ILE:HG22	2:D:35:ARG:HD2	1.88	0.55
1:C:405:SER:O	2:D:54:ILE:HD12	2.07	0.53
1:C:287:VAL:HB	5:C:2:HEA:HAC	1.91	0.53
1:C:50:TYR:OH	1:C:79:SER:HB2	2.08	0.53
2:D:54:ILE:HD11	2:D:126:GLN:NE2	2.24	0.53
1:A:287:VAL:HB	5:A:2:HEA:HAC	1.91	0.52
1:C:396:VAL:HB	2:D:65:ILE:HB	1.91	0.52
1:A:221:THR:HG22	1:A:223:HIS:H	1.74	0.52
1:C:253:LEU:O	1:C:257:ARG:HG3	2.10	0.52
1:A:45:VAL:HG21	5:A:1:HEA:H171	1.93	0.51
1:A:63:MET:HG2	1:A:94:LEU:HD23	1.91	0.51
3:D:8:DMU:H35	3:D:8:DMU:H29	1.91	0.50
1:A:397:THR:HG21	1:A:419:HIS:HB2	1.92	0.50
2:B:211:THR:HB	2:B:235:LEU:HD12	1.92	0.49
1:A:402:SER:HA	5:A:2:HEA:OMA	2.12	0.49
1:A:442:LYS:O	1:A:545:PRO:HA	2.13	0.49
1:C:402:SER:HA	5:C:2:HEA:OMA	2.12	0.48
2:D:104:TRP:CD1	2:D:104:TRP:C	2.86	0.48
1:C:349:MET:O	1:C:353:MET:HG3	2.13	0.48
1:A:291:VAL:HG13	5:A:2:HEA:HBC2	1.96	0.48
1:C:350:MET:HG2	1:C:353:MET:CE	2.44	0.48
1:A:292:LEU:O	1:A:295:PHE:HB2	2.14	0.47
2:B:129:ILE:HD13	2:B:237:GLN:HB2	1.96	0.47
1:C:342:LEU:HD21	2:D:124:PHE:CD2	2.49	0.47
1:C:349:MET:HG3	1:C:402:SER:O	2.13	0.47
2:D:107:VAL:O	2:D:111:ILE:HG12	2.14	0.47
1:C:476:ARG:HH21	4:C:3:TRD:H21	1.80	0.47
1:C:94:LEU:O	1:C:98:MET:HG2	2.15	0.47
1:C:284:HIS:CD2	1:C:284:HIS:C	2.88	0.47
2:D:138:VAL:HG11	2:D:219:TRP:CD1	2.50	0.47
1:C:249:ALA:HB2	1:C:278:ILE:HG22	1.97	0.46
5:A:2:HEA:H212	5:A:2:HEA:H18	1.62	0.46
1:A:95:TRP:CZ2	1:A:99:ILE:HD11	2.51	0.46

Continued on next page...

Continued from previous page...

Atom-1	Atom-2	Interatomic distance (Å)	Clash overlap (Å)
1:C:48:THR:CG2	1:C:102:HIS:CE1	3.00	0.45
1:C:420:PHE:HB2	5:C:2:HEA:HMD3	1.97	0.45
2:D:190:PHE:O	2:D:191:LEU:HB2	2.17	0.45
2:D:141:TYR:O	2:D:143:TRP:HA	2.16	0.45
2:D:96:HIS:O	2:D:97:ASN:HB2	2.16	0.45
1:C:109:PHE:CE1	1:C:197:SER:HB2	2.51	0.45
2:D:164:PRO:HA	2:D:168:GLY:O	2.17	0.45
2:B:129:ILE:HA	2:B:130:PRO:HD3	1.82	0.44
1:A:93:HIS:N	2:B:258:ILE:HG13	2.32	0.44
1:A:264:PHE:CE1	1:A:275:TYR:HB2	2.53	0.44
1:C:55:LEU:O	1:C:494:ASN:HB3	2.17	0.44
1:A:191:ILE:HG23	1:A:250:ILE:HD12	2.00	0.44
2:B:138:VAL:HG23	2:B:208:VAL:HG13	1.98	0.44
1:C:143:TYR:O	1:C:147:VAL:HG23	2.18	0.44
1:C:41:GLY:O	1:C:45:VAL:HG23	2.18	0.44
2:B:104:TRP:CD1	2:B:104:TRP:C	2.92	0.43
1:A:349:MET:HG2	1:A:353:MET:HE2	2.00	0.43
1:C:292:LEU:O	1:C:295:PHE:HB2	2.18	0.43
1:A:424:MET:HE2	5:A:2:HEA:HMD3	2.00	0.43
1:C:139:ASN:HB2	1:C:207:ASN:ND2	2.33	0.43
1:A:486:TYR:CD2	1:A:490:PHE:HB2	2.53	0.43
2:B:54:ILE:HD11	2:B:126:GLN:HE21	1.83	0.43
1:A:252:MET:HE1	1:A:278:ILE:HD13	2.01	0.42
1:C:398:GLY:O	5:C:2:HEA:HMB3	2.19	0.42
1:C:48:THR:O	1:C:52:ARG:HG2	2.19	0.42
2:D:35:ARG:HG2	2:D:35:ARG:O	2.17	0.42
1:C:238:LEU:HD21	1:C:324:GLY:CA	2.49	0.42
1:C:124:MET:O	1:C:128:ILE:HG12	2.20	0.41
1:C:486:TYR:CD2	1:C:490:PHE:HB2	2.56	0.41
1:C:357:VAL:HB	1:C:358:PRO:CD	2.50	0.41
1:A:202:ILE:O	1:A:206:ILE:HG12	2.20	0.41
1:A:479:MET:HA	1:A:480:PRO:HD3	1.89	0.41
1:C:291:VAL:HG13	5:C:2:HEA:HBC2	2.02	0.41
1:A:420:PHE:HB2	5:A:2:HEA:HMD3	2.03	0.41
1:C:202:ILE:O	1:C:206:ILE:HG12	2.20	0.41
1:A:225:VAL:HA	1:A:226:PRO:HD3	1.96	0.41
1:A:537:THR:OG1	1:A:539:GLU:OE1	2.32	0.41
1:C:182:GLU:O	1:C:257:ARG:NH1	2.53	0.41
1:A:308:LYS:HE3	1:A:371:TRP:O	2.21	0.41
1:C:128:ILE:HB	1:C:216:ARG:HG2	2.03	0.40
1:C:482:ARG:HD3	2:D:255:LEU:HB2	2.03	0.40

Continued on next page...

Continued from previous page...

Atom-1	Atom-2	Interatomic distance (Å)	Clash overlap (Å)
1:C:483:TYR:CZ	2:D:261:ALA:HA	2.56	0.40
1:A:363:ILE:O	1:A:367:ILE:HG13	2.21	0.40
1:C:307:LYS:HE2	1:C:374:SER:HB3	2.02	0.40
1:A:133:MET:HG3	1:A:139:ASN:ND2	2.36	0.40
1:A:395:GLY:HA3	5:A:2:HEA:C15	2.52	0.40
5:C:2:HEA:H18	5:C:2:HEA:H212	1.54	0.40
1:A:137:ARG:HB2	1:A:137:ARG:HE	1.80	0.40
1:C:364:PHE:HB3	2:D:104:TRP:CE3	2.57	0.40

There are no symmetry-related clashes.

5.3 Torsion angles [i](#)

5.3.1 Protein backbone [i](#)

In the following table, the Percentiles column shows the percent Ramachandran outliers of the chain as a percentile score with respect to all X-ray entries followed by that with respect to entries of similar resolution.

The Analysed column shows the number of residues for which the backbone conformation was analysed, and the total number of residues.

Mol	Chain	Analysed	Favoured	Allowed	Outliers	Percentiles	
1	A	533/535 (100%)	513 (96%)	18 (3%)	2 (0%)	34	57
1	C	529/535 (99%)	513 (97%)	16 (3%)	0	100	100
2	B	254/256 (99%)	244 (96%)	9 (4%)	1 (0%)	34	57
2	D	254/256 (99%)	245 (96%)	8 (3%)	1 (0%)	34	57
All	All	1570/1582 (99%)	1515 (96%)	51 (3%)	4 (0%)	41	64

All (4) Ramachandran outliers are listed below:

Mol	Chain	Res	Type
1	A	19	ARG
1	A	20	TRP
2	D	97	ASN
2	B	97	ASN

5.3.2 Protein sidechains [i](#)

In the following table, the Percentiles column shows the percent sidechain outliers of the chain as a percentile score with respect to all X-ray entries followed by that with respect to entries of similar resolution.

The Analysed column shows the number of residues for which the sidechain conformation was analysed, and the total number of residues.

Mol	Chain	Analysed	Rotameric	Outliers	Percentiles	
1	A	424/435 (98%)	415 (98%)	9 (2%)	53	77
1	C	415/435 (95%)	408 (98%)	7 (2%)	60	81
2	B	212/215 (99%)	208 (98%)	4 (2%)	57	79
2	D	212/215 (99%)	210 (99%)	2 (1%)	78	91
All	All	1263/1300 (97%)	1241 (98%)	22 (2%)	60	81

All (22) residues with a non-rotameric sidechain are listed below:

Mol	Chain	Res	Type
1	A	52	ARG
1	A	127	HIS
1	A	137	ARG
1	A	221	THR
1	A	279	LEU
1	A	361	ILE
1	A	397	THR
1	A	412	ASP
1	A	526	THR
2	B	35	ARG
2	B	98	SER
2	B	104	TRP
2	B	158	SER
1	C	174	LEU
1	C	279	LEU
1	C	282	PHE
1	C	291	VAL
1	C	310	ILE
1	C	376	GLU
1	C	412	ASP
2	D	35	ARG
2	D	104	TRP

Some sidechains can be flipped to improve hydrogen bonding and reduce clashes. All (1) such sidechains are listed below:

Mol	Chain	Res	Type
1	A	447	GLN

5.3.3 RNA [i](#)

There are no RNA molecules in this entry.

5.4 Non-standard residues in protein, DNA, RNA chains [i](#)

There are no non-standard protein/DNA/RNA residues in this entry.

5.5 Carbohydrates [i](#)

There are no carbohydrates in this entry.

5.6 Ligand geometry [i](#)

Of 39 ligands modelled in this entry, 14 are monoatomic - leaving 25 for Mogul analysis.

In the following table, the Counts columns list the number of bonds (or angles) for which Mogul statistics could be retrieved, the number of bonds (or angles) that are observed in the model and the number of bonds (or angles) that are defined in the Chemical Component Dictionary. The Link column lists molecule types, if any, to which the group is linked. The Z score for a bond length (or angle) is the number of standard deviations the observed value is removed from the expected value. A bond length (or angle) with $|Z| > 2$ is considered an outlier worth inspection. RMSZ is the root-mean-square of all Z scores of the bond lengths (or angles).

Mol	Type	Chain	Res	Link	Bond lengths			Bond angles		
					Counts	RMSZ	$\# Z > 2$	Counts	RMSZ	$\# Z > 2$
3	DMU	B	2	-	34,34,34	0.55	1 (2%)	45,45,45	0.81	2 (4%)
3	DMU	D	8	-	24,24,34	0.58	0	35,35,45	0.60	0
5	HEA	C	1	1	44,67,67	1.47	5 (11%)	37,103,103	1.42	7 (18%)
3	DMU	D	4	-	24,24,34	0.55	0	35,35,45	0.84	1 (2%)
5	HEA	C	2	1	44,67,67	1.48	5 (11%)	37,103,103	1.61	9 (24%)
4	TRD	D	14	-	6,6,12	0.27	0	5,5,11	0.39	0
9	HTH	B	286	-	9,9,9	0.45	0	10,10,10	0.81	1 (10%)
4	TRD	A	1013	-	6,6,12	0.35	0	5,5,11	0.27	0
3	DMU	C	9	-	12,12,34	0.56	0	17,17,45	0.47	0
3	DMU	C	5	-	24,24,34	0.56	0	35,35,45	0.72	0
3	DMU	B	1	-	34,34,34	0.59	1 (2%)	45,45,45	1.09	2 (4%)
4	TRD	C	552	-	12,12,12	0.28	0	11,11,11	0.47	0

Mol	Type	Chain	Res	Link	Bond lengths			Bond angles		
					Counts	RMSZ	# Z > 2	Counts	RMSZ	# Z > 2
5	HEA	A	2	1	44,67,67	1.61	6 (13%)	37,103,103	1.47	8 (21%)
4	TRD	C	3	-	12,12,12	0.27	0	11,11,11	0.53	0
4	TRD	A	552	-	12,12,12	0.31	0	11,11,11	0.38	0
3	DMU	C	10	-	34,34,34	0.55	0	45,45,45	0.77	1 (2%)
3	DMU	A	1005	-	22,22,34	0.55	0	27,27,45	0.77	1 (3%)
3	DMU	A	7	-	22,22,34	0.66	1 (4%)	27,27,45	0.78	1 (3%)
3	DMU	B	3	-	34,34,34	0.58	0	45,45,45	0.59	0
4	TRD	A	1009	-	6,6,12	0.29	0	5,5,11	0.38	0
4	TRD	A	3	-	12,12,12	0.29	0	11,11,11	0.51	0
5	HEA	A	1	1	44,67,67	1.45	4 (9%)	37,103,103	1.44	5 (13%)
4	TRD	B	4	-	8,8,12	0.27	0	7,7,11	0.46	0
3	DMU	B	6	-	24,24,34	0.59	0	35,35,45	0.70	0
4	TRD	A	1015	-	6,6,12	0.34	0	5,5,11	0.31	0

In the following table, the Chirals column lists the number of chiral outliers, the number of chiral centers analysed, the number of these observed in the model and the number defined in the Chemical Component Dictionary. Similar counts are reported in the Torsion and Rings columns. '-' means no outliers of that kind were identified.

Mol	Type	Chain	Res	Link	Chirals	Torsions	Rings
3	DMU	B	2	-	-	13/19/59/59	0/2/2/2
3	DMU	D	8	-	-	2/8/48/59	0/2/2/2
5	HEA	C	1	1	2/2/7/16	0/24/76/76	-
3	DMU	D	4	-	-	1/8/48/59	0/2/2/2
5	HEA	C	2	1	3/3/7/16	5/24/76/76	-
4	TRD	D	14	-	-	1/4/4/10	-
9	HTH	B	286	-	-	5/10/10/10	-
4	TRD	A	1013	-	-	0/4/4/10	-
3	DMU	C	9	-	1/1/5/10	1/2/22/59	0/1/1/2
3	DMU	C	5	-	-	2/8/48/59	0/2/2/2
3	DMU	B	1	-	-	12/19/59/59	0/2/2/2
4	TRD	C	552	-	-	6/10/10/10	-
5	HEA	A	2	1	3/3/7/16	3/24/76/76	-
4	TRD	C	3	-	-	7/10/10/10	-
4	TRD	A	552	-	-	7/10/10/10	-
3	DMU	C	10	-	-	12/19/59/59	0/2/2/2
3	DMU	A	1005	-	-	5/13/33/59	0/1/1/2
3	DMU	A	7	-	-	7/13/33/59	0/1/1/2

Continued on next page...

Continued from previous page...

Mol	Type	Chain	Res	Link	Chirals	Torsions	Rings
3	DMU	B	3	-	-	7/19/59/59	0/2/2/2
4	TRD	A	1009	-	-	1/4/4/10	-
4	TRD	A	3	-	-	3/10/10/10	-
5	HEA	A	1	1	2/2/7/16	0/24/76/76	-
4	TRD	B	4	-	-	1/6/6/10	-
3	DMU	B	6	-	-	1/8/48/59	0/2/2/2
4	TRD	A	1015	-	-	0/4/4/10	-

All (23) bond length outliers are listed below:

Mol	Chain	Res	Type	Atoms	Z	Observed(Å)	Ideal(Å)
5	A	2	HEA	C3B-C11	5.16	1.56	1.52
5	C	1	HEA	C3A-C2A	-4.55	1.34	1.40
5	A	1	HEA	C3A-C2A	-4.52	1.34	1.40
5	A	2	HEA	C3C-C2C	-4.51	1.34	1.40
5	C	2	HEA	C3C-C2C	-4.12	1.34	1.40
5	C	2	HEA	C3B-C11	4.08	1.56	1.52
5	A	2	HEA	C3A-C2A	-3.97	1.34	1.40
5	C	2	HEA	C3A-C2A	-3.83	1.35	1.40
5	C	1	HEA	C3B-C11	3.78	1.55	1.52
5	A	1	HEA	C3B-C11	3.67	1.55	1.52
5	A	1	HEA	C3C-C2C	-3.50	1.35	1.40
5	C	1	HEA	C3C-C2C	-3.33	1.35	1.40
5	A	1	HEA	C3C-CAC	3.30	1.54	1.47
5	C	1	HEA	C3C-CAC	3.06	1.54	1.47
5	C	2	HEA	C3C-CAC	2.87	1.53	1.47
5	A	2	HEA	C3C-CAC	2.87	1.53	1.47
5	A	2	HEA	C3A-CMA	2.40	1.52	1.46
5	C	2	HEA	C3A-CMA	2.39	1.51	1.46
5	A	2	HEA	CAD-C3D	2.29	1.55	1.52
3	A	7	DMU	O16-C6	2.23	1.44	1.40
3	B	1	DMU	O16-C6	2.19	1.43	1.40
5	C	1	HEA	C3A-CMA	2.17	1.51	1.46
3	B	2	DMU	O16-C6	2.10	1.43	1.40

All (38) bond angle outliers are listed below:

Mol	Chain	Res	Type	Atoms	Z	Observed(°)	Ideal(°)
3	D	4	DMU	C10-O1-C9	3.40	120.36	113.69
5	C	2	HEA	CAD-CBD-CGD	-3.28	107.17	112.67
5	A	2	HEA	CBD-CAD-C3D	3.02	118.05	112.49

Continued on next page...

Continued from previous page...

Mol	Chain	Res	Type	Atoms	Z	Observed(°)	Ideal(°)
5	C	2	HEA	CBD-CAD-C3D	2.94	117.92	112.49
3	B	1	DMU	O1-C9-C11	2.75	113.27	106.44
5	A	2	HEA	C1B-C2B-C3B	2.68	108.86	107.00
5	C	2	HEA	C25-C23-C24	2.64	120.42	114.60
5	C	2	HEA	C26-C15-C16	2.60	119.64	115.27
5	A	1	HEA	CMC-C2C-C1C	-2.59	124.48	128.46
5	A	1	HEA	CMB-C2B-C1B	-2.56	124.53	128.46
5	C	2	HEA	C1B-C2B-C3B	2.56	108.78	107.00
5	C	1	HEA	CMB-C2B-C1B	-2.55	124.54	128.46
5	A	1	HEA	C27-C19-C20	2.50	119.47	115.27
5	A	2	HEA	C26-C15-C16	2.50	119.47	115.27
5	A	2	HEA	C27-C19-C20	2.49	119.45	115.27
5	C	1	HEA	CMC-C2C-C1C	-2.48	124.65	128.46
5	A	1	HEA	C26-C15-C16	2.46	119.40	115.27
5	C	2	HEA	CMB-C2B-C1B	-2.43	124.73	128.46
5	C	2	HEA	C27-C19-C20	2.40	119.30	115.27
5	A	1	HEA	C17-C18-C19	-2.39	121.91	127.66
5	C	1	HEA	C13-C12-C11	-2.34	110.83	114.35
3	B	2	DMU	C10-O7-C3	-2.31	112.24	117.96
5	C	2	HEA	CBA-CAA-C2A	-2.30	108.23	112.48
3	A	7	DMU	O16-C6-C1	2.30	111.89	108.30
3	B	2	DMU	O16-C6-C1	2.27	111.85	108.30
5	A	2	HEA	CBA-CAA-C2A	-2.27	108.29	112.48
5	C	1	HEA	C25-C23-C24	2.25	119.57	114.60
5	C	1	HEA	C27-C19-C20	2.22	119.01	115.27
5	A	2	HEA	C25-C23-C24	2.20	119.47	114.60
5	A	2	HEA	CMC-C2C-C1C	-2.13	125.20	128.46
5	C	2	HEA	C3A-C4A-NA	-2.12	106.94	110.94
9	B	286	HTH	C5-C4-C3	-2.06	110.79	114.18
3	A	1005	DMU	O16-C6-C1	2.05	111.50	108.30
3	C	10	DMU	C10-O1-C9	2.04	117.68	113.69
3	B	1	DMU	O3-C5-C10	-2.03	105.10	110.05
5	A	2	HEA	C13-C14-C15	-2.03	122.77	127.66
5	C	1	HEA	C21-C22-C23	-2.02	120.85	127.75
5	C	1	HEA	C26-C15-C16	2.00	118.64	115.27

All (11) chirality outliers are listed below:

Mol	Chain	Res	Type	Atom
5	C	1	HEA	ND
5	C	1	HEA	NB
5	C	2	HEA	NB

Continued on next page...

Continued from previous page...

Mol	Chain	Res	Type	Atom
5	C	2	HEA	NA
5	C	2	HEA	ND
3	C	9	DMU	C10
5	A	2	HEA	NB
5	A	2	HEA	NA
5	A	2	HEA	ND
5	A	1	HEA	ND
5	A	1	HEA	NB

All (102) torsion outliers are listed below:

Mol	Chain	Res	Type	Atoms
3	B	2	DMU	C1-C6-O16-C18
3	B	2	DMU	O5-C6-O16-C18
5	C	2	HEA	C4D-C3D-CAD-CBD
9	B	286	HTH	O1-C1-C2-O2
5	A	2	HEA	C2D-C3D-CAD-CBD
5	A	2	HEA	C4D-C3D-CAD-CBD
3	A	7	DMU	C1-C6-O16-C18
3	A	7	DMU	O5-C6-O16-C18
9	B	286	HTH	O1-C1-C2-C3
3	C	5	DMU	O5-C4-C57-O61
3	D	8	DMU	O6-C11-C9-O1
3	B	1	DMU	O5-C6-O16-C18
3	C	10	DMU	O1-C10-O7-C3
3	B	1	DMU	C1-C6-O16-C18
3	B	3	DMU	O6-C11-C9-C8
4	C	3	TRD	C2-C3-C4-C5
3	B	3	DMU	O6-C11-C9-O1
3	C	10	DMU	C31-C34-C37-C40
4	B	4	TRD	C5-C6-C7-C8
3	C	10	DMU	C25-C28-C31-C34
3	A	1005	DMU	C1-C6-O16-C18
3	B	1	DMU	C28-C31-C34-C37
4	A	552	TRD	C2-C3-C4-C5
3	B	2	DMU	C31-C34-C37-C40
4	C	3	TRD	C4-C5-C6-C7
3	A	7	DMU	C25-C28-C31-C34
4	A	3	TRD	C11-C10-C9-C8
3	A	1005	DMU	O5-C6-O16-C18
3	B	1	DMU	C22-C25-C28-C31
4	C	3	TRD	C6-C7-C8-C9

Continued on next page...

Continued from previous page...

Mol	Chain	Res	Type	Atoms
3	B	2	DMU	C18-C19-C22-C25
3	B	2	DMU	C19-C18-O16-C6
9	B	286	HTH	O3-C3-C4-C5
3	C	5	DMU	C3-C4-C57-O61
4	C	3	TRD	C11-C10-C9-C8
3	D	8	DMU	O6-C11-C9-C8
3	C	10	DMU	O16-C18-C19-C22
4	C	552	TRD	C4-C5-C6-C7
3	D	4	DMU	O6-C11-C9-O1
3	A	1005	DMU	C28-C31-C34-C37
3	B	3	DMU	C22-C25-C28-C31
3	B	2	DMU	C25-C28-C31-C34
3	C	10	DMU	C18-C19-C22-C25
3	B	2	DMU	O6-C11-C9-C8
3	B	3	DMU	O5-C6-O16-C18
3	B	1	DMU	C25-C28-C31-C34
3	A	7	DMU	C28-C31-C34-C37
3	B	2	DMU	C22-C25-C28-C31
3	C	10	DMU	C22-C25-C28-C31
4	A	552	TRD	C11-C10-C9-C8
4	C	552	TRD	C5-C6-C7-C8
3	A	7	DMU	C34-C37-C40-C43
3	C	10	DMU	C28-C31-C34-C37
3	B	1	DMU	C3-C4-C57-O61
3	A	7	DMU	C19-C22-C25-C28
3	B	2	DMU	C34-C37-C40-C43
4	A	3	TRD	C7-C8-C9-C10
3	B	3	DMU	C1-C6-O16-C18
4	C	552	TRD	C3-C4-C5-C6
3	B	2	DMU	C28-C31-C34-C37
9	B	286	HTH	C2-C3-C4-C5
3	C	10	DMU	C34-C37-C40-C43
4	A	552	TRD	C1-C2-C3-C4
3	B	2	DMU	C19-C22-C25-C28
4	C	3	TRD	C5-C6-C7-C8
3	C	10	DMU	O5-C6-O16-C18
5	C	2	HEA	C19-C20-C21-C22
5	A	2	HEA	C19-C20-C21-C22
3	B	3	DMU	O16-C18-C19-C22
3	B	1	DMU	C34-C37-C40-C43
4	C	3	TRD	C9-C10-C11-C12
3	B	1	DMU	O6-C11-C9-C8

Continued on next page...

Continued from previous page...

Mol	Chain	Res	Type	Atoms
3	C	10	DMU	C1-C6-O16-C18
4	A	1009	TRD	C4-C5-C6-C7
3	B	1	DMU	C31-C34-C37-C40
4	A	552	TRD	C4-C5-C6-C7
3	B	6	DMU	C3-C4-C57-O61
3	B	1	DMU	C18-C19-C22-C25
4	C	552	TRD	C2-C3-C4-C5
4	A	552	TRD	C9-C10-C11-C12
4	C	3	TRD	C10-C11-C12-C13
3	B	2	DMU	O6-C11-C9-O1
5	C	2	HEA	C2D-C3D-CAD-CBD
3	B	2	DMU	O16-C18-C19-C22
3	A	7	DMU	C18-C19-C22-C25
3	B	1	DMU	O5-C4-C57-O61
4	D	14	TRD	C4-C5-C6-C7
5	C	2	HEA	C18-C19-C20-C21
5	C	2	HEA	C27-C19-C20-C21
3	B	1	DMU	O16-C18-C19-C22
3	C	10	DMU	C4-C3-O7-C10
3	C	10	DMU	C2-C3-O7-C10
4	C	552	TRD	C11-C10-C9-C8
4	A	3	TRD	C3-C4-C5-C6
3	A	1005	DMU	C31-C34-C37-C40
4	C	552	TRD	C9-C10-C11-C12
3	C	9	DMU	O6-C11-C9-C8
3	A	1005	DMU	C34-C37-C40-C43
9	B	286	HTH	O2-C2-C3-O3
4	A	552	TRD	C5-C6-C7-C8
3	B	3	DMU	C25-C28-C31-C34
4	A	552	TRD	C7-C8-C9-C10

There are no ring outliers.

8 monomers are involved in 21 short contacts:

Mol	Chain	Res	Type	Clashes	Symm-Clashes
3	D	8	DMU	1	0
5	C	1	HEA	1	0
5	C	2	HEA	6	0
5	A	2	HEA	8	0
4	C	3	TRD	1	0
3	C	10	DMU	1	0
3	A	1005	DMU	1	0

Continued on next page...

Continued from previous page...

Mol	Chain	Res	Type	Clashes	Symm-Clashes
5	A	1	HEA	2	0

The following is a two-dimensional graphical depiction of Mogul quality analysis of bond lengths, bond angles, torsion angles, and ring geometry for all instances of the Ligand of Interest. In addition, ligands with molecular weight > 250 and outliers as shown on the validation Tables will also be included. For torsion angles, if less than 5% of the Mogul distribution of torsion angles is within 10 degrees of the torsion angle in question, then that torsion angle is considered an outlier. Any bond that is central to one or more torsion angles identified as an outlier by Mogul will be highlighted in the graph. For rings, the root-mean-square deviation (RMSD) between the ring in question and similar rings identified by Mogul is calculated over all ring torsion angles. If the average RMSD is greater than 60 degrees and the minimal RMSD between the ring in question and any Mogul-identified rings is also greater than 60 degrees, then that ring is considered an outlier. The outliers are highlighted in purple. The color gray indicates Mogul did not find sufficient equivalents in the CSD to analyse the geometry.

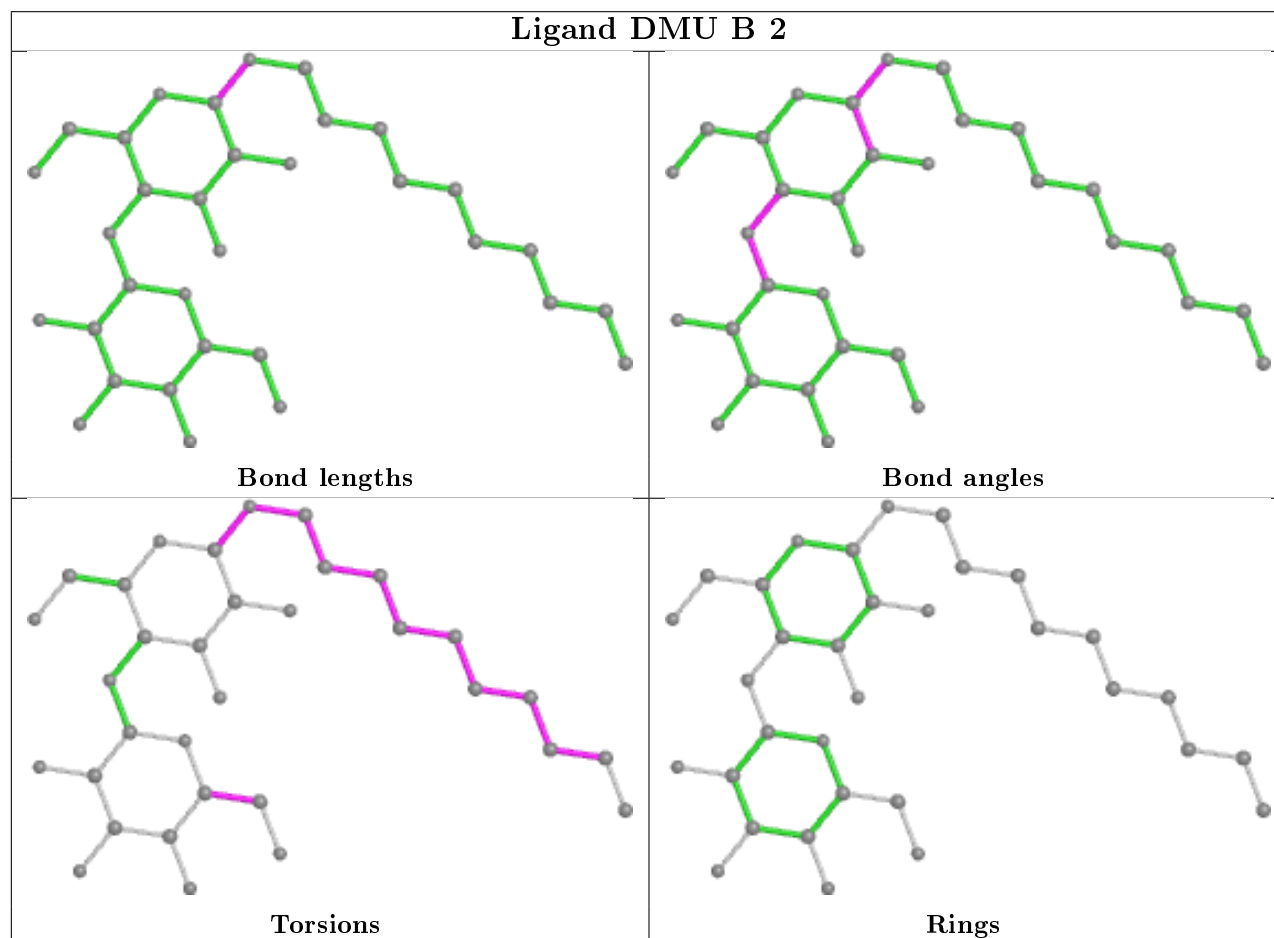

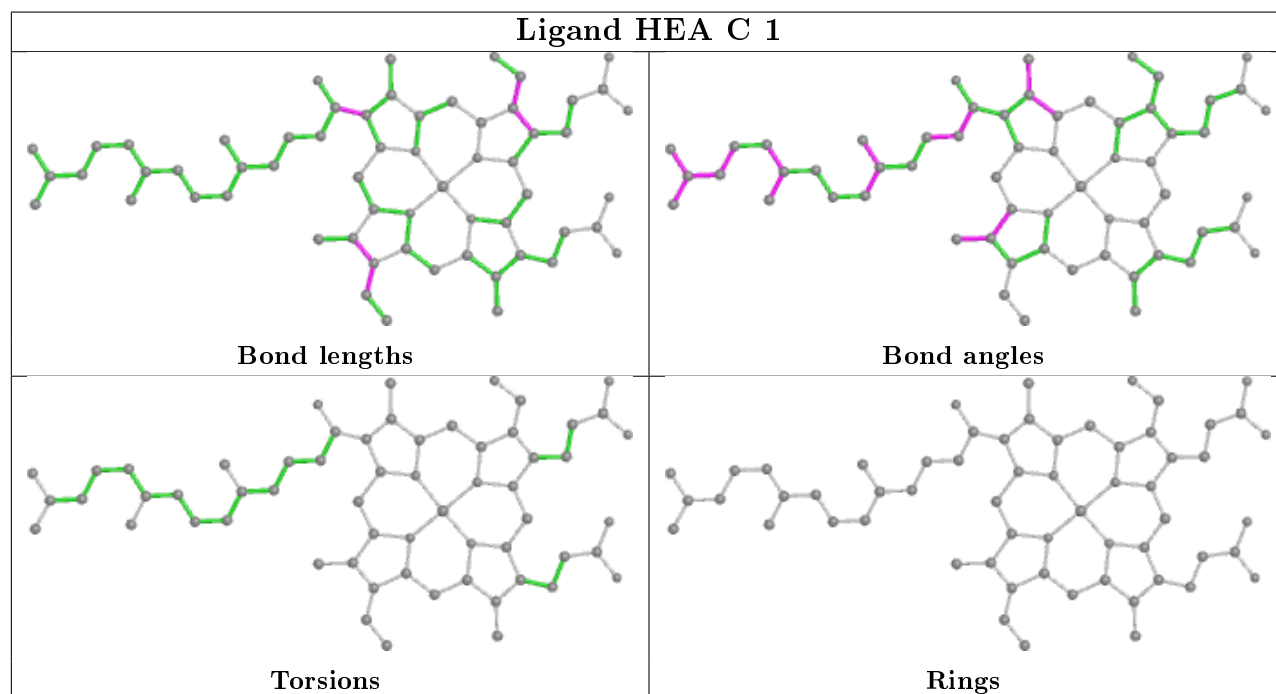
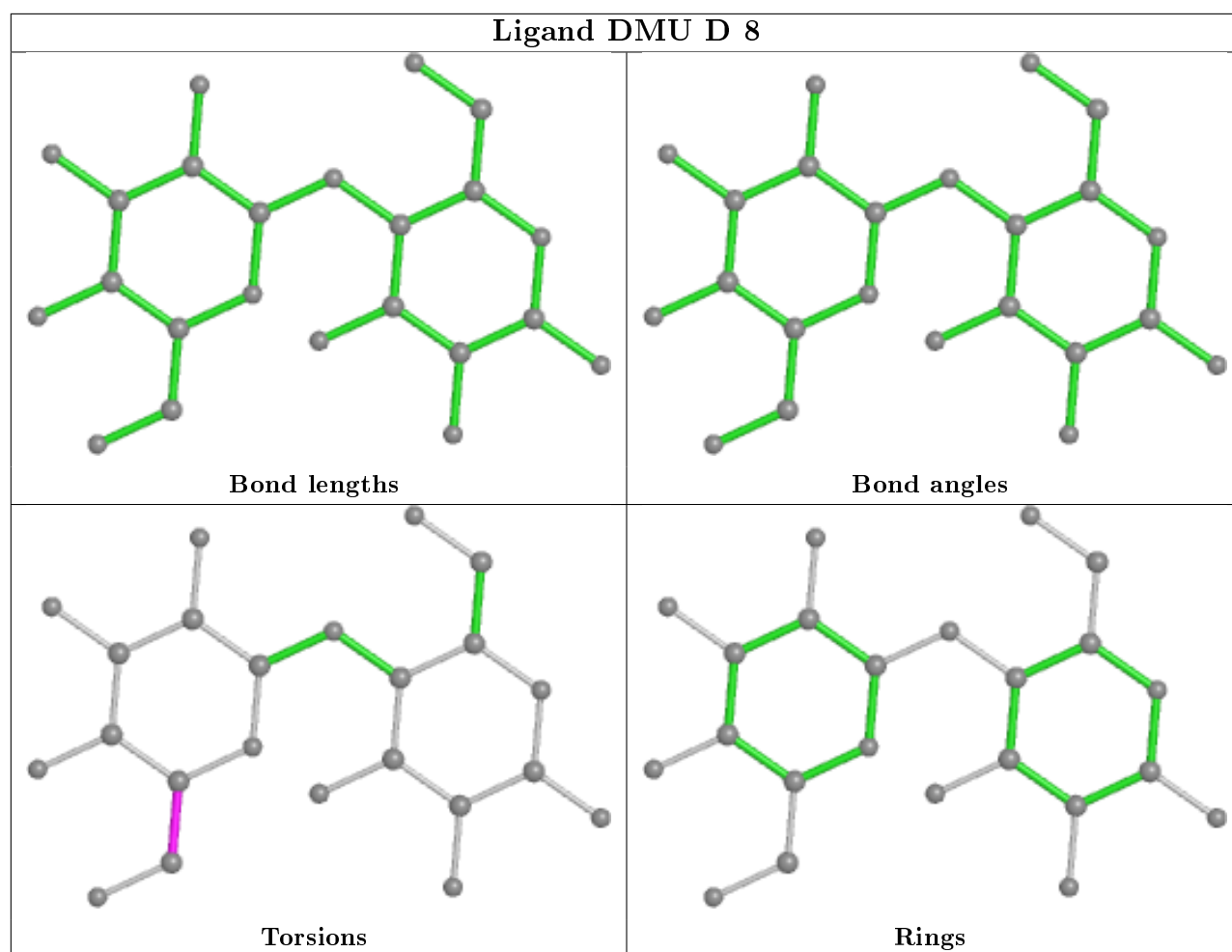

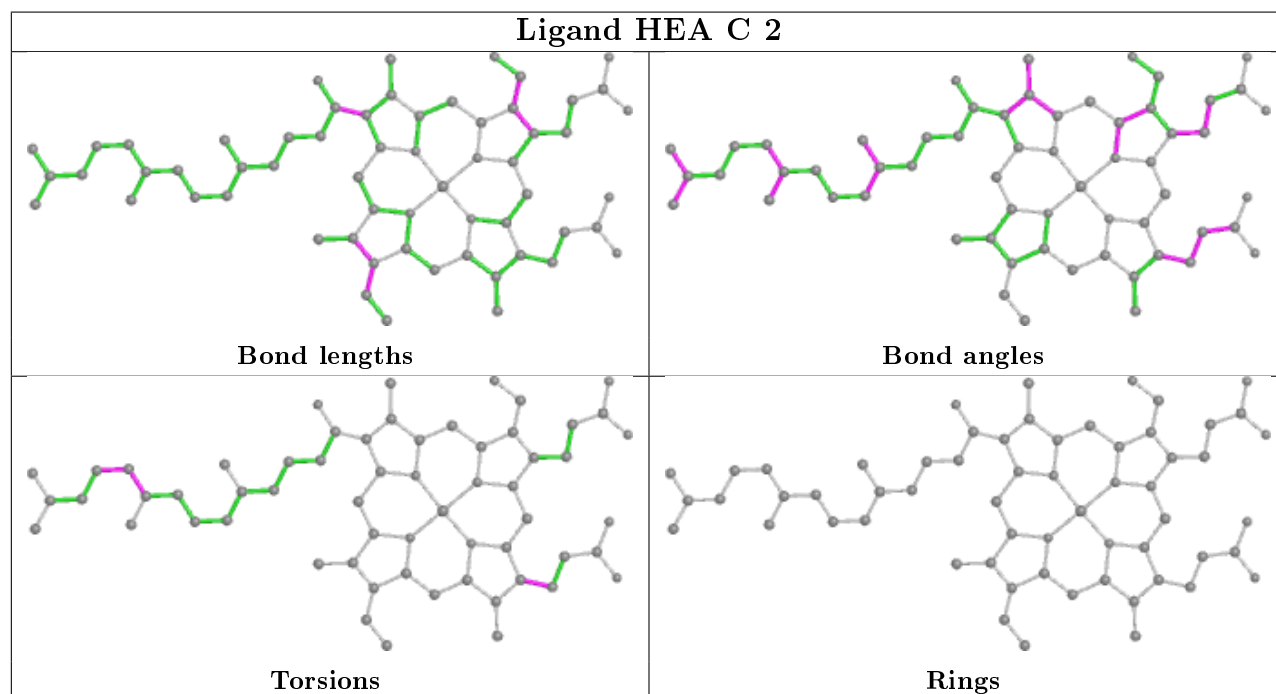
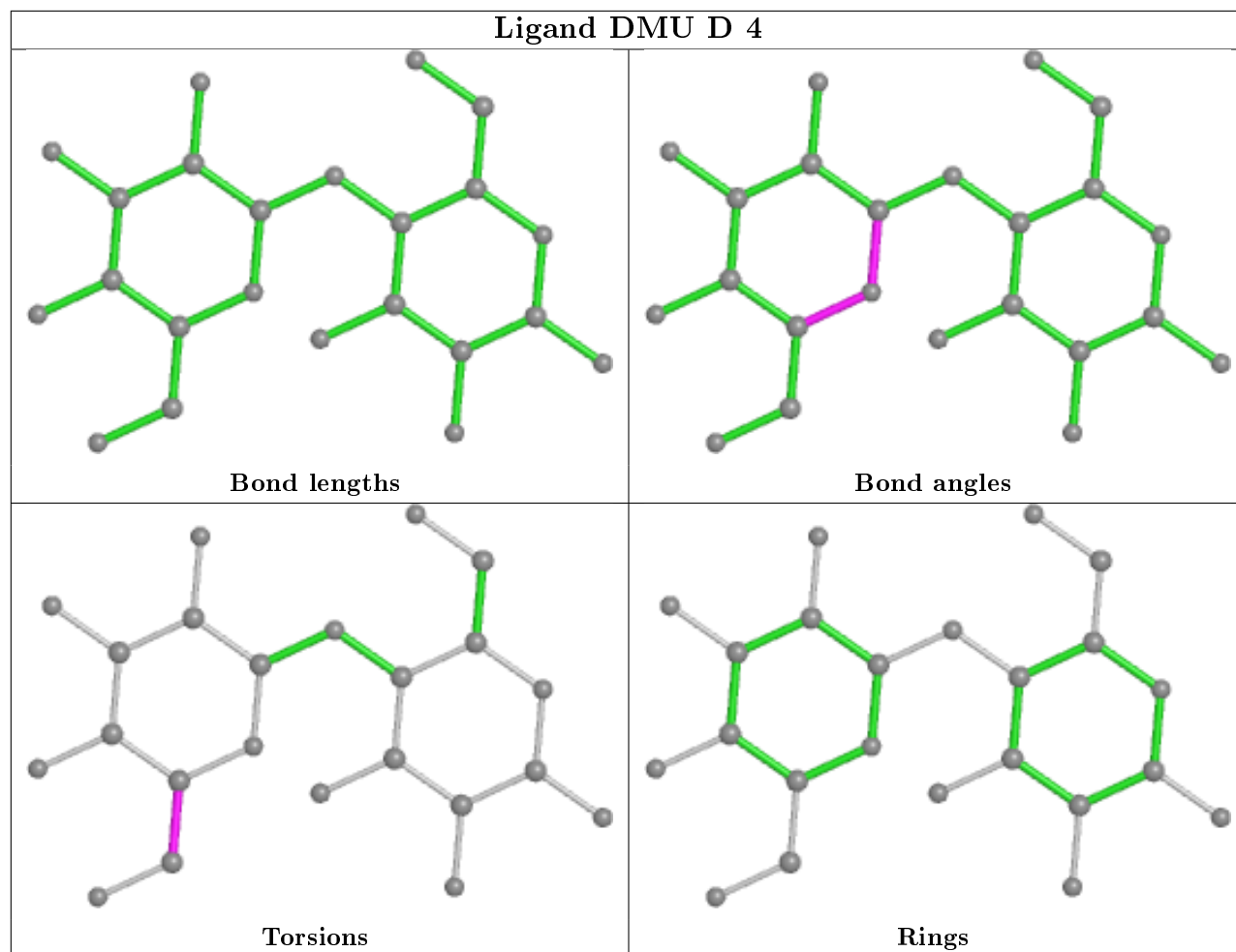

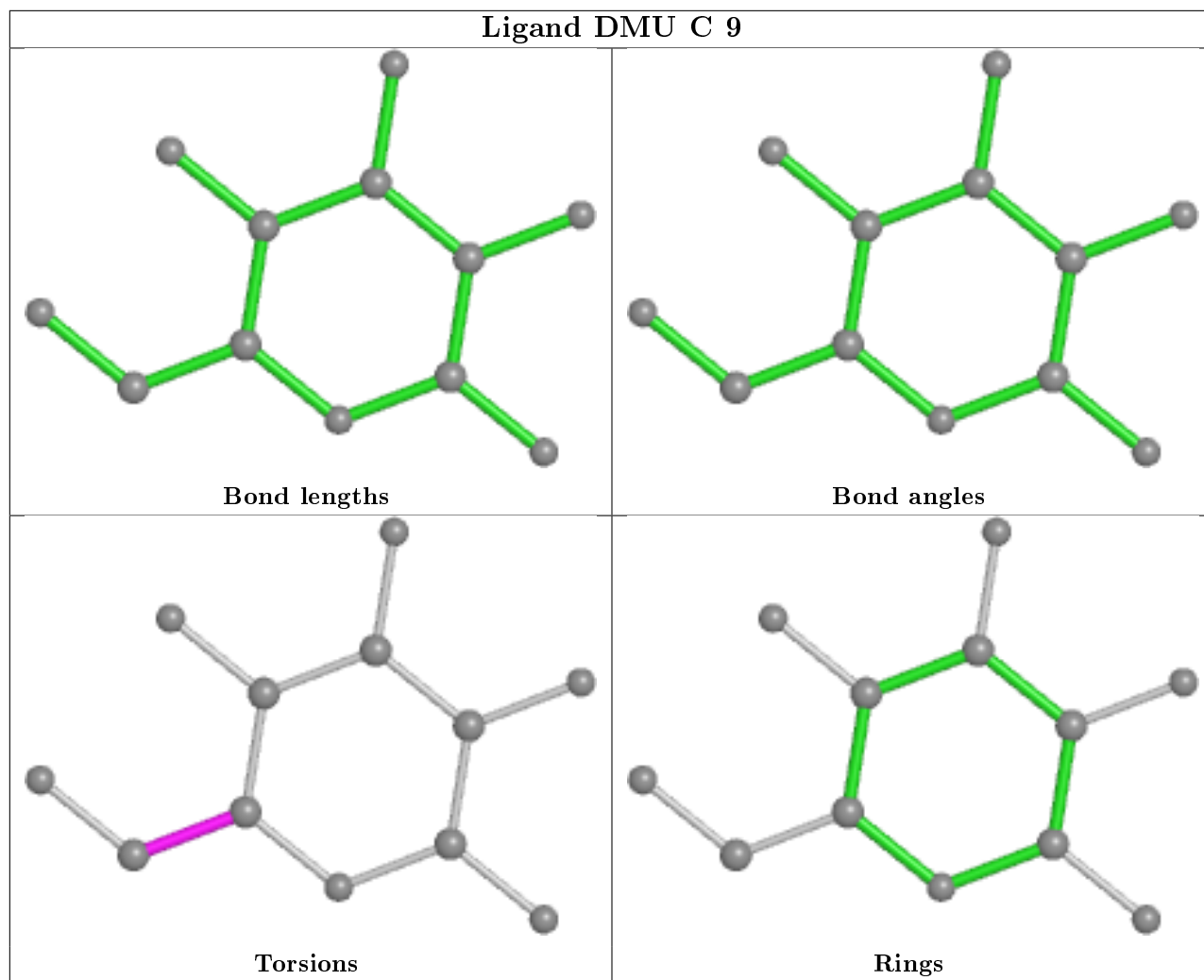

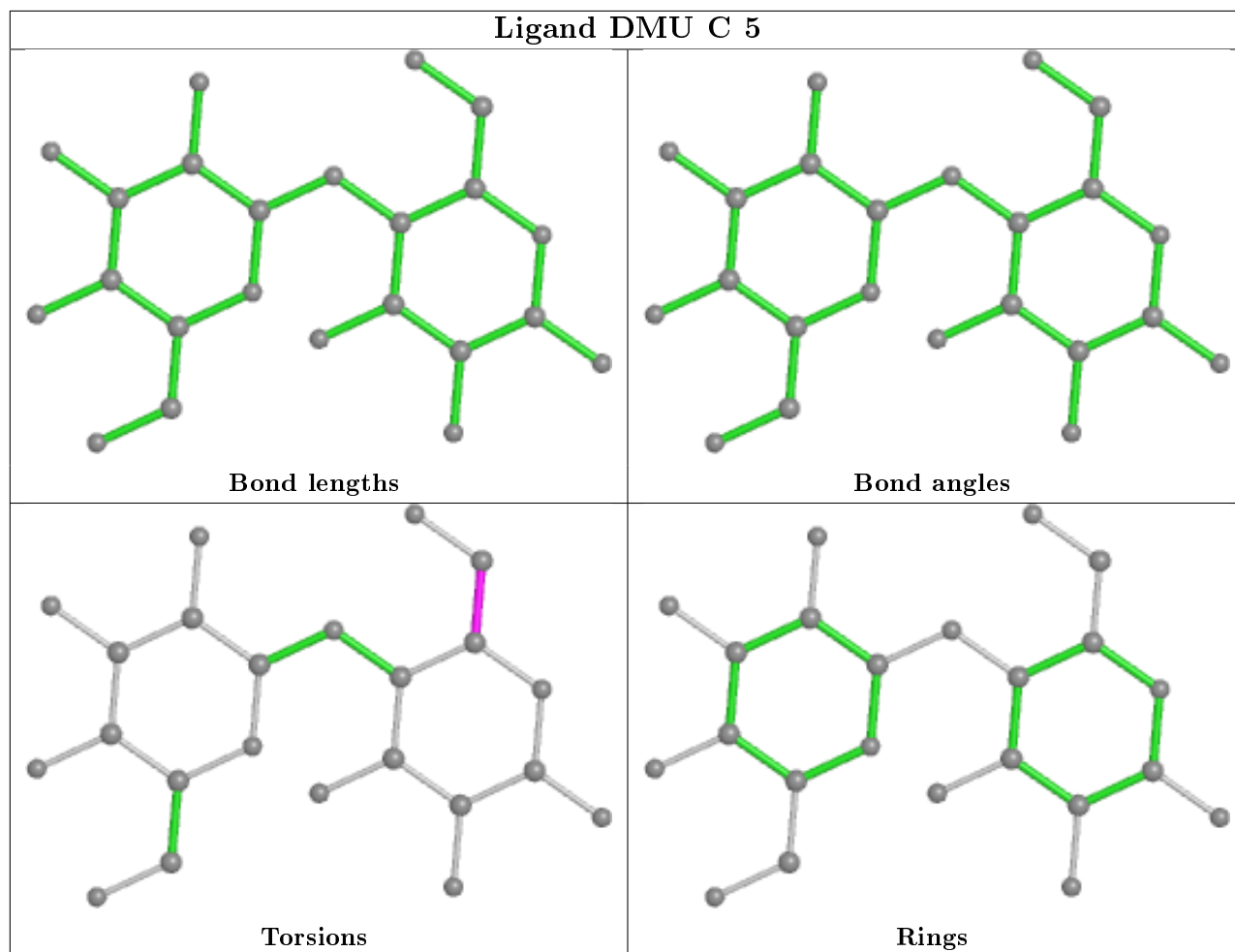

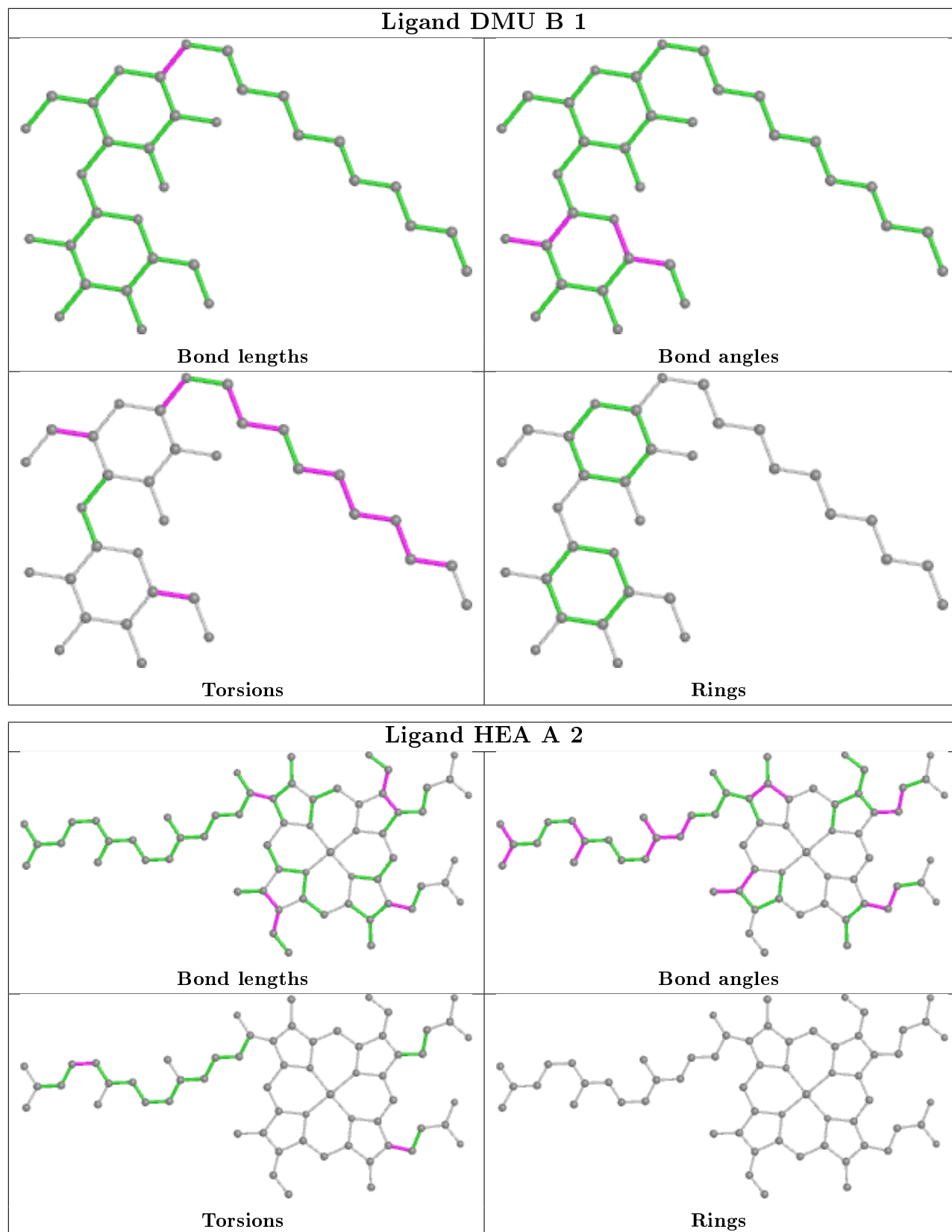

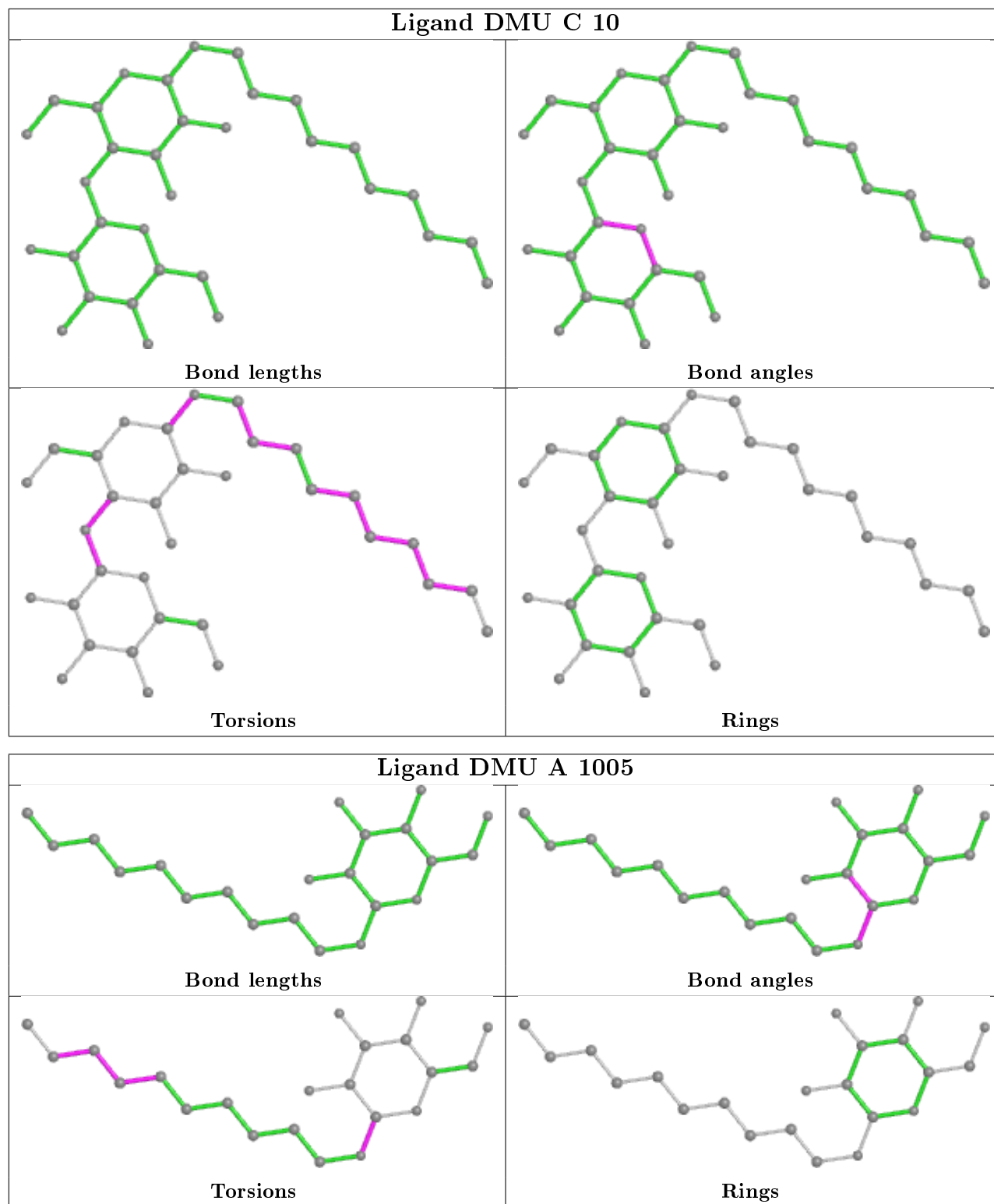

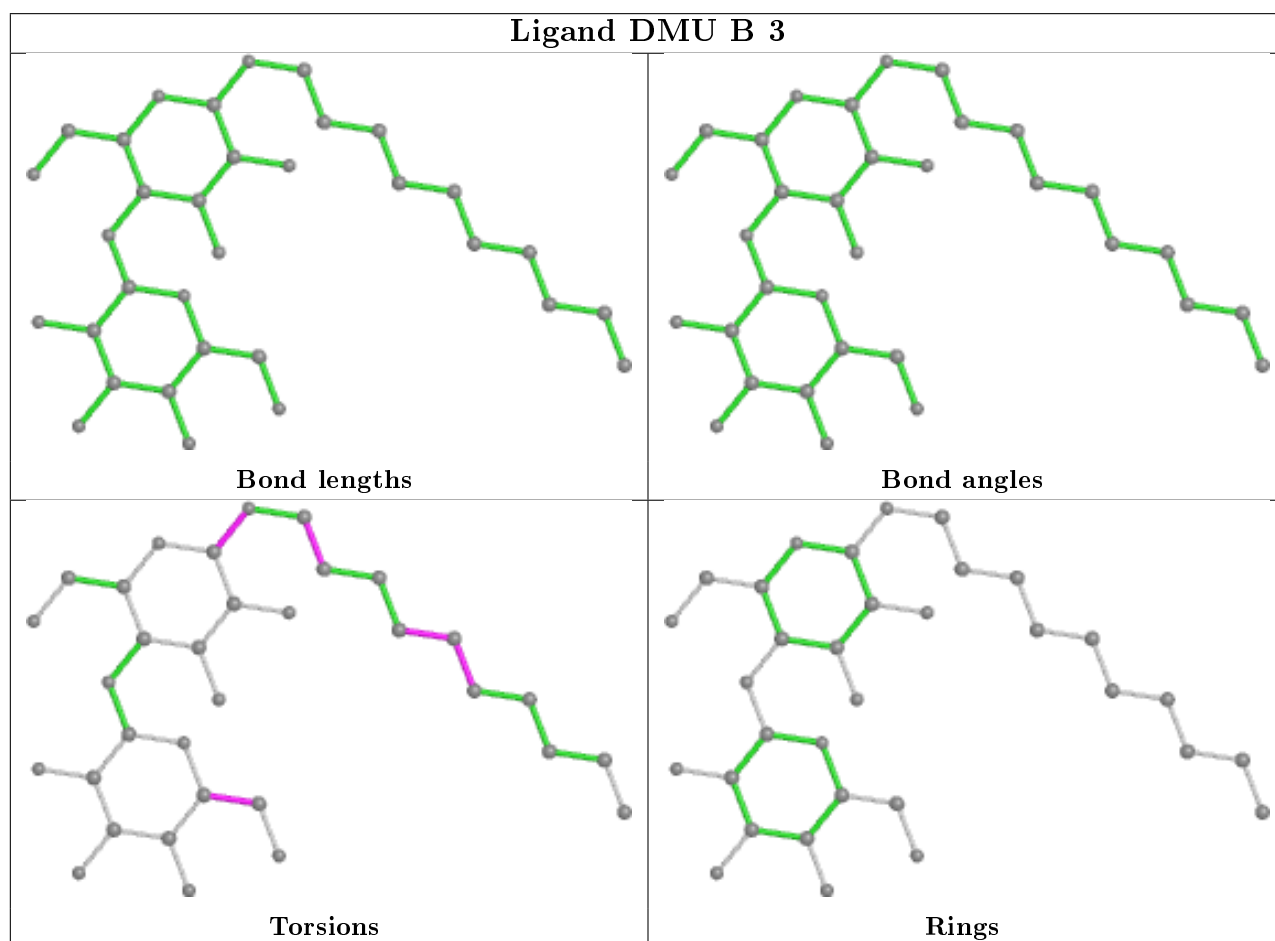
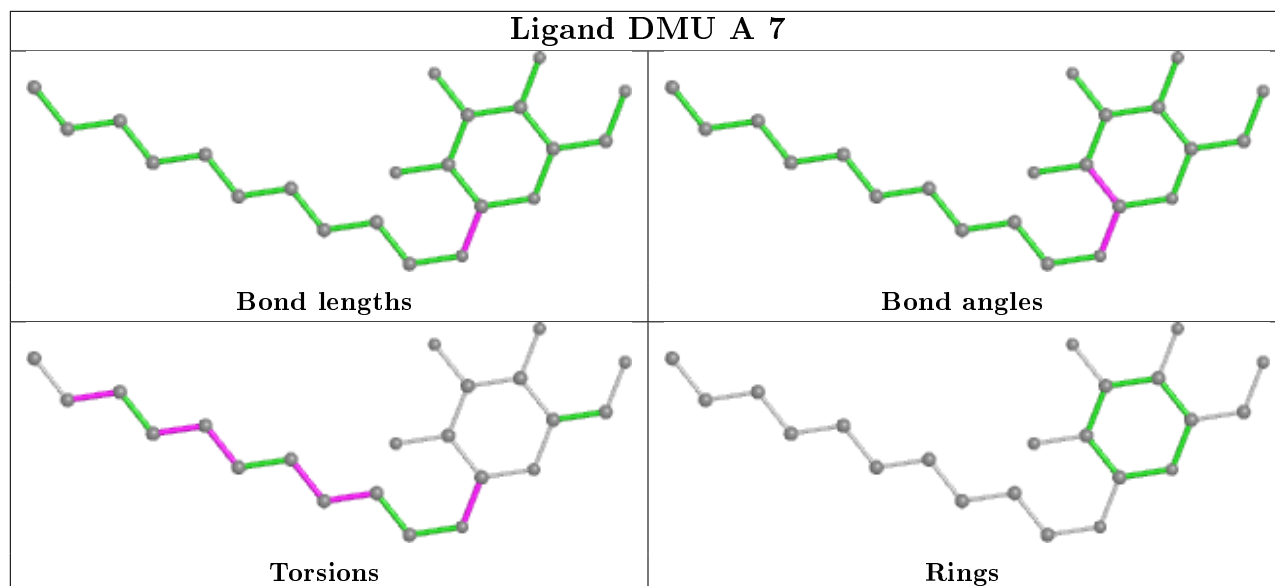

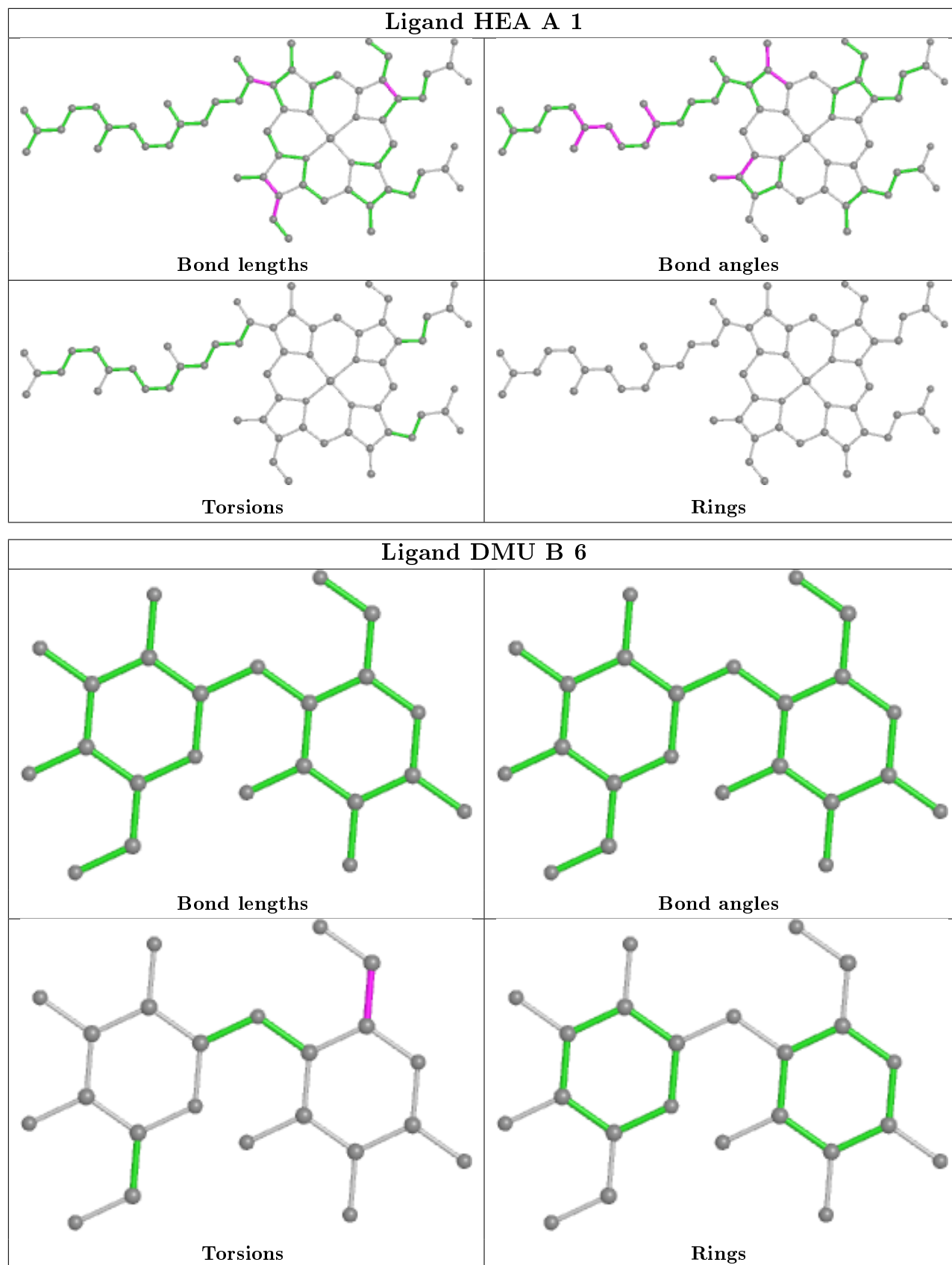

5.7 Other polymers [i](#)

There are no such residues in this entry.

5.8 Polymer linkage issues [i](#)

There are no chain breaks in this entry.

6 Fit of model and data

6.1 Protein, DNA and RNA chains

In the following table, the column labelled ‘#RSRZ> 2’ contains the number (and percentage) of RSRZ outliers, followed by percent RSRZ outliers for the chain as percentile scores relative to all X-ray entries and entries of similar resolution. The OWAB column contains the minimum, median, 95th percentile and maximum values of the occupancy-weighted average B-factor per residue. The column labelled ‘Q< 0.9’ lists the number of (and percentage) of residues with an average occupancy less than 0.9.

Mol	Chain	Analysed	<RSRZ>	#RSRZ>2	OWAB(Å ²)	Q<0.9
1	A	535/535 (100%)	-0.10	22 (4%) 37 30	30, 46, 68, 90	0
1	C	531/535 (99%)	0.24	42 (7%) 12 9	43, 65, 87, 95	0
2	B	256/256 (100%)	-0.31	7 (2%) 54 48	33, 50, 69, 75	1 (0%)
2	D	256/256 (100%)	-0.21	8 (3%) 49 42	42, 56, 79, 88	1 (0%)
All	All	1578/1582 (99%)	-0.04	79 (5%) 28 23	30, 54, 80, 95	2 (0%)

All (79) RSRZ outliers are listed below:

Mol	Chain	Res	Type	RSRZ
1	C	520	THR	6.2
1	C	218	PRO	5.7
1	C	138	MET	5.3
1	C	222	MET	4.8
2	D	99	PRO	4.6
1	C	21	PHE	4.6
1	C	20	TRP	4.4
1	C	22	MET	4.4
1	C	74	LYS	4.3
1	A	22	MET	4.1
1	C	23	SER	3.6
1	C	77	PHE	3.6
2	B	56	TRP	3.6
1	A	424	MET	3.5
1	A	18	THR	3.5
2	D	96	HIS	3.4
1	C	71	GLY	3.4
1	A	20	TRP	3.4
2	B	87	ARG	3.2
2	B	99	PRO	3.2
1	A	222	MET	3.1

Continued on next page...

Continued from previous page...

Mol	Chain	Res	Type	RSRZ
2	D	97	ASN	3.1
1	C	137	ARG	3.1
1	C	259	PHE	3.0
1	A	423	VAL	3.0
1	C	217	ALA	3.0
1	C	103	GLY	2.9
1	A	172	TRP	2.9
1	C	171	GLY	2.9
1	A	425	SER	2.9
2	D	87	ARG	2.9
2	B	281	GLN	2.7
1	A	223	HIS	2.7
1	C	425	SER	2.7
1	C	481	ARG	2.7
1	C	290	ILE	2.6
1	C	100	THR	2.6
1	C	413	THR	2.6
1	C	426	LEU	2.6
1	A	420	PHE	2.6
1	C	172	TRP	2.5
2	D	98	SER	2.5
2	B	284	HIS	2.5
1	C	73	VAL	2.5
2	D	178	GLN	2.5
1	C	417	VAL	2.4
1	C	140	ASN	2.4
1	A	426	LEU	2.4
2	D	100	LEU	2.3
1	C	263	PHE	2.3
1	C	287	VAL	2.3
1	C	69	GLU	2.3
1	A	397	THR	2.3
1	C	106	MET	2.3
1	C	70	SER	2.3
1	A	214	ASN	2.3
1	C	427	GLY	2.3
1	A	287	VAL	2.2
1	C	107	MET	2.2
2	B	81	TRP	2.2
1	C	219	GLY	2.2
1	C	428	ALA	2.2
1	A	260	GLY	2.2

Continued on next page...

Continued from previous page...

Mol	Chain	Res	Type	RSRZ
1	C	378	LYS	2.2
1	A	291	VAL	2.2
1	A	421	HIS	2.2
1	A	220	MET	2.1
1	A	427	GLY	2.1
1	C	135	PHE	2.1
1	C	99	ILE	2.1
2	D	81	TRP	2.1
1	A	548	GLU	2.1
1	C	184	GLY	2.1
2	B	96	HIS	2.1
1	C	416	VAL	2.0
1	C	203	LEU	2.0
1	A	394	GLY	2.0
1	A	401	LEU	2.0
1	C	446	ARG	2.0

6.2 Non-standard residues in protein, DNA, RNA chains [i](#)

There are no non-standard protein/DNA/RNA residues in this entry.

6.3 Carbohydrates [i](#)

There are no carbohydrates in this entry.

6.4 Ligands [i](#)

In the following table, the Atoms column lists the number of modelled atoms in the group and the number defined in the chemical component dictionary. The B-factors column lists the minimum, median, 95th percentile and maximum values of B factors of atoms in the group. The column labelled 'Q< 0.9' lists the number of atoms with occupancy less than 0.9.

Mol	Type	Chain	Res	Atoms	RSCC	RSR	B-factors(Å ²)	Q<0.9
4	TRD	C	552	13/13	0.68	0.27	94,94,95,95	0
4	TRD	A	1013	7/13	0.69	0.32	60,61,61,61	0
3	DMU	C	9	12/33	0.75	0.27	91,92,92,92	12
3	DMU	D	8	23/33	0.78	0.38	88,90,92,92	23
3	DMU	B	2	33/33	0.78	0.34	65,69,86,87	25
4	TRD	A	552	13/13	0.80	0.30	72,73,77,77	0
4	TRD	D	14	7/13	0.82	0.42	41,42,42,43	0

Continued on next page...

Continued from previous page...

Mol	Type	Chain	Res	Atoms	RSCC	RSR	B-factors(\AA^2)	Q<0.9
3	DMU	A	7	22/33	0.82	0.21	51,72,80,80	0
3	DMU	C	5	23/33	0.83	0.26	99,100,101,101	23
3	DMU	D	4	23/33	0.83	0.28	88,89,91,91	23
4	TRD	A	3	13/13	0.83	0.28	61,63,64,64	0
3	DMU	C	10	33/33	0.84	0.32	52,54,56,57	0
9	HTH	B	286	10/10	0.85	0.43	62,66,68,68	0
4	TRD	A	1015	7/13	0.85	0.47	72,72,74,74	0
3	DMU	A	1005	22/33	0.86	0.24	56,59,63,63	22
10	CD	D	9	1/1	0.86	0.07	95,95,95,95	1
3	DMU	B	3	33/33	0.86	0.25	95,99,101,101	0
4	TRD	A	1009	7/13	0.87	0.17	62,63,63,64	0
4	TRD	B	4	9/13	0.88	0.31	73,73,75,76	0
3	DMU	B	6	23/33	0.90	0.17	81,82,83,83	23
4	TRD	C	3	13/13	0.90	0.23	68,69,73,73	0
8	CA	C	7	1/1	0.94	0.09	57,57,57,57	0
5	HEA	A	2	60/60	0.94	0.29	41,48,58,59	0
5	HEA	C	2	60/60	0.95	0.22	44,53,63,64	0
3	DMU	B	1	33/33	0.95	0.14	39,45,59,61	0
5	HEA	C	1	60/60	0.97	0.25	45,47,54,55	0
5	HEA	A	1	60/60	0.98	0.21	31,35,40,41	0
6	CU1	C	553	1/1	0.98	0.16	54,54,54,54	0
6	CU1	A	5	1/1	0.99	0.21	48,48,48,48	0
8	CA	A	553	1/1	0.99	0.10	34,34,34,34	0
10	CD	D	287	1/1	0.99	0.07	54,54,54,54	0
7	MG	C	6	1/1	0.99	0.23	31,31,31,31	0
7	MG	A	6	1/1	0.99	0.24	23,23,23,23	0
10	CD	B	9	1/1	0.99	0.06	79,79,79,79	1
6	CU1	D	3	1/1	1.00	0.15	47,47,47,47	0
6	CU1	B	288	1/1	1.00	0.12	34,34,34,34	0
6	CU1	D	286	1/1	1.00	0.13	44,44,44,44	0
10	CD	B	8	1/1	1.00	0.08	52,52,52,52	0
6	CU1	B	287	1/1	1.00	0.15	37,37,37,37	0

The following is a graphical depiction of the model fit to experimental electron density of all instances of the Ligand of Interest. In addition, ligands with molecular weight > 250 and outliers as shown on the geometry validation Tables will also be included. Each fit is shown from different orientation to approximate a three-dimensional view.

Electron density around DMU C 9:

$2mF_o-DF_c$ (at 0.7 rmsd) in gray
 mF_o-DF_c (at 3 rmsd) in purple (negative)
and green (positive)

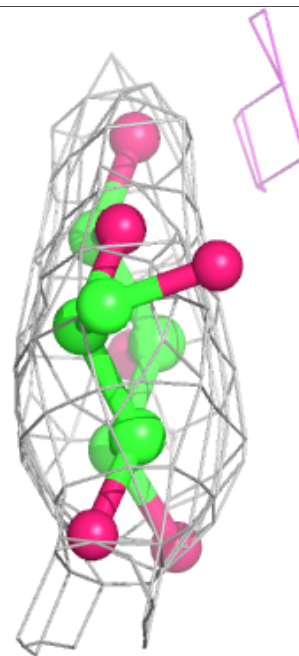
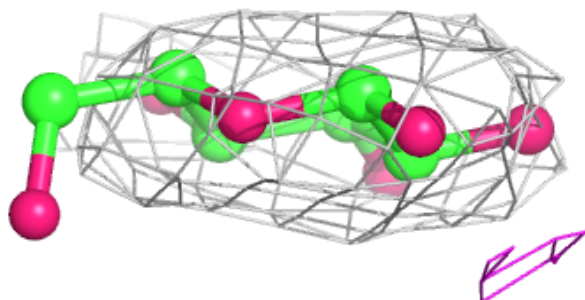
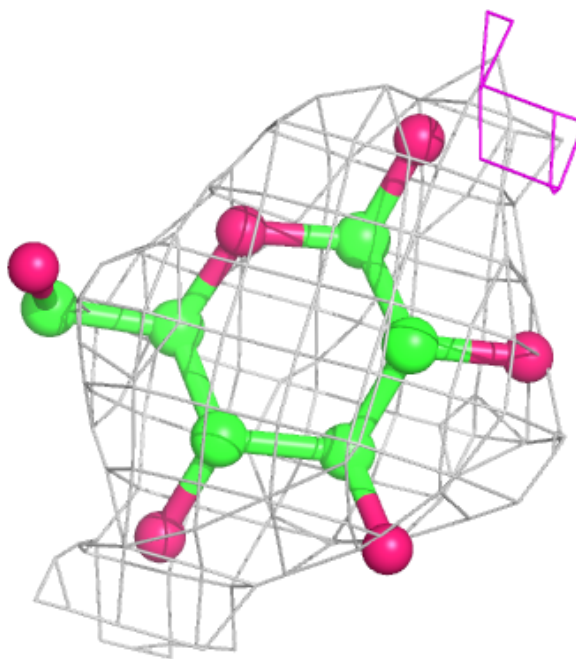

Electron density around DMU D 8:

$2mF_o-DF_c$ (at 0.7 rmsd) in gray
 mF_o-DF_c (at 3 rmsd) in purple (negative)
and green (positive)

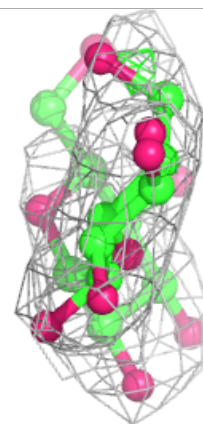
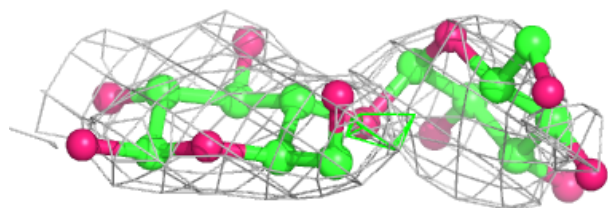
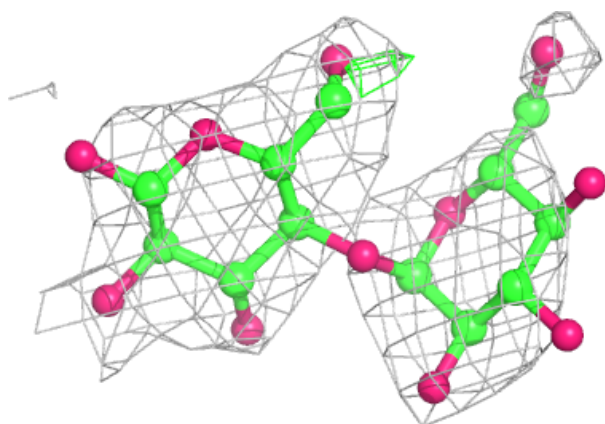

Electron density around DMU B 2:

$2mF_o-DF_c$ (at 0.7 rmsd) in gray
 mF_o-DF_c (at 3 rmsd) in purple (negative)
and green (positive)

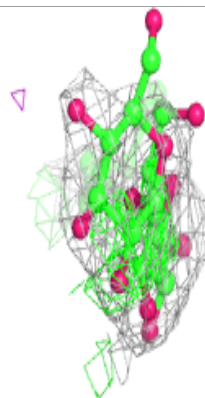
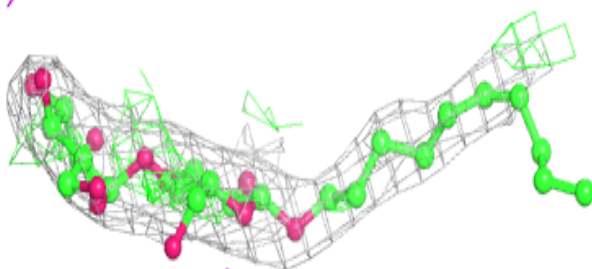
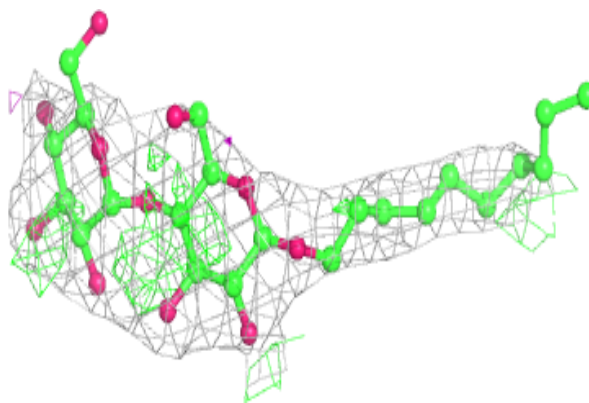
**Electron density around DMU A 7:**

$2mF_o-DF_c$ (at 0.7 rmsd) in gray
 mF_o-DF_c (at 3 rmsd) in purple (negative)
and green (positive)

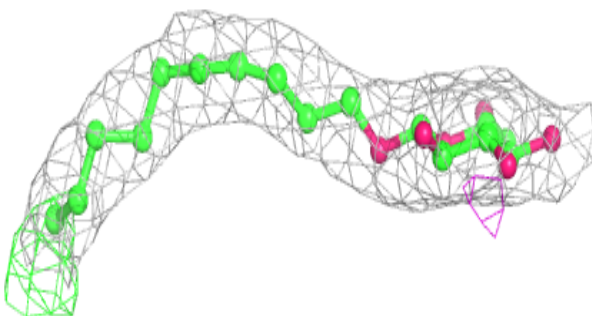
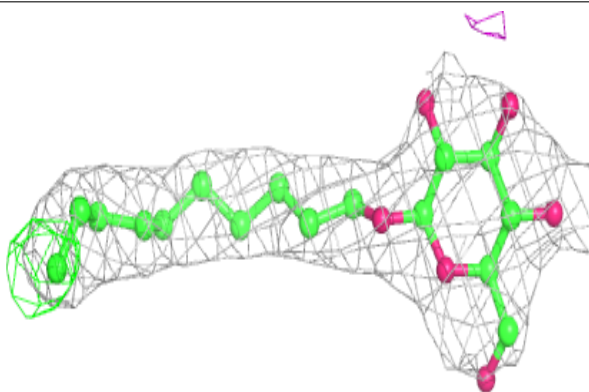

Electron density around DMU C 5:

$2mF_o-DF_c$ (at 0.7 rmsd) in gray
 mF_o-DF_c (at 3 rmsd) in purple (negative)
and green (positive)

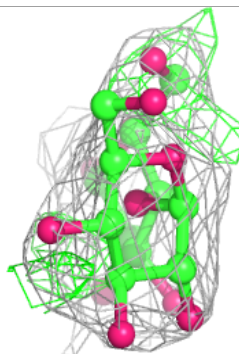
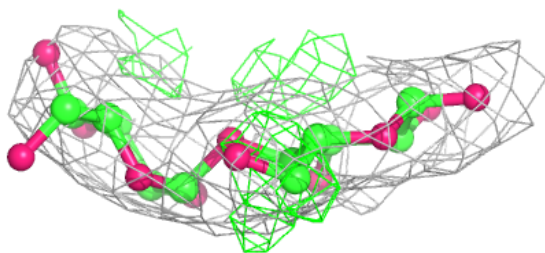
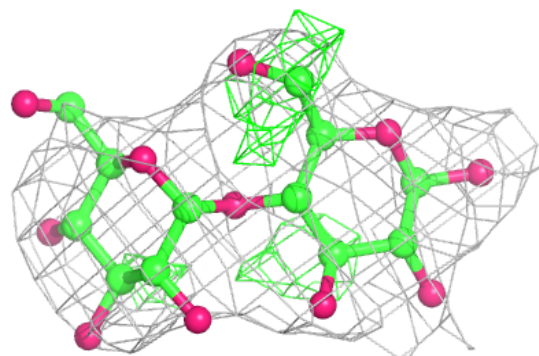
**Electron density around DMU D 4:**

$2mF_o-DF_c$ (at 0.7 rmsd) in gray
 mF_o-DF_c (at 3 rmsd) in purple (negative)
and green (positive)

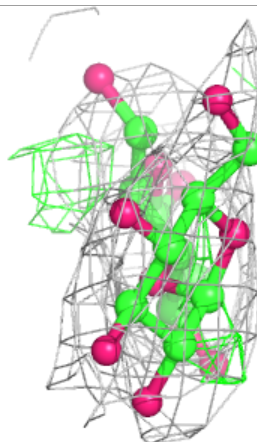
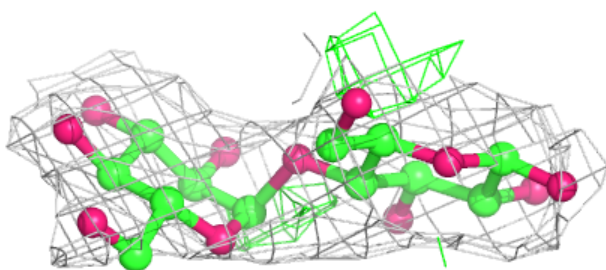
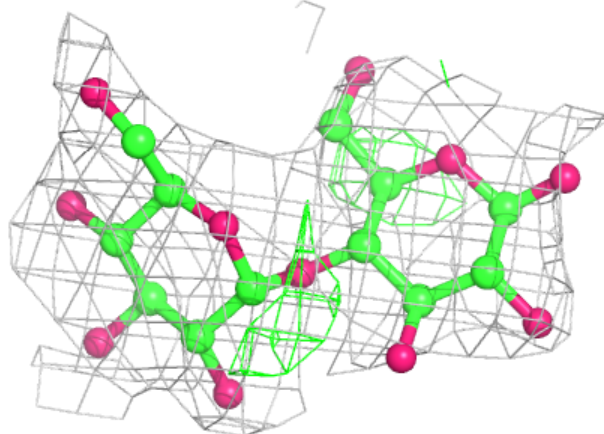

Electron density around DMU C 10:

$2mF_o-DF_c$ (at 0.7 rmsd) in gray
 mF_o-DF_c (at 3 rmsd) in purple (negative)
and green (positive)

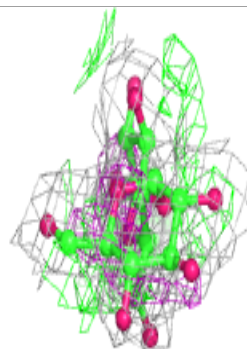
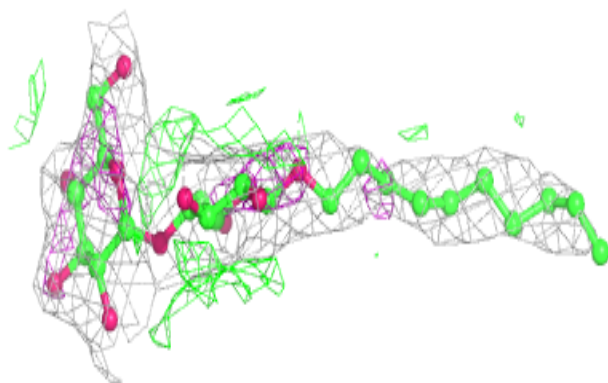
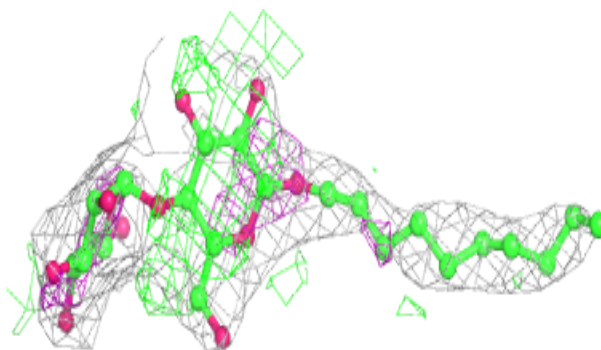
**Electron density around DMU A 1005:**

$2mF_o-DF_c$ (at 0.7 rmsd) in gray
 mF_o-DF_c (at 3 rmsd) in purple (negative)
and green (positive)

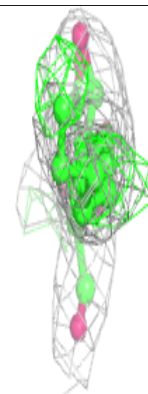
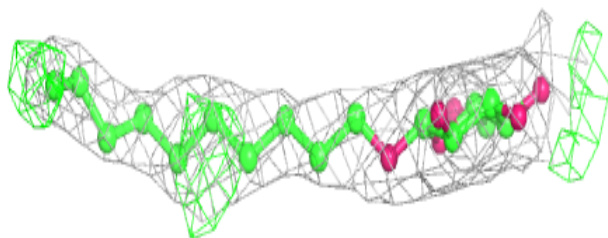
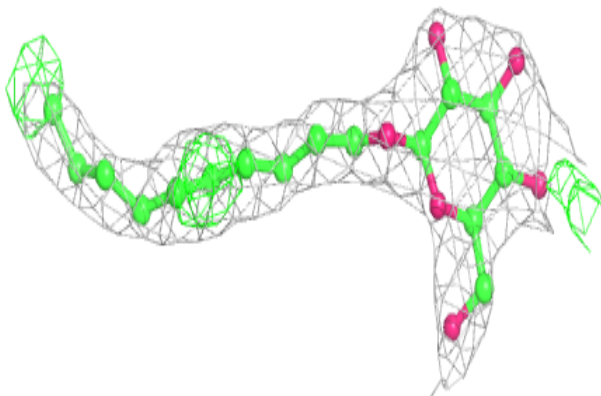

Electron density around DMU B 3:

$2mF_o-DF_c$ (at 0.7 rmsd) in gray
 mF_o-DF_c (at 3 rmsd) in purple (negative)
and green (positive)

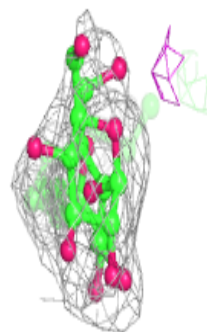
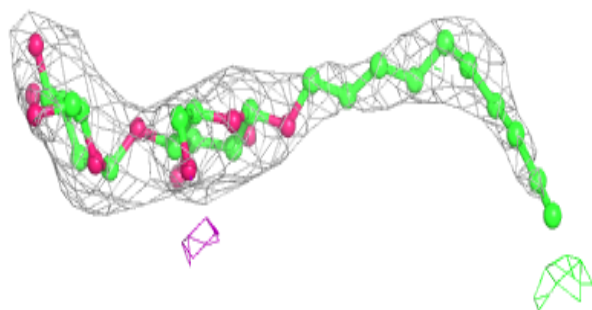
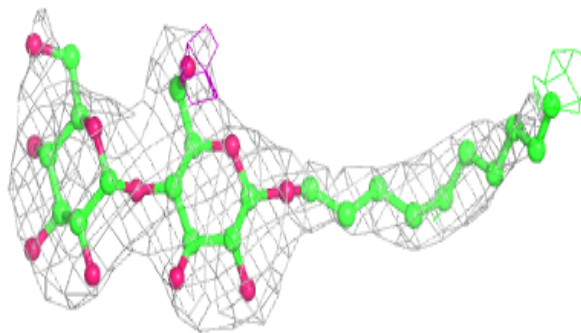
**Electron density around DMU B 6:**

$2mF_o-DF_c$ (at 0.7 rmsd) in gray
 mF_o-DF_c (at 3 rmsd) in purple (negative)
and green (positive)

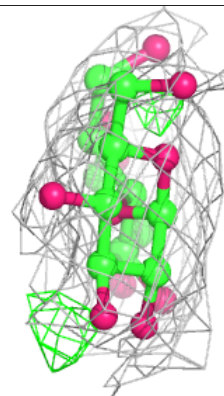
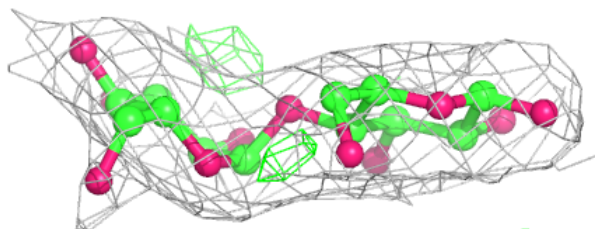
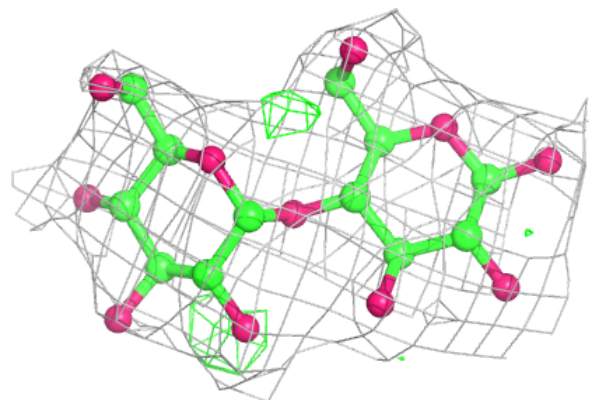

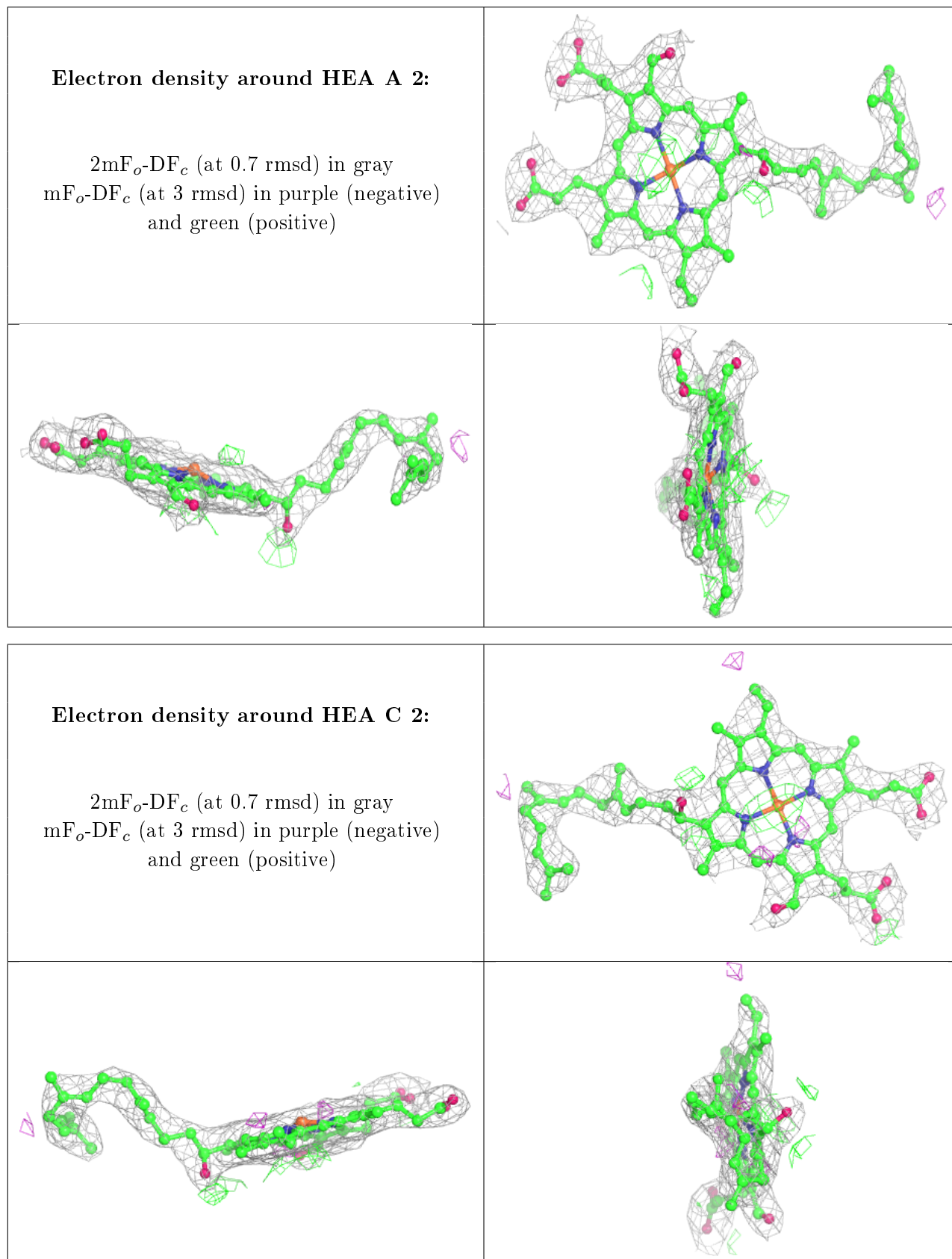

Electron density around DMU B 1:

$2mF_o-DF_c$ (at 0.7 rmsd) in gray
 mF_o-DF_c (at 3 rmsd) in purple (negative)
and green (positive)

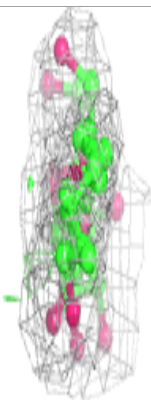
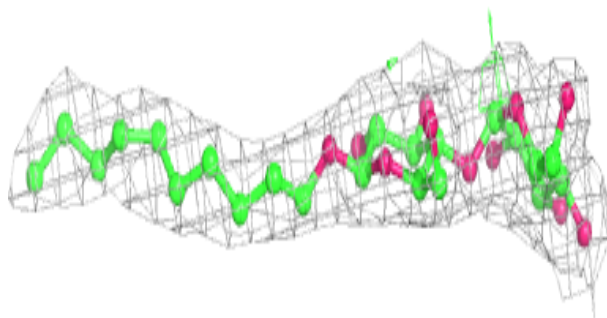
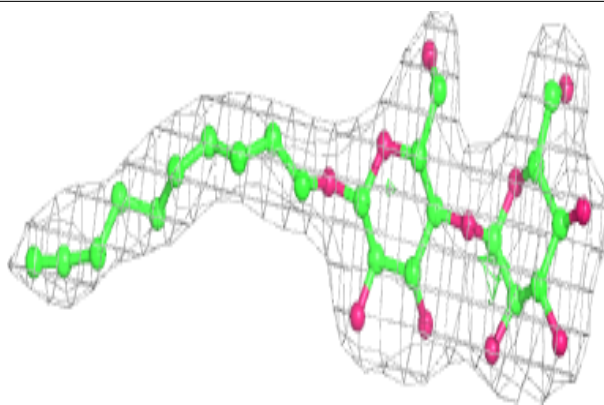
**Electron density around HEA C 1:**

$2mF_o-DF_c$ (at 0.7 rmsd) in gray
 mF_o-DF_c (at 3 rmsd) in purple (negative)
and green (positive)

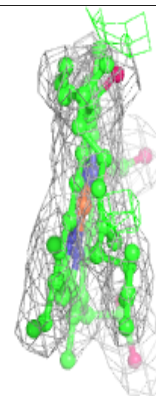
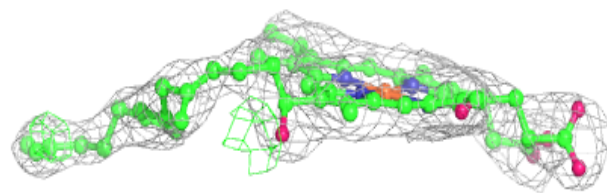
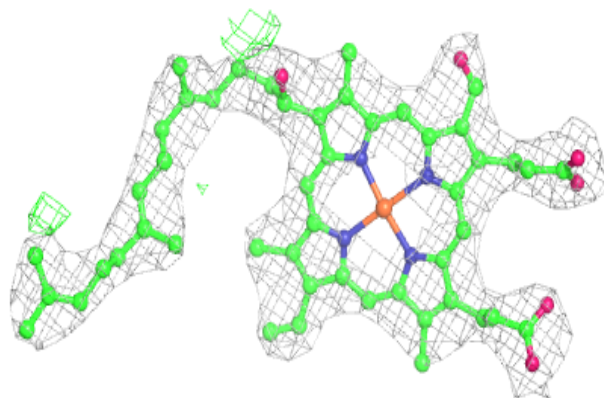

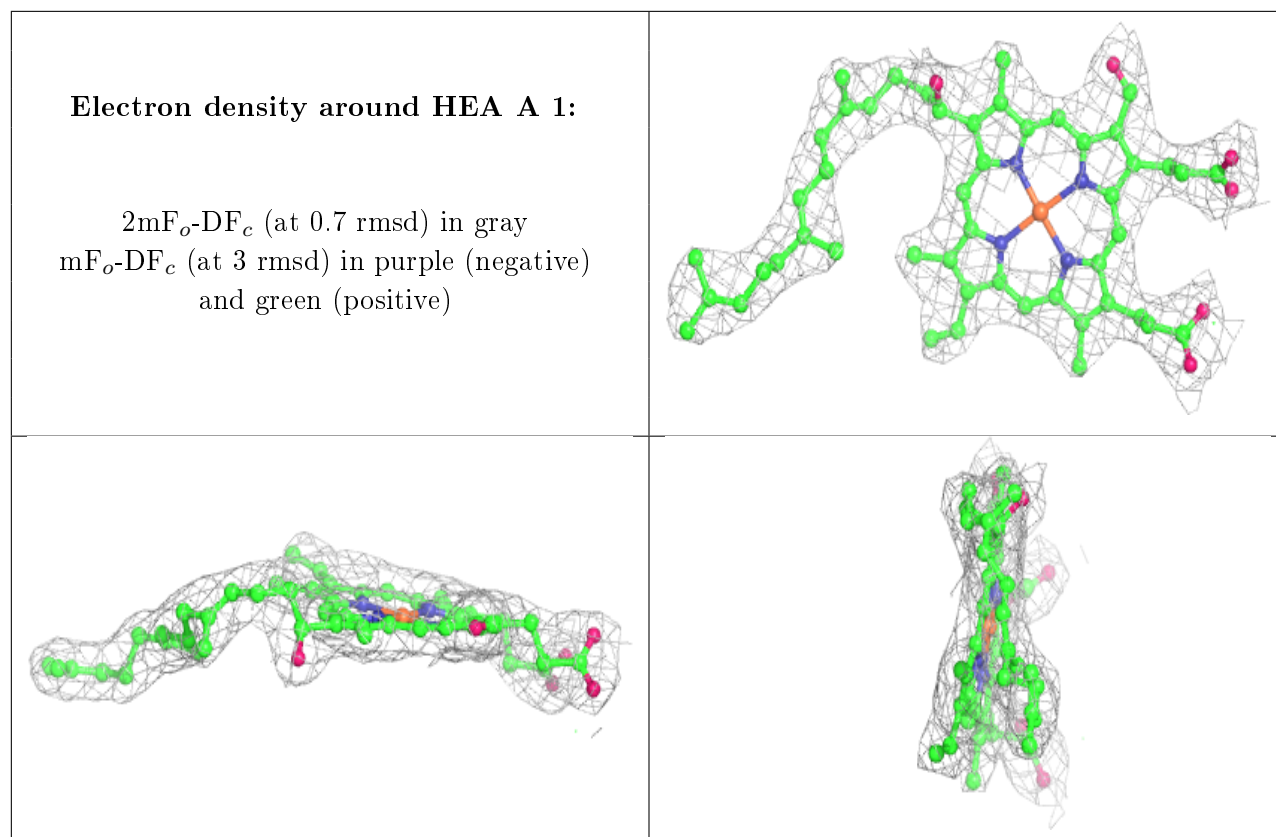

6.5 Other polymers [i](#)

There are no such residues in this entry.