



wwPDB X-ray Structure Validation Summary Report ⓘ

Jun 22, 2024 – 10:17 AM EDT

PDB ID : 4OMD
Title : X-ray structure of human furin in complex with the competitive inhibitor Phac-RVR-Amba
Authors : Dahms, S.O.; Than, M.E.
Deposited on : 2014-01-27
Resolution : 2.70 Å (reported)

This is a wwPDB X-ray Structure Validation Summary Report for a publicly released PDB entry.

We welcome your comments at validation@mail.wwpdb.org

A user guide is available at

<https://www.wwpdb.org/validation/2017/XrayValidationReportHelp>

with specific help available everywhere you see the ⓘ symbol.

The types of validation reports are described at

<http://www.wwpdb.org/validation/2017/FAQs#types>.

The following versions of software and data (see [references ⓘ](#)) were used in the production of this report:

MolProbity : 4.02b-467
Mogul : 1.8.5 (274361), CSD as541be (2020)
Xtriage (Phenix) : 1.13
EDS : 2.37.1
Percentile statistics : 20191225.v01 (using entries in the PDB archive December 25th 2019)
Refmac : 5.8.0158
CCP4 : 7.0.044 (Gargrove)
Ideal geometry (proteins) : Engh & Huber (2001)
Ideal geometry (DNA, RNA) : Parkinson et al. (1996)
Validation Pipeline (wwPDB-VP) : 2.37.1

1 Overall quality at a glance

The following experimental techniques were used to determine the structure:

X-RAY DIFFRACTION



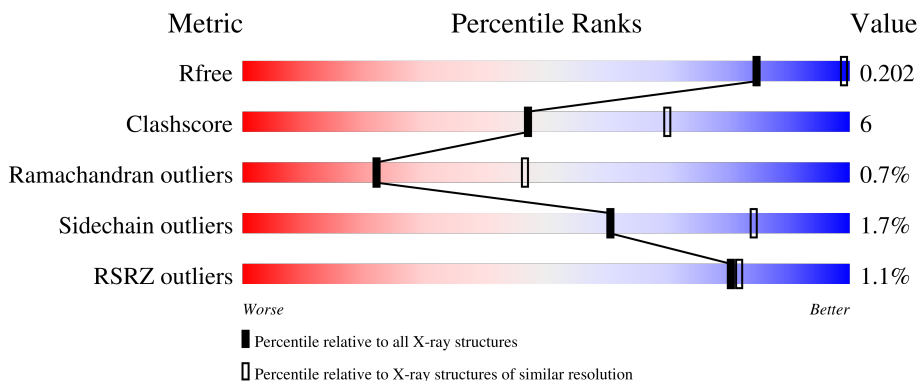

The reported resolution of this entry is 2.70 Å.

Percentile scores (ranging between 0-100) for global validation metrics of the entry are shown in the following graphic. The table shows the number of entries on which the scores are based.

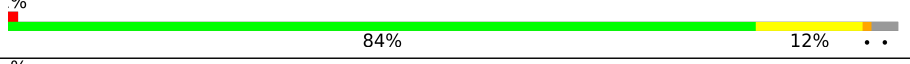

Metric	Whole archive (#Entries)	Similar resolution (#Entries, resolution range(Å))
R_{free}	130704	2808 (2.70-2.70)
Clashscore	141614	3122 (2.70-2.70)
Ramachandran outliers	138981	3069 (2.70-2.70)
Sidechain outliers	138945	3069 (2.70-2.70)
RSRZ outliers	127900	2737 (2.70-2.70)

The table below summarises the geometric issues observed across the polymeric chains and their fit to the electron density. The red, orange, yellow and green segments of the lower bar indicate the fraction of residues that contain outliers for ≥ 3 , 2, 1 and 0 types of geometric quality criteria respectively. A grey segment represents the fraction of residues that are not modelled. The numeric value for each fraction is indicated below the corresponding segment, with a dot representing fractions $\leq 5\%$. The upper red bar (where present) indicates the fraction of residues that have poor fit to the electron density. The numeric value is given above the bar.

Mol	Chain	Length	Quality of chain
1	A	482	 84% 12% ..
1	B	482	 84% 12% ..
1	C	482	 84% 12% ..
1	D	482	 83% 13% ..
1	E	482	 82% 14% ..

Continued on next page...

Continued from previous page...

Mol	Chain	Length	Quality of chain
1	F	482	 <p>%</p> <p>79% 16% . .</p>
2	H	5	 <p>100%</p>
2	I	5	 <p>80% 20%</p>
2	J	5	 <p>100%</p>
2	K	5	 <p>80% 20%</p>
2	L	5	 <p>80% 20%</p>
2	N	5	 <p>80% 20%</p>

2 Entry composition [i](#)

There are 6 unique types of molecules in this entry. The entry contains 22341 atoms, of which 0 are hydrogens and 0 are deuteriums.

In the tables below, the ZeroOcc column contains the number of atoms modelled with zero occupancy, the AltConf column contains the number of residues with at least one atom in alternate conformation and the Trace column contains the number of residues modelled with at most 2 atoms.

- Molecule 1 is a protein called Furin.

Mol	Chain	Residues	Atoms					ZeroOcc	AltConf	Trace
			Total	C	N	O	S			
1	A	466	3559	2204	637	704	14	34	0	0
1	B	465	3552	2199	636	703	14	41	0	0
1	C	466	3559	2204	637	704	14	36	0	0
1	D	465	3552	2199	636	703	14	46	0	0
1	E	465	3552	2199	636	703	14	40	0	0
1	F	465	3552	2199	636	703	14	56	0	0

There are 90 discrepancies between the modelled and reference sequences:

Chain	Residue	Modelled	Actual	Comment	Reference
A	575	SER	-	EXPRESSION TAG	UNP P09958
A	576	GLY	-	EXPRESSION TAG	UNP P09958
A	577	SER	-	EXPRESSION TAG	UNP P09958
A	578	LEU	-	EXPRESSION TAG	UNP P09958
A	579	VAL	-	EXPRESSION TAG	UNP P09958
A	580	PRO	-	EXPRESSION TAG	UNP P09958
A	581	ARG	-	EXPRESSION TAG	UNP P09958
A	582	GLY	-	EXPRESSION TAG	UNP P09958
A	583	SER	-	EXPRESSION TAG	UNP P09958
A	584	HIS	-	EXPRESSION TAG	UNP P09958
A	585	HIS	-	EXPRESSION TAG	UNP P09958
A	586	HIS	-	EXPRESSION TAG	UNP P09958
A	587	HIS	-	EXPRESSION TAG	UNP P09958
A	588	HIS	-	EXPRESSION TAG	UNP P09958
A	589	HIS	-	EXPRESSION TAG	UNP P09958
B	575	SER	-	EXPRESSION TAG	UNP P09958
B	576	GLY	-	EXPRESSION TAG	UNP P09958

Continued on next page...

Continued from previous page...

Chain	Residue	Modelled	Actual	Comment	Reference
B	577	SER	-	EXPRESSION TAG	UNP P09958
B	578	LEU	-	EXPRESSION TAG	UNP P09958
B	579	VAL	-	EXPRESSION TAG	UNP P09958
B	580	PRO	-	EXPRESSION TAG	UNP P09958
B	581	ARG	-	EXPRESSION TAG	UNP P09958
B	582	GLY	-	EXPRESSION TAG	UNP P09958
B	583	SER	-	EXPRESSION TAG	UNP P09958
B	584	HIS	-	EXPRESSION TAG	UNP P09958
B	585	HIS	-	EXPRESSION TAG	UNP P09958
B	586	HIS	-	EXPRESSION TAG	UNP P09958
B	587	HIS	-	EXPRESSION TAG	UNP P09958
B	588	HIS	-	EXPRESSION TAG	UNP P09958
B	589	HIS	-	EXPRESSION TAG	UNP P09958
C	575	SER	-	EXPRESSION TAG	UNP P09958
C	576	GLY	-	EXPRESSION TAG	UNP P09958
C	577	SER	-	EXPRESSION TAG	UNP P09958
C	578	LEU	-	EXPRESSION TAG	UNP P09958
C	579	VAL	-	EXPRESSION TAG	UNP P09958
C	580	PRO	-	EXPRESSION TAG	UNP P09958
C	581	ARG	-	EXPRESSION TAG	UNP P09958
C	582	GLY	-	EXPRESSION TAG	UNP P09958
C	583	SER	-	EXPRESSION TAG	UNP P09958
C	584	HIS	-	EXPRESSION TAG	UNP P09958
C	585	HIS	-	EXPRESSION TAG	UNP P09958
C	586	HIS	-	EXPRESSION TAG	UNP P09958
C	587	HIS	-	EXPRESSION TAG	UNP P09958
C	588	HIS	-	EXPRESSION TAG	UNP P09958
C	589	HIS	-	EXPRESSION TAG	UNP P09958
D	575	SER	-	EXPRESSION TAG	UNP P09958
D	576	GLY	-	EXPRESSION TAG	UNP P09958
D	577	SER	-	EXPRESSION TAG	UNP P09958
D	578	LEU	-	EXPRESSION TAG	UNP P09958
D	579	VAL	-	EXPRESSION TAG	UNP P09958
D	580	PRO	-	EXPRESSION TAG	UNP P09958
D	581	ARG	-	EXPRESSION TAG	UNP P09958
D	582	GLY	-	EXPRESSION TAG	UNP P09958
D	583	SER	-	EXPRESSION TAG	UNP P09958
D	584	HIS	-	EXPRESSION TAG	UNP P09958
D	585	HIS	-	EXPRESSION TAG	UNP P09958
D	586	HIS	-	EXPRESSION TAG	UNP P09958
D	587	HIS	-	EXPRESSION TAG	UNP P09958
D	588	HIS	-	EXPRESSION TAG	UNP P09958

Continued on next page...

Continued from previous page...

Chain	Residue	Modelled	Actual	Comment	Reference
D	589	HIS	-	EXPRESSION TAG	UNP P09958
E	575	SER	-	EXPRESSION TAG	UNP P09958
E	576	GLY	-	EXPRESSION TAG	UNP P09958
E	577	SER	-	EXPRESSION TAG	UNP P09958
E	578	LEU	-	EXPRESSION TAG	UNP P09958
E	579	VAL	-	EXPRESSION TAG	UNP P09958
E	580	PRO	-	EXPRESSION TAG	UNP P09958
E	581	ARG	-	EXPRESSION TAG	UNP P09958
E	582	GLY	-	EXPRESSION TAG	UNP P09958
E	583	SER	-	EXPRESSION TAG	UNP P09958
E	584	HIS	-	EXPRESSION TAG	UNP P09958
E	585	HIS	-	EXPRESSION TAG	UNP P09958
E	586	HIS	-	EXPRESSION TAG	UNP P09958
E	587	HIS	-	EXPRESSION TAG	UNP P09958
E	588	HIS	-	EXPRESSION TAG	UNP P09958
E	589	HIS	-	EXPRESSION TAG	UNP P09958
F	575	SER	-	EXPRESSION TAG	UNP P09958
F	576	GLY	-	EXPRESSION TAG	UNP P09958
F	577	SER	-	EXPRESSION TAG	UNP P09958
F	578	LEU	-	EXPRESSION TAG	UNP P09958
F	579	VAL	-	EXPRESSION TAG	UNP P09958
F	580	PRO	-	EXPRESSION TAG	UNP P09958
F	581	ARG	-	EXPRESSION TAG	UNP P09958
F	582	GLY	-	EXPRESSION TAG	UNP P09958
F	583	SER	-	EXPRESSION TAG	UNP P09958
F	584	HIS	-	EXPRESSION TAG	UNP P09958
F	585	HIS	-	EXPRESSION TAG	UNP P09958
F	586	HIS	-	EXPRESSION TAG	UNP P09958
F	587	HIS	-	EXPRESSION TAG	UNP P09958
F	588	HIS	-	EXPRESSION TAG	UNP P09958
F	589	HIS	-	EXPRESSION TAG	UNP P09958

- Molecule 2 is a protein called phenylacetyl-Arg-Val-Arg-(amidomethyl)benzamidine.

Mol	Chain	Residues	Atoms				ZeroOcc	AltConf	Trace
2	H	5	Total	C	N	O	6	0	0
			49	33	12	4			
2	I	5	Total	C	N	O	6	0	0
			49	33	12	4			
2	J	5	Total	C	N	O	6	0	0
			49	33	12	4			
2	K	5	Total	C	N	O	6	0	0
			49	33	12	4			

Continued on next page...

Continued from previous page...

Mol	Chain	Residues	Atoms				ZeroOcc	AltConf	Trace
2	L	5	Total	C	N	O	6	0	0
			49	33	12	4			
2	N	5	Total	C	N	O	6	0	0
			49	33	12	4			

- Molecule 3 is FORMIC ACID (three-letter code: FMT) (formula: CH₂O₂).

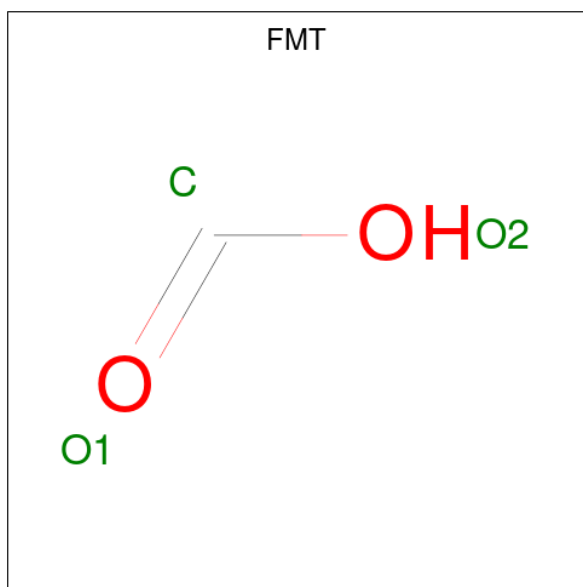

Mol	Chain	Residues	Atoms			ZeroOcc	AltConf
3	A	1	Total	C	O	0	0
			3	1	2		
3	A	1	Total	C	O	0	0
			3	1	2		
3	B	1	Total	C	O	0	0
			3	1	2		
3	B	1	Total	C	O	0	0
			3	1	2		
3	C	1	Total	C	O	0	0
			3	1	2		
3	C	1	Total	C	O	0	0
			3	1	2		
3	D	1	Total	C	O	0	0
			3	1	2		
3	D	1	Total	C	O	0	0
			3	1	2		
3	E	1	Total	C	O	0	0
			3	1	2		

Continued on next page...

Continued from previous page...

Mol	Chain	Residues	Atoms	ZeroOcc	AltConf
3	E	1	Total C O 3 1 2	0	0
3	F	1	Total C O 3 1 2	0	0
3	F	1	Total C O 3 1 2	0	0

- Molecule 4 is CALCIUM ION (three-letter code: CA) (formula: Ca).

Mol	Chain	Residues	Atoms	ZeroOcc	AltConf
4	A	3	Total Ca 3 3	0	0
4	B	3	Total Ca 3 3	0	0
4	C	3	Total Ca 3 3	0	0
4	D	3	Total Ca 3 3	0	0
4	E	3	Total Ca 3 3	0	0
4	F	3	Total Ca 3 3	0	0

- Molecule 5 is SODIUM ION (three-letter code: NA) (formula: Na).

Mol	Chain	Residues	Atoms	ZeroOcc	AltConf
5	A	1	Total Na 1 1	0	0
5	B	1	Total Na 1 1	0	0
5	C	1	Total Na 1 1	0	0
5	D	1	Total Na 1 1	0	0
5	E	1	Total Na 1 1	0	0
5	F	1	Total Na 1 1	0	0

- Molecule 6 is water.

Mol	Chain	Residues	Atoms	ZeroOcc	AltConf
6	A	112	Total O 112 112	0	0
6	B	96	Total O 96 96	0	0
6	C	113	Total O 113 113	0	0
6	D	125	Total O 125 125	0	0
6	E	106	Total O 106 106	0	0
6	F	94	Total O 94 94	0	0
6	H	2	Total O 2 2	0	0
6	I	3	Total O 3 3	0	0
6	J	3	Total O 3 3	0	0
6	K	2	Total O 2 2	0	0
6	L	3	Total O 3 3	0	0
6	N	2	Total O 2 2	0	0

3 Residue-property plots (i)

These plots are drawn for all protein, RNA, DNA and oligosaccharide chains in the entry. The first graphic for a chain summarises the proportions of the various outlier classes displayed in the second graphic. The second graphic shows the sequence view annotated by issues in geometry and electron density. Residues are color-coded according to the number of geometric quality criteria for which they contain at least one outlier: green = 0, yellow = 1, orange = 2 and red = 3 or more. A red dot above a residue indicates a poor fit to the electron density (RSRZ > 2). Stretches of 2 or more consecutive residues without any outlier are shown as a green connector. Residues present in the sample, but not in the model, are shown in grey.

● Molecule 1: Furin

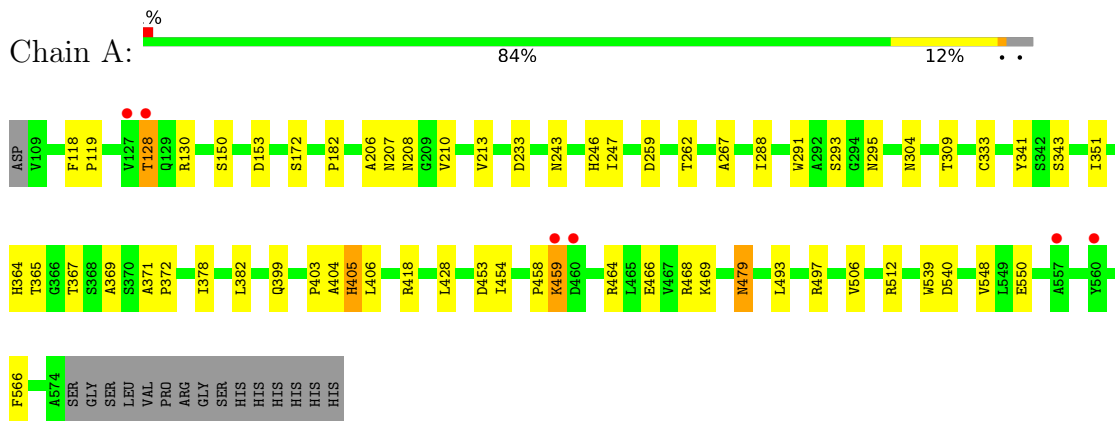

● Molecule 1: Furin

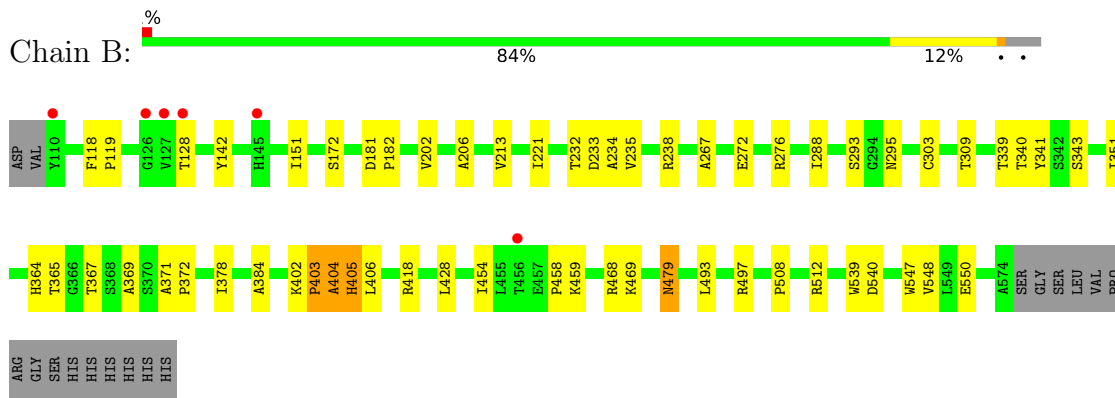

● Molecule 1: Furin

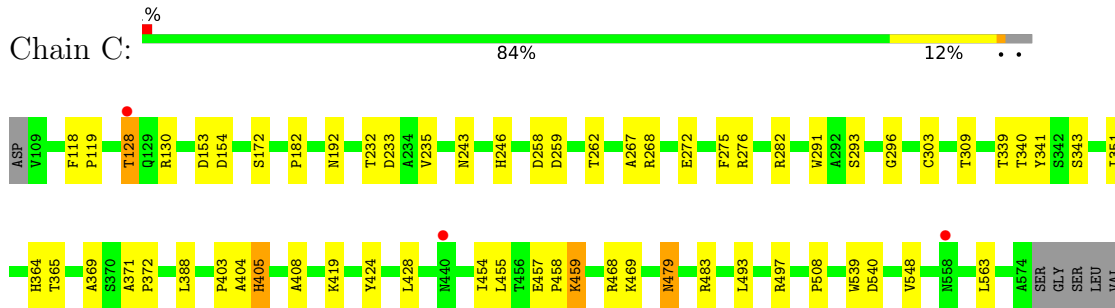

PRO
ARG
GLY
SER
HIS
HIS
HIS
HIS
HIS

- Molecule 1: Furin

Chain D: 83% 13%

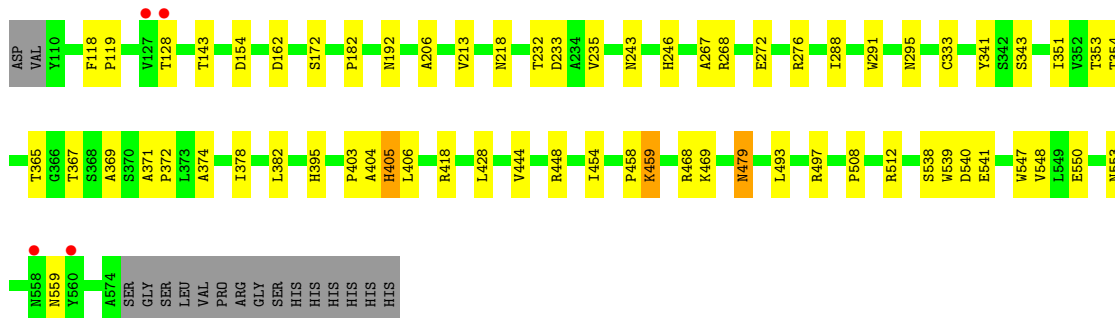

- Molecule 1: Furin

Chain E: 82% 14%

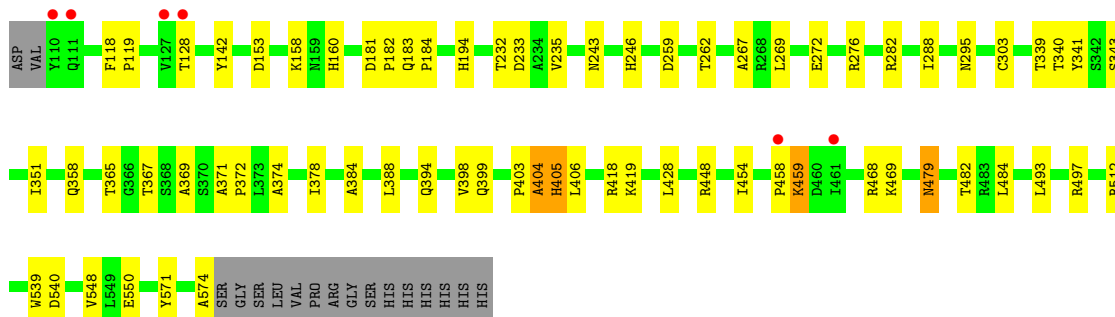

- Molecule 1: Furin

Chain F: 79% 16%

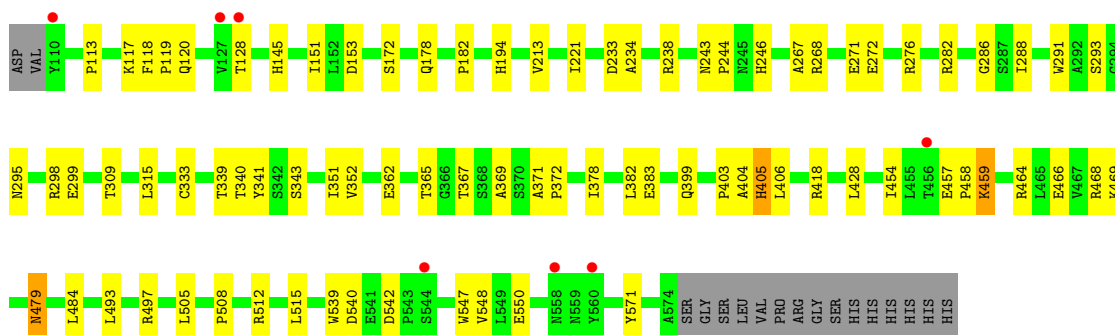

- Molecule 2: phenylacetyl-Arg-Val-Arg-(amidomethyl)benzamidine

Chain H: 100%

There are no outlier residues recorded for this chain.

- Molecule 2: phenylacetyl-Arg-Val-Arg-(amidomethyl)benzamide

Chain I:  80% 20%



- Molecule 2: phenylacetyl-Arg-Val-Arg-(amidomethyl)benzamide

Chain J:  100%

There are no outlier residues recorded for this chain.

- Molecule 2: phenylacetyl-Arg-Val-Arg-(amidomethyl)benzamide

Chain K:  80% 20%



- Molecule 2: phenylacetyl-Arg-Val-Arg-(amidomethyl)benzamide

Chain L:  80% 20%



- Molecule 2: phenylacetyl-Arg-Val-Arg-(amidomethyl)benzamide

Chain N:  80% 20%



4 Data and refinement statistics

Property	Value	Source
Space group	P 21 21 21	Depositor
Cell constants a, b, c, α , β , γ	141.62Å 152.61Å 168.54Å 90.00° 90.00° 90.00°	Depositor
Resolution (Å)	50.00 – 2.70 47.88 – 2.70	Depositor EDS
% Data completeness (in resolution range)	99.4 (50.00-2.70) 99.5 (47.88-2.70)	Depositor EDS
R_{merge}	(Not available)	Depositor
R_{sym}	0.13	Depositor
$\langle I/\sigma(I) \rangle$ ¹	2.50 (at 2.69Å)	Xtrriage
Refinement program	CNS	Depositor
R, R_{free}	0.193 , 0.218 0.179 , 0.202	Depositor DCC
R_{free} test set	5025 reflections (5.02%)	wwPDB-VP
Wilson B-factor (Å ²)	28.5	Xtrriage
Anisotropy	0.403	Xtrriage
Bulk solvent k_{sol} (e/Å ³), B_{sol} (Å ²)	0.34 , 34.9	EDS
L-test for twinning ²	$\langle L \rangle = 0.49$, $\langle L^2 \rangle = 0.33$	Xtrriage
Estimated twinning fraction	No twinning to report.	Xtrriage
F_o, F_c correlation	0.94	EDS
Total number of atoms	22341	wwPDB-VP
Average B, all atoms (Å ²)	23.0	wwPDB-VP

Xtrriage's analysis on translational NCS is as follows: *The largest off-origin peak in the Patterson function is 3.44% of the height of the origin peak. No significant pseudotranslation is detected.*

¹Intensities estimated from amplitudes.

²Theoretical values of $\langle |L| \rangle$, $\langle L^2 \rangle$ for acentric reflections are 0.5, 0.333 respectively for untwinned datasets, and 0.375, 0.2 for perfectly twinned datasets.

5 Model quality [i](#)

5.1 Standard geometry [i](#)

Bond lengths and bond angles in the following residue types are not validated in this section: FMT, HY1, 00S, CA, NA

The Z score for a bond length (or angle) is the number of standard deviations the observed value is removed from the expected value. A bond length (or angle) with $|Z| > 5$ is considered an outlier worth inspection. RMSZ is the root-mean-square of all Z scores of the bond lengths (or angles).

Mol	Chain	Bond lengths		Bond angles	
		RMSZ	# Z >5	RMSZ	# Z >5
1	A	0.37	0/3641	0.62	0/4964
1	B	0.36	0/3634	0.62	0/4954
1	C	0.37	0/3641	0.62	0/4964
1	D	0.36	0/3634	0.62	0/4954
1	E	0.36	0/3634	0.62	0/4954
1	F	0.35	0/3634	0.62	0/4954
2	H	0.25	0/28	0.71	0/35
2	I	0.26	0/28	0.73	0/35
2	J	0.24	0/28	0.73	0/35
2	K	0.21	0/28	0.69	0/35
2	L	0.28	0/28	0.77	0/35
2	N	0.27	0/28	0.74	0/35
All	All	0.36	0/21986	0.62	0/29954

There are no bond length outliers.

There are no bond angle outliers.

There are no chirality outliers.

There are no planarity outliers.

5.2 Too-close contacts [i](#)

In the following table, the Non-H and H(model) columns list the number of non-hydrogen atoms and hydrogen atoms in the chain respectively. The H(added) column lists the number of hydrogen atoms added and optimized by MolProbity. The Clashes column lists the number of clashes within the asymmetric unit, whereas Symm-Clashes lists symmetry-related clashes.

Mol	Chain	Non-H	H(model)	H(added)	Clashes	Symm-Clashes
1	A	3559	0	3376	41	0

Continued on next page...

Continued from previous page...

Mol	Chain	Non-H	H(model)	H(added)	Clashes	Symm-Clashes
1	B	3552	0	3367	39	0
1	C	3559	0	3376	39	0
1	D	3552	0	3367	40	0
1	E	3552	0	3367	46	0
1	F	3552	0	3367	53	0
2	H	49	0	50	0	0
2	I	49	0	50	1	0
2	J	49	0	50	0	0
2	K	49	0	50	1	0
2	L	49	0	50	2	0
2	N	49	0	50	3	0
3	A	6	0	2	0	0
3	B	6	0	2	0	0
3	C	6	0	2	0	0
3	D	6	0	2	0	0
3	E	6	0	2	0	0
3	F	6	0	2	0	0
4	A	3	0	0	0	0
4	B	3	0	0	0	0
4	C	3	0	0	0	0
4	D	3	0	0	0	0
4	E	3	0	0	0	0
4	F	3	0	0	0	0
5	A	1	0	0	0	0
5	B	1	0	0	0	0
5	C	1	0	0	0	0
5	D	1	0	0	0	0
5	E	1	0	0	0	0
5	F	1	0	0	0	0
6	A	112	0	0	1	0
6	B	96	0	0	0	0
6	C	113	0	0	3	0
6	D	125	0	0	1	0
6	E	106	0	0	2	0
6	F	94	0	0	4	0
6	H	2	0	0	0	0
6	I	3	0	0	0	0
6	J	3	0	0	0	0
6	K	2	0	0	0	0
6	L	3	0	0	0	0
6	N	2	0	0	0	0
All	All	22341	0	20532	259	0

The all-atom clashscore is defined as the number of clashes found per 1000 atoms (including hydrogen atoms). The all-atom clashscore for this structure is 6.

The worst 5 of 259 close contacts within the same asymmetric unit are listed below, sorted by their clash magnitude.

Atom-1	Atom-2	Interatomic distance (Å)	Clash overlap (Å)
1:B:479:ASN:HD22	1:B:479:ASN:H	1.02	0.95
1:A:479:ASN:H	1:A:479:ASN:HD22	1.13	0.91
1:E:479:ASN:HD22	1:E:479:ASN:H	1.06	0.90
1:B:454:ILE:HD12	1:B:469:LYS:HG2	1.51	0.90
1:D:479:ASN:H	1:D:479:ASN:HD22	1.24	0.86

There are no symmetry-related clashes.

5.3 Torsion angles [i](#)

5.3.1 Protein backbone [i](#)

In the following table, the Percentiles column shows the percent Ramachandran outliers of the chain as a percentile score with respect to all X-ray entries followed by that with respect to entries of similar resolution.

The Analysed column shows the number of residues for which the backbone conformation was analysed, and the total number of residues.

Mol	Chain	Analysed	Favoured	Allowed	Outliers	Percentiles	
1	A	464/482 (96%)	441 (95%)	20 (4%)	3 (1%)	25	50
1	B	463/482 (96%)	440 (95%)	19 (4%)	4 (1%)	17	40
1	C	464/482 (96%)	442 (95%)	19 (4%)	3 (1%)	25	50
1	D	463/482 (96%)	441 (95%)	19 (4%)	3 (1%)	25	50
1	E	463/482 (96%)	440 (95%)	19 (4%)	4 (1%)	17	40
1	F	463/482 (96%)	441 (95%)	19 (4%)	3 (1%)	25	50
2	H	2/5 (40%)	2 (100%)	0	0	100	100
2	I	2/5 (40%)	2 (100%)	0	0	100	100
2	J	2/5 (40%)	2 (100%)	0	0	100	100
2	K	2/5 (40%)	2 (100%)	0	0	100	100
2	L	2/5 (40%)	2 (100%)	0	0	100	100
2	N	2/5 (40%)	2 (100%)	0	0	100	100
All	All	2792/2922 (96%)	2657 (95%)	115 (4%)	20 (1%)	22	46

5 of 20 Ramachandran outliers are listed below:

Mol	Chain	Res	Type
1	C	128	THR
1	D	128	THR
1	E	128	THR
1	F	128	THR
1	A	128	THR

5.3.2 Protein sidechains [i](#)

In the following table, the Percentiles column shows the percent sidechain outliers of the chain as a percentile score with respect to all X-ray entries followed by that with respect to entries of similar resolution.

The Analysed column shows the number of residues for which the sidechain conformation was analysed, and the total number of residues.

Mol	Chain	Analysed	Rotameric	Outliers	Percentiles	
1	A	376/390 (96%)	369 (98%)	7 (2%)	57	82
1	B	375/390 (96%)	371 (99%)	4 (1%)	73	90
1	C	376/390 (96%)	368 (98%)	8 (2%)	53	80
1	D	375/390 (96%)	369 (98%)	6 (2%)	62	85
1	E	375/390 (96%)	368 (98%)	7 (2%)	57	82
1	F	375/390 (96%)	368 (98%)	7 (2%)	57	82
2	H	3/3 (100%)	3 (100%)	0	100	100
2	I	3/3 (100%)	3 (100%)	0	100	100
2	J	3/3 (100%)	3 (100%)	0	100	100
2	K	3/3 (100%)	3 (100%)	0	100	100
2	L	3/3 (100%)	3 (100%)	0	100	100
2	N	3/3 (100%)	3 (100%)	0	100	100
All	All	2270/2358 (96%)	2231 (98%)	39 (2%)	60	84

5 of 39 residues with a non-rotameric sidechain are listed below:

Mol	Chain	Res	Type
1	E	406	LEU
1	F	406	LEU
1	E	459	LYS
1	F	153	ASP

Continued on next page...

Continued from previous page...

Mol	Chain	Res	Type
1	F	479	ASN

Sometimes sidechains can be flipped to improve hydrogen bonding and reduce clashes. 5 of 21 such sidechains are listed below:

Mol	Chain	Res	Type
1	E	346	GLN
1	F	346	GLN
1	F	537	HIS
1	F	387	ASN
1	E	479	ASN

5.3.3 RNA [i](#)

There are no RNA molecules in this entry.

5.4 Non-standard residues in protein, DNA, RNA chains [i](#)

There are no non-standard protein/DNA/RNA residues in this entry.

5.5 Carbohydrates [i](#)

There are no monosaccharides in this entry.

5.6 Ligand geometry [i](#)

Of 36 ligands modelled in this entry, 24 are monoatomic - leaving 12 for Mogul analysis.

In the following table, the Counts columns list the number of bonds (or angles) for which Mogul statistics could be retrieved, the number of bonds (or angles) that are observed in the model and the number of bonds (or angles) that are defined in the Chemical Component Dictionary. The Link column lists molecule types, if any, to which the group is linked. The Z score for a bond length (or angle) is the number of standard deviations the observed value is removed from the expected value. A bond length (or angle) with $|Z| > 2$ is considered an outlier worth inspection. RMSZ is the root-mean-square of all Z scores of the bond lengths (or angles).

Mol	Type	Chain	Res	Link	Bond lengths			Bond angles		
					Counts	RMSZ	$\# Z > 2$	Counts	RMSZ	$\# Z > 2$
3	FMT	D	602	-	2,2,2	0.61	0	1,1,1	0.07	0
3	FMT	E	601	-	2,2,2	0.63	0	1,1,1	0.07	0
3	FMT	A	602	-	2,2,2	0.64	0	1,1,1	0.06	0

Mol	Type	Chain	Res	Link	Bond lengths			Bond angles		
					Counts	RMSZ	# Z > 2	Counts	RMSZ	# Z > 2
3	FMT	C	601	-	2,2,2	0.71	0	1,1,1	0.03	0
3	FMT	E	602	-	2,2,2	0.64	0	1,1,1	0.07	0
3	FMT	C	602	-	2,2,2	0.65	0	1,1,1	0.06	0
3	FMT	B	601	-	2,2,2	0.71	0	1,1,1	0.01	0
3	FMT	A	601	-	2,2,2	0.69	0	1,1,1	0.02	0
3	FMT	D	601	-	2,2,2	0.67	0	1,1,1	0.03	0
3	FMT	F	602	-	2,2,2	0.64	0	1,1,1	0.07	0
3	FMT	F	601	-	2,2,2	0.69	0	1,1,1	0.02	0
3	FMT	B	602	-	2,2,2	0.63	0	1,1,1	0.06	0

There are no bond length outliers.

There are no bond angle outliers.

There are no chirality outliers.

There are no torsion outliers.

There are no ring outliers.

No monomer is involved in short contacts.

5.7 Other polymers [i](#)

There are no such residues in this entry.

5.8 Polymer linkage issues [i](#)

There are no chain breaks in this entry.

6 Fit of model and data [i](#)

6.1 Protein, DNA and RNA chains [i](#)

In the following table, the column labelled '#RSRZ > 2' contains the number (and percentage) of RSRZ outliers, followed by percent RSRZ outliers for the chain as percentile scores relative to all X-ray entries and entries of similar resolution. The OWAB column contains the minimum, median, 95th percentile and maximum values of the occupancy-weighted average B-factor per residue. The column labelled 'Q < 0.9' lists the number of (and percentage) of residues with an average occupancy less than 0.9.

Mol	Chain	Analysed	<RSRZ>	#RSRZ>2	OWAB(Å ²)	Q<0.9
1	A	466/482 (96%)	-0.31	6 (1%) 77 78	11, 21, 35, 50	13 (2%)
1	B	465/482 (96%)	-0.25	6 (1%) 77 78	12, 22, 36, 54	15 (3%)
1	C	466/482 (96%)	-0.33	3 (0%) 89 91	10, 20, 34, 48	14 (3%)
1	D	465/482 (96%)	-0.31	4 (0%) 84 85	12, 22, 37, 54	18 (3%)
1	E	465/482 (96%)	-0.26	6 (1%) 77 78	13, 22, 37, 56	13 (2%)
1	F	465/482 (96%)	-0.23	7 (1%) 73 76	13, 24, 38, 56	19 (4%)
2	H	3/5 (60%)	-0.82	0 100 100	16, 16, 20, 22	0
2	I	3/5 (60%)	-0.87	0 100 100	19, 19, 24, 26	0
2	J	3/5 (60%)	-0.85	0 100 100	18, 18, 20, 24	0
2	K	3/5 (60%)	-0.95	0 100 100	15, 15, 15, 21	0
2	L	3/5 (60%)	-0.72	0 100 100	20, 20, 22, 25	0
2	N	3/5 (60%)	-0.71	0 100 100	20, 20, 23, 26	0
All	All	2810/2922 (96%)	-0.29	32 (1%) 80 82	10, 22, 36, 56	92 (3%)

The worst 5 of 32 RSRZ outliers are listed below:

Mol	Chain	Res	Type	RSRZ
1	E	127	VAL	5.1
1	F	127	VAL	4.1
1	A	128	THR	3.9
1	E	128	THR	3.9
1	A	127	VAL	3.6

6.2 Non-standard residues in protein, DNA, RNA chains [i](#)

There are no non-standard protein/DNA/RNA residues in this entry.

6.3 Carbohydrates [i](#)

There are no monosaccharides in this entry.

6.4 Ligands [i](#)

In the following table, the Atoms column lists the number of modelled atoms in the group and the number defined in the chemical component dictionary. The B-factors column lists the minimum, median, 95th percentile and maximum values of B factors of atoms in the group. The column labelled 'Q< 0.9' lists the number of atoms with occupancy less than 0.9.

Mol	Type	Chain	Res	Atoms	RSCC	RSR	B-factors(Å ²)	Q<0.9
3	FMT	C	601	3/3	0.84	0.24	33,33,34,37	0
3	FMT	B	601	3/3	0.88	0.24	29,29,32,34	0
3	FMT	F	601	3/3	0.88	0.25	32,32,36,37	0
4	CA	B	605	1/1	0.90	0.07	42,42,42,42	0
4	CA	D	605	1/1	0.90	0.05	32,32,32,32	0
3	FMT	D	601	3/3	0.94	0.23	28,28,29,30	0
4	CA	E	605	1/1	0.94	0.04	35,35,35,35	0
4	CA	C	605	1/1	0.95	0.05	33,33,33,33	0
3	FMT	A	601	3/3	0.96	0.23	26,26,28,31	0
5	NA	C	606	1/1	0.96	0.10	21,21,21,21	0
5	NA	F	606	1/1	0.96	0.09	25,25,25,25	0
4	CA	F	604	1/1	0.97	0.14	17,17,17,17	0
4	CA	F	605	1/1	0.97	0.09	35,35,35,35	0
3	FMT	E	601	3/3	0.97	0.28	25,25,26,27	0
3	FMT	D	602	3/3	0.97	0.20	22,22,26,30	0
4	CA	A	603	1/1	0.98	0.04	18,18,18,18	0
4	CA	E	604	1/1	0.98	0.11	17,17,17,17	0
4	CA	A	605	1/1	0.98	0.05	35,35,35,35	0
4	CA	F	603	1/1	0.98	0.05	29,29,29,29	0
4	CA	B	603	1/1	0.98	0.05	32,32,32,32	0
4	CA	B	604	1/1	0.98	0.08	18,18,18,18	0
3	FMT	C	602	3/3	0.98	0.20	34,34,35,35	0
3	FMT	F	602	3/3	0.98	0.19	19,19,21,23	0
4	CA	E	603	1/1	0.99	0.03	28,28,28,28	0
3	FMT	E	602	3/3	0.99	0.19	22,22,22,25	0
4	CA	A	604	1/1	0.99	0.10	15,15,15,15	0
4	CA	C	603	1/1	0.99	0.04	18,18,18,18	0
3	FMT	B	602	3/3	0.99	0.17	32,32,33,33	0
4	CA	D	603	1/1	0.99	0.05	30,30,30,30	0
5	NA	A	606	1/1	0.99	0.12	11,11,11,11	0
5	NA	B	606	1/1	0.99	0.13	20,20,20,20	0
4	CA	D	604	1/1	0.99	0.11	14,14,14,14	0

Continued on next page...

Continued from previous page...

Mol	Type	Chain	Res	Atoms	RSCC	RSR	B-factors(\AA^2)	Q<0.9
5	NA	D	606	1/1	0.99	0.11	21,21,21,21	0
5	NA	E	606	1/1	0.99	0.12	17,17,17,17	0
3	FMT	A	602	3/3	0.99	0.24	33,33,33,33	0
4	CA	C	604	1/1	1.00	0.09	20,20,20,20	0

6.5 Other polymers [i](#)

There are no such residues in this entry.