



wwPDB X-ray Structure Validation Summary Report ⓘ

Aug 20, 2023 – 03:57 PM EDT

PDB ID : 2ONM
Title : Human Mitochondrial Aldehyde Dehydrogenase Asian Variant, ALDH2*2, complexed with NAD⁺
Authors : Larson, H.N.; Hurley, T.D.
Deposited on : 2007-01-24
Resolution : 2.50 Å (reported)

This is a wwPDB X-ray Structure Validation Summary Report for a publicly released PDB entry.

We welcome your comments at validation@mail.wwpdb.org

A user guide is available at

<https://www.wwpdb.org/validation/2017/XrayValidationReportHelp>

with specific help available everywhere you see the ⓘ symbol.

The types of validation reports are described at

<http://www.wwpdb.org/validation/2017/FAQs#types>.

The following versions of software and data (see [references ⓘ](#)) were used in the production of this report:

MolProbity : 4.02b-467
Mogul : 1.8.5 (274361), CSD as541be (2020)
Xtrriage (Phenix) : 1.13
EDS : 2.35
buster-report : 1.1.7 (2018)
Percentile statistics : 20191225.v01 (using entries in the PDB archive December 25th 2019)
Refmac : 5.8.0158
CCP4 : 7.0.044 (Gargrove)
Ideal geometry (proteins) : Engh & Huber (2001)
Ideal geometry (DNA, RNA) : Parkinson et al. (1996)
Validation Pipeline (wwPDB-VP) : 2.35

1 Overall quality at a glance

The following experimental techniques were used to determine the structure:

X-RAY DIFFRACTION

The reported resolution of this entry is 2.50 Å.

Percentile scores (ranging between 0-100) for global validation metrics of the entry are shown in the following graphic. The table shows the number of entries on which the scores are based.

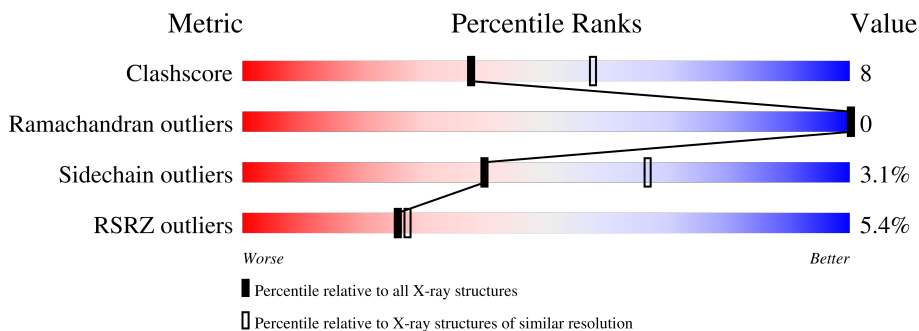







Metric	Whole archive (#Entries)	Similar resolution (#Entries, resolution range(Å))
Clashscore	141614	5346 (2.50-2.50)
Ramachandran outliers	138981	5231 (2.50-2.50)
Sidechain outliers	138945	5233 (2.50-2.50)
RSRZ outliers	127900	4559 (2.50-2.50)

The table below summarises the geometric issues observed across the polymeric chains and their fit to the electron density. The red, orange, yellow and green segments of the lower bar indicate the fraction of residues that contain outliers for ≥ 3 , 2, 1 and 0 types of geometric quality criteria respectively. A grey segment represents the fraction of residues that are not modelled. The numeric value for each fraction is indicated below the corresponding segment, with a dot representing fractions $\leq 5\%$. The upper red bar (where present) indicates the fraction of residues that have poor fit to the electron density. The numeric value is given above the bar.

Mol	Chain	Length	Quality of chain
1	A	500	
1	B	500	
1	C	500	
1	D	500	
1	E	500	
1	F	500	

Continued on next page...

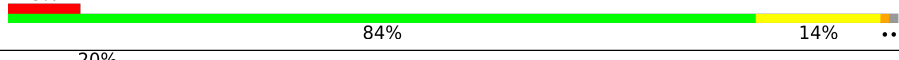
Continued from previous page...

Mol	Chain	Length	Quality of chain
1	G	500	 % 82% 16% ..
1	H	500	 2% 80% 17% ..
1	I	500	 4% 83% 15% ..
1	J	500	 8% 77% 20% ..
1	K	500	 8% 84% 14% ..
1	L	500	 20% 80% 18% ..

2 Entry composition [i](#)

There are 7 unique types of molecules in this entry. The entry contains 48124 atoms, of which 0 are hydrogens and 0 are deuteriums.

In the tables below, the ZeroOcc column contains the number of atoms modelled with zero occupancy, the AltConf column contains the number of residues with at least one atom in alternate conformation and the Trace column contains the number of residues modelled with at most 2 atoms.

- Molecule 1 is a protein called Aldehyde dehydrogenase, mitochondrial precursor.

Mol	Chain	Residues	Atoms					ZeroOcc	AltConf	Trace
			Total	C	N	O	S			
1	A	494	3798	2416	649	715	18	0	0	0
1	B	494	3798	2416	649	715	18	0	0	0
1	C	494	3798	2416	649	715	18	0	0	0
1	D	494	3798	2416	649	715	18	0	0	0
1	E	494	3798	2416	649	715	18	0	0	0
1	F	494	3798	2416	649	715	18	0	0	0
1	G	494	3798	2416	649	715	18	0	0	0
1	H	494	3798	2416	649	715	18	0	0	0
1	I	494	3798	2416	649	715	18	0	0	0
1	J	494	3798	2416	649	715	18	0	0	0
1	K	494	3798	2416	649	715	18	0	0	0
1	L	494	3798	2416	649	715	18	0	0	0

There are 12 discrepancies between the modelled and reference sequences:

Chain	Residue	Modelled	Actual	Comment	Reference
A	487	LYS	GLU	engineered mutation	UNP P05091
B	487	LYS	GLU	engineered mutation	UNP P05091
C	487	LYS	GLU	engineered mutation	UNP P05091
D	487	LYS	GLU	engineered mutation	UNP P05091
E	487	LYS	GLU	engineered mutation	UNP P05091

Continued on next page...

Continued from previous page...

Chain	Residue	Modelled	Actual	Comment	Reference
F	487	LYS	GLU	engineered mutation	UNP P05091
G	487	LYS	GLU	engineered mutation	UNP P05091
H	487	LYS	GLU	engineered mutation	UNP P05091
I	487	LYS	GLU	engineered mutation	UNP P05091
J	487	LYS	GLU	engineered mutation	UNP P05091
K	487	LYS	GLU	engineered mutation	UNP P05091
L	487	LYS	GLU	engineered mutation	UNP P05091

- Molecule 2 is SODIUM ION (three-letter code: NA) (formula: Na).

Mol	Chain	Residues	Atoms	ZeroOcc	AltConf
2	A	1	Total Na 1 1	0	0
2	B	2	Total Na 2 2	0	0
2	C	2	Total Na 2 2	0	0
2	D	1	Total Na 1 1	0	0
2	E	1	Total Na 1 1	0	0
2	F	2	Total Na 2 2	0	0
2	G	2	Total Na 2 2	0	0
2	H	1	Total Na 1 1	0	0
2	I	1	Total Na 1 1	0	0
2	J	1	Total Na 1 1	0	0
2	K	2	Total Na 2 2	0	0
2	L	1	Total Na 1 1	0	0

- Molecule 3 is ADENOSINE-5'-DIPHOSPHATE (three-letter code: ADP) (formula: C₁₀H₁₅N₅O₁₀P₂).



Mol	Chain	Residues	Atoms				ZeroOcc	AltConf	
			Total	C	N	O			P
3	A	1	Total	C	N	O	P	0	1
			54	20	10	20	4		
3	D	1	Total	C	N	O	P	0	1
			54	20	10	20	4		
3	E	1	Total	C	N	O	P	0	0
			27	10	5	10	2		
3	I	1	Total	C	N	O	P	0	0
			27	10	5	10	2		
3	J	1	Total	C	N	O	P	0	0
			27	10	5	10	2		
3	K	1	Total	C	N	O	P	0	0
			27	10	5	10	2		
3	L	1	Total	C	N	O	P	0	0
			27	10	5	10	2		

- Molecule 4 is 1,2-ETHANEDIOL (three-letter code: EDO) (formula: C₂H₆O₂).



Mol	Chain	Residues	Atoms	ZeroOcc	AltConf
4	A	1	Total C O 4 2 2	0	0
4	B	1	Total C O 4 2 2	0	0
4	B	1	Total C O 4 2 2	0	0
4	B	1	Total C O 4 2 2	0	0
4	C	1	Total C O 4 2 2	0	0
4	C	1	Total C O 4 2 2	0	0
4	D	1	Total C O 4 2 2	0	0
4	D	1	Total C O 4 2 2	0	0
4	E	1	Total C O 4 2 2	0	0
4	E	1	Total C O 4 2 2	0	0
4	E	1	Total C O 4 2 2	0	0
4	F	1	Total C O 4 2 2	0	0
4	F	1	Total C O 4 2 2	0	0
4	F	1	Total C O 4 2 2	0	0

Continued on next page...

Continued from previous page...

Mol	Chain	Residues	Atoms	ZeroOcc	AltConf
4	F	1	Total C O 4 2 2	0	0
4	G	1	Total C O 4 2 2	0	0
4	G	1	Total C O 4 2 2	0	0
4	H	1	Total C O 4 2 2	0	0
4	H	1	Total C O 4 2 2	0	0
4	H	1	Total C O 4 2 2	0	0
4	I	1	Total C O 4 2 2	0	0
4	I	1	Total C O 4 2 2	0	0
4	K	1	Total C O 4 2 2	0	0
4	L	1	Total C O 4 2 2	0	0
4	L	1	Total C O 4 2 2	0	0

- Molecule 5 is GUANIDINE (three-letter code: GAI) (formula: CH_5N_3).

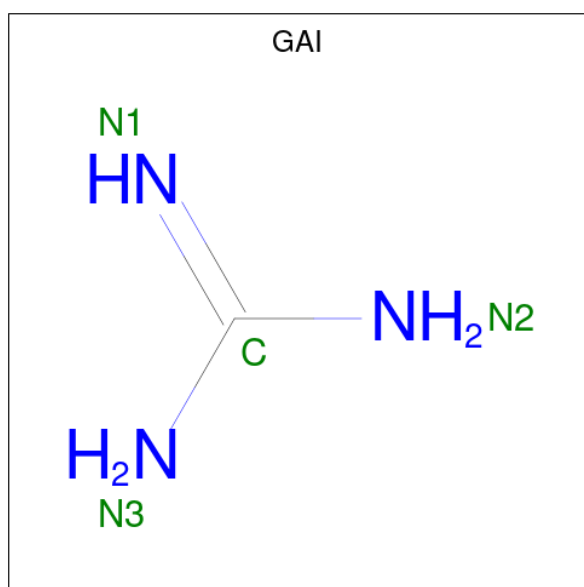

Mol	Chain	Residues	Atoms			ZeroOcc	AltConf
5	A	1	Total	C	N	0	0
			4	1	3		
5	D	1	Total	C	N	0	0
			4	1	3		
5	E	1	Total	C	N	0	0
			4	1	3		
5	E	1	Total	C	N	0	0
			4	1	3		
5	G	1	Total	C	N	0	0
			4	1	3		
5	G	1	Total	C	N	0	0
			4	1	3		
5	H	1	Total	C	N	0	0
			4	1	3		
5	I	1	Total	C	N	0	0
			4	1	3		
5	J	1	Total	C	N	0	0
			4	1	3		

- Molecule 6 is NICOTINAMIDE-ADENINE-DINUCLEOTIDE (three-letter code: NAD) (formula: $C_{21}H_{27}N_7O_{14}P_2$).

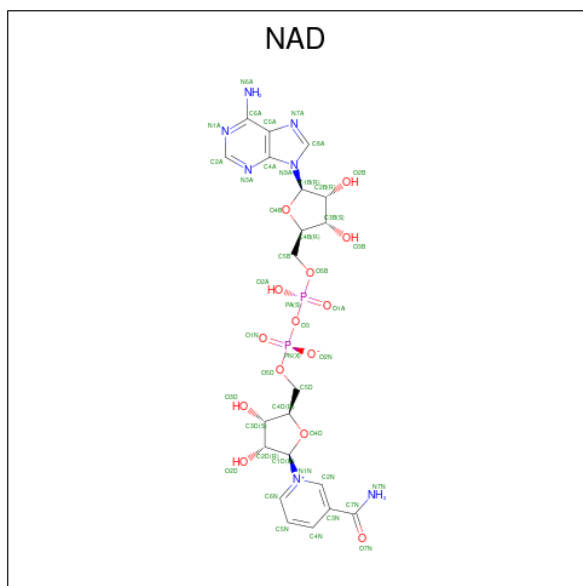

Mol	Chain	Residues	Atoms					ZeroOcc	AltConf
6	B	1	Total	C	N	O	P	0	0
			44	21	7	14	2		
6	C	1	Total	C	N	O	P	0	0
			44	21	7	14	2		

Continued on next page...

Continued from previous page...

Mol	Chain	Residues	Atoms				ZeroOcc	AltConf	
6	F	1	Total	C	N	O	P	0	0
			44	21	7	14	2		
6	G	1	Total	C	N	O	P	0	0
			44	21	7	14	2		
6	H	1	Total	C	N	O	P	0	0
			44	21	7	14	2		

- Molecule 7 is water.

Mol	Chain	Residues	Atoms		ZeroOcc	AltConf
7	A	121	Total	O	0	0
			121	121		
7	B	223	Total	O	0	0
			223	223		
7	C	232	Total	O	0	0
			232	232		
7	D	133	Total	O	0	0
			133	133		
7	E	264	Total	O	0	0
			264	264		
7	F	251	Total	O	0	0
			251	251		
7	G	186	Total	O	0	0
			186	186		
7	H	185	Total	O	0	0
			185	185		
7	I	131	Total	O	0	0
			131	131		
7	J	63	Total	O	0	0
			63	63		
7	K	77	Total	O	0	0
			77	77		
7	L	66	Total	O	0	0
			66	66		

3 Residue-property plots [i](#)

These plots are drawn for all protein, RNA, DNA and oligosaccharide chains in the entry. The first graphic for a chain summarises the proportions of the various outlier classes displayed in the second graphic. The second graphic shows the sequence view annotated by issues in geometry and electron density. Residues are color-coded according to the number of geometric quality criteria for which they contain at least one outlier: green = 0, yellow = 1, orange = 2 and red = 3 or more. A red dot above a residue indicates a poor fit to the electron density ($RSRZ > 2$). Stretches of 2 or more consecutive residues without any outlier are shown as a green connector. Residues present in the sample, but not in the model, are shown in grey.

- Molecule 1: Aldehyde dehydrogenase, mitochondrial precursor

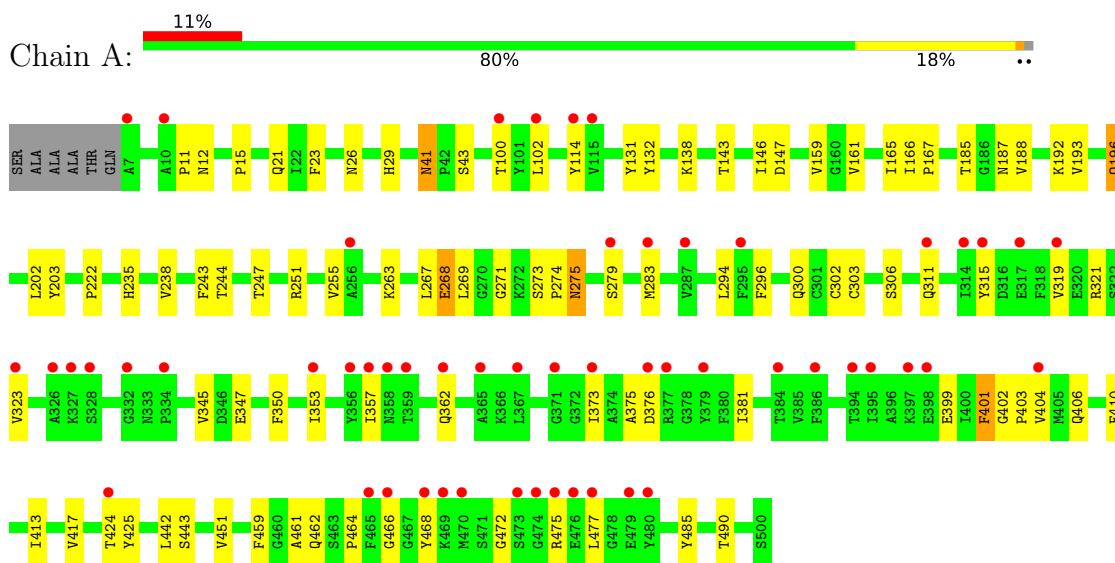

- Molecule 1: Aldehyde dehydrogenase, mitochondrial precursor

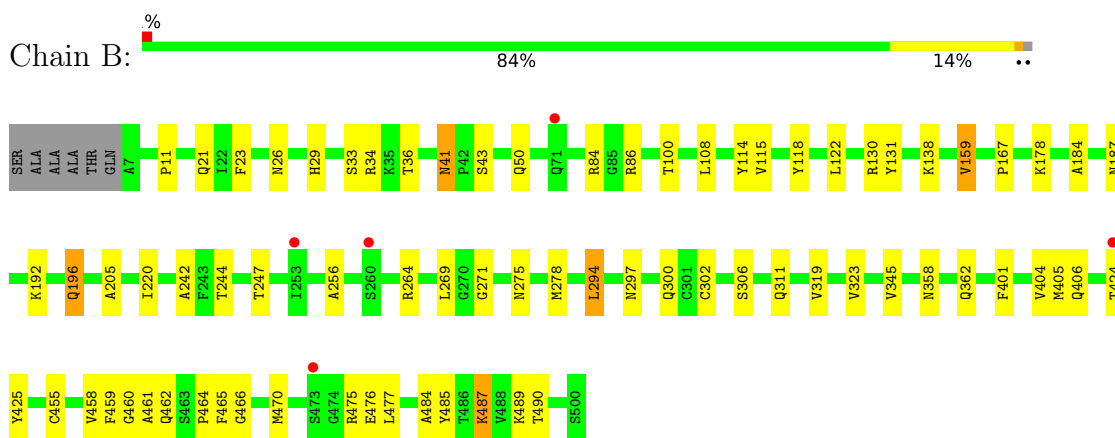

- Molecule 1: Aldehyde dehydrogenase, mitochondrial precursor

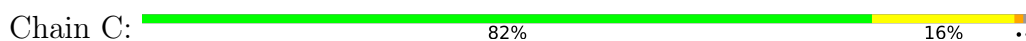

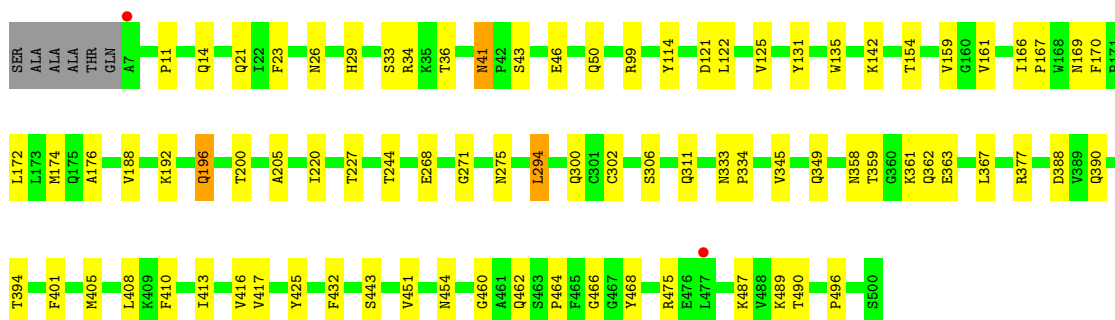

- Molecule 1: Aldehyde dehydrogenase, mitochondrial precursor

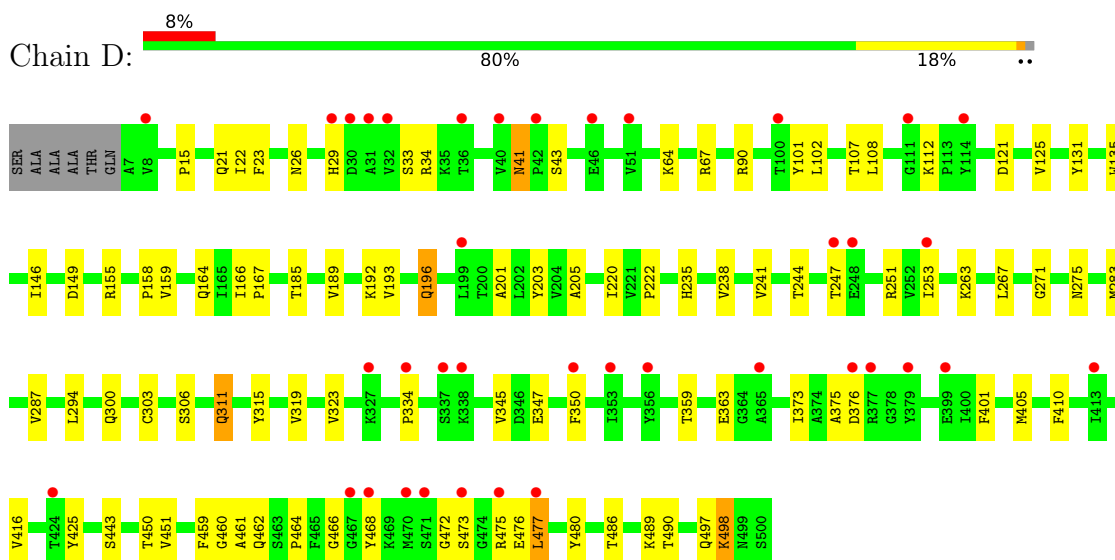

- Molecule 1: Aldehyde dehydrogenase, mitochondrial precursor

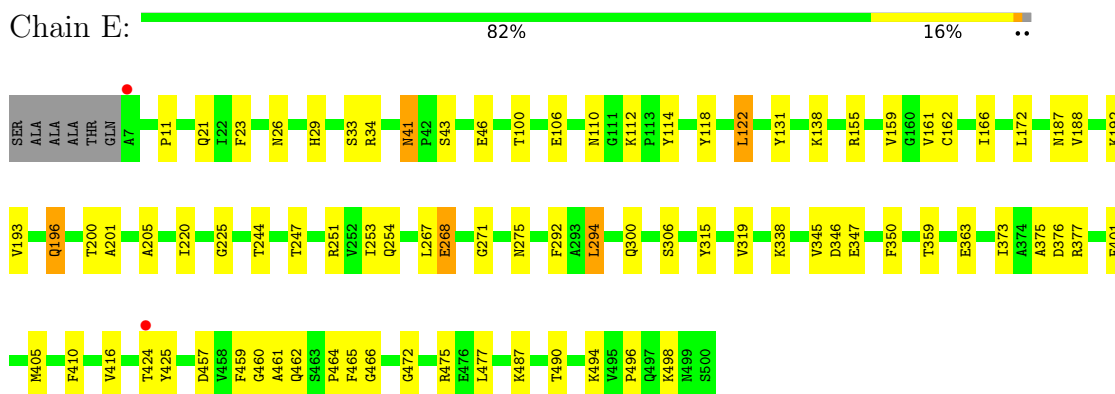

- Molecule 1: Aldehyde dehydrogenase, mitochondrial precursor

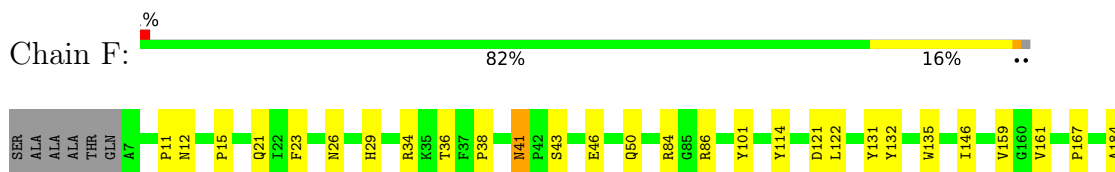

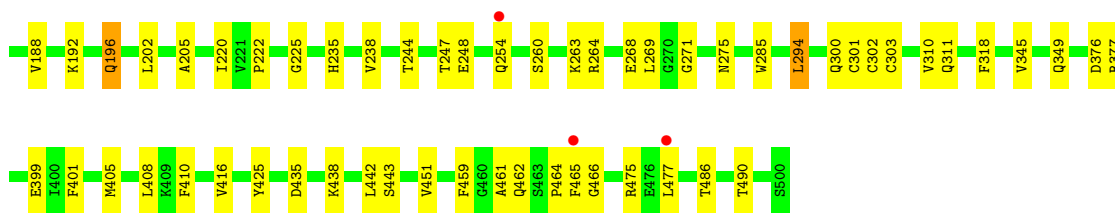

● Molecule 1: Aldehyde dehydrogenase, mitochondrial precursor

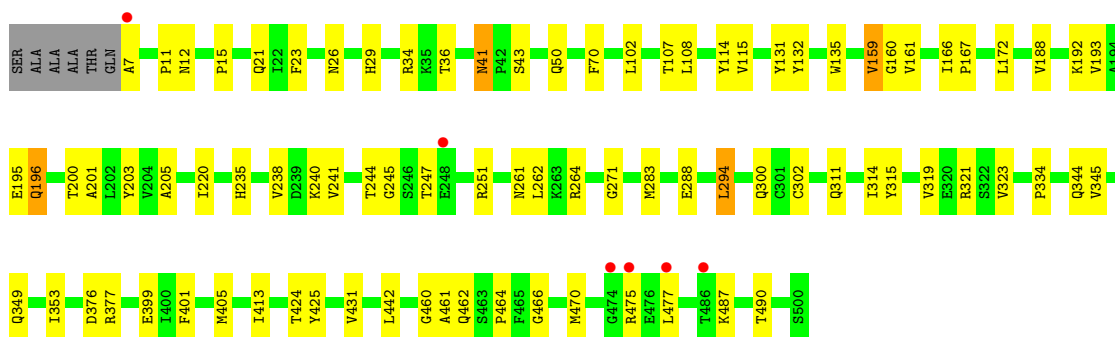
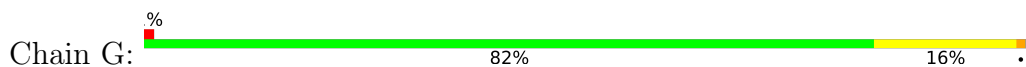

● Molecule 1: Aldehyde dehydrogenase, mitochondrial precursor

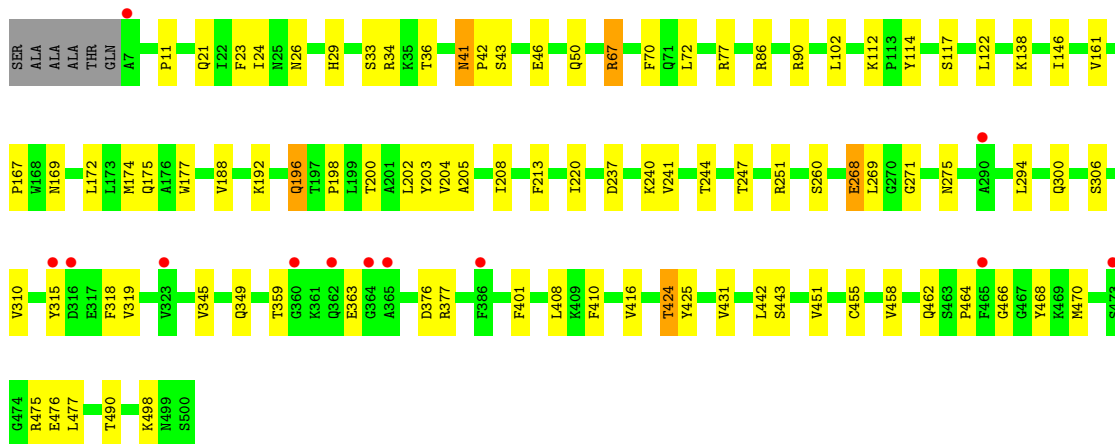
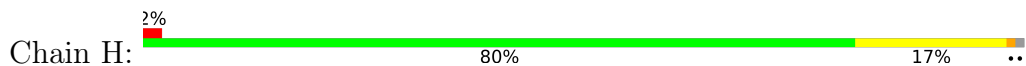

● Molecule 1: Aldehyde dehydrogenase, mitochondrial precursor

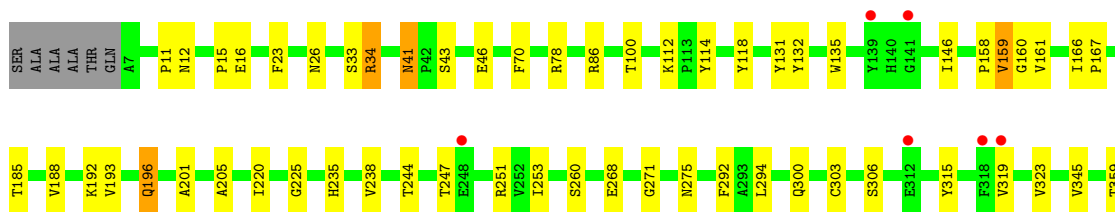
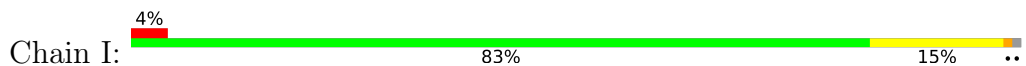



- Molecule 1: Aldehyde dehydrogenase, mitochondrial precursor

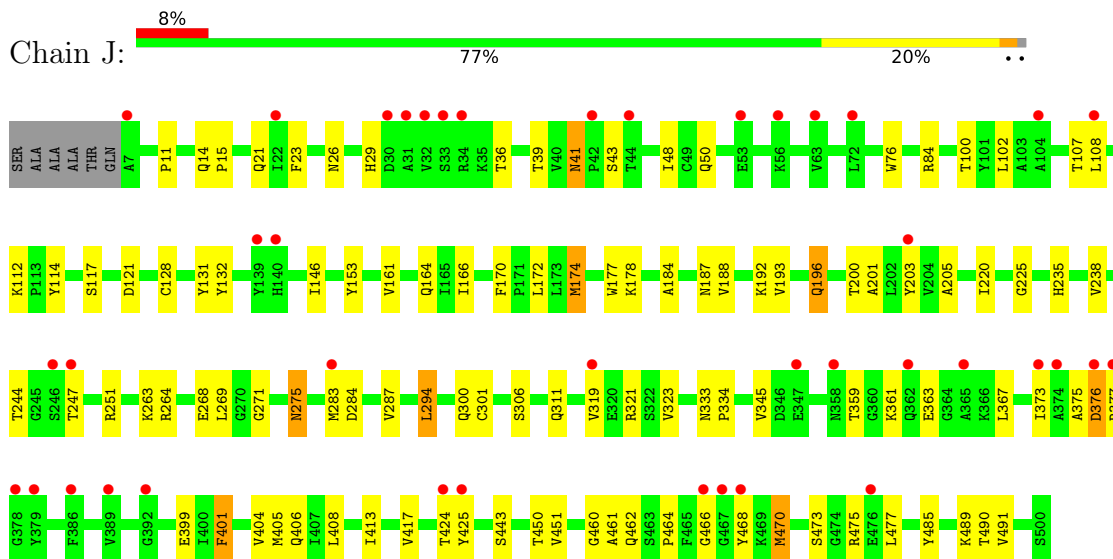

- Molecule 1: Aldehyde dehydrogenase, mitochondrial precursor

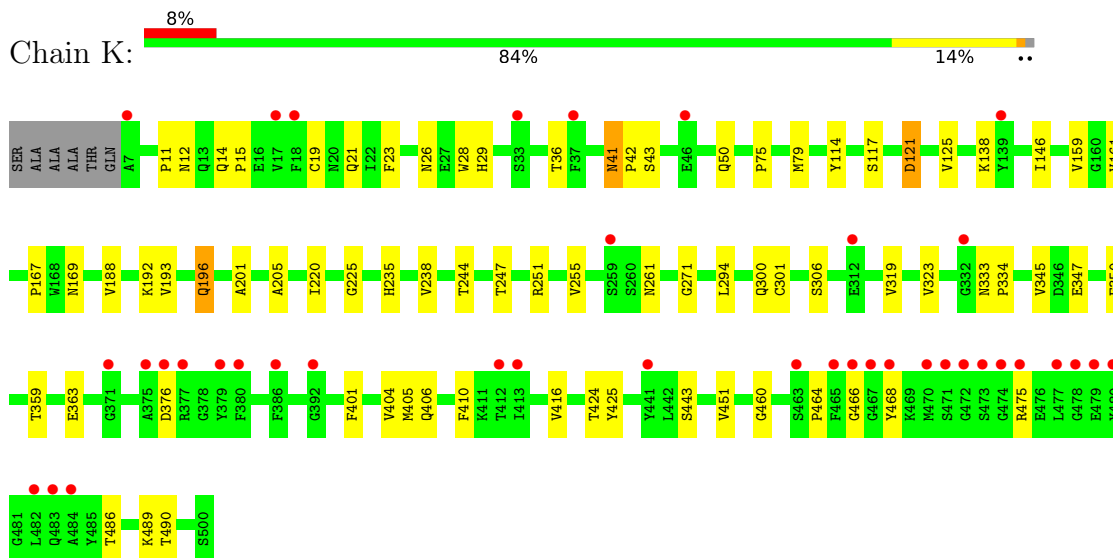

- Molecule 1: Aldehyde dehydrogenase, mitochondrial precursor

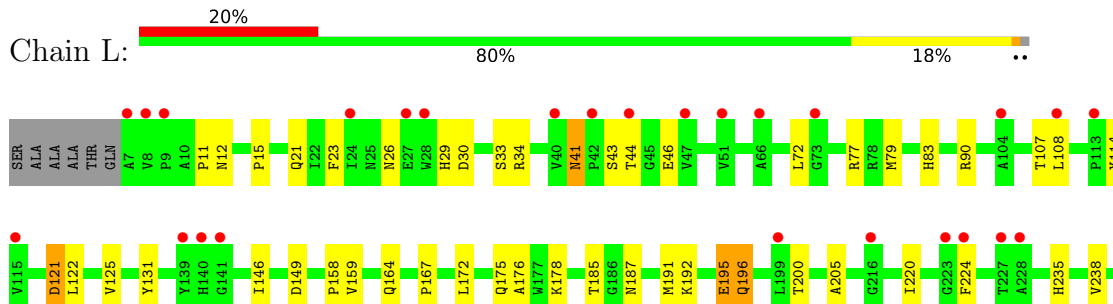

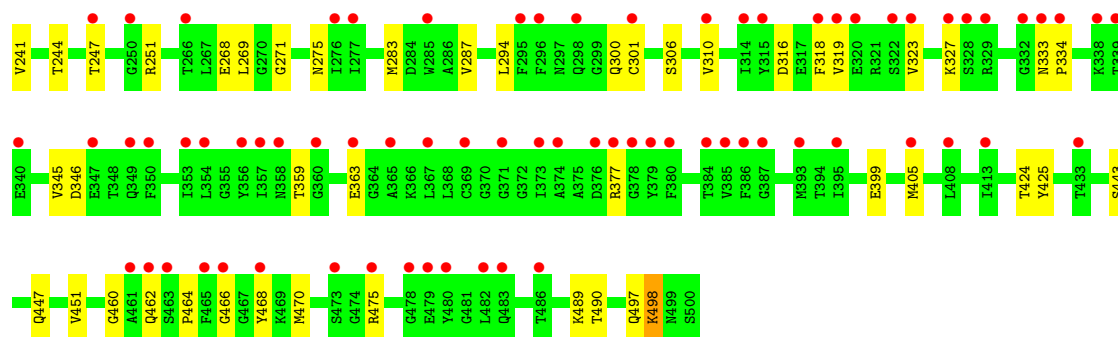

4 Data and refinement statistics

Property	Value	Source
Space group	P 1	Depositor
Cell constants a, b, c, α , β , γ	96.20Å 104.85Å 162.36Å 78.99° 82.14° 88.55°	Depositor
Resolution (Å)	44.01 – 2.50 48.95 – 2.50	Depositor EDS
% Data completeness (in resolution range)	96.5 (44.01-2.50) 93.9 (48.95-2.50)	Depositor EDS
R_{merge}	0.06	Depositor
R_{sym}	(Not available)	Depositor
$\langle I/\sigma(I) \rangle$ ¹	1.98 (at 2.51Å)	Xtrriage
Refinement program	CNS 1.1	Depositor
R, R_{free}	0.230 , 0.271 0.223 , (Not available)	Depositor DCC
R_{free} test set	No test flags present.	wwPDB-VP
Wilson B-factor (Å ²)	44.6	Xtrriage
Anisotropy	0.250	Xtrriage
Bulk solvent k_{sol} (e/Å ³), B_{sol} (Å ²)	0.31 , 47.3	EDS
L-test for twinning ²	$\langle L \rangle = 0.51$, $\langle L^2 \rangle = 0.34$	Xtrriage
Estimated twinning fraction	No twinning to report.	Xtrriage
F_o, F_c correlation	0.94	EDS
Total number of atoms	48124	wwPDB-VP
Average B, all atoms (Å ²)	58.0	wwPDB-VP

Xtrriage's analysis on translational NCS is as follows: *The largest off-origin peak in the Patterson function is 3.07% of the height of the origin peak. No significant pseudotranslation is detected.*

¹Intensities estimated from amplitudes.

²Theoretical values of $\langle |L| \rangle$, $\langle L^2 \rangle$ for acentric reflections are 0.5, 0.333 respectively for untwinned datasets, and 0.375, 0.2 for perfectly twinned datasets.

5 Model quality [i](#)

5.1 Standard geometry [i](#)

Bond lengths and bond angles in the following residue types are not validated in this section: NAD, NA, ADP, GAI, EDO

The Z score for a bond length (or angle) is the number of standard deviations the observed value is removed from the expected value. A bond length (or angle) with $|Z| > 5$ is considered an outlier worth inspection. RMSZ is the root-mean-square of all Z scores of the bond lengths (or angles).

Mol	Chain	Bond lengths		Bond angles	
		RMSZ	# Z >5	RMSZ	# Z >5
1	A	0.46	0/3882	0.61	1/5266 (0.0%)
1	B	0.52	0/3882	0.67	1/5266 (0.0%)
1	C	0.53	0/3882	0.67	0/5266
1	D	0.47	0/3882	0.62	0/5266
1	E	0.55	0/3882	0.67	1/5266 (0.0%)
1	F	0.56	0/3882	0.68	0/5266
1	G	0.52	0/3882	0.65	0/5266
1	H	0.51	0/3882	0.64	0/5266
1	I	0.47	0/3882	0.63	0/5266
1	J	0.40	0/3882	0.61	1/5266 (0.0%)
1	K	0.40	0/3882	0.59	0/5266
1	L	0.38	0/3882	0.59	0/5266
All	All	0.48	0/46584	0.64	4/63192 (0.0%)

There are no bond length outliers.

All (4) bond angle outliers are listed below:

Mol	Chain	Res	Type	Atoms	Z	Observed(°)	Ideal(°)
1	J	264	ARG	NE-CZ-NH1	-5.72	117.44	120.30
1	E	122	LEU	CA-CB-CG	-5.51	102.63	115.30
1	A	143	THR	N-CA-C	-5.17	97.04	111.00
1	B	130	ARG	NE-CZ-NH1	-5.14	117.73	120.30

There are no chirality outliers.

There are no planarity outliers.

5.2 Too-close contacts

In the following table, the Non-H and H(model) columns list the number of non-hydrogen atoms and hydrogen atoms in the chain respectively. The H(added) column lists the number of hydrogen atoms added and optimized by MolProbity. The Clashes column lists the number of clashes within the asymmetric unit, whereas Symm-Clashes lists symmetry-related clashes.

Mol	Chain	Non-H	H(model)	H(added)	Clashes	Symm-Clashes
1	A	3798	0	3752	78	0
1	B	3798	0	3752	57	0
1	C	3798	0	3752	63	0
1	D	3798	0	3752	63	0
1	E	3798	0	3752	67	0
1	F	3798	0	3752	55	0
1	G	3798	0	3752	64	0
1	H	3798	0	3752	56	0
1	I	3798	0	3752	74	0
1	J	3798	0	3752	75	0
1	K	3798	0	3752	46	0
1	L	3798	0	3752	62	0
2	A	1	0	0	0	0
2	B	2	0	0	0	0
2	C	2	0	0	0	0
2	D	1	0	0	0	0
2	E	1	0	0	0	0
2	F	2	0	0	0	0
2	G	2	0	0	0	0
2	H	1	0	0	0	0
2	I	1	0	0	0	0
2	J	1	0	0	0	0
2	K	2	0	0	0	0
2	L	1	0	0	0	0
3	A	54	0	24	3	0
3	D	54	0	24	1	0
3	E	27	0	12	2	0
3	I	27	0	12	2	0
3	J	27	0	12	1	0
3	K	27	0	12	1	0
3	L	27	0	12	0	0
4	A	4	0	6	0	0
4	B	12	0	18	2	0
4	C	8	0	12	1	0
4	D	8	0	12	2	0
4	E	12	0	18	1	0
4	F	16	0	24	2	0

Continued on next page...

Continued from previous page...

Mol	Chain	Non-H	H(model)	H(added)	Clashes	Symm-Clashes
4	G	8	0	12	1	0
4	H	12	0	18	1	0
4	I	8	0	12	2	0
4	K	4	0	6	0	0
4	L	8	0	12	0	0
5	A	4	0	4	0	0
5	D	4	0	5	0	0
5	E	8	0	10	0	0
5	G	8	0	10	0	0
5	H	4	0	5	0	0
5	I	4	0	5	0	0
5	J	4	0	5	0	0
6	B	44	0	26	5	0
6	C	44	0	26	1	0
6	F	44	0	26	2	0
6	G	44	0	26	3	0
6	H	44	0	26	2	0
7	A	121	0	0	1	0
7	B	223	0	0	5	0
7	C	232	0	0	11	0
7	D	133	0	0	2	0
7	E	264	0	0	3	0
7	F	251	0	0	6	0
7	G	186	0	0	6	0
7	H	185	0	0	1	0
7	I	131	0	0	1	0
7	J	63	0	0	1	0
7	K	77	0	0	2	0
7	L	66	0	0	1	0
All	All	48124	0	45456	702	0

The all-atom clashscore is defined as the number of clashes found per 1000 atoms (including hydrogen atoms). The all-atom clashscore for this structure is 8.

The worst 5 of 702 close contacts within the same asymmetric unit are listed below, sorted by their clash magnitude.

Atom-1	Atom-2	Interatomic distance (Å)	Clash overlap (Å)
1:C:196:GLN:HE21	1:C:196:GLN:H	1.03	1.01
1:J:196:GLN:H	1:J:196:GLN:HE21	1.08	0.98
1:C:46:GLU:HB2	4:C:803:EDO:H21	1.47	0.95
1:G:300:GLN:HE22	1:G:345:VAL:H	1.15	0.95

Continued on next page...

Continued from previous page...

Atom-1	Atom-2	Interatomic distance (Å)	Clash overlap (Å)
1:E:196:GLN:H	1:E:196:GLN:HE21	1.12	0.95

There are no symmetry-related clashes.

5.3 Torsion angles [i](#)

5.3.1 Protein backbone [i](#)

In the following table, the Percentiles column shows the percent Ramachandran outliers of the chain as a percentile score with respect to all X-ray entries followed by that with respect to entries of similar resolution.

The Analysed column shows the number of residues for which the backbone conformation was analysed, and the total number of residues.

Mol	Chain	Analysed	Favoured	Allowed	Outliers	Percentiles	
1	A	492/500 (98%)	469 (95%)	23 (5%)	0	100	100
1	B	492/500 (98%)	477 (97%)	15 (3%)	0	100	100
1	C	492/500 (98%)	474 (96%)	18 (4%)	0	100	100
1	D	492/500 (98%)	470 (96%)	22 (4%)	0	100	100
1	E	492/500 (98%)	475 (96%)	17 (4%)	0	100	100
1	F	492/500 (98%)	476 (97%)	16 (3%)	0	100	100
1	G	492/500 (98%)	474 (96%)	18 (4%)	0	100	100
1	H	492/500 (98%)	473 (96%)	19 (4%)	0	100	100
1	I	492/500 (98%)	474 (96%)	18 (4%)	0	100	100
1	J	492/500 (98%)	469 (95%)	23 (5%)	0	100	100
1	K	492/500 (98%)	473 (96%)	19 (4%)	0	100	100
1	L	492/500 (98%)	471 (96%)	21 (4%)	0	100	100
All	All	5904/6000 (98%)	5675 (96%)	229 (4%)	0	100	100

There are no Ramachandran outliers to report.

5.3.2 Protein sidechains [i](#)

In the following table, the Percentiles column shows the percent sidechain outliers of the chain as a percentile score with respect to all X-ray entries followed by that with respect to entries of similar

resolution.

The Analysed column shows the number of residues for which the sidechain conformation was analysed, and the total number of residues.

Mol	Chain	Analysed	Rotameric	Outliers	Percentiles	
1	A	399/402 (99%)	388 (97%)	11 (3%)	43	70
1	B	399/402 (99%)	389 (98%)	10 (2%)	47	73
1	C	399/402 (99%)	391 (98%)	8 (2%)	55	79
1	D	399/402 (99%)	384 (96%)	15 (4%)	33	58
1	E	399/402 (99%)	388 (97%)	11 (3%)	43	70
1	F	399/402 (99%)	384 (96%)	15 (4%)	33	58
1	G	399/402 (99%)	390 (98%)	9 (2%)	50	76
1	H	399/402 (99%)	383 (96%)	16 (4%)	31	56
1	I	399/402 (99%)	389 (98%)	10 (2%)	47	73
1	J	399/402 (99%)	384 (96%)	15 (4%)	33	58
1	K	399/402 (99%)	388 (97%)	11 (3%)	43	70
1	L	399/402 (99%)	383 (96%)	16 (4%)	31	56
All	All	4788/4824 (99%)	4641 (97%)	147 (3%)	40	67

5 of 147 residues with a non-rotameric sidechain are listed below:

Mol	Chain	Res	Type
1	J	376	ASP
1	L	301	CYS
1	J	473	SER
1	K	486	THR
1	E	196	GLN

Sometimes sidechains can be flipped to improve hydrogen bonding and reduce clashes. 5 of 105 such sidechains are listed below:

Mol	Chain	Res	Type
1	G	275	ASN
1	I	41	ASN
1	L	83	HIS
1	G	349	GLN
1	H	196	GLN

5.3.3 RNA [i](#)

There are no RNA molecules in this entry.

5.4 Non-standard residues in protein, DNA, RNA chains [i](#)

There are no non-standard protein/DNA/RNA residues in this entry.

5.5 Carbohydrates [i](#)

There are no monosaccharides in this entry.

5.6 Ligand geometry [i](#)

Of 65 ligands modelled in this entry, 17 are monoatomic - leaving 48 for Mogul analysis.

In the following table, the Counts columns list the number of bonds (or angles) for which Mogul statistics could be retrieved, the number of bonds (or angles) that are observed in the model and the number of bonds (or angles) that are defined in the Chemical Component Dictionary. The Link column lists molecule types, if any, to which the group is linked. The Z score for a bond length (or angle) is the number of standard deviations the observed value is removed from the expected value. A bond length (or angle) with $|Z| > 2$ is considered an outlier worth inspection. RMSZ is the root-mean-square of all Z scores of the bond lengths (or angles).

Mol	Type	Chain	Res	Link	Bond lengths			Bond angles		
					Counts	RMSZ	# Z > 2	Counts	RMSZ	# Z > 2
4	EDO	I	909	-	3,3,3	0.39	0	2,2,2	0.37	0
5	GAI	G	5009	-	3,3,3	1.37	1 (33%)	3,3,3	1.11	0
5	GAI	E	906	-	3,3,3	1.39	1 (33%)	3,3,3	1.26	0
4	EDO	C	803	-	3,3,3	0.45	0	2,2,2	0.31	0
5	GAI	E	907	-	3,3,3	1.55	1 (33%)	3,3,3	1.32	0
4	EDO	B	701	-	3,3,3	0.43	0	2,2,2	0.37	0
3	ADP	L	512	-	24,29,29	1.68	4 (16%)	29,45,45	1.49	6 (20%)
5	GAI	G	5010	-	3,3,3	1.52	1 (33%)	3,3,3	1.16	0
4	EDO	F	806	-	3,3,3	0.44	0	2,2,2	0.32	0
4	EDO	G	807	-	3,3,3	0.60	0	2,2,2	0.20	0
4	EDO	E	905	-	3,3,3	0.13	0	2,2,2	0.56	0
4	EDO	H	708	-	3,3,3	0.46	0	2,2,2	0.29	0
4	EDO	E	805	-	3,3,3	0.64	0	2,2,2	0.18	0
4	EDO	L	912	-	3,3,3	0.43	0	2,2,2	0.36	0
3	ADP	K	511	-	24,29,29	1.67	5 (20%)	29,45,45	1.62	5 (17%)
4	EDO	D	904	-	3,3,3	0.41	0	2,2,2	0.36	0

Mol	Type	Chain	Res	Link	Bond lengths			Bond angles		
					Counts	RMSZ	# Z > 2	Counts	RMSZ	# Z > 2
4	EDO	C	903	-	3,3,3	0.63	0	2,2,2	0.33	0
3	ADP	D	504[A]	-	24,29,29	1.85	5 (20%)	29,45,45	1.68	4 (13%)
3	ADP	J	510	-	24,29,29	1.69	4 (16%)	29,45,45	1.35	3 (10%)
4	EDO	H	808	-	3,3,3	0.67	0	2,2,2	0.21	0
4	EDO	I	809	-	3,3,3	0.67	0	2,2,2	0.15	0
4	EDO	G	907	-	3,3,3	0.36	0	2,2,2	0.44	0
6	NAD	H	508	-	42,48,48	2.36	10 (23%)	50,73,73	1.69	10 (20%)
6	NAD	B	502	-	42,48,48	2.16	8 (19%)	50,73,73	1.90	11 (22%)
6	NAD	G	507	-	42,48,48	2.45	10 (23%)	50,73,73	1.54	10 (20%)
5	GAI	A	902	-	3,3,3	1.36	1 (33%)	3,3,3	1.18	0
5	GAI	J	611	-	3,3,3	1.39	1 (33%)	3,3,3	1.18	0
4	EDO	B	902	-	3,3,3	0.30	0	2,2,2	0.44	0
5	GAI	I	910	-	3,3,3	1.53	1 (33%)	3,3,3	0.99	0
5	GAI	D	905	-	3,3,3	1.56	1 (33%)	3,3,3	1.22	0
4	EDO	L	712	-	3,3,3	0.55	0	2,2,2	0.26	0
3	ADP	E	505	-	24,29,29	1.53	4 (16%)	29,45,45	1.78	6 (20%)
6	NAD	C	503	-	42,48,48	2.21	8 (19%)	50,73,73	1.96	15 (30%)
4	EDO	F	707	-	3,3,3	0.77	0	2,2,2	0.13	0
3	ADP	A	501[A]	-	24,29,29	1.90	5 (20%)	29,45,45	1.97	6 (20%)
3	ADP	D	504[B]	-	24,29,29	1.65	5 (20%)	29,45,45	1.49	3 (10%)
4	EDO	K	911	-	3,3,3	0.61	0	2,2,2	0.26	0
4	EDO	F	906	-	3,3,3	0.40	0	2,2,2	0.37	0
3	ADP	I	509	-	24,29,29	1.76	5 (20%)	29,45,45	2.19	5 (17%)
4	EDO	B	802	-	3,3,3	0.41	0	2,2,2	0.47	0
6	NAD	F	506	-	42,48,48	2.20	9 (21%)	50,73,73	1.77	9 (18%)
4	EDO	D	704	-	3,3,3	0.60	0	2,2,2	0.28	0
5	GAI	H	909	-	3,3,3	1.38	1 (33%)	3,3,3	1.13	0
4	EDO	F	706	-	3,3,3	0.42	0	2,2,2	0.38	0
4	EDO	E	705	-	3,3,3	0.56	0	2,2,2	0.25	0
4	EDO	H	908	-	3,3,3	0.42	0	2,2,2	0.37	0
4	EDO	A	901	-	3,3,3	0.54	0	2,2,2	0.34	0
3	ADP	A	501[B]	-	24,29,29	1.71	5 (20%)	29,45,45	1.53	3 (10%)

In the following table, the Chirals column lists the number of chiral outliers, the number of chiral centers analysed, the number of these observed in the model and the number defined in the Chemical Component Dictionary. Similar counts are reported in the Torsion and Rings columns. '2' means no outliers of that kind were identified.

Mol	Type	Chain	Res	Link	Chirals	Torsions	Rings
4	EDO	I	909	-	-	0/1/1/1	-
4	EDO	C	803	-	-	1/1/1/1	-
4	EDO	B	701	-	-	0/1/1/1	-
3	ADP	L	512	-	-	4/12/32/32	0/3/3/3
4	EDO	F	806	-	-	0/1/1/1	-
4	EDO	G	807	-	-	0/1/1/1	-
4	EDO	E	905	-	-	0/1/1/1	-
4	EDO	H	708	-	-	0/1/1/1	-
4	EDO	E	805	-	-	0/1/1/1	-
4	EDO	L	912	-	-	0/1/1/1	-
3	ADP	K	511	-	-	1/12/32/32	0/3/3/3
4	EDO	D	904	-	-	0/1/1/1	-
4	EDO	C	903	-	-	1/1/1/1	-
3	ADP	D	504[A]	-	-	5/12/32/32	0/3/3/3
3	ADP	J	510	-	-	6/12/32/32	0/3/3/3
4	EDO	H	808	-	-	0/1/1/1	-
4	EDO	I	809	-	-	0/1/1/1	-
4	EDO	G	907	-	-	0/1/1/1	-
6	NAD	H	508	-	-	9/26/62/62	0/5/5/5
6	NAD	B	502	-	-	9/26/62/62	0/5/5/5
6	NAD	G	507	-	-	11/26/62/62	0/5/5/5
4	EDO	B	902	-	-	0/1/1/1	-
4	EDO	L	712	-	-	0/1/1/1	-
3	ADP	E	505	-	-	3/12/32/32	0/3/3/3
6	NAD	C	503	-	-	10/26/62/62	0/5/5/5
4	EDO	F	707	-	-	0/1/1/1	-
3	ADP	A	501[A]	-	-	3/12/32/32	0/3/3/3
3	ADP	D	504[B]	-	-	4/12/32/32	0/3/3/3
4	EDO	K	911	-	-	1/1/1/1	-
4	EDO	F	906	-	-	0/1/1/1	-
3	ADP	I	509	-	-	4/12/32/32	0/3/3/3
4	EDO	B	802	-	-	0/1/1/1	-
6	NAD	F	506	-	-	6/26/62/62	0/5/5/5
4	EDO	D	704	-	-	1/1/1/1	-
4	EDO	F	706	-	-	0/1/1/1	-
4	EDO	E	705	-	-	0/1/1/1	-
4	EDO	H	908	-	-	0/1/1/1	-
4	EDO	A	901	-	-	1/1/1/1	-
3	ADP	A	501[B]	-	-	0/12/32/32	0/3/3/3

The worst 5 of 96 bond length outliers are listed below:

Mol	Chain	Res	Type	Atoms	Z	Observed(Å)	Ideal(Å)
6	G	507	NAD	C3N-C7N	-11.97	1.32	1.50
6	H	508	NAD	C3N-C7N	-10.50	1.34	1.50
6	B	502	NAD	C3N-C7N	-10.14	1.35	1.50
6	F	506	NAD	C3N-C7N	-9.72	1.36	1.50
6	C	503	NAD	C3N-C7N	-9.45	1.36	1.50

The worst 5 of 96 bond angle outliers are listed below:

Mol	Chain	Res	Type	Atoms	Z	Observed(°)	Ideal(°)
6	B	502	NAD	O4B-C1B-C2B	-8.32	94.77	106.93
3	I	509	ADP	O4'-C1'-C2'	-8.32	94.77	106.93
3	A	501[A]	ADP	O4'-C1'-C2'	-7.13	96.51	106.93
3	E	505	ADP	N3-C2-N1	-5.22	120.52	128.68
6	C	503	NAD	O4B-C1B-C2B	-5.03	99.57	106.93

There are no chirality outliers.

5 of 80 torsion outliers are listed below:

Mol	Chain	Res	Type	Atoms
3	D	504[A]	ADP	C5'-O5'-PA-O1A
3	D	504[A]	ADP	C5'-O5'-PA-O2A
3	D	504[B]	ADP	PA-O3A-PB-O2B
3	D	504[B]	ADP	PA-O3A-PB-O3B
3	E	505	ADP	PA-O3A-PB-O3B

There are no ring outliers.

22 monomers are involved in 35 short contacts:

Mol	Chain	Res	Type	Clashes	Symm-Clashes
4	C	803	EDO	1	0
4	F	806	EDO	1	0
4	G	807	EDO	1	0
3	K	511	ADP	1	0
4	D	904	EDO	1	0
3	J	510	ADP	1	0
4	H	808	EDO	1	0
4	I	809	EDO	2	0
6	H	508	NAD	2	0
6	B	502	NAD	5	0
6	G	507	NAD	3	0
3	E	505	ADP	2	0
6	C	503	NAD	1	0

Continued on next page...

Continued from previous page...

Mol	Chain	Res	Type	Clashes	Symm-Clashes
3	A	501[A]	ADP	2	0
3	D	504[B]	ADP	1	0
4	F	906	EDO	1	0
3	I	509	ADP	2	0
4	B	802	EDO	2	0
6	F	506	NAD	2	0
4	D	704	EDO	1	0
4	E	705	EDO	1	0
3	A	501[B]	ADP	1	0

The following is a two-dimensional graphical depiction of Mogul quality analysis of bond lengths, bond angles, torsion angles, and ring geometry for all instances of the Ligand of Interest. In addition, ligands with molecular weight > 250 and outliers as shown on the validation Tables will also be included. For torsion angles, if less than 5% of the Mogul distribution of torsion angles is within 10 degrees of the torsion angle in question, then that torsion angle is considered an outlier. Any bond that is central to one or more torsion angles identified as an outlier by Mogul will be highlighted in the graph. For rings, the root-mean-square deviation (RMSD) between the ring in question and similar rings identified by Mogul is calculated over all ring torsion angles. If the average RMSD is greater than 60 degrees and the minimal RMSD between the ring in question and any Mogul-identified rings is also greater than 60 degrees, then that ring is considered an outlier. The outliers are highlighted in purple. The color gray indicates Mogul did not find sufficient equivalents in the CSD to analyse the geometry.

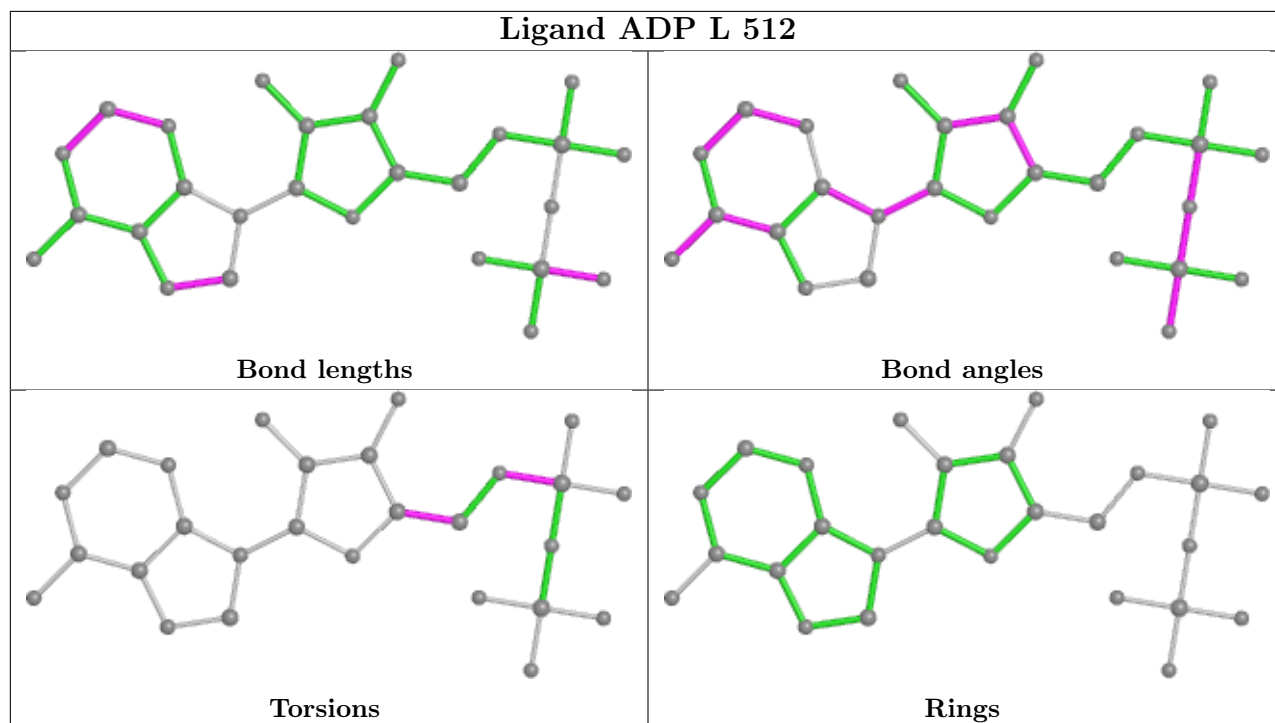

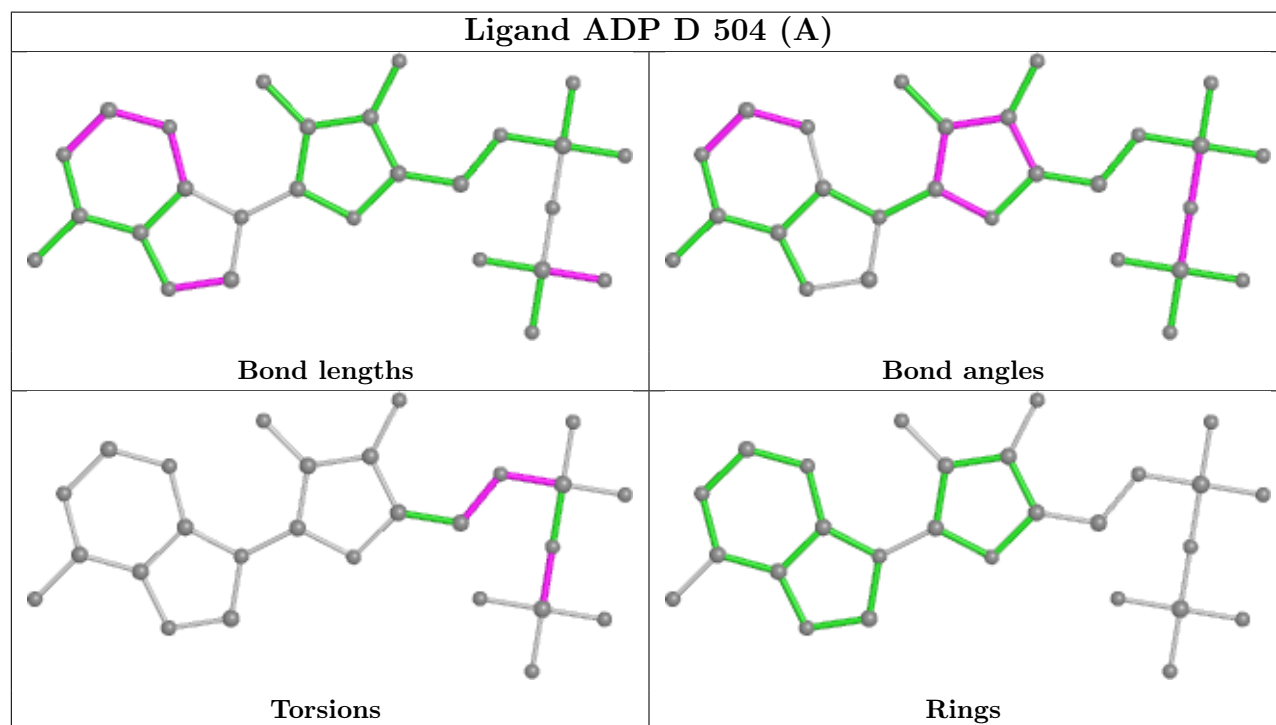
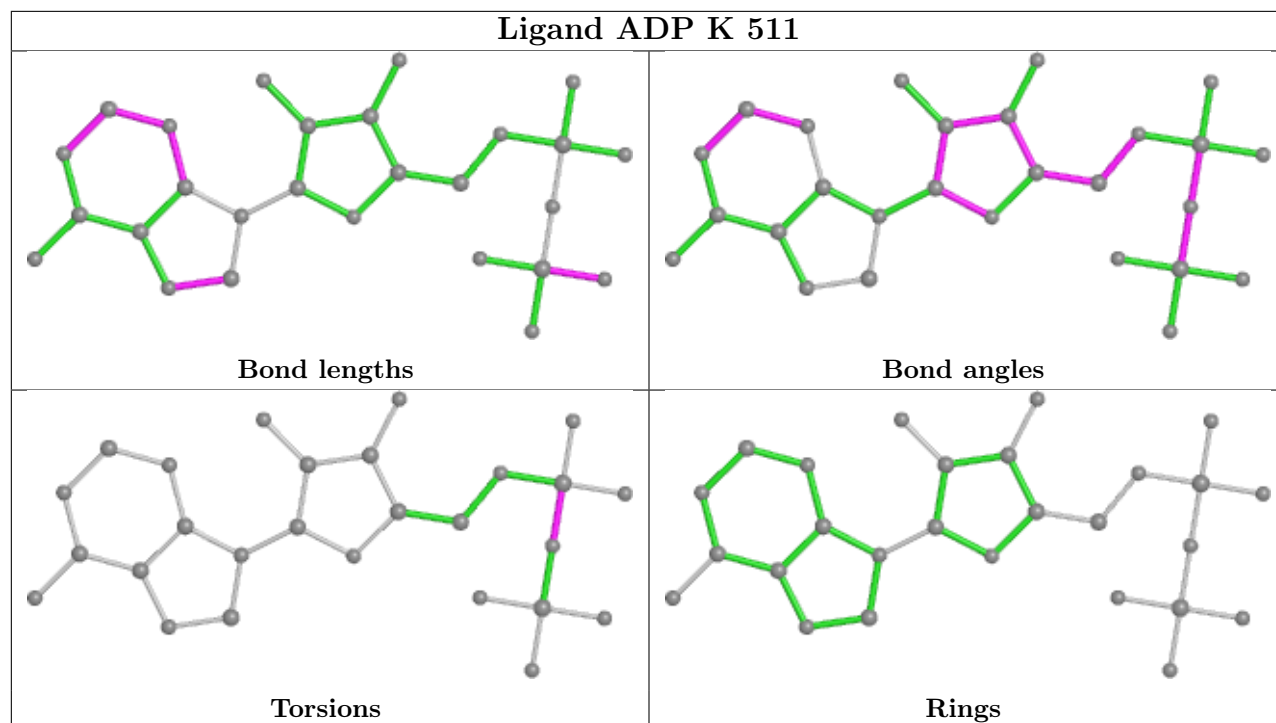

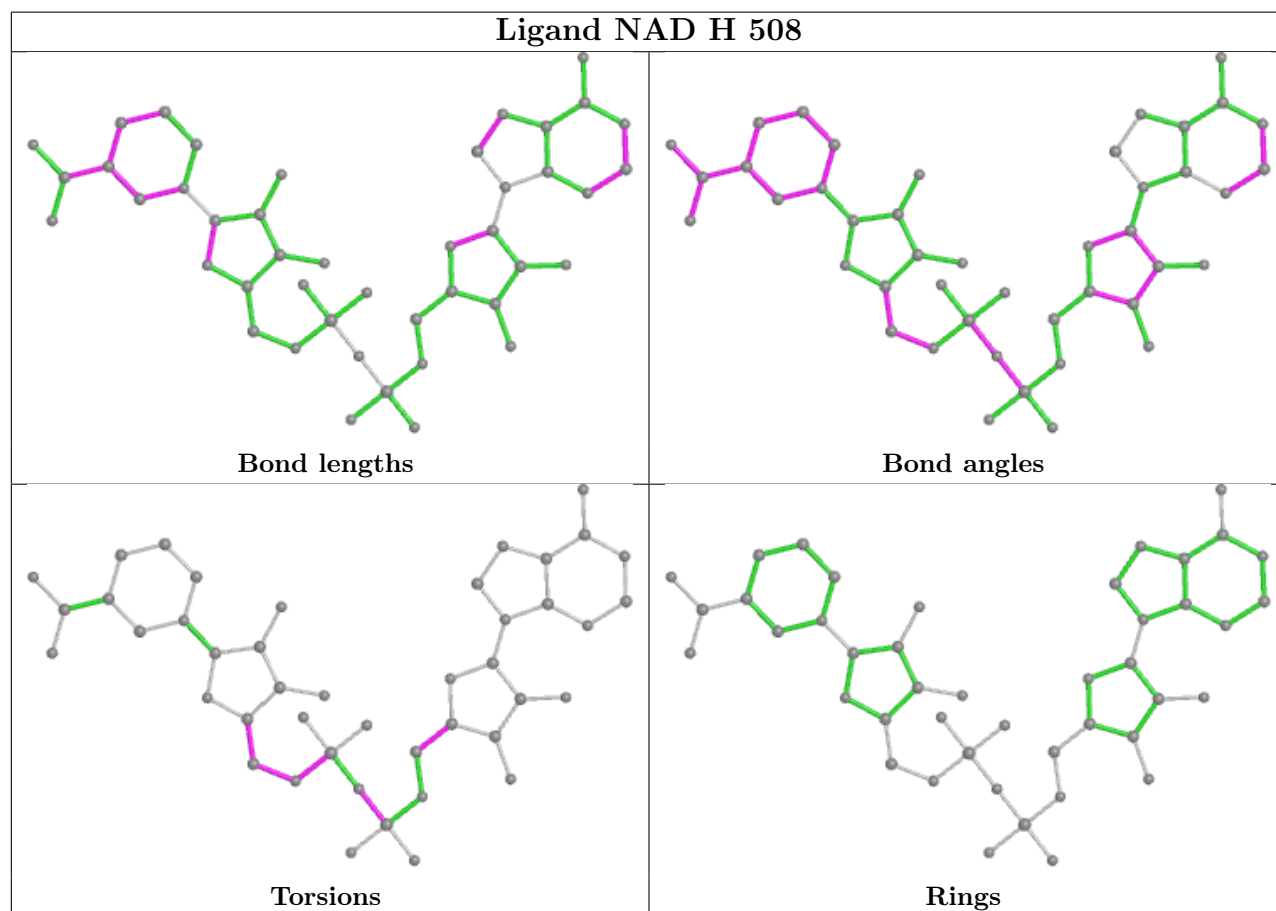
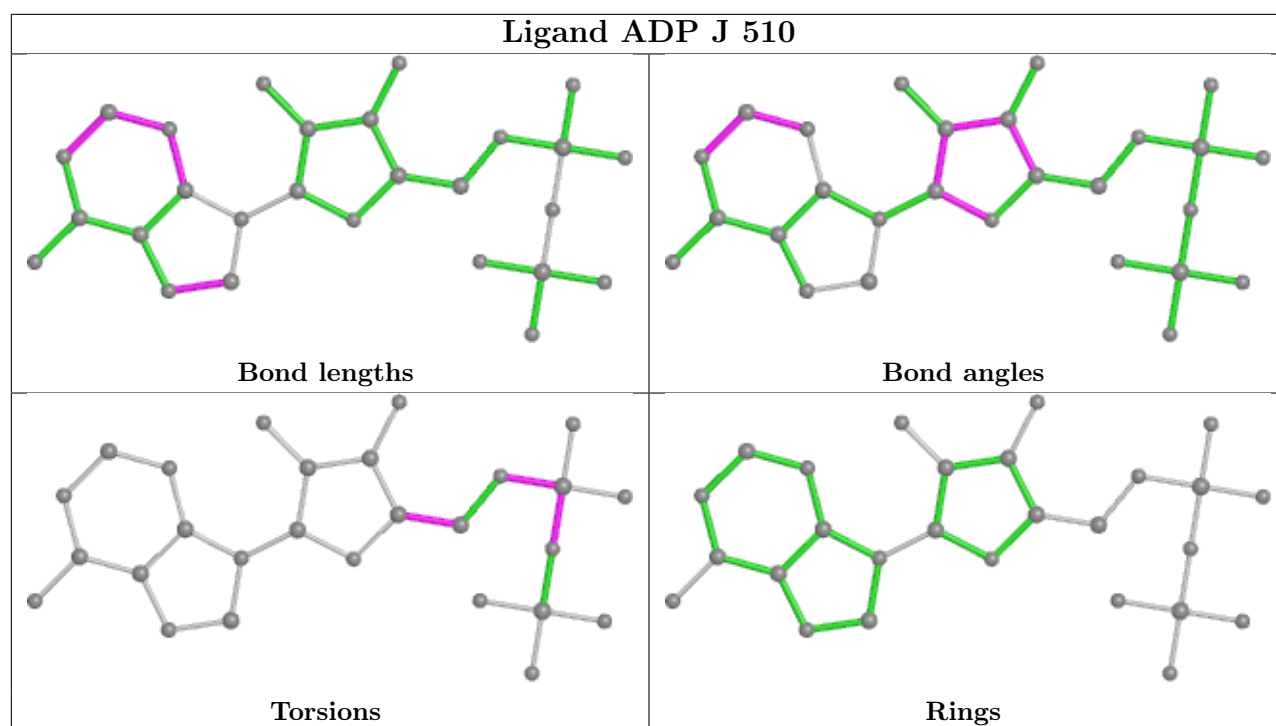

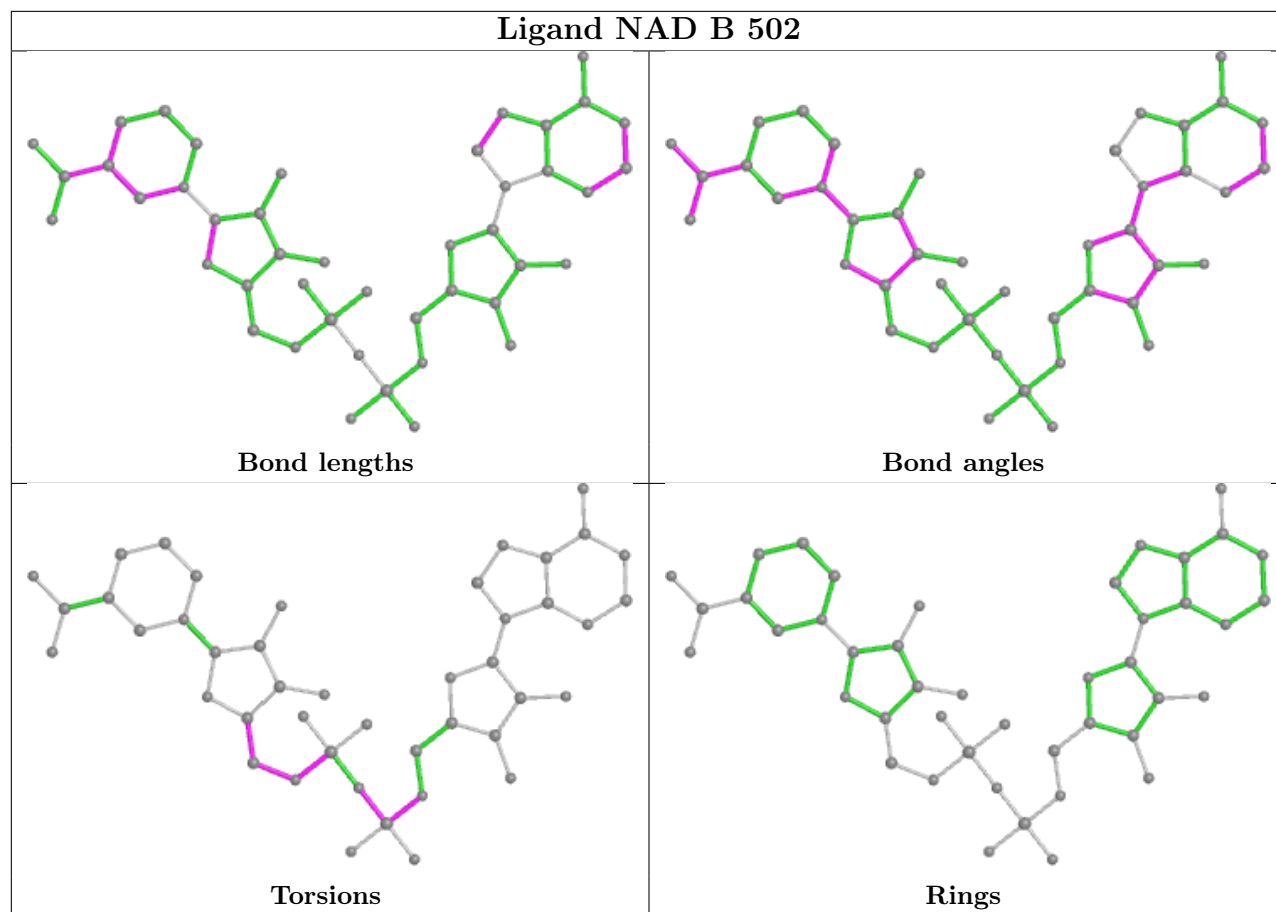

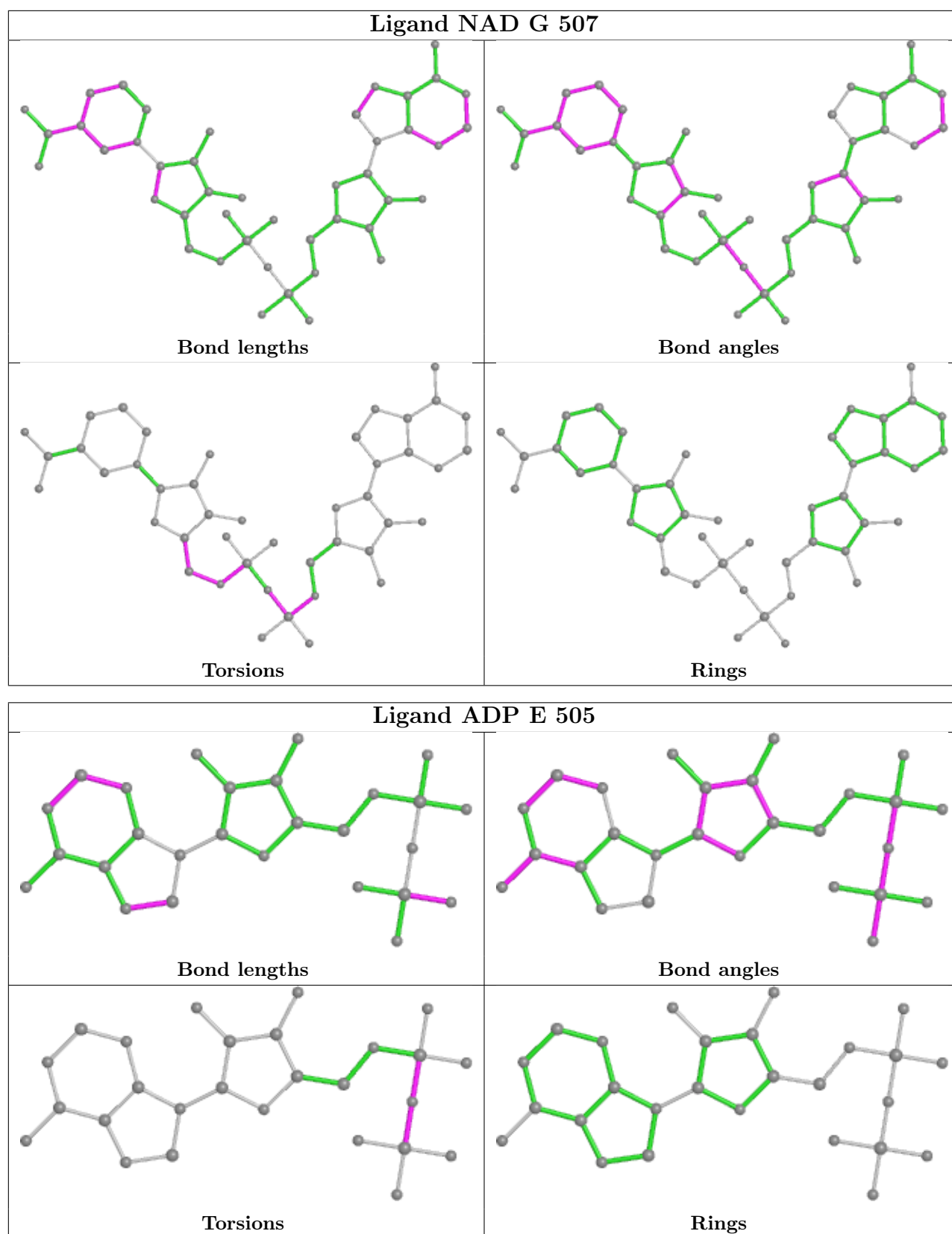

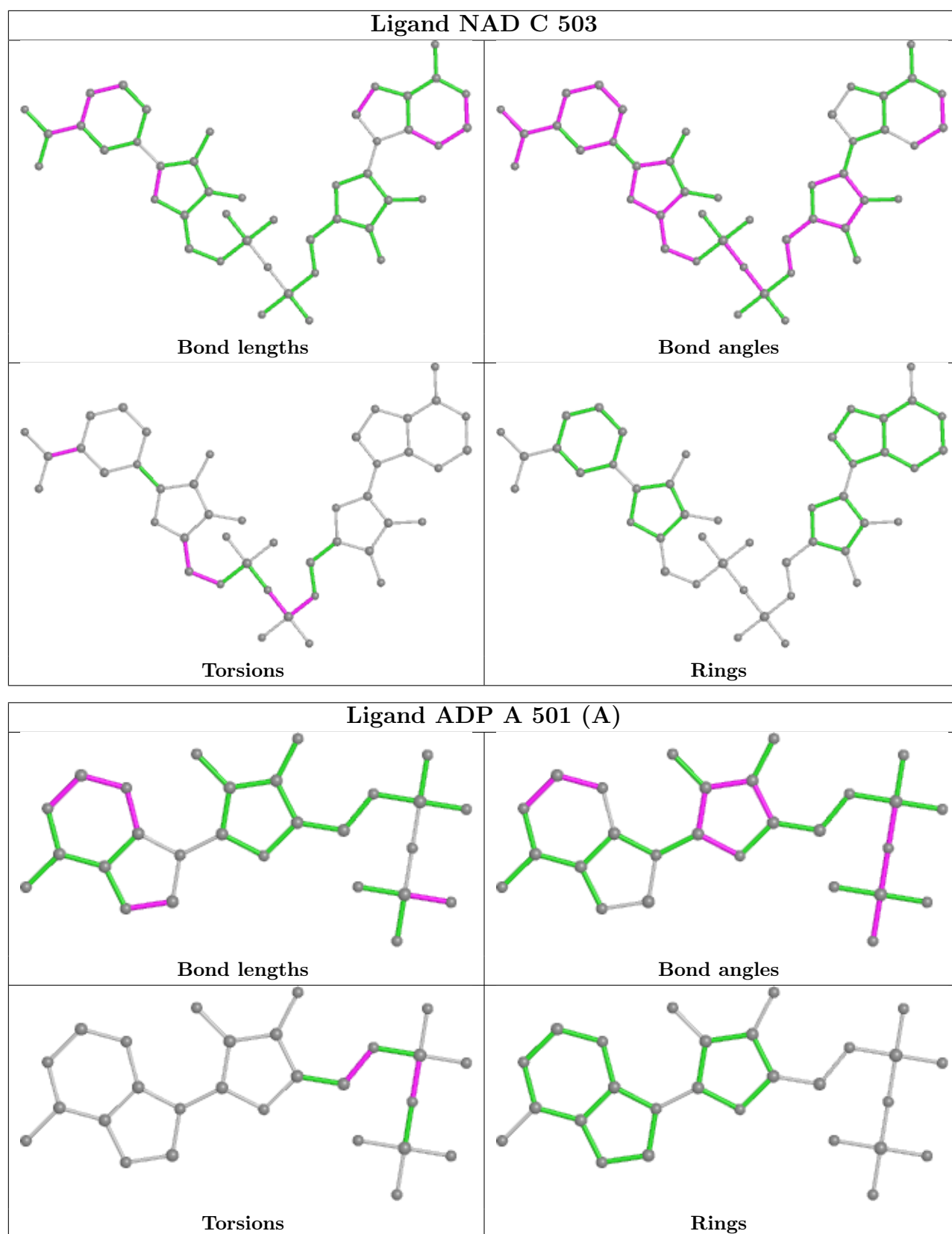

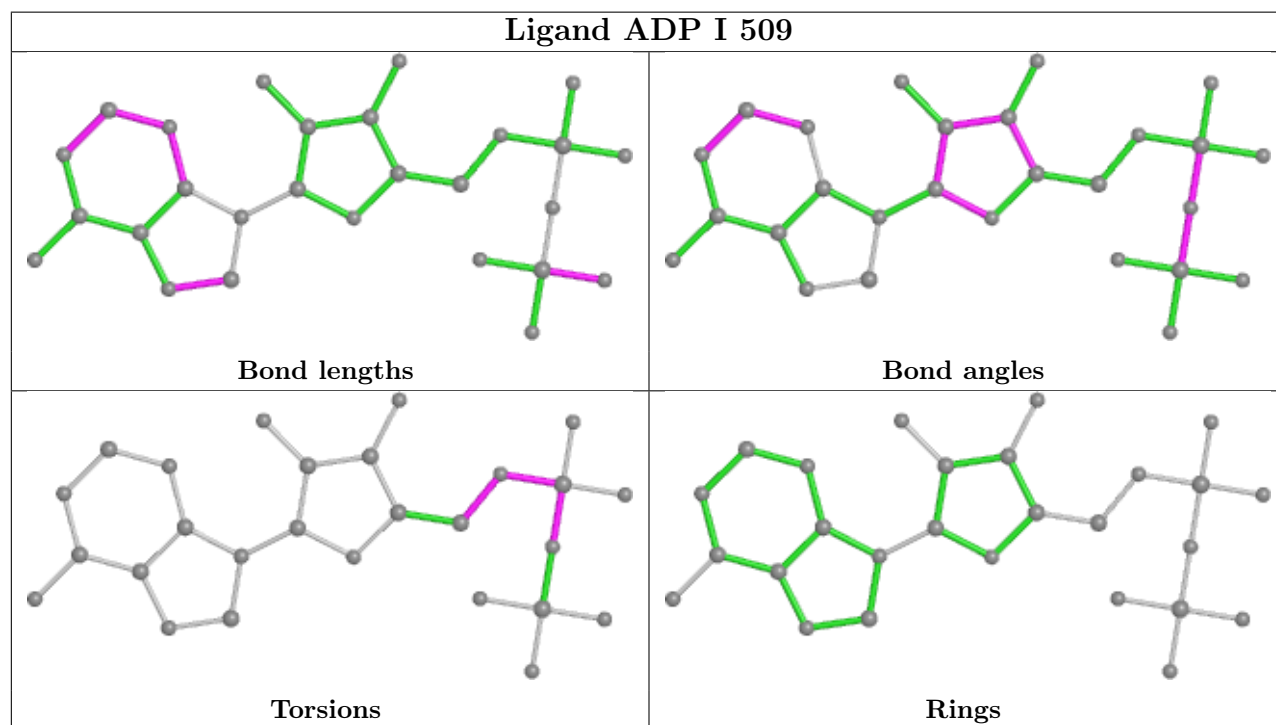
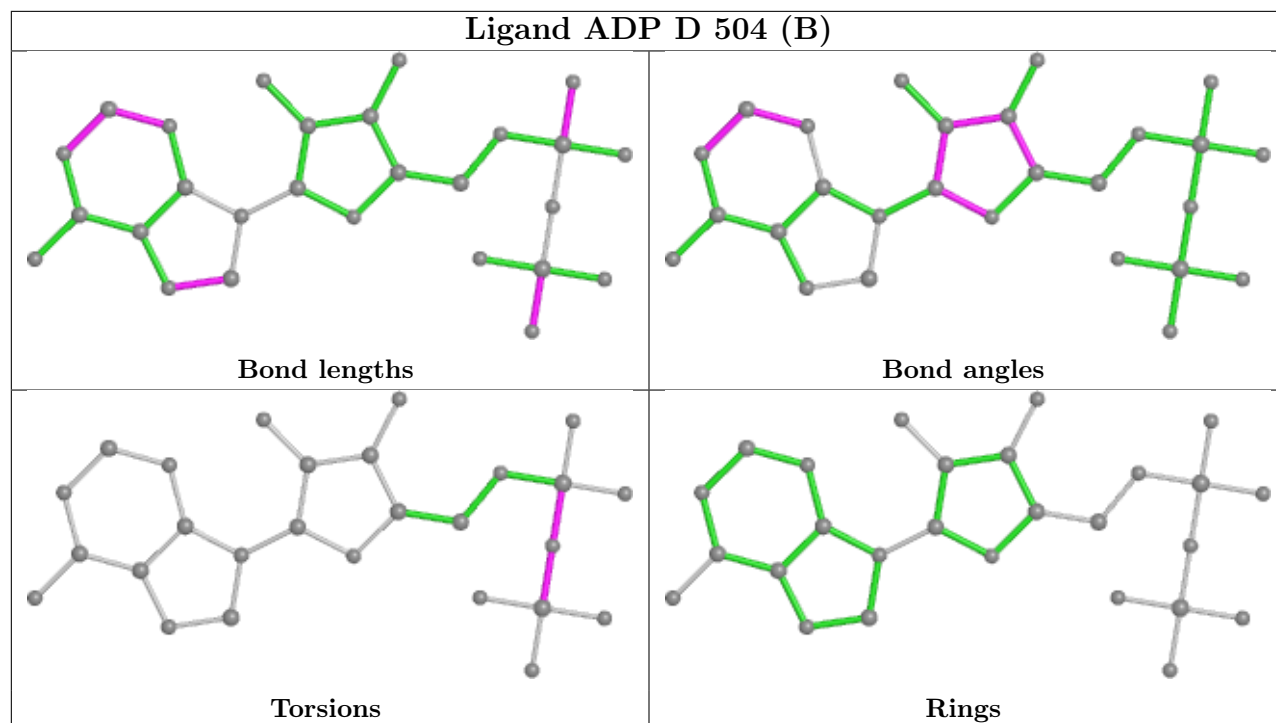

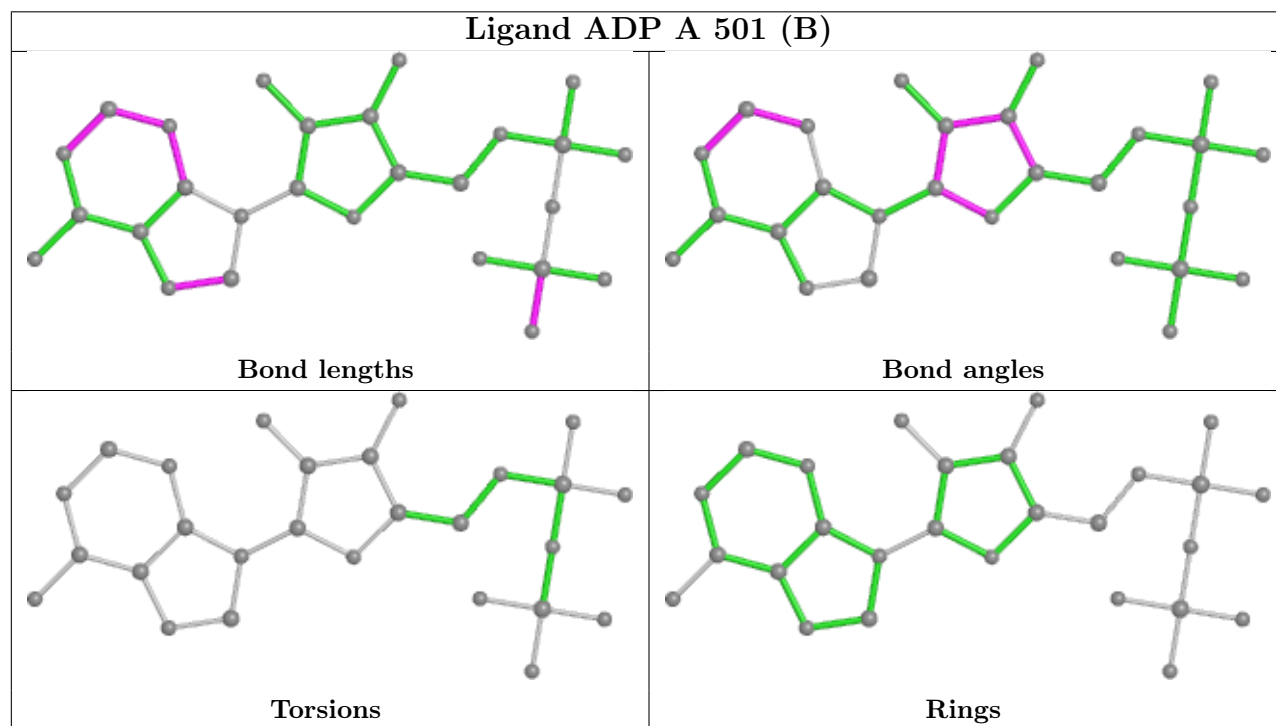
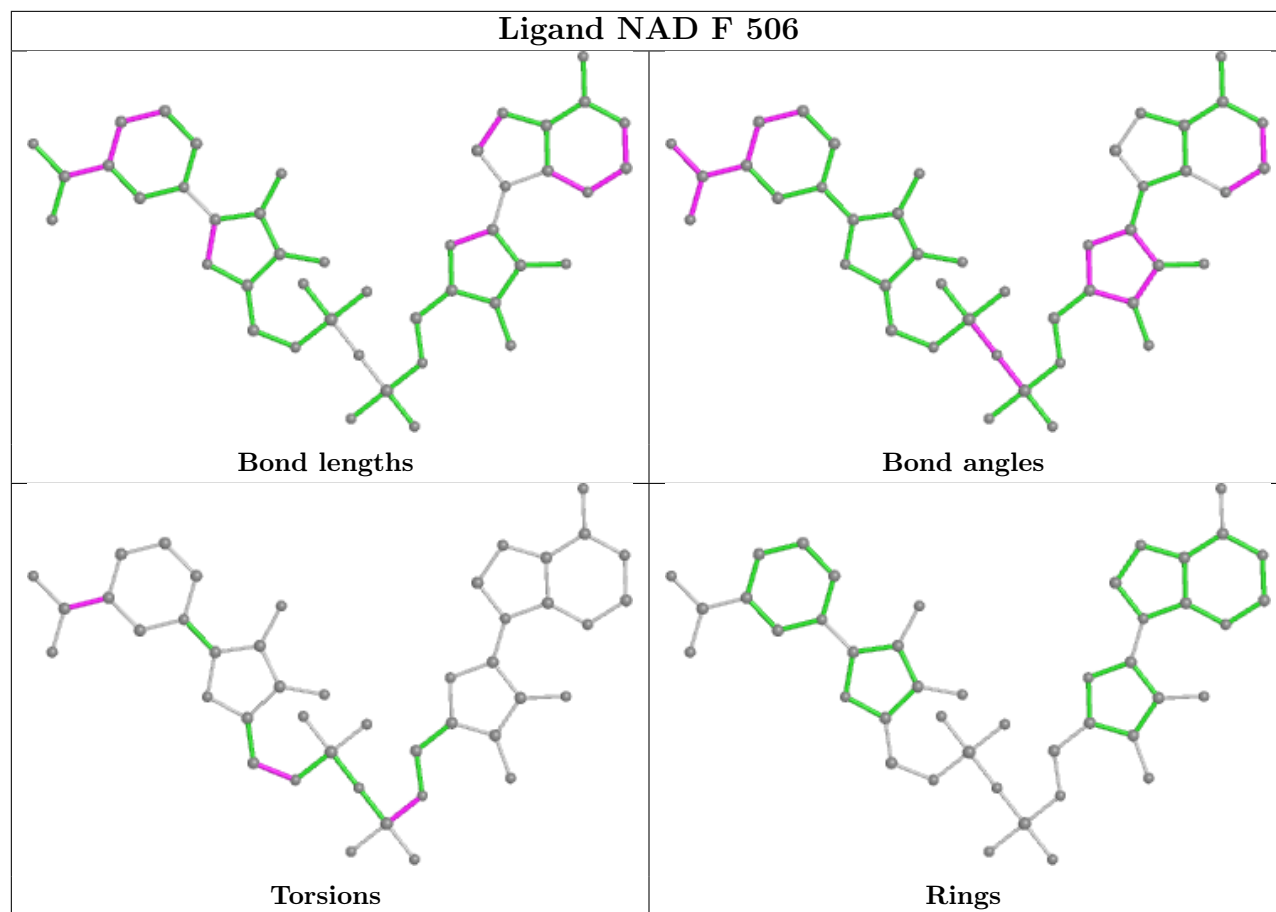

5.7 Other polymers [i](#)

There are no such residues in this entry.

5.8 Polymer linkage issues [i](#)

There are no chain breaks in this entry.

6 Fit of model and data [i](#)

6.1 Protein, DNA and RNA chains [i](#)

In the following table, the column labelled ‘#RSRZ > 2’ contains the number (and percentage) of RSRZ outliers, followed by percent RSRZ outliers for the chain as percentile scores relative to all X-ray entries and entries of similar resolution. The OWAB column contains the minimum, median, 95th percentile and maximum values of the occupancy-weighted average B-factor per residue. The column labelled ‘Q < 0.9’ lists the number of (and percentage) of residues with an average occupancy less than 0.9.

Mol	Chain	Analysed	<RSRZ>	#RSRZ>2	OWAB(Å ²)	Q<0.9
1	A	494/500 (98%)	0.71	55 (11%) 5 5	21, 67, 104, 123	0
1	B	494/500 (98%)	-0.15	5 (1%) 82 84	24, 40, 78, 98	0
1	C	494/500 (98%)	-0.12	2 (0%) 92 93	23, 40, 72, 88	0
1	D	494/500 (98%)	0.60	38 (7%) 13 13	25, 68, 97, 118	0
1	E	494/500 (98%)	-0.17	2 (0%) 92 93	23, 41, 68, 96	0
1	F	494/500 (98%)	-0.09	3 (0%) 89 90	21, 37, 66, 94	0
1	G	494/500 (98%)	0.08	6 (1%) 79 80	26, 46, 68, 98	0
1	H	494/500 (98%)	0.11	12 (2%) 59 62	24, 46, 77, 91	0
1	I	494/500 (98%)	0.37	20 (4%) 38 41	36, 58, 82, 105	0
1	J	494/500 (98%)	0.77	41 (8%) 11 11	44, 77, 104, 114	0
1	K	494/500 (98%)	0.57	39 (7%) 12 12	44, 71, 96, 115	0
1	L	494/500 (98%)	1.15	98 (19%) 1 1	47, 89, 115, 127	0
All	All	5928/6000 (98%)	0.32	321 (5%) 25 27	21, 55, 99, 127	0

The worst 5 of 321 RSRZ outliers are listed below:

Mol	Chain	Res	Type	RSRZ
1	L	378	GLY	7.2
1	L	369	CYS	5.9
1	L	223	GLY	5.4
1	L	386	PHE	5.0
1	G	474	GLY	5.0

6.2 Non-standard residues in protein, DNA, RNA chains [i](#)

There are no non-standard protein/DNA/RNA residues in this entry.

6.3 Carbohydrates [i](#)

There are no monosaccharides in this entry.

6.4 Ligands [i](#)

In the following table, the Atoms column lists the number of modelled atoms in the group and the number defined in the chemical component dictionary. The B-factors column lists the minimum, median, 95th percentile and maximum values of B factors of atoms in the group. The column labelled 'Q< 0.9' lists the number of atoms with occupancy less than 0.9.

Mol	Type	Chain	Res	Atoms	RSCC	RSR	B-factors(Å ²)	Q<0.9
2	NA	J	610	1/1	0.56	0.12	75,75,75,75	0
2	NA	A	601	1/1	0.61	0.27	82,82,82,82	0
2	NA	C	603	1/1	0.67	0.23	54,54,54,54	0
2	NA	D	604	1/1	0.69	0.09	73,73,73,73	0
4	EDO	I	809	4/4	0.70	0.36	81,82,82,82	0
4	EDO	K	911	4/4	0.71	0.22	79,80,80,80	0
4	EDO	C	903	4/4	0.76	0.27	45,49,49,52	0
3	ADP	D	504[A]	27/27	0.76	0.29	79,81,86,86	27
3	ADP	D	504[B]	27/27	0.76	0.29	89,91,96,96	27
4	EDO	E	805	4/4	0.80	0.43	83,83,85,85	0
5	GAI	D	905	4/4	0.80	0.28	77,78,78,78	0
4	EDO	H	908	4/4	0.81	0.26	79,79,79,80	0
2	NA	I	609	1/1	0.81	0.13	54,54,54,54	0
2	NA	G	607	1/1	0.82	0.07	46,46,46,46	0
3	ADP	J	510	27/27	0.83	0.18	102,104,114,115	0
4	EDO	G	907	4/4	0.83	0.32	68,68,68,69	0
4	EDO	D	904	4/4	0.83	0.24	74,74,75,75	0
4	EDO	B	802	4/4	0.84	0.23	48,48,52,53	0
4	EDO	L	712	4/4	0.85	0.25	70,72,73,73	0
5	GAI	I	910	4/4	0.85	0.44	94,94,94,95	0
3	ADP	A	501[A]	27/27	0.86	0.20	78,80,81,81	27
4	EDO	F	706	4/4	0.86	0.38	74,76,79,80	0
3	ADP	A	501[B]	27/27	0.86	0.20	91,93,93,93	27
5	GAI	J	611	4/4	0.87	0.21	64,66,66,66	0
4	EDO	A	901	4/4	0.88	0.28	75,75,76,77	0
5	GAI	E	907	4/4	0.88	0.21	47,48,49,49	0
6	NAD	B	502	44/44	0.88	0.23	73,88,103,104	0
6	NAD	C	503	44/44	0.88	0.20	58,81,92,93	0
4	EDO	G	807	4/4	0.89	0.16	75,75,75,75	0
2	NA	L	612	1/1	0.89	0.17	80,80,80,80	0
2	NA	B	5003	1/1	0.89	0.17	55,55,55,55	0
6	NAD	H	508	44/44	0.89	0.16	49,81,89,90	0

Continued on next page...

Continued from previous page...

Mol	Type	Chain	Res	Atoms	RSCC	RSR	B-factors(Å ²)	Q<0.9
5	GAI	H	909	4/4	0.90	0.32	95,95,95,95	0
3	ADP	L	512	27/27	0.90	0.21	89,97,112,113	0
4	EDO	H	808	4/4	0.90	0.21	63,64,64,65	0
4	EDO	F	707	4/4	0.90	0.29	59,59,61,61	0
5	GAI	E	906	4/4	0.90	0.31	51,54,55,55	0
6	NAD	G	507	44/44	0.90	0.19	61,77,91,92	0
3	ADP	K	511	27/27	0.90	0.18	94,99,105,106	0
4	EDO	E	705	4/4	0.91	0.34	77,80,80,80	0
3	ADP	I	509	27/27	0.91	0.16	79,81,94,95	0
2	NA	E	605	1/1	0.91	0.07	37,37,37,37	0
4	EDO	C	803	4/4	0.92	0.15	49,53,53,55	0
2	NA	H	608	1/1	0.92	0.10	46,46,46,46	0
6	NAD	F	506	44/44	0.92	0.17	38,68,81,84	0
3	ADP	E	505	27/27	0.92	0.15	43,52,79,80	0
4	EDO	I	909	4/4	0.92	0.15	62,62,63,64	0
2	NA	K	5012	1/1	0.93	0.16	60,60,60,60	0
2	NA	K	611	1/1	0.93	0.09	63,63,63,63	0
4	EDO	E	905	4/4	0.93	0.23	51,52,53,58	0
4	EDO	B	902	4/4	0.93	0.30	63,63,65,65	0
4	EDO	L	912	4/4	0.94	0.25	68,69,70,72	0
4	EDO	D	704	4/4	0.94	0.14	53,54,56,56	0
5	GAI	G	5009	4/4	0.94	0.25	76,76,76,76	0
5	GAI	G	5010	4/4	0.94	0.25	47,47,49,49	0
2	NA	F	606	1/1	0.95	0.08	32,32,32,32	0
2	NA	C	5004	1/1	0.95	0.44	51,51,51,51	0
5	GAI	A	902	4/4	0.95	0.18	63,64,64,65	0
2	NA	F	5007	1/1	0.95	0.20	54,54,54,54	0
4	EDO	B	701	4/4	0.96	0.19	67,67,67,68	0
4	EDO	F	906	4/4	0.96	0.18	63,63,65,65	0
4	EDO	H	708	4/4	0.96	0.19	47,49,51,53	0
2	NA	B	602	1/1	0.96	0.06	40,40,40,40	0
2	NA	G	5008	1/1	0.97	0.47	48,48,48,48	0
4	EDO	F	806	4/4	0.97	0.16	53,54,54,58	0

The following is a graphical depiction of the model fit to experimental electron density of all instances of the Ligand of Interest. In addition, ligands with molecular weight > 250 and outliers as shown on the geometry validation Tables will also be included. Each fit is shown from different orientation to approximate a three-dimensional view.

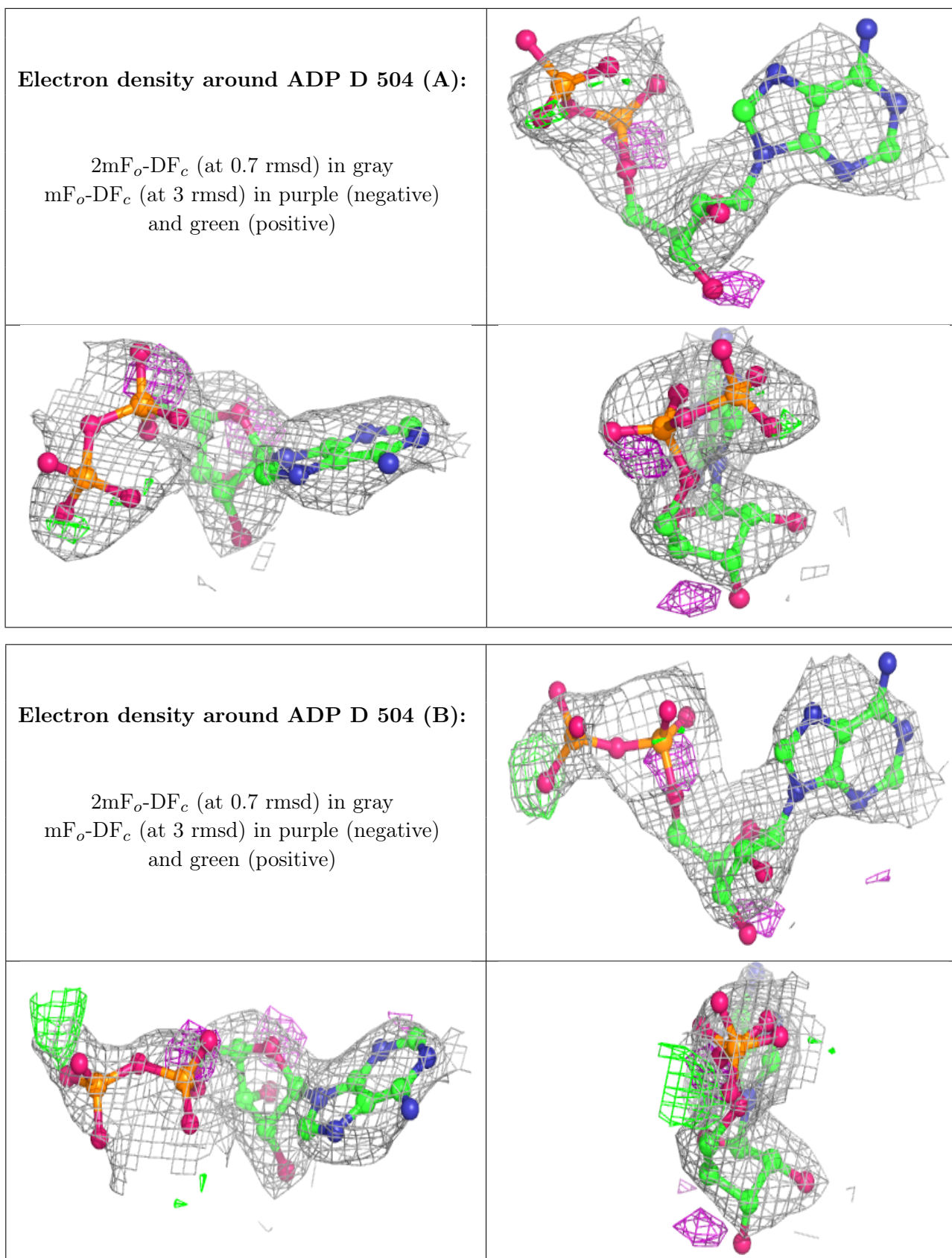

Electron density around ADP J 510:

$2mF_o-DF_c$ (at 0.7 rmsd) in gray
 mF_o-DF_c (at 3 rmsd) in purple (negative)
and green (positive)

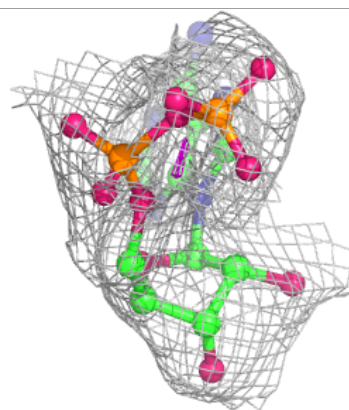
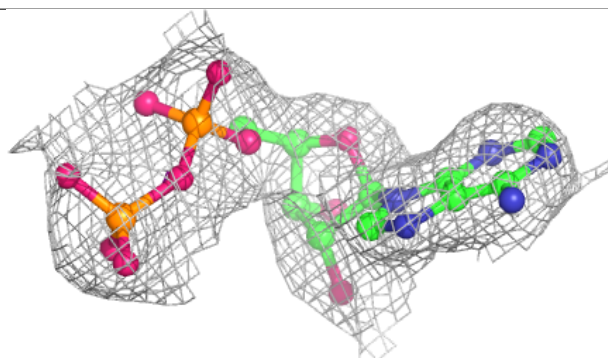
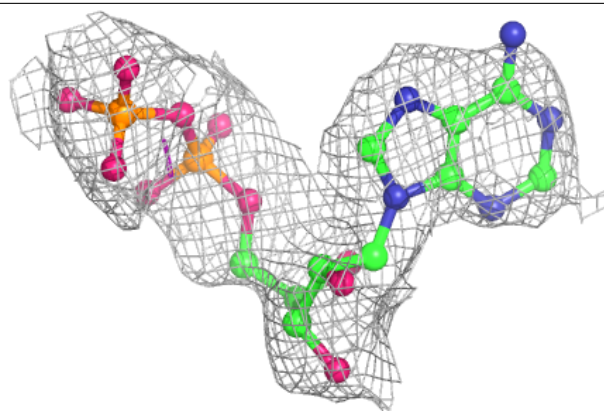
**Electron density around ADP A 501 (A):**

$2mF_o-DF_c$ (at 0.7 rmsd) in gray
 mF_o-DF_c (at 3 rmsd) in purple (negative)
and green (positive)

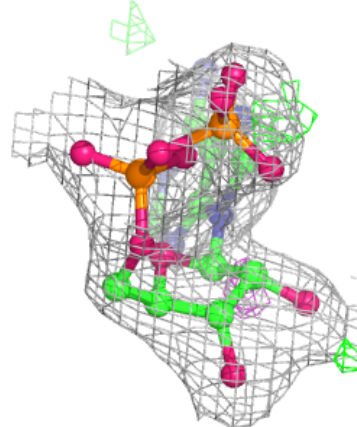
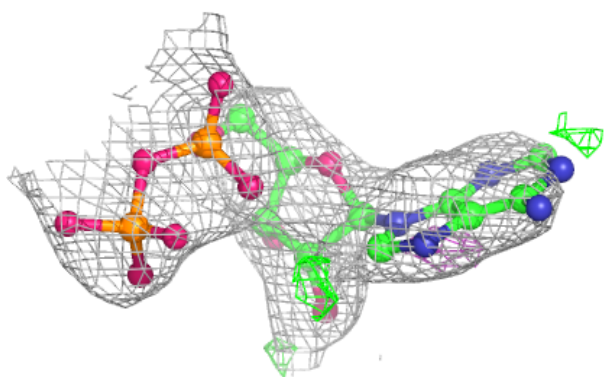
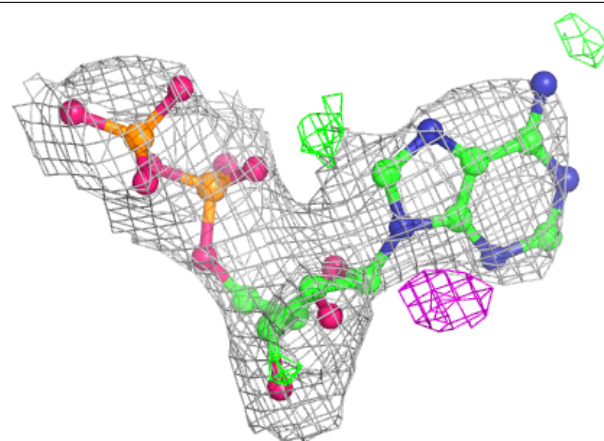

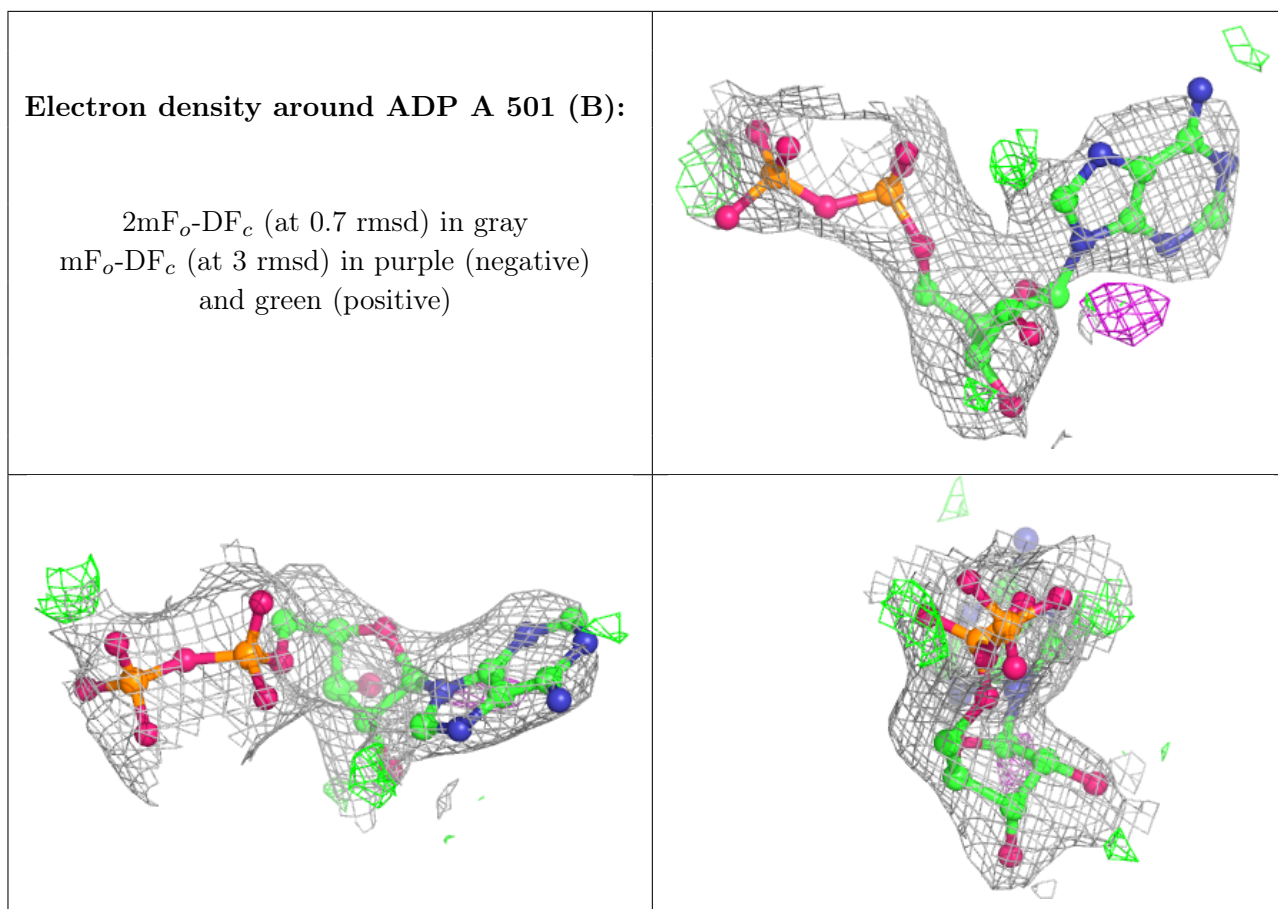

Electron density around NAD B 502:

$2mF_o-DF_c$ (at 0.7 rmsd) in gray
 mF_o-DF_c (at 3 rmsd) in purple (negative)
and green (positive)

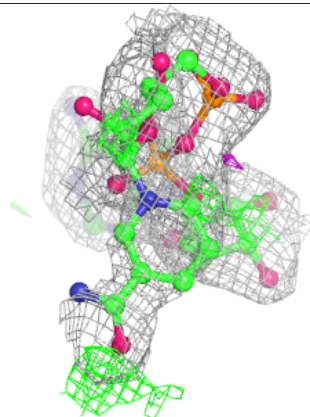
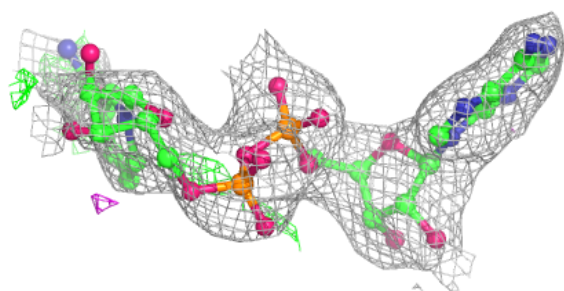
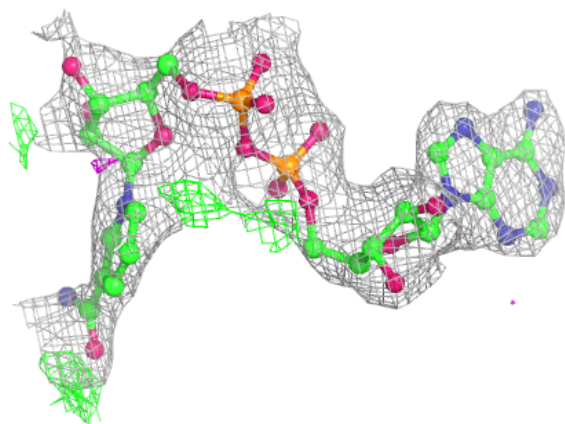
**Electron density around NAD C 503:**

$2mF_o-DF_c$ (at 0.7 rmsd) in gray
 mF_o-DF_c (at 3 rmsd) in purple (negative)
and green (positive)

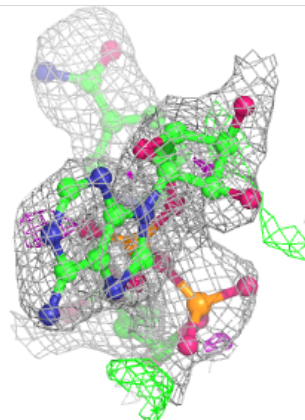
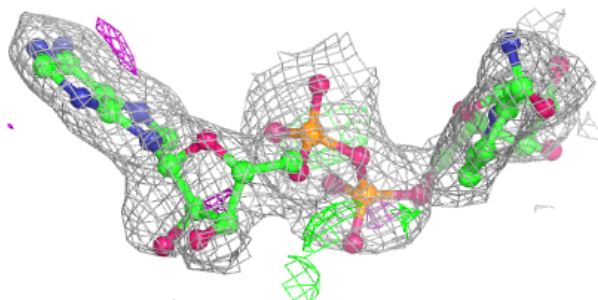
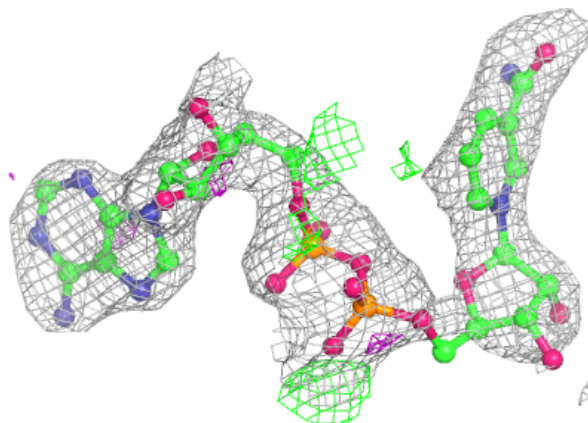

Electron density around NAD H 508:

$2mF_o-DF_c$ (at 0.7 rmsd) in gray
 mF_o-DF_c (at 3 rmsd) in purple (negative)
and green (positive)

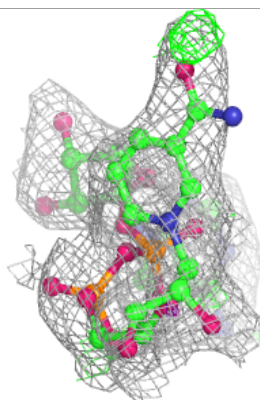
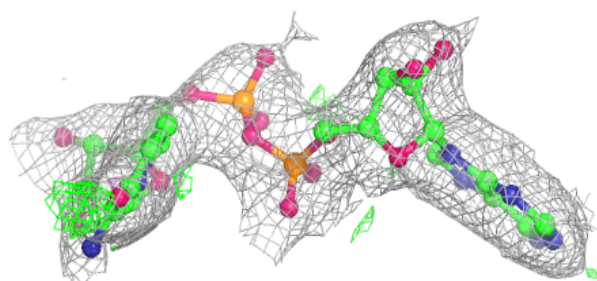
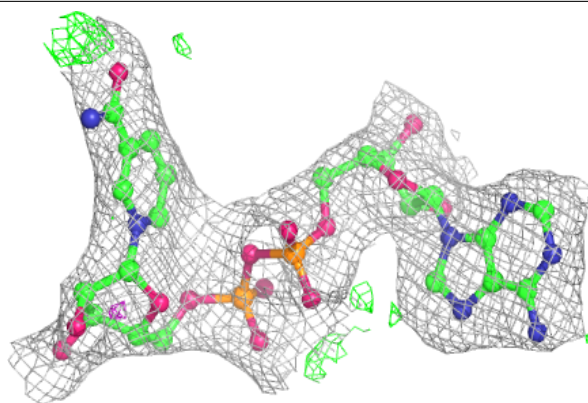
**Electron density around ADP L 512:**

$2mF_o-DF_c$ (at 0.7 rmsd) in gray
 mF_o-DF_c (at 3 rmsd) in purple (negative)
and green (positive)

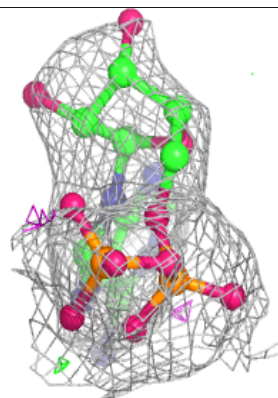
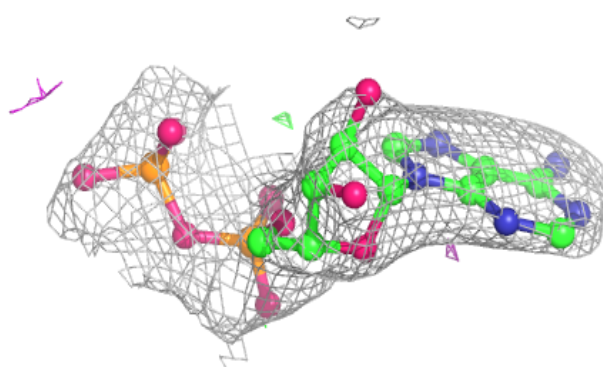
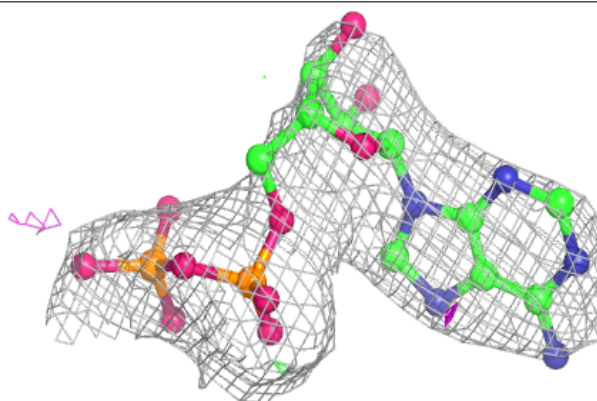

Electron density around NAD G 507:

$2mF_o-DF_c$ (at 0.7 rmsd) in gray
 mF_o-DF_c (at 3 rmsd) in purple (negative)
and green (positive)

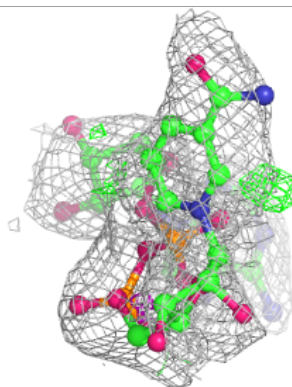
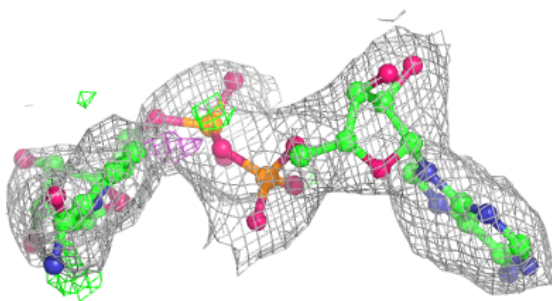
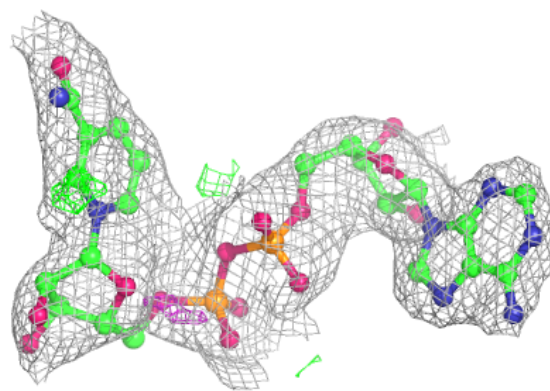
**Electron density around ADP K 511:**

$2mF_o-DF_c$ (at 0.7 rmsd) in gray
 mF_o-DF_c (at 3 rmsd) in purple (negative)
and green (positive)

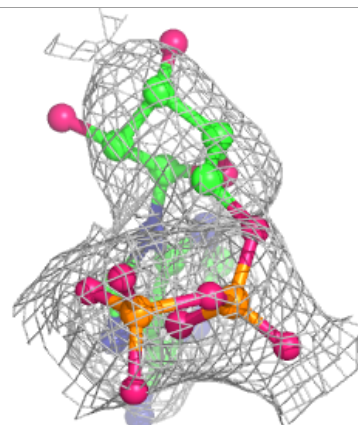
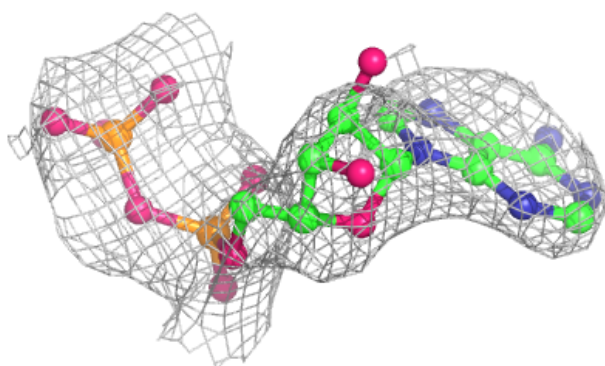
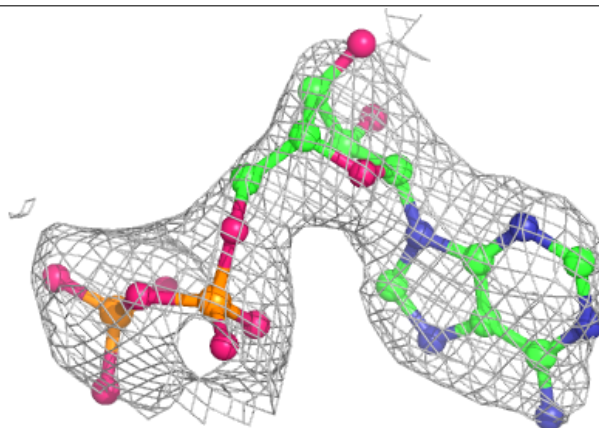

Electron density around ADP I 509:

$2mF_o-DF_c$ (at 0.7 rmsd) in gray
 mF_o-DF_c (at 3 rmsd) in purple (negative)
and green (positive)

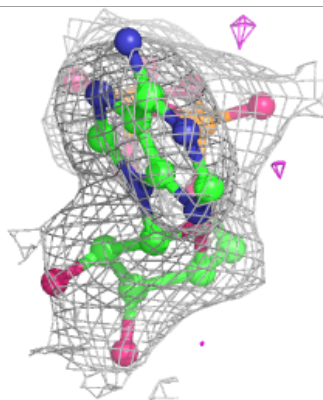
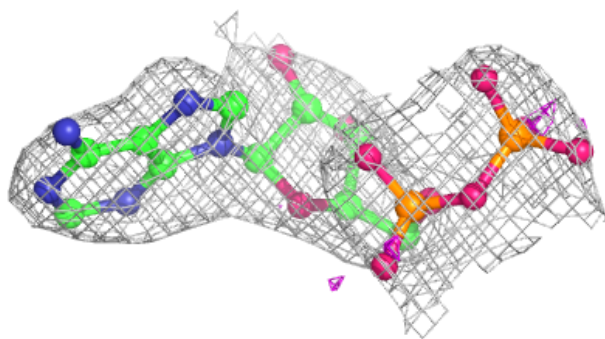
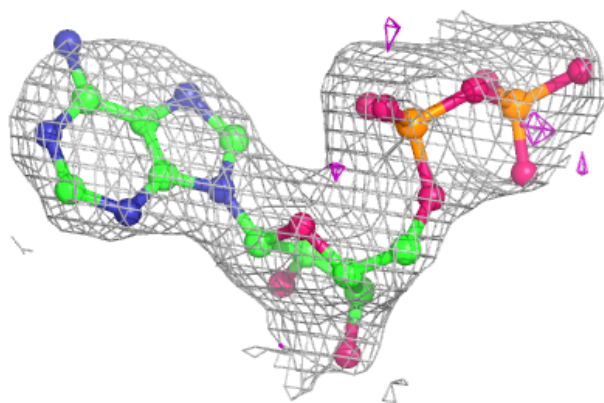
**Electron density around NAD F 506:**

$2mF_o-DF_c$ (at 0.7 rmsd) in gray
 mF_o-DF_c (at 3 rmsd) in purple (negative)
and green (positive)

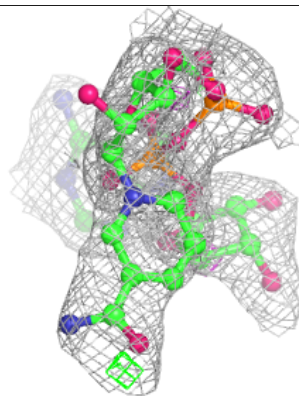
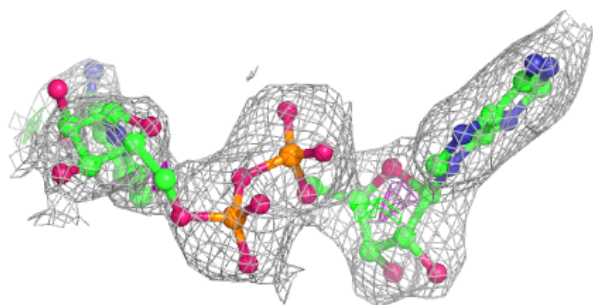
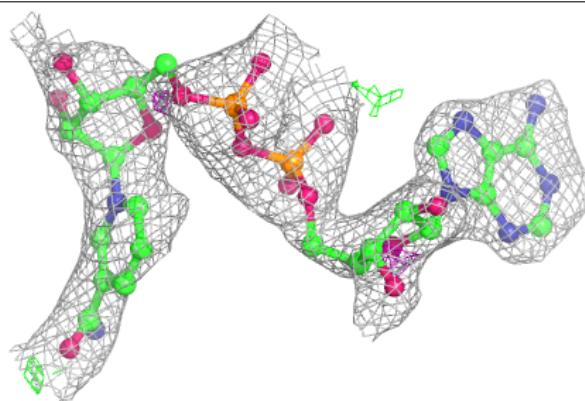

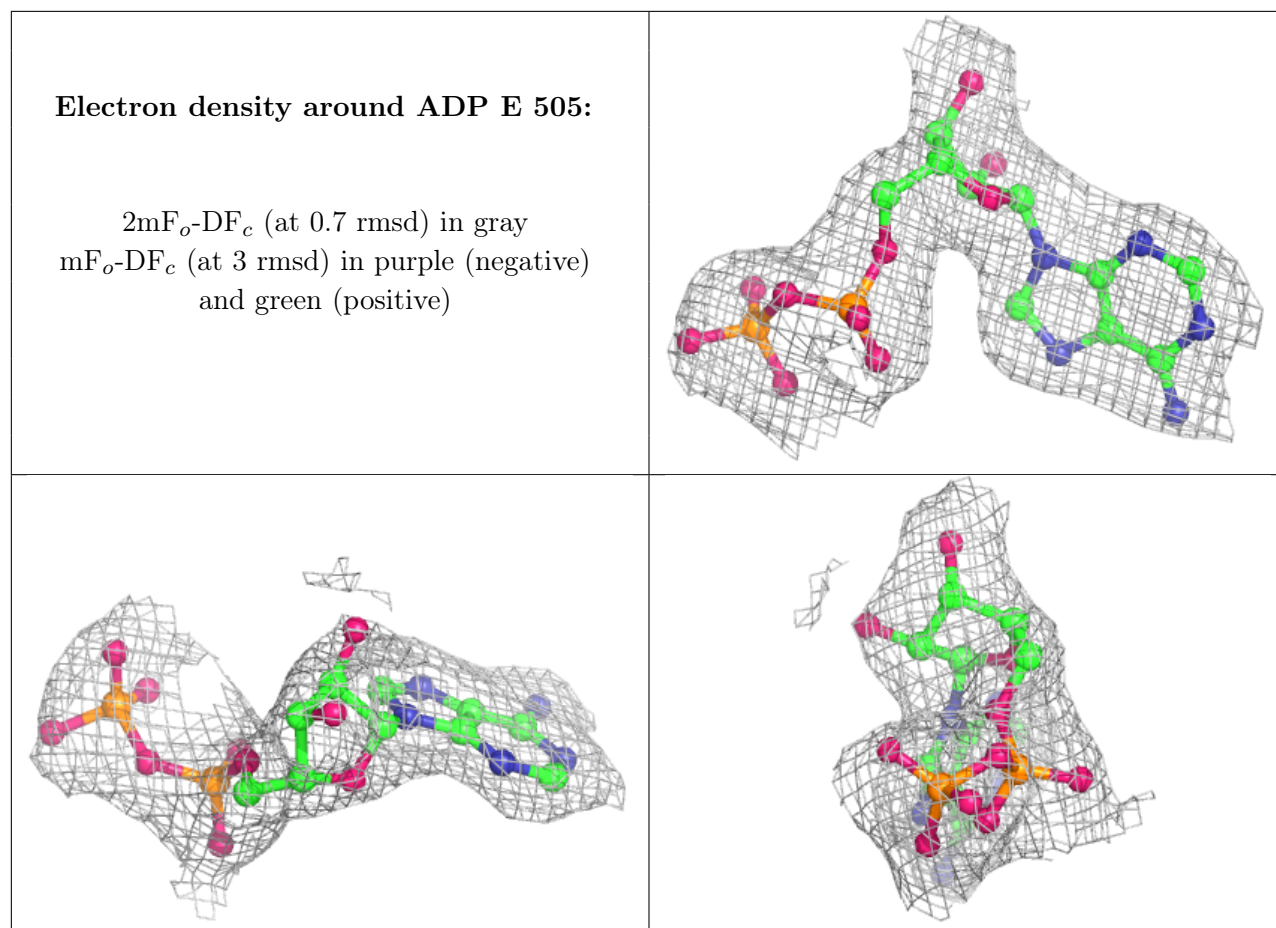

6.5 Other polymers [i](#)

There are no such residues in this entry.