



# Full wwPDB X-ray Structure Validation Report ⓘ

Feb 4, 2024 – 01:57 AM EST

PDB ID : 1OXV  
Title : Crystal structure of GlcV, the ABC-ATPase of the glucose ABC transporter from *Sulfolobus solfataricus*  
Authors : Verdon, G.; Albers, S.V.; Dijkstra, B.W.; Driessen, A.J.; Thunnissen, A.M.  
Deposited on : 2003-04-03  
Resolution : 1.95 Å(reported)

This is a Full wwPDB X-ray Structure Validation Report for a publicly released PDB entry.

We welcome your comments at [validation@mail.wwpdb.org](mailto:validation@mail.wwpdb.org)

A user guide is available at

<https://www.wwpdb.org/validation/2017/XrayValidationReportHelp>

with specific help available everywhere you see the ⓘ symbol.

The types of validation reports are described at

<http://www.wwpdb.org/validation/2017/FAQs#types>.

---

The following versions of software and data (see [references ⓘ](#)) were used in the production of this report:

MolProbity : 4.02b-467  
Mogul : 1.8.5 (274361), CSD as541be (2020)  
Xtriage (Phenix) : 1.13  
EDS : 2.36  
buster-report : 1.1.7 (2018)  
Percentile statistics : 20191225.v01 (using entries in the PDB archive December 25th 2019)  
Refmac : 5.8.0158  
CCP4 : 7.0.044 (Gargrove)  
Ideal geometry (proteins) : Engh & Huber (2001)  
Ideal geometry (DNA, RNA) : Parkinson et al. (1996)  
Validation Pipeline (wwPDB-VP) : 2.36

# 1 Overall quality at a glance

The following experimental techniques were used to determine the structure:

*X-RAY DIFFRACTION*

The reported resolution of this entry is 1.95 Å.

Percentile scores (ranging between 0-100) for global validation metrics of the entry are shown in the following graphic. The table shows the number of entries on which the scores are based.

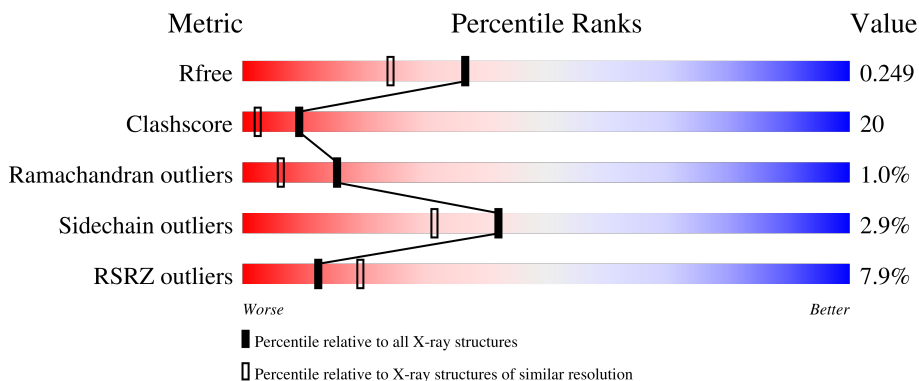

Metric	Whole archive (#Entries)	Similar resolution (#Entries, resolution range(Å))
$R_{free}$	130704	2580 (1.96-1.96)
Clashscore	141614	2705 (1.96-1.96)
Ramachandran outliers	138981	2678 (1.96-1.96)
Sidechain outliers	138945	2678 (1.96-1.96)
RSRZ outliers	127900	2539 (1.96-1.96)

The table below summarises the geometric issues observed across the polymeric chains and their fit to the electron density. The red, orange, yellow and green segments of the lower bar indicate the fraction of residues that contain outliers for  $\geq 3$ , 2, 1 and 0 types of geometric quality criteria respectively. A grey segment represents the fraction of residues that are not modelled. The numeric value for each fraction is indicated below the corresponding segment, with a dot representing fractions  $\leq 5\%$ . The upper red bar (where present) indicates the fraction of residues that have poor fit to the electron density. The numeric value is given above the bar.

Mol	Chain	Length	Quality of chain
1	A	353	
1	B	353	
1	D	353	

The following table lists non-polymeric compounds, carbohydrate monomers and non-standard residues in protein, DNA, RNA chains that are outliers for geometric or electron-density-fit criteria:

Mol	Type	Chain	Res	Chirality	Geometry	Clashes	Electron density
3	IOD	A	1202	-	-	X	-
3	IOD	A	1217	-	-	X	-
3	IOD	A	1227	-	-	X	-
3	IOD	A	1228	-	-	X	-
3	IOD	B	1221	-	-	X	-
3	IOD	B	1236	-	-	X	-
3	IOD	D	1208	-	-	X	-
3	IOD	D	1222	-	-	X	-

## 2 Entry composition [i](#)

There are 5 unique types of molecules in this entry. The entry contains 9042 atoms, of which 0 are hydrogens and 0 are deuteriums.

In the tables below, the ZeroOcc column contains the number of atoms modelled with zero occupancy, the AltConf column contains the number of residues with at least one atom in alternate conformation and the Trace column contains the number of residues modelled with at most 2 atoms.

- Molecule 1 is a protein called ABC transporter, ATP binding protein.

Mol	Chain	Residues	Atoms					ZeroOcc	AltConf	Trace
			Total	C	N	O	S			
1	A	353	2702	1736	468	491	7	0	17	0
1	B	353	2672	1717	464	485	6	0	11	0
1	D	353	2671	1714	461	489	7	0	7	0

- Molecule 2 is MAGNESIUM ION (three-letter code: MG) (formula: Mg).

Mol	Chain	Residues	Atoms		ZeroOcc	AltConf
2	A	1	Total	Mg	0	0
			1	1		
2	B	1	Total	Mg	0	0
			1	1		
2	D	1	Total	Mg	0	0
			1	1		

- Molecule 3 is IODIDE ION (three-letter code: IOD) (formula: I).

Mol	Chain	Residues	Atoms		ZeroOcc	AltConf
3	A	15	Total	I	0	0
			15	15		
3	B	12	Total	I	0	0
			12	12		
3	D	11	Total	I	0	0
			11	11		

- Molecule 4 is PHOSPHOAMINOPHOSPHONIC ACID-ADENYLATE ESTER (three-letter code: ANP) (formula: C<sub>10</sub>H<sub>17</sub>N<sub>6</sub>O<sub>12</sub>P<sub>3</sub>).



### 3 Residue-property plots [i](#)

These plots are drawn for all protein, RNA, DNA and oligosaccharide chains in the entry. The first graphic for a chain summarises the proportions of the various outlier classes displayed in the second graphic. The second graphic shows the sequence view annotated by issues in geometry and electron density. Residues are color-coded according to the number of geometric quality criteria for which they contain at least one outlier: green = 0, yellow = 1, orange = 2 and red = 3 or more. A red dot above a residue indicates a poor fit to the electron density ( $RSRZ > 2$ ). Stretches of 2 or more consecutive residues without any outlier are shown as a green connector. Residues present in the sample, but not in the model, are shown in grey.

- Molecule 1: ABC transporter, ATP binding protein

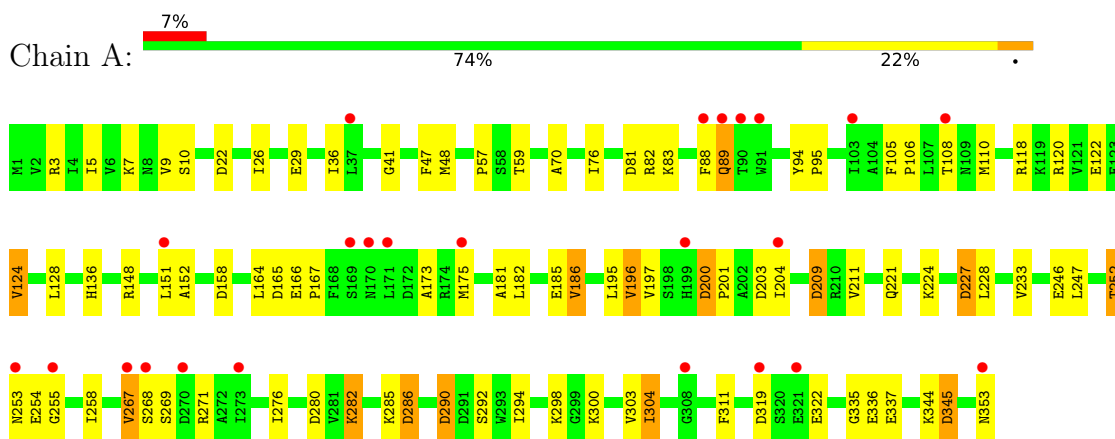

- Molecule 1: ABC transporter, ATP binding protein

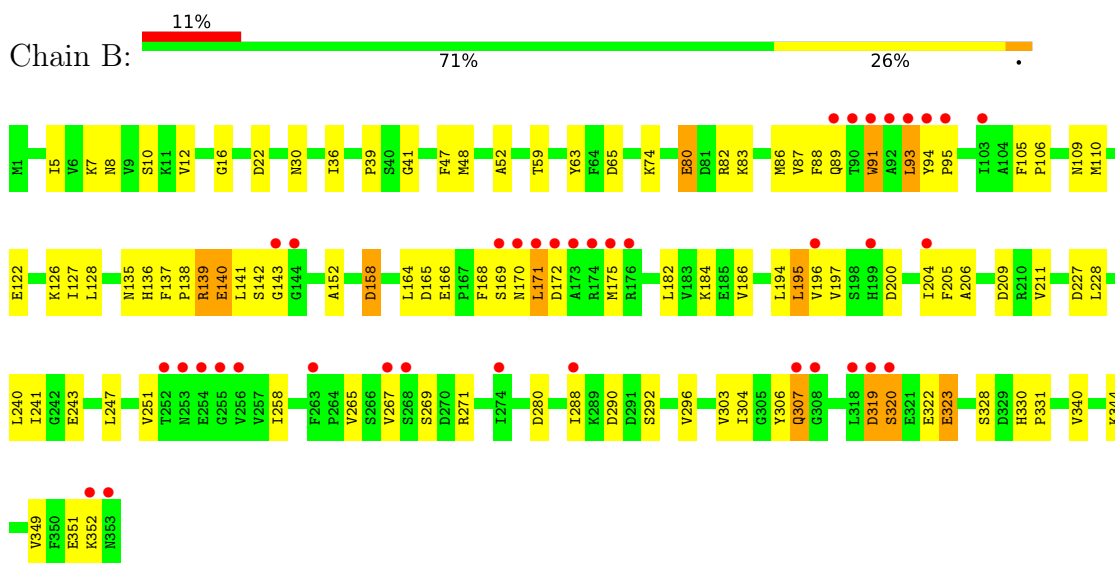

- Molecule 1: ABC transporter, ATP binding protein

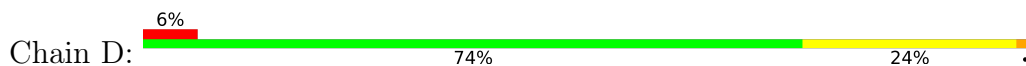

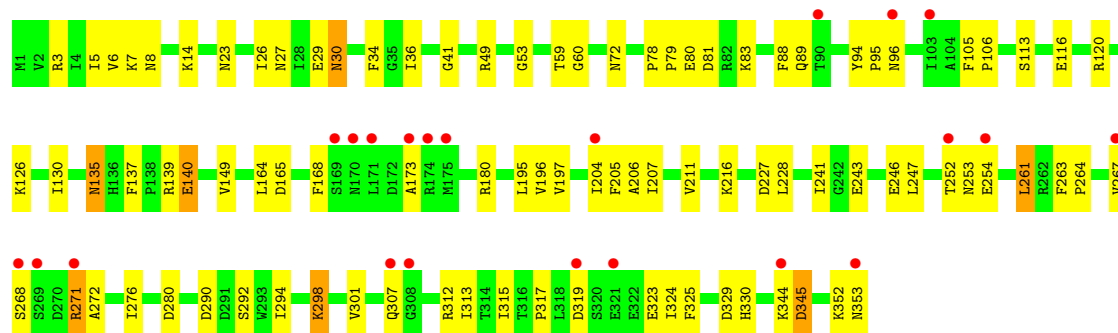

## 4 Data and refinement statistics i

Property	Value	Source
Space group	P 21 21 21	Depositor
Cell constants a, b, c, $\alpha$ , $\beta$ , $\gamma$	47.09Å 148.78Å 176.71Å 90.00° 90.00° 90.00°	Depositor
Resolution (Å)	20.00 – 1.95 19.99 – 1.95	Depositor EDS
% Data completeness (in resolution range)	100.0 (20.00-1.95) 95.9 (19.99-1.95)	Depositor EDS
$R_{merge}$	(Not available)	Depositor
$R_{sym}$	0.08	Depositor
$\langle I/\sigma(I) \rangle$ <sup>1</sup>	3.27 (at 1.94Å)	Xtrriage
Refinement program	REFMAC 5.0	Depositor
R, $R_{free}$	0.188 , 0.240 0.202 , 0.249	Depositor DCC
$R_{free}$ test set	4465 reflections (5.09%)	wwPDB-VP
Wilson B-factor (Å <sup>2</sup> )	26.3	Xtrriage
Anisotropy	0.126	Xtrriage
Bulk solvent $k_{sol}$ (e/Å <sup>3</sup> ), $B_{sol}$ (Å <sup>2</sup> )	0.34 , 55.8	EDS
L-test for twinning <sup>2</sup>	$\langle  L  \rangle = 0.50$ , $\langle L^2 \rangle = 0.33$	Xtrriage
Estimated twinning fraction	No twinning to report.	Xtrriage
$F_o, F_c$ correlation	0.95	EDS
Total number of atoms	9042	wwPDB-VP
Average B, all atoms (Å <sup>2</sup> )	24.0	wwPDB-VP

Xtrriage's analysis on translational NCS is as follows: *The analyses of the Patterson function reveals a significant off-origin peak that is 54.01 % of the origin peak, indicating pseudo-translational symmetry. The chance of finding a peak of this or larger height randomly in a structure without pseudo-translational symmetry is equal to 3.8814e-05. The detected translational NCS is most likely also responsible for the elevated intensity ratio.*

<sup>1</sup>Intensities estimated from amplitudes.

<sup>2</sup>Theoretical values of  $\langle |L| \rangle$ ,  $\langle L^2 \rangle$  for acentric reflections are 0.5, 0.333 respectively for untwinned datasets, and 0.375, 0.2 for perfectly twinned datasets.



## 5 Model quality i

### 5.1 Standard geometry i

Bond lengths and bond angles in the following residue types are not validated in this section: IOD, MG, ANP

The Z score for a bond length (or angle) is the number of standard deviations the observed value is removed from the expected value. A bond length (or angle) with  $|Z| > 5$  is considered an outlier worth inspection. RMSZ is the root-mean-square of all Z scores of the bond lengths (or angles).

Mol	Chain	Bond lengths		Bond angles	
		RMSZ	# $ Z  > 5$	RMSZ	# $ Z  > 5$
1	A	0.51	2/2832 (0.1%)	0.75	12/3828 (0.3%)
1	B	0.43	1/2772 (0.0%)	0.74	10/3748 (0.3%)
1	D	0.42	0/2758	0.71	6/3730 (0.2%)
All	All	0.46	3/8362 (0.0%)	0.73	28/11306 (0.2%)

All (3) bond length outliers are listed below:

Mol	Chain	Res	Type	Atoms	Z	Observed(Å)	Ideal(Å)
1	A	282[A]	LYS	C-N	-10.51	1.09	1.34
1	A	282[B]	LYS	C-N	-10.51	1.09	1.34
1	B	139	ARG	C-N	9.99	1.57	1.34

All (28) bond angle outliers are listed below:

Mol	Chain	Res	Type	Atoms	Z	Observed(°)	Ideal(°)
1	B	140	GLU	O-C-N	-10.43	106.01	122.70
1	B	65	ASP	CB-CG-OD2	6.79	124.41	118.30
1	B	140	GLU	CA-C-N	6.58	131.67	117.20
1	A	22	ASP	CB-CG-OD2	6.38	124.05	118.30
1	A	290	ASP	CB-CG-OD2	6.34	124.01	118.30
1	A	200	ASP	CB-CG-OD2	6.31	123.98	118.30
1	A	286	ASP	CB-CG-OD2	5.88	123.59	118.30
1	D	227	ASP	CB-CG-OD2	5.84	123.55	118.30
1	D	280	ASP	CB-CG-OD2	5.82	123.54	118.30
1	D	319	ASP	CB-CG-OD2	5.79	123.51	118.30
1	B	280	ASP	CB-CG-OD2	5.79	123.51	118.30
1	B	319	ASP	CB-CG-OD2	5.71	123.44	118.30
1	A	345	ASP	CB-CG-OD2	5.66	123.40	118.30
1	B	209	ASP	CB-CG-OD2	5.57	123.31	118.30
1	D	81	ASP	CB-CG-OD2	5.50	123.25	118.30

*Continued on next page...*

Continued from previous page...

Mol	Chain	Res	Type	Atoms	Z	Observed(°)	Ideal(°)
1	A	280	ASP	CB-CG-OD2	5.48	123.23	118.30
1	B	158	ASP	CB-CG-OD2	5.43	123.19	118.30
1	A	319	ASP	CB-CG-OD2	5.43	123.18	118.30
1	B	22	ASP	CB-CG-OD2	5.29	123.06	118.30
1	B	200	ASP	CB-CG-OD2	5.28	123.05	118.30
1	D	345	ASP	CB-CG-OD2	5.25	123.03	118.30
1	A	81	ASP	CB-CG-OD2	5.24	123.02	118.30
1	B	227	ASP	CB-CG-OD2	5.16	122.95	118.30
1	D	329	ASP	CB-CG-OD2	5.12	122.91	118.30
1	A	158	ASP	CB-CG-OD2	5.09	122.88	118.30
1	A	227	ASP	CB-CG-OD2	5.09	122.88	118.30
1	A	203	ASP	CB-CG-OD2	5.08	122.87	118.30
1	A	209	ASP	CB-CG-OD2	5.03	122.83	118.30

There are no chirality outliers.

There are no planarity outliers.

## 5.2 Too-close contacts

In the following table, the Non-H and H(model) columns list the number of non-hydrogen atoms and hydrogen atoms in the chain respectively. The H(added) column lists the number of hydrogen atoms added and optimized by MolProbity. The Clashes column lists the number of clashes within the asymmetric unit, whereas Symm-Clashes lists symmetry-related clashes.

Mol	Chain	Non-H	H(model)	H(added)	Clashes	Symm-Clashes
1	A	2702	0	2778	105	1
1	B	2672	0	2734	110	2
1	D	2671	0	2727	106	2
2	A	1	0	0	0	0
2	B	1	0	0	0	0
2	D	1	0	0	0	0
3	A	15	0	0	13	1
3	B	12	0	0	6	0
3	D	11	0	0	6	0
4	A	31	0	13	1	0
4	B	31	0	13	1	0
4	D	31	0	13	1	0
5	A	299	0	0	18	4
5	B	242	0	0	13	0
5	D	322	0	0	22	1
All	All	9042	0	8278	328	6

The all-atom clashscore is defined as the number of clashes found per 1000 atoms (including hydrogen atoms). The all-atom clashscore for this structure is 20.

All (328) close contacts within the same asymmetric unit are listed below, sorted by their clash magnitude.

Atom-1	Atom-2	Interatomic distance (Å)	Clash overlap (Å)
1:B:194:LEU:HD21	1:B:196[B]:VAL:CG2	1.69	1.23
1:D:352:LYS:HG3	1:D:353:ASN:N	1.47	1.17
1:B:211:VAL:HG13	1:B:228:LEU:HD11	1.26	1.16
3:A:1228:IOD:I	5:A:1446:HOH:O	2.36	1.14
1:A:175:MET:HE2	5:A:1415:HOH:O	1.45	1.13
1:D:352:LYS:CG	1:D:353:ASN:H	1.59	1.12
1:D:96:ASN:OD1	1:D:96:ASN:O	1.71	1.09
1:B:140:GLU:OE2	5:B:1361:HOH:O	1.69	1.07
3:A:1230:IOD:I	5:A:1384:HOH:O	2.41	1.06
1:A:182:LEU:O	1:A:186[A]:VAL:HG13	1.60	1.01
1:B:290:ASP:OD1	1:B:292:SER:OG	1.79	1.00
1:D:140:GLU:HG3	5:D:1422:HOH:O	1.60	1.00
1:B:211:VAL:HG13	1:B:228:LEU:CD1	1.91	0.99
1:B:12[B]:VAL:HG11	1:B:16:GLY:HA2	1.46	0.98
1:B:164:LEU:HB2	1:B:196[B]:VAL:HG13	1.50	0.94
1:B:110:MET:HA	1:B:110:MET:HE2	1.49	0.93
1:B:194:LEU:HD21	1:B:196[B]:VAL:HG22	1.50	0.93
1:A:26:ILE:HD12	3:A:1202:IOD:I	2.39	0.93
1:D:14[B]:LYS:NZ	5:D:1531:HOH:O	2.03	0.91
1:B:211:VAL:CG1	1:B:228:LEU:CD1	2.49	0.90
1:A:7[B]:LYS:NZ	1:A:7[B]:LYS:HB3	1.83	0.90
1:B:194:LEU:CD2	1:B:196[B]:VAL:CG2	2.50	0.89
1:A:165:ASP:HA	1:A:197:VAL:CG2	2.03	0.89
1:A:282[B]:LYS:NZ	5:A:1506:HOH:O	2.02	0.88
1:D:83:LYS:NZ	5:D:1534:HOH:O	2.01	0.88
1:A:3[B]:ARG:NH1	1:A:29:GLU:OE2	2.08	0.86
1:A:70:ALA:HA	1:A:76:ILE:CD1	2.07	0.85
1:B:175:MET:HE2	5:B:1401:HOH:O	1.75	0.84
1:B:211:VAL:CG1	1:B:228:LEU:HD12	2.07	0.84
1:A:3[B]:ARG:NH2	5:A:1482:HOH:O	2.10	0.84
1:B:211:VAL:HG11	1:B:228:LEU:HD12	1.59	0.83
1:B:110:MET:HA	1:B:110:MET:CE	2.08	0.83
1:D:211:VAL:HG13	1:D:228:LEU:HD11	1.60	0.82
1:A:209:ASP:OD2	5:A:1281:HOH:O	1.97	0.81
1:A:165:ASP:HA	1:A:197:VAL:HG23	1.60	0.81
1:B:290:ASP:CG	1:B:292:SER:HG	1.83	0.81
1:B:168:PHE:C	1:B:170:ASN:H	1.83	0.81

*Continued on next page...*

*Continued from previous page...*

Atom-1	Atom-2	Interatomic distance (Å)	Clash overlap (Å)
1:A:337:GLU:OE2	5:A:1459:HOH:O	1.99	0.81
1:B:12[B]:VAL:CG1	1:B:16:GLY:HA2	2.12	0.80
1:A:82:ARG:O	3:A:1217:IOD:I	2.69	0.80
1:A:304:ILE:HG22	3:A:1227:IOD:I	2.51	0.80
3:B:1221:IOD:I	3:B:1236:IOD:I	3.40	0.79
1:B:307:GLN:HA	5:B:1405[A]:HOH:O	1.82	0.79
1:B:194:LEU:HD21	1:B:196[B]:VAL:HG23	1.65	0.79
1:A:70:ALA:CA	1:A:76:ILE:HD13	2.13	0.78
1:B:267:VAL:HG22	1:B:351:GLU:HG2	1.66	0.78
1:B:7:LYS:HE3	1:B:8:ASN:OD1	1.84	0.78
1:A:294:ILE:HG13	1:A:344:LYS:HB2	1.64	0.77
1:B:194:LEU:CD2	1:B:196[B]:VAL:HG23	2.14	0.77
3:A:1238:IOD:I	5:A:1386:HOH:O	2.73	0.76
1:A:252:THR:CG2	1:A:254:GLU:H	1.99	0.76
1:D:211:VAL:HG13	1:D:228:LEU:CD1	2.15	0.76
1:D:307:GLN:OE1	5:D:1336:HOH:O	2.03	0.75
1:B:168:PHE:O	1:B:170:ASN:N	2.18	0.75
1:A:110[A]:MET:HE3	5:A:1522:HOH:O	1.87	0.75
1:D:139:ARG:HH11	1:D:139:ARG:HG2	1.52	0.75
1:D:137:PHE:O	1:D:140:GLU:HG2	1.85	0.74
1:D:7[A]:LYS:NZ	5:D:1365:HOH:O	2.20	0.74
1:D:96:ASN:HB3	3:D:1208:IOD:I	2.58	0.74
1:A:118[A]:ARG:NH1	1:A:122:GLU:OE2	2.20	0.74
1:B:82:ARG:O	3:B:1236:IOD:I	2.76	0.74
1:D:344:LYS:O	3:D:1233:IOD:I	2.75	0.74
1:A:164:LEU:HB3	1:A:167:PRO:HG3	1.68	0.73
1:B:135:ASN:OD1	5:B:1238:HOH:O	2.06	0.72
1:D:252:THR:O	1:D:254:GLU:N	2.22	0.72
1:D:352:LYS:HG3	1:D:353:ASN:H	0.67	0.72
1:A:89:GLN:HG2	1:A:166:GLU:HB2	1.71	0.72
1:D:88:PHE:CD2	3:D:1222:IOD:I	3.13	0.72
1:B:184:LYS:HD3	1:B:206:ALA:O	1.90	0.72
1:D:23:ASN:ND2	5:D:1513:HOH:O	2.20	0.72
1:B:127:ILE:HG21	5:B:1290:HOH:O	1.90	0.72
1:A:7[B]:LYS:HB3	1:A:7[B]:LYS:HZ1	1.53	0.71
3:A:1217:IOD:I	5:A:1519:HOH:O	2.78	0.71
1:A:3[A]:ARG:HD3	5:A:1424:HOH:O	1.88	0.71
1:D:36:ILE:HB	1:D:197:VAL:HG12	1.73	0.71
1:D:267:VAL:CG2	1:D:272:ALA:HB2	2.21	0.71
1:D:352:LYS:O	1:D:353:ASN:CB	2.38	0.71
1:B:52:ALA:HB1	1:B:86:MET:CE	2.22	0.70

*Continued on next page...*

*Continued from previous page...*

Atom-1	Atom-2	Interatomic distance (Å)	Clash overlap (Å)
1:D:246[B]:GLU:OE1	5:D:1516:HOH:O	2.09	0.70
1:A:70:ALA:HA	1:A:76:ILE:HD12	1.74	0.70
1:A:70:ALA:HA	1:A:76:ILE:HD13	1.73	0.69
1:A:88:PHE:HB2	3:A:1218:IOD:I	2.63	0.68
1:B:83[B]:LYS:NZ	1:B:158:ASP:O	2.26	0.68
1:A:252:THR:HG22	1:A:255:GLY:H	1.58	0.68
1:D:164:LEU:HB2	1:D:196[B]:VAL:CG2	2.22	0.68
1:D:298:LYS:HB2	1:D:298:LYS:HZ2	1.59	0.68
1:D:135:ASN:H	1:D:135:ASN:HD22	1.42	0.68
1:B:344:LYS:O	3:B:1235:IOD:I	2.82	0.67
1:A:252:THR:HG22	1:A:254:GLU:H	1.58	0.67
1:B:109:ASN:O	1:B:110:MET:CE	2.42	0.67
1:B:247:LEU:HD12	1:B:322:GLU:HB3	1.77	0.67
1:D:60:GLY:H	1:D:72:ASN:ND2	1.92	0.67
1:A:120[B]:ARG:HH11	1:A:120[B]:ARG:HG2	1.57	0.67
1:A:105:PHE:HB3	1:A:106:PRO:HD3	1.77	0.67
1:B:290:ASP:CG	1:B:292:SER:OG	2.30	0.66
1:B:267:VAL:CG2	1:B:351:GLU:HG2	2.25	0.66
1:A:269:SER:CB	1:A:353:ASN:HD22	2.10	0.64
1:B:168:PHE:C	1:B:170:ASN:N	2.50	0.64
1:A:108:THR:HG22	5:A:1449:HOH:O	1.97	0.64
1:B:105:PHE:HB3	1:B:106:PRO:HD3	1.79	0.64
1:D:113:SER:OG	1:D:116:GLU:HG3	1.97	0.63
1:A:36[B]:ILE:HB	1:A:197:VAL:HG12	1.81	0.63
1:D:49:ARG:NH1	3:D:1222:IOD:I	3.00	0.63
1:A:201:PRO:HD3	5:A:1433:HOH:O	1.98	0.63
1:D:135:ASN:H	1:D:135:ASN:ND2	1.95	0.63
1:B:88:PHE:O	1:B:91:TRP:HD1	1.82	0.63
1:D:330:HIS:NE2	5:D:1519:HOH:O	2.30	0.63
1:A:164:LEU:HB2	1:A:196[B]:VAL:HG13	1.80	0.63
1:B:52:ALA:HB1	1:B:86:MET:HE2	1.81	0.62
1:D:94:TYR:HB3	3:D:1208:IOD:I	2.69	0.62
1:A:3[B]:ARG:HG2	1:A:5:ILE:HD11	1.81	0.62
1:D:204:ILE:HG22	1:D:205:PHE:N	2.13	0.62
1:A:247:LEU:HB3	1:A:258:ILE:HD13	1.81	0.62
1:D:298:LYS:NZ	1:D:298:LYS:CB	2.62	0.62
1:A:95:PRO:HD2	3:A:1232:IOD:I	2.69	0.62
1:A:247:LEU:HB3	1:A:258:ILE:CD1	2.29	0.61
1:A:285:LYS:CE	1:A:336:GLU:OE1	2.49	0.61
1:A:5:ILE:HD12	1:A:5:ILE:N	2.15	0.61
1:B:109:ASN:O	1:B:110:MET:HE2	2.00	0.61

*Continued on next page...*

*Continued from previous page...*

Atom-1	Atom-2	Interatomic distance (Å)	Clash overlap (Å)
1:A:36[A]:ILE:HB	1:A:197:VAL:HG12	1.81	0.61
1:B:89[B]:GLN:HG3	1:B:165:ASP:O	2.01	0.60
1:A:36[B]:ILE:HD11	1:A:47:PHE:CE2	2.37	0.60
1:D:3:ARG:NH1	1:D:29:GLU:OE2	2.34	0.60
1:B:74:LYS:HE3	5:B:1327:HOH:O	2.01	0.60
1:A:221:GLN:HE22	1:A:233:VAL:H	1.47	0.60
1:B:319:ASP:O	1:B:320:SER:O	2.19	0.60
1:B:241:ILE:HG13	1:B:241:ILE:O	2.02	0.60
1:B:88:PHE:O	1:B:91:TRP:CD1	2.56	0.59
1:D:26:ILE:HD11	1:D:34:PHE:CZ	2.38	0.59
1:B:194:LEU:HD23	1:B:194:LEU:C	2.23	0.59
1:B:122:GLU:O	1:B:126[B]:LYS:HG3	2.02	0.59
1:D:164:LEU:HB2	1:D:196[B]:VAL:HG22	1.83	0.58
1:A:108:THR:CG2	5:A:1510:HOH:O	2.52	0.58
1:D:137:PHE:HB2	1:D:140:GLU:OE2	2.04	0.58
1:A:48[B]:MET:SD	1:A:197:VAL:HG22	2.43	0.58
1:D:294:ILE:HD12	1:D:344:LYS:CB	2.33	0.58
1:A:344:LYS:NZ	1:A:345:ASP:OD2	2.37	0.58
1:A:269:SER:HB3	1:A:353:ASN:HD22	1.69	0.58
1:D:30:ASN:HD22	1:D:30:ASN:H	1.51	0.57
1:D:139:ARG:HG2	1:D:139:ARG:NH1	2.19	0.57
1:A:120[B]:ARG:HG2	1:A:120[B]:ARG:NH1	2.18	0.57
1:A:290:ASP:OD2	1:A:292:SER:OG	2.20	0.57
1:B:136:HIS:HB2	1:B:141:LEU:HD21	1.86	0.57
1:D:30:ASN:H	1:D:30:ASN:ND2	2.03	0.57
1:D:345:ASP:HB3	5:D:1550:HOH:O	2.04	0.57
1:B:122:GLU:O	1:B:126[A]:LYS:HG3	2.04	0.57
1:B:251:VAL:HG21	1:B:267:VAL:HG12	1.87	0.56
1:A:89:GLN:CG	1:A:166:GLU:HB2	2.35	0.56
1:B:93:LEU:O	1:B:94:TYR:C	2.44	0.56
1:B:194:LEU:HD21	1:B:196[B]:VAL:HG21	1.78	0.56
1:D:3:ARG:HH11	1:D:29:GLU:CD	2.08	0.56
1:B:265:VAL:HB	1:B:349:VAL:HG21	1.87	0.56
1:A:105:PHE:O	1:A:108:THR:HG23	2.06	0.56
1:B:306:TYR:O	1:B:307:GLN:HG3	2.06	0.56
1:D:6:VAL:HB	1:D:26:ILE:HG22	1.87	0.56
1:B:306:TYR:C	1:B:307:GLN:HG3	2.26	0.56
1:B:269:SER:OG	1:B:271:ARG:O	2.22	0.55
1:D:8:ASN:HD22	1:D:23:ASN:HD21	1.54	0.55
1:A:48[B]:MET:SD	1:A:197:VAL:CG2	2.94	0.55
1:B:48:MET:SD	1:B:197:VAL:HG13	2.46	0.55

*Continued on next page...*

*Continued from previous page...*

Atom-1	Atom-2	Interatomic distance (Å)	Clash overlap (Å)
1:D:216:LYS:CE	1:D:216:LYS:HA	2.37	0.55
1:D:261:LEU:HD22	1:D:317:PRO:HG3	1.88	0.55
1:B:110:MET:CE	1:B:110:MET:CA	2.84	0.55
1:B:247:LEU:HB3	1:B:258:ILE:HD13	1.89	0.55
1:B:182:LEU:O	1:B:186:VAL:HG23	2.06	0.55
1:B:205:PHE:CE1	1:B:241:ILE:HD11	2.42	0.55
1:D:72:ASN:ND2	5:D:1517:HOH:O	2.40	0.55
1:A:221:GLN:NE2	1:A:233:VAL:H	2.04	0.55
1:A:247:LEU:HD12	1:A:322:GLU:HB3	1.89	0.55
1:A:285:LYS:NZ	1:A:336:GLU:OE1	2.39	0.55
1:B:93:LEU:HD23	1:B:138:PRO:HG3	1.87	0.55
1:A:3[A]:ARG:HG2	1:A:5:ILE:HD11	1.89	0.54
1:A:211:VAL:HG13	1:A:228:LEU:HD11	1.90	0.54
1:D:164:LEU:HB2	1:D:196[B]:VAL:HG23	1.88	0.54
1:A:48[B]:MET:CE	1:A:195[B]:LEU:HG	2.37	0.54
1:A:76:ILE:HD12	1:A:76:ILE:N	2.23	0.54
1:D:14[B]:LYS:HE2	5:D:1364:HOH:O	2.07	0.54
1:D:216:LYS:HA	1:D:216:LYS:HE2	1.90	0.53
1:A:252:THR:HG22	1:A:254:GLU:N	2.22	0.53
1:D:180:ARG:HD3	1:D:206:ALA:CB	2.39	0.53
1:B:175:MET:CE	5:B:1401:HOH:O	2.46	0.53
1:D:120:ARG:HD3	5:D:1465:HOH:O	2.09	0.53
1:B:89[A]:GLN:HG2	1:B:166:GLU:HB2	1.92	0.52
1:B:89[B]:GLN:NE2	5:B:1375:HOH:O	2.35	0.52
1:D:211:VAL:CG1	1:D:228:LEU:CD1	2.86	0.52
1:A:118[A]:ARG:NH1	1:A:122:GLU:CD	2.63	0.52
1:D:139:ARG:NH1	5:D:1265:HOH:O	2.42	0.52
1:D:211:VAL:CG1	1:D:228:LEU:HD12	2.39	0.52
1:A:70:ALA:CA	1:A:76:ILE:CD1	2.75	0.52
1:B:8:ASN:HA	5:B:1457:HOH:O	2.10	0.52
1:B:211:VAL:HG11	1:B:228:LEU:CD1	2.28	0.51
1:B:165:ASP:HA	1:B:197:VAL:HG22	1.92	0.51
1:D:3:ARG:HG2	1:D:30:ASN:HD22	1.75	0.51
1:A:303:VAL:HG23	3:A:1227:IOD:I	2.81	0.51
1:B:52:ALA:HB1	1:B:86:MET:HE1	1.91	0.51
1:B:109:ASN:O	1:B:110:MET:HE3	2.11	0.51
1:D:41:GLY:H	4:D:1106:ANP:HNB1	1.57	0.51
1:B:12[B]:VAL:HG11	1:B:16:GLY:CA	2.31	0.51
1:B:36:ILE:HB	1:B:197:VAL:HG12	1.93	0.51
1:A:7[B]:LYS:HB3	1:A:7[B]:LYS:HZ2	1.73	0.51
1:D:8:ASN:ND2	1:D:23:ASN:HD21	2.09	0.51

*Continued on next page...*

*Continued from previous page...*

Atom-1	Atom-2	Interatomic distance (Å)	Clash overlap (Å)
1:D:241:ILE:O	1:D:241:ILE:HG13	2.10	0.51
1:A:108:THR:HG22	5:A:1510:HOH:O	2.11	0.50
1:D:247:LEU:HD21	1:D:323:GLU:O	2.12	0.50
1:A:108:THR:HG21	5:A:1510:HOH:O	2.11	0.50
1:A:9:VAL:HG13	1:A:57:PRO:HB3	1.94	0.50
1:B:205:PHE:HE1	1:B:241:ILE:HD11	1.78	0.49
1:D:140:GLU:CG	5:D:1422:HOH:O	2.37	0.49
1:D:298:LYS:HG2	5:D:1375:HOH:O	2.11	0.49
1:A:224:LYS:HE2	1:A:227:ASP:OD1	2.12	0.49
3:B:1221:IOD:I	5:B:1341:HOH:O	2.90	0.49
1:B:48:MET:CG	1:B:197:VAL:HG11	2.42	0.49
1:D:352:LYS:CG	1:D:353:ASN:N	2.32	0.49
1:A:252:THR:HG23	1:A:254:GLU:H	1.73	0.49
1:B:170:ASN:O	1:B:171:LEU:O	2.30	0.49
1:D:105:PHE:HB3	1:D:106:PRO:HD3	1.95	0.49
1:A:48[B]:MET:HE1	1:A:195[B]:LEU:HG	1.94	0.48
1:A:252:THR:HG23	1:A:253:ASN:N	2.28	0.48
1:D:130:ILE:HD12	1:D:149:VAL:HG22	1.95	0.48
1:B:288:ILE:HG22	1:B:290:ASP:H	1.78	0.48
1:D:267:VAL:HG21	1:D:272:ALA:HB2	1.93	0.48
1:B:80:GLU:H	1:B:80:GLU:HG3	1.35	0.48
1:B:109:ASN:C	1:B:110:MET:HE3	2.34	0.48
1:D:243:GLU:OE2	5:D:1300:HOH:O	2.20	0.48
1:D:78:PRO:HB2	1:D:80:GLU:OE1	2.13	0.48
1:A:41:GLY:H	4:A:1104:ANP:HNB1	1.61	0.48
1:B:5[A]:ILE:HB	1:B:63:TYR:HB2	1.96	0.48
1:B:5[B]:ILE:HB	1:B:63:TYR:HB2	1.96	0.48
1:B:127:ILE:HD13	5:B:1442:HOH:O	2.15	0.47
1:A:252:THR:HB	1:A:255:GLY:O	2.15	0.47
3:B:1223:IOD:I	5:B:1295:HOH:O	2.91	0.47
1:D:79:PRO:HD2	1:D:80:GLU:OE1	2.14	0.47
1:A:300:LYS:HE3	1:A:335:GLY:HA2	1.95	0.47
1:B:41:GLY:H	4:B:1105:ANP:HNB1	1.61	0.47
1:D:5:ILE:HG23	1:D:27:ASN:OD1	2.14	0.47
1:B:128:LEU:HD12	1:B:152:ALA:HB2	1.97	0.46
1:D:307:GLN:NE2	1:D:312:ARG:HD2	2.30	0.46
1:A:124[A]:VAL:CG1	1:A:152:ALA:HB1	2.45	0.46
1:B:194:LEU:CD2	1:B:196[B]:VAL:HG22	2.30	0.46
1:D:263:PHE:HA	1:D:264:PRO:HD3	1.73	0.46
1:A:3[B]:ARG:NE	5:A:1424:HOH:O	2.26	0.46
1:D:8:ASN:HB3	5:D:1513:HOH:O	2.16	0.46

*Continued on next page...*



*Continued from previous page...*

Atom-1	Atom-2	Interatomic distance (Å)	Clash overlap (Å)
1:B:12[B]:VAL:CG1	1:B:16:GLY:CA	2.91	0.45
1:B:303:VAL:HG22	1:B:304:ILE:N	2.31	0.45
1:A:285:LYS:HE2	1:A:336:GLU:OE1	2.17	0.45
1:D:3:ARG:CG	1:D:30:ASN:HD22	2.30	0.45
1:D:8:ASN:ND2	5:D:1354:HOH:O	2.49	0.45
1:B:290:ASP:OD1	1:B:292:SER:N	2.40	0.45
1:D:352:LYS:HE2	1:D:353:ASN:O	2.17	0.45
1:A:304:ILE:HD11	1:A:311:PHE:CD2	2.53	0.44
1:D:307:GLN:HE22	1:D:312:ARG:HD2	1.83	0.44
1:A:269:SER:HB2	1:A:353:ASN:HD22	1.82	0.44
1:A:303:VAL:HG22	1:A:304:ILE:N	2.33	0.44
1:B:48:MET:SD	1:B:197:VAL:CG1	3.05	0.44
1:A:151[B]:LEU:HD13	3:A:1206:IOD:I	2.87	0.44
1:D:211:VAL:HG11	1:D:228:LEU:HD12	2.00	0.44
1:D:3:ARG:CD	1:D:30:ASN:HD22	2.31	0.43
1:D:252:THR:O	1:D:252:THR:OG1	2.29	0.43
1:D:5:ILE:HG22	1:D:7[B]:LYS:HG3	1.99	0.43
1:D:53:GLY:O	1:D:79:PRO:HG3	2.19	0.43
1:D:298:LYS:NZ	1:D:298:LYS:HB3	2.32	0.43
1:D:26:ILE:HG13	1:D:27:ASN:N	2.34	0.43
1:D:216:LYS:HE2	1:D:216:LYS:CA	2.48	0.43
1:A:83:LYS:HB2	3:A:1217:IOD:I	2.89	0.43
1:A:211:VAL:HG13	1:A:228:LEU:CD1	2.48	0.43
1:A:246:GLU:O	1:A:247:LEU:HD13	2.19	0.43
1:A:70:ALA:C	1:A:76:ILE:HD13	2.39	0.43
1:D:345:ASP:OD2	1:D:345:ASP:N	2.51	0.43
1:B:137:PHE:O	1:B:140:GLU:N	2.52	0.43
1:A:204:ILE:N	1:A:204:ILE:HD12	2.34	0.42
1:A:276:ILE:HG23	1:A:276:ILE:O	2.19	0.42
1:B:47:PHE:HE2	1:B:195:LEU:HD11	1.84	0.42
1:D:14[A]:LYS:HD3	5:D:1328:HOH:O	2.18	0.42
1:D:276:ILE:HG23	1:D:276:ILE:O	2.19	0.42
1:D:290:ASP:OD1	1:D:292:SER:OG	2.36	0.42
1:B:127:ILE:CG2	5:B:1290:HOH:O	2.57	0.42
1:D:95:PRO:HD2	3:D:1208:IOD:I	2.90	0.42
1:D:271:ARG:HB3	1:D:352:LYS:HB3	2.02	0.42
1:A:269:SER:OG	1:A:271:ARG:O	2.27	0.42
1:A:298:LYS:NZ	5:A:1459:HOH:O	2.51	0.42
1:B:10:SER:HB2	1:B:59:THR:OG1	2.20	0.42
1:B:138:PRO:HA	1:B:141:LEU:HD12	2.02	0.42
1:B:87:VAL:HB	1:B:164:LEU:CD2	2.49	0.42

*Continued on next page...*

*Continued from previous page...*

Atom-1	Atom-2	Interatomic distance (Å)	Clash overlap (Å)
1:B:296:VAL:HG22	1:B:340:VAL:O	2.20	0.42
1:D:301:VAL:HA	1:D:315:ILE:HG22	2.00	0.42
1:A:10:SER:HB2	1:A:59:THR:OG1	2.20	0.42
1:B:330:HIS:HA	1:B:331:PRO:HD3	1.92	0.42
1:A:252:THR:CG2	1:A:253:ASN:N	2.81	0.42
1:D:89:GLN:HB2	5:D:1426:HOH:O	2.20	0.42
1:A:36[B]:ILE:CD1	1:A:47:PHE:CE2	3.02	0.41
1:A:70:ALA:N	1:A:76:ILE:HD13	2.34	0.41
1:D:8:ASN:HD22	1:D:23:ASN:ND2	2.18	0.41
1:D:165:ASP:HA	1:D:197:VAL:HG22	2.01	0.41
1:D:126:LYS:HD2	5:D:1401:HOH:O	2.20	0.41
1:A:3[B]:ARG:HH11	1:A:29:GLU:CD	2.22	0.41
1:A:94:TYR:HA	1:A:95:PRO:HD3	1.88	0.41
1:A:181:ALA:O	1:A:185[A]:GLU:HG3	2.21	0.41
1:D:164:LEU:HB2	1:D:196[A]:VAL:HG23	2.01	0.41
1:D:313:ILE:O	1:D:325:PHE:HA	2.21	0.41
1:A:221:GLN:HE22	1:A:233:VAL:N	2.17	0.41
1:B:139:ARG:CG	1:B:140:GLU:N	2.84	0.41
1:D:267:VAL:HG22	1:D:272:ALA:HB2	2.00	0.41
1:D:168:PHE:HE1	1:D:207:ILE:CD1	2.34	0.41
1:B:142:SER:O	1:B:143:GLY:C	2.59	0.41
1:D:59:THR:HA	1:D:72:ASN:HD22	1.85	0.41
1:D:298:LYS:HZ2	1:D:298:LYS:CB	2.20	0.41
1:A:128:LEU:O	1:A:148:ARG:HD3	2.21	0.40
1:B:89[A]:GLN:CG	1:B:166:GLU:HB2	2.51	0.40
1:B:93:LEU:HD23	1:B:138:PRO:HB3	2.03	0.40
1:B:328:SER:HB2	3:B:1211:IOD:I	2.91	0.40
1:D:247:LEU:HD11	1:D:324:ILE:HD11	2.03	0.40
1:B:39:PRO:HG3	1:B:240:LEU:HD21	2.02	0.40
1:B:94:TYR:HA	1:B:95:PRO:HD3	1.75	0.40
1:D:83:LYS:CE	5:D:1534:HOH:O	2.62	0.40
1:A:48[B]:MET:HE1	1:A:197:VAL:HG13	2.03	0.40
1:A:200:ASP:HA	1:A:201:PRO:HD2	1.94	0.40
1:B:247:LEU:HD11	1:B:323:GLU:O	2.22	0.40
1:B:271:ARG:HB2	1:B:352:LYS:HB3	2.03	0.40
1:A:5:ILE:N	1:A:5:ILE:CD1	2.83	0.40
1:A:26:ILE:CD1	3:A:1202:IOD:I	3.27	0.40
1:A:166:GLU:N	1:A:167:PRO:HD3	2.36	0.40
1:D:96:ASN:OD1	1:D:96:ASN:C	2.53	0.40

All (6) symmetry-related close contacts are listed below. The label for Atom-2 includes the symmetry operator and encoded unit-cell translations to be applied.

Atom-1	Atom-2	Interatomic distance (Å)	Clash overlap (Å)
3:A:1228:IOD:I	5:A:1497:HOH:O[1_455]	1.01	1.19
1:B:7:LYS:NZ	1:D:96:ASN:OD1[1_565]	1.86	0.34
1:B:8:ASN:ND2	1:D:96:ASN:ND2[1_565]	1.93	0.27
5:A:1446:HOH:O	5:A:1497:HOH:O[1_455]	2.02	0.18
1:A:282[B]:LYS:NZ	5:A:1492:HOH:O[1_455]	2.09	0.11
5:A:1383:HOH:O	5:D:1310:HOH:O[4_456]	2.17	0.03

## 5.3 Torsion angles [i](#)

### 5.3.1 Protein backbone [i](#)

In the following table, the Percentiles column shows the percent Ramachandran outliers of the chain as a percentile score with respect to all X-ray entries followed by that with respect to entries of similar resolution.

The Analysed column shows the number of residues for which the backbone conformation was analysed, and the total number of residues.

Mol	Chain	Analysed	Favoured	Allowed	Outliers	Percentiles	
1	A	368/353 (104%)	358 (97%)	8 (2%)	2 (0%)	29	17
1	B	362/353 (102%)	346 (96%)	10 (3%)	6 (2%)	9	2
1	D	359/353 (102%)	350 (98%)	6 (2%)	3 (1%)	19	9
All	All	1089/1059 (103%)	1054 (97%)	24 (2%)	11 (1%)	15	6

All (11) Ramachandran outliers are listed below:

Mol	Chain	Res	Type
1	B	171	LEU
1	B	320	SER
1	D	253	ASN
1	A	173	ALA
1	B	169	SER
1	D	173	ALA
1	A	267	VAL
1	B	91	TRP
1	B	172	ASP
1	B	93	LEU
1	D	268	SER

### 5.3.2 Protein sidechains

In the following table, the Percentiles column shows the percent sidechain outliers of the chain as a percentile score with respect to all X-ray entries followed by that with respect to entries of similar resolution.

The Analysed column shows the number of residues for which the sidechain conformation was analysed, and the total number of residues.

Mol	Chain	Analysed	Rotameric	Outliers	Percentiles	
1	A	296/307 (96%)	283 (96%)	13 (4%)	28	15
1	B	288/307 (94%)	281 (98%)	7 (2%)	49	40
1	D	290/307 (94%)	283 (98%)	7 (2%)	49	40
All	All	874/921 (95%)	847 (97%)	27 (3%)	42	28

All (27) residues with a non-rotameric sidechain are listed below:

Mol	Chain	Res	Type
1	A	89	GLN
1	A	124[A]	VAL
1	A	124[B]	VAL
1	A	136	HIS
1	A	186[A]	VAL
1	A	186[B]	VAL
1	A	196[A]	VAL
1	A	196[B]	VAL
1	A	252	THR
1	A	267	VAL
1	A	268	SER
1	A	286	ASP
1	A	304	ILE
1	B	30	ASN
1	B	80	GLU
1	B	195	LEU
1	B	204	ILE
1	B	243	GLU
1	B	307	GLN
1	B	323	GLU
1	D	30	ASN
1	D	135	ASN
1	D	140	GLU
1	D	195	LEU
1	D	261	LEU
1	D	271	ARG

*Continued on next page...*

*Continued from previous page...*

Mol	Chain	Res	Type
1	D	298	LYS

Sometimes sidechains can be flipped to improve hydrogen bonding and reduce clashes. All (16) such sidechains are listed below:

Mol	Chain	Res	Type
1	A	146	GLN
1	A	199	HIS
1	A	221	GLN
1	A	353	ASN
1	B	136	HIS
1	B	307	GLN
1	B	353	ASN
1	D	8	ASN
1	D	23	ASN
1	D	30	ASN
1	D	72	ASN
1	D	96	ASN
1	D	135	ASN
1	D	146	GLN
1	D	199	HIS
1	D	307	GLN

### 5.3.3 RNA [i](#)

There are no RNA molecules in this entry.

### 5.4 Non-standard residues in protein, DNA, RNA chains [i](#)

There are no non-standard protein/DNA/RNA residues in this entry.

### 5.5 Carbohydrates [i](#)

There are no monosaccharides in this entry.

### 5.6 Ligand geometry [i](#)

Of 44 ligands modelled in this entry, 41 are monoatomic - leaving 3 for Mogul analysis.

In the following table, the Counts columns list the number of bonds (or angles) for which Mogul statistics could be retrieved, the number of bonds (or angles) that are observed in the model and the number of bonds (or angles) that are defined in the Chemical Component Dictionary. The Link column lists molecule types, if any, to which the group is linked. The Z score for a bond length (or angle) is the number of standard deviations the observed value is removed from the expected value. A bond length (or angle) with  $|Z| > 2$  is considered an outlier worth inspection. RMSZ is the root-mean-square of all Z scores of the bond lengths (or angles).

Mol	Type	Chain	Res	Link	Bond lengths			Bond angles		
					Counts	RMSZ	# $ Z  > 2$	Counts	RMSZ	# $ Z  > 2$
4	ANP	B	1105	2	29,33,33	1.63	5 (17%)	31,52,52	1.34	4 (12%)
4	ANP	A	1104	2	29,33,33	1.55	6 (20%)	31,52,52	1.40	3 (9%)
4	ANP	D	1106	2	29,33,33	1.54	7 (24%)	31,52,52	1.39	3 (9%)

In the following table, the Chirals column lists the number of chiral outliers, the number of chiral centers analysed, the number of these observed in the model and the number defined in the Chemical Component Dictionary. Similar counts are reported in the Torsion and Rings columns. '-' means no outliers of that kind were identified.

Mol	Type	Chain	Res	Link	Chirals	Torsions	Rings
4	ANP	B	1105	2	-	4/14/38/38	0/3/3/3
4	ANP	A	1104	2	-	4/14/38/38	0/3/3/3
4	ANP	D	1106	2	-	4/14/38/38	0/3/3/3

All (18) bond length outliers are listed below:

Mol	Chain	Res	Type	Atoms	Z	Observed(Å)	Ideal(Å)
4	B	1105	ANP	PB-O3A	-4.80	1.53	1.59
4	D	1106	ANP	PB-O3A	-3.74	1.54	1.59
4	A	1104	ANP	PG-O3G	-3.22	1.48	1.56
4	A	1104	ANP	PB-O2B	-2.89	1.49	1.56
4	D	1106	ANP	PG-O3G	-2.69	1.49	1.56
4	B	1105	ANP	PG-O3G	-2.50	1.50	1.56
4	A	1104	ANP	PG-O1G	2.43	1.50	1.46
4	D	1106	ANP	PG-O1G	2.38	1.49	1.46
4	B	1105	ANP	PG-O1G	2.38	1.49	1.46
4	D	1106	ANP	PB-O2B	-2.29	1.50	1.56
4	A	1104	ANP	PG-O2G	-2.26	1.50	1.56
4	D	1106	ANP	C5-C4	2.21	1.46	1.40
4	D	1106	ANP	PG-O2G	-2.20	1.50	1.56
4	A	1104	ANP	C5-C4	2.18	1.46	1.40
4	B	1105	ANP	C5-C4	2.17	1.46	1.40
4	A	1104	ANP	PB-O3A	-2.17	1.56	1.59

*Continued on next page...*

Continued from previous page...

Mol	Chain	Res	Type	Atoms	Z	Observed(Å)	Ideal(Å)
4	B	1105	ANP	PG-O2G	-2.14	1.51	1.56
4	D	1106	ANP	C2-N3	2.03	1.35	1.32

All (10) bond angle outliers are listed below:

Mol	Chain	Res	Type	Atoms	Z	Observed(°)	Ideal(°)
4	A	1104	ANP	N3-C2-N1	-4.09	122.29	128.68
4	D	1106	ANP	N3-C2-N1	-3.80	122.74	128.68
4	B	1105	ANP	N3-C2-N1	-3.55	123.12	128.68
4	B	1105	ANP	O2B-PB-O3A	2.80	114.00	104.64
4	A	1104	ANP	O2B-PB-O3A	2.78	113.91	104.64
4	B	1105	ANP	C4-C5-N7	-2.64	106.65	109.40
4	A	1104	ANP	C2-N1-C6	2.46	122.96	118.75
4	D	1106	ANP	O2B-PB-O3A	2.39	112.61	104.64
4	D	1106	ANP	C2-N1-C6	2.25	122.60	118.75
4	B	1105	ANP	C2-N1-C6	2.02	122.21	118.75

There are no chirality outliers.

All (12) torsion outliers are listed below:

Mol	Chain	Res	Type	Atoms
4	A	1104	ANP	PB-N3B-PG-O1G
4	A	1104	ANP	PG-N3B-PB-O1B
4	A	1104	ANP	PA-O3A-PB-O1B
4	A	1104	ANP	PA-O3A-PB-O2B
4	B	1105	ANP	PB-N3B-PG-O1G
4	B	1105	ANP	PG-N3B-PB-O1B
4	B	1105	ANP	PA-O3A-PB-O1B
4	B	1105	ANP	PA-O3A-PB-O2B
4	D	1106	ANP	PB-N3B-PG-O1G
4	D	1106	ANP	PG-N3B-PB-O1B
4	D	1106	ANP	PA-O3A-PB-O1B
4	D	1106	ANP	PA-O3A-PB-O2B

There are no ring outliers.

3 monomers are involved in 3 short contacts:

Mol	Chain	Res	Type	Clashes	Symm-Clashes
4	B	1105	ANP	1	0
4	A	1104	ANP	1	0
4	D	1106	ANP	1	0

The following is a two-dimensional graphical depiction of Mogul quality analysis of bond lengths, bond angles, torsion angles, and ring geometry for all instances of the Ligand of Interest. In addition, ligands with molecular weight > 250 and outliers as shown on the validation Tables will also be included. For torsion angles, if less than 5% of the Mogul distribution of torsion angles is within 10 degrees of the torsion angle in question, then that torsion angle is considered an outlier. Any bond that is central to one or more torsion angles identified as an outlier by Mogul will be highlighted in the graph. For rings, the root-mean-square deviation (RMSD) between the ring in question and similar rings identified by Mogul is calculated over all ring torsion angles. If the average RMSD is greater than 60 degrees and the minimal RMSD between the ring in question and any Mogul-identified rings is also greater than 60 degrees, then that ring is considered an outlier. The outliers are highlighted in purple. The color gray indicates Mogul did not find sufficient equivalents in the CSD to analyse the geometry.

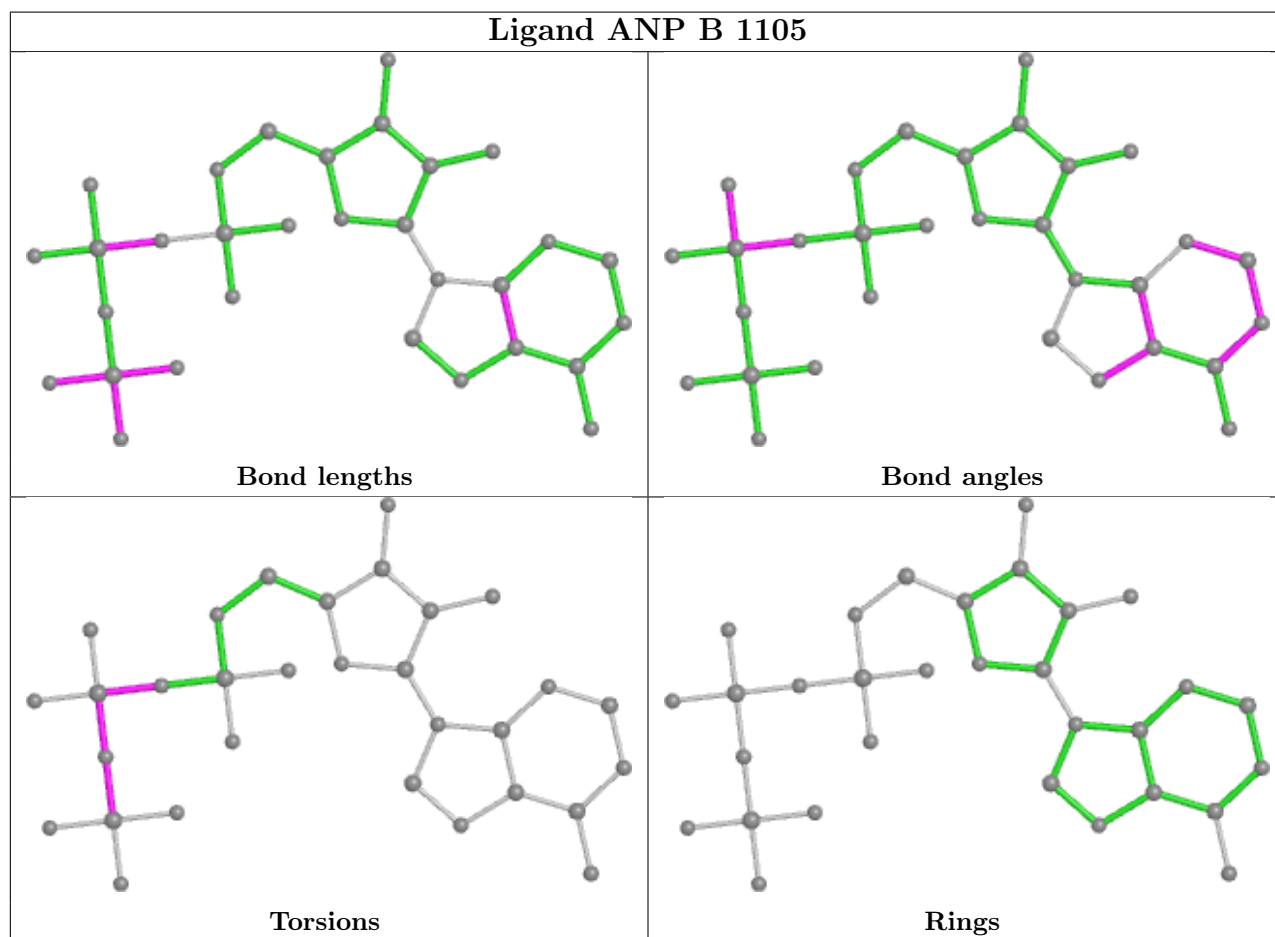



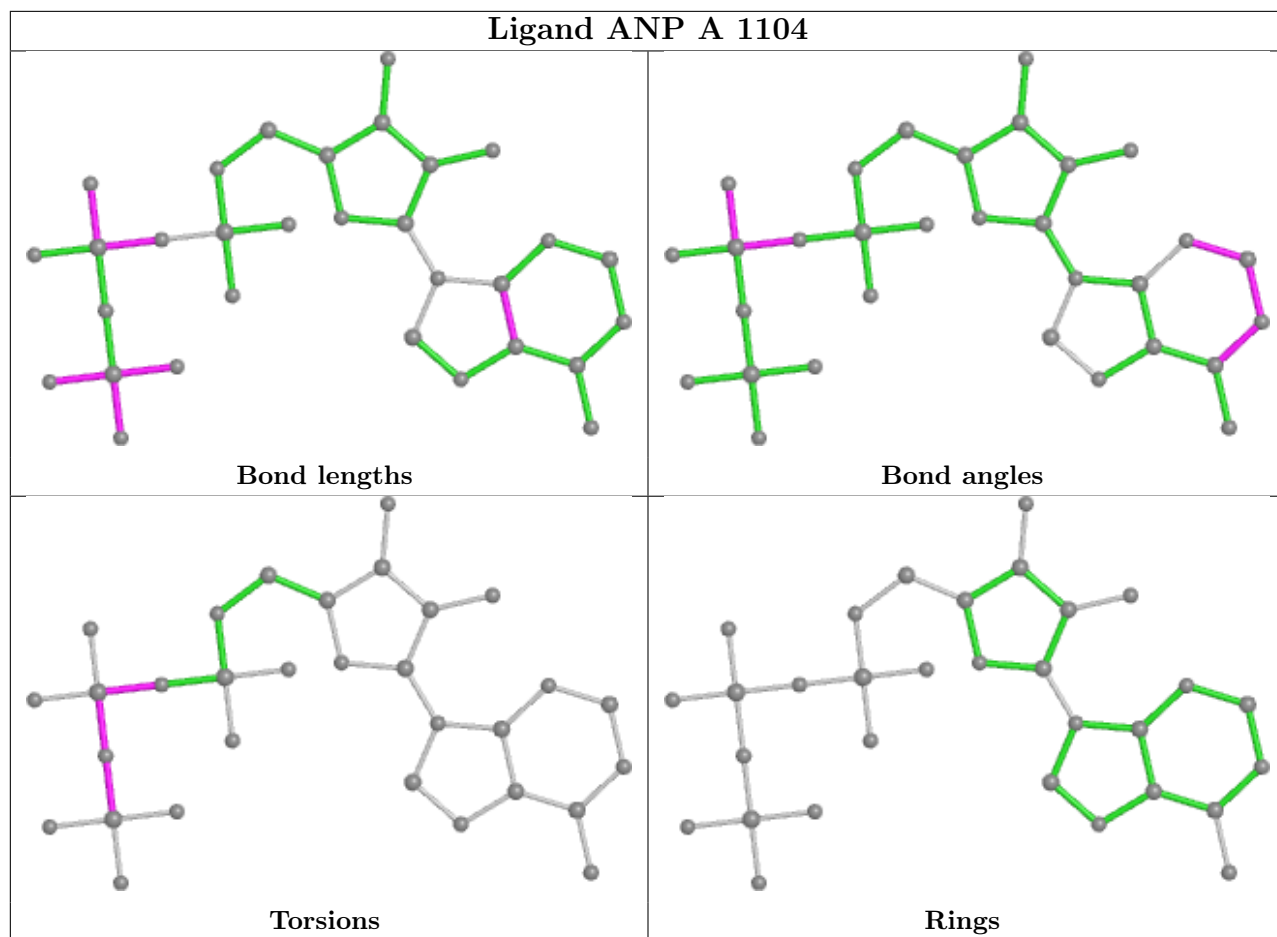

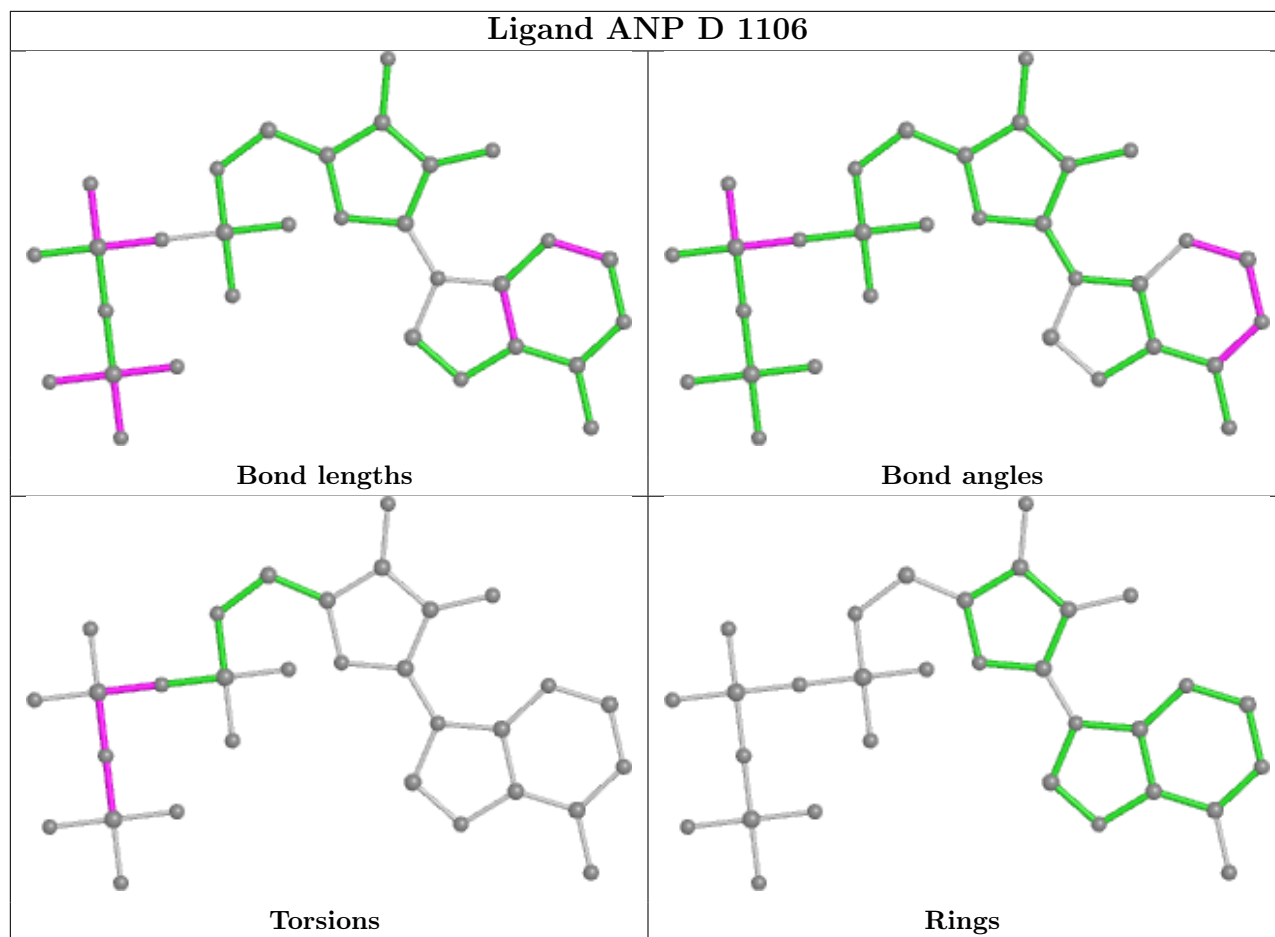

## 5.7 Other polymers [i](#)

There are no such residues in this entry.

## 5.8 Polymer linkage issues [i](#)

The following chains have linkage breaks:

Mol	Chain	Number of breaks
1	A	1

All chain breaks are listed below:

Model	Chain	Residue-1	Atom-1	Residue-2	Atom-2	Distance (Å)
1	A	282:LYS	C	283:LEU	N	1.09

## 6 Fit of model and data

### 6.1 Protein, DNA and RNA chains

In the following table, the column labelled ‘#RSRZ > 2’ contains the number (and percentage) of RSRZ outliers, followed by percent RSRZ outliers for the chain as percentile scores relative to all X-ray entries and entries of similar resolution. The OWAB column contains the minimum, median, 95<sup>th</sup> percentile and maximum values of the occupancy-weighted average B-factor per residue. The column labelled ‘Q < 0.9’ lists the number of (and percentage) of residues with an average occupancy less than 0.9.

Mol	Chain	Analysed	<RSRZ>	#RSRZ>2	OWAB(Å <sup>2</sup> )	Q<0.9
1	A	353/353 (100%)	0.34	24 (6%) 17 25	10, 20, 36, 71	0
1	B	353/353 (100%)	0.52	38 (10%) 5 9	8, 19, 38, 56	0
1	D	353/353 (100%)	0.31	22 (6%) 20 29	7, 20, 37, 76	0
All	All	1059/1059 (100%)	0.39	84 (7%) 12 19	7, 20, 37, 76	0

All (84) RSRZ outliers are listed below:

Mol	Chain	Res	Type	RSRZ
1	D	170	ASN	6.6
1	B	173	ALA	6.4
1	A	170	ASN	5.7
1	D	353	ASN	5.6
1	B	253	ASN	5.5
1	D	267	VAL	5.0
1	B	92	ALA	4.9
1	B	254	GLU	4.5
1	A	353	ASN	4.3
1	D	171	LEU	4.0
1	B	320	SER	4.0
1	B	171	LEU	4.0
1	B	95	PRO	3.8
1	B	176	ARG	3.8
1	D	175[A]	MET	3.7
1	A	267	VAL	3.6
1	B	353	ASN	3.6
1	A	169	SER	3.6
1	A	171	LEU	3.6
1	B	93	LEU	3.4
1	A	175	MET	3.4
1	D	268	SER	3.4
1	A	90	THR	3.4

*Continued on next page...*

*Continued from previous page...*

<b>Mol</b>	<b>Chain</b>	<b>Res</b>	<b>Type</b>	<b>RSRZ</b>
1	B	143	GLY	3.4
1	B	169	SER	3.4
1	D	173	ALA	3.4
1	A	199	HIS	3.3
1	B	252	THR	3.3
1	D	103	ILE	3.3
1	B	94	TYR	3.3
1	D	90	THR	3.2
1	D	308	GLY	3.2
1	B	268	SER	3.2
1	A	321	GLU	3.1
1	A	108	THR	3.1
1	B	90	THR	3.1
1	A	253	ASN	3.0
1	D	319	ASP	3.0
1	B	319	ASP	3.0
1	A	103	ILE	2.9
1	A	270	ASP	2.9
1	A	37	LEU	2.9
1	B	267	VAL	2.8
1	A	319	ASP	2.8
1	D	254	GLU	2.8
1	B	307	GLN	2.7
1	D	252	THR	2.7
1	A	89	GLN	2.6
1	B	196[A]	VAL	2.6
1	D	321	GLU	2.6
1	D	271	ARG	2.6
1	B	91	TRP	2.6
1	D	174	ARG	2.6
1	B	255	GLY	2.6
1	B	170	ASN	2.5
1	B	144	GLY	2.5
1	B	89[A]	GLN	2.5
1	B	204	ILE	2.5
1	B	256	VAL	2.5
1	B	352	LYS	2.4
1	D	344	LYS	2.4
1	B	174	ARG	2.4
1	D	96	ASN	2.4
1	A	91	TRP	2.3
1	B	308	GLY	2.3

*Continued on next page...*

*Continued from previous page...*

Mol	Chain	Res	Type	RSRZ
1	B	172	ASP	2.3
1	A	273	ILE	2.2
1	B	199	HIS	2.2
1	B	103	ILE	2.2
1	A	88	PHE	2.2
1	A	255	GLY	2.2
1	B	175	MET	2.1
1	A	204	ILE	2.1
1	B	288	ILE	2.1
1	A	151[A]	LEU	2.1
1	B	263	PHE	2.1
1	D	169	SER	2.1
1	D	307	GLN	2.1
1	D	269	SER	2.1
1	B	274	ILE	2.1
1	B	318	LEU	2.1
1	D	204	ILE	2.0
1	A	308	GLY	2.0
1	A	268	SER	2.0

## 6.2 Non-standard residues in protein, DNA, RNA chains [i](#)

There are no non-standard protein/DNA/RNA residues in this entry.

## 6.3 Carbohydrates [i](#)

There are no monosaccharides in this entry.

## 6.4 Ligands [i](#)

In the following table, the Atoms column lists the number of modelled atoms in the group and the number defined in the chemical component dictionary. The B-factors column lists the minimum, median, 95<sup>th</sup> percentile and maximum values of B factors of atoms in the group. The column labelled 'Q< 0.9' lists the number of atoms with occupancy less than 0.9.

Mol	Type	Chain	Res	Atoms	RSCC	RSR	B-factors(Å <sup>2</sup> )	Q<0.9
3	IOD	D	1234	1/1	0.87	0.07	57,57,57,57	1
3	IOD	B	1226	1/1	0.89	0.17	67,67,67,67	1
3	IOD	B	1220	1/1	0.91	0.08	42,42,42,42	1
3	IOD	A	1237	1/1	0.92	0.08	50,50,50,50	1

*Continued on next page...*

*Continued from previous page...*

Mol	Type	Chain	Res	Atoms	RSCC	RSR	B-factors( $\text{\AA}^2$ )	Q<0.9
3	IOD	A	1232	1/1	0.93	0.13	46,46,46,46	1
3	IOD	B	1223	1/1	0.93	0.06	45,45,45,45	1
3	IOD	A	1229	1/1	0.93	0.09	46,46,46,46	1
3	IOD	D	1209	1/1	0.93	0.06	46,46,46,46	1
3	IOD	A	1238	1/1	0.93	0.10	57,57,57,57	1
3	IOD	A	1228	1/1	0.94	0.13	47,47,47,47	1
3	IOD	B	1225	1/1	0.95	0.10	61,61,61,61	1
3	IOD	D	1213	1/1	0.96	0.09	41,41,41,41	1
3	IOD	D	1222	1/1	0.96	0.07	54,54,54,54	1
3	IOD	A	1219	1/1	0.96	0.10	34,34,34,34	1
3	IOD	B	1224	1/1	0.97	0.05	43,43,43,43	1
3	IOD	A	1230	1/1	0.97	0.06	42,42,42,42	1
3	IOD	A	1217	1/1	0.97	0.04	37,37,37,37	1
3	IOD	D	1233	1/1	0.97	0.17	60,60,60,60	1
3	IOD	B	1235	1/1	0.97	0.10	60,60,60,60	1
3	IOD	A	1206	1/1	0.98	0.05	41,41,41,41	1
2	MG	A	1102	1/1	0.98	0.04	25,25,25,25	0
3	IOD	A	1218	1/1	0.98	0.07	44,44,44,44	1
2	MG	B	1103	1/1	0.98	0.03	33,33,33,33	0
3	IOD	A	1227	1/1	0.98	0.10	48,48,48,48	1
3	IOD	D	1208	1/1	0.98	0.04	48,48,48,48	1
3	IOD	B	1207	1/1	0.98	0.04	33,33,33,33	1
3	IOD	B	1210	1/1	0.98	0.03	48,48,48,48	1
3	IOD	D	1214	1/1	0.98	0.06	40,40,40,40	1
3	IOD	B	1212	1/1	0.98	0.13	36,36,36,36	1
2	MG	D	1101	1/1	0.98	0.07	25,25,25,25	0
3	IOD	B	1221	1/1	0.98	0.06	50,50,50,50	1
4	ANP	B	1105	31/31	0.98	0.10	24,34,45,48	0
4	ANP	D	1106	31/31	0.98	0.07	18,26,35,38	0
3	IOD	A	1201	1/1	0.99	0.03	31,31,31,31	1
3	IOD	A	1216	1/1	0.99	0.03	35,35,35,35	1
3	IOD	B	1211	1/1	0.99	0.08	28,28,28,28	1
3	IOD	D	1215	1/1	0.99	0.03	29,29,29,29	1
3	IOD	B	1236	1/1	0.99	0.14	58,58,58,58	1
3	IOD	D	1203	1/1	0.99	0.04	34,34,34,34	1
3	IOD	D	1204	1/1	0.99	0.05	36,36,36,36	1
4	ANP	A	1104	31/31	0.99	0.08	18,26,38,38	0
3	IOD	D	1205	1/1	0.99	0.05	42,42,42,42	1
3	IOD	A	1202	1/1	0.99	0.05	40,40,40,40	1
3	IOD	A	1231	1/1	1.00	0.02	42,42,42,42	1

The following is a graphical depiction of the model fit to experimental electron density of all instances of the Ligand of Interest. In addition, ligands with molecular weight > 250 and outliers

as shown on the geometry validation Tables will also be included. Each fit is shown from different orientation to approximate a three-dimensional view.

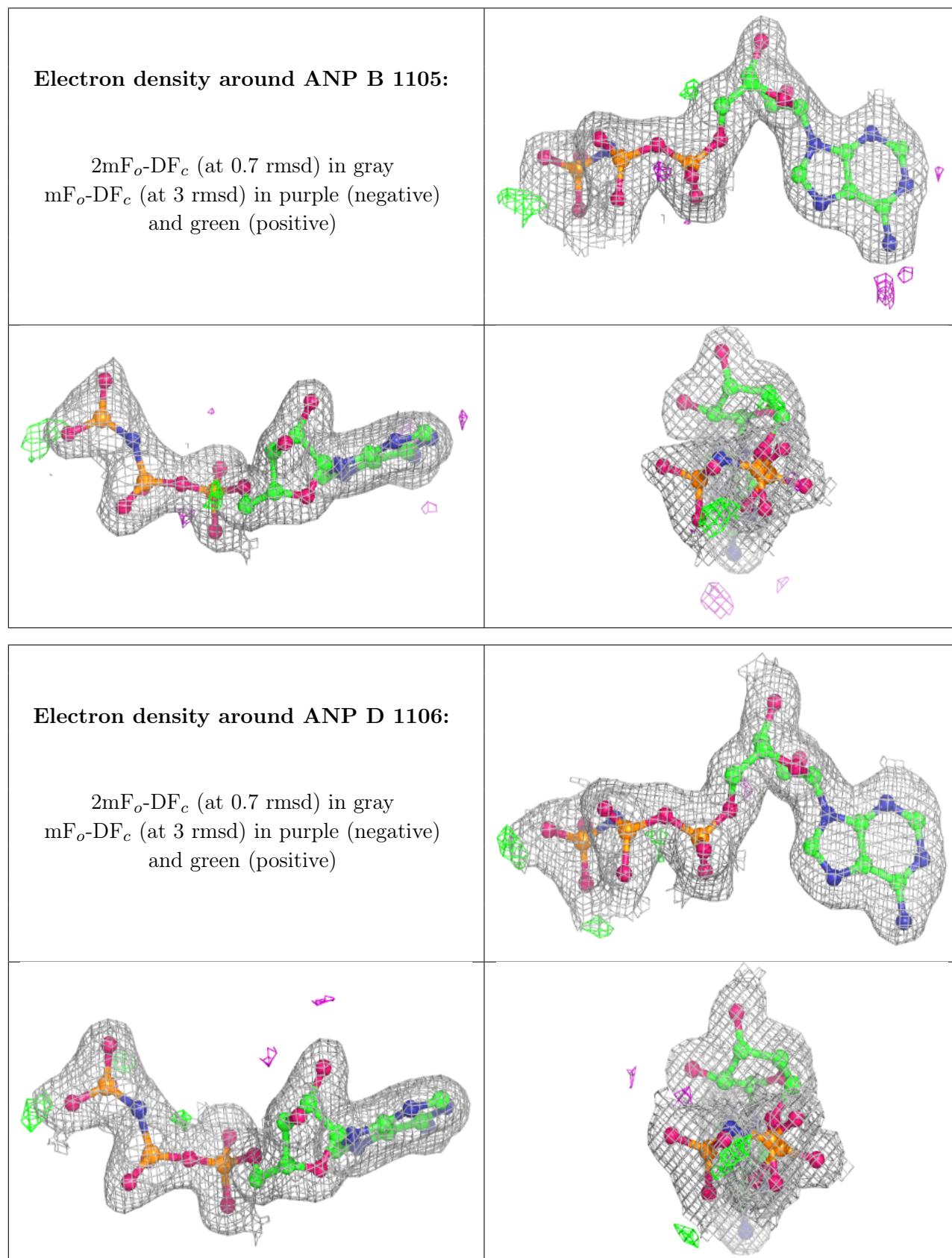

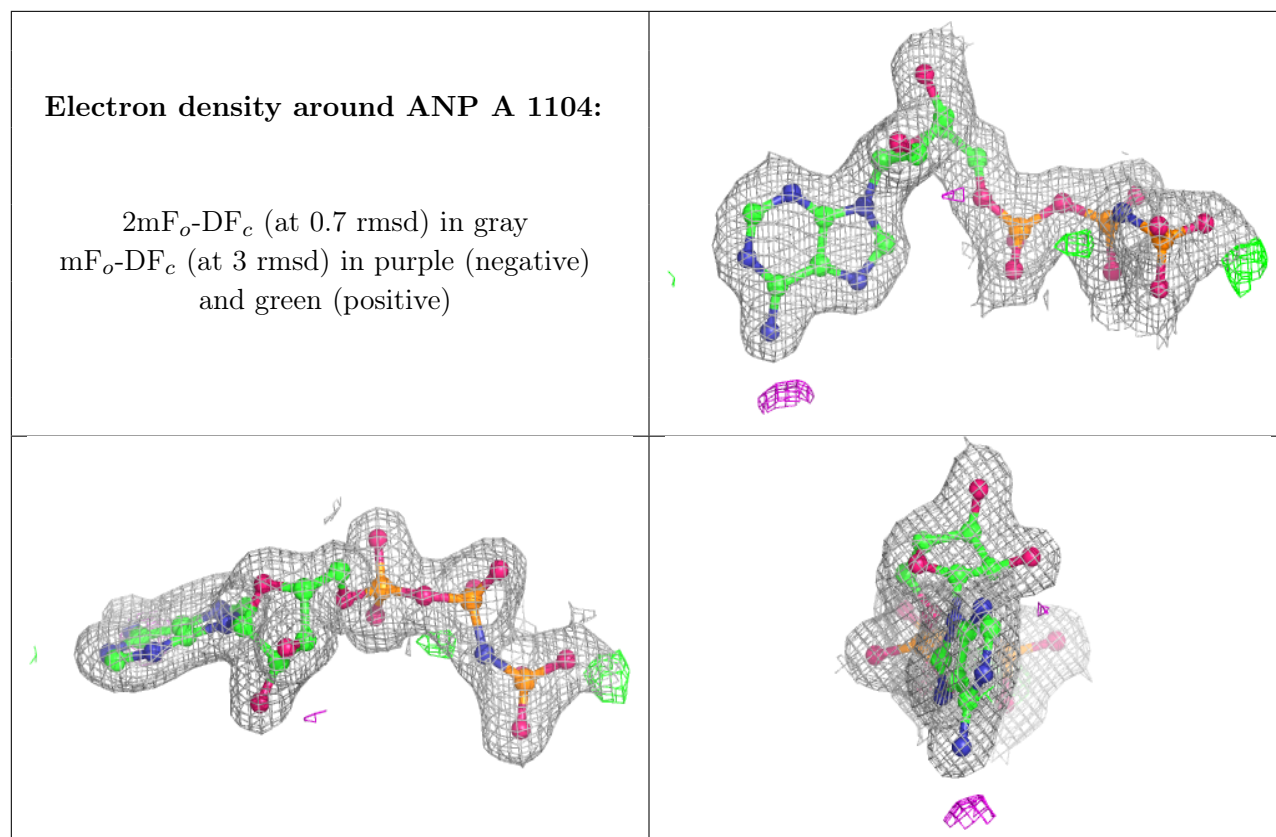

## 6.5 Other polymers [i](#)

There are no such residues in this entry.