



wwPDB EM Validation Summary Report ⓘ

Oct 14, 2021 – 09:45 am BST

PDB ID : 7OZO
EMDB ID : EMD-13130
Title : RNA Polymerase II dimer (Class 2)
Authors : Aibara, S.; Dienemann, C.; Cramer, P.
Deposited on : 2021-06-28
Resolution : 3.80 Å(reported)

This is a wwPDB EM Validation Summary Report for a publicly released PDB entry.

We welcome your comments at validation@mail.wwpdb.org

A user guide is available at

<https://www.wwpdb.org/validation/2017/EMValidationReportHelp>

with specific help available everywhere you see the ⓘ symbol.

The following versions of software and data (see [references ⓘ](#)) were used in the production of this report:

EMDB validation analysis : 0.0.0.dev97
MolProbity : 4.02b-467
Percentile statistics : 20191225.v01 (using entries in the PDB archive December 25th 2019)
Ideal geometry (proteins) : Engh & Huber (2001)
Ideal geometry (DNA, RNA) : Parkinson et al. (1996)
Validation Pipeline (wwPDB-VP) : 2.23.2

1 Overall quality at a glance

The following experimental techniques were used to determine the structure:

ELECTRON MICROSCOPY

The reported resolution of this entry is 3.80 Å.

Percentile scores (ranging between 0-100) for global validation metrics of the entry are shown in the following graphic. The table shows the number of entries on which the scores are based.

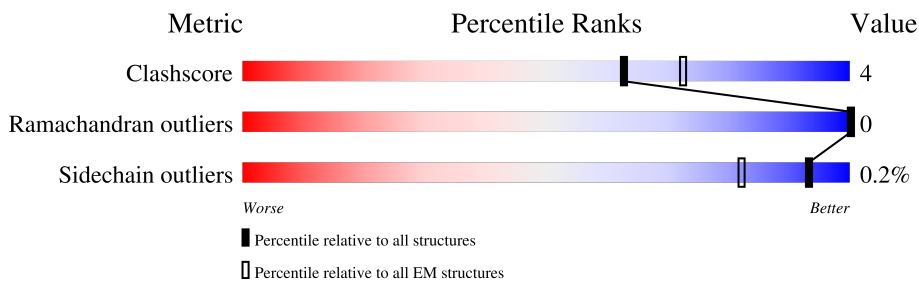

Metric	Whole archive (#Entries)	EM structures (#Entries)
Clashscore	158937	4297
Ramachandran outliers	154571	4023
Sidechain outliers	154315	3826

The table below summarises the geometric issues observed across the polymeric chains and their fit to the map. The red, orange, yellow and green segments of the bar indicate the fraction of residues that contain outliers for ≥ 3 , 2, 1 and 0 types of geometric quality criteria respectively. A grey segment represents the fraction of residues that are not modelled. The numeric value for each fraction is indicated below the corresponding segment, with a dot representing fractions $\leq 5\%$. The upper red bar (where present) indicates the fraction of residues that have poor fit to the EM map (all-atom inclusion $< 40\%$). The numeric value is given above the bar.

Mol	Chain	Length	Quality of chain
1	A	1970	
1	M	1970	
2	B	1174	
2	N	1174	
3	C	275	
3	O	275	
4	D	142	
4	P	142	

Continued on next page...

Continued from previous page...

Mol	Chain	Length	Quality of chain
5	E	210	11% 89% 11%
5	Q	210	11% 88% 12%
6	F	127	6% 50% 12% 38%
6	R	127	• 51% 11% 38%
7	G	172	15% 93% 6% •
7	S	172	15% 92% 7% •
8	H	150	10% 83% 15% ••
8	T	150	13% 84% 14% ••
9	I	125	15% 83% 8% 9%
9	U	125	15% 84% 7% 9%
10	J	67	• 84% 13% •
10	V	67	6% 84% 13% •
11	K	117	• 93% 5% •
11	W	117	5% 93% 5% •
12	L	58	9% 64% 12% 24%
12	X	58	12% 59% 17% 24%

2 Entry composition [i](#)

There are 13 unique types of molecules in this entry. The entry contains 54330 atoms, of which 0 are hydrogens and 0 are deuteriums.

In the tables below, the AltConf column contains the number of residues with at least one atom in alternate conformation and the Trace column contains the number of residues modelled with at most 2 atoms.

- Molecule 1 is a protein called DNA-directed RNA polymerase subunit.

Mol	Chain	Residues	Atoms					AltConf	Trace
			Total	C	N	O	S		
1	A	1033	Total	C	N	O	S	0	0
			8233	5186	1452	1550	45		
1	M	1033	Total	C	N	O	S	0	0
			8233	5186	1452	1550	45		

- Molecule 2 is a protein called DNA-directed RNA polymerase subunit beta.

Mol	Chain	Residues	Atoms					AltConf	Trace
			Total	C	N	O	S		
2	B	1023	Total	C	N	O	S	0	0
			8179	5188	1423	1518	50		
2	N	1023	Total	C	N	O	S	0	0
			8179	5188	1423	1518	50		

- Molecule 3 is a protein called DNA-directed RNA polymerase II subunit RPB3.

Mol	Chain	Residues	Atoms					AltConf	Trace
			Total	C	N	O	S		
3	C	257	Total	C	N	O	S	0	0
			2059	1294	351	408	6		
3	O	257	Total	C	N	O	S	0	0
			2059	1294	351	408	6		

- Molecule 4 is a protein called RNA polymerase II subunit D.

Mol	Chain	Residues	Atoms					AltConf	Trace
			Total	C	N	O	S		
4	D	129	Total	C	N	O	S	0	0
			1063	665	179	215	4		
4	P	129	Total	C	N	O	S	0	0
			1063	665	179	215	4		

- Molecule 5 is a protein called DNA-directed RNA polymerase II subunit E.

Mol	Chain	Residues	Atoms					AltConf	Trace
5	E	209	Total	C	N	O	S	0	0
			1720	1089	300	323	8		
5	Q	209	Total	C	N	O	S	0	0
			1720	1089	300	323	8		

- Molecule 6 is a protein called DNA-directed RNA polymerase II subunit F.

Mol	Chain	Residues	Atoms					AltConf	Trace
6	F	79	Total	C	N	O	S	0	0
			635	406	108	116	5		
6	R	79	Total	C	N	O	S	0	0
			635	406	108	116	5		

- Molecule 7 is a protein called DNA-directed RNA polymerase II subunit RPB7.

Mol	Chain	Residues	Atoms					AltConf	Trace
7	G	171	Total	C	N	O	S	0	0
			1351	875	219	249	8		
7	S	171	Total	C	N	O	S	0	0
			1351	875	219	249	8		

- Molecule 8 is a protein called DNA-directed RNA polymerases I, II, and III subunit RPABC3.

Mol	Chain	Residues	Atoms					AltConf	Trace
8	H	148	Total	C	N	O	S	0	0
			1186	750	194	237	5		
8	T	148	Total	C	N	O	S	0	0
			1186	750	194	237	5		

- Molecule 9 is a protein called DNA-directed RNA polymerase II subunit RPB9.

Mol	Chain	Residues	Atoms					AltConf	Trace
9	I	114	Total	C	N	O	S	0	0
			927	571	166	179	11		
9	U	114	Total	C	N	O	S	0	0
			927	571	166	179	11		

- Molecule 10 is a protein called DNA-directed RNA polymerases I, II, and III subunit RPABC5.

Mol	Chain	Residues	Atoms					AltConf	Trace
10	J	65	Total	C	N	O	S	0	0
			515	334	87	88	6		

Continued on next page...

Continued from previous page...

Mol	Chain	Residues	Atoms					AltConf	Trace
			Total	C	N	O	S		
10	V	65	515	334	87	88	6	0	0

- Molecule 11 is a protein called RNA_pol_L_2 domain-containing protein.

Mol	Chain	Residues	Atoms					AltConf	Trace
			Total	C	N	O	S		
11	K	115	920	593	152	173	2	0	0
11	W	115	920	593	152	173	2	0	0

- Molecule 12 is a protein called RNA polymerase II subunit K.

Mol	Chain	Residues	Atoms					AltConf	Trace
			Total	C	N	O	S		
12	L	44	372	231	72	63	6	0	0
12	X	44	372	231	72	63	6	0	0

- Molecule 13 is ZINC ION (three-letter code: ZN) (formula: Zn).

Mol	Chain	Residues	Atoms		AltConf
13	C	1	Total	Zn	0
			1	1	
13	I	2	Total	Zn	0
			2	2	
13	J	1	Total	Zn	0
			1	1	
13	L	1	Total	Zn	0
			1	1	
13	O	1	Total	Zn	0
			1	1	
13	U	2	Total	Zn	0
			2	2	
13	V	1	Total	Zn	0
			1	1	
13	X	1	Total	Zn	0
			1	1	

3 Residue-property plots

These plots are drawn for all protein, RNA, DNA and oligosaccharide chains in the entry. The first graphic for a chain summarises the proportions of the various outlier classes displayed in the second graphic. The second graphic shows the sequence view annotated by issues in geometry and atom inclusion in map density. Residues are color-coded according to the number of geometric quality criteria for which they contain at least one outlier: green = 0, yellow = 1, orange = 2 and red = 3 or more. A red diamond above a residue indicates a poor fit to the EM map for this residue (all-atom inclusion < 40%). Stretches of 2 or more consecutive residues without any outlier are shown as a green connector. Residues present in the sample, but not in the model, are shown in grey.

- Molecule 1: DNA-directed RNA polymerase subunit

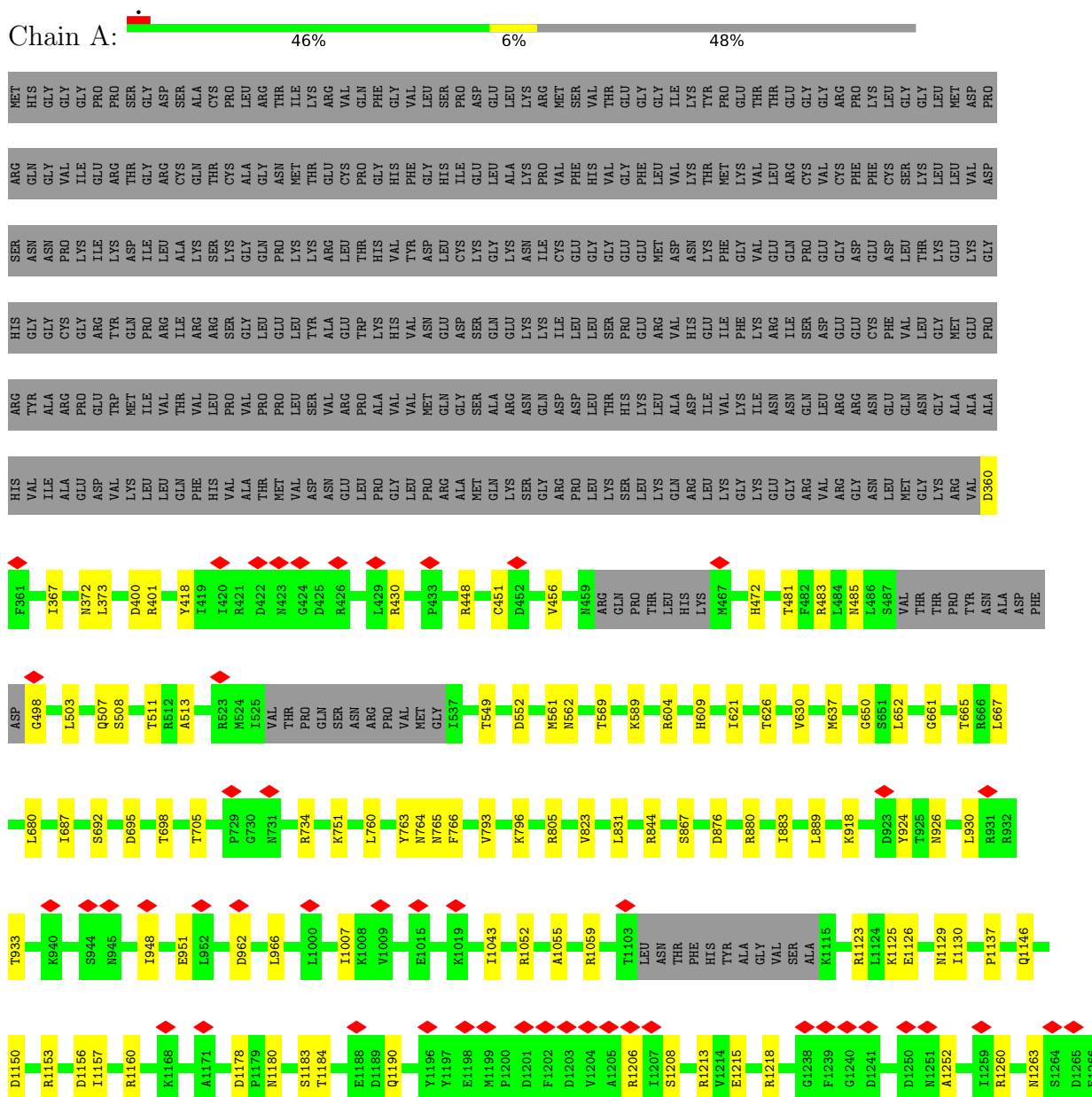

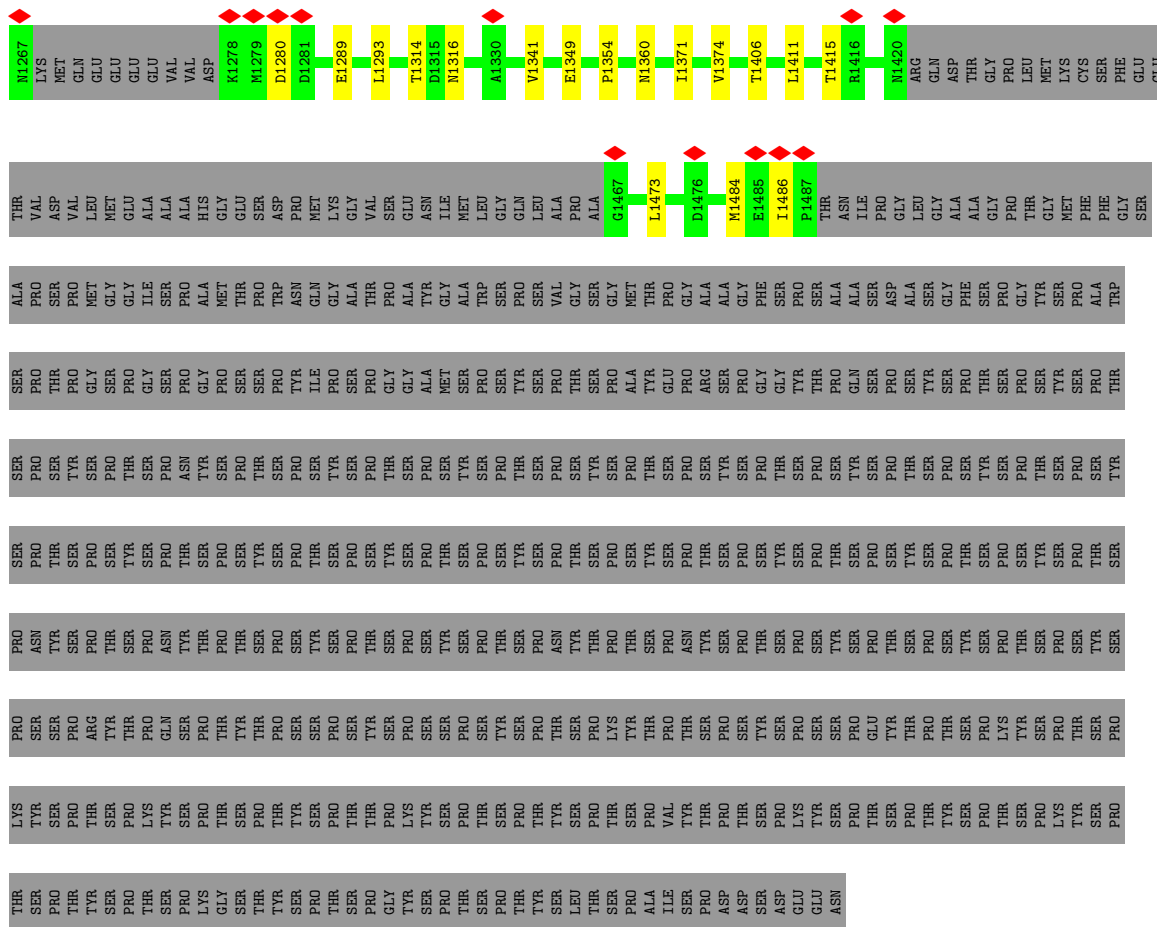

● Molecule 1: DNA-directed RNA polymerase subunit

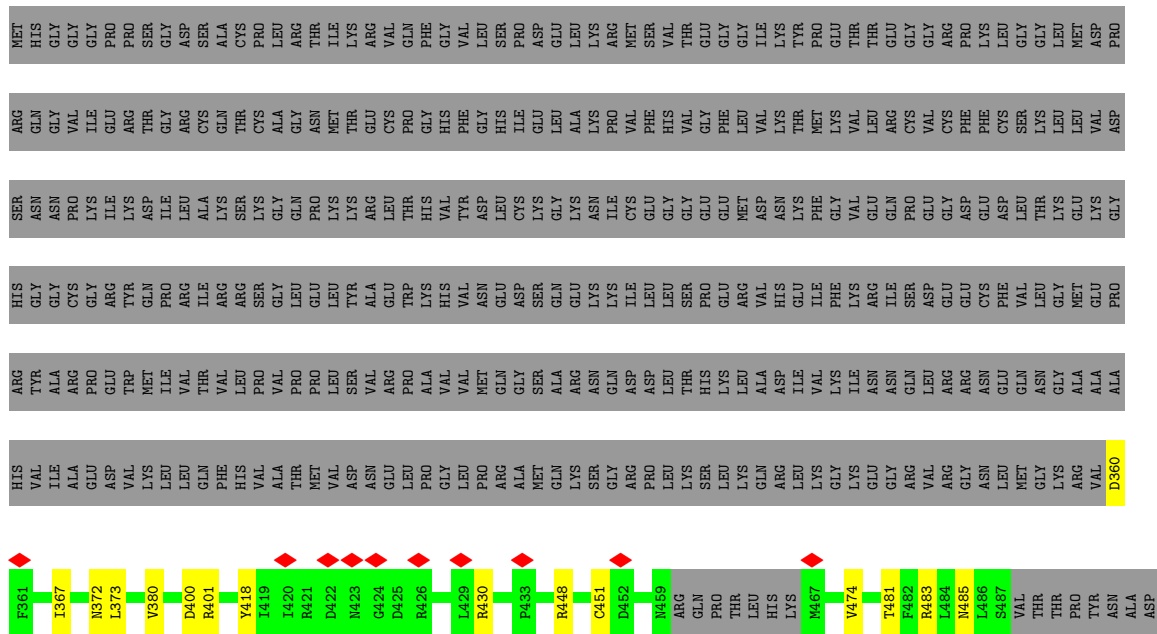

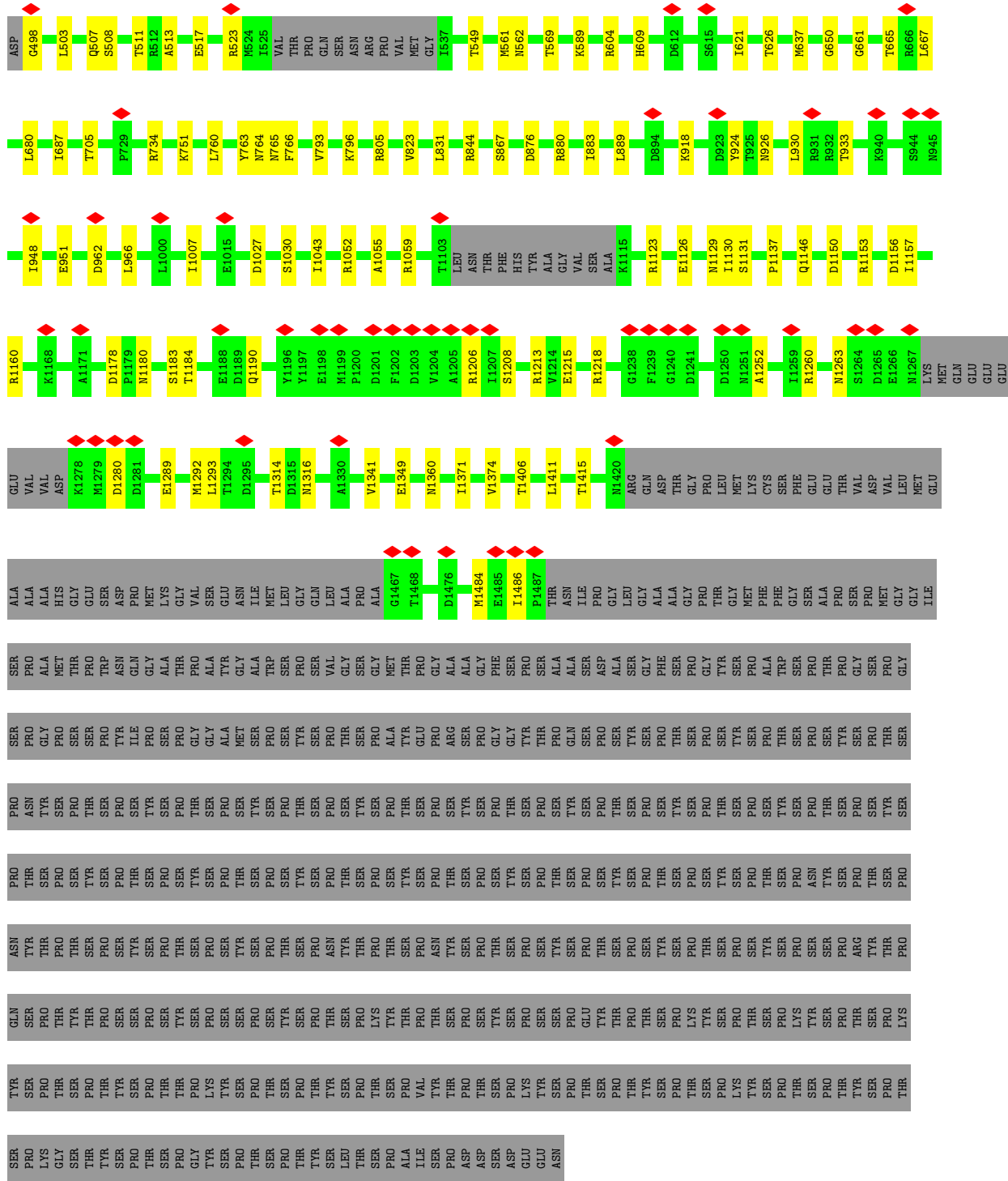

● Molecule 2: DNA-directed RNA polymerase subunit beta

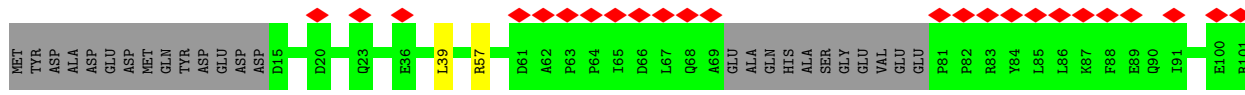
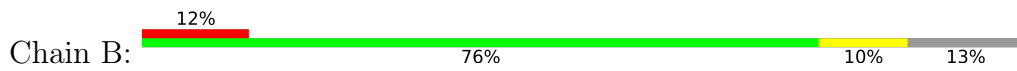

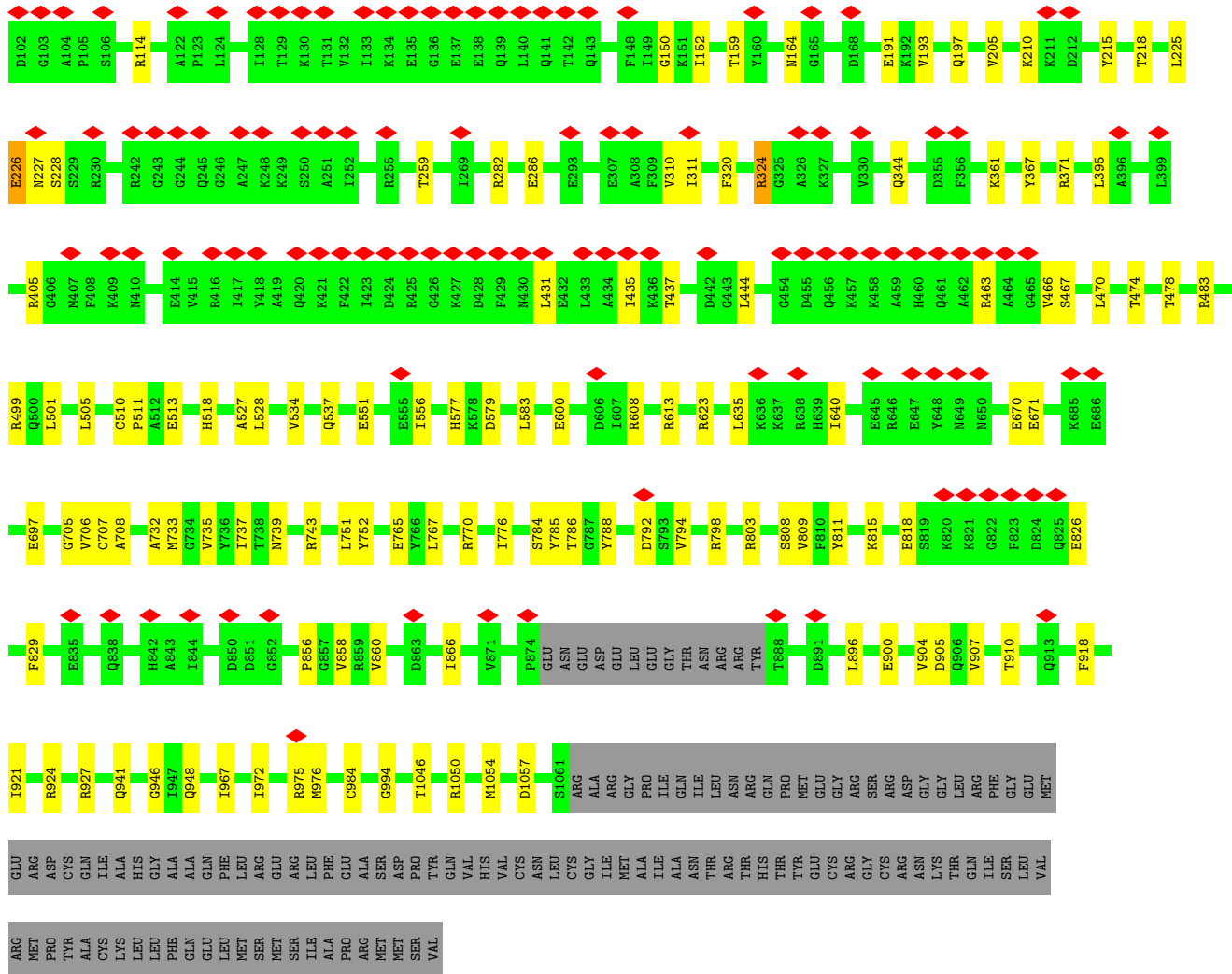

• Molecule 2: DNA-directed RNA polymerase subunit beta

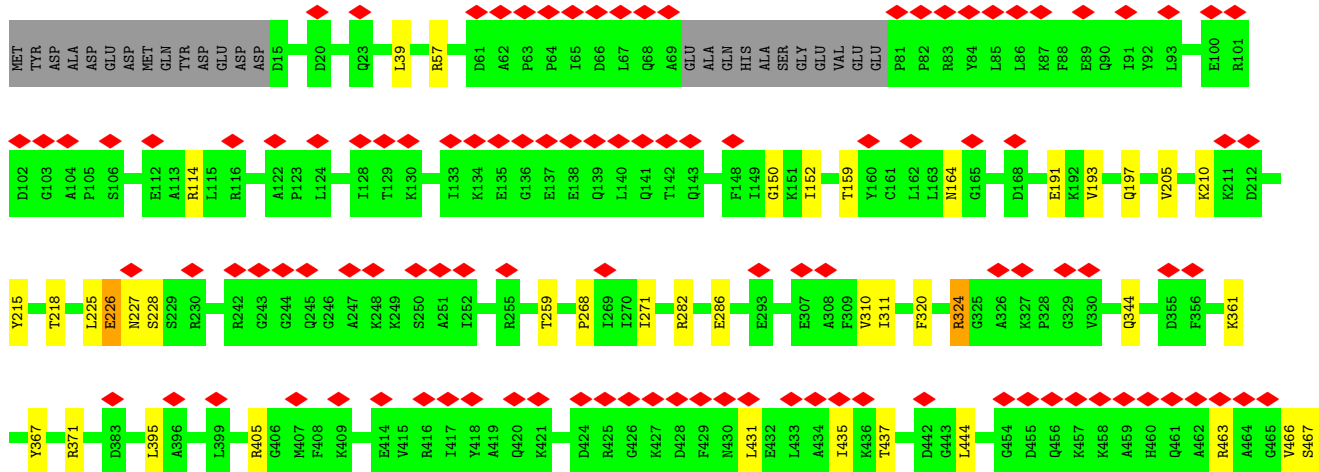
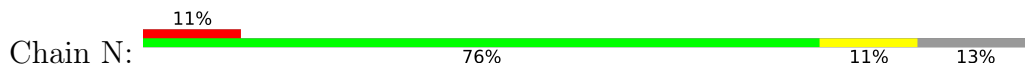

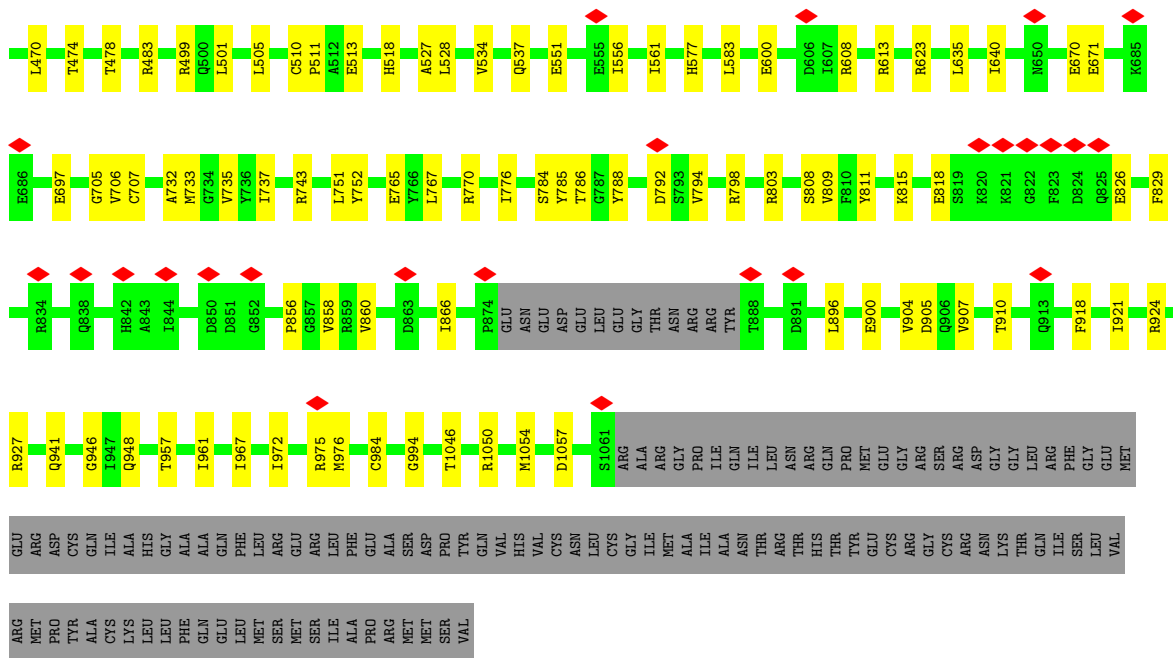

• Molecule 3: DNA-directed RNA polymerase II subunit RPB3

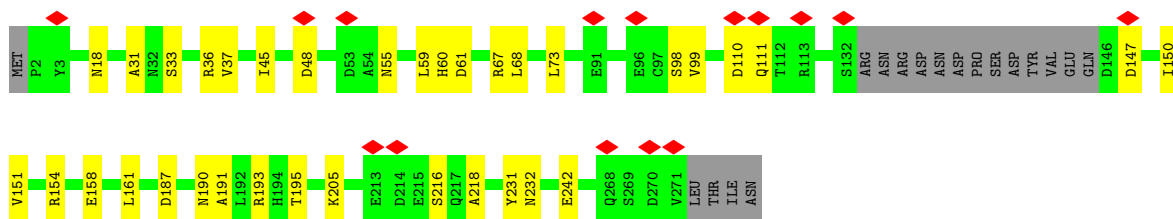
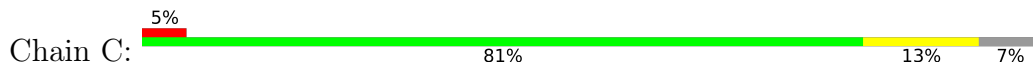

• Molecule 3: DNA-directed RNA polymerase II subunit RPB3

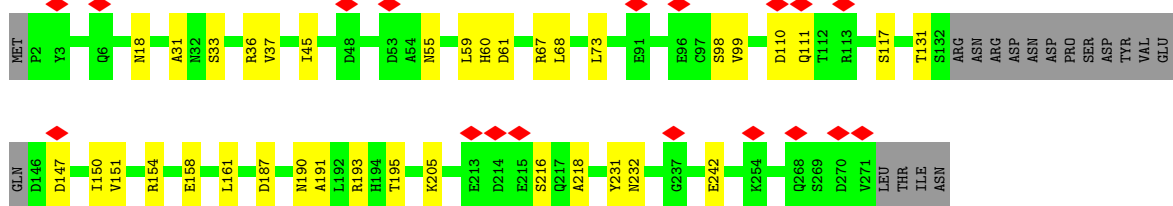
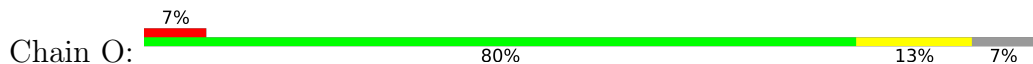

• Molecule 4: RNA polymerase II subunit D

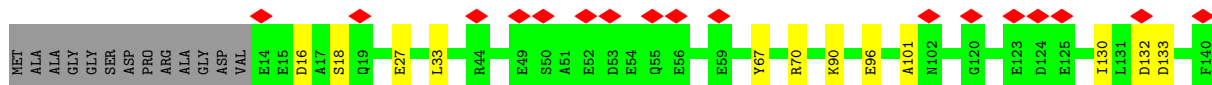
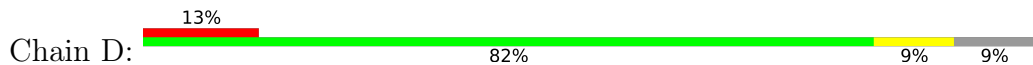



• Molecule 4: RNA polymerase II subunit D

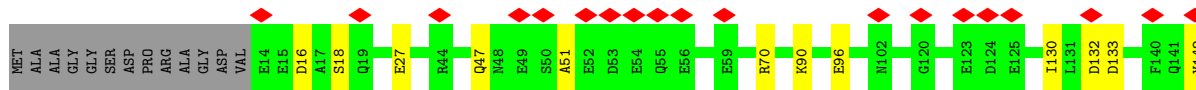
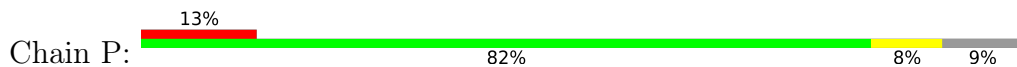

• Molecule 5: DNA-directed RNA polymerase II subunit E

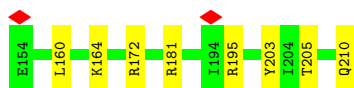
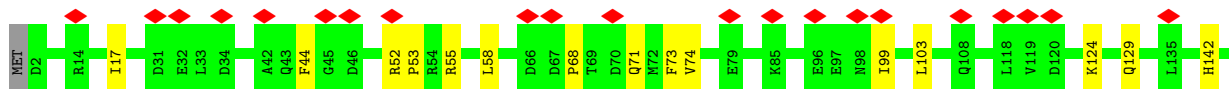
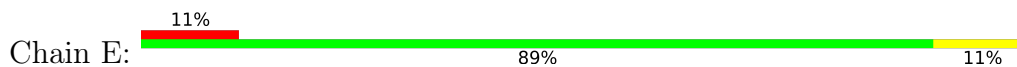

• Molecule 5: DNA-directed RNA polymerase II subunit E

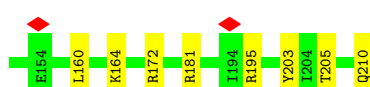
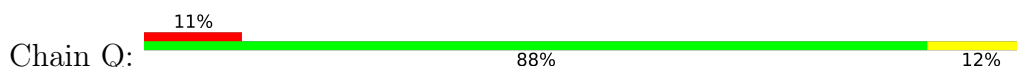

• Molecule 6: DNA-directed RNA polymerase II subunit F

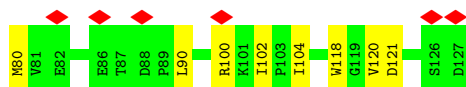
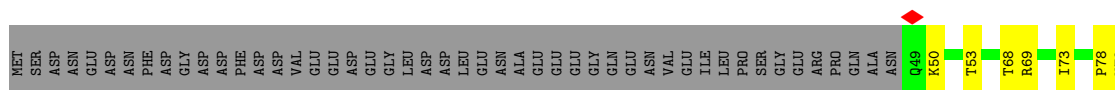

• Molecule 6: DNA-directed RNA polymerase II subunit F



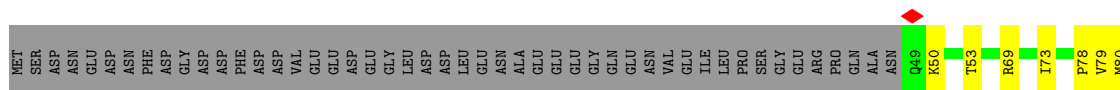

- Molecule 7: DNA-directed RNA polymerase II subunit RPB7

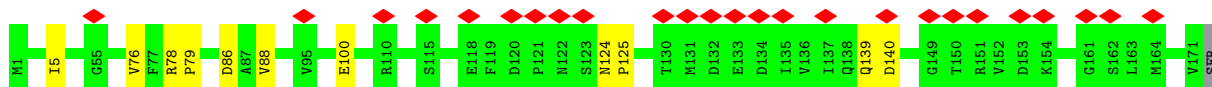
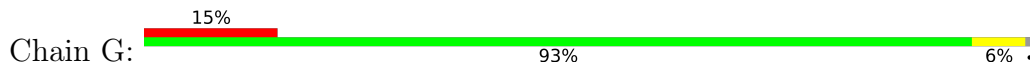

- Molecule 7: DNA-directed RNA polymerase II subunit RPB7

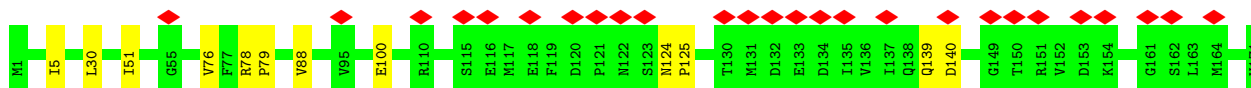

SER

- Molecule 8: DNA-directed RNA polymerases I, II, and III subunit RPABC3

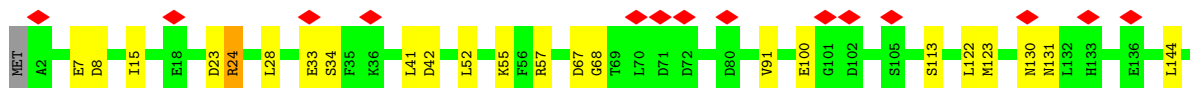
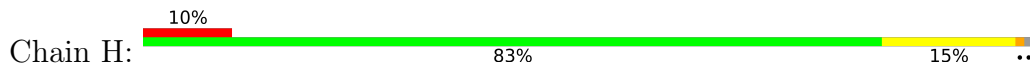

- Molecule 8: DNA-directed RNA polymerases I, II, and III subunit RPABC3

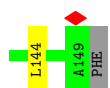
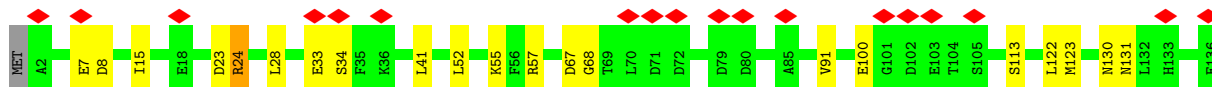
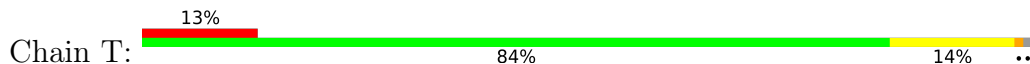

- Molecule 9: DNA-directed RNA polymerase II subunit RPB9

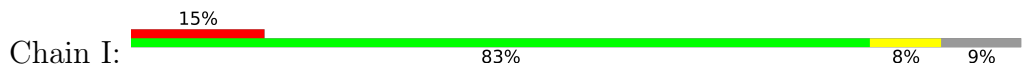

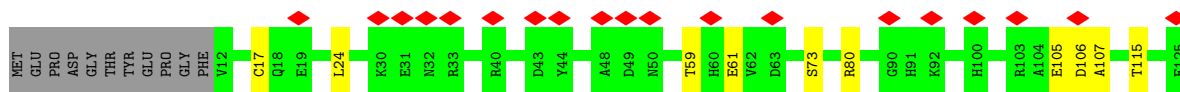

- Molecule 9: DNA-directed RNA polymerase II subunit RPB9

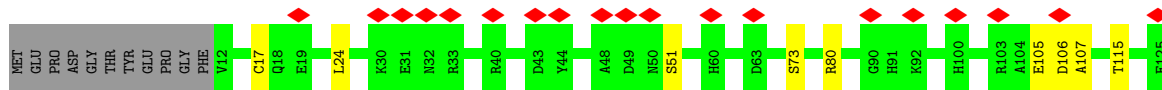
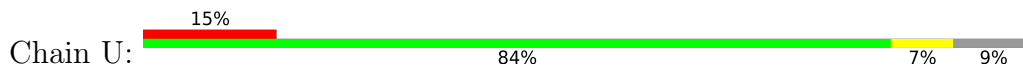

- Molecule 10: DNA-directed RNA polymerases I, II, and III subunit RPABC5

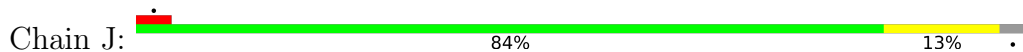

- Molecule 10: DNA-directed RNA polymerases I, II, and III subunit RPABC5

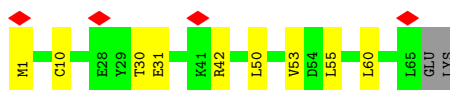
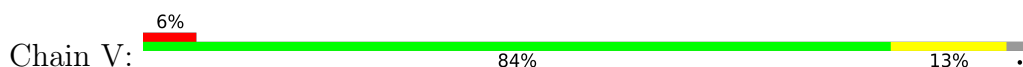

- Molecule 11: RNA_pol_L_2 domain-containing protein



- Molecule 11: RNA_pol_L_2 domain-containing protein



- Molecule 12: RNA polymerase II subunit K

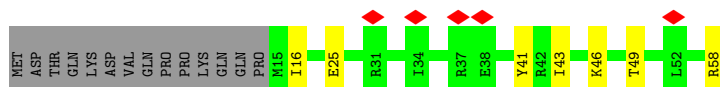

- Molecule 12: RNA polymerase II subunit K

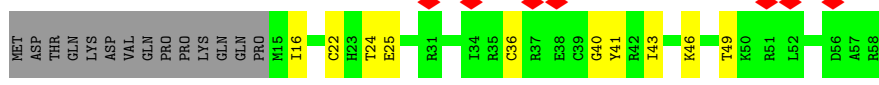

4 Experimental information

Property	Value	Source
EM reconstruction method	SINGLE PARTICLE	Depositor
Imposed symmetry	POINT, Not provided	
Number of particles used	47091	Depositor
Resolution determination method	FSC 0.143 CUT-OFF	Depositor
CTF correction method	PHASE FLIPPING AND AMPLITUDE CORRECTION	Depositor
Microscope	FEI TITAN KRIOS	Depositor
Voltage (kV)	300	Depositor
Electron dose ($e^-/\text{\AA}^2$)	42	Depositor
Minimum defocus (nm)	Not provided	
Maximum defocus (nm)	Not provided	
Magnification	Not provided	
Image detector	GATAN K3 BIOQUANTUM (6k x 4k)	Depositor
Maximum map value	39.047	Depositor
Minimum map value	-20.160	Depositor
Average map value	-0.001	Depositor
Map value standard deviation	0.935	Depositor
Recommended contour level	5.0	Depositor
Map size (Å)	367.65, 367.65, 367.65	wwPDB
Map dimensions	450, 450, 450	wwPDB
Map angles (°)	90.0, 90.0, 90.0	wwPDB
Pixel spacing (Å)	0.817, 0.817, 0.817	Depositor

5 Model quality

5.1 Standard geometry

Bond lengths and bond angles in the following residue types are not validated in this section:
ZN

The Z score for a bond length (or angle) is the number of standard deviations the observed value is removed from the expected value. A bond length (or angle) with $|Z| > 5$ is considered an outlier worth inspection. RMSZ is the root-mean-square of all Z scores of the bond lengths (or angles).

Mol	Chain	Bond lengths		Bond angles	
		RMSZ	# Z >5	RMSZ	# Z >5
1	A	0.23	0/8378	0.38	0/11315
1	M	0.23	0/8378	0.38	0/11315
2	B	0.24	0/8345	0.40	0/11272
2	N	0.24	0/8345	0.40	0/11272
3	C	0.23	0/2102	0.40	0/2857
3	O	0.23	0/2102	0.40	0/2857
4	D	0.23	0/1078	0.35	0/1446
4	P	0.23	0/1078	0.35	0/1446
5	E	0.23	0/1751	0.39	0/2366
5	Q	0.23	0/1751	0.39	0/2366
6	F	0.23	0/645	0.39	0/871
6	R	0.23	0/645	0.39	0/871
7	G	0.25	0/1382	0.41	0/1874
7	S	0.25	0/1382	0.41	0/1874
8	H	0.24	0/1207	0.41	0/1628
8	T	0.24	0/1207	0.41	0/1628
9	I	0.23	0/948	0.39	0/1284
9	U	0.23	0/948	0.39	0/1284
10	J	0.24	0/524	0.38	0/707
10	V	0.24	0/524	0.38	0/707
11	K	0.24	0/939	0.37	0/1271
11	W	0.24	0/939	0.37	0/1271
12	L	0.23	0/377	0.42	0/500
12	X	0.23	0/377	0.42	0/500
All	All	0.24	0/55352	0.39	0/74782

Chiral center outliers are detected by calculating the chiral volume of a chiral center and verifying if the center is modelled as a planar moiety or with the opposite hand. A planarity outlier is detected by checking planarity of atoms in a peptide group, atoms in a mainchain group or atoms of a sidechain that are expected to be planar.

Mol	Chain	#Chirality outliers	#Planarity outliers
2	B	0	1
2	N	0	1
All	All	0	2

There are no bond length outliers.

There are no bond angle outliers.

There are no chirality outliers.

All (2) planarity outliers are listed below:

Mol	Chain	Res	Type	Group
2	B	226	GLU	Peptide
2	N	226	GLU	Peptide

5.2 Too-close contacts [i](#)

In the following table, the Non-H and H(model) columns list the number of non-hydrogen atoms and hydrogen atoms in the chain respectively. The H(added) column lists the number of hydrogen atoms added and optimized by MolProbity. The Clashes column lists the number of clashes within the asymmetric unit, whereas Symm-Clashes lists symmetry-related clashes.

Mol	Chain	Non-H	H(model)	H(added)	Clashes	Symm-Clashes
1	A	8233	0	8273	80	0
1	M	8233	0	8273	79	0
2	B	8179	0	8218	86	0
2	N	8179	0	8218	89	0
3	C	2059	0	2007	22	0
3	O	2059	0	2007	22	0
4	D	1063	0	1042	9	0
4	P	1063	0	1042	8	0
5	E	1720	0	1737	14	0
5	Q	1720	0	1737	15	0
6	F	635	0	665	10	0
6	R	635	0	665	9	0
7	G	1351	0	1358	8	0
7	S	1351	0	1358	8	0
8	H	1186	0	1147	15	0
8	T	1186	0	1147	13	0
9	I	927	0	859	6	0
9	U	927	0	859	6	0
10	J	515	0	534	7	0
10	V	515	0	534	7	0

Continued on next page...

Continued from previous page...

Mol	Chain	Non-H	H(model)	H(added)	Clashes	Symm-Clashes
11	K	920	0	942	8	0
11	W	920	0	942	8	0
12	L	372	0	378	5	0
12	X	372	0	378	7	0
13	C	1	0	0	0	0
13	I	2	0	0	0	0
13	J	1	0	0	0	0
13	L	1	0	0	0	0
13	O	1	0	0	0	0
13	U	2	0	0	0	0
13	V	1	0	0	0	0
13	X	1	0	0	0	0
All	All	54330	0	54320	477	0

The all-atom clashscore is defined as the number of clashes found per 1000 atoms (including hydrogen atoms). The all-atom clashscore for this structure is 4.

The worst 5 of 477 close contacts within the same asymmetric unit are listed below, sorted by their clash magnitude.

Atom-1	Atom-2	Interatomic distance (Å)	Clash overlap (Å)
1:M:1374:VAL:HG11	1:M:1411:LEU:HD21	1.58	0.85
1:M:867:SER:HG	1:M:1415:THR:HG1	1.11	0.84
1:A:1374:VAL:HG11	1:A:1411:LEU:HD21	1.58	0.83
2:B:984:CYS:SG	2:B:1046:THR:OG1	2.37	0.81
2:N:984:CYS:SG	2:N:1046:THR:OG1	2.37	0.81

There are no symmetry-related clashes.

5.3 Torsion angles [i](#)

5.3.1 Protein backbone [i](#)

In the following table, the Percentiles column shows the percent Ramachandran outliers of the chain as a percentile score with respect to all PDB entries followed by that with respect to all EM entries.

The Analysed column shows the number of residues for which the backbone conformation was analysed, and the total number of residues.

Mol	Chain	Analysed	Favoured	Allowed	Outliers	Percentiles	
1	A	1019/1970 (52%)	998 (98%)	21 (2%)	0	100	100
1	M	1019/1970 (52%)	997 (98%)	22 (2%)	0	100	100
2	B	1017/1174 (87%)	987 (97%)	30 (3%)	0	100	100
2	N	1017/1174 (87%)	986 (97%)	31 (3%)	0	100	100
3	C	253/275 (92%)	248 (98%)	5 (2%)	0	100	100
3	O	253/275 (92%)	248 (98%)	5 (2%)	0	100	100
4	D	127/142 (89%)	127 (100%)	0	0	100	100
4	P	127/142 (89%)	127 (100%)	0	0	100	100
5	E	207/210 (99%)	201 (97%)	6 (3%)	0	100	100
5	Q	207/210 (99%)	202 (98%)	5 (2%)	0	100	100
6	F	77/127 (61%)	76 (99%)	1 (1%)	0	100	100
6	R	77/127 (61%)	76 (99%)	1 (1%)	0	100	100
7	G	169/172 (98%)	167 (99%)	2 (1%)	0	100	100
7	S	169/172 (98%)	167 (99%)	2 (1%)	0	100	100
8	H	146/150 (97%)	146 (100%)	0	0	100	100
8	T	146/150 (97%)	146 (100%)	0	0	100	100
9	I	112/125 (90%)	108 (96%)	4 (4%)	0	100	100
9	U	112/125 (90%)	109 (97%)	3 (3%)	0	100	100
10	J	63/67 (94%)	63 (100%)	0	0	100	100
10	V	63/67 (94%)	62 (98%)	1 (2%)	0	100	100
11	K	113/117 (97%)	113 (100%)	0	0	100	100
11	W	113/117 (97%)	113 (100%)	0	0	100	100
12	L	42/58 (72%)	40 (95%)	2 (5%)	0	100	100
12	X	42/58 (72%)	40 (95%)	2 (5%)	0	100	100
All	All	6690/9174 (73%)	6547 (98%)	143 (2%)	0	100	100

There are no Ramachandran outliers to report.

5.3.2 Protein sidechains [i](#)

In the following table, the Percentiles column shows the percent sidechain outliers of the chain as a percentile score with respect to all PDB entries followed by that with respect to all EM entries.

The Analysed column shows the number of residues for which the sidechain conformation was

analysed, and the total number of residues.

Mol	Chain	Analysed	Rotameric	Outliers	Percentiles	
1	A	918/1749 (52%)	918 (100%)	0	100	100
1	M	918/1749 (52%)	918 (100%)	0	100	100
2	B	898/1027 (87%)	896 (100%)	2 (0%)	93	97
2	N	898/1027 (87%)	896 (100%)	2 (0%)	93	97
3	C	234/252 (93%)	234 (100%)	0	100	100
3	O	234/252 (93%)	234 (100%)	0	100	100
4	D	119/126 (94%)	119 (100%)	0	100	100
4	P	119/126 (94%)	119 (100%)	0	100	100
5	E	191/192 (100%)	190 (100%)	1 (0%)	88	94
5	Q	191/192 (100%)	190 (100%)	1 (0%)	88	94
6	F	69/111 (62%)	68 (99%)	1 (1%)	67	81
6	R	69/111 (62%)	68 (99%)	1 (1%)	67	81
7	G	152/153 (99%)	152 (100%)	0	100	100
7	S	152/153 (99%)	152 (100%)	0	100	100
8	H	129/131 (98%)	128 (99%)	1 (1%)	81	89
8	T	129/131 (98%)	128 (99%)	1 (1%)	81	89
9	I	103/112 (92%)	103 (100%)	0	100	100
9	U	103/112 (92%)	103 (100%)	0	100	100
10	J	54/56 (96%)	53 (98%)	1 (2%)	57	76
10	V	54/56 (96%)	53 (98%)	1 (2%)	57	76
11	K	104/106 (98%)	104 (100%)	0	100	100
11	W	104/106 (98%)	104 (100%)	0	100	100
12	L	41/55 (74%)	41 (100%)	0	100	100
12	X	41/55 (74%)	41 (100%)	0	100	100
All	All	6024/8140 (74%)	6012 (100%)	12 (0%)	93	97

5 of 12 residues with a non-rotameric sidechain are listed below:

Mol	Chain	Res	Type
2	N	608	ARG
5	Q	124	LYS
10	V	42	ARG
6	R	50	LYS

Continued on next page...

Continued from previous page...

Mol	Chain	Res	Type
6	F	50	LYS

Sometimes sidechains can be flipped to improve hydrogen bonding and reduce clashes. All (5) such sidechains are listed below:

Mol	Chain	Res	Type
1	A	485	ASN
2	B	518	HIS
1	M	485	ASN
1	M	809	HIS
2	N	518	HIS

5.3.3 RNA [i](#)

There are no RNA molecules in this entry.

5.4 Non-standard residues in protein, DNA, RNA chains [i](#)

There are no non-standard protein/DNA/RNA residues in this entry.

5.5 Carbohydrates [i](#)

There are no monosaccharides in this entry.

5.6 Ligand geometry [i](#)

Of 10 ligands modelled in this entry, 10 are monoatomic - leaving 0 for Mogul analysis.

There are no bond length outliers.

There are no bond angle outliers.

There are no chirality outliers.

There are no torsion outliers.

There are no ring outliers.

No monomer is involved in short contacts.

5.7 Other polymers [i](#)

There are no such residues in this entry.

5.8 Polymer linkage issues [i](#)

There are no chain breaks in this entry.

6 Map visualisation [i](#)

This section contains visualisations of the EMDB entry EMD-13130. These allow visual inspection of the internal detail of the map and identification of artifacts.

Images derived from a raw map, generated by summing the deposited half-maps, are presented below the corresponding image components of the primary map to allow further visual inspection and comparison with those of the primary map.

6.1 Orthogonal projections [i](#)

6.1.1 Primary map

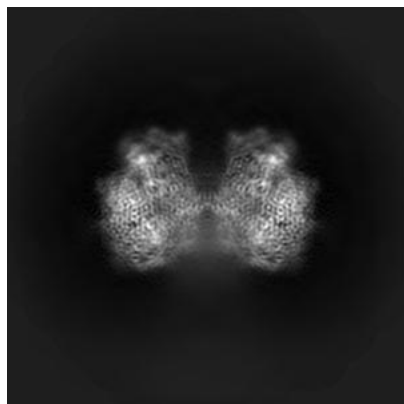

X

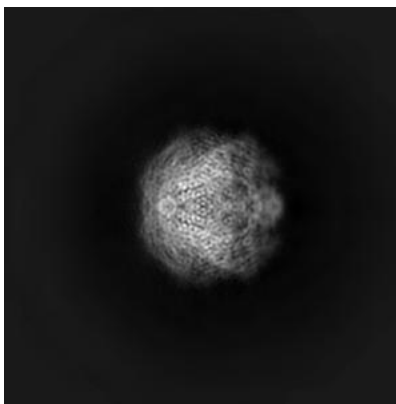

Y

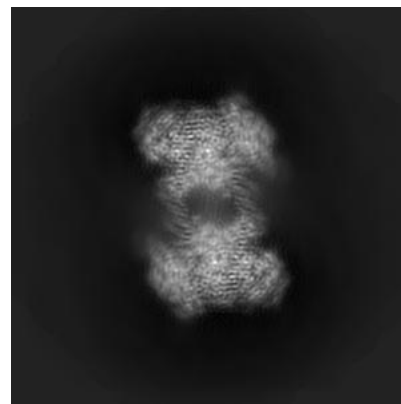

Z

6.1.2 Raw map

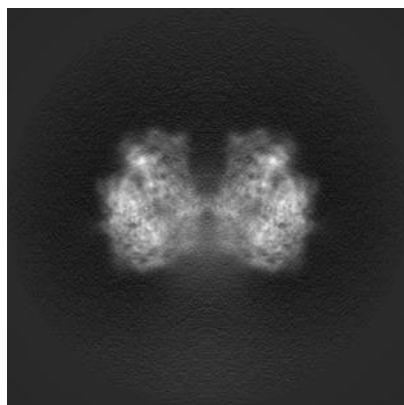

X

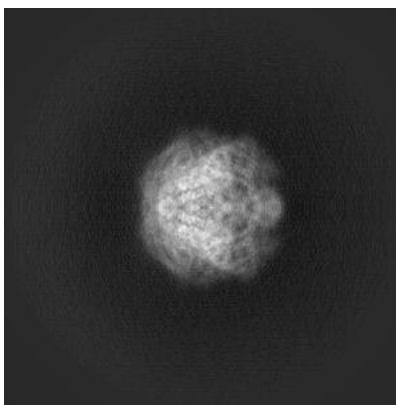

Y

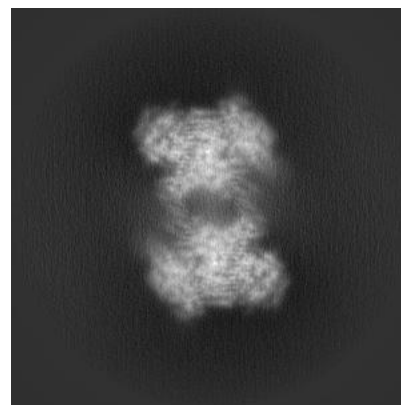

Z

The images above show the map projected in three orthogonal directions.

6.2 Central slices [i](#)

6.2.1 Primary map

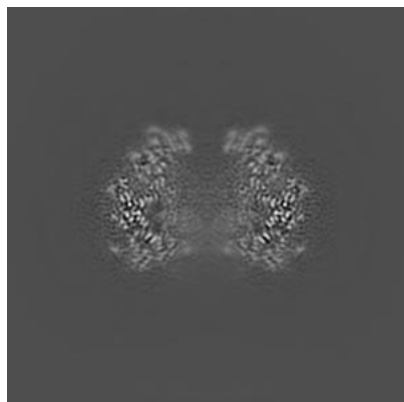

X Index: 225

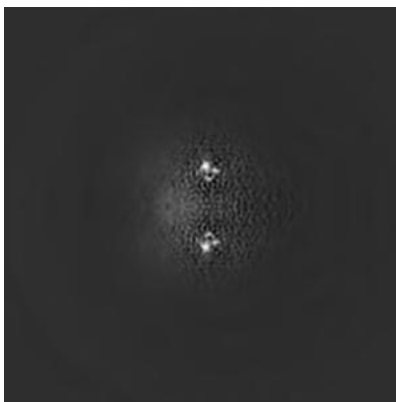

Y Index: 225

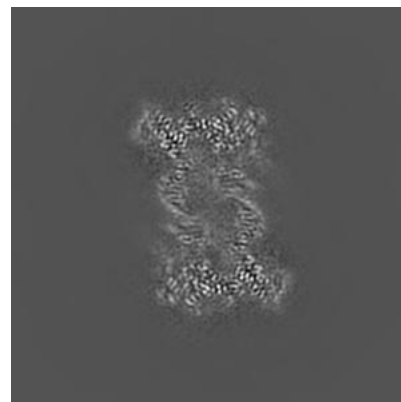

Z Index: 225

6.2.2 Raw map

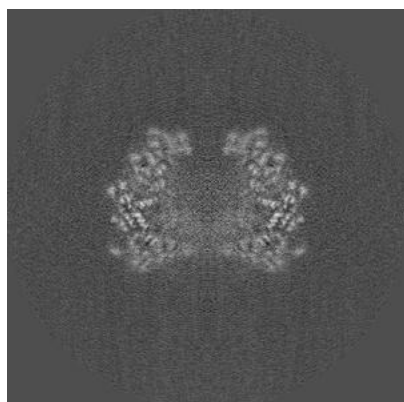

X Index: 225

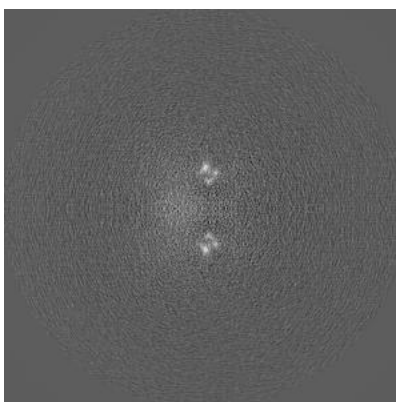

Y Index: 225

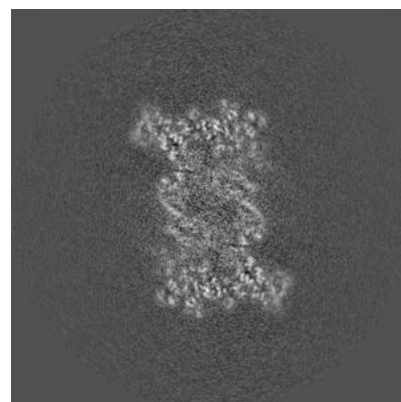

Z Index: 225

The images above show central slices of the map in three orthogonal directions.

6.3 Largest variance slices [i](#)

6.3.1 Primary map

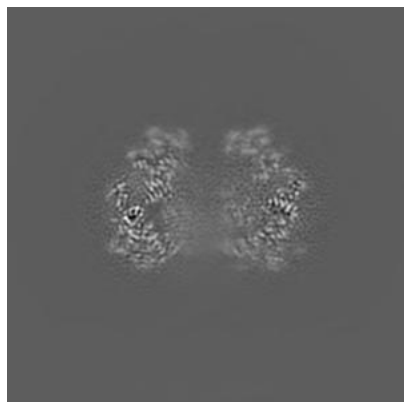

X Index: 229

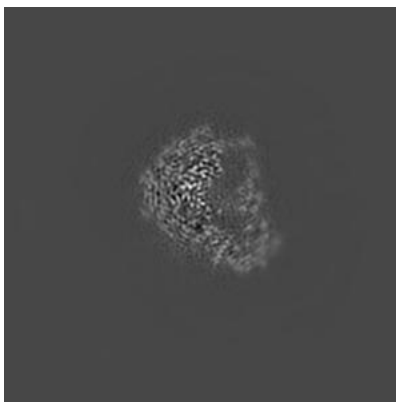

Y Index: 146

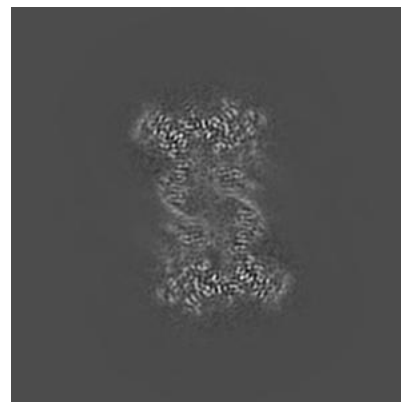

Z Index: 224

6.3.2 Raw map

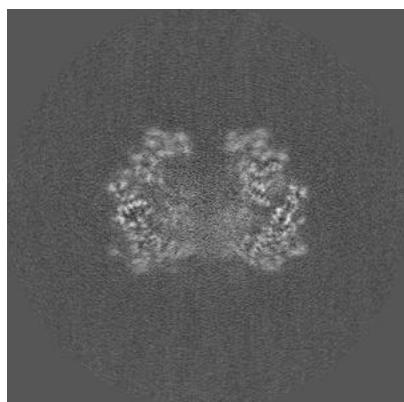

X Index: 222

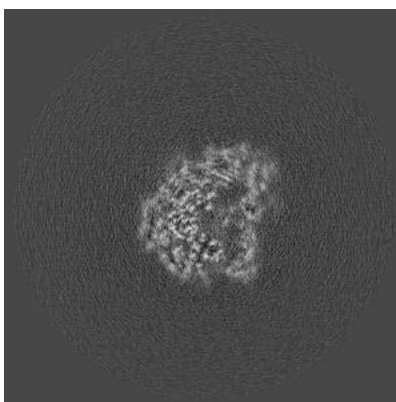

Y Index: 297

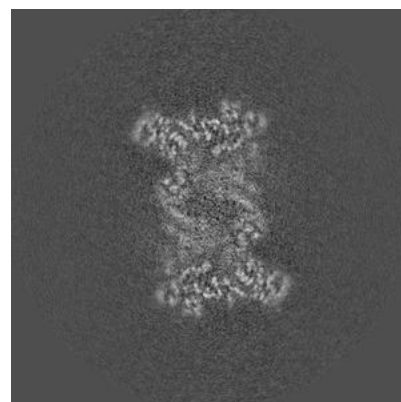

Z Index: 223

The images above show the largest variance slices of the map in three orthogonal directions.

6.4 Orthogonal surface views [i](#)

6.4.1 Primary map

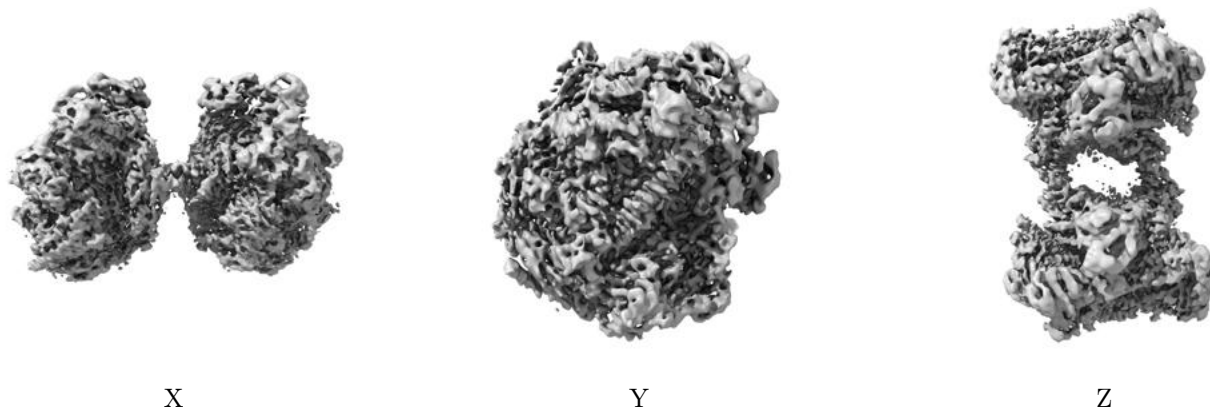

The images above show the 3D surface view of the map at the recommended contour level 5.0. These images, in conjunction with the slice images, may facilitate assessment of whether an appropriate contour level has been provided.

6.4.2 Raw map

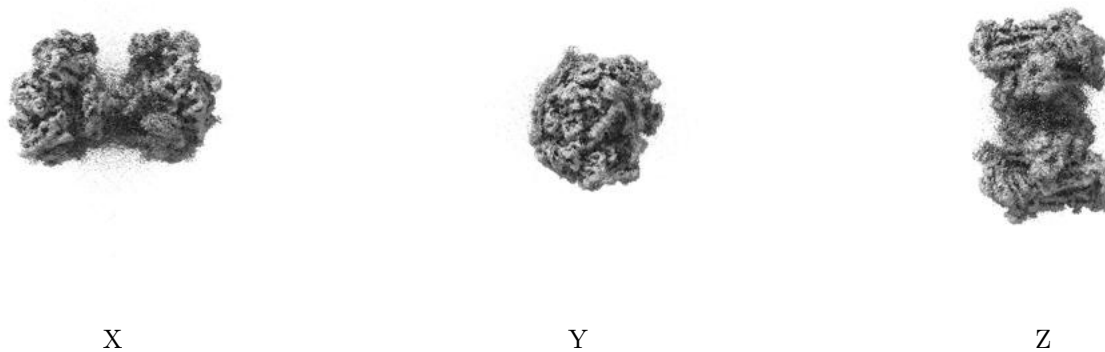

These images show the 3D surface of the raw map. The raw map's contour level was selected so that its surface encloses the same volume as the primary map does at its recommended contour level.

6.5 Mask visualisation [i](#)

This section shows the 3D surface view of the primary map at 50% transparency overlaid with the specified mask at 0% transparency

A mask typically either:

- Encompasses the whole structure
- Separates out a domain, a functional unit, a monomer or an area of interest from a larger structure

6.5.1 emd_13130_msk_1.map [i](#)

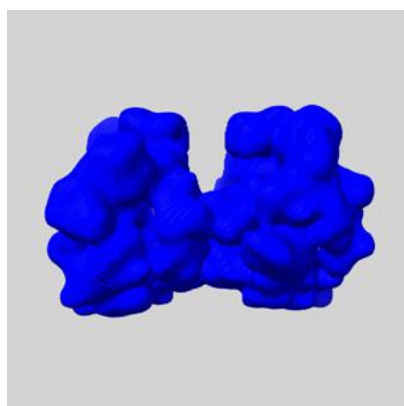

X

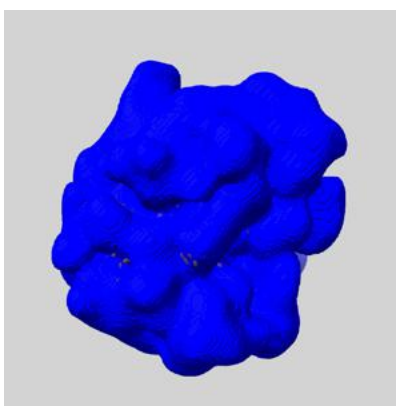

Y

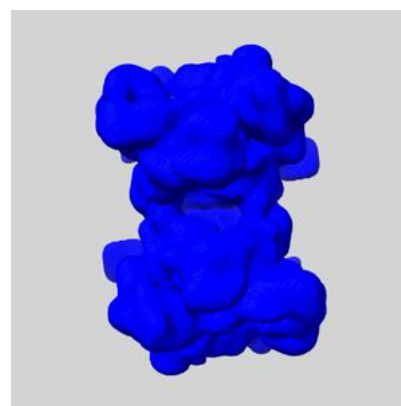

Z

7 Map analysis [i](#)

This section contains the results of statistical analysis of the map.

7.1 Map-value distribution [i](#)

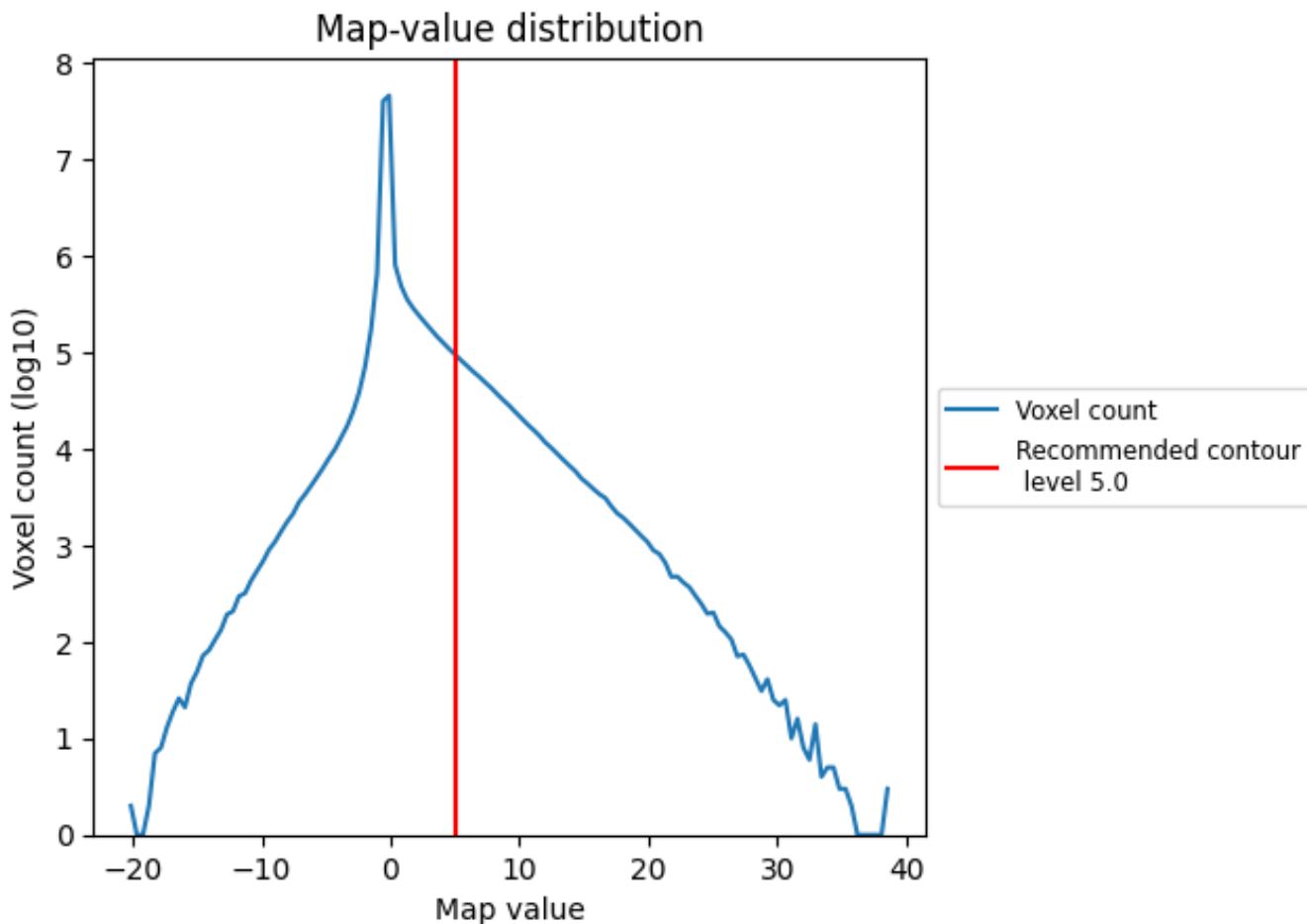

The map-value distribution is plotted in 128 intervals along the x-axis. The y-axis is logarithmic. A spike in this graph at zero usually indicates that the volume has been masked.

7.2 Volume estimate [\(i\)](#)

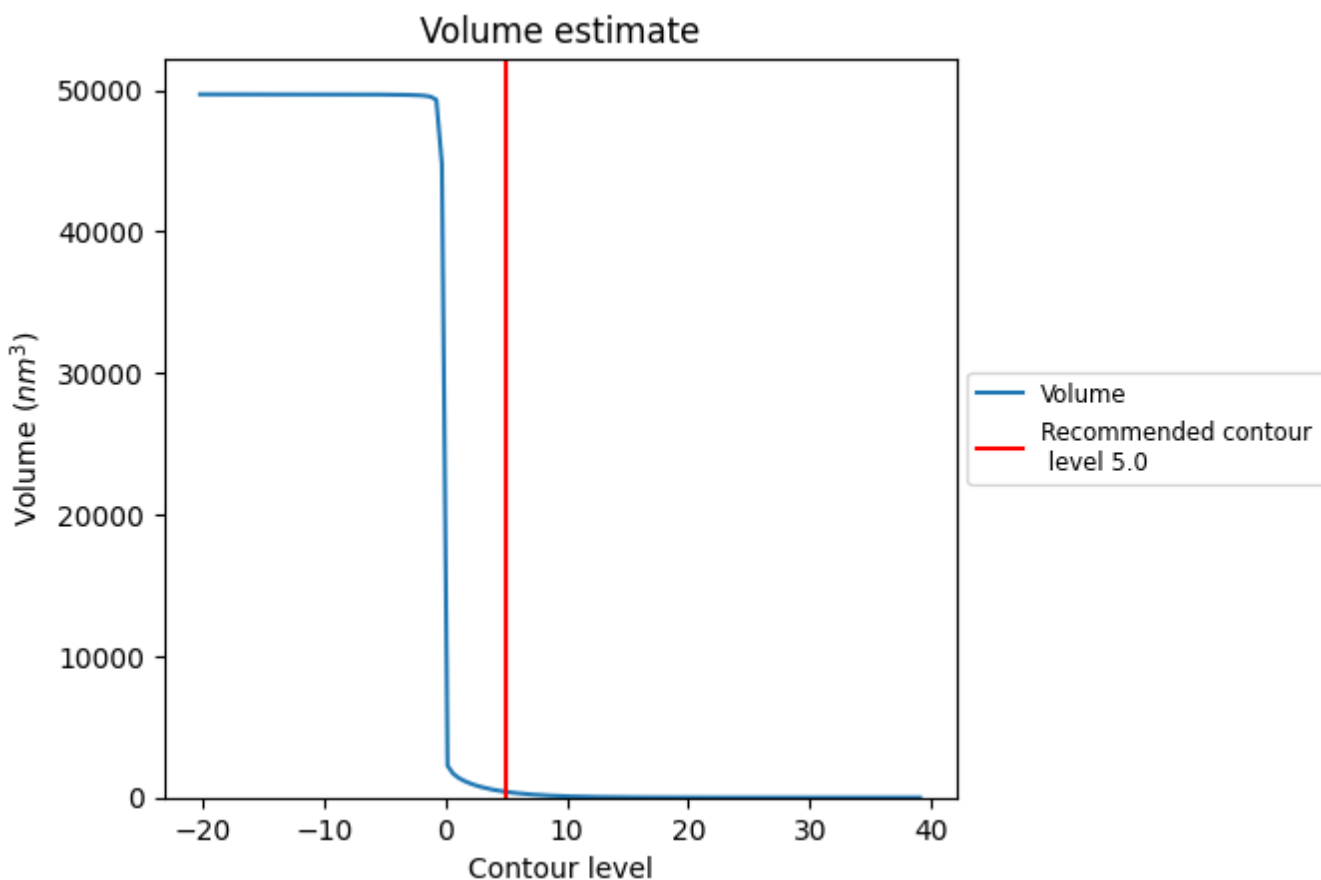

The volume at the recommended contour level is 406 nm³; this corresponds to an approximate mass of 367 kDa.

The volume estimate graph shows how the enclosed volume varies with the contour level. The recommended contour level is shown as a vertical line and the intersection between the line and the curve gives the volume of the enclosed surface at the given level.

7.3 Rotationally averaged power spectrum i

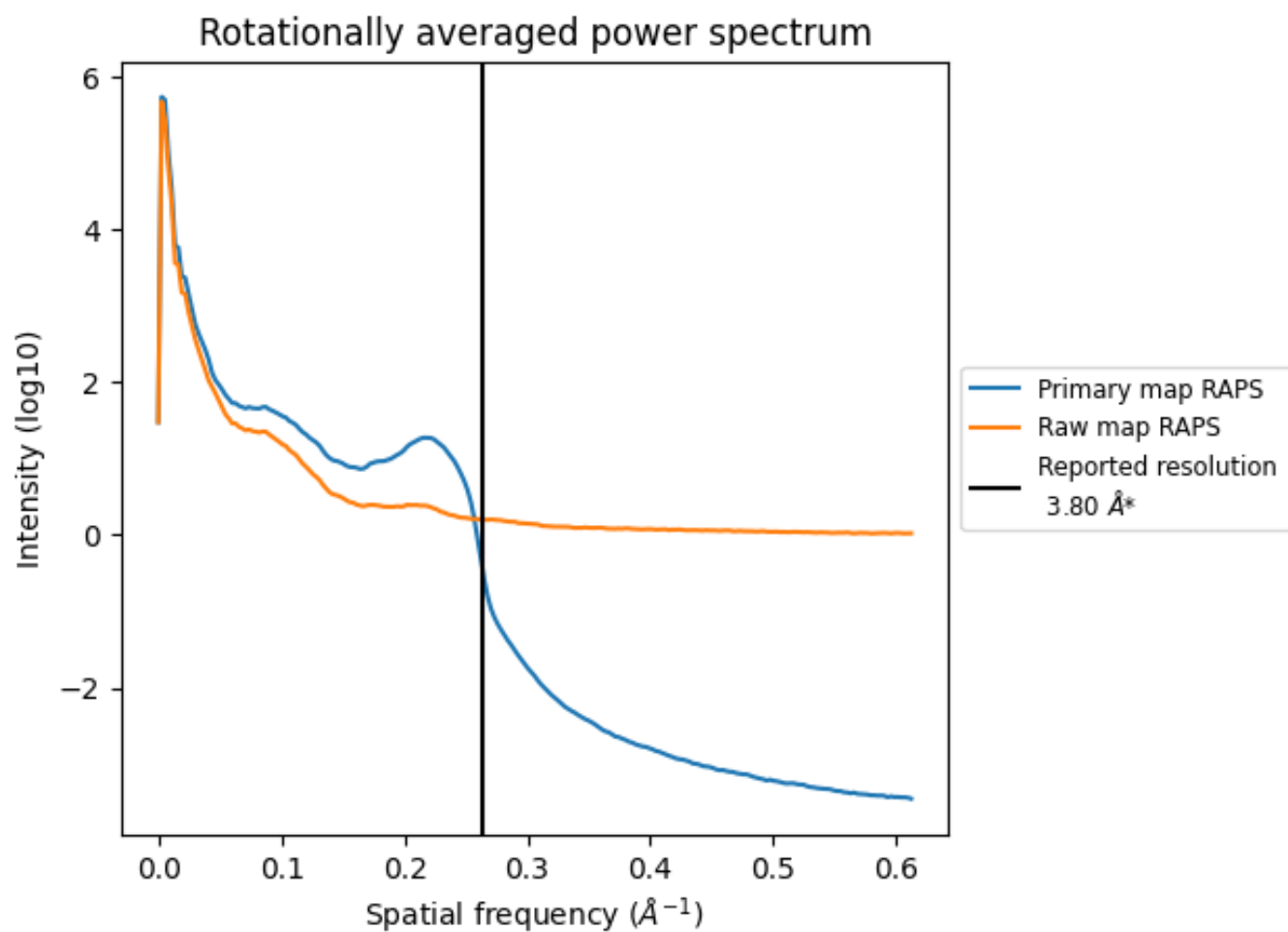

*Reported resolution corresponds to spatial frequency of 0.263 \AA^{-1}

8 Fourier-Shell correlation [i](#)

Fourier-Shell Correlation (FSC) is the most commonly used method to estimate the resolution of single-particle and subtomogram-averaged maps. The shape of the curve depends on the imposed symmetry, mask and whether or not the two 3D reconstructions used were processed from a common reference. The reported resolution is shown as a black line. A curve is displayed for the half-bit criterion in addition to lines showing the 0.143 gold standard cut-off and 0.5 cut-off.

8.1 FSC [i](#)

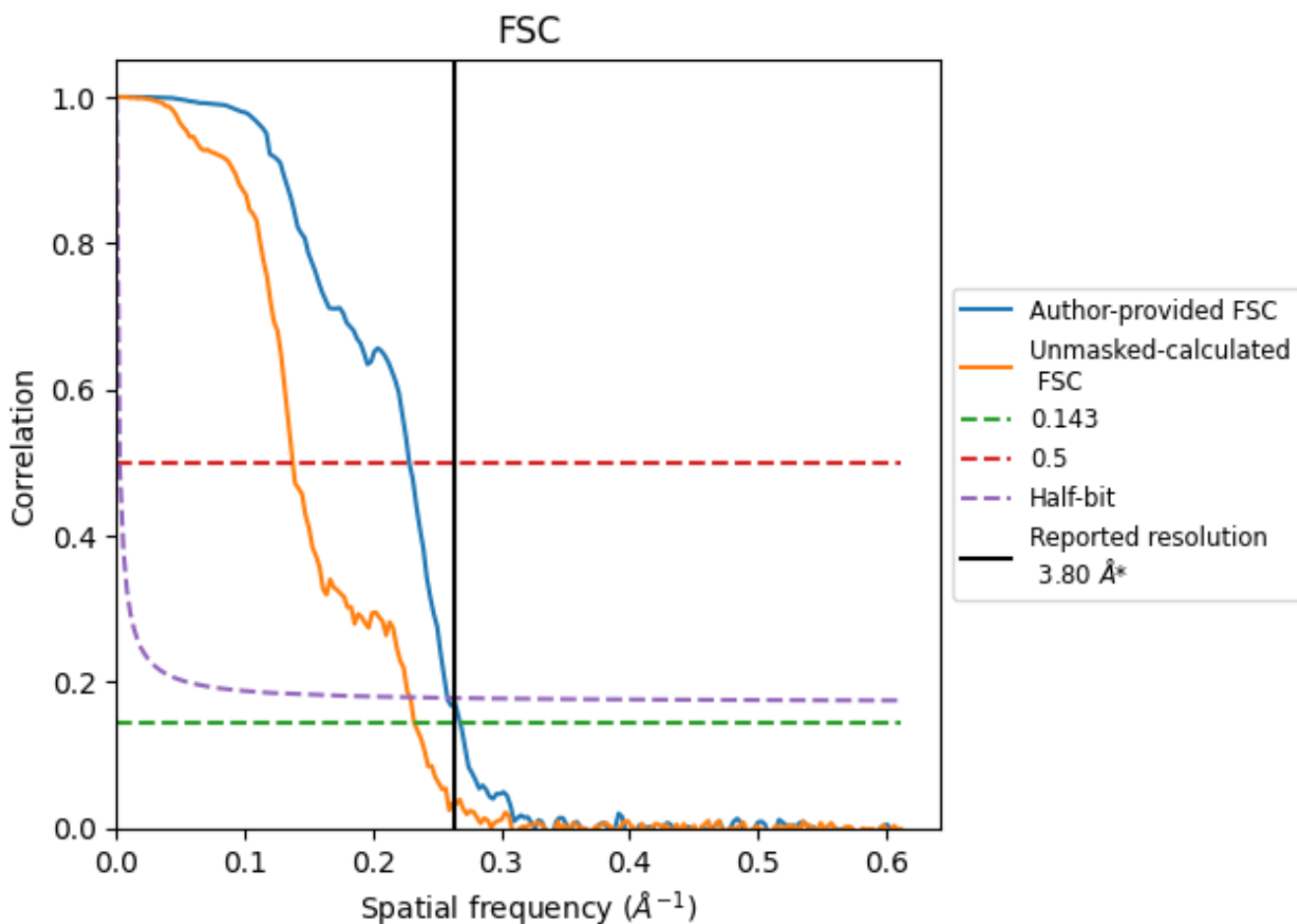

*Reported resolution corresponds to spatial frequency of 0.263\AA^{-1}

8.2 Resolution estimates [i](#)

Resolution estimate (Å)	Estimation criterion (FSC cut-off)		
	0.143	0.5	Half-bit
Reported by author	3.80	-	-
Author-provided FSC curve	3.73	4.38	3.87
Unmasked-calculated*	4.30	7.27	4.37

*Resolution estimate based on FSC curve calculated by comparison of deposited half-maps. The value from deposited half-maps intersecting FSC 0.143 CUT-OFF 4.30 differs from the reported value 3.8 by more than 10 %

9 Map-model fit [i](#)

This section contains information regarding the fit between EMDB map EMD-13130 and PDB model 7OZO. Per-residue inclusion information can be found in section 3 on page 7.

9.1 Map-model overlay [i](#)

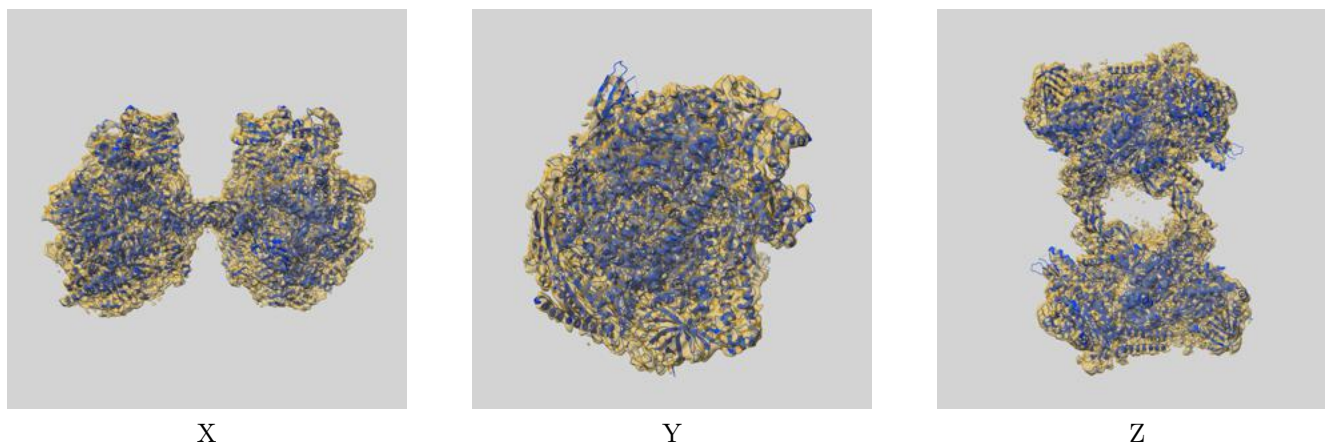

The images above show the 3D surface view of the map at the recommended contour level 5.0 at 50% transparency in yellow overlaid with a ribbon representation of the model coloured in blue. These images allow for the visual assessment of the quality of fit between the atomic model and the map.

9.2 Atom inclusion [i](#)

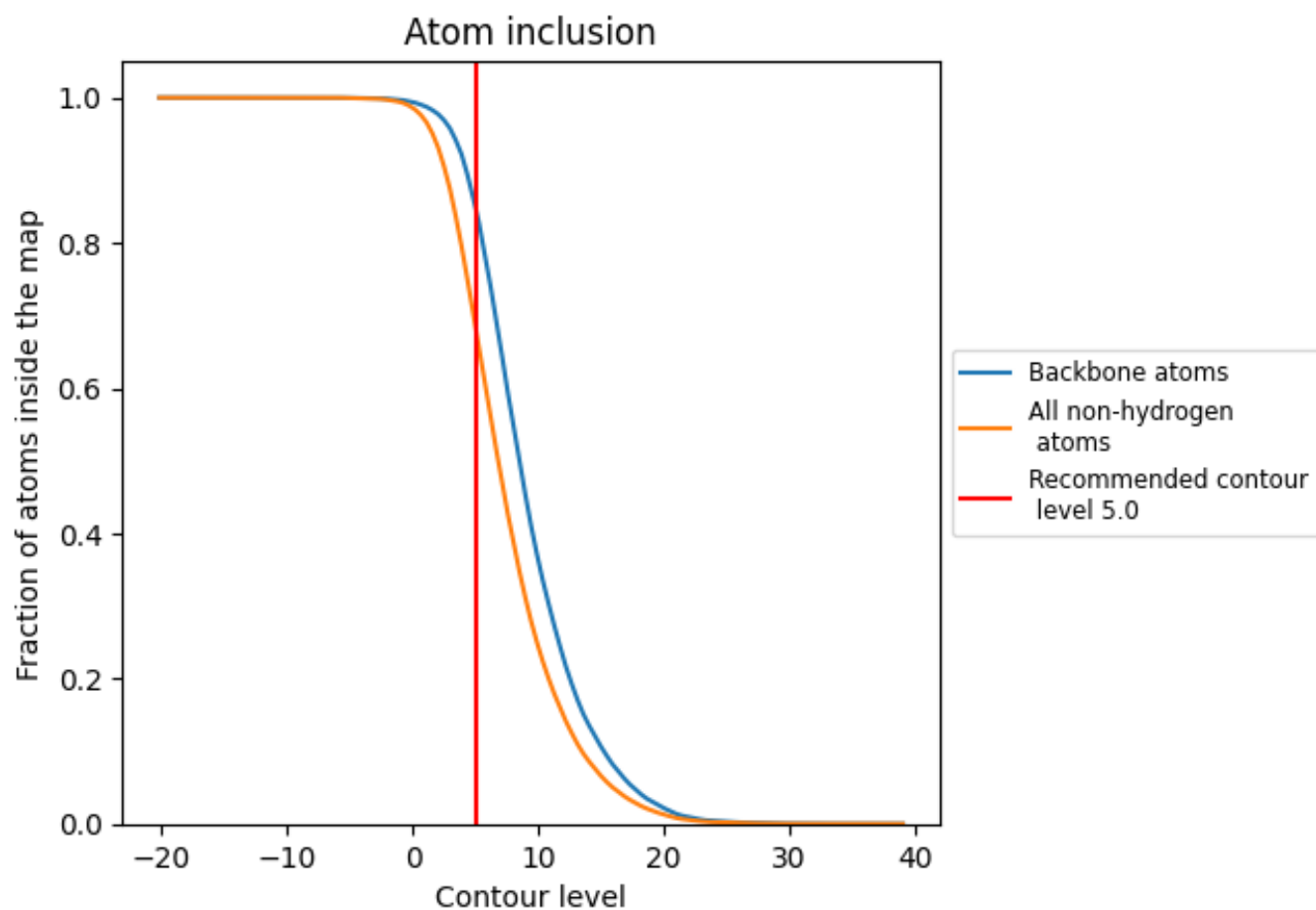

At the recommended contour level, 85% of all backbone atoms, 69% of all non-hydrogen atoms, are inside the map.