



wwPDB EM Validation Summary Report ⓘ

Jan 27, 2022 – 06:37 pm GMT

PDB ID : 7P30
EMDB ID : EMD-13176
Title : 3.0 Å resolution structure of a DNA-loaded MCM double hexamer
Authors : Greiwe, J.F.; Miller, T.C.R.; Martino, F.; Costa, A.
Deposited on : 2021-07-06
Resolution : 3.00 Å (reported)
Based on initial models : 5BK4, 6F0L, 6EYC

This is a wwPDB EM Validation Summary Report for a publicly released PDB entry.

We welcome your comments at validation@mail.wwpdb.org

A user guide is available at

<https://www.wwpdb.org/validation/2017/EMValidationReportHelp>

with specific help available everywhere you see the ⓘ symbol.

The following versions of software and data (see [references ⓘ](#)) were used in the production of this report:

EMDB validation analysis : 0.0.0.dev97
Mogul : 1.8.4, CSD as541be (2020)
MolProbity : 4.02b-467
buster-report : 1.1.7 (2018)
Percentile statistics : 20191225.v01 (using entries in the PDB archive December 25th 2019)
Ideal geometry (proteins) : Engh & Huber (2001)
Ideal geometry (DNA, RNA) : Parkinson et al. (1996)
Validation Pipeline (wwPDB-VP) : 2.26

1 Overall quality at a glance

The following experimental techniques were used to determine the structure:

ELECTRON MICROSCOPY

The reported resolution of this entry is 3.00 Å.

Percentile scores (ranging between 0-100) for global validation metrics of the entry are shown in the following graphic. The table shows the number of entries on which the scores are based.

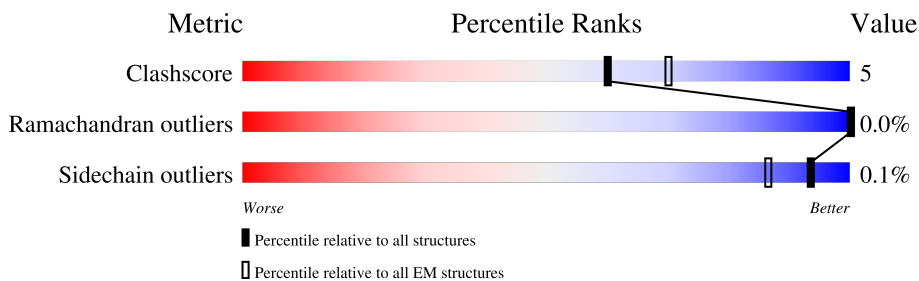

Metric	Whole archive (#Entries)	EM structures (#Entries)
Clashscore	158937	4297
Ramachandran outliers	154571	4023
Sidechain outliers	154315	3826

The table below summarises the geometric issues observed across the polymeric chains and their fit to the map. The red, orange, yellow and green segments of the bar indicate the fraction of residues that contain outliers for ≥ 3 , 2, 1 and 0 types of geometric quality criteria respectively. A grey segment represents the fraction of residues that are not modelled. The numeric value for each fraction is indicated below the corresponding segment, with a dot representing fractions $\leq 5\%$. The upper red bar (where present) indicates the fraction of residues that have poor fit to the EM map (all-atom inclusion $< 40\%$). The numeric value is given above the bar.

Mol	Chain	Length	Quality of chain
1	2	868	
1	A	868	
2	3	1006	
2	B	1006	
3	4	933	
3	C	933	
4	5	775	
4	D	775	

Continued on next page...

Continued from previous page...

Mol	Chain	Length	Quality of chain
5	6	1017	
5	E	1017	
6	7	845	
6	F	845	
7	X	53	
8	Y	53	

2 Entry composition [i](#)

There are 12 unique types of molecules in this entry. The entry contains 123819 atoms, of which 61072 are hydrogens and 0 are deuteriums.

In the tables below, the AltConf column contains the number of residues with at least one atom in alternate conformation and the Trace column contains the number of residues modelled with at most 2 atoms.

- Molecule 1 is a protein called DNA replication licensing factor MCM2.

Mol	Chain	Residues	Atoms					AltConf	Trace	
			Total	C	H	N	O			S
1	2	623	9918	3109	4986	877	927	19	0	0
1	A	623	9918	3109	4986	877	927	19	0	0

- Molecule 2 is a protein called DNA replication licensing factor MCM3.

Mol	Chain	Residues	Atoms					AltConf	Trace	
			Total	C	H	N	O			S
2	3	595	9381	2930	4726	833	879	13	0	0
2	B	595	9381	2930	4726	833	879	13	0	0

There are 70 discrepancies between the modelled and reference sequences:

Chain	Residue	Modelled	Actual	Comment	Reference
3	-34	MET	-	initiating methionine	UNP P24279
3	-33	LYS	-	expression tag	UNP P24279
3	-32	ARG	-	expression tag	UNP P24279
3	-31	ARG	-	expression tag	UNP P24279
3	-30	TRP	-	expression tag	UNP P24279
3	-29	LYS	-	expression tag	UNP P24279
3	-28	LYS	-	expression tag	UNP P24279
3	-27	ASN	-	expression tag	UNP P24279
3	-26	PHE	-	expression tag	UNP P24279
3	-25	ILE	-	expression tag	UNP P24279
3	-24	ALA	-	expression tag	UNP P24279
3	-23	VAL	-	expression tag	UNP P24279
3	-22	SER	-	expression tag	UNP P24279
3	-21	ALA	-	expression tag	UNP P24279
3	-20	ALA	-	expression tag	UNP P24279
3	-19	ASN	-	expression tag	UNP P24279
3	-18	ARG	-	expression tag	UNP P24279

Continued on next page...

Continued from previous page...

Chain	Residue	Modelled	Actual	Comment	Reference
3	-17	PHE	-	expression tag	UNP P24279
3	-16	LYS	-	expression tag	UNP P24279
3	-15	LYS	-	expression tag	UNP P24279
3	-14	ILE	-	expression tag	UNP P24279
3	-13	SER	-	expression tag	UNP P24279
3	-12	SER	-	expression tag	UNP P24279
3	-11	SER	-	expression tag	UNP P24279
3	-10	GLY	-	expression tag	UNP P24279
3	-9	ALA	-	expression tag	UNP P24279
3	-8	LEU	-	expression tag	UNP P24279
3	-7	GLU	-	expression tag	UNP P24279
3	-6	ASN	-	expression tag	UNP P24279
3	-5	LEU	-	expression tag	UNP P24279
3	-4	TYR	-	expression tag	UNP P24279
3	-3	PHE	-	expression tag	UNP P24279
3	-2	GLN	-	expression tag	UNP P24279
3	-1	GLY	-	expression tag	UNP P24279
3	0	GLU	-	expression tag	UNP P24279
B	-34	MET	-	initiating methionine	UNP P24279
B	-33	LYS	-	expression tag	UNP P24279
B	-32	ARG	-	expression tag	UNP P24279
B	-31	ARG	-	expression tag	UNP P24279
B	-30	TRP	-	expression tag	UNP P24279
B	-29	LYS	-	expression tag	UNP P24279
B	-28	LYS	-	expression tag	UNP P24279
B	-27	ASN	-	expression tag	UNP P24279
B	-26	PHE	-	expression tag	UNP P24279
B	-25	ILE	-	expression tag	UNP P24279
B	-24	ALA	-	expression tag	UNP P24279
B	-23	VAL	-	expression tag	UNP P24279
B	-22	SER	-	expression tag	UNP P24279
B	-21	ALA	-	expression tag	UNP P24279
B	-20	ALA	-	expression tag	UNP P24279
B	-19	ASN	-	expression tag	UNP P24279
B	-18	ARG	-	expression tag	UNP P24279
B	-17	PHE	-	expression tag	UNP P24279
B	-16	LYS	-	expression tag	UNP P24279
B	-15	LYS	-	expression tag	UNP P24279
B	-14	ILE	-	expression tag	UNP P24279
B	-13	SER	-	expression tag	UNP P24279
B	-12	SER	-	expression tag	UNP P24279
B	-11	SER	-	expression tag	UNP P24279

Continued on next page...

Continued from previous page...

Chain	Residue	Modelled	Actual	Comment	Reference
B	-10	GLY	-	expression tag	UNP P24279
B	-9	ALA	-	expression tag	UNP P24279
B	-8	LEU	-	expression tag	UNP P24279
B	-7	GLU	-	expression tag	UNP P24279
B	-6	ASN	-	expression tag	UNP P24279
B	-5	LEU	-	expression tag	UNP P24279
B	-4	TYR	-	expression tag	UNP P24279
B	-3	PHE	-	expression tag	UNP P24279
B	-2	GLN	-	expression tag	UNP P24279
B	-1	GLY	-	expression tag	UNP P24279
B	0	GLU	-	expression tag	UNP P24279

- Molecule 3 is a protein called DNA replication licensing factor MCM4.

Mol	Chain	Residues	Atoms						AltConf	Trace
			Total	C	H	N	O	S		
3	4	654	Total	C	H	N	O	S	0	0
			10452	3259	5256	896	1011	30		
3	C	654	Total	C	H	N	O	S	0	0
			10452	3259	5256	896	1011	30		

- Molecule 4 is a protein called Minichromosome maintenance protein 5.

Mol	Chain	Residues	Atoms						AltConf	Trace
			Total	C	H	N	O	S		
4	5	652	Total	C	H	N	O	S	0	0
			10253	3198	5150	873	1007	25		
4	D	652	Total	C	H	N	O	S	0	0
			10251	3198	5148	873	1007	25		

- Molecule 5 is a protein called DNA replication licensing factor MCM6.

Mol	Chain	Residues	Atoms						AltConf	Trace
			Total	C	H	N	O	S		
5	6	609	Total	C	H	N	O	S	0	0
			9681	3041	4862	840	913	25		
5	E	609	Total	C	H	N	O	S	0	0
			9681	3041	4862	840	913	25		

- Molecule 6 is a protein called DNA replication licensing factor MCM7.

Mol	Chain	Residues	Atoms						AltConf	Trace
			Total	C	H	N	O	S		
6	7	689	Total	C	H	N	O	S	0	0
			10935	3421	5502	942	1041	29		

Continued on next page...

Continued from previous page...

Mol	Chain	Residues	Atoms						AltConf	Trace
			Total	C	H	N	O	S		
6	F	689	10935	3421	5502	942	1041	29	0	0

- Molecule 7 is a DNA chain called DNA (53-MER).

Mol	Chain	Residues	Atoms					AltConf	Trace
			Total	C	N	O	P		
7	X	53	1086	515	199	319	53	0	0

- Molecule 8 is a DNA chain called DNA (53-MER).

Mol	Chain	Residues	Atoms					AltConf	Trace
			Total	C	N	O	P		
8	Y	53	1087	515	202	317	53	0	0

- Molecule 9 is ADENOSINE-5'-TRIPHOSPHATE (three-letter code: ATP) (formula: $C_{10}H_{16}N_5O_{13}P_3$).

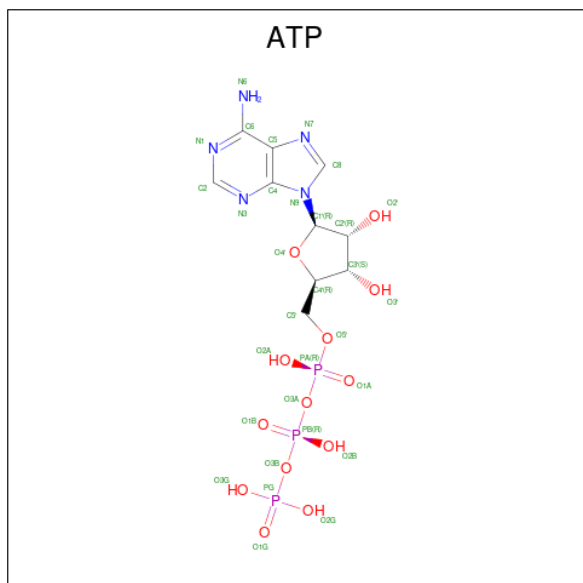

Mol	Chain	Residues	Atoms						AltConf
			Total	C	H	N	O	P	
9	2	1	42	10	11	5	13	3	0
9	A	1	42	10	11	5	13	3	0

- Molecule 10 is MAGNESIUM ION (three-letter code: MG) (formula: Mg).

Mol	Chain	Residues	Atoms	AltConf
10	2	1	Total Mg 1 1	0
10	3	1	Total Mg 1 1	0
10	5	1	Total Mg 1 1	0
10	7	2	Total Mg 2 2	0
10	A	1	Total Mg 1 1	0
10	B	1	Total Mg 1 1	0
10	D	1	Total Mg 1 1	0
10	F	2	Total Mg 2 2	0

- Molecule 11 is ZINC ION (three-letter code: ZN) (formula: Zn).

Mol	Chain	Residues	Atoms	AltConf
11	2	1	Total Zn 1 1	0
11	4	1	Total Zn 1 1	0
11	5	1	Total Zn 1 1	0
11	6	1	Total Zn 1 1	0
11	7	1	Total Zn 1 1	0
11	A	1	Total Zn 1 1	0
11	C	1	Total Zn 1 1	0
11	D	1	Total Zn 1 1	0
11	E	1	Total Zn 1 1	0
11	F	1	Total Zn 1 1	0

- Molecule 12 is ADENOSINE-5'-DIPHOSPHATE (three-letter code: ADP) (formula: $C_{10}H_{15}N_5O_{10}P_2$).



Mol	Chain	Residues	Atoms					AltConf	
			Total	C	H	N	O		P
12	3	1	Total 38	C 10	H 11	N 5	O 10	P 2	0
12	4	1	Total 38	C 10	H 11	N 5	O 10	P 2	0
12	5	1	Total 38	C 10	H 11	N 5	O 10	P 2	0
12	7	1	Total 38	C 10	H 11	N 5	O 10	P 2	0
12	B	1	Total 38	C 10	H 11	N 5	O 10	P 2	0
12	C	1	Total 38	C 10	H 11	N 5	O 10	P 2	0
12	D	1	Total 38	C 10	H 11	N 5	O 10	P 2	0
12	F	1	Total 38	C 10	H 11	N 5	O 10	P 2	0

3 Residue-property plots

These plots are drawn for all protein, RNA, DNA and oligosaccharide chains in the entry. The first graphic for a chain summarises the proportions of the various outlier classes displayed in the second graphic. The second graphic shows the sequence view annotated by issues in geometry and atom inclusion in map density. Residues are color-coded according to the number of geometric quality criteria for which they contain at least one outlier: green = 0, yellow = 1, orange = 2 and red = 3 or more. A red diamond above a residue indicates a poor fit to the EM map for this residue (all-atom inclusion < 40%). Stretches of 2 or more consecutive residues without any outlier are shown as a green connector. Residues present in the sample, but not in the model, are shown in grey.

- Molecule 1: DNA replication licensing factor MCM2

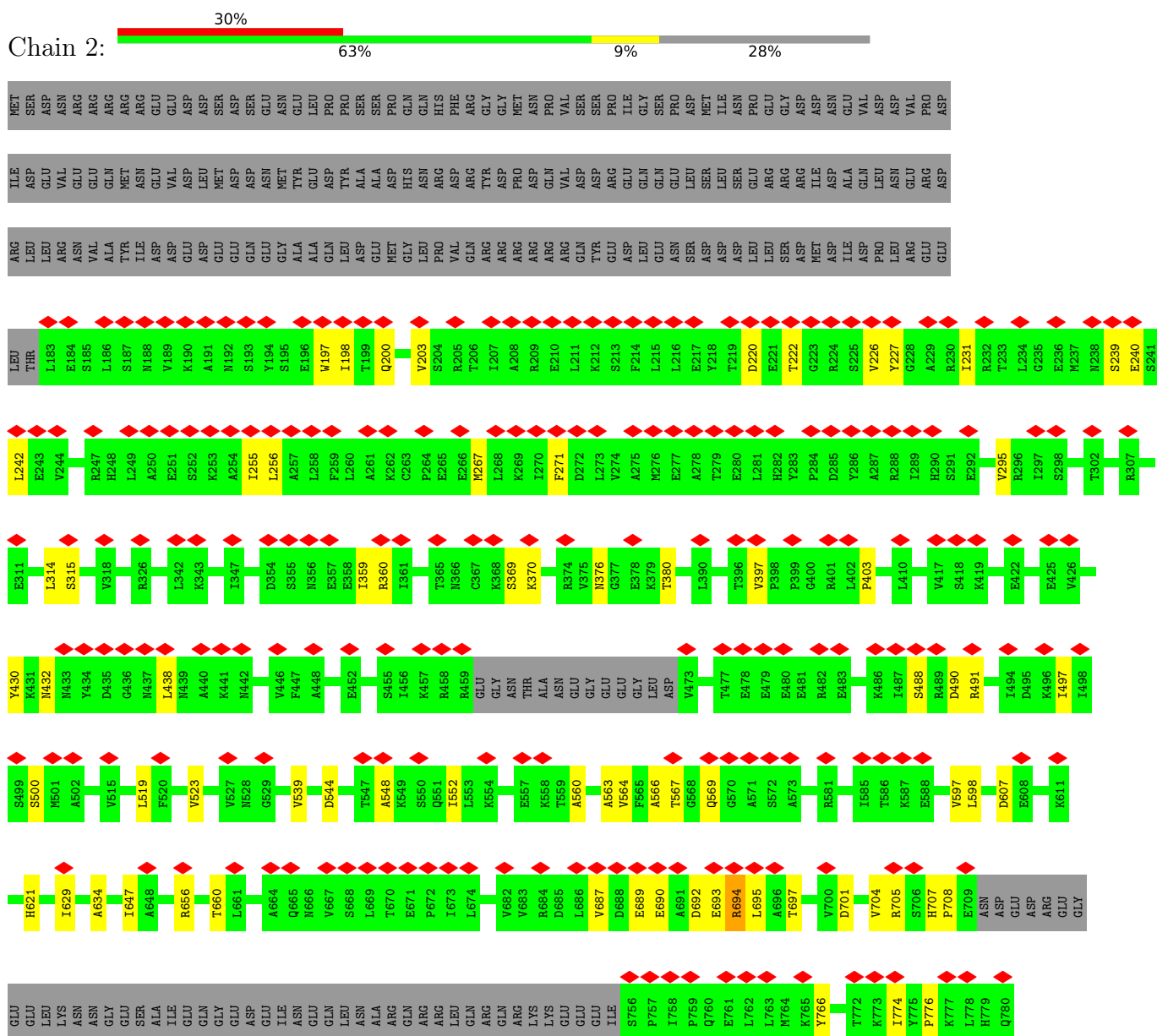

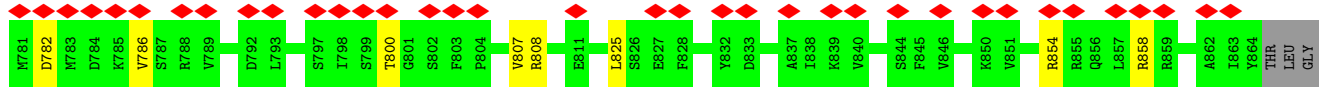

HIS

• Molecule 1: DNA replication licensing factor MCM2

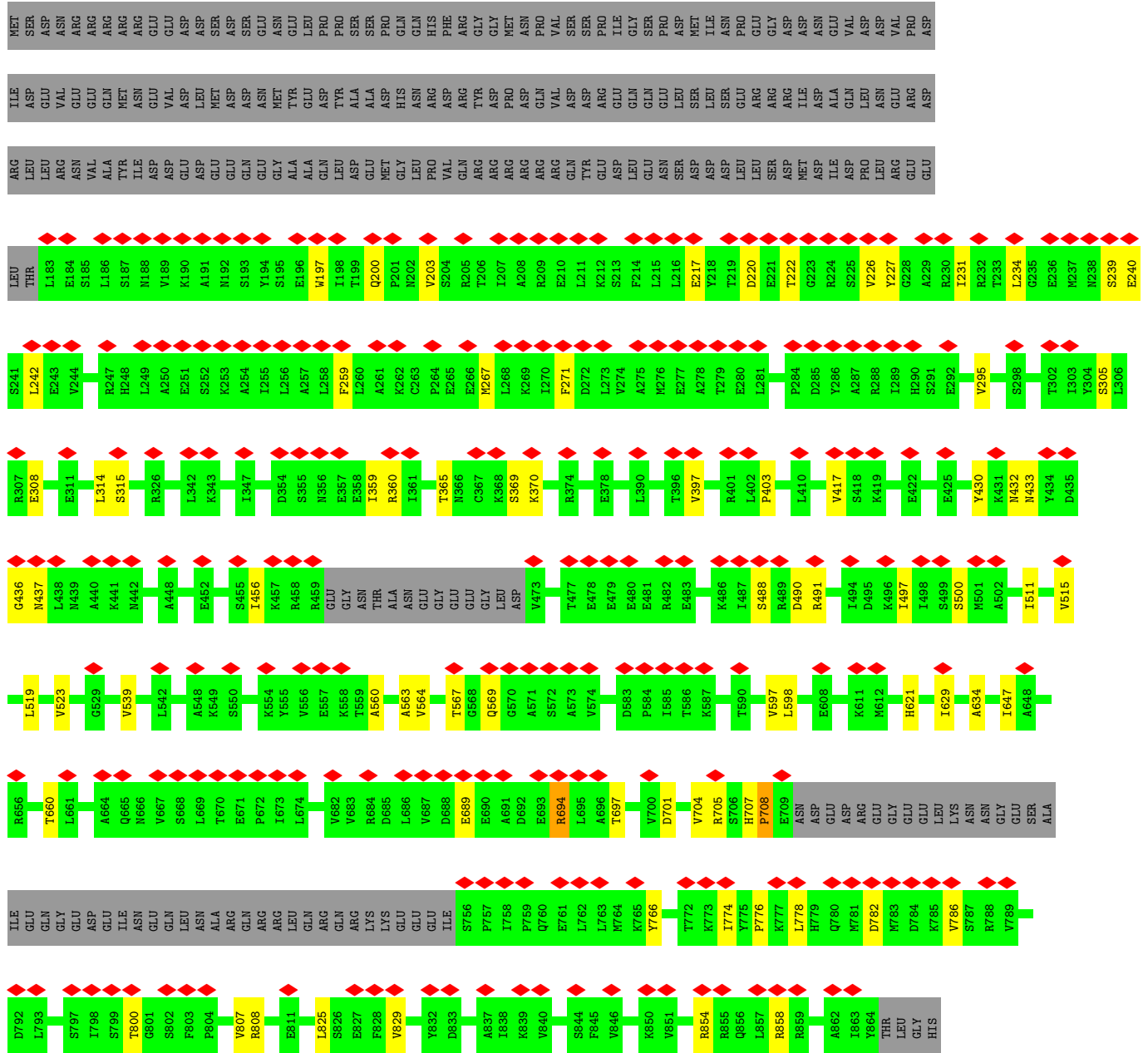

• Molecule 2: DNA replication licensing factor MCM3



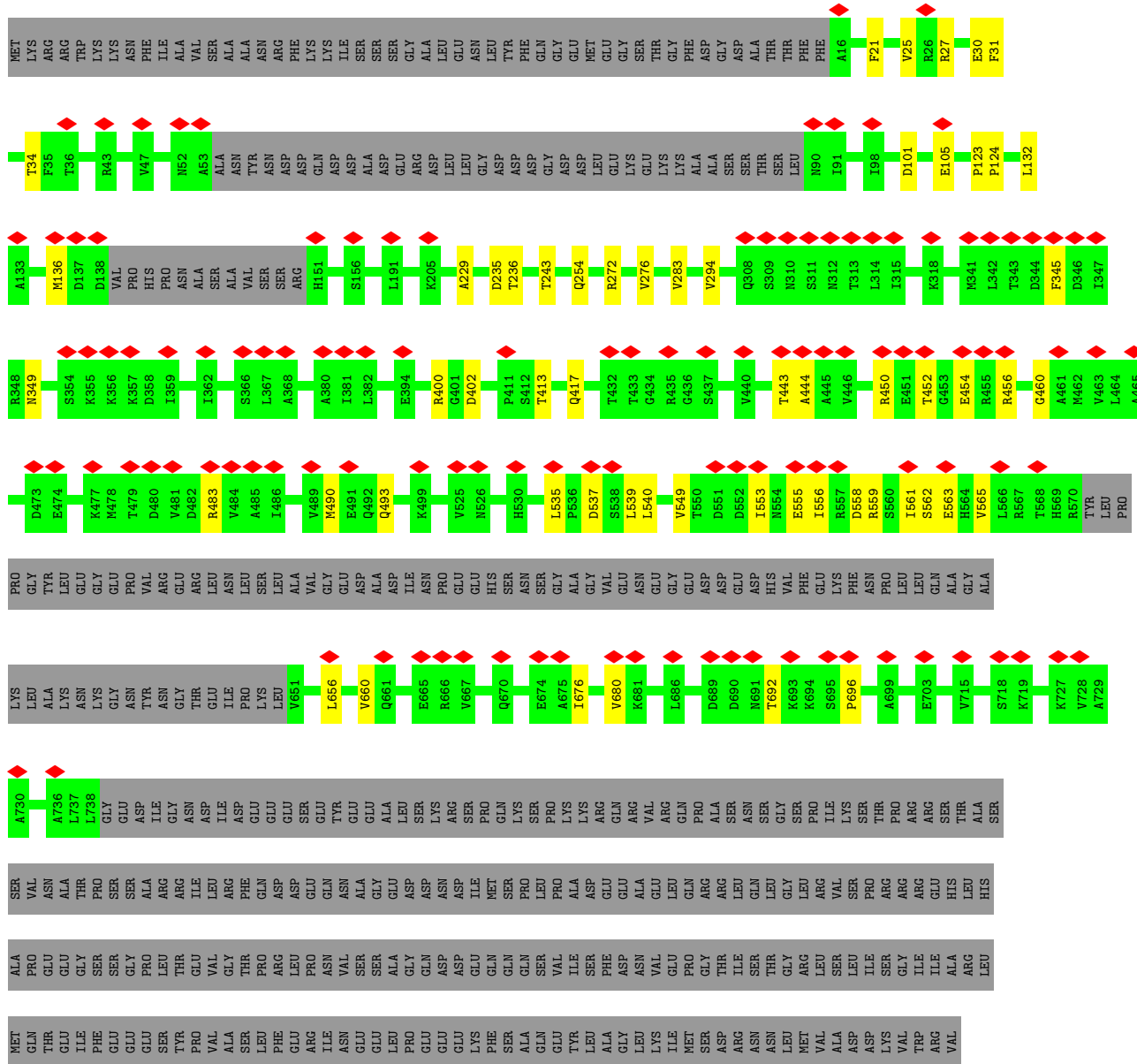

● Molecule 2: DNA replication licensing factor MCM3

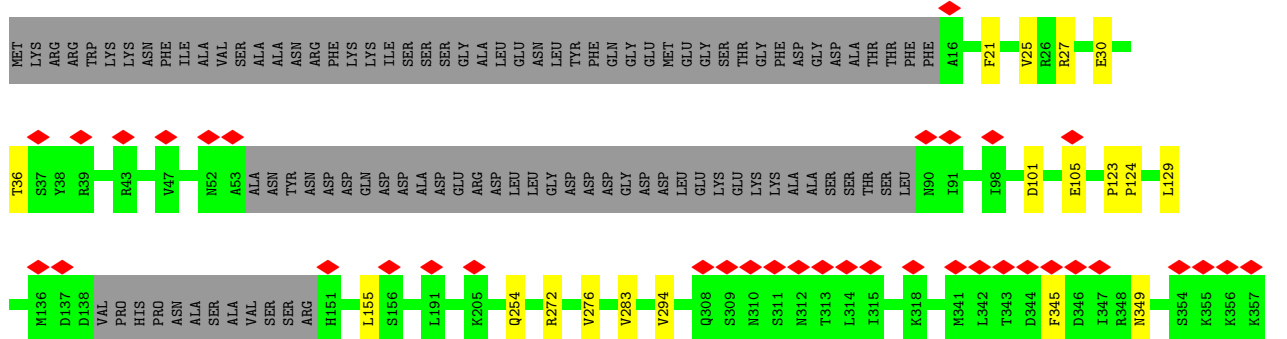

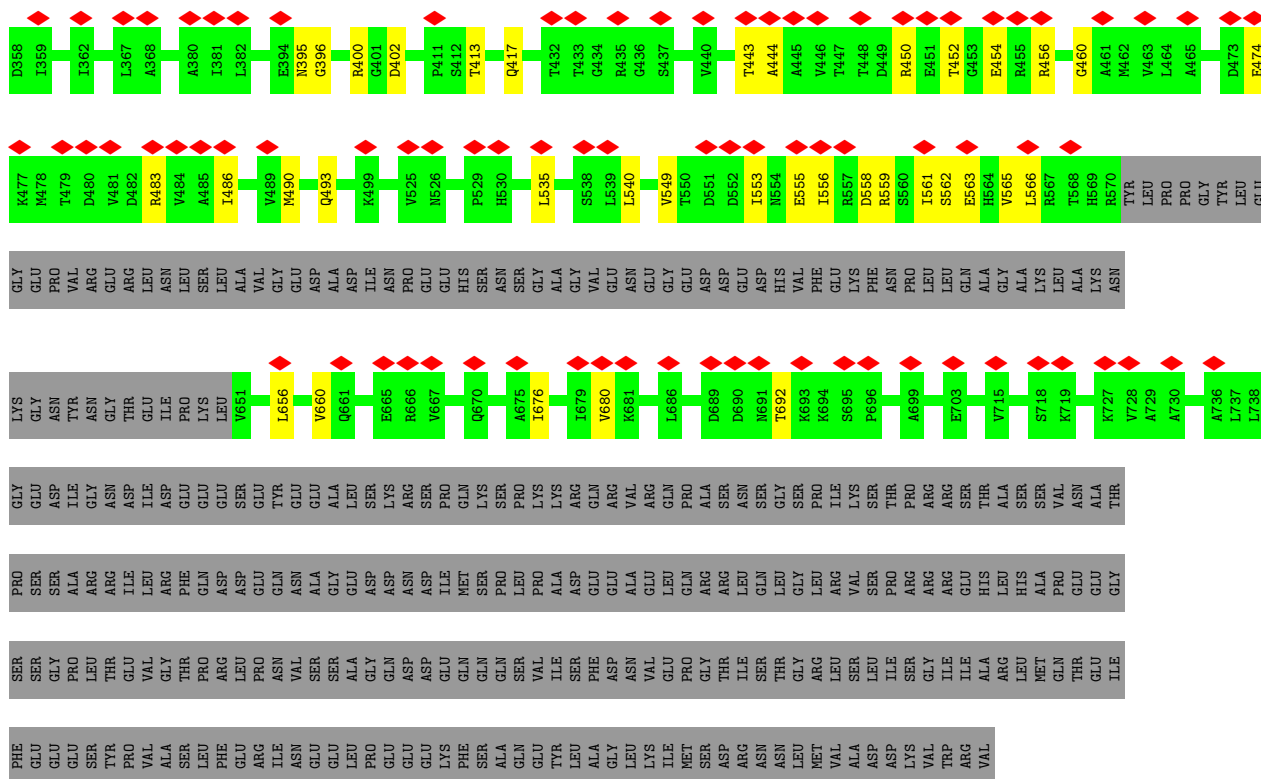

• Molecule 3: DNA replication licensing factor MCM4

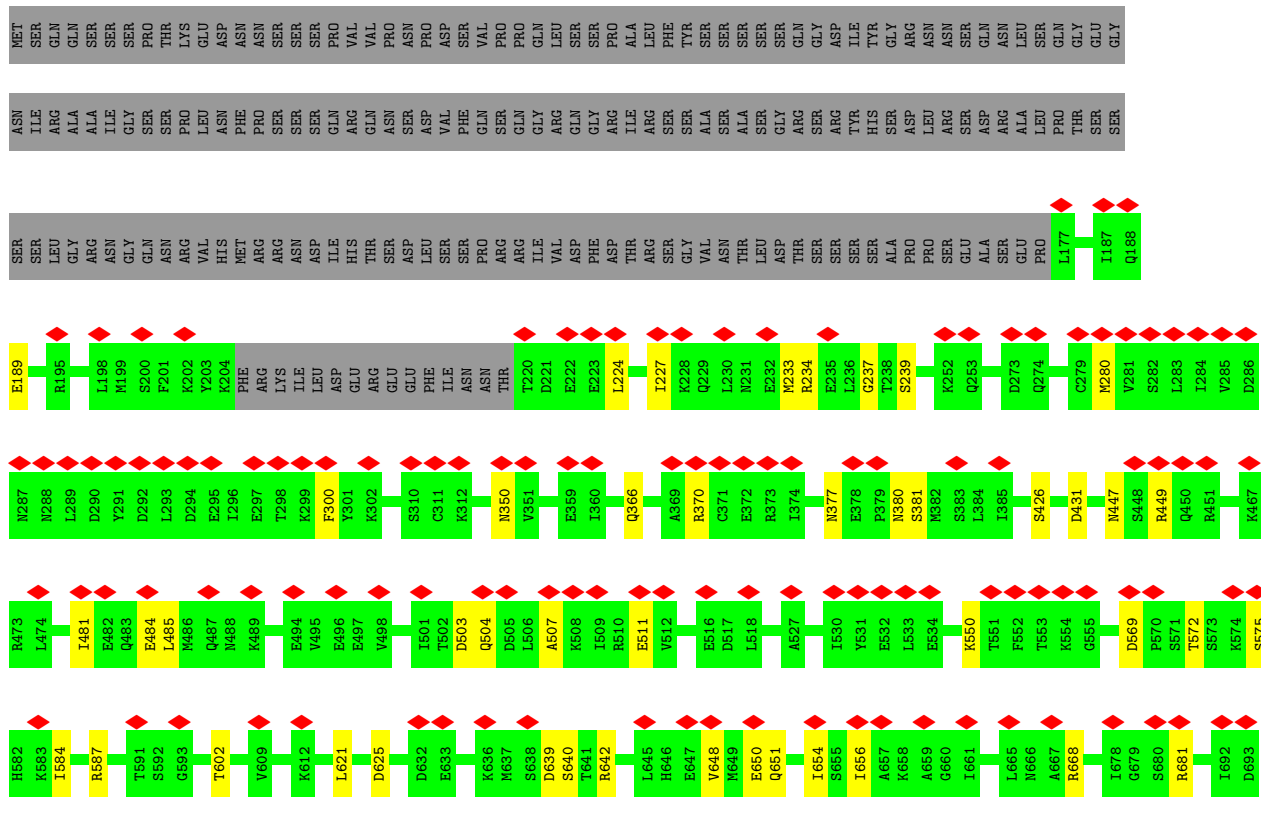

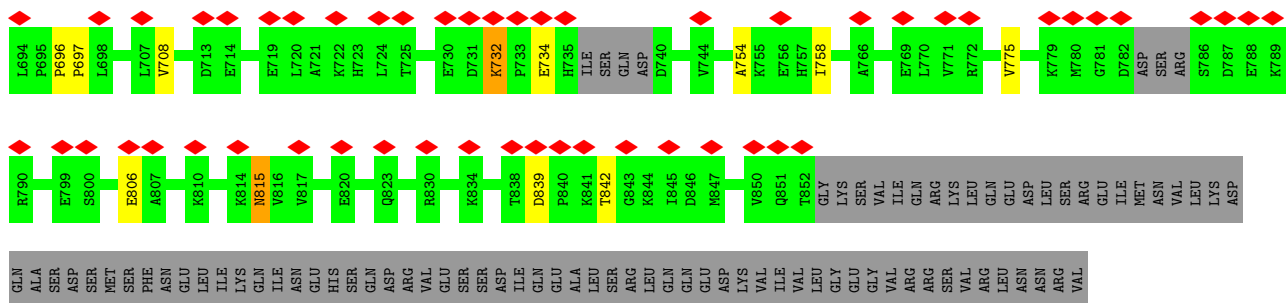

● Molecule 3: DNA replication licensing factor MCM4

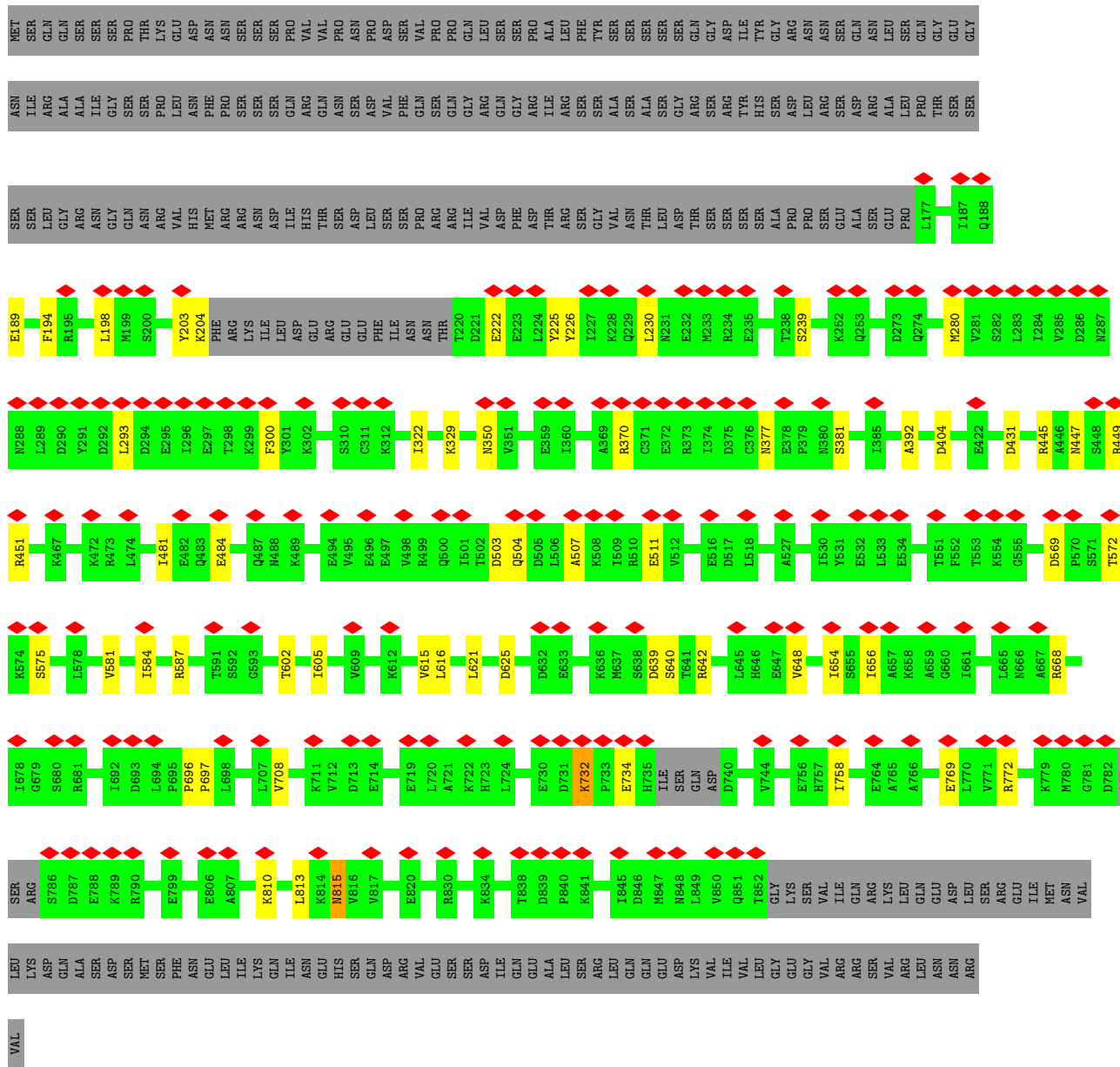

● Molecule 4: Minichromosome maintenance protein 5

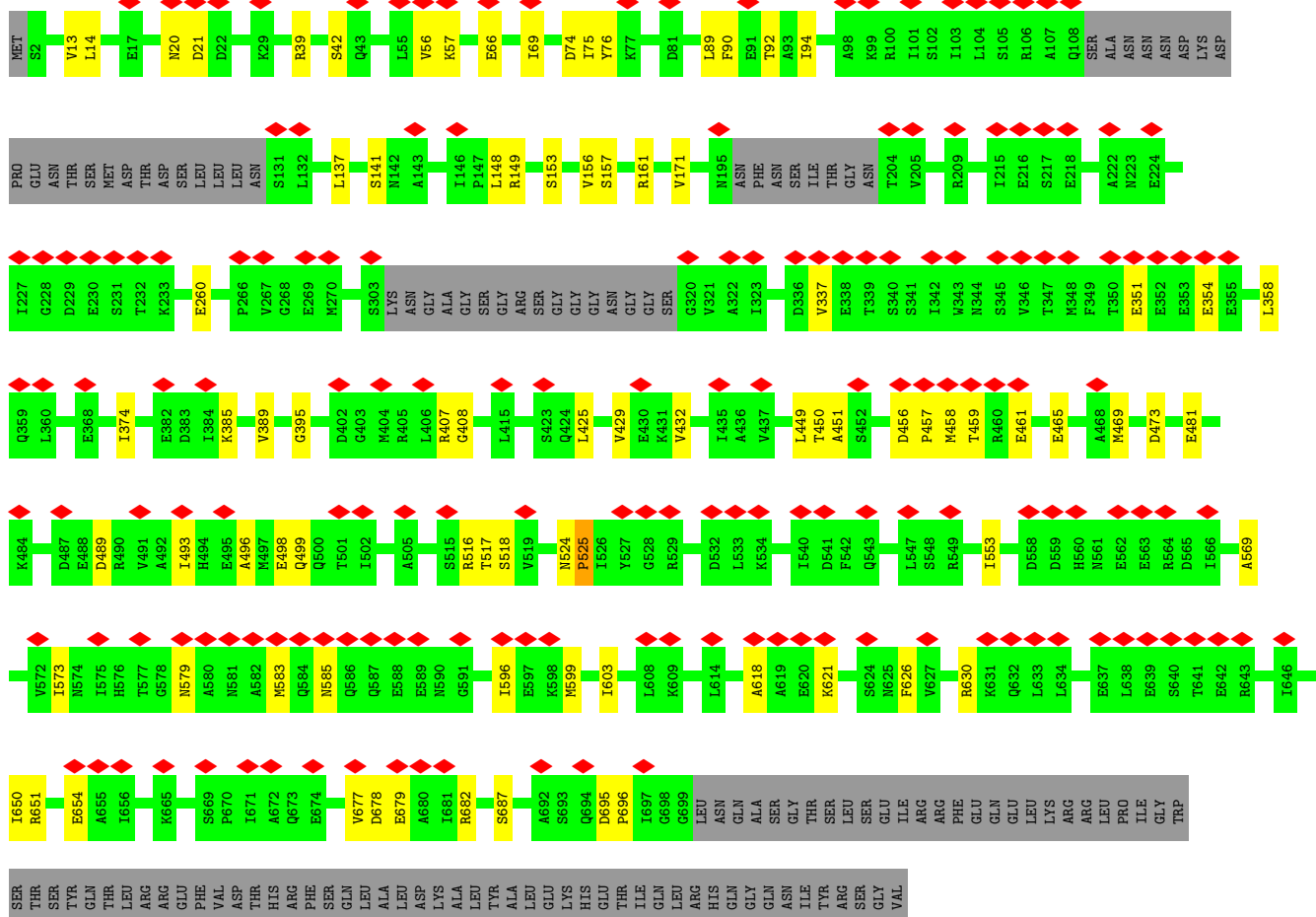
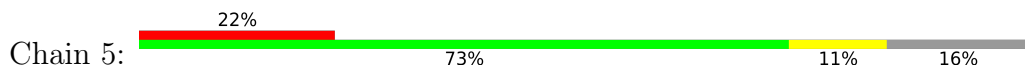

• Molecule 4: Minichromosome maintenance protein 5

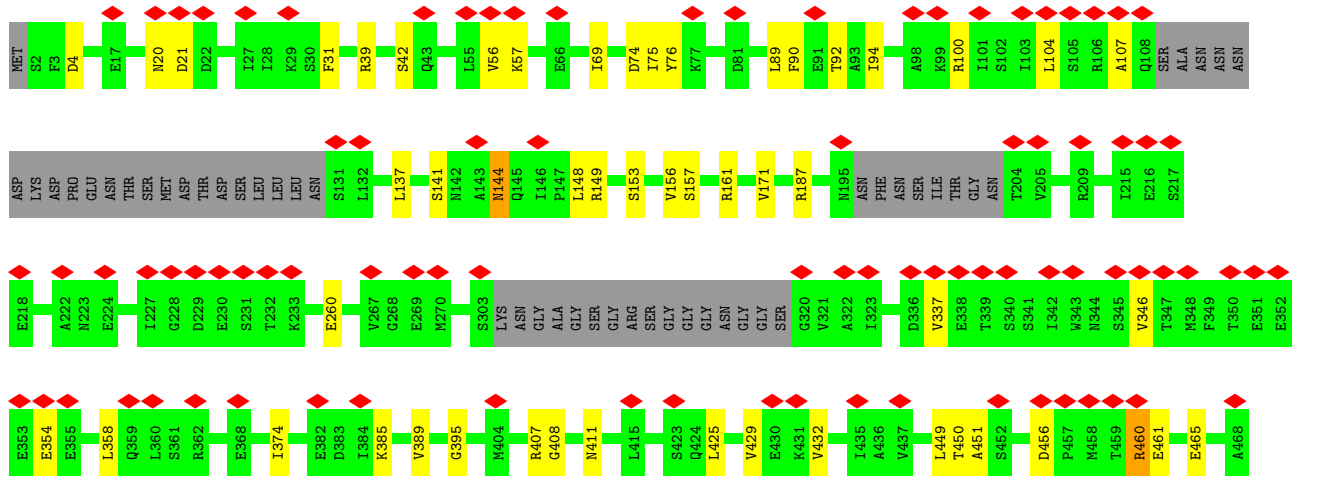
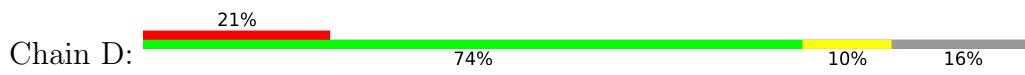

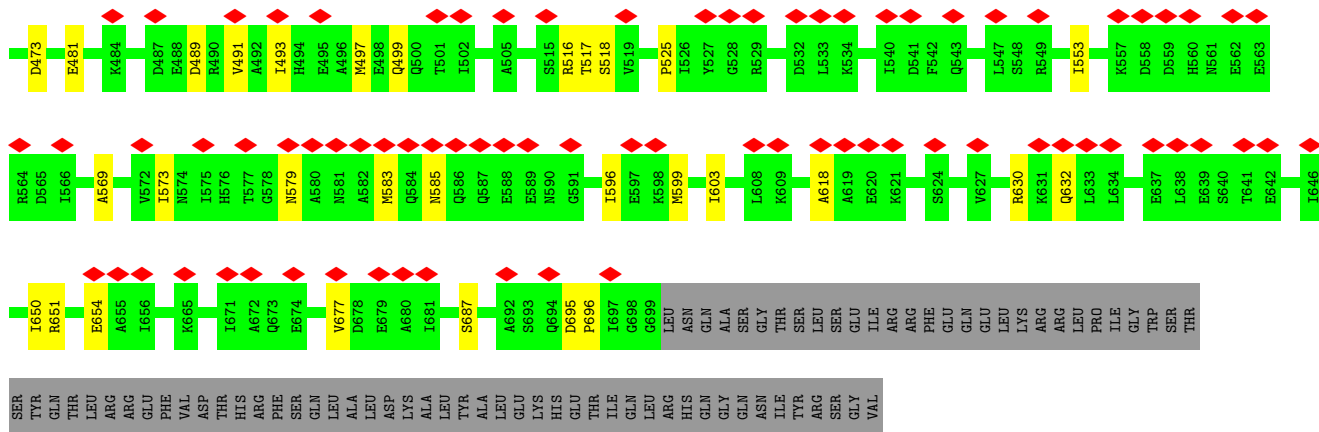

● Molecule 5: DNA replication licensing factor MCM6

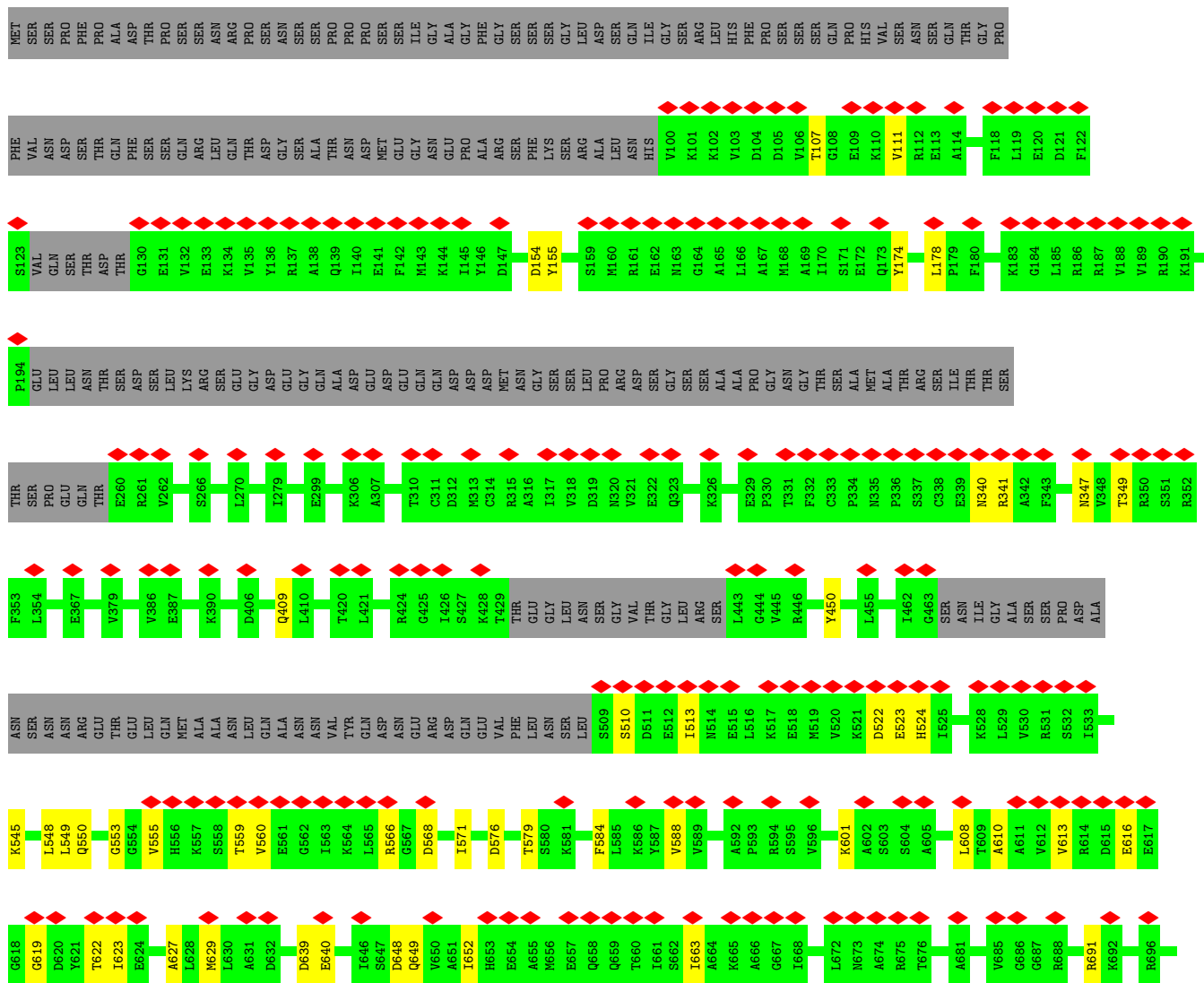

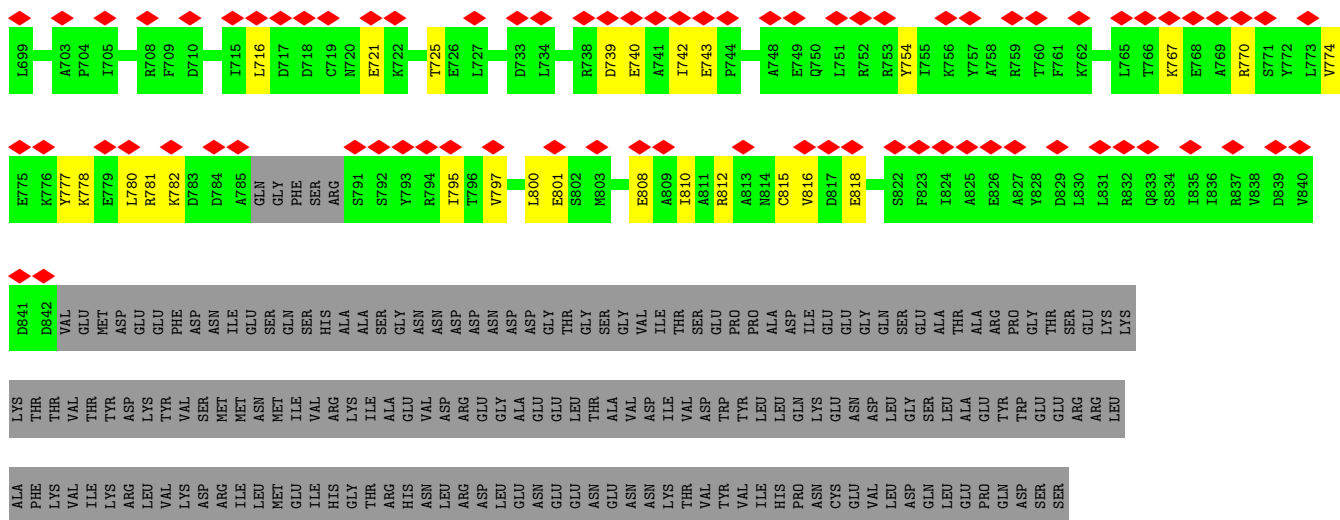

● Molecule 5: DNA replication licensing factor MCM6

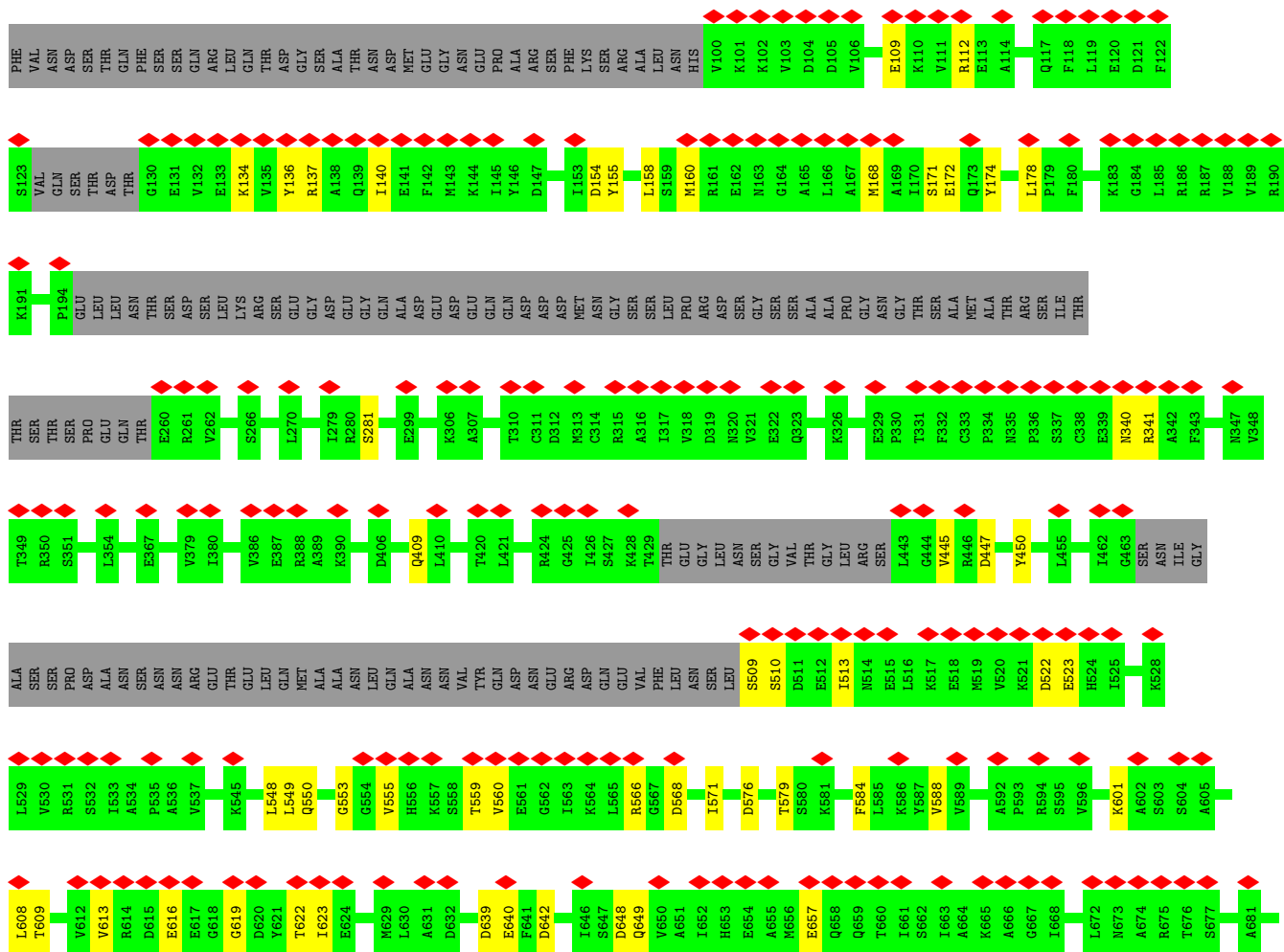
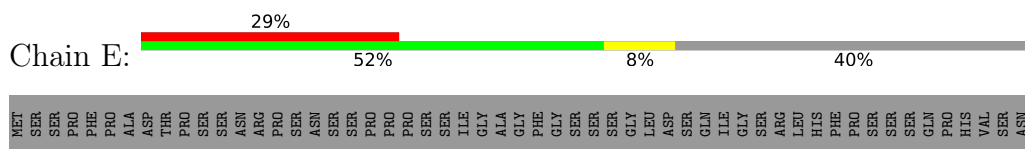

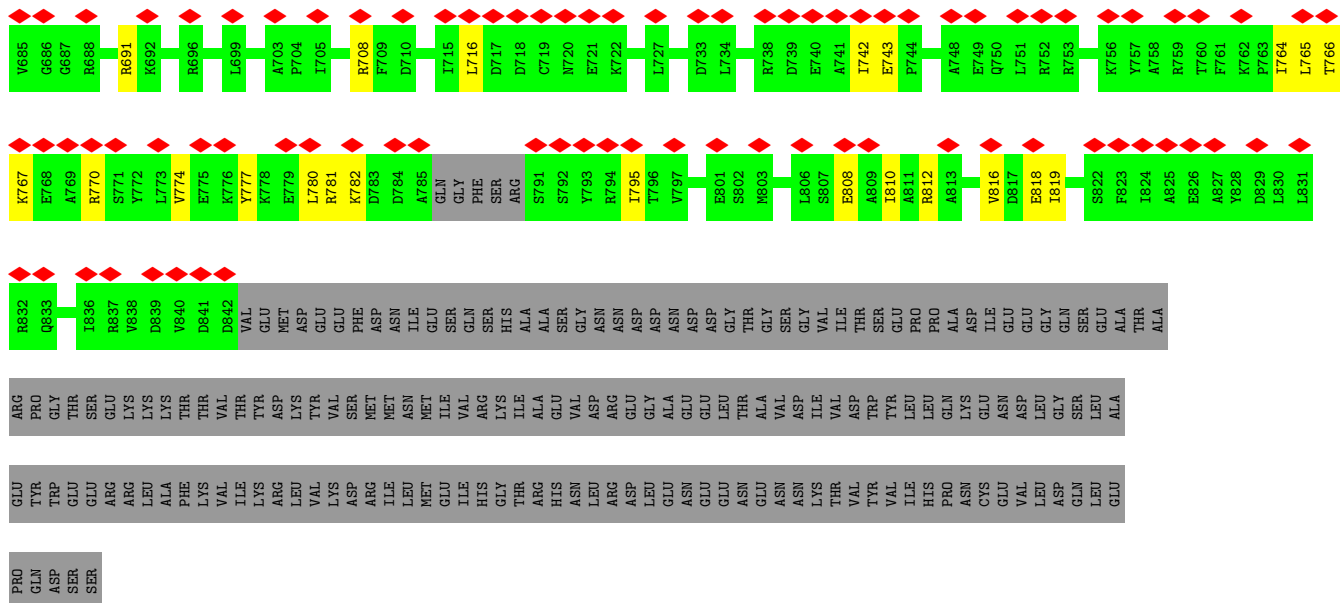

• Molecule 6: DNA replication licensing factor MCM7

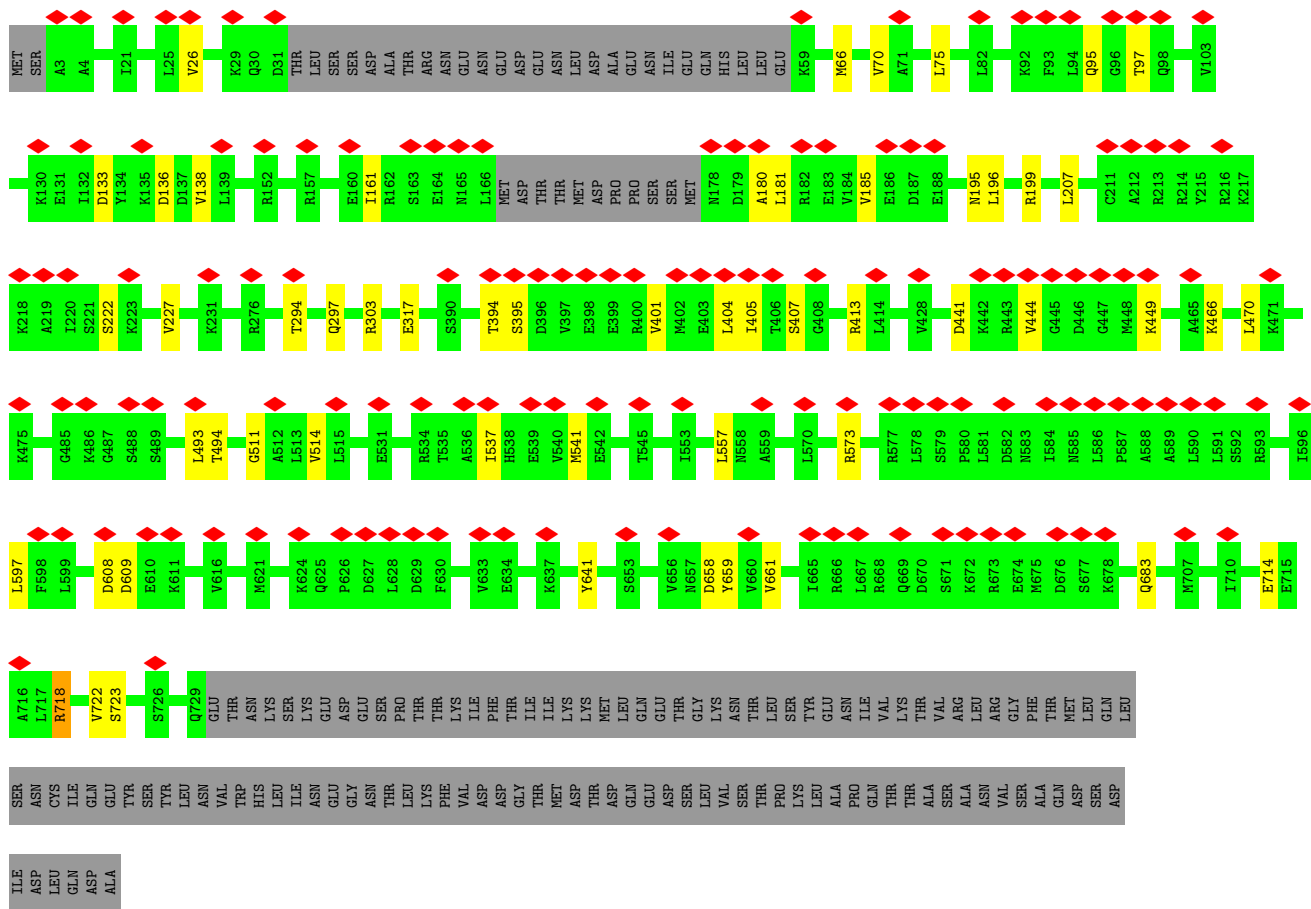
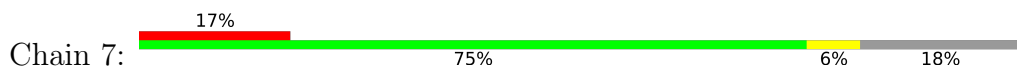

• Molecule 6: DNA replication licensing factor MCM7

4 Experimental information

Property	Value	Source
EM reconstruction method	SINGLE PARTICLE	Depositor
Imposed symmetry	POINT, C2	Depositor
Number of particles used	238620	Depositor
Resolution determination method	FSC 0.143 CUT-OFF	Depositor
CTF correction method	PHASE FLIPPING AND AMPLITUDE CORRECTION	Depositor
Microscope	FEI TITAN KRIOS	Depositor
Voltage (kV)	300	Depositor
Electron dose ($e^-/\text{\AA}^2$)	51.3	Depositor
Minimum defocus (nm)	2000	Depositor
Maximum defocus (nm)	4100	Depositor
Magnification	130000	Depositor
Image detector	GATAN K2 SUMMIT (4k x 4k)	Depositor
Maximum map value	2.081	Depositor
Minimum map value	-1.358	Depositor
Average map value	-0.000	Depositor
Map value standard deviation	0.074	Depositor
Recommended contour level	0.2	Depositor
Map size (Å)	276.48, 276.48, 276.48	wwPDB
Map dimensions	256, 256, 256	wwPDB
Map angles (°)	90.0, 90.0, 90.0	wwPDB
Pixel spacing (Å)	1.08, 1.08, 1.08	Depositor

5 Model quality i

5.1 Standard geometry i

Bond lengths and bond angles in the following residue types are not validated in this section: ADP, ATP, MG, ZN

The Z score for a bond length (or angle) is the number of standard deviations the observed value is removed from the expected value. A bond length (or angle) with $|Z| > 5$ is considered an outlier worth inspection. RMSZ is the root-mean-square of all Z scores of the bond lengths (or angles).

Mol	Chain	Bond lengths		Bond angles	
		RMSZ	# $ Z > 5$	RMSZ	# $ Z > 5$
1	2	0.24	0/5019	0.51	0/6781
1	A	0.26	1/5019 (0.0%)	0.53	2/6781 (0.0%)
2	3	0.24	0/4733	0.51	0/6417
2	B	0.24	0/4733	0.51	0/6417
3	4	0.24	0/5270	0.50	0/7123
3	C	0.24	0/5270	0.49	0/7123
4	5	0.32	2/5176 (0.0%)	0.56	3/7000 (0.0%)
4	D	0.29	1/5176 (0.0%)	0.55	3/7000 (0.0%)
5	6	0.24	0/4896	0.52	0/6601
5	E	0.24	0/4896	0.52	0/6601
6	7	0.24	0/5516	0.50	0/7454
6	F	0.24	0/5516	0.50	0/7454
7	X	0.45	0/1217	0.87	0/1876
8	Y	0.48	0/1219	0.86	0/1879
All	All	0.27	4/63656 (0.0%)	0.54	8/86507 (0.0%)

All (4) bond length outliers are listed below:

Mol	Chain	Res	Type	Atoms	Z	Observed(Å)	Ideal(Å)
4	5	525	PRO	CG-CD	-13.78	1.05	1.50
4	D	525	PRO	CG-CD	-10.94	1.14	1.50
1	A	708	PRO	CG-CD	-6.17	1.30	1.50
4	5	525	PRO	N-CD	5.14	1.55	1.47

The worst 5 of 8 bond angle outliers are listed below:

Mol	Chain	Res	Type	Atoms	Z	Observed(°)	Ideal(°)
4	5	525	PRO	N-CD-CG	-14.59	81.31	103.20
4	D	525	PRO	N-CD-CG	-13.23	83.36	103.20
4	5	525	PRO	CA-N-CD	-9.80	97.78	111.50

Continued on next page...

Continued from previous page...

Mol	Chain	Res	Type	Atoms	Z	Observed(°)	Ideal(°)
1	A	708	PRO	N-CD-CG	-8.14	90.98	103.20
4	D	525	PRO	CA-N-CD	-7.92	100.42	111.50

There are no chirality outliers.

There are no planarity outliers.

5.2 Too-close contacts [i](#)

In the following table, the Non-H and H(model) columns list the number of non-hydrogen atoms and hydrogen atoms in the chain respectively. The H(added) column lists the number of hydrogen atoms added and optimized by MolProbity. The Clashes column lists the number of clashes within the asymmetric unit, whereas Symm-Clashes lists symmetry-related clashes.

Mol	Chain	Non-H	H(model)	H(added)	Clashes	Symm-Clashes
1	2	4932	4986	4984	62	0
1	A	4932	4986	4984	50	0
2	3	4655	4726	4723	38	0
2	B	4655	4726	4723	35	0
3	4	5196	5256	5254	37	0
3	C	5196	5256	5254	39	0
4	5	5103	5150	5147	59	0
4	D	5103	5148	5147	61	0
5	6	4819	4862	4856	49	0
5	E	4819	4862	4856	48	0
6	7	5433	5502	5500	37	0
6	F	5433	5502	5500	26	0
7	X	1086	0	596	41	0
8	Y	1087	0	595	43	0
9	2	31	11	12	0	0
9	A	31	11	12	0	0
10	2	1	0	0	0	0
10	3	1	0	0	0	0
10	5	1	0	0	0	0
10	7	2	0	0	0	0
10	A	1	0	0	0	0
10	B	1	0	0	0	0
10	D	1	0	0	0	0
10	F	2	0	0	0	0
11	2	1	0	0	0	0
11	4	1	0	0	0	0
11	5	1	0	0	0	0

Continued on next page...

Continued from previous page...

Mol	Chain	Non-H	H(model)	H(added)	Clashes	Symm-Clashes
11	6	1	0	0	0	0
11	7	1	0	0	0	0
11	A	1	0	0	0	0
11	C	1	0	0	0	0
11	D	1	0	0	0	0
11	E	1	0	0	0	0
11	F	1	0	0	0	0
12	3	27	11	12	1	0
12	4	27	11	12	1	0
12	5	27	11	12	2	0
12	7	27	11	12	0	0
12	B	27	11	12	1	0
12	C	27	11	12	1	0
12	D	27	11	12	2	0
12	F	27	11	12	0	0
All	All	62747	61072	62239	591	0

The all-atom clashscore is defined as the number of clashes found per 1000 atoms (including hydrogen atoms). The all-atom clashscore for this structure is 5.

The worst 5 of 591 close contacts within the same asymmetric unit are listed below, sorted by their clash magnitude.

Atom-1	Atom-2	Interatomic distance (Å)	Clash overlap (Å)
4:5:621:LYS:NZ	4:5:678:ASP:OD1	2.05	0.89
8:Y:-12:DG:H4'	8:Y:-11:DC:OP1	1.72	0.87
6:7:401:VAL:O	6:7:405:ILE:HD12	1.74	0.87
7:X:7:DA:H2''	7:X:8:DT:H71	1.59	0.84
3:4:350:ASN:OD1	3:4:381:SER:OG	1.94	0.84

There are no symmetry-related clashes.

5.3 Torsion angles [i](#)

5.3.1 Protein backbone [i](#)

In the following table, the Percentiles column shows the percent Ramachandran outliers of the chain as a percentile score with respect to all PDB entries followed by that with respect to all EM entries.

The Analysed column shows the number of residues for which the backbone conformation was analysed, and the total number of residues.

Mol	Chain	Analysed	Favoured	Allowed	Outliers	Percentiles	
1	2	617/868 (71%)	602 (98%)	15 (2%)	0	100	100
1	A	617/868 (71%)	606 (98%)	11 (2%)	0	100	100
2	3	587/1006 (58%)	571 (97%)	16 (3%)	0	100	100
2	B	587/1006 (58%)	571 (97%)	16 (3%)	0	100	100
3	4	646/933 (69%)	626 (97%)	20 (3%)	0	100	100
3	C	646/933 (69%)	625 (97%)	21 (3%)	0	100	100
4	5	644/775 (83%)	621 (96%)	22 (3%)	1 (0%)	47	82
4	D	644/775 (83%)	619 (96%)	24 (4%)	1 (0%)	47	82
5	6	597/1017 (59%)	574 (96%)	23 (4%)	0	100	100
5	E	597/1017 (59%)	574 (96%)	23 (4%)	0	100	100
6	7	683/845 (81%)	660 (97%)	23 (3%)	0	100	100
6	F	683/845 (81%)	663 (97%)	20 (3%)	0	100	100
All	All	7548/10888 (69%)	7312 (97%)	234 (3%)	2 (0%)	100	100

All (2) Ramachandran outliers are listed below:

Mol	Chain	Res	Type
4	5	337	VAL
4	D	337	VAL

5.3.2 Protein sidechains [i](#)

In the following table, the Percentiles column shows the percent sidechain outliers of the chain as a percentile score with respect to all PDB entries followed by that with respect to all EM entries.

The Analysed column shows the number of residues for which the sidechain conformation was analysed, and the total number of residues.

Mol	Chain	Analysed	Rotameric	Outliers	Percentiles	
1	2	547/770 (71%)	546 (100%)	1 (0%)	93	98
1	A	547/770 (71%)	546 (100%)	1 (0%)	93	98
2	3	514/864 (60%)	514 (100%)	0	100	100
2	B	514/864 (60%)	514 (100%)	0	100	100
3	4	593/848 (70%)	591 (100%)	2 (0%)	92	97
3	C	593/848 (70%)	591 (100%)	2 (0%)	92	97

Continued on next page...

Continued from previous page...

Mol	Chain	Analysed	Rotameric	Outliers	Percentiles	
4	5	584/688 (85%)	584 (100%)	0	100	100
4	D	584/688 (85%)	582 (100%)	2 (0%)	92	97
5	6	531/886 (60%)	531 (100%)	0	100	100
5	E	531/886 (60%)	531 (100%)	0	100	100
6	7	608/753 (81%)	607 (100%)	1 (0%)	93	98
6	F	608/753 (81%)	607 (100%)	1 (0%)	93	98
All	All	6754/9618 (70%)	6744 (100%)	10 (0%)	93	98

5 of 10 residues with a non-rotameric sidechain are listed below:

Mol	Chain	Res	Type
4	D	144	ASN
4	D	460	ARG
6	F	718	ARG
6	7	718	ARG
1	A	694	ARG

Sometimes sidechains can be flipped to improve hydrogen bonding and reduce clashes. All (5) such sidechains are listed below:

Mol	Chain	Res	Type
2	3	417	GLN
6	7	95	GLN
4	D	144	ASN
5	E	653	HIS
6	F	95	GLN

5.3.3 RNA [i](#)

There are no RNA molecules in this entry.

5.4 Non-standard residues in protein, DNA, RNA chains [i](#)

There are no non-standard protein/DNA/RNA residues in this entry.

5.5 Carbohydrates [i](#)

There are no monosaccharides in this entry.

5.6 Ligand geometry

Of 30 ligands modelled in this entry, 20 are monoatomic - leaving 10 for Mogul analysis.

In the following table, the Counts columns list the number of bonds (or angles) for which Mogul statistics could be retrieved, the number of bonds (or angles) that are observed in the model and the number of bonds (or angles) that are defined in the Chemical Component Dictionary. The Link column lists molecule types, if any, to which the group is linked. The Z score for a bond length (or angle) is the number of standard deviations the observed value is removed from the expected value. A bond length (or angle) with $|Z| > 2$ is considered an outlier worth inspection. RMSZ is the root-mean-square of all Z scores of the bond lengths (or angles).

Mol	Type	Chain	Res	Link	Bond lengths			Bond angles		
					Counts	RMSZ	# Z > 2	Counts	RMSZ	# Z > 2
12	ADP	3	1001	10	24,29,29	0.93	1 (4%)	29,45,45	1.52	4 (13%)
12	ADP	5	801	10	24,29,29	0.94	1 (4%)	29,45,45	1.54	4 (13%)
12	ADP	F	902	10	24,29,29	0.96	1 (4%)	29,45,45	1.48	4 (13%)
12	ADP	7	902	10	24,29,29	0.95	1 (4%)	29,45,45	1.48	4 (13%)
12	ADP	B	1001	10	24,29,29	0.94	1 (4%)	29,45,45	1.52	4 (13%)
12	ADP	C	1001	10	24,29,29	0.95	1 (4%)	29,45,45	1.48	4 (13%)
9	ATP	A	901	10	26,33,33	0.62	0	31,52,52	1.04	1 (3%)
12	ADP	4	1001	10	24,29,29	0.94	1 (4%)	29,45,45	1.48	4 (13%)
9	ATP	2	901	10	26,33,33	0.62	0	31,52,52	1.04	1 (3%)
12	ADP	D	801	10	24,29,29	0.94	1 (4%)	29,45,45	1.55	4 (13%)

In the following table, the Chirals column lists the number of chiral outliers, the number of chiral centers analysed, the number of these observed in the model and the number defined in the Chemical Component Dictionary. Similar counts are reported in the Torsion and Rings columns. '-' means no outliers of that kind were identified.

Mol	Type	Chain	Res	Link	Chirals	Torsions	Rings
12	ADP	3	1001	10	-	4/12/32/32	0/3/3/3
12	ADP	5	801	10	-	3/12/32/32	0/3/3/3
12	ADP	F	902	10	-	2/12/32/32	0/3/3/3
12	ADP	7	902	10	-	2/12/32/32	0/3/3/3
12	ADP	B	1001	10	-	4/12/32/32	0/3/3/3
12	ADP	C	1001	10	-	8/12/32/32	0/3/3/3
9	ATP	A	901	10	-	6/18/38/38	0/3/3/3
12	ADP	4	1001	10	-	8/12/32/32	0/3/3/3
9	ATP	2	901	10	-	6/18/38/38	0/3/3/3
12	ADP	D	801	10	-	3/12/32/32	0/3/3/3

The worst 5 of 8 bond length outliers are listed below:

Mol	Chain	Res	Type	Atoms	Z	Observed(Å)	Ideal(Å)
12	4	1001	ADP	C5-C4	2.40	1.47	1.40
12	F	902	ADP	C5-C4	2.39	1.47	1.40
12	C	1001	ADP	C5-C4	2.38	1.47	1.40
12	7	902	ADP	C5-C4	2.37	1.47	1.40
12	D	801	ADP	C5-C4	2.35	1.47	1.40

The worst 5 of 34 bond angle outliers are listed below:

Mol	Chain	Res	Type	Atoms	Z	Observed(°)	Ideal(°)
12	5	801	ADP	PA-O3A-PB	-3.82	119.70	132.83
12	D	801	ADP	PA-O3A-PB	-3.82	119.71	132.83
12	C	1001	ADP	C3'-C2'-C1'	3.67	106.51	100.98
12	B	1001	ADP	N3-C2-N1	-3.65	122.98	128.68
12	3	1001	ADP	N3-C2-N1	-3.64	122.98	128.68

There are no chirality outliers.

5 of 46 torsion outliers are listed below:

Mol	Chain	Res	Type	Atoms
12	3	1001	ADP	C5'-O5'-PA-O1A
12	3	1001	ADP	C5'-O5'-PA-O3A
12	4	1001	ADP	PA-O3A-PB-O2B
12	4	1001	ADP	C5'-O5'-PA-O2A
12	5	801	ADP	C5'-O5'-PA-O1A

There are no ring outliers.

6 monomers are involved in 8 short contacts:

Mol	Chain	Res	Type	Clashes	Symm-Clashes
12	3	1001	ADP	1	0
12	5	801	ADP	2	0
12	B	1001	ADP	1	0
12	C	1001	ADP	1	0
12	4	1001	ADP	1	0
12	D	801	ADP	2	0

The following is a two-dimensional graphical depiction of Mogul quality analysis of bond lengths, bond angles, torsion angles, and ring geometry for all instances of the Ligand of Interest. In addition, ligands with molecular weight > 250 and outliers as shown on the validation Tables will also be included. For torsion angles, if less than 5% of the Mogul distribution of torsion angles is within 10 degrees of the torsion angle in question, then that torsion angle is considered an outlier.

Any bond that is central to one or more torsion angles identified as an outlier by Mogul will be highlighted in the graph. For rings, the root-mean-square deviation (RMSD) between the ring in question and similar rings identified by Mogul is calculated over all ring torsion angles. If the average RMSD is greater than 60 degrees and the minimal RMSD between the ring in question and any Mogul-identified rings is also greater than 60 degrees, then that ring is considered an outlier. The outliers are highlighted in purple. The color gray indicates Mogul did not find sufficient equivalents in the CSD to analyse the geometry.

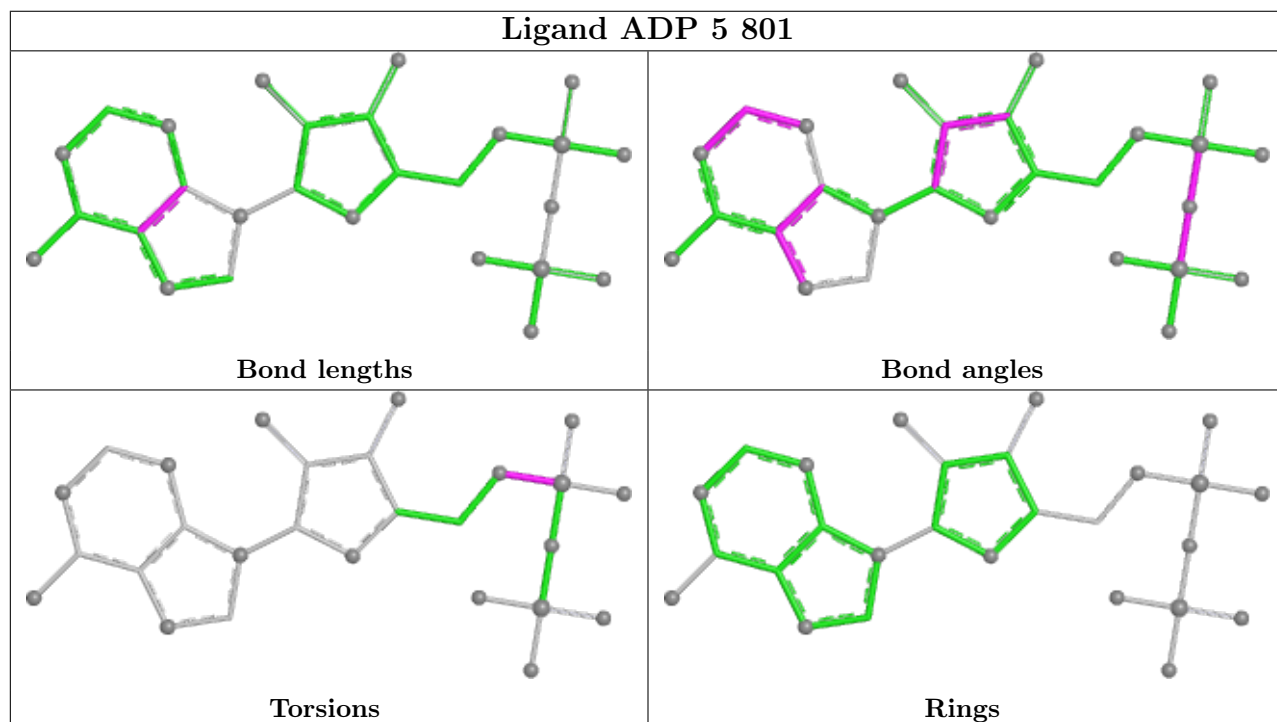
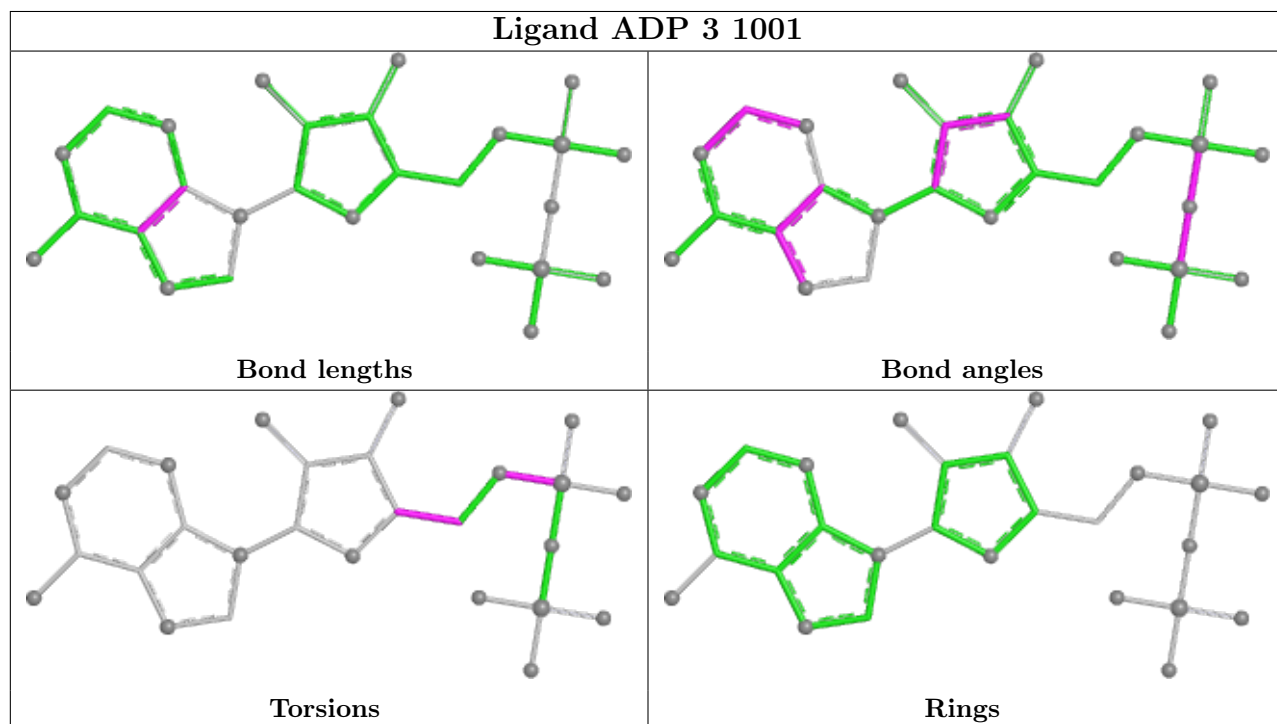

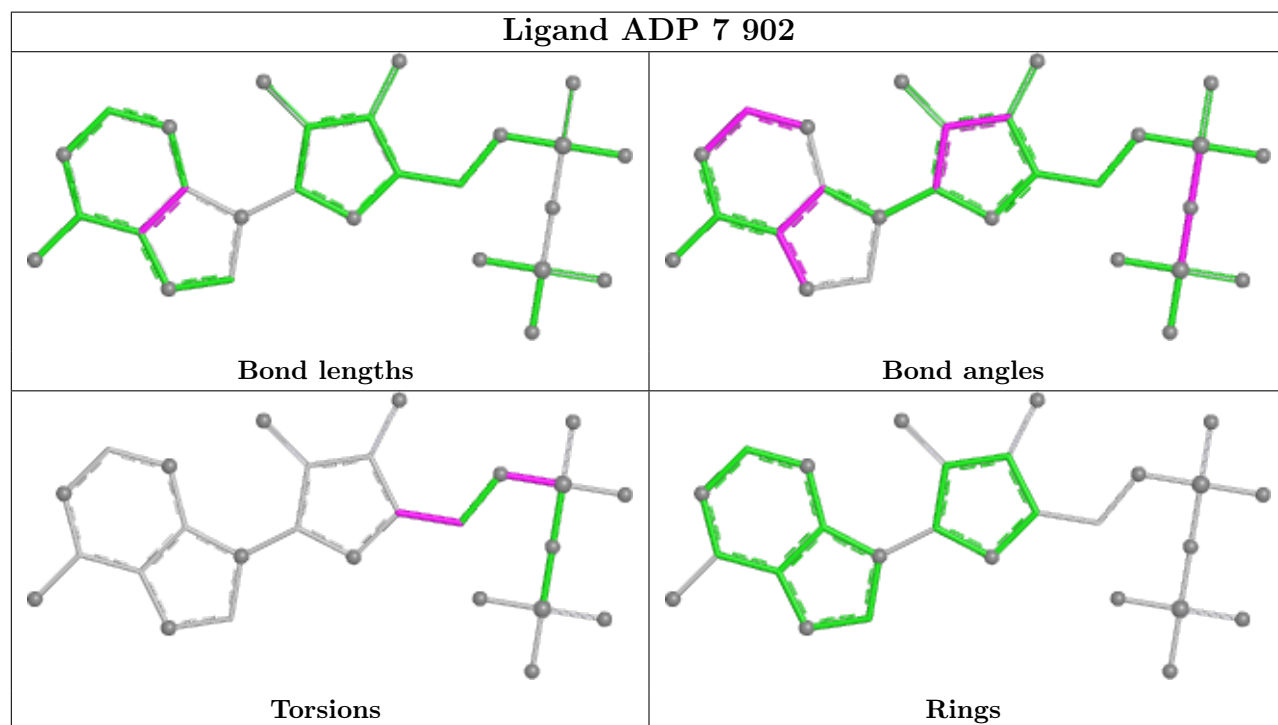
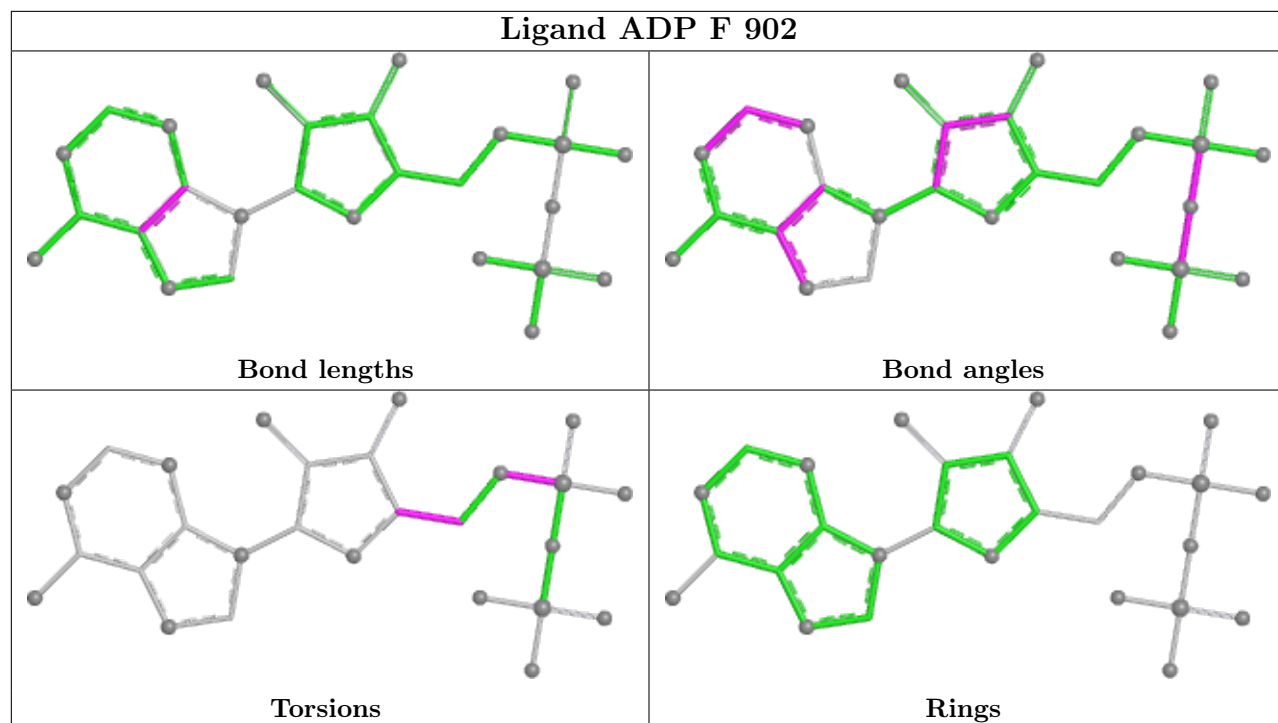

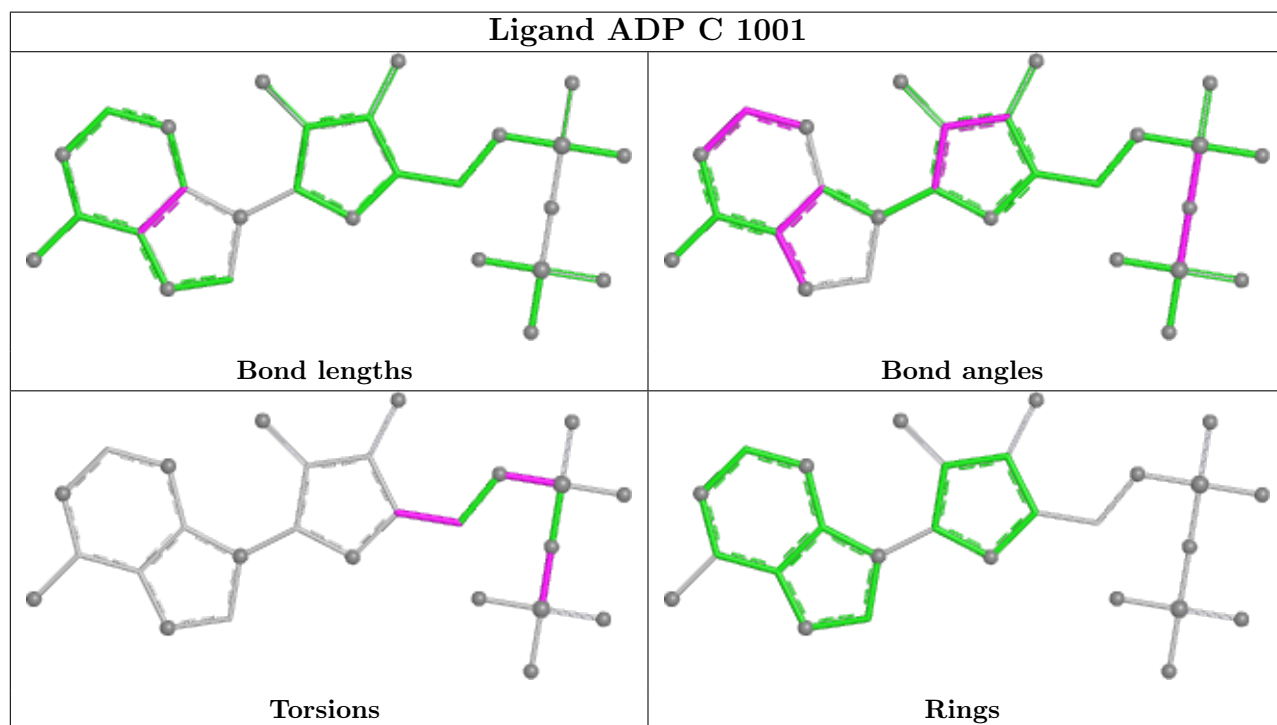
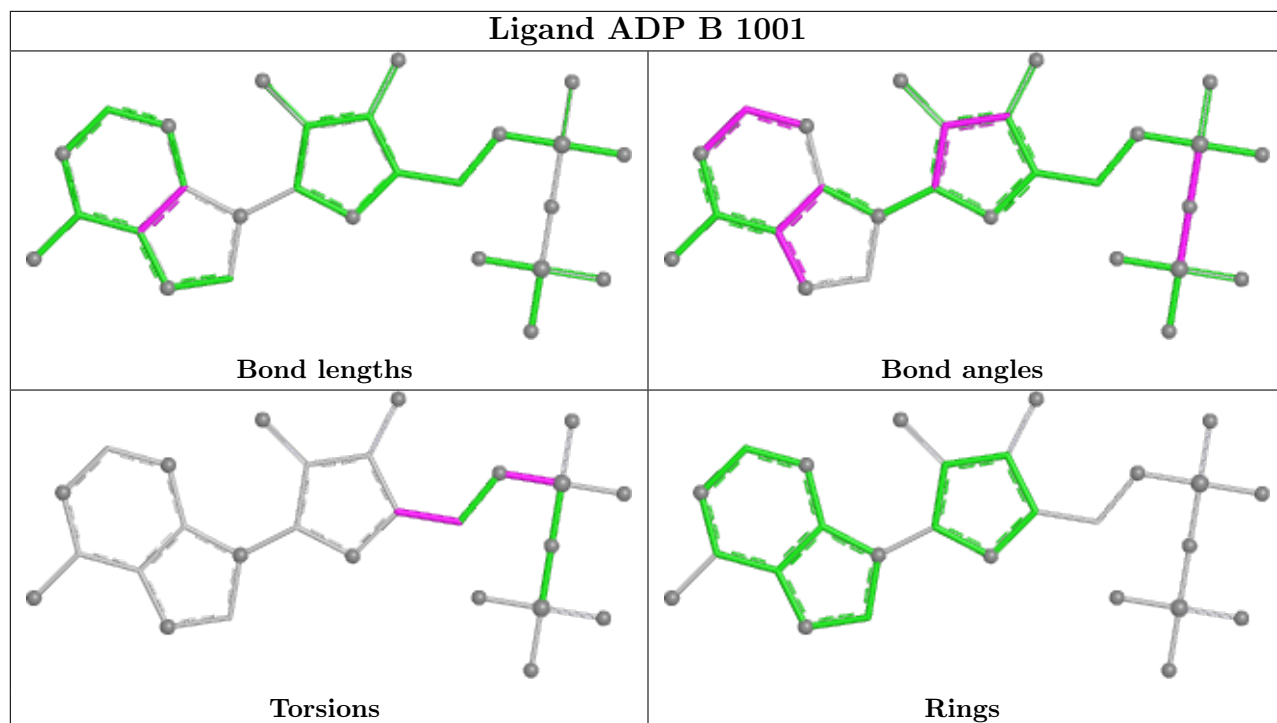

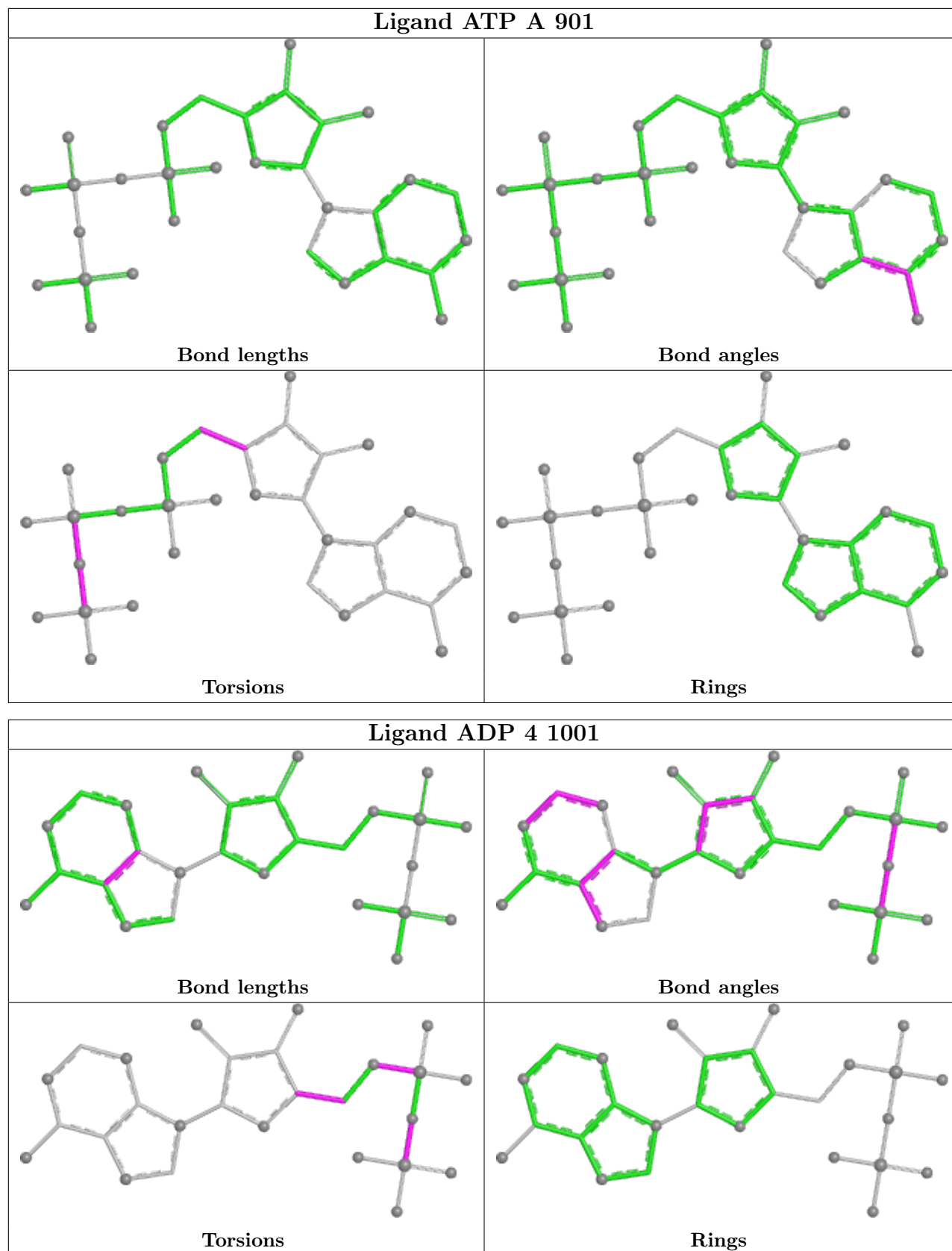

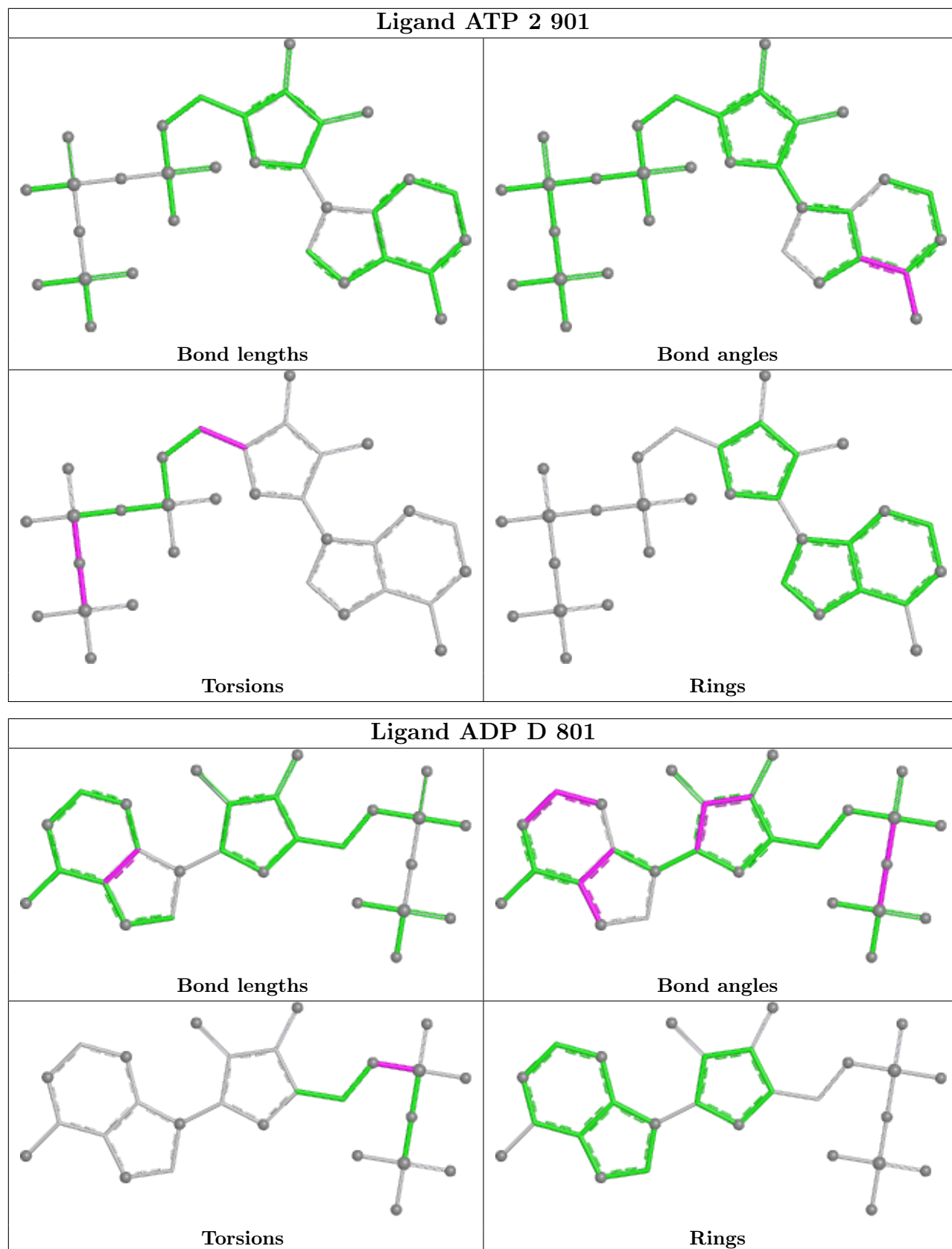

5.7 Other polymers [i](#)

There are no such residues in this entry.

5.8 Polymer linkage issues [i](#)

There are no chain breaks in this entry.

6 Map visualisation [i](#)

This section contains visualisations of the EMDB entry EMD-13176. These allow visual inspection of the internal detail of the map and identification of artifacts.

Images derived from a raw map, generated by summing the deposited half-maps, are presented below the corresponding image components of the primary map to allow further visual inspection and comparison with those of the primary map.

6.1 Orthogonal projections [i](#)

6.1.1 Primary map

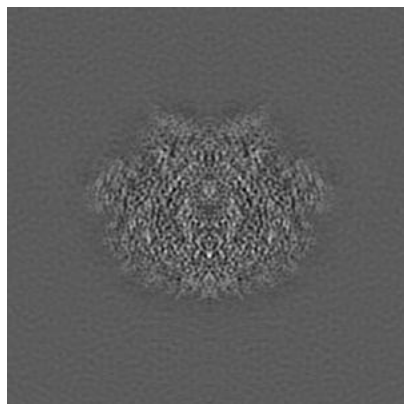

X

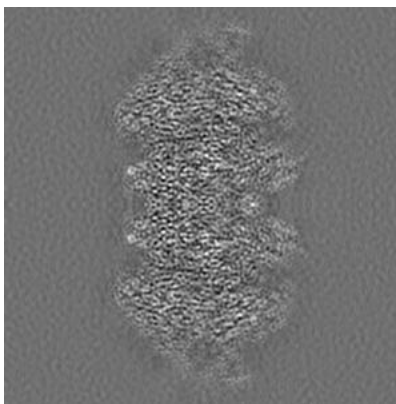

Y

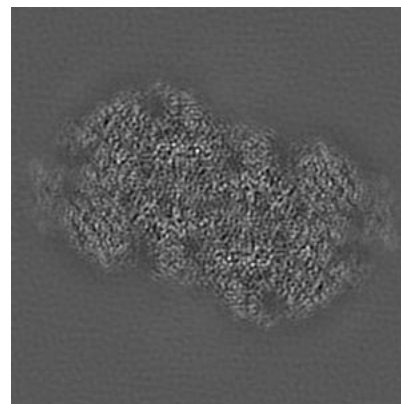

Z

6.1.2 Raw map

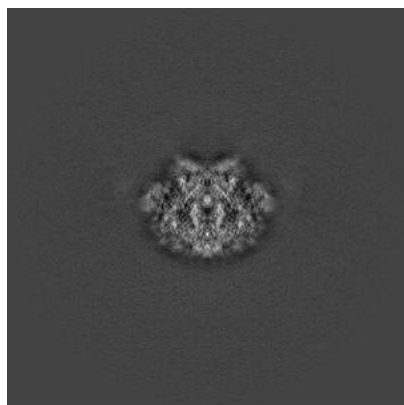

X

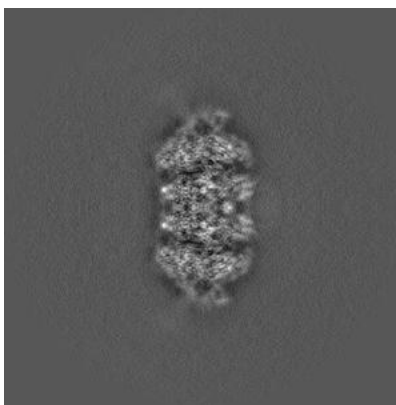

Y

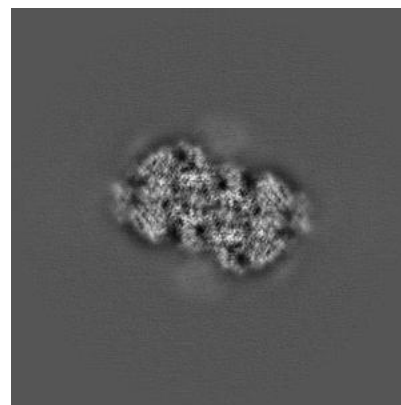

Z

The images above show the map projected in three orthogonal directions.

6.2 Central slices [i](#)

6.2.1 Primary map

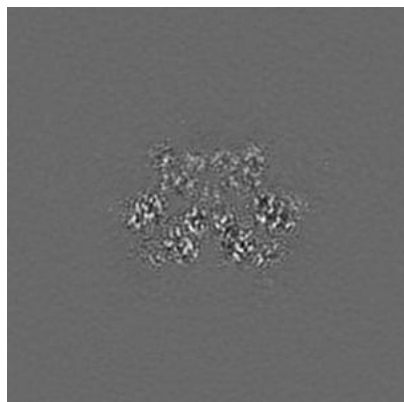

X Index: 128

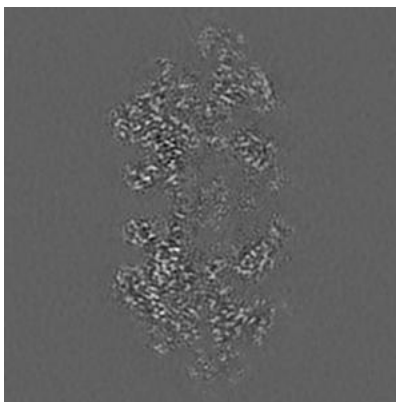

Y Index: 128

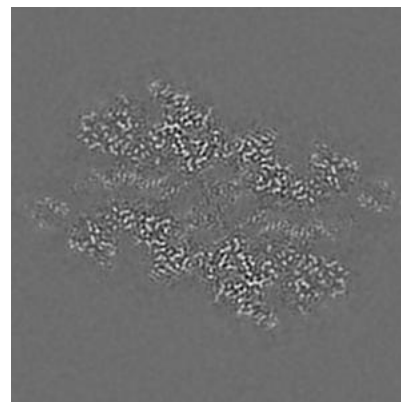

Z Index: 128

6.2.2 Raw map

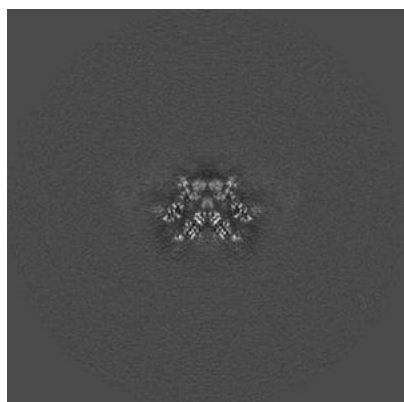

X Index: 240

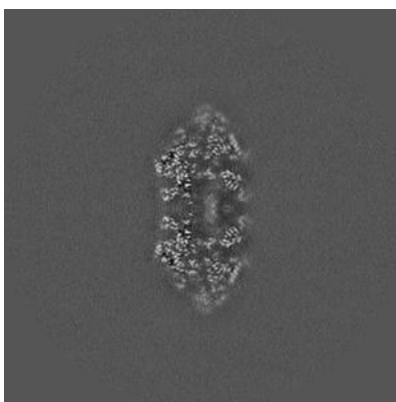

Y Index: 240

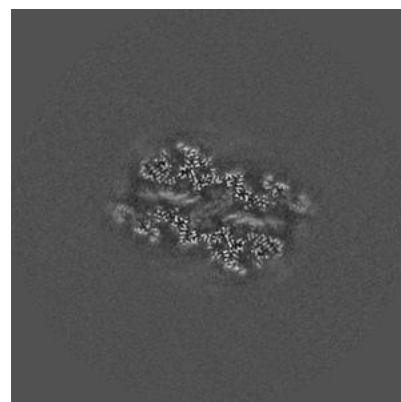

Z Index: 240

The images above show central slices of the map in three orthogonal directions.

6.3 Largest variance slices [i](#)

6.3.1 Primary map

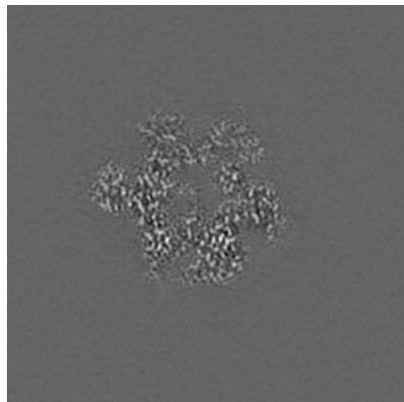

X Index: 153

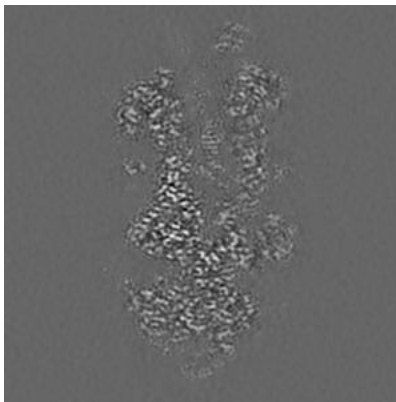

Y Index: 117

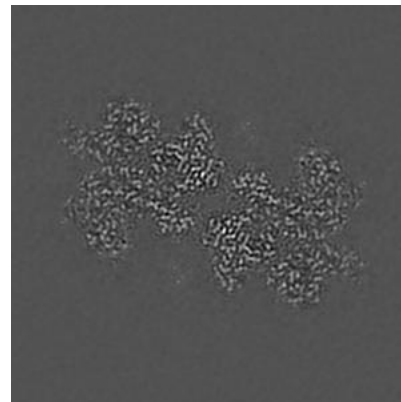

Z Index: 102

6.3.2 Raw map

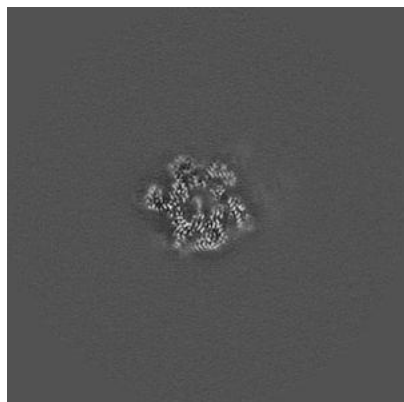

X Index: 263

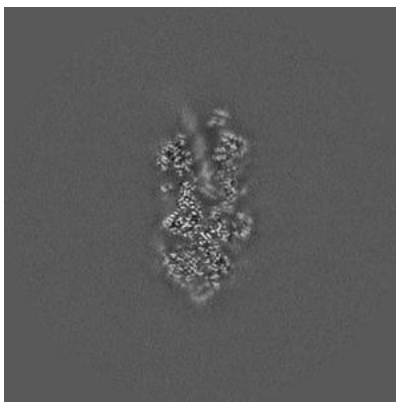

Y Index: 228

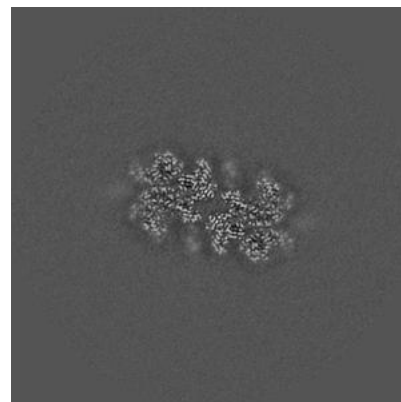

Z Index: 213

The images above show the largest variance slices of the map in three orthogonal directions.

6.4 Orthogonal surface views [i](#)

6.4.1 Primary map

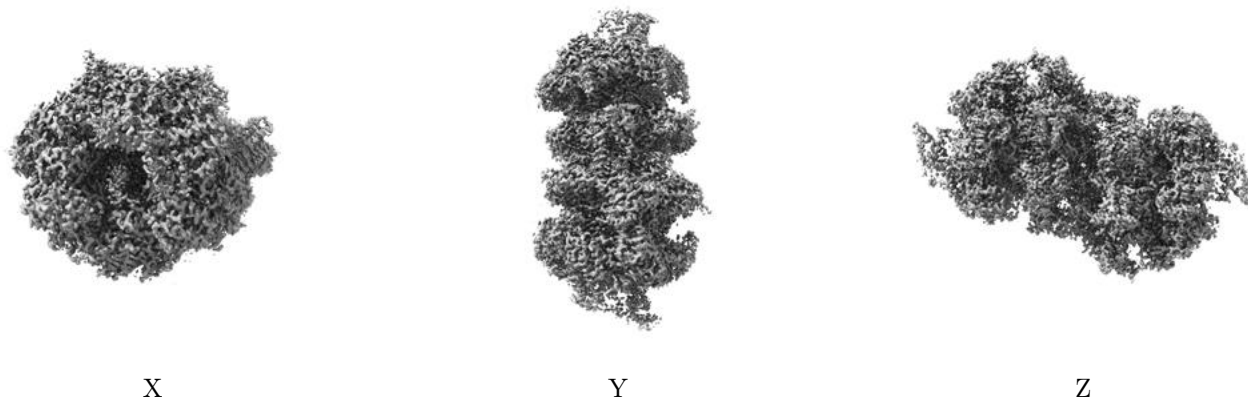

The images above show the 3D surface view of the map at the recommended contour level 0.2. These images, in conjunction with the slice images, may facilitate assessment of whether an appropriate contour level has been provided.

6.4.2 Raw map

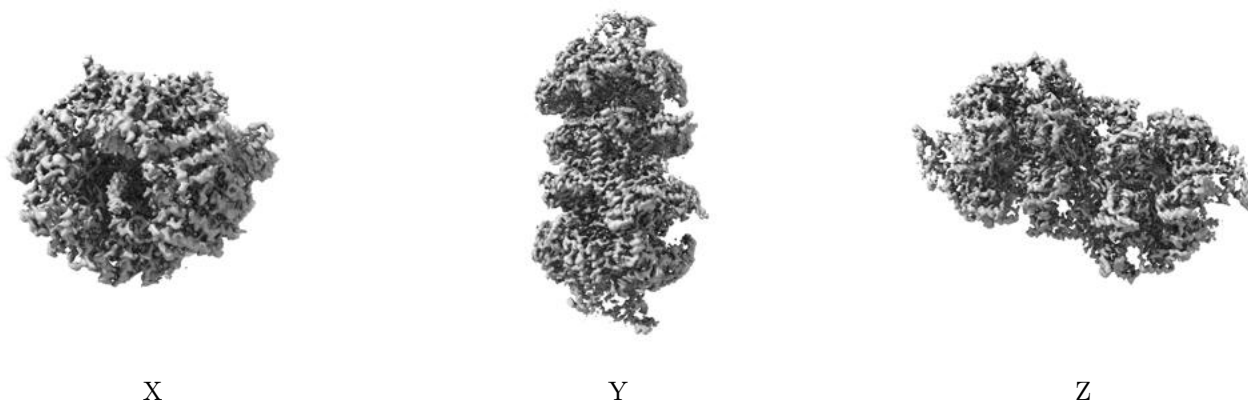

These images show the 3D surface of the raw map. The raw map's contour level was selected so that its surface encloses the same volume as the primary map does at its recommended contour level.

6.5 Mask visualisation [i](#)

This section was not generated. No masks/segmentation were deposited.

7 Map analysis [i](#)

This section contains the results of statistical analysis of the map.

7.1 Map-value distribution [i](#)

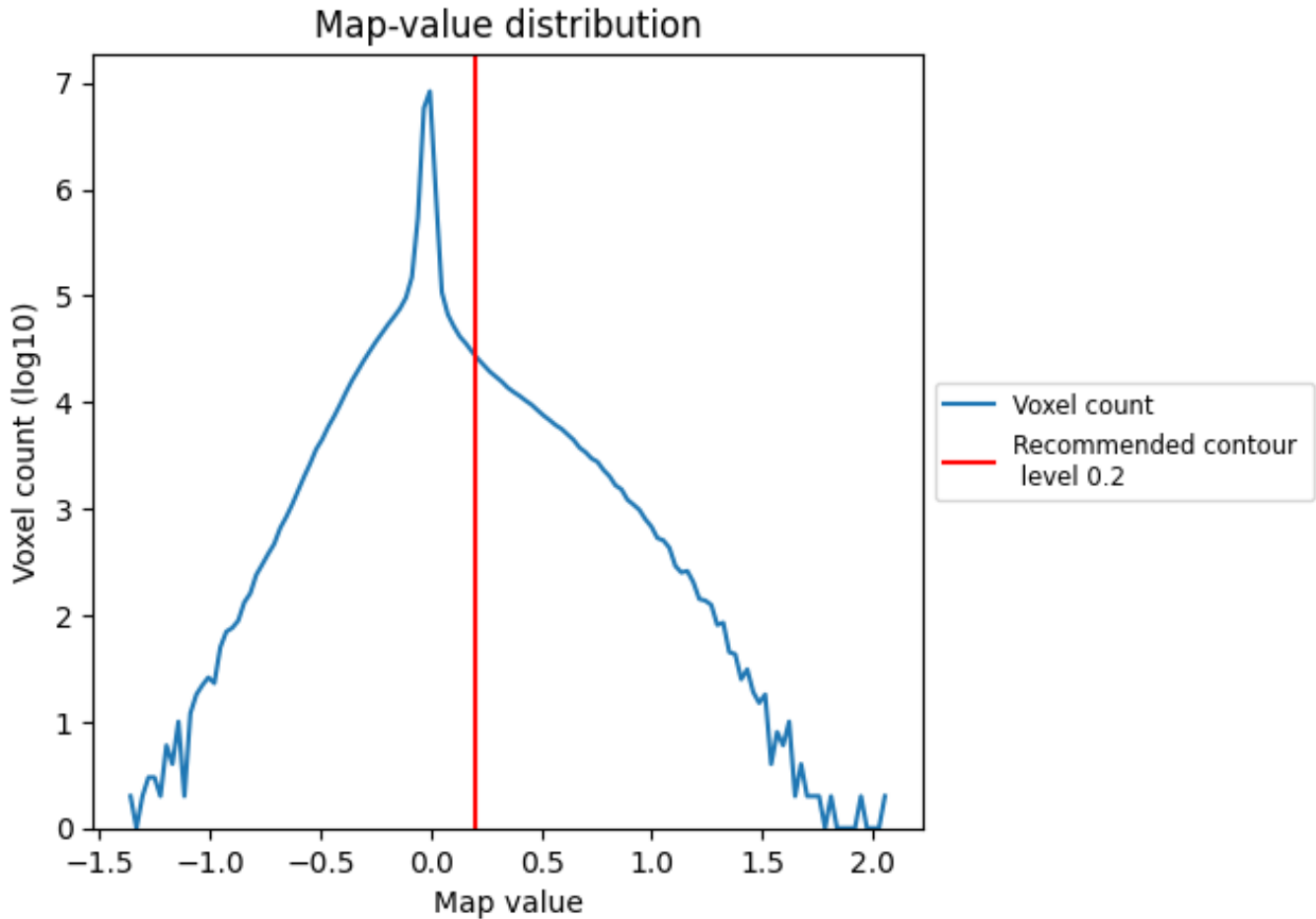

The map-value distribution is plotted in 128 intervals along the x-axis. The y-axis is logarithmic. A spike in this graph at zero usually indicates that the volume has been masked.

7.2 Volume estimate [\(i\)](#)

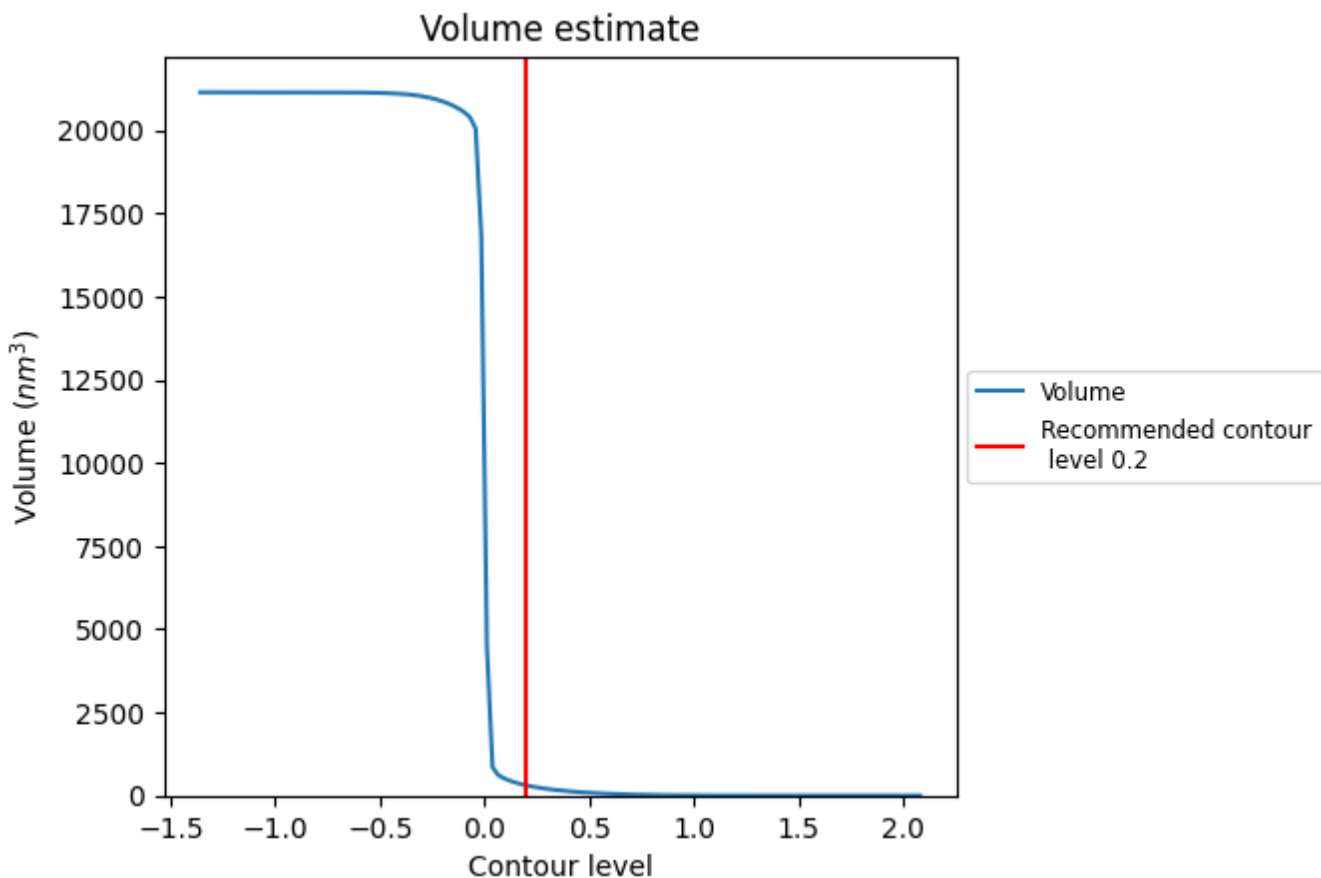

The volume at the recommended contour level is 306 nm³; this corresponds to an approximate mass of 277 kDa.

The volume estimate graph shows how the enclosed volume varies with the contour level. The recommended contour level is shown as a vertical line and the intersection between the line and the curve gives the volume of the enclosed surface at the given level.

7.3 Rotationally averaged power spectrum [\(i\)](#)

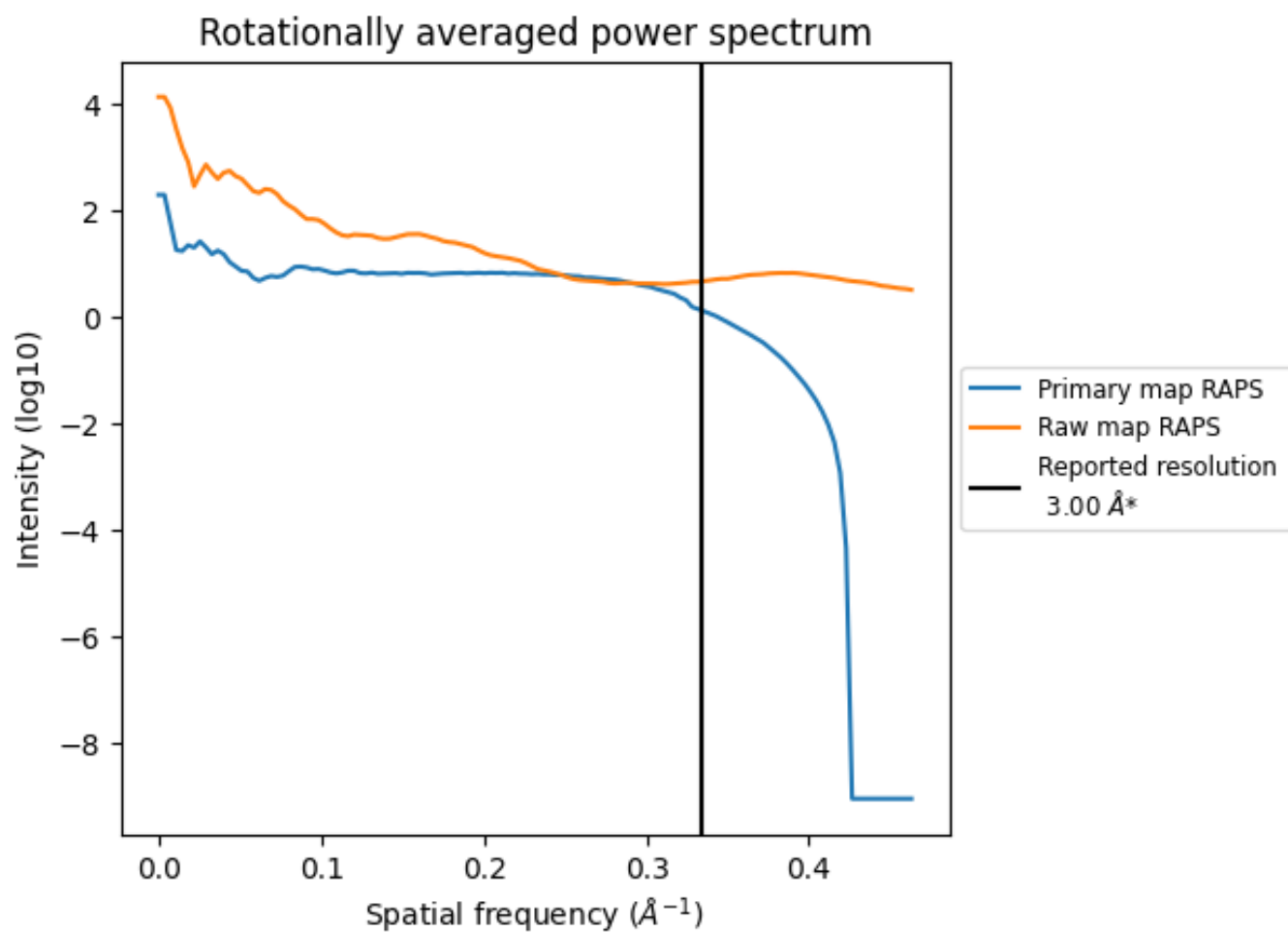

*Reported resolution corresponds to spatial frequency of 0.333 Å⁻¹

8 Fourier-Shell correlation [i](#)

Fourier-Shell Correlation (FSC) is the most commonly used method to estimate the resolution of single-particle and subtomogram-averaged maps. The shape of the curve depends on the imposed symmetry, mask and whether or not the two 3D reconstructions used were processed from a common reference. The reported resolution is shown as a black line. A curve is displayed for the half-bit criterion in addition to lines showing the 0.143 gold standard cut-off and 0.5 cut-off.

8.1 FSC [i](#)

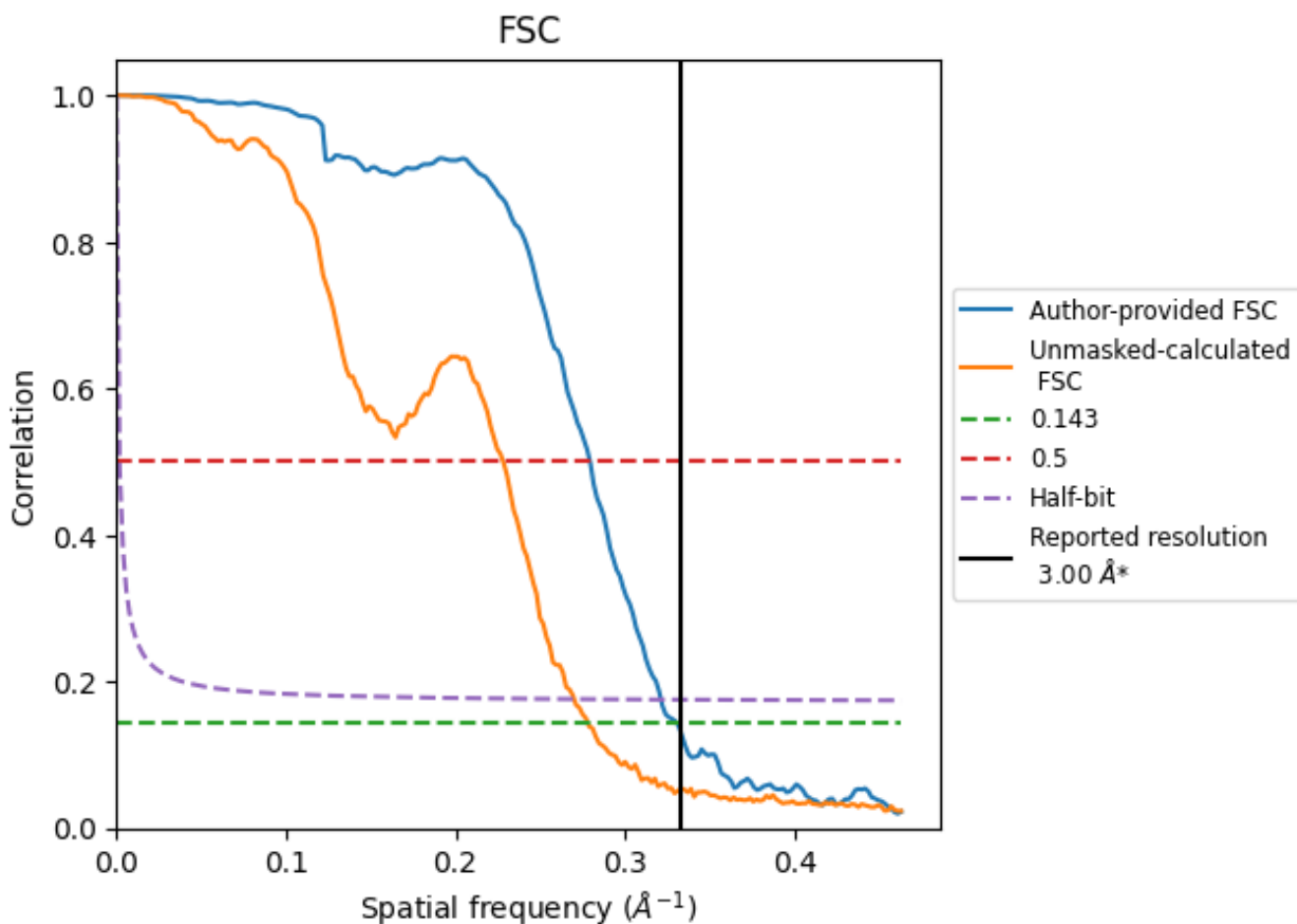

*Reported resolution corresponds to spatial frequency of 0.333 Å⁻¹

8.2 Resolution estimates [i](#)

Resolution estimate (Å)	Estimation criterion (FSC cut-off)		
	0.143	0.5	Half-bit
Reported by author	3.00	-	-
Author-provided FSC curve	3.02	3.58	3.11
Unmasked-calculated*	3.60	4.38	3.70

*Resolution estimate based on FSC curve calculated by comparison of deposited half-maps. The value from deposited half-maps intersecting FSC 0.143 CUT-OFF 3.60 differs from the reported value 3.0 by more than 10 %

9 Map-model fit [i](#)

This section contains information regarding the fit between EMDB map EMD-13176 and PDB model 7P30. Per-residue inclusion information can be found in section 3 on page 10.

9.1 Map-model overlay [i](#)

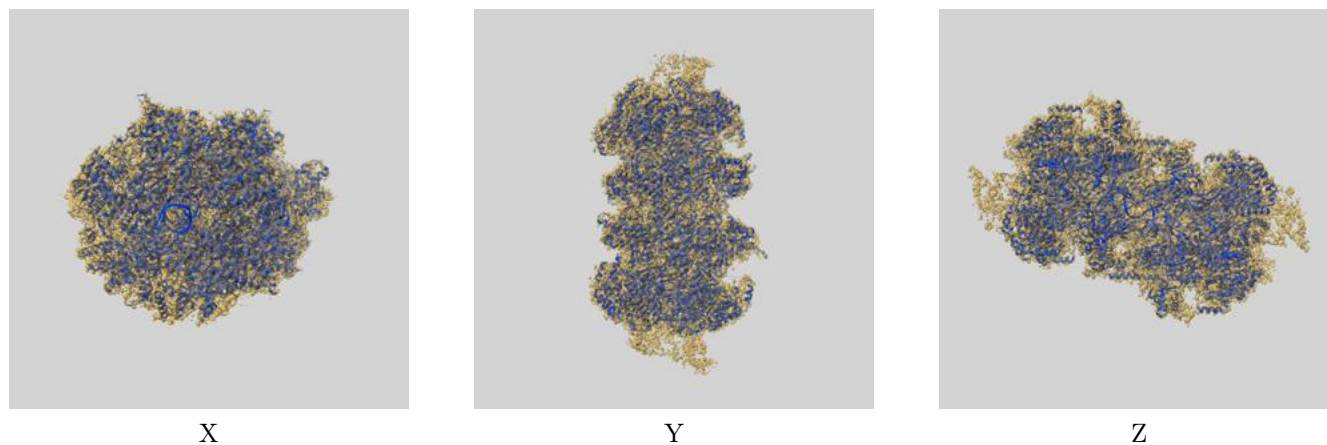

The images above show the 3D surface view of the map at the recommended contour level 0.2 at 50% transparency in yellow overlaid with a ribbon representation of the model coloured in blue. These images allow for the visual assessment of the quality of fit between the atomic model and the map.

9.2 Atom inclusion [i](#)

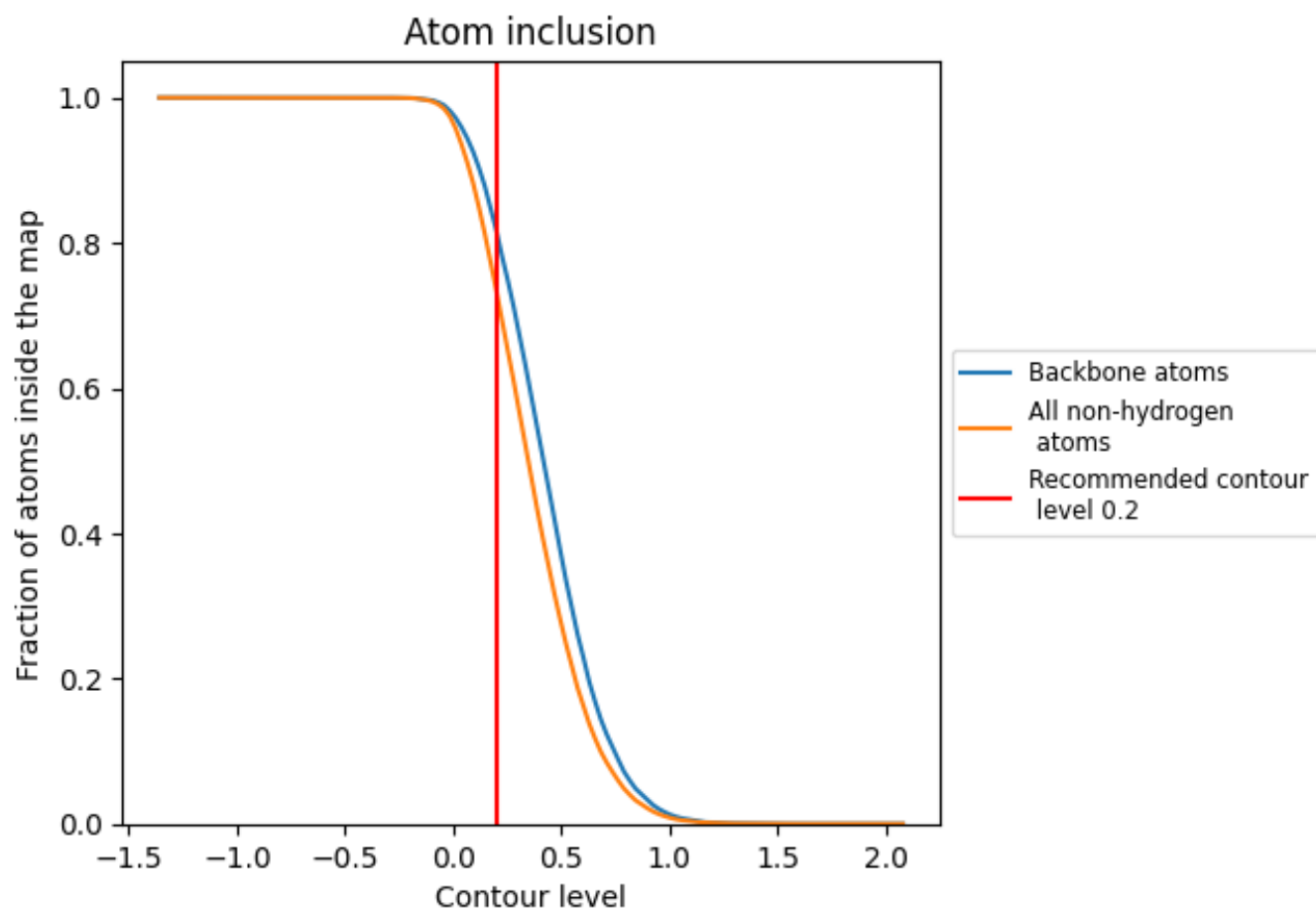

At the recommended contour level, 82% of all backbone atoms, 73% of all non-hydrogen atoms, are inside the map.