



wwPDB EM Validation Summary Report ⓘ

Jul 27, 2022 – 10:24 pm BST

PDB ID : 7PF2
EMDB ID : EMD-13365
Title : Nucleosome stack of the 4x187 nucleosome array containing H1
Authors : Dombrowski, M.; Cramer, P.
Deposited on : 2021-08-11
Resolution : 5.10 Å (reported)
Based on initial model : 7K5Y

This is a wwPDB EM Validation Summary Report for a publicly released PDB entry.

We welcome your comments at validation@mail.wwpdb.org

A user guide is available at

<https://www.wwpdb.org/validation/2017/EMValidationReportHelp>

with specific help available everywhere you see the ⓘ symbol.

The types of validation reports are described at <http://www.wwpdb.org/validation/2017/FAQs#types>.

The following versions of software and data (see [references ⓘ](#)) were used in the production of this report:

EMDB validation analysis : 0.0.1.dev8
MolProbity : 4.02b-467
Percentile statistics : 20191225.v01 (using entries in the PDB archive December 25th 2019)
Ideal geometry (proteins) : Engh & Huber (2001)
Ideal geometry (DNA, RNA) : Parkinson et al. (1996)
Validation Pipeline (wwPDB-VP) : 2.29

1 Overall quality at a glance i

The following experimental techniques were used to determine the structure:

ELECTRON MICROSCOPY

The reported resolution of this entry is 5.10 Å.

Percentile scores (ranging between 0-100) for global validation metrics of the entry are shown in the following graphic. The table shows the number of entries on which the scores are based.

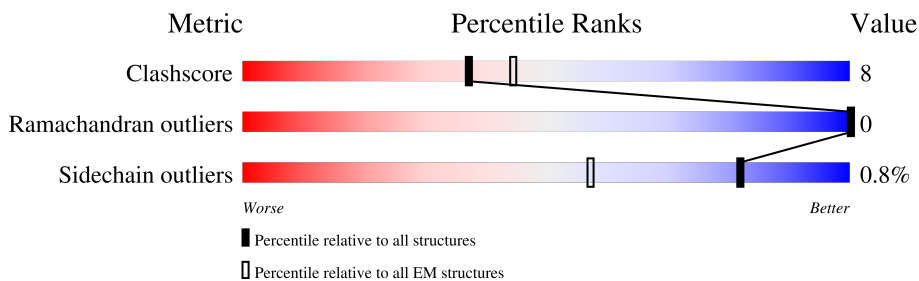









Metric	Whole archive (#Entries)	EM structures (#Entries)
Clashscore	158937	4297
Ramachandran outliers	154571	4023
Sidechain outliers	154315	3826

The table below summarises the geometric issues observed across the polymeric chains and their fit to the map. The red, orange, yellow and green segments of the bar indicate the fraction of residues that contain outliers for ≥ 3 , 2, 1 and 0 types of geometric quality criteria respectively. A grey segment represents the fraction of residues that are not modelled. The numeric value for each fraction is indicated below the corresponding segment, with a dot representing fractions $\leq 5\%$. The upper red bar (where present) indicates the fraction of residues that have poor fit to the EM map (all-atom inclusion $< 40\%$). The numeric value is given above the bar.

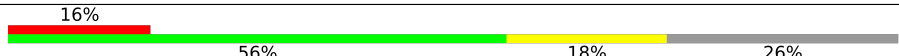
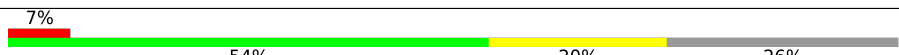
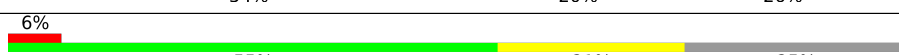
Mol	Chain	Length	Quality of chain
1	A	136	
1	E	136	
1	K	136	
1	O	136	
2	B	103	
2	F	103	
2	L	103	
2	P	103	

Continued on next page...

Continued from previous page...

Mol	Chain	Length	Quality of chain
3	C	147	
3	G	147	
3	M	147	
3	Q	147	
4	D	126	
4	H	126	
4	N	126	
4	R	126	
5	U	218	
6	I	748	
7	J	748	

2 Entry composition i

There are 7 unique types of molecules in this entry. The entry contains 26610 atoms, of which 0 are hydrogens and 0 are deuteriums.

In the tables below, the AltConf column contains the number of residues with at least one atom in alternate conformation and the Trace column contains the number of residues modelled with at most 2 atoms.

- Molecule 1 is a protein called Histone H3.2.

Mol	Chain	Residues	Atoms					AltConf	Trace
			Total	C	N	O	S		
1	K	97	798	505	153	138	2	0	0
1	O	97	798	505	153	138	2	0	0
1	A	97	798	505	153	138	2	0	0
1	E	97	798	505	153	138	2	0	0

There are 4 discrepancies between the modelled and reference sequences:

Chain	Residue	Modelled	Actual	Comment	Reference
K	110	ALA	CYS	engineered mutation	UNP Q71DI3
O	110	ALA	CYS	engineered mutation	UNP Q71DI3
A	110	ALA	CYS	engineered mutation	UNP Q71DI3
E	110	ALA	CYS	engineered mutation	UNP Q71DI3

- Molecule 2 is a protein called Histone H4.

Mol	Chain	Residues	Atoms					AltConf	Trace
			Total	C	N	O	S		
2	L	83	662	418	129	114	1	0	0
2	P	83	662	418	129	114	1	0	0
2	B	83	662	418	129	114	1	0	0
2	F	83	662	418	129	114	1	0	0

- Molecule 3 is a protein called Histone H2A type 1-B/E.

Mol	Chain	Residues	Atoms				AltConf	Trace
3	M	109	Total 840	C 529	N 166	O 145	0	0
3	Q	109	Total 840	C 529	N 166	O 145	0	0
3	C	109	Total 840	C 529	N 166	O 145	0	0
3	G	109	Total 840	C 529	N 166	O 145	0	0

There are 68 discrepancies between the modelled and reference sequences:

Chain	Residue	Modelled	Actual	Comment	Reference
M	-17	HIS	-	expression tag	UNP P04908
M	-16	HIS	-	expression tag	UNP P04908
M	-15	HIS	-	expression tag	UNP P04908
M	-14	HIS	-	expression tag	UNP P04908
M	-13	HIS	-	expression tag	UNP P04908
M	-12	HIS	-	expression tag	UNP P04908
M	-11	GLU	-	expression tag	UNP P04908
M	-10	ASN	-	expression tag	UNP P04908
M	-9	LEU	-	expression tag	UNP P04908
M	-8	TYR	-	expression tag	UNP P04908
M	-7	PHE	-	expression tag	UNP P04908
M	-6	GLN	-	expression tag	UNP P04908
M	-5	SER	-	expression tag	UNP P04908
M	-4	ASN	-	expression tag	UNP P04908
M	-3	ALA	-	expression tag	UNP P04908
M	-2	PRO	-	expression tag	UNP P04908
M	-1	TRP	-	expression tag	UNP P04908
Q	-17	HIS	-	expression tag	UNP P04908
Q	-16	HIS	-	expression tag	UNP P04908
Q	-15	HIS	-	expression tag	UNP P04908
Q	-14	HIS	-	expression tag	UNP P04908
Q	-13	HIS	-	expression tag	UNP P04908
Q	-12	HIS	-	expression tag	UNP P04908
Q	-11	GLU	-	expression tag	UNP P04908
Q	-10	ASN	-	expression tag	UNP P04908
Q	-9	LEU	-	expression tag	UNP P04908
Q	-8	TYR	-	expression tag	UNP P04908
Q	-7	PHE	-	expression tag	UNP P04908
Q	-6	GLN	-	expression tag	UNP P04908
Q	-5	SER	-	expression tag	UNP P04908
Q	-4	ASN	-	expression tag	UNP P04908

Continued on next page...

Continued from previous page...

Chain	Residue	Modelled	Actual	Comment	Reference
Q	-3	ALA	-	expression tag	UNP P04908
Q	-2	PRO	-	expression tag	UNP P04908
Q	-1	TRP	-	expression tag	UNP P04908
C	-17	HIS	-	expression tag	UNP P04908
C	-16	HIS	-	expression tag	UNP P04908
C	-15	HIS	-	expression tag	UNP P04908
C	-14	HIS	-	expression tag	UNP P04908
C	-13	HIS	-	expression tag	UNP P04908
C	-12	HIS	-	expression tag	UNP P04908
C	-11	GLU	-	expression tag	UNP P04908
C	-10	ASN	-	expression tag	UNP P04908
C	-9	LEU	-	expression tag	UNP P04908
C	-8	TYR	-	expression tag	UNP P04908
C	-7	PHE	-	expression tag	UNP P04908
C	-6	GLN	-	expression tag	UNP P04908
C	-5	SER	-	expression tag	UNP P04908
C	-4	ASN	-	expression tag	UNP P04908
C	-3	ALA	-	expression tag	UNP P04908
C	-2	PRO	-	expression tag	UNP P04908
C	-1	TRP	-	expression tag	UNP P04908
G	-17	HIS	-	expression tag	UNP P04908
G	-16	HIS	-	expression tag	UNP P04908
G	-15	HIS	-	expression tag	UNP P04908
G	-14	HIS	-	expression tag	UNP P04908
G	-13	HIS	-	expression tag	UNP P04908
G	-12	HIS	-	expression tag	UNP P04908
G	-11	GLU	-	expression tag	UNP P04908
G	-10	ASN	-	expression tag	UNP P04908
G	-9	LEU	-	expression tag	UNP P04908
G	-8	TYR	-	expression tag	UNP P04908
G	-7	PHE	-	expression tag	UNP P04908
G	-6	GLN	-	expression tag	UNP P04908
G	-5	SER	-	expression tag	UNP P04908
G	-4	ASN	-	expression tag	UNP P04908
G	-3	ALA	-	expression tag	UNP P04908
G	-2	PRO	-	expression tag	UNP P04908
G	-1	TRP	-	expression tag	UNP P04908

- Molecule 4 is a protein called Histone H2B type 1-K.

Mol	Chain	Residues	Atoms				AltConf	Trace	
			Total	C	N	O			S
4	N	95	744	467	136	139	2	0	0

Continued on next page...

Continued from previous page...

Mol	Chain	Residues	Atoms					AltConf	Trace
4	R	95	Total	C	N	O	S	0	0
			744	467	136	139	2		
4	D	95	Total	C	N	O	S	0	0
			744	467	136	139	2		
4	H	95	Total	C	N	O	S	0	0
			744	467	136	139	2		

- Molecule 5 is a protein called Histone H1.4.

Mol	Chain	Residues	Atoms				AltConf	Trace
5	U	75	Total	C	N	O	0	0
			535	336	97	102		

- Molecule 6 is a DNA chain called DNA (541-MER).

Mol	Chain	Residues	Atoms					AltConf	Trace
6	I	339	Total	C	N	O	P	0	0
			6912	3282	1254	2037	339		

- Molecule 7 is a DNA chain called DNA (541-MER).

Mol	Chain	Residues	Atoms					AltConf	Trace
7	J	339	Total	C	N	O	P	0	0
			6987	3306	1311	2031	339		

3 Residue-property plots [i](#)

These plots are drawn for all protein, RNA, DNA and oligosaccharide chains in the entry. The first graphic for a chain summarises the proportions of the various outlier classes displayed in the second graphic. The second graphic shows the sequence view annotated by issues in geometry and atom inclusion in map density. Residues are color-coded according to the number of geometric quality criteria for which they contain at least one outlier: green = 0, yellow = 1, orange = 2 and red = 3 or more. A red diamond above a residue indicates a poor fit to the EM map for this residue (all-atom inclusion < 40%). Stretches of 2 or more consecutive residues without any outlier are shown as a green connector. Residues present in the sample, but not in the model, are shown in grey.

- Molecule 1: Histone H3.2

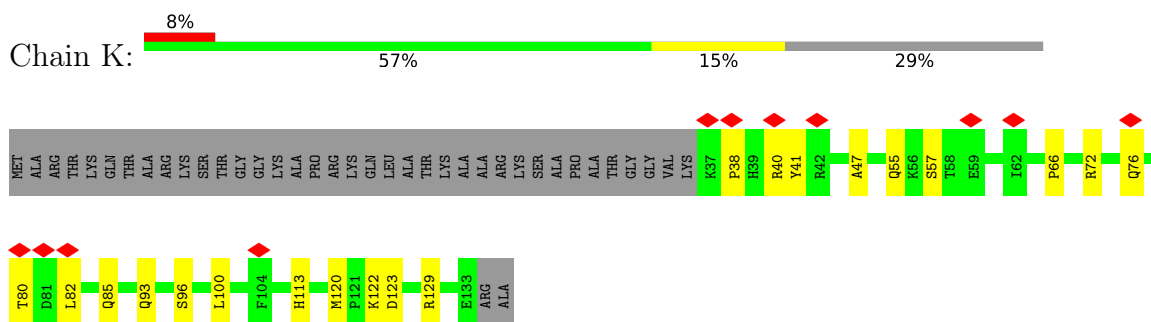

- Molecule 1: Histone H3.2

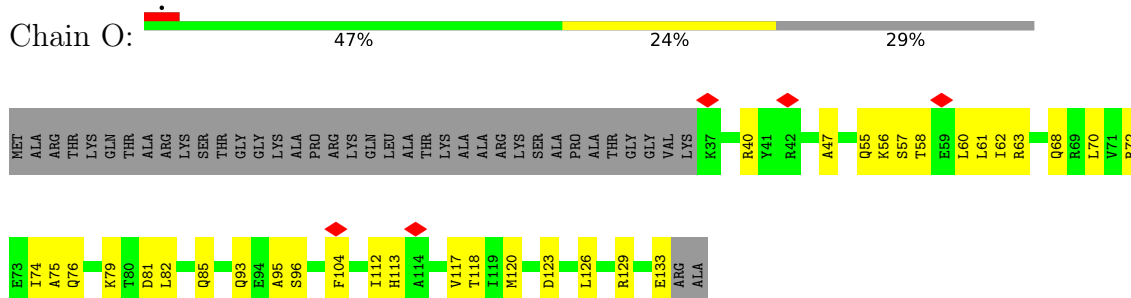

- Molecule 1: Histone H3.2

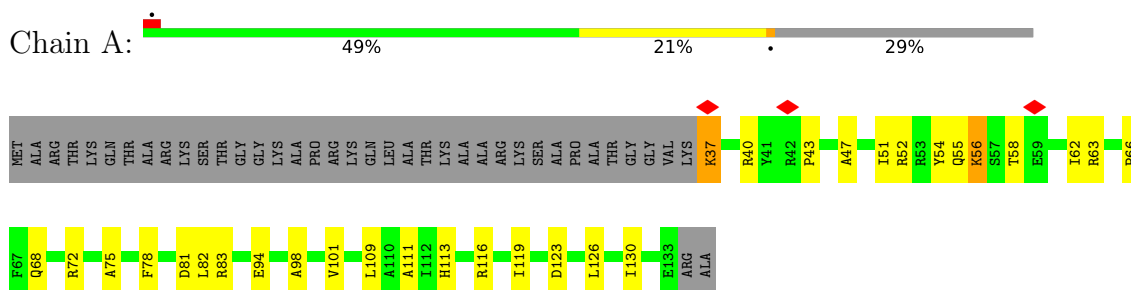

- Molecule 1: Histone H3.2



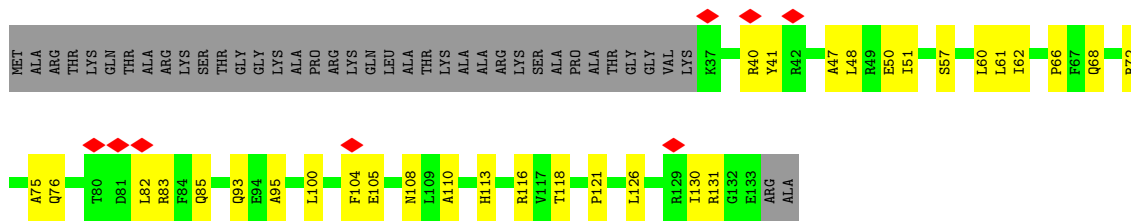

• Molecule 2: Histone H4

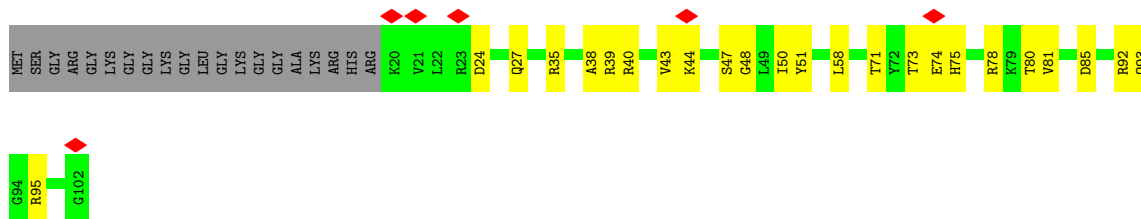

• Molecule 2: Histone H4

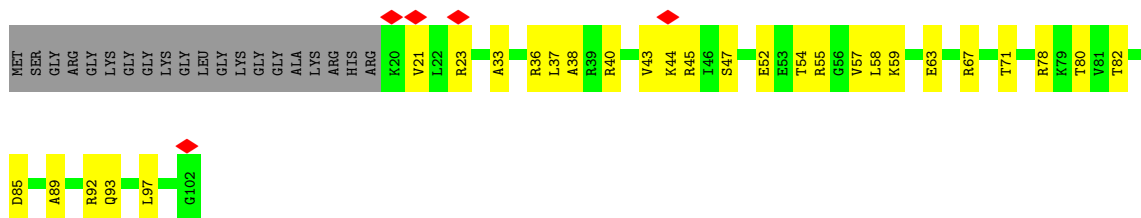

• Molecule 2: Histone H4



• Molecule 2: Histone H4

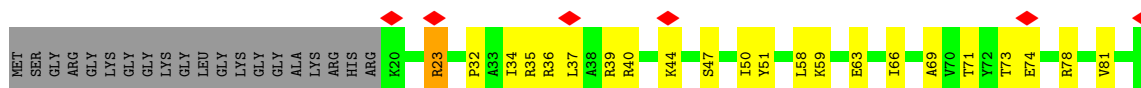



● Molecule 3: Histone H2A type 1-B/E

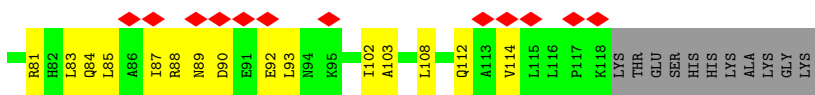
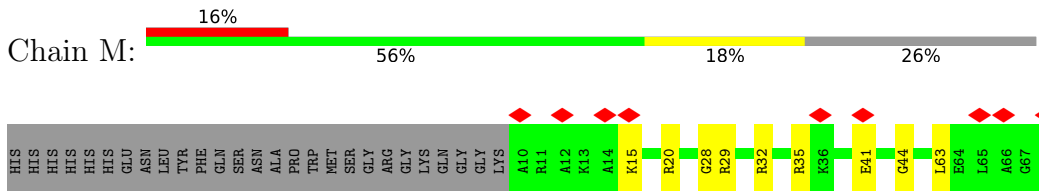

● Molecule 3: Histone H2A type 1-B/E

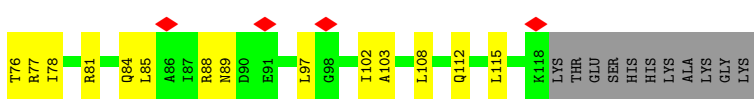
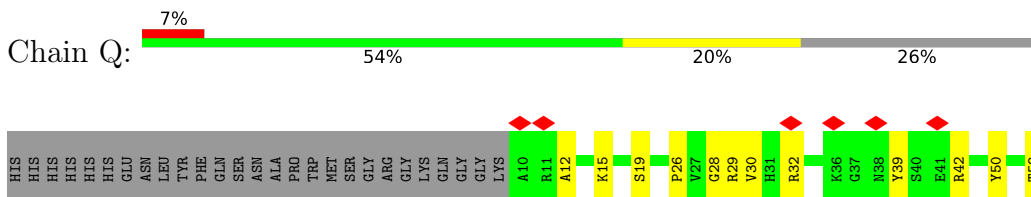

● Molecule 3: Histone H2A type 1-B/E

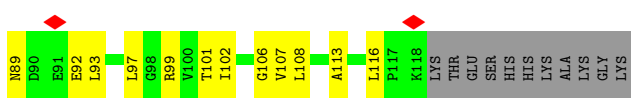
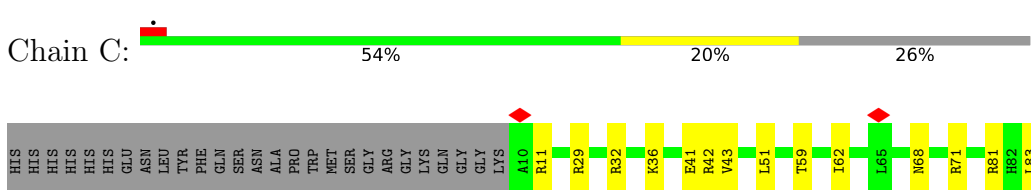

● Molecule 3: Histone H2A type 1-B/E

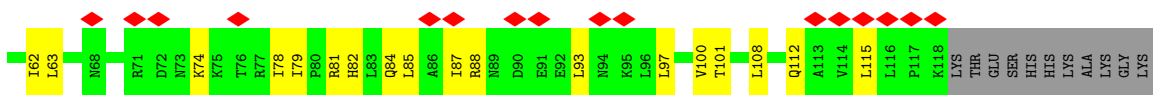
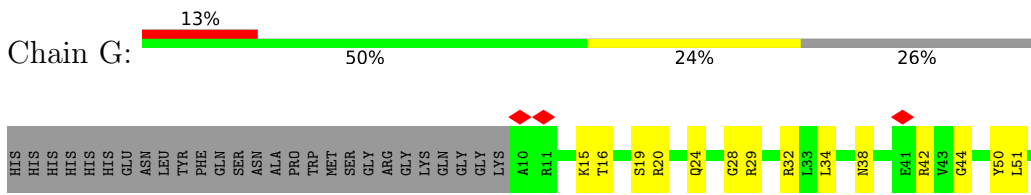

● Molecule 4: Histone H2B type 1-K

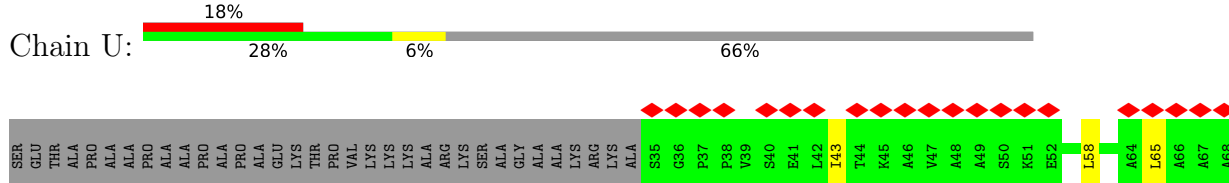
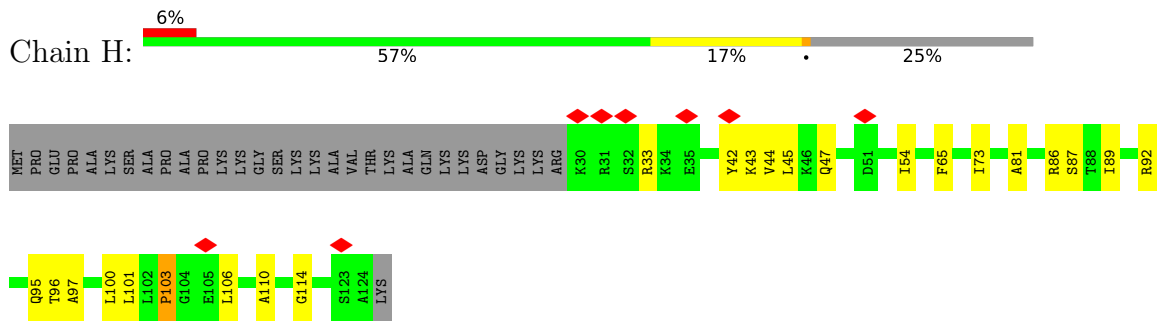
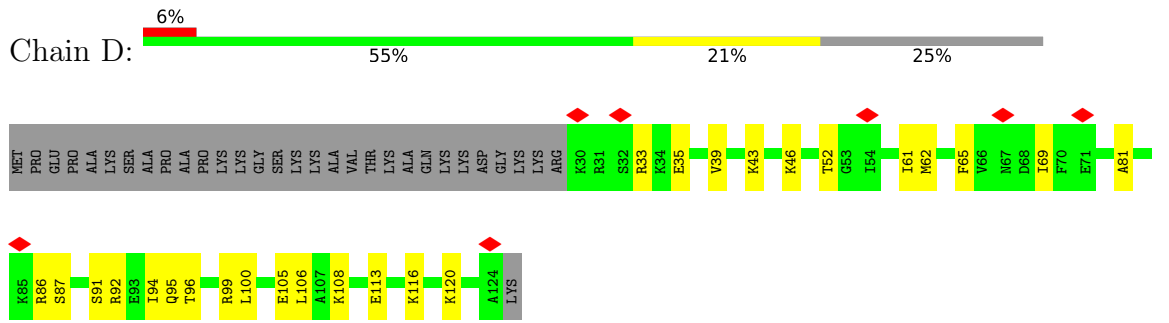
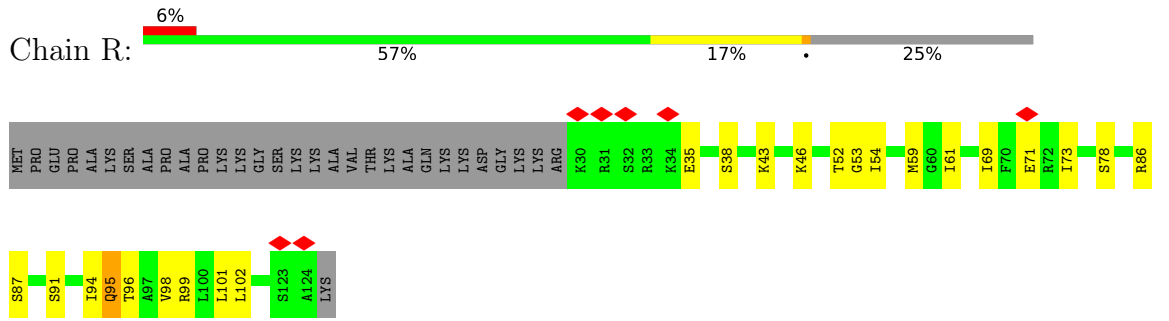
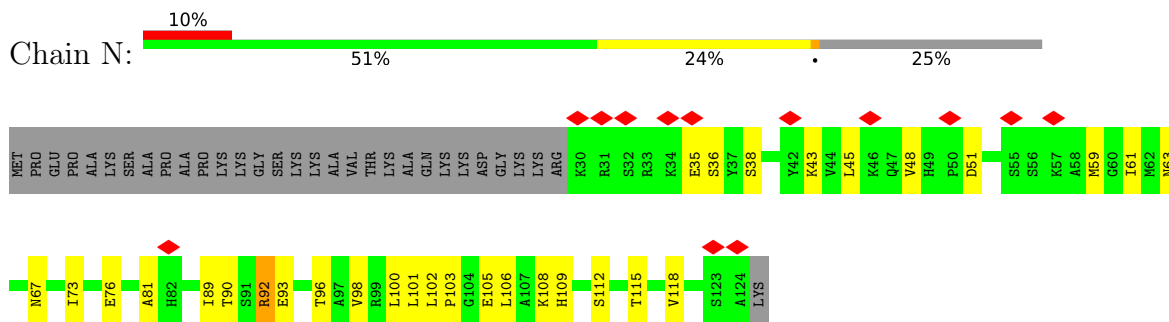

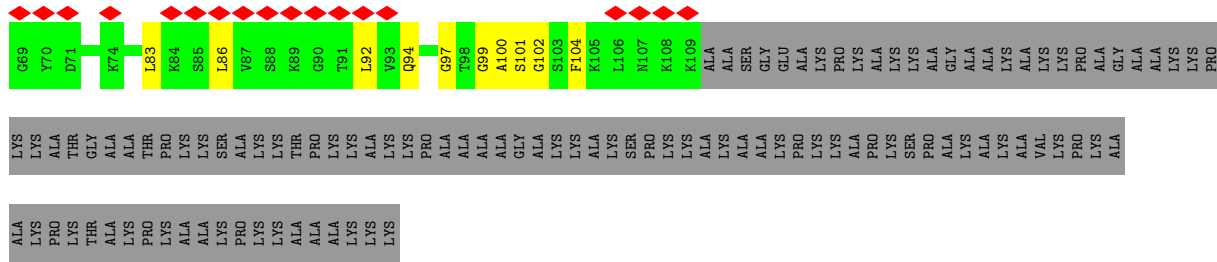

● Molecule 6: DNA (541-MER)

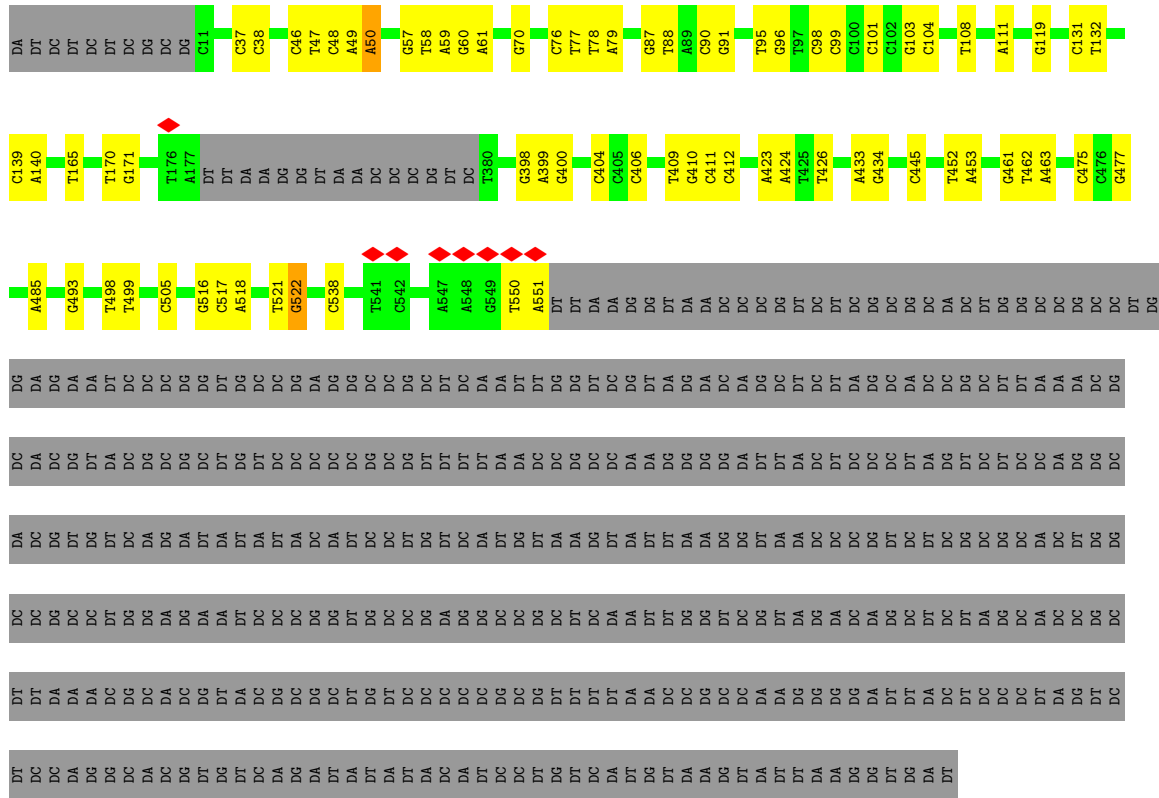
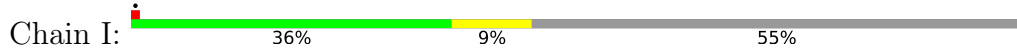

● Molecule 7: DNA (541-MER)

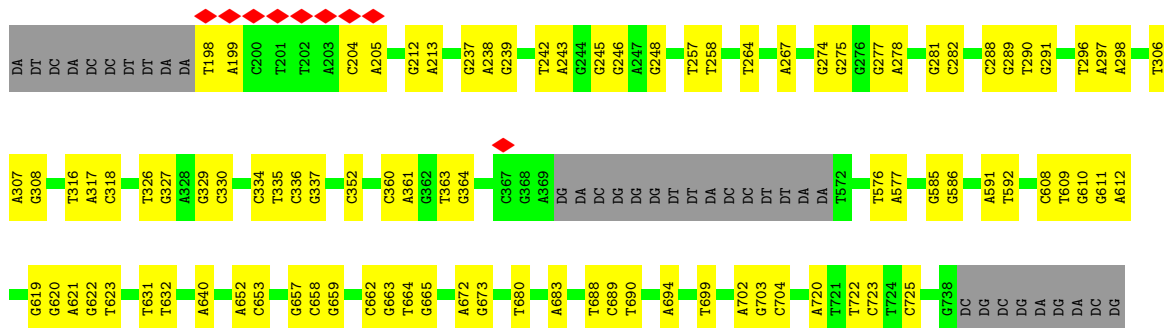
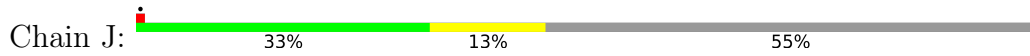

4 Experimental information

Property	Value	Source
EM reconstruction method	SINGLE PARTICLE	Depositor
Imposed symmetry	POINT, Not provided	
Number of particles used	110706	Depositor
Resolution determination method	FSC 0.143 CUT-OFF	Depositor
CTF correction method	PHASE FLIPPING AND AMPLITUDE CORRECTION	Depositor
Microscope	FEI TITAN KRIOS	Depositor
Voltage (kV)	300	Depositor
Electron dose ($e^-/\text{\AA}^2$)	60	Depositor
Minimum defocus (nm)	Not provided	
Maximum defocus (nm)	Not provided	
Magnification	Not provided	
Image detector	GATAN K3 (6k x 4k)	Depositor
Maximum map value	0.099	Depositor
Minimum map value	-0.045	Depositor
Average map value	-0.000	Depositor
Map value standard deviation	0.004	Depositor
Recommended contour level	0.0215	Depositor
Map size (Å)	315.0, 315.0, 315.0	wwPDB
Map dimensions	300, 300, 300	wwPDB
Map angles (°)	90.0, 90.0, 90.0	wwPDB
Pixel spacing (Å)	1.05, 1.05, 1.05	Depositor

5 Model quality i

5.1 Standard geometry i

The Z score for a bond length (or angle) is the number of standard deviations the observed value is removed from the expected value. A bond length (or angle) with $|Z| > 5$ is considered an outlier worth inspection. RMSZ is the root-mean-square of all Z scores of the bond lengths (or angles).

Mol	Chain	Bond lengths		Bond angles	
		RMSZ	# $ Z > 5$	RMSZ	# $ Z > 5$
1	A	0.36	0/810	0.76	0/1087
1	E	0.32	0/810	0.72	0/1087
1	K	0.50	1/810 (0.1%)	0.88	3/1087 (0.3%)
1	O	0.29	0/810	0.63	0/1087
2	B	0.35	0/669	0.73	0/894
2	F	0.36	0/669	0.82	0/894
2	L	0.33	0/669	0.72	0/894
2	P	0.35	0/669	0.75	0/894
3	C	0.33	0/850	0.69	0/1146
3	G	0.34	0/850	0.75	0/1146
3	M	0.34	0/850	0.75	0/1146
3	Q	0.31	0/850	0.63	0/1146
4	D	0.35	0/755	0.66	0/1014
4	H	0.38	0/755	0.74	1/1014 (0.1%)
4	N	0.37	0/755	0.69	0/1014
4	R	0.31	0/755	0.63	0/1014
5	U	0.26	0/538	0.60	0/718
6	I	0.66	1/7744 (0.0%)	1.02	5/11938 (0.0%)
7	J	0.65	0/7846	0.97	1/12115 (0.0%)
All	All	0.54	2/28464 (0.0%)	0.89	10/41335 (0.0%)

Chiral center outliers are detected by calculating the chiral volume of a chiral center and verifying if the center is modelled as a planar moiety or with the opposite hand. A planarity outlier is detected by checking planarity of atoms in a peptide group, atoms in a mainchain group or atoms of a sidechain that are expected to be planar.

Mol	Chain	#Chirality outliers	#Planarity outliers
4	H	0	1

All (2) bond length outliers are listed below:

Mol	Chain	Res	Type	Atoms	Z	Observed(Å)	Ideal(Å)
1	K	38	PRO	CG-CD	-9.28	1.20	1.50

Continued on next page...

Continued from previous page...

Mol	Chain	Res	Type	Atoms	Z	Observed(Å)	Ideal(Å)
6	I	49	DA	C3'-O3'	5.92	1.51	1.44

The worst 5 of 10 bond angle outliers are listed below:

Mol	Chain	Res	Type	Atoms	Z	Observed(°)	Ideal(°)
6	I	50	DA	OP1-P-OP2	14.09	140.73	119.60
1	K	38	PRO	N-CD-CG	-11.88	85.39	103.20
6	I	49	DA	OP2-P-O3'	-11.27	80.41	105.20
6	I	49	DA	OP1-P-O3'	-8.71	86.03	105.20
1	K	38	PRO	CA-N-CD	-7.46	101.05	111.50

There are no chirality outliers.

All (1) planarity outliers are listed below:

Mol	Chain	Res	Type	Group
4	H	103	PRO	Peptide

5.2 Too-close contacts [i](#)

In the following table, the Non-H and H(model) columns list the number of non-hydrogen atoms and hydrogen atoms in the chain respectively. The H(added) column lists the number of hydrogen atoms added and optimized by MolProbity. The Clashes column lists the number of clashes within the asymmetric unit, whereas Symm-Clashes lists symmetry-related clashes.

Mol	Chain	Non-H	H(model)	H(added)	Clashes	Symm-Clashes
1	A	798	0	838	27	0
1	E	798	0	838	32	0
1	K	798	0	838	17	0
1	O	798	0	838	29	0
2	B	662	0	709	21	0
2	F	662	0	709	22	0
2	L	662	0	709	22	0
2	P	662	0	709	25	0
3	C	840	0	902	25	0
3	G	840	0	902	32	0
3	M	840	0	902	24	0
3	Q	840	0	902	25	0
4	D	744	0	769	27	0
4	H	744	0	769	23	0
4	N	744	0	769	27	0
4	R	744	0	769	21	0

Continued on next page...

Continued from previous page...

Mol	Chain	Non-H	H(model)	H(added)	Clashes	Symm-Clashes
5	U	535	0	588	8	0
6	I	6912	0	3806	60	0
7	J	6987	0	3803	83	0
All	All	26610	0	21069	378	0

The all-atom clashscore is defined as the number of clashes found per 1000 atoms (including hydrogen atoms). The all-atom clashscore for this structure is 8.

The worst 5 of 378 close contacts within the same asymmetric unit are listed below, sorted by their clash magnitude.

Atom-1	Atom-2	Interatomic distance (Å)	Clash overlap (Å)
1:A:75:ALA:HB1	1:A:82:LEU:HD23	1.67	0.77
4:D:91:SER:O	4:D:95:GLN:HB2	1.86	0.76
4:N:76:GLU:HG3	4:N:101:LEU:HD11	1.70	0.72
2:F:71:THR:HG22	4:H:96:THR:HG23	1.74	0.69
2:P:89:ALA:O	2:P:93:GLN:NE2	2.26	0.68

There are no symmetry-related clashes.

5.3 Torsion angles [i](#)

5.3.1 Protein backbone [i](#)

In the following table, the Percentiles column shows the percent Ramachandran outliers of the chain as a percentile score with respect to all PDB entries followed by that with respect to all EM entries.

The Analysed column shows the number of residues for which the backbone conformation was analysed, and the total number of residues.

Mol	Chain	Analysed	Favoured	Allowed	Outliers	Percentiles	
1	A	95/136 (70%)	92 (97%)	3 (3%)	0	100	100
1	E	95/136 (70%)	95 (100%)	0	0	100	100
1	K	95/136 (70%)	95 (100%)	0	0	100	100
1	O	95/136 (70%)	93 (98%)	2 (2%)	0	100	100
2	B	81/103 (79%)	79 (98%)	2 (2%)	0	100	100
2	F	81/103 (79%)	79 (98%)	2 (2%)	0	100	100
2	L	81/103 (79%)	77 (95%)	4 (5%)	0	100	100

Continued on next page...

Continued from previous page...

Mol	Chain	Analysed	Favoured	Allowed	Outliers	Percentiles	
2	P	81/103 (79%)	79 (98%)	2 (2%)	0	100	100
3	C	107/147 (73%)	104 (97%)	3 (3%)	0	100	100
3	G	107/147 (73%)	105 (98%)	2 (2%)	0	100	100
3	M	107/147 (73%)	103 (96%)	4 (4%)	0	100	100
3	Q	107/147 (73%)	105 (98%)	2 (2%)	0	100	100
4	D	93/126 (74%)	93 (100%)	0	0	100	100
4	H	93/126 (74%)	91 (98%)	2 (2%)	0	100	100
4	N	93/126 (74%)	91 (98%)	2 (2%)	0	100	100
4	R	93/126 (74%)	91 (98%)	2 (2%)	0	100	100
5	U	73/218 (34%)	71 (97%)	2 (3%)	0	100	100
All	All	1577/2266 (70%)	1543 (98%)	34 (2%)	0	100	100

There are no Ramachandran outliers to report.

5.3.2 Protein sidechains [i](#)

In the following table, the Percentiles column shows the percent sidechain outliers of the chain as a percentile score with respect to all PDB entries followed by that with respect to all EM entries.

The Analysed column shows the number of residues for which the sidechain conformation was analysed, and the total number of residues.

Mol	Chain	Analysed	Rotameric	Outliers	Percentiles	
1	A	84/110 (76%)	82 (98%)	2 (2%)	49	69
1	E	84/110 (76%)	84 (100%)	0	100	100
1	K	84/110 (76%)	83 (99%)	1 (1%)	71	84
1	O	84/110 (76%)	84 (100%)	0	100	100
2	B	68/79 (86%)	67 (98%)	1 (2%)	65	80
2	F	68/79 (86%)	67 (98%)	1 (2%)	65	80
2	L	68/79 (86%)	68 (100%)	0	100	100
2	P	68/79 (86%)	68 (100%)	0	100	100
3	C	85/116 (73%)	85 (100%)	0	100	100
3	G	85/116 (73%)	83 (98%)	2 (2%)	49	69
3	M	85/116 (73%)	84 (99%)	1 (1%)	71	84

Continued on next page...

Continued from previous page...

Mol	Chain	Analysed	Rotameric	Outliers	Percentiles	
3	Q	85/116 (73%)	85 (100%)	0	100	100
4	D	81/105 (77%)	81 (100%)	0	100	100
4	H	81/105 (77%)	81 (100%)	0	100	100
4	N	81/105 (77%)	80 (99%)	1 (1%)	71	84
4	R	81/105 (77%)	80 (99%)	1 (1%)	71	84
5	U	57/145 (39%)	57 (100%)	0	100	100
All	All	1329/1785 (74%)	1319 (99%)	10 (1%)	82	89

5 of 10 residues with a non-rotameric sidechain are listed below:

Mol	Chain	Res	Type
2	F	23	ARG
3	G	74	LYS
3	G	84	GLN
4	R	95	GLN
1	A	37	LYS

Sometimes sidechains can be flipped to improve hydrogen bonding and reduce clashes. 5 of 8 such sidechains are listed below:

Mol	Chain	Res	Type
3	G	24	GLN
1	E	108	ASN
4	D	95	GLN
3	C	38	ASN
1	E	76	GLN

5.3.3 RNA [i](#)

There are no RNA molecules in this entry.

5.4 Non-standard residues in protein, DNA, RNA chains [i](#)

There are no non-standard protein/DNA/RNA residues in this entry.

5.5 Carbohydrates [i](#)

There are no monosaccharides in this entry.

5.6 Ligand geometry [i](#)

There are no ligands in this entry.

5.7 Other polymers [i](#)

There are no such residues in this entry.

5.8 Polymer linkage issues [i](#)

There are no chain breaks in this entry.

6 Map visualisation [i](#)

This section contains visualisations of the EMDB entry EMD-13365. These allow visual inspection of the internal detail of the map and identification of artifacts.

No raw map or half-maps were deposited for this entry and therefore no images, graphs, etc. pertaining to the raw map can be shown.

6.1 Orthogonal projections [i](#)

6.1.1 Primary map

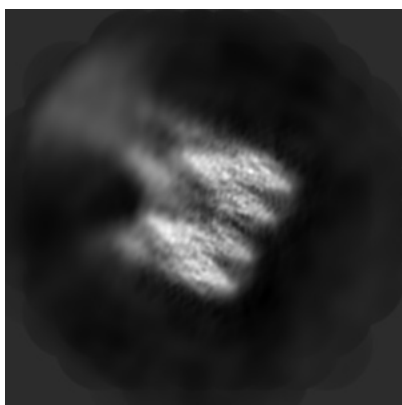

X

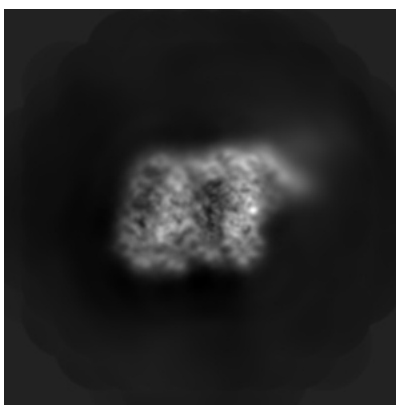

Y

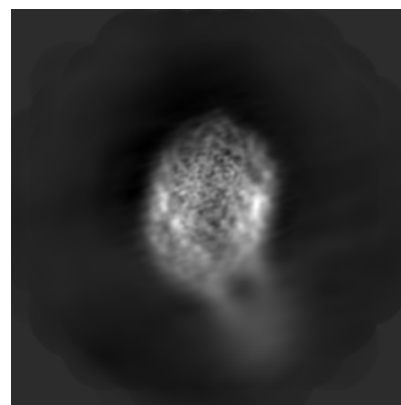

Z

The images above show the map projected in three orthogonal directions.

6.2 Central slices [i](#)

6.2.1 Primary map

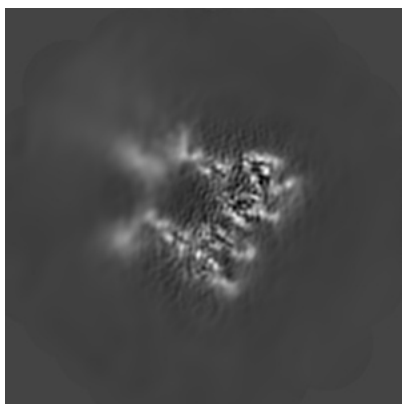

X Index: 150

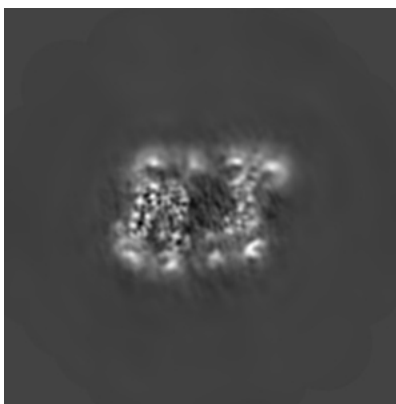

Y Index: 150

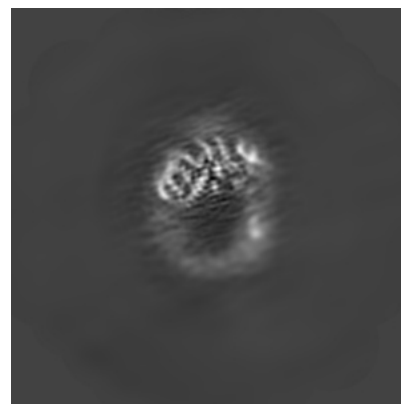

Z Index: 150

The images above show central slices of the map in three orthogonal directions.

6.3 Largest variance slices [i](#)

6.3.1 Primary map

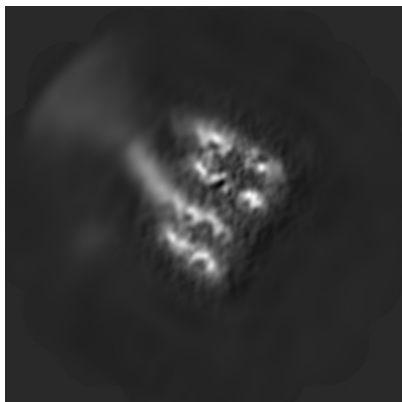

X Index: 183

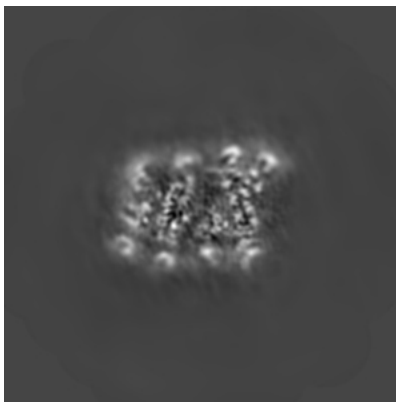

Y Index: 158

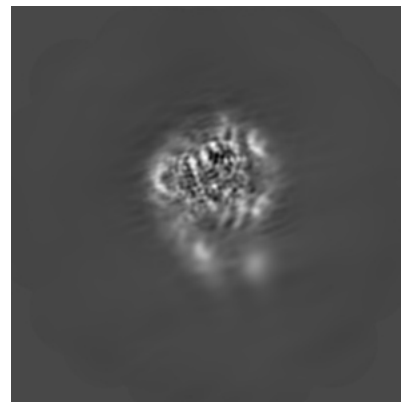

Z Index: 178

The images above show the largest variance slices of the map in three orthogonal directions.

6.4 Orthogonal surface views [i](#)

6.4.1 Primary map

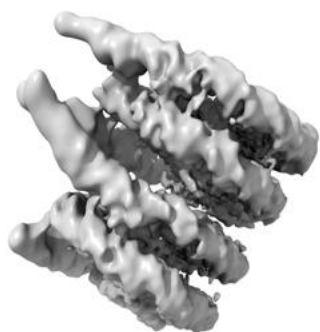

X

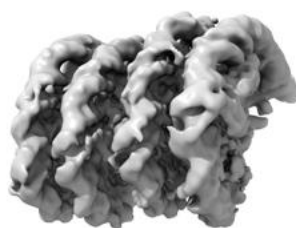

Y

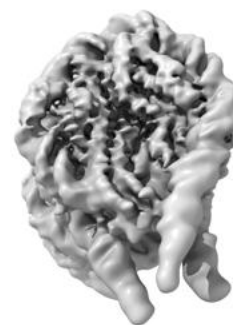

Z

The images above show the 3D surface view of the map at the recommended contour level 0.0215. These images, in conjunction with the slice images, may facilitate assessment of whether an appropriate contour level has been provided.

6.5 Mask visualisation

This section was not generated. No masks/segmentation were deposited.

7 Map analysis [i](#)

This section contains the results of statistical analysis of the map.

7.1 Map-value distribution [i](#)

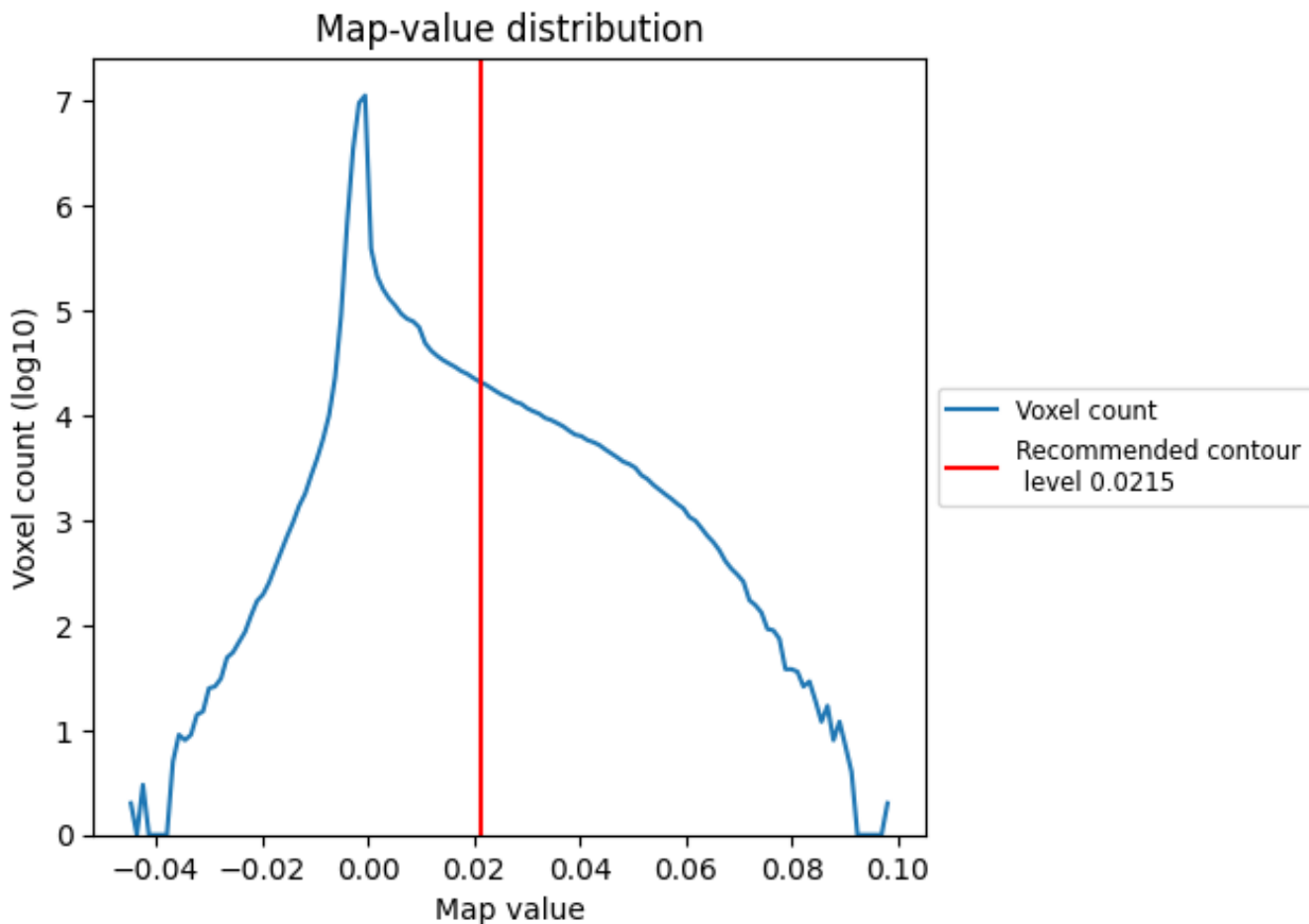

The map-value distribution is plotted in 128 intervals along the x-axis. The y-axis is logarithmic. A spike in this graph at zero usually indicates that the volume has been masked.

7.2 Volume estimate [\(i\)](#)

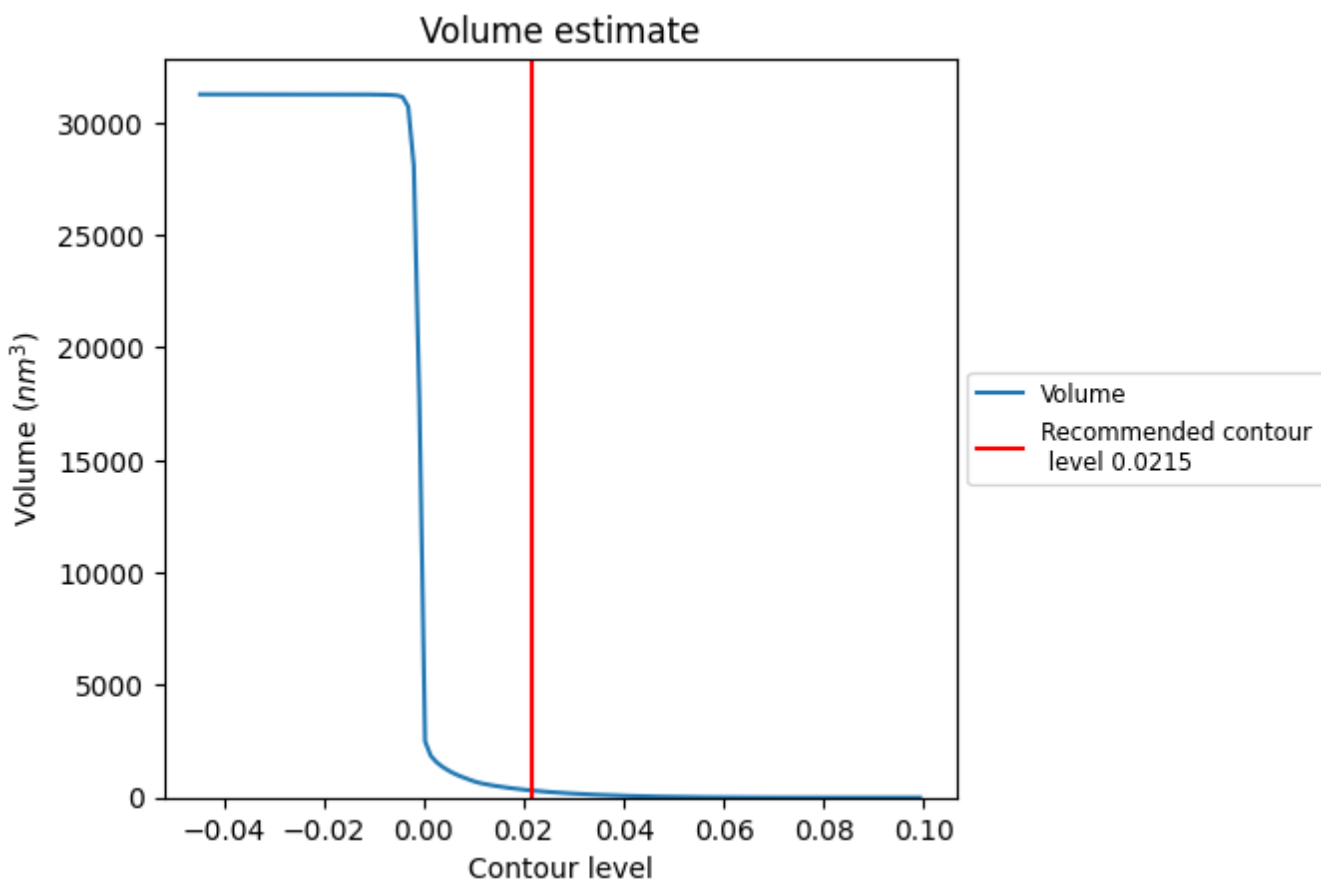

The volume at the recommended contour level is 318 nm^3 ; this corresponds to an approximate mass of 287 kDa.

The volume estimate graph shows how the enclosed volume varies with the contour level. The recommended contour level is shown as a vertical line and the intersection between the line and the curve gives the volume of the enclosed surface at the given level.

7.3 Rotationally averaged power spectrum [i](#)

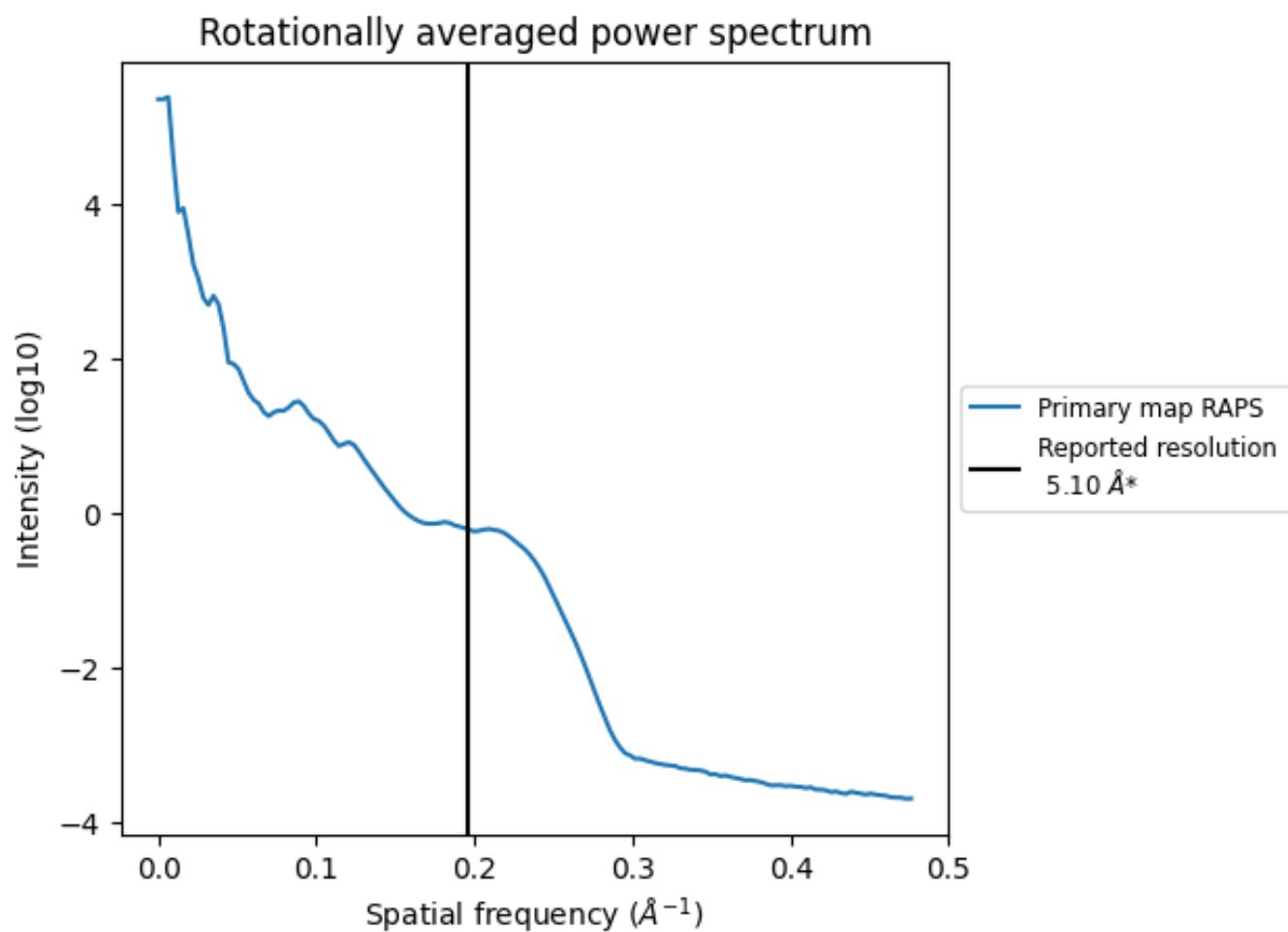

*Reported resolution corresponds to spatial frequency of 0.196 Å⁻¹

8 Fourier-Shell correlation [i](#)

Fourier-Shell Correlation (FSC) is the most commonly used method to estimate the resolution of single-particle and subtomogram-averaged maps. The shape of the curve depends on the imposed symmetry, mask and whether or not the two 3D reconstructions used were processed from a common reference. The reported resolution is shown as a black line. A curve is displayed for the half-bit criterion in addition to lines showing the 0.143 gold standard cut-off and 0.5 cut-off.

8.1 FSC [i](#)

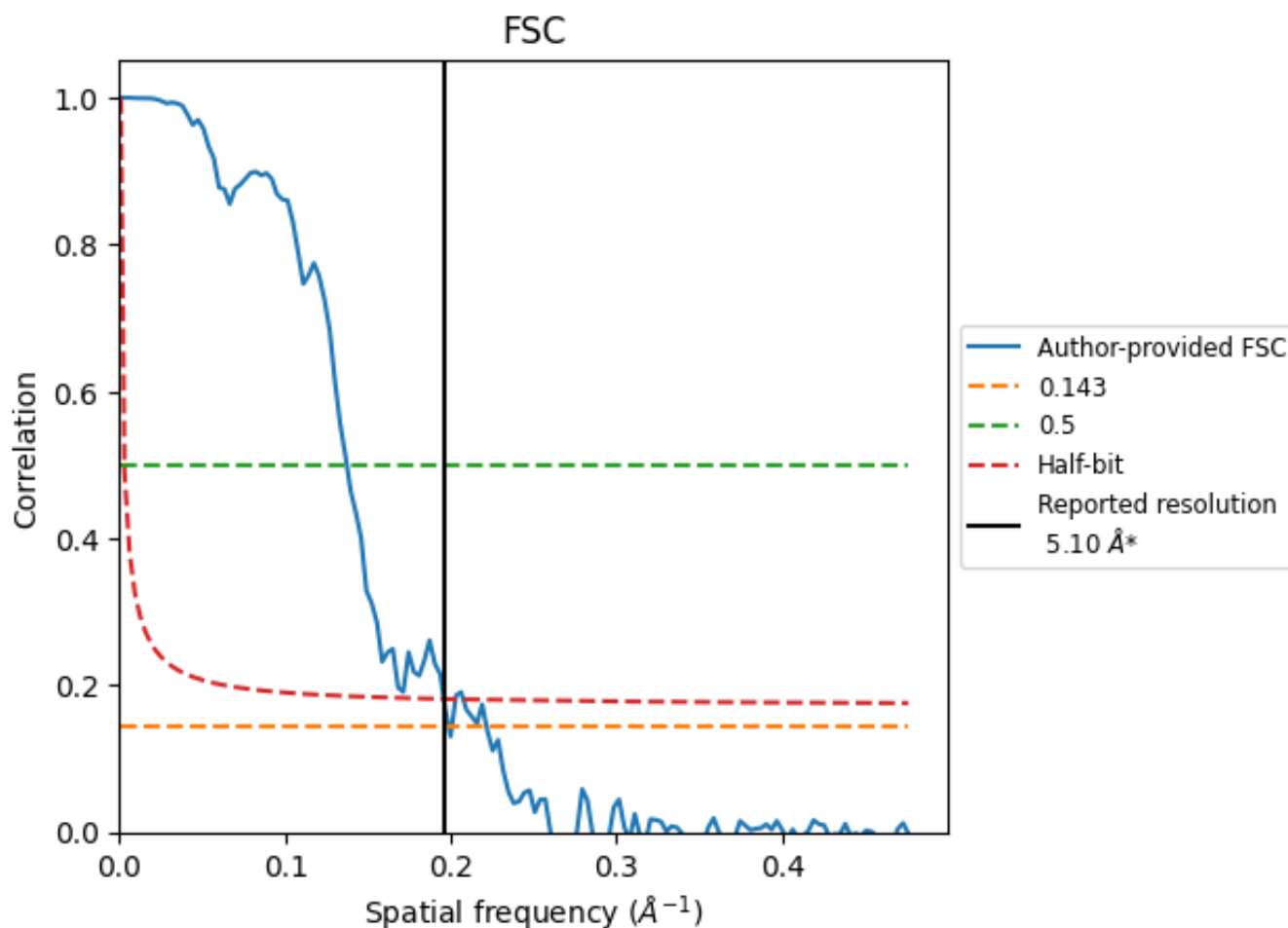

*Reported resolution corresponds to spatial frequency of 0.196\AA^{-1}

8.2 Resolution estimates [i](#)

Resolution estimate (Å)	Estimation criterion (FSC cut-off)		
	0.143	0.5	Half-bit
Reported by author	5.10	-	-
Author-provided FSC curve	5.03	7.28	5.10
Unmasked-calculated*	-	-	-

*Resolution estimate based on FSC curve calculated by comparison of deposited half-maps.

9 Map-model fit [i](#)

This section contains information regarding the fit between EMDB map EMD-13365 and PDB model 7PF2. Per-residue inclusion information can be found in section 3 on page 8.

9.1 Map-model overlay [i](#)



The images above show the 3D surface view of the map at the recommended contour level 0.0215 at 50% transparency in yellow overlaid with a ribbon representation of the model coloured in blue. These images allow for the visual assessment of the quality of fit between the atomic model and the map.

9.2 Atom inclusion [i](#)

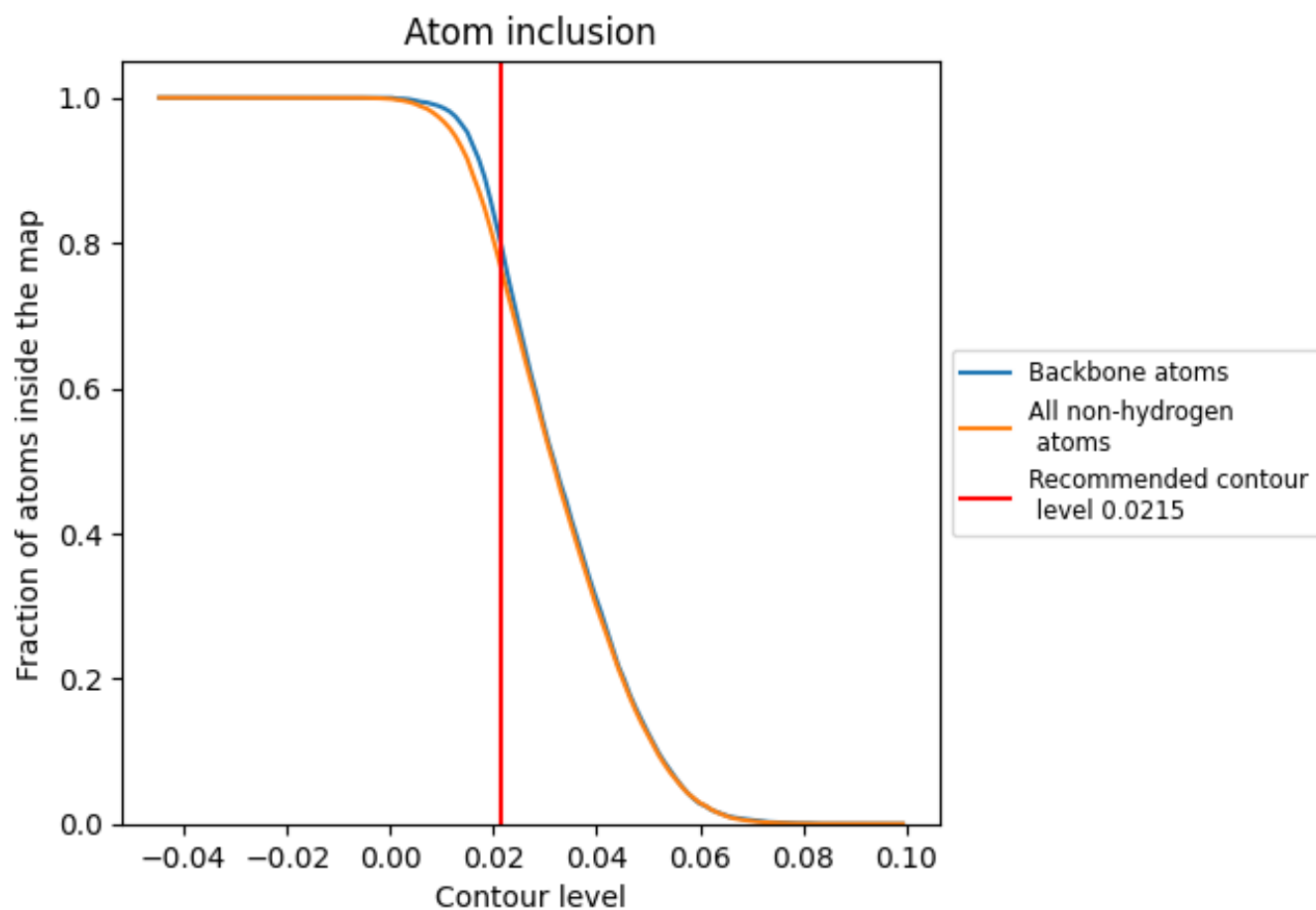

At the recommended contour level, 80% of all backbone atoms, 76% of all non-hydrogen atoms, are inside the map.