



wwPDB X-ray Structure Validation Summary Report ⓘ

Aug 30, 2022 – 04:14 pm BST

PDB ID : 7PHF
Title : Chimeric carminomycin-4-O-methyltransferase (DnrK) with regions from 10-hydroxylase RdmB and 10-decarboxylase TamK
Authors : Dinis, P.; MetsaKetela, M.
Deposited on : 2021-08-17
Resolution : 2.21 Å(reported)

This is a wwPDB X-ray Structure Validation Summary Report for a publicly released PDB entry.

We welcome your comments at validation@mail.wwpdb.org

A user guide is available at

<https://www.wwpdb.org/validation/2017/XrayValidationReportHelp>

with specific help available everywhere you see the ⓘ symbol.

The types of validation reports are described at <http://www.wwpdb.org/validation/2017/FAQs#types>.

The following versions of software and data (see [references ⓘ](#)) were used in the production of this report:

MolProbity : 4.02b-467
Mogul : 1.8.4, CSD as541be (2020)
Xtrriage (Phenix) : 1.13
EDS : 2.30
buster-report : 1.1.7 (2018)
Percentile statistics : 20191225.v01 (using entries in the PDB archive December 25th 2019)
Refmac : 5.8.0267
CCP4 : 7.1.010 (Gargrove)
Ideal geometry (proteins) : Engh & Huber (2001)
Ideal geometry (DNA, RNA) : Parkinson et al. (1996)
Validation Pipeline (wwPDB-VP) : 2.30

1 Overall quality at a glance

The following experimental techniques were used to determine the structure:

X-RAY DIFFRACTION

The reported resolution of this entry is 2.21 Å.

Percentile scores (ranging between 0-100) for global validation metrics of the entry are shown in the following graphic. The table shows the number of entries on which the scores are based.

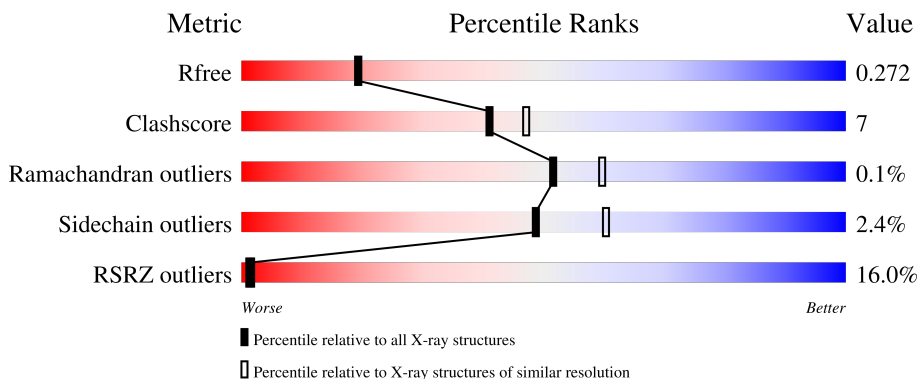

Metric	Whole archive (#Entries)	Similar resolution (#Entries, resolution range(Å))
R_{free}	130704	5912 (2.24-2.20)
Clashscore	141614	6646 (2.24-2.20)
Ramachandran outliers	138981	6543 (2.24-2.20)
Sidechain outliers	138945	6544 (2.24-2.20)
RSRZ outliers	127900	5797 (2.24-2.20)

The table below summarises the geometric issues observed across the polymeric chains and their fit to the electron density. The red, orange, yellow and green segments of the lower bar indicate the fraction of residues that contain outliers for ≥ 3 , 2, 1 and 0 types of geometric quality criteria respectively. A grey segment represents the fraction of residues that are not modelled. The numeric value for each fraction is indicated below the corresponding segment, with a dot representing fractions $\leq 5\%$. The upper red bar (where present) indicates the fraction of residues that have poor fit to the electron density. The numeric value is given above the bar.

Mol	Chain	Length	Quality of chain
1	A	368	
1	B	368	
1	C	368	
1	D	368	

The following table lists non-polymeric compounds, carbohydrate monomers and non-standard

residues in protein, DNA, RNA chains that are outliers for geometric or electron-density-fit criteria:

Mol	Type	Chain	Res	Chirality	Geometry	Clashes	Electron density
3	VAK	B	402	-	-	-	X
3	VAK	C	402	-	-	X	X
3	VAK	D	402	-	-	X	X

2 Entry composition [i](#)

There are 4 unique types of molecules in this entry. The entry contains 9818 atoms, of which 0 are hydrogens and 0 are deuteriums.

In the tables below, the ZeroOcc column contains the number of atoms modelled with zero occupancy, the AltConf column contains the number of residues with at least one atom in alternate conformation and the Trace column contains the number of residues modelled with at most 2 atoms.

- Molecule 1 is a protein called Carminomycin 4-O-methyltransferase DnrK, Methyltransferase domain-containing protein, Aclacinomycin 10-hydroxylase RdmB.

Mol	Chain	Residues	Atoms					ZeroOcc	AltConf	Trace
			Total	C	N	O	S			
1	A	333	Total 2497	C 1587	N 445	O 459	S 6	0	2	1
1	B	270	Total 1966	C 1259	N 346	O 356	S 5	8	1	0
1	C	329	Total 2488	C 1583	N 448	O 451	S 6	4	3	1
1	D	331	Total 2450	C 1564	N 436	O 444	S 6	0	0	1

There are 48 discrepancies between the modelled and reference sequences:

Chain	Residue	Modelled	Actual	Comment	Reference
A	-9	MET	-	initiating methionine	UNP Q06528
A	-8	ALA	-	expression tag	UNP Q06528
A	-7	HIS	-	expression tag	UNP Q06528
A	-6	HIS	-	expression tag	UNP Q06528
A	-5	HIS	-	expression tag	UNP Q06528
A	-4	HIS	-	expression tag	UNP Q06528
A	-3	HIS	-	expression tag	UNP Q06528
A	-2	HIS	-	expression tag	UNP Q06528
A	-1	HIS	-	expression tag	UNP Q06528
A	0	ARG	-	expression tag	UNP Q06528
A	1	SER	-	expression tag	UNP Q06528
A	190	ASN	LYS	engineered mutation	UNP Q06528
B	-9	MET	-	initiating methionine	UNP Q06528
B	-8	ALA	-	expression tag	UNP Q06528
B	-7	HIS	-	expression tag	UNP Q06528
B	-6	HIS	-	expression tag	UNP Q06528
B	-5	HIS	-	expression tag	UNP Q06528
B	-4	HIS	-	expression tag	UNP Q06528
B	-3	HIS	-	expression tag	UNP Q06528
B	-2	HIS	-	expression tag	UNP Q06528

Continued on next page...

Continued from previous page...

Chain	Residue	Modelled	Actual	Comment	Reference
B	-1	HIS	-	expression tag	UNP Q06528
B	0	ARG	-	expression tag	UNP Q06528
B	1	SER	-	expression tag	UNP Q06528
B	190	ASN	LYS	engineered mutation	UNP Q06528
C	-9	MET	-	initiating methionine	UNP Q06528
C	-8	ALA	-	expression tag	UNP Q06528
C	-7	HIS	-	expression tag	UNP Q06528
C	-6	HIS	-	expression tag	UNP Q06528
C	-5	HIS	-	expression tag	UNP Q06528
C	-4	HIS	-	expression tag	UNP Q06528
C	-3	HIS	-	expression tag	UNP Q06528
C	-2	HIS	-	expression tag	UNP Q06528
C	-1	HIS	-	expression tag	UNP Q06528
C	0	ARG	-	expression tag	UNP Q06528
C	1	SER	-	expression tag	UNP Q06528
C	190	ASN	LYS	engineered mutation	UNP Q06528
D	-9	MET	-	initiating methionine	UNP Q06528
D	-8	ALA	-	expression tag	UNP Q06528
D	-7	HIS	-	expression tag	UNP Q06528
D	-6	HIS	-	expression tag	UNP Q06528
D	-5	HIS	-	expression tag	UNP Q06528
D	-4	HIS	-	expression tag	UNP Q06528
D	-3	HIS	-	expression tag	UNP Q06528
D	-2	HIS	-	expression tag	UNP Q06528
D	-1	HIS	-	expression tag	UNP Q06528
D	0	ARG	-	expression tag	UNP Q06528
D	1	SER	-	expression tag	UNP Q06528
D	190	ASN	LYS	engineered mutation	UNP Q06528

- Molecule 2 is S-ADENOSYL-L-HOMOCYSTEINE (three-letter code: SAH) (formula: C₁₄H₂₀N₆O₅S) (labeled as "Ligand of Interest" by depositor).

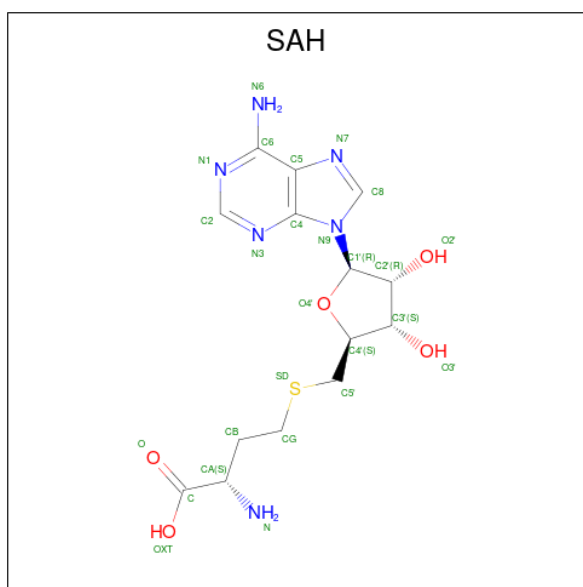

Mol	Chain	Residues	Atoms				ZeroOcc	AltConf	
			Total	C	N	O			S
2	A	1	Total	C	N	O	S	0	0
			26	14	6	5	1		
2	B	1	Total	C	N	O	S	0	0
			26	14	6	5	1		
2	C	1	Total	C	N	O	S	0	0
			26	14	6	5	1		
2	D	1	Total	C	N	O	S	0	0
			26	14	6	5	1		

- Molecule 3 is methyl (1R,2R,4S)-2-ethyl-2,4,5,7-tetrahydroxy-6,11-dioxo-1,2,3,4,6,11-hexahydrotetracene-1-carboxylate (three-letter code: VAK) (formula: $C_{22}H_{20}O_8$) (labeled as "Ligand of Interest" by depositor).

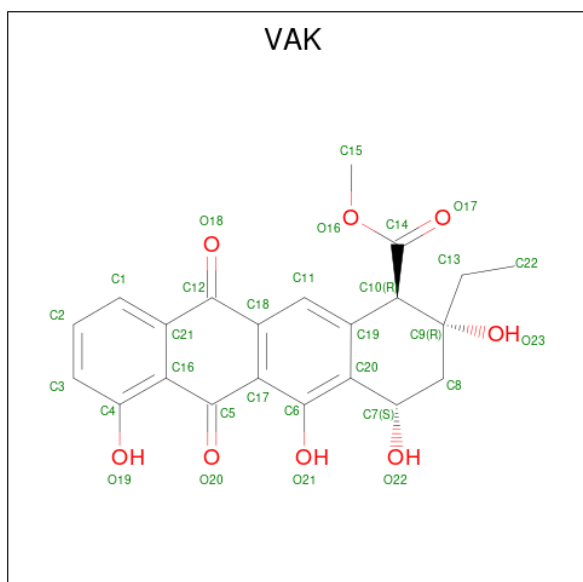

Mol	Chain	Residues	Atoms			ZeroOcc	AltConf
3	B	1	Total	C	O	0	0
			30	22	8		
3	C	1	Total	C	O	0	0
			30	22	8		
3	D	1	Total	C	O	0	0
			30	22	8		

- Molecule 4 is water.

Mol	Chain	Residues	Atoms		ZeroOcc	AltConf
4	A	51	Total	O	0	0
			51	51		
4	B	40	Total	O	0	0
			40	40		
4	C	61	Total	O	0	0
			61	61		
4	D	71	Total	O	0	0
			71	71		

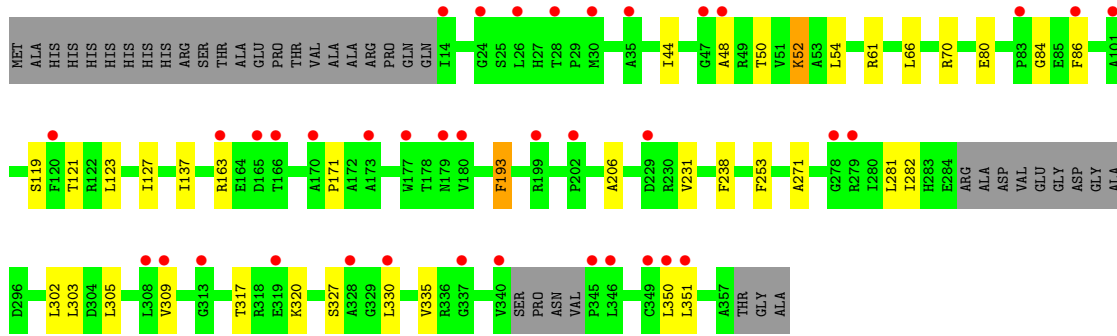

● Molecule 1: Carminomycin 4-O-methyltransferase DnrK, Methyltransferase domain-containing protein, Aclacinomycin 10-hydroxylase RdmB

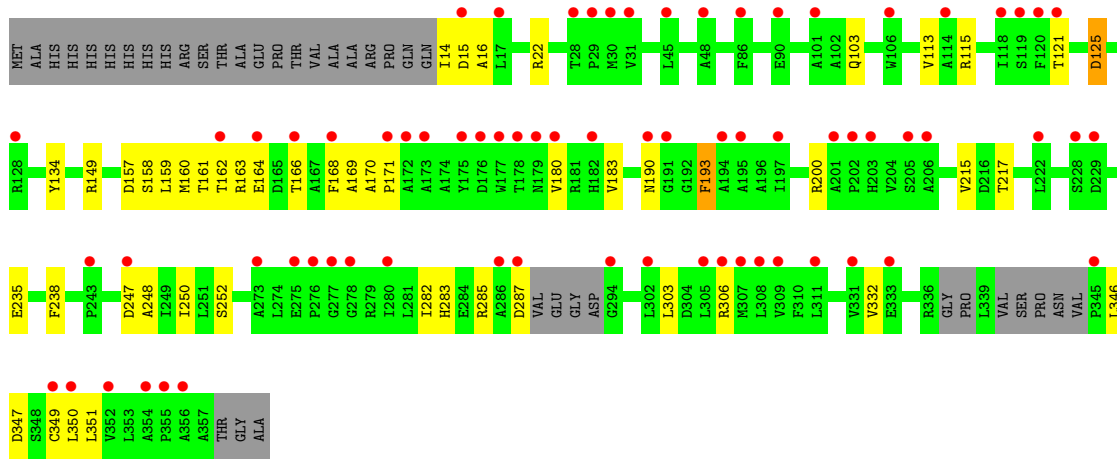
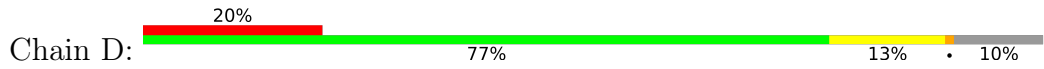

4 Data and refinement statistics

Property	Value	Source
Space group	P 1 21 1	Depositor
Cell constants a, b, c, α , β , γ	60.01Å 102.42Å 122.19Å 90.00° 99.30° 90.00°	Depositor
Resolution (Å)	47.13 – 2.21 47.13 – 2.21	Depositor EDS
% Data completeness (in resolution range)	99.5 (47.13-2.21) 99.5 (47.13-2.21)	Depositor EDS
R_{merge}	0.15	Depositor
R_{sym}	(Not available)	Depositor
$\langle I/\sigma(I) \rangle$ ¹	1.20 (at 2.22Å)	Xtrriage
Refinement program	PHENIX 1.19.2_4158, PHENIX 1.19.2_4158	Depositor
R, R_{free}	0.235 , 0.274 0.236 , 0.272	Depositor DCC
R_{free} test set	1993 reflections (2.76%)	wwPDB-VP
Wilson B-factor (Å ²)	44.6	Xtrriage
Anisotropy	0.394	Xtrriage
Bulk solvent k_{sol} (e/Å ³), B_{sol} (Å ²)	(Not available) , (Not available)	EDS
L-test for twinning ²	$\langle L \rangle = 0.48$, $\langle L^2 \rangle = 0.31$	Xtrriage
Estimated twinning fraction	No twinning to report.	Xtrriage
F_o, F_c correlation	0.94	EDS
Total number of atoms	9818	wwPDB-VP
Average B, all atoms (Å ²)	48.0	wwPDB-VP

Xtrriage's analysis on translational NCS is as follows: *The analyses of the Patterson function reveals a significant off-origin peak that is 39.08 % of the origin peak, indicating pseudo-translational symmetry. The chance of finding a peak of this or larger height randomly in a structure without pseudo-translational symmetry is equal to 3.3466e-04. The detected translational NCS is most likely also responsible for the elevated intensity ratio.*

¹Intensities estimated from amplitudes.

²Theoretical values of $\langle |L| \rangle$, $\langle L^2 \rangle$ for acentric reflections are 0.5, 0.333 respectively for untwinned datasets, and 0.375, 0.2 for perfectly twinned datasets.

5 Model quality [i](#)

5.1 Standard geometry [i](#)

Bond lengths and bond angles in the following residue types are not validated in this section: SAH, VAK

The Z score for a bond length (or angle) is the number of standard deviations the observed value is removed from the expected value. A bond length (or angle) with $|Z| > 5$ is considered an outlier worth inspection. RMSZ is the root-mean-square of all Z scores of the bond lengths (or angles).

Mol	Chain	Bond lengths		Bond angles	
		RMSZ	# Z >5	RMSZ	# Z >5
1	A	0.37	0/2554	0.64	0/3489
1	B	0.40	0/1994	0.65	0/2718
1	C	0.42	0/2547	0.67	0/3470
1	D	0.45	0/2497	0.65	0/3406
All	All	0.41	0/9592	0.65	0/13083

There are no bond length outliers.

There are no bond angle outliers.

There are no chirality outliers.

There are no planarity outliers.

5.2 Too-close contacts [i](#)

In the following table, the Non-H and H(model) columns list the number of non-hydrogen atoms and hydrogen atoms in the chain respectively. The H(added) column lists the number of hydrogen atoms added and optimized by MolProbity. The Clashes column lists the number of clashes within the asymmetric unit, whereas Symm-Clashes lists symmetry-related clashes.

Mol	Chain	Non-H	H(model)	H(added)	Clashes	Symm-Clashes
1	A	2497	0	2483	26	0
1	B	1966	0	1901	23	0
1	C	2488	0	2498	38	0
1	D	2450	0	2431	49	0
2	A	26	0	19	0	0
2	B	26	0	19	1	0
2	C	26	0	19	0	0
2	D	26	0	19	0	0
3	B	30	0	20	1	0

Continued on next page...

Continued from previous page...

Mol	Chain	Non-H	H(model)	H(added)	Clashes	Symm-Clashes
3	C	30	0	19	22	0
3	D	30	0	18	20	0
4	A	51	0	0	3	0
4	B	40	0	0	4	0
4	C	61	0	0	0	0
4	D	71	0	0	5	0
All	All	9818	0	9446	135	0

The all-atom clashscore is defined as the number of clashes found per 1000 atoms (including hydrogen atoms). The all-atom clashscore for this structure is 7.

The worst 5 of 135 close contacts within the same asymmetric unit are listed below, sorted by their clash magnitude.

Atom-1	Atom-2	Interatomic distance (Å)	Clash overlap (Å)
1:C:303:LEU:HD22	3:C:402:VAK:C22	1.41	1.48
1:D:346:LEU:HD22	3:D:402:VAK:C22	1.67	1.22
1:C:303:LEU:HD22	3:C:402:VAK:H22B	1.18	1.12
1:C:303:LEU:CD2	3:C:402:VAK:C22	2.27	1.11
1:D:346:LEU:HD22	3:D:402:VAK:H22	1.11	1.07

There are no symmetry-related clashes.

5.3 Torsion angles [i](#)

5.3.1 Protein backbone [i](#)

In the following table, the Percentiles column shows the percent Ramachandran outliers of the chain as a percentile score with respect to all X-ray entries followed by that with respect to entries of similar resolution.

The Analysed column shows the number of residues for which the backbone conformation was analysed, and the total number of residues.

Mol	Chain	Analysed	Favoured	Allowed	Outliers	Percentiles
1	A	331/368 (90%)	322 (97%)	9 (3%)	0	100 100
1	B	248/368 (67%)	239 (96%)	8 (3%)	1 (0%)	34 37
1	C	326/368 (89%)	319 (98%)	7 (2%)	0	100 100
1	D	324/368 (88%)	317 (98%)	7 (2%)	0	100 100
All	All	1229/1472 (84%)	1197 (97%)	31 (2%)	1 (0%)	51 60

All (1) Ramachandran outliers are listed below:

Mol	Chain	Res	Type
1	B	169	ALA

5.3.2 Protein sidechains [i](#)

In the following table, the Percentiles column shows the percent sidechain outliers of the chain as a percentile score with respect to all X-ray entries followed by that with respect to entries of similar resolution.

The Analysed column shows the number of residues for which the sidechain conformation was analysed, and the total number of residues.

Mol	Chain	Analysed	Rotameric	Outliers	Percentiles	
1	A	251/288 (87%)	246 (98%)	5 (2%)	55	67
1	B	186/288 (65%)	179 (96%)	7 (4%)	33	41
1	C	250/288 (87%)	245 (98%)	5 (2%)	55	67
1	D	239/288 (83%)	234 (98%)	5 (2%)	53	65
All	All	926/1152 (80%)	904 (98%)	22 (2%)	49	60

5 of 22 residues with a non-rotameric sidechain are listed below:

Mol	Chain	Res	Type
1	C	193	PHE
1	D	125	ASP
1	C	327	SER
1	D	193	PHE
1	B	63	GLU

Sometimes sidechains can be flipped to improve hydrogen bonding and reduce clashes. All (1) such sidechains are listed below:

Mol	Chain	Res	Type
1	B	257	ASN

5.3.3 RNA [i](#)

There are no RNA molecules in this entry.

5.4 Non-standard residues in protein, DNA, RNA chains [i](#)

There are no non-standard protein/DNA/RNA residues in this entry.

5.5 Carbohydrates [i](#)

There are no monosaccharides in this entry.

5.6 Ligand geometry [i](#)

7 ligands are modelled in this entry.

In the following table, the Counts columns list the number of bonds (or angles) for which Mogul statistics could be retrieved, the number of bonds (or angles) that are observed in the model and the number of bonds (or angles) that are defined in the Chemical Component Dictionary. The Link column lists molecule types, if any, to which the group is linked. The Z score for a bond length (or angle) is the number of standard deviations the observed value is removed from the expected value. A bond length (or angle) with $|Z| > 2$ is considered an outlier worth inspection. RMSZ is the root-mean-square of all Z scores of the bond lengths (or angles).

Mol	Type	Chain	Res	Link	Bond lengths			Bond angles		
					Counts	RMSZ	# Z > 2	Counts	RMSZ	# Z > 2
2	SAH	B	401	-	24,28,28	0.98	1 (4%)	25,40,40	1.39	3 (12%)
2	SAH	C	401	-	24,28,28	1.09	3 (12%)	25,40,40	1.93	7 (28%)
2	SAH	A	401	-	24,28,28	1.19	3 (12%)	25,40,40	1.67	5 (20%)
3	VAK	C	402	-	32,33,33	2.40	8 (25%)	44,52,52	1.76	7 (15%)
2	SAH	D	401	-	24,28,28	1.27	2 (8%)	25,40,40	1.70	5 (20%)
3	VAK	B	402	-	32,33,33	2.47	8 (25%)	44,52,52	1.24	4 (9%)
3	VAK	D	402	-	32,33,33	2.46	7 (21%)	44,52,52	1.61	5 (11%)

In the following table, the Chirals column lists the number of chiral outliers, the number of chiral centers analysed, the number of these observed in the model and the number defined in the Chemical Component Dictionary. Similar counts are reported in the Torsion and Rings columns. '-' means no outliers of that kind were identified.

Mol	Type	Chain	Res	Link	Chirals	Torsions	Rings
2	SAH	B	401	-	-	4/11/31/31	0/3/3/3
2	SAH	C	401	-	-	2/11/31/31	0/3/3/3
2	SAH	A	401	-	-	1/11/31/31	0/3/3/3
3	VAK	C	402	-	-	7/9/44/44	0/4/4/4
2	SAH	D	401	-	-	0/11/31/31	0/3/3/3

Continued on next page...

Continued from previous page...

Mol	Type	Chain	Res	Link	Chirals	Torsions	Rings
3	VAK	B	402	-	-	2/9/44/44	0/4/4/4
3	VAK	D	402	-	-	3/9/44/44	0/4/4/4

The worst 5 of 32 bond length outliers are listed below:

Mol	Chain	Res	Type	Atoms	Z	Observed(Å)	Ideal(Å)
3	D	402	VAK	C20-C19	7.07	1.49	1.40
3	B	402	VAK	C20-C19	6.57	1.49	1.40
3	C	402	VAK	C20-C19	6.32	1.48	1.40
3	D	402	VAK	O16-C14	5.78	1.47	1.33
3	B	402	VAK	O16-C14	5.63	1.46	1.33

The worst 5 of 36 bond angle outliers are listed below:

Mol	Chain	Res	Type	Atoms	Z	Observed(°)	Ideal(°)
3	D	402	VAK	O16-C14-C10	5.98	124.34	110.86
3	C	402	VAK	C22-C13-C9	5.95	124.59	115.20
2	A	401	SAH	N3-C2-N1	-5.18	120.58	128.68
3	C	402	VAK	O16-C14-C10	5.05	122.26	110.86
2	D	401	SAH	N3-C2-N1	-5.00	120.86	128.68

There are no chirality outliers.

5 of 19 torsion outliers are listed below:

Mol	Chain	Res	Type	Atoms
3	B	402	VAK	C10-C14-O16-C15
3	C	402	VAK	C22-C13-C9-C10
3	C	402	VAK	C22-C13-C9-O23
3	D	402	VAK	C10-C14-O16-C15
3	C	402	VAK	O17-C14-O16-C15

There are no ring outliers.

4 monomers are involved in 44 short contacts:

Mol	Chain	Res	Type	Clashes	Symm-Clashes
2	B	401	SAH	1	0
3	C	402	VAK	22	0
3	B	402	VAK	1	0
3	D	402	VAK	20	0

The following is a two-dimensional graphical depiction of Mogul quality analysis of bond lengths,

bond angles, torsion angles, and ring geometry for all instances of the Ligand of Interest. In addition, ligands with molecular weight > 250 and outliers as shown on the validation Tables will also be included. For torsion angles, if less than 5% of the Mogul distribution of torsion angles is within 10 degrees of the torsion angle in question, then that torsion angle is considered an outlier. Any bond that is central to one or more torsion angles identified as an outlier by Mogul will be highlighted in the graph. For rings, the root-mean-square deviation (RMSD) between the ring in question and similar rings identified by Mogul is calculated over all ring torsion angles. If the average RMSD is greater than 60 degrees and the minimal RMSD between the ring in question and any Mogul-identified rings is also greater than 60 degrees, then that ring is considered an outlier. The outliers are highlighted in purple. The color gray indicates Mogul did not find sufficient equivalents in the CSD to analyse the geometry.

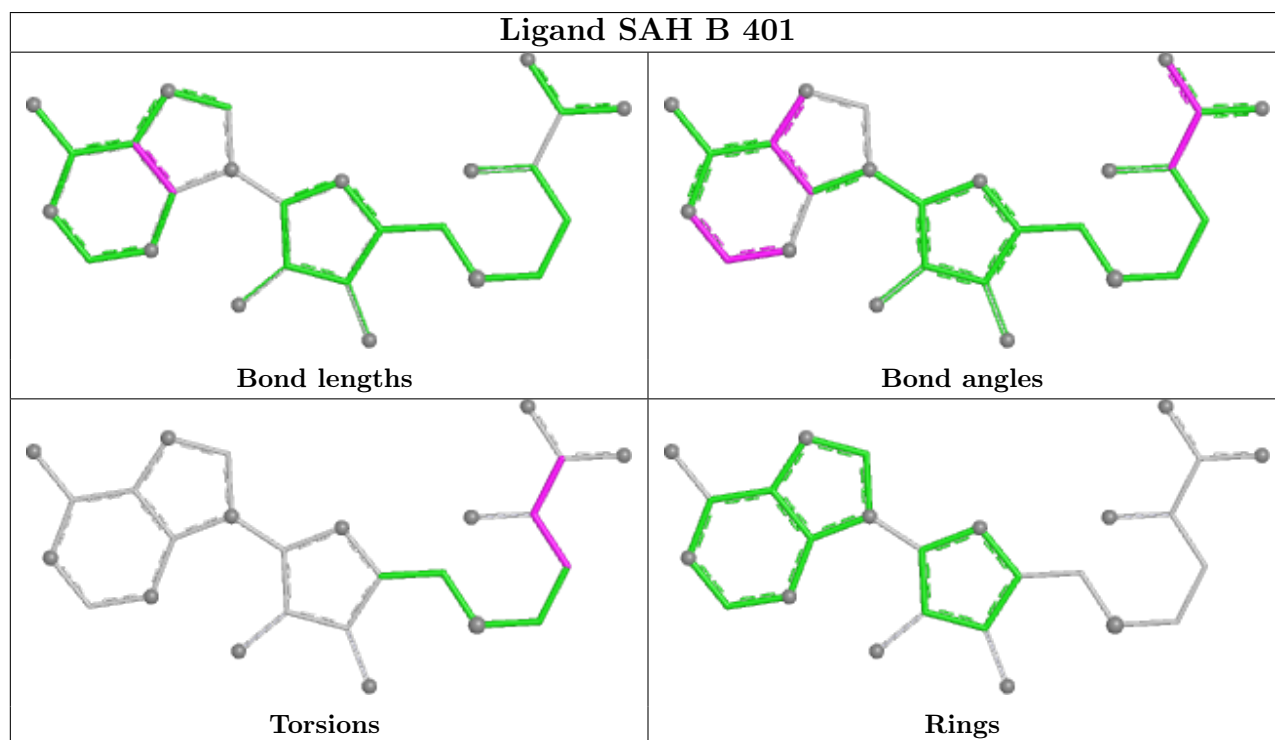

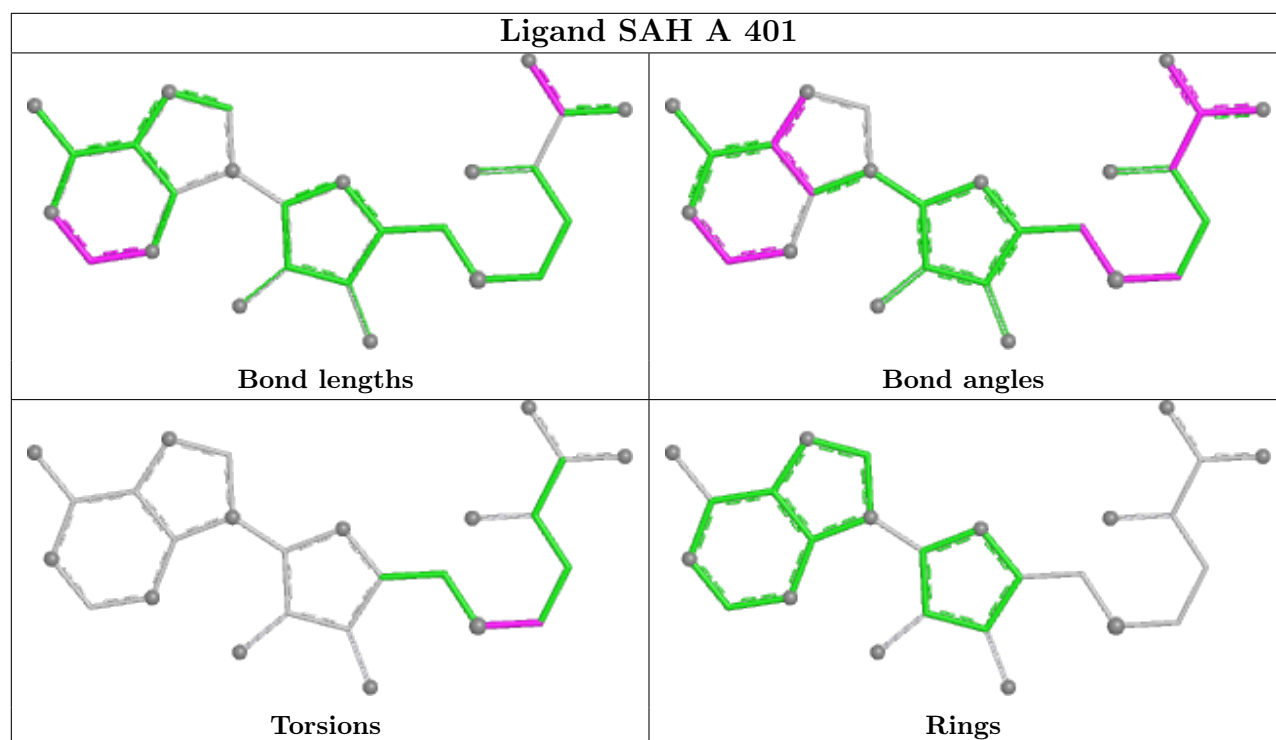
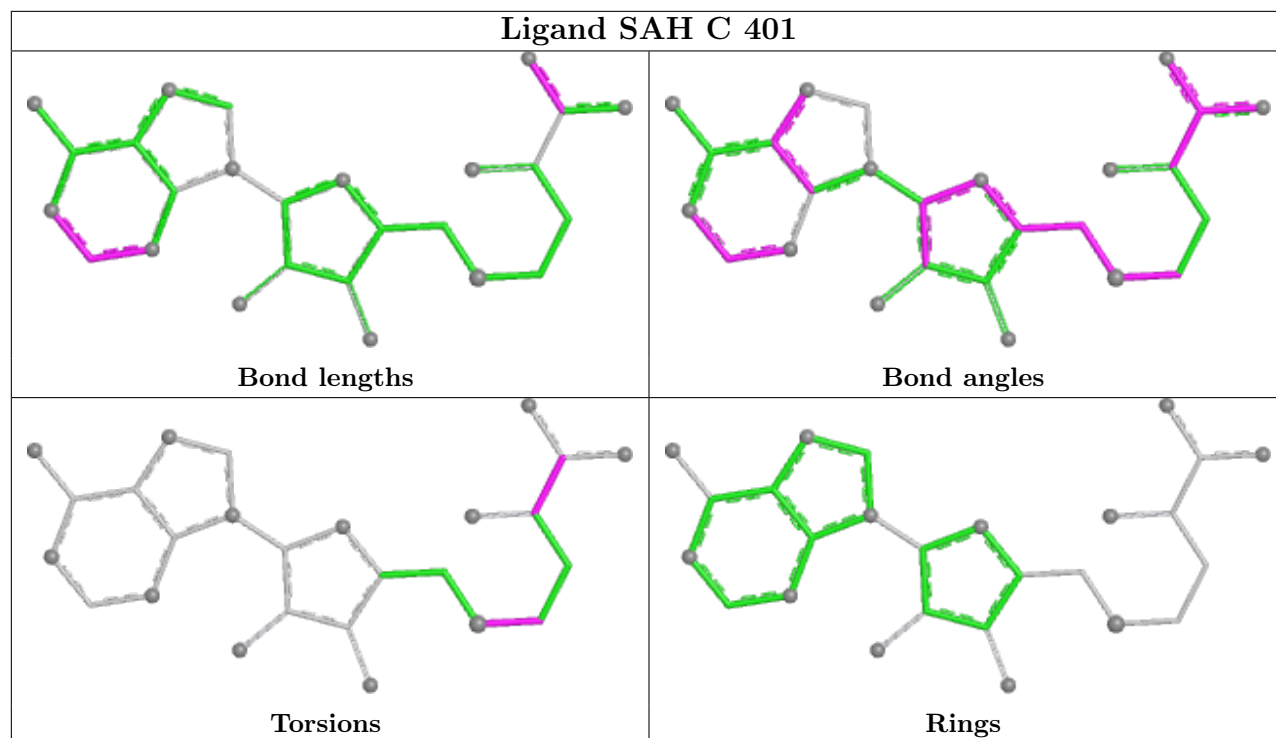

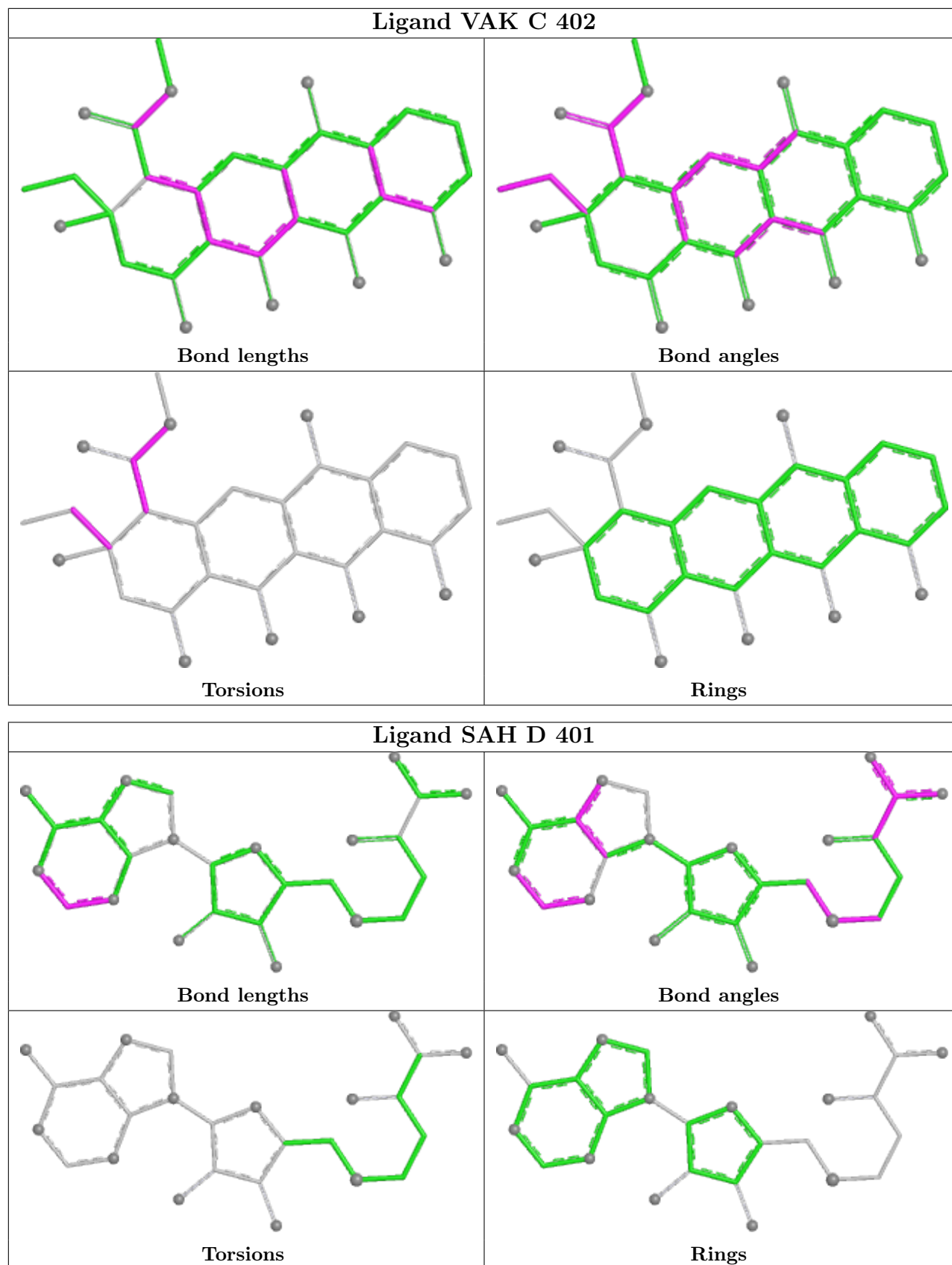

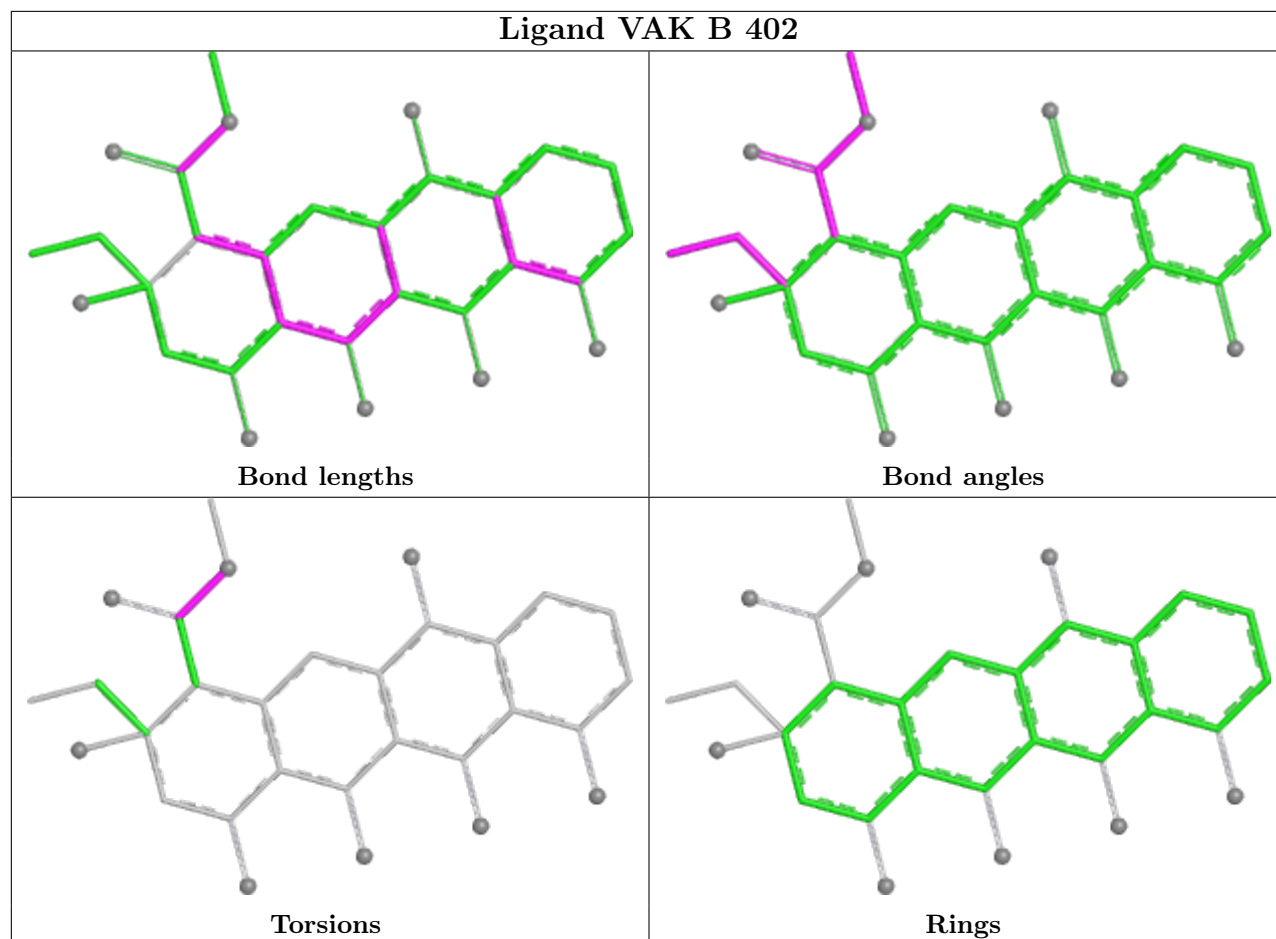

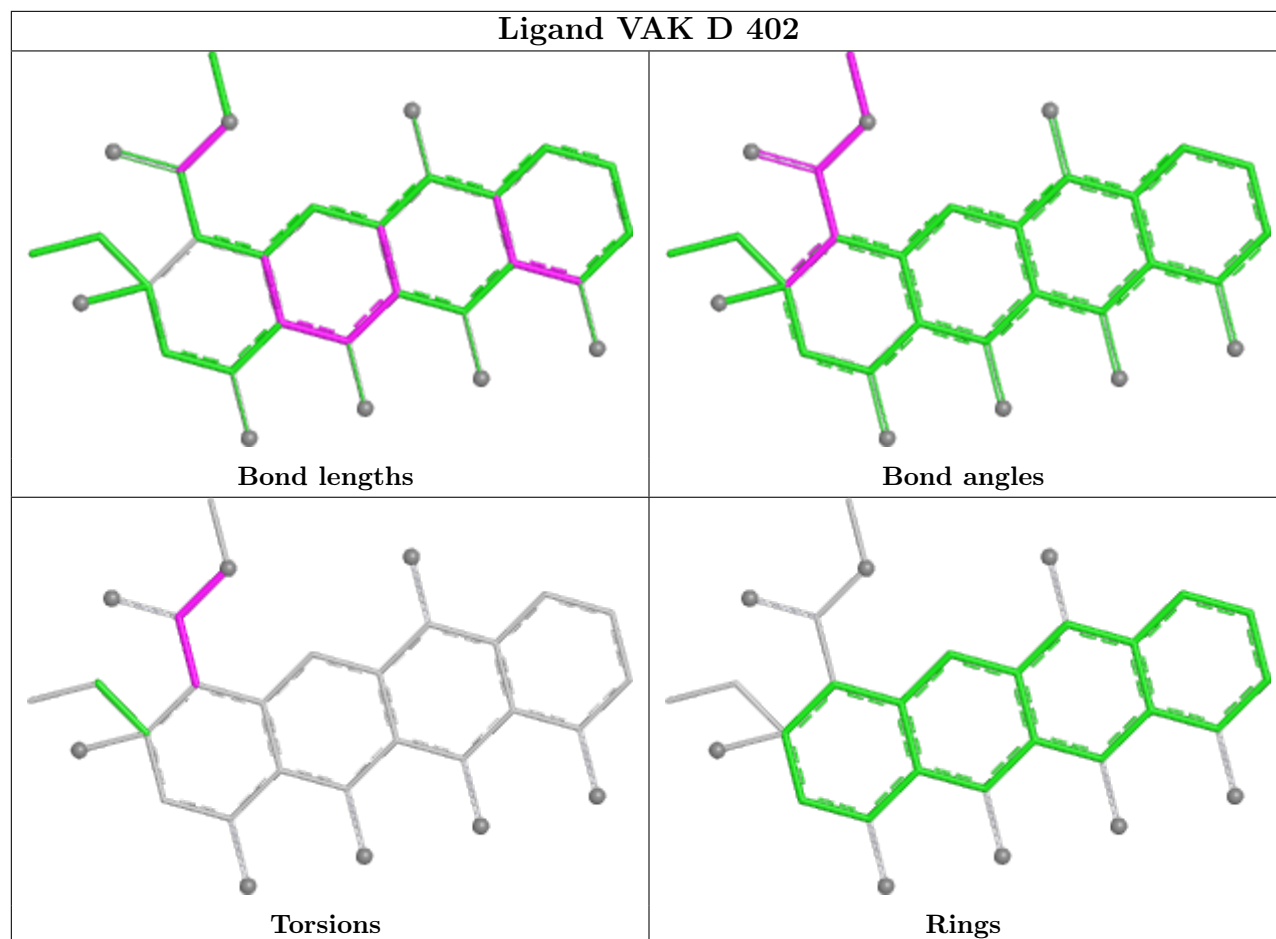

5.7 Other polymers [\(i\)](#)

There are no such residues in this entry.

5.8 Polymer linkage issues [\(i\)](#)

There are no chain breaks in this entry.

6 Fit of model and data [i](#)

6.1 Protein, DNA and RNA chains [i](#)

In the following table, the column labelled ‘#RSRZ> 2’ contains the number (and percentage) of RSRZ outliers, followed by percent RSRZ outliers for the chain as percentile scores relative to all X-ray entries and entries of similar resolution. The OWAB column contains the minimum, median, 95th percentile and maximum values of the occupancy-weighted average B-factor per residue. The column labelled ‘Q< 0.9’ lists the number of (and percentage) of residues with an average occupancy less than 0.9.

Mol	Chain	Analysed	<RSRZ>	#RSRZ>2	OWAB(Å ²)	Q<0.9
1	A	333/368 (90%)	1.01	42 (12%) 3 3	36, 50, 71, 81	0
1	B	270/368 (73%)	1.23	50 (18%) 1 1	30, 55, 71, 85	0
1	C	329/368 (89%)	0.93	38 (11%) 4 4	32, 43, 65, 76	0
1	D	331/368 (89%)	1.26	72 (21%) 0 0	31, 43, 63, 80	0
All	All	1263/1472 (85%)	1.10	202 (15%) 1 1	30, 47, 69, 85	0

The worst 5 of 202 RSRZ outliers are listed below:

Mol	Chain	Res	Type	RSRZ
1	C	166	THR	8.6
1	B	248	ALA	8.0
1	A	82	ALA	6.4
1	B	340	VAL	6.3
1	B	171	PRO	5.9

6.2 Non-standard residues in protein, DNA, RNA chains [i](#)

There are no non-standard protein/DNA/RNA residues in this entry.

6.3 Carbohydrates [i](#)

There are no monosaccharides in this entry.

6.4 Ligands [i](#)

In the following table, the Atoms column lists the number of modelled atoms in the group and the number defined in the chemical component dictionary. The B-factors column lists the minimum, median, 95th percentile and maximum values of B factors of atoms in the group. The column labelled ‘Q< 0.9’ lists the number of atoms with occupancy less than 0.9.

Mol	Type	Chain	Res	Atoms	RSCC	RSR	B-factors(\AA^2)	Q<0.9
3	VAK	C	402	30/30	0.61	0.57	12,23,43,49	30
3	VAK	B	402	30/30	0.65	0.47	49,61,76,76	30
3	VAK	D	402	30/30	0.66	0.46	13,26,47,54	30
2	SAH	B	401	26/26	0.75	0.25	59,71,79,81	0
2	SAH	C	401	26/26	0.91	0.17	29,37,42,44	0
2	SAH	A	401	26/26	0.92	0.17	35,41,46,47	0
2	SAH	D	401	26/26	0.93	0.15	29,35,40,43	0

The following is a graphical depiction of the model fit to experimental electron density of all instances of the Ligand of Interest. In addition, ligands with molecular weight > 250 and outliers as shown on the geometry validation Tables will also be included. Each fit is shown from different orientation to approximate a three-dimensional view.

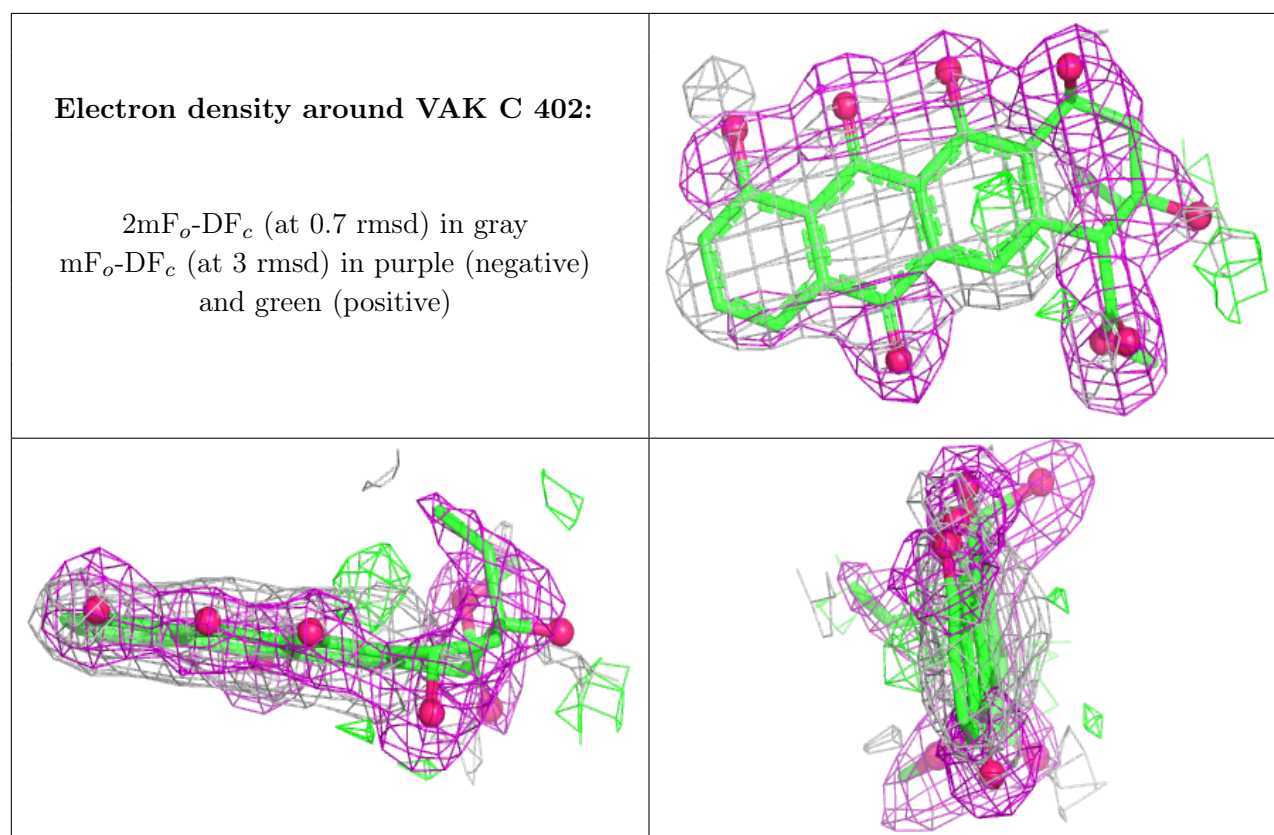

Electron density around VAK B 402:

$2mF_o-DF_c$ (at 0.7 rmsd) in gray
 mF_o-DF_c (at 3 rmsd) in purple (negative)
and green (positive)

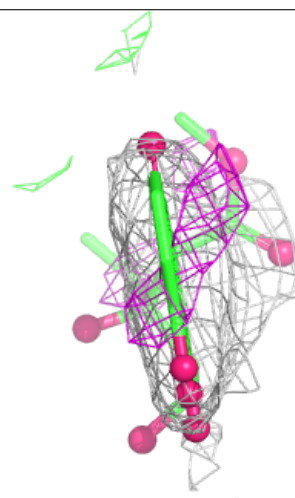
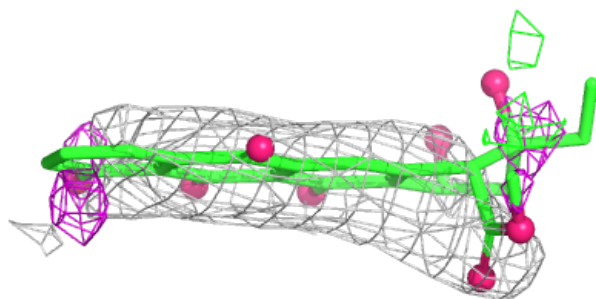
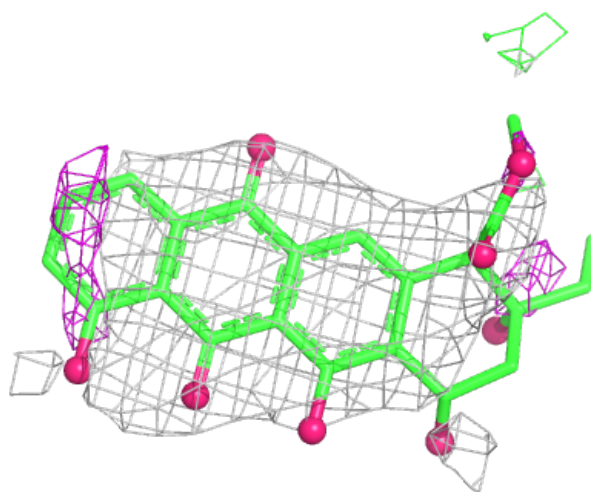

Electron density around VAK D 402:

$2mF_o-DF_c$ (at 0.7 rmsd) in gray
 mF_o-DF_c (at 3 rmsd) in purple (negative)
and green (positive)

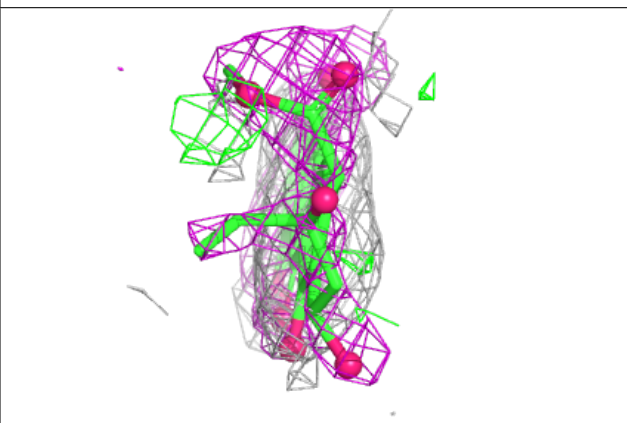
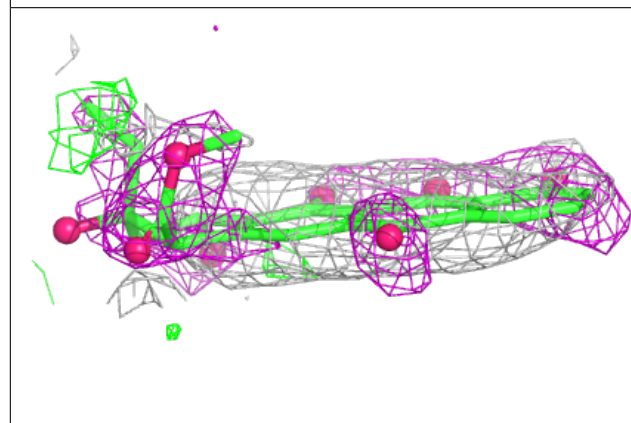
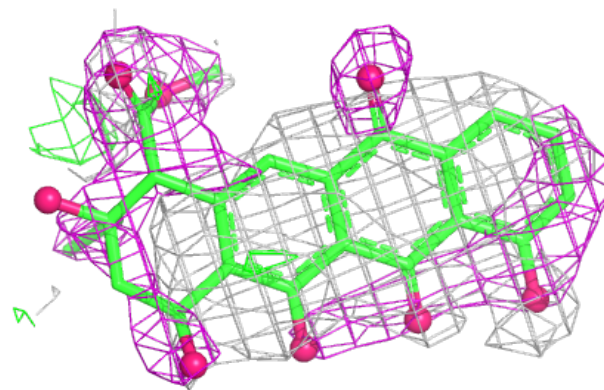
**Electron density around SAH B 401:**

$2mF_o-DF_c$ (at 0.7 rmsd) in gray
 mF_o-DF_c (at 3 rmsd) in purple (negative)
and green (positive)

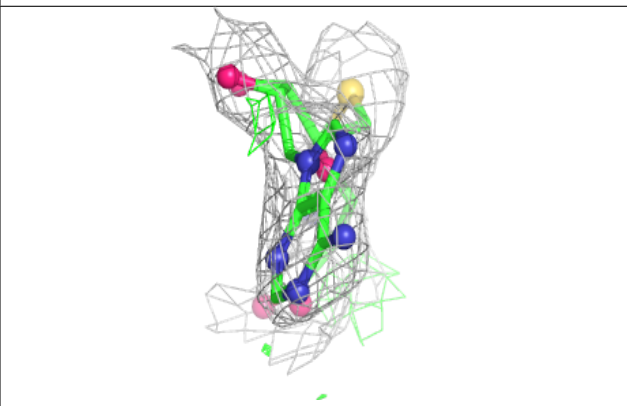
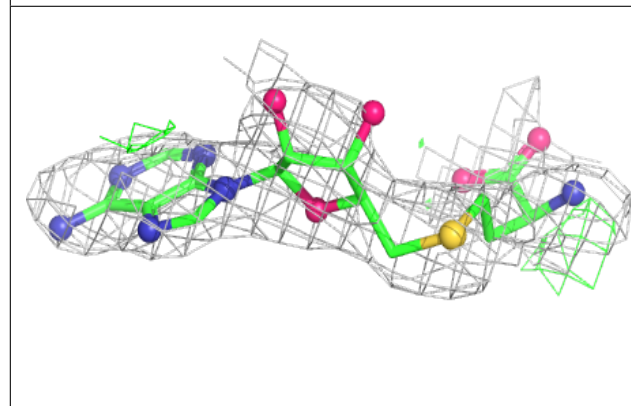
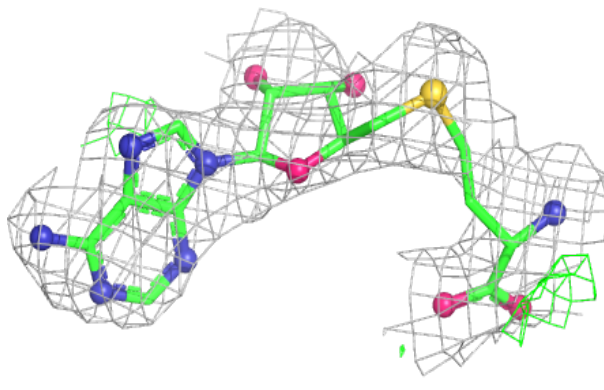

Electron density around SAH C 401:

$2mF_o-DF_c$ (at 0.7 rmsd) in gray
 mF_o-DF_c (at 3 rmsd) in purple (negative)
and green (positive)

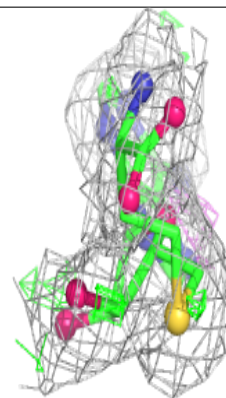
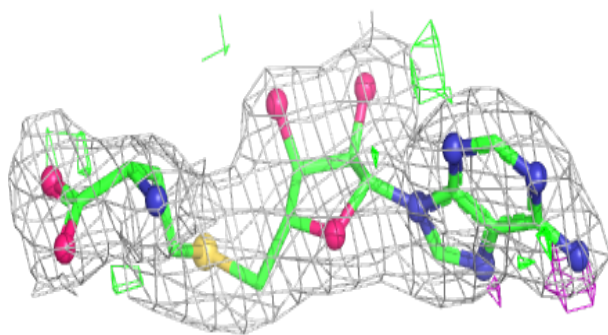
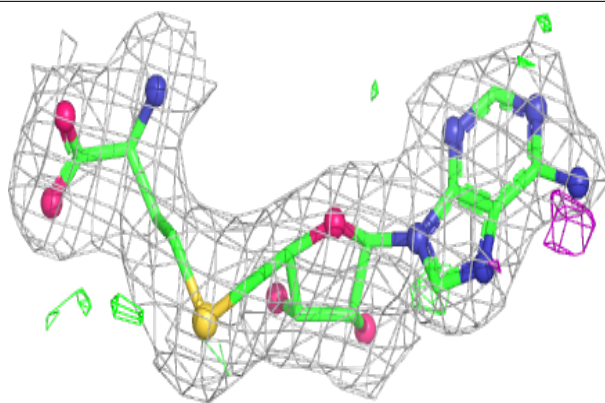
**Electron density around SAH A 401:**

$2mF_o-DF_c$ (at 0.7 rmsd) in gray
 mF_o-DF_c (at 3 rmsd) in purple (negative)
and green (positive)

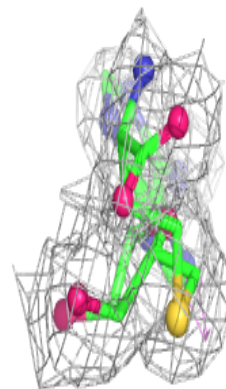
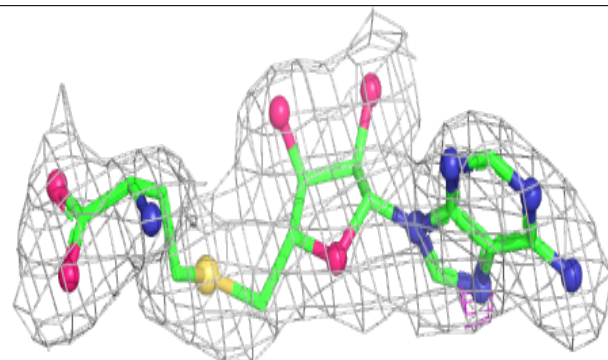
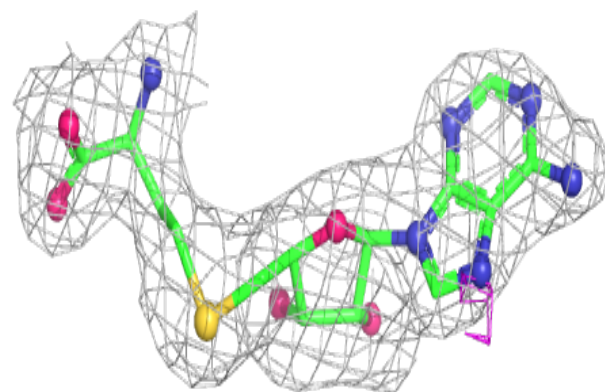

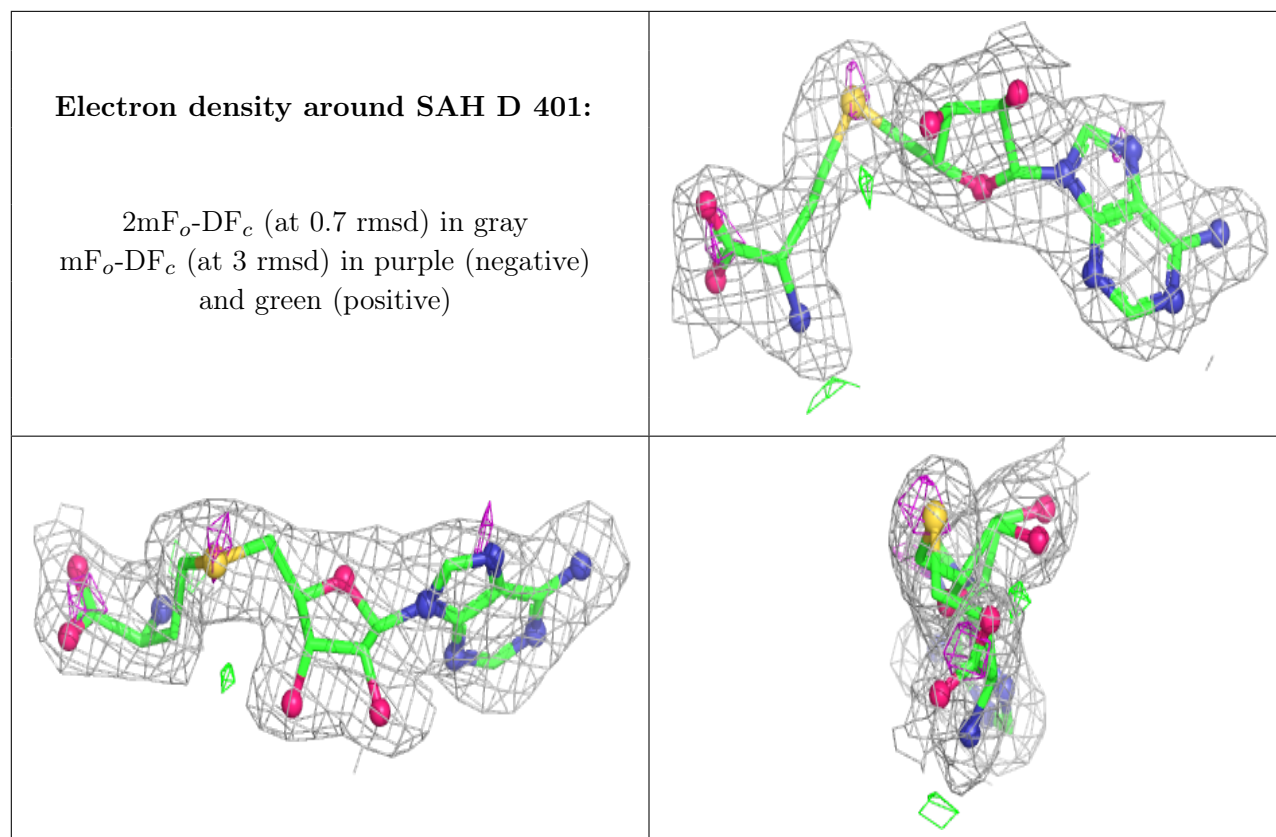

6.5 Other polymers [i](#)

There are no such residues in this entry.