



wwPDB EM Validation Summary Report ⓘ

Oct 25, 2023 – 09:14 am BST

PDB ID : 8PHU
EMDB ID : EMD-17675
Title : Asymmetric structure of the portal-containing cap of the Borrelia bacteriophage BB1 procapsid
Authors : Rumnieks, J.; Fuzik, T.; Tars, K.
Deposited on : 2023-06-20
Resolution : 7.41 Å(reported)
Based on initial model : .

This is a wwPDB EM Validation Summary Report for a publicly released PDB entry.

We welcome your comments at validation@mail.wwpdb.org

A user guide is available at

<https://www.wwpdb.org/validation/2017/EMValidationReportHelp>

with specific help available everywhere you see the ⓘ symbol.

The types of validation reports are described at

<http://www.wwpdb.org/validation/2017/FAQs#types>.

The following versions of software and data (see [references ⓘ](#)) were used in the production of this report:

EMDB validation analysis : 0.0.1.dev70
MolProbity : 4.02b-467
Percentile statistics : 20191225.v01 (using entries in the PDB archive December 25th 2019)
MapQ : 1.9.9
Ideal geometry (proteins) : Engh & Huber (2001)
Ideal geometry (DNA, RNA) : Parkinson et al. (1996)
Validation Pipeline (wwPDB-VP) : 2.36

1 Overall quality at a glance

The following experimental techniques were used to determine the structure:

ELECTRON MICROSCOPY

The reported resolution of this entry is 7.41 Å.

Percentile scores (ranging between 0-100) for global validation metrics of the entry are shown in the following graphic. The table shows the number of entries on which the scores are based.

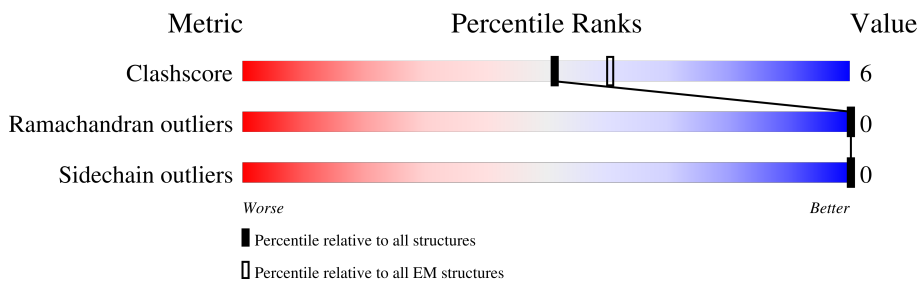

Metric	Whole archive (#Entries)	EM structures (#Entries)
Clashscore	158937	4297
Ramachandran outliers	154571	4023
Sidechain outliers	154315	3826

The table below summarises the geometric issues observed across the polymeric chains and their fit to the map. The red, orange, yellow and green segments of the bar indicate the fraction of residues that contain outliers for ≥ 3 , 2, 1 and 0 types of geometric quality criteria respectively. A grey segment represents the fraction of residues that are not modelled. The numeric value for each fraction is indicated below the corresponding segment, with a dot representing fractions $\leq 5\%$. The upper red bar (where present) indicates the fraction of residues that have poor fit to the EM map (all-atom inclusion $< 40\%$). The numeric value is given above the bar.

Mol	Chain	Length	Quality of chain
1	AB	319	5% (Poor fit), 83% (0-3 outliers), 15% (4+ outliers), 1% (Not modelled)
1	AC	319	8% (Poor fit), 83% (0-3 outliers), 11% (4+ outliers), 6% (Not modelled)
1	AJ	319	25% (Poor fit), 84% (0-3 outliers), 13% (4+ outliers), 1% (Not modelled)
1	AK	319	14% (Poor fit), 86% (0-3 outliers), 13% (4+ outliers), 1% (Not modelled)
1	AL	319	9% (Poor fit), 84% (0-3 outliers), 14% (4+ outliers), 1% (Not modelled)
1	AS	319	18% (Poor fit), 84% (0-3 outliers), 13% (4+ outliers), 1% (Not modelled)
1	AT	319	36% (Poor fit), 84% (0-3 outliers), 14% (4+ outliers), 1% (Not modelled)
1	AU	319	20% (Poor fit), 84% (0-3 outliers), 14% (4+ outliers), 1% (Not modelled)

Continued on next page...

Continued from previous page...

Mol	Chain	Length	Quality of chain
1	BB	319	
1	BC	319	
1	BD	319	
1	BK	319	
1	BL	319	
1	BM	319	
1	BT	319	
1	BU	319	
1	BV	319	
1	CC	319	
1	CD	319	
1	CE	319	
1	CL	319	
1	CM	319	
1	CN	319	
1	CU	319	
1	CV	319	
1	CW	319	
1	DB	319	
1	DC	319	
1	DJ	319	
1	DK	319	
1	DL	319	
1	DS	319	
1	DT	319	

Continued on next page...

Continued from previous page...

Mol	Chain	Length	Quality of chain
1	DU	319	15% 85% 13%
1	EB	319	38% 86% 11%
1	EC	319	34% 80% 18%
1	ED	319	23% 87% 11%
1	EK	319	29% 82% 15%
1	EL	319	28% 88% 10%
1	EM	319	38% 85% 13%
1	ET	319	29% 84% 13%
1	EU	319	21% 83% 15%
1	EV	319	26% 83% 14%
1	FC	319	33% 82% 16%
1	FD	319	30% 80% 13% 7%
1	FE	319	25% 80% 18%
1	FL	319	31% 81% 17%
1	FM	319	18% 85% 13%
1	FN	319	36% 84% 9% 7%
1	FU	319	50% 80% 18%
1	FV	319	33% 84% 14%
1	FW	319	37% 81% 18%
1	GB	319	84% 14%
1	GC	319	5% 83% 11% 6%
1	GJ	319	15% 84% 13%
1	GK	319	11% 86% 12%
1	GL	319	7% 84% 14%
1	GS	319	16% 85% 12%

Continued on next page...

Continued from previous page...

Mol	Chain	Length	Quality of chain
1	GT	319	32% 83% 15%
1	GU	319	20% 85% 13%
1	HB	319	25% 85% 12%
1	HC	319	21% 80% 18%
1	HD	319	22% 86% 12%
1	HK	319	17% 83% 14%
1	HL	319	17% 88% 10%
1	HM	319	26% 85% 13%
1	HT	319	15% 83% 14%
1	HU	319	15% 84% 14%
1	HV	319	19% 82% 15%
1	IC	319	29% 82% 16%
1	ID	319	23% 80% 13% 7%
1	IE	319	20% 79% 19%
1	IL	319	27% 82% 16%
1	IM	319	24% 86% 12%
1	IN	319	34% 84% 9% 7%
1	IU	319	37% 80% 18%
1	IV	319	17% 84% 14%
1	IW	319	25% 81% 18%
1	JB	319	7% 84% 14%
1	JC	319	6% 83% 11% 6%
1	JJ	319	16% 84% 13%
1	JK	319	13% 87% 11%
1	JL	319	11% 85% 13%

Continued on next page...

Continued from previous page...

Mol	Chain	Length	Quality of chain	
1	JS	319	17%	84% 13%
1	JT	319	31%	83% 15%
1	JU	319	15%	84% 14%
1	KB	319	27%	85% 12%
1	KC	319	25%	80% 18%
1	KD	319	25%	86% 12%
1	KK	319	22%	83% 14%
1	KL	319	28%	87% 11%
1	KM	319	29%	86% 13%
1	KT	319	25%	83% 14%
1	KU	319	23%	83% 15%
1	KV	319	29%	82% 15%
1	LC	319	33%	82% 16%
1	LD	319	33%	80% 13% 7%
1	LE	319	26%	79% 19%
1	LL	319	25%	81% 18%
1	LM	319	25%	85% 13%
1	LN	319	36%	83% 10% 7%
1	LU	319	39%	81% 17%
1	LV	319	23%	84% 14%
1	LW	319	36%	82% 16%
1	MB	319	6%	83% 15%
1	MC	319	7%	83% 11% 6%
1	MJ	319	19%	84% 13%
1	MK	319	8%	87% 11%

Continued on next page...

Continued from previous page...

Mol	Chain	Length	Quality of chain			
1	ML	319	12%	84%	14%	•
1	MS	319	13%	83%	14%	•
1	MT	319	28%	84%	14%	•
1	MU	319	16%	84%	14%	•
1	NB	319	23%	85%	12%	•
1	NC	319	21%	81%	18%	•
1	ND	319	20%	87%	11%	•
1	NK	319	18%	83%	14%	•
1	NL	319	24%	88%	10%	•
1	NM	319	31%	85%	13%	•
1	NT	319	22%	83%	14%	•
1	NU	319	17%	84%	14%	•
1	NV	319	26%	83%	15%	•
1	OC	319	27%	82%	17%	•
1	OD	319	29%	80%	13%	7%
1	OE	319	29%	80%	18%	•
1	OL	319	20%	83%	15%	•
1	OM	319	23%	85%	13%	•
1	ON	319	33%	83%	10%	7%
1	OU	319	34%	80%	18%	•
1	OV	319	19%	84%	14%	•
1	OW	319	32%	82%	16%	•
2	AD	185	16%	59%	6%	35%
2	AO	185	19%	68%	17%	15%
2	AW	185	12%	75%	8%	17%

Continued on next page...

Continued from previous page...

Mol	Chain	Length	Quality of chain			
2	AX	185	18%	77%	9%	14%
2	BF	185	19%	76%	9%	15%
2	BG	185	28%	70%	14%	17%
2	BN	185	44%	85%	10%	5%
2	BO	185	38%	72%	10%	17%
2	BW	185	16%	74%	11%	15%
2	BX	185	25%	81%	9%	10%
2	CF	185	24%	78%	13%	9%
2	CG	185	36%	72%	10%	18%
2	CH	185	35%	68%	15%	17%
2	CP	185	25%	70%	12%	17%
2	CQ	185	18%	83%	9%	8%
2	DD	185	17%	59%	6%	35%
2	DO	185	16%	70%	15%	15%
2	DW	185	10%	75%	8%	17%
2	DX	185	16%	78%	8%	14%
2	EF	185	25%	77%	8%	15%
2	EG	185	32%	70%	13%	17%
2	EN	185	35%	83%	12%	5%
2	EO	185	39%	72%	10%	17%
2	EW	185	15%	74%	11%	15%
2	EX	185	22%	80%	10%	10%
2	FF	185	18%	78%	13%	9%
2	FG	185	21%	72%	10%	18%
2	FH	185	22%	69%	15%	17%

Continued on next page...

Continued from previous page...

Mol	Chain	Length	Quality of chain
2	FP	185	
2	FQ	185	
2	GD	185	
2	GO	185	
2	GW	185	
2	GX	185	
2	HF	185	
2	HG	185	
2	HN	185	
2	HO	185	
2	HW	185	
2	HX	185	
2	IF	185	
2	IG	185	
2	IH	185	
2	IP	185	
2	IQ	185	
2	JD	185	
2	JO	185	
2	JW	185	
2	JX	185	
2	KF	185	
2	KG	185	
2	KN	185	
2	KO	185	

Continued on next page...

Continued from previous page...

Mol	Chain	Length	Quality of chain
2	KW	185	9% 74% 11% 15%
2	KX	185	17% 79% 10% 10%
2	LF	185	21% 77% 14% 9%
2	LG	185	25% 72% 10% 18%
2	LH	185	20% 70% 14% 17%
2	LP	185	36% 70% 12% 17%
2	LQ	185	24% 82% 10% 8%
2	MD	185	11% 59% 6% 35%
2	MO	185	16% 69% 16% 15%
2	MW	185	9% 75% 8% 17%
2	MX	185	12% 77% 9% 14%
2	NF	185	21% 76% 9% 15%
2	NG	185	22% 71% 12% 17%
2	NN	185	34% 84% 11% 5%
2	NO	185	27% 72% 10% 17%
2	NW	185	9% 74% 11% 15%
2	NX	185	22% 79% 10% 10%
2	OF	185	30% 76% 15% 9%
2	OG	185	27% 72% 10% 18%
2	OH	185	32% 69% 15% 17%
2	OP	185	25% 71% 11% 17%
2	OQ	185	11% 83% 9% 8%
3	AF	190	9% 67% 9% 24%
3	AN	190	17% 69% 11% 21%
3	AV	190	9% 71% 10% 19%

Continued on next page...

Continued from previous page...

Mol	Chain	Length	Quality of chain			
3	BE	190	21%	66%	15%	19%
3	BP	190	34%	71%	9%	21%
3	BY	190	14%	65%	14%	21%
3	CO	190	18%	67%	13%	20%
3	DF	190	7%	65%	11%	24%
3	DN	190	16%	69%	10%	21%
3	DV	190	8%	71%	10%	19%
3	EE	190	24%	67%	14%	19%
3	EP	190	21%	71%	9%	21%
3	EY	190	13%	65%	14%	21%
3	FO	190	24%	67%	13%	20%
3	GF	190	5%	66%	10%	24%
3	GN	190	5%	70%	9%	21%
3	GV	190	8%	71%	10%	19%
3	HE	190	24%	66%	15%	19%
3	HP	190	12%	69%	10%	21%
3	HY	190	•	65%	15%	21%
3	IO	190	26%	65%	15%	20%
3	JF	190	7%	66%	10%	24%
3	JN	190	14%	69%	10%	21%
3	JV	190	11%	71%	10%	19%
3	KE	190	20%	66%	15%	19%
3	KP	190	17%	69%	10%	21%
3	KY	190	13%	65%	14%	21%
3	LO	190	23%	66%	14%	20%















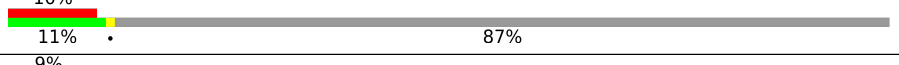

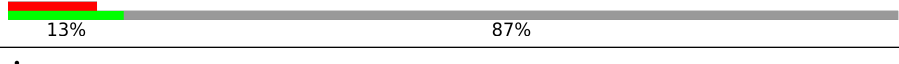





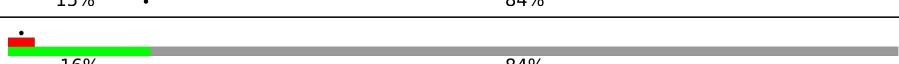

Continued on next page...

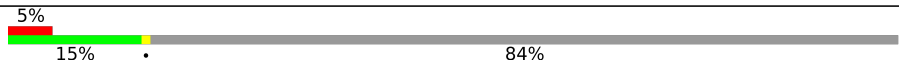
Continued from previous page...

Mol	Chain	Length	Quality of chain
3	MF	190	7% 66% 10% 24%
3	MN	190	15% 69% 10% 21%
3	MV	190	11% 71% 10% 19%
3	NE	190	18% 66% 15% 19%
3	NP	190	24% 71% 9% 21%
3	NY	190	13% 66% 14% 21%
3	OO	190	12% 67% 13% 20%
4	AH	230	15% 84%
4	AI	230	12% 87%
4	AP	230	7% 15% 84%
4	AQ	230	6% 16% 84%
4	AR	230	16% 84%
4	AY	230	15% 84%
4	AZ	230	9% 15% 84%
4	BA	230	16% 84%
4	BH	230	11% 16% 84%
4	BI	230	10% 15% 84%
4	BJ	230	15% 84%
4	BQ	230	11% 12% 88%
4	BR	230	16% 84%
4	BS	230	8% 15% 84%
4	BZ	230	14% 84%
4	CA	230	10% 89%
4	CB	230	7% 12% 87%
4	CI	230	14% 84%

Continued on next page...

Continued from previous page...

Mol	Chain	Length	Quality of chain
4	CJ	230	 10% 13% 87%
4	CK	230	 12% 16% 84%
4	CR	230	 5% 14% 84%
4	CS	230	 11% 16% 84%
4	CT	230	 10% 11% 87%
4	CX	230	 9% 12% 87%
4	CY	230	 10% 13% 87%
4	CZ	230	 12% 12% 87%
4	DH	230	 15% 15% 84%
4	DI	230	 12% 12% 87%
4	DP	230	 7% 15% 84%
4	DQ	230	 16% 16% 84%
4	DR	230	 16% 16% 84%
4	DY	230	 6% 14% 84%
4	DZ	230	 10% 15% 84%
4	EA	230	 16% 16% 84%
4	EH	230	 8% 16% 84%
4	EI	230	 9% 15% 84%
4	EJ	230	 5% 15% 84%
4	EQ	230	 12% 12% 88%
4	ER	230	 16% 16% 84%
4	ES	230	 8% 15% 84%
4	EZ	230	 14% 14% 84%
4	FA	230	 15% 15% 84%
4	FB	230	 10% 12% 87%

Continued on next page...

Continued from previous page...

Mol	Chain	Length	Quality of chain
4	FI	230	84%
4	FJ	230	87%
4	FK	230	84%
4	FR	230	84%
4	FS	230	84%
4	FT	230	87%
4	FX	230	87%
4	FY	230	87%
4	FZ	230	87%
4	GH	230	84%
4	GI	230	87%
4	GP	230	84%
4	GQ	230	84%
4	GR	230	84%
4	GY	230	84%
4	GZ	230	84%
4	HA	230	84%
4	HH	230	84%
4	HI	230	84%
4	HJ	230	84%
4	HQ	230	88%
4	HR	230	84%
4	HS	230	84%
4	HZ	230	84%
4	IA	230	84%















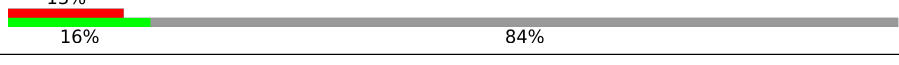

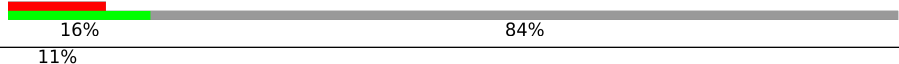





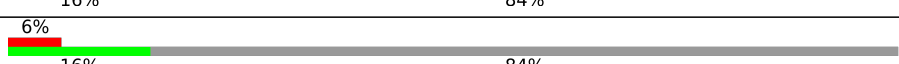

Continued on next page...

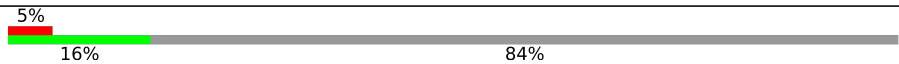
Continued from previous page...

Mol	Chain	Length	Quality of chain	
4	IB	230	12%	87%
4	II	230	5%	84%
4	IJ	230	8%	87%
4	IK	230	12%	84%
4	IR	230	14%	84%
4	IS	230	9%	84%
4	IT	230	10%	87%
4	IX	230	8%	87%
4	IY	230	9%	87%
4	IZ	230	12%	87%
4	JH	230	15%	84%
4	JI	230	12%	87%
4	JP	230	6%	84%
4	JQ	230	16%	84%
4	JR	230	16%	84%
4	JY	230	14%	84%
4	JZ	230	10%	84%
4	KA	230	16%	84%
4	KH	230	7%	84%
4	KI	230	7%	84%
4	KJ	230	5%	84%
4	KQ	230	10%	88%
4	KR	230	16%	84%
4	KS	230	7%	84%
4	KZ	230	14%	84%



















Continued on next page...

Continued from previous page...

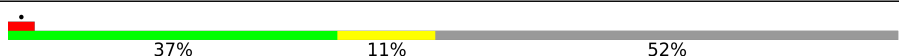
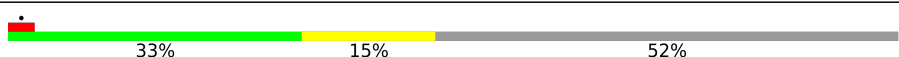
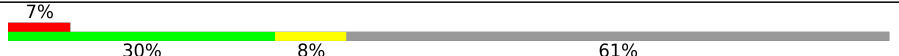
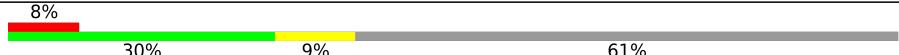
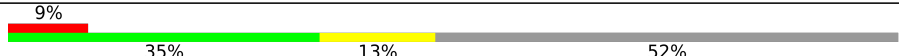
Mol	Chain	Length	Quality of chain
4	LA	230	 5% 15% 84%
4	LB	230	 7% 12% 87%
4	LI	230	 15% 84%
4	LJ	230	 9% 13% 87%
4	LK	230	 13% 16% 84%
4	LR	230	 14% 84%
4	LS	230	 11% 16% 84%
4	LT	230	 11% 11% 87%
4	LX	230	 10% 12% 87%
4	LY	230	 7% 13% 87%
4	LZ	230	 12% 87%
4	MH	230	 15% 84%
4	MI	230	 12% 87%
4	MP	230	 7% 15% 84%
4	MQ	230	 16% 84%
4	MR	230	 6% 16% 84%
4	MY	230	 15% 84%
4	MZ	230	 8% 15% 84%
4	NA	230	 5% 16% 84%
4	NH	230	 9% 16% 84%
4	NI	230	 7% 15% 84%
4	NJ	230	 5% 15% 84%
4	NQ	230	 11% 12% 88%
4	NR	230	 16% 84%
4	NS	230	 7% 15% 84%

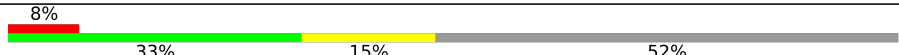
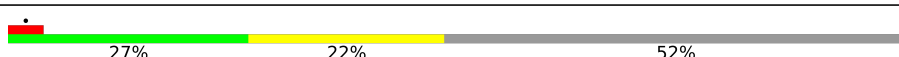
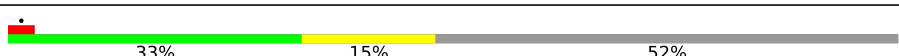
Continued on next page...

Continued from previous page...

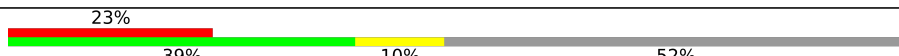
Mol	Chain	Length	Quality of chain
4	NZ	230	 14% 84%
4	OA	230	 10% 89%
4	OB	230	 11% 87%
4	OI	230	 14% 84%
4	OJ	230	 10% 87%
4	OK	230	 10% 84%
4	OR	230	 14% 84%
4	OS	230	 11% 84%
4	OT	230	 11% 87%
4	OX	230	 10% 87%
4	OY	230	 8% 87%
4	OZ	230	 12% 87%
4	QA	230	 37% 11% 52%
4	QB	230	 33% 15% 52%
4	QC	230	 7% 30% 8% 61%
4	QD	230	 8% 30% 9% 61%
4	QE	230	 9% 35% 13% 52%
4	QF	230	 13% 30% 9% 61%
4	QG	230	 8% 33% 15% 52%
4	QH	230	 27% 22% 52%
4	QI	230	 33% 15% 52%
4	QJ	230	 29% 10% 61%
4	RA	230	 35% 32% 16% 52%
4	RB	230	 20% 33% 15% 52%
4	SA	230	 23% 39% 10% 52%

Continued on next page...

Continued from previous page...

Mol	Chain	Length	Quality of chain
4	SB	230	12% 29% 13% 58%
4	SC	230	8% 32% 17% 52%
4	SD	230	11% 28% 14% 58%
4	SE	230	11% 36% 13% 52%
4	SF	230	33% 39% 9% 52%
4	SG	230	30% 30% 13% 58%
4	SH	230	19% 32% 16% 52%
4	SI	230	21% 27% 16% 58%
4	SJ	230	11% 30% 18% 52%
4	SK	230	14% 27% 15% 58%
4	SL	230	14% 32% 17% 52%
4	SM	230	32% 37% 11% 52%
4	SN	230	12% 27% 15% 58%
4	SO	230	11% 33% 15% 52%
4	TA	230	1% 37% 11% 52%
4	TB	230	9% 30% 12% 58%
4	TC	230	1% 36% 12% 52%
4	TD	230	11% 28% 14% 58%
4	TE	230	6% 38% 10% 52%
4	TF	230	11% 29% 13% 58%
4	TG	230	16% 35% 13% 52%
4	TH	230	30% 27% 15% 58%
4	TI	230	5% 33% 15% 52%
4	TJ	230	9% 28% 14% 58%
4	TK	230	5% 33% 15% 52%



















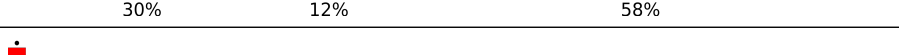
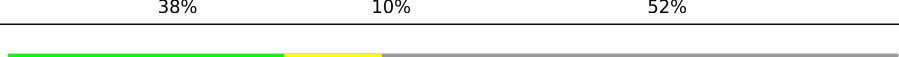

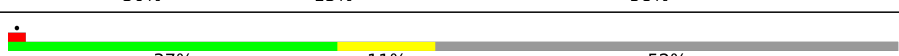
Continued on next page...

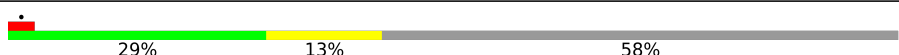
Continued from previous page...

Mol	Chain	Length	Quality of chain
4	TL	230	
4	TM	230	
4	TN	230	
4	TO	230	
4	TP	230	
4	TQ	230	
4	TR	230	
4	TS	230	
4	TT	230	
4	TU	230	
4	TV	230	
4	TW	230	
4	TX	230	
4	TY	230	
4	TZ	230	
4	UA	230	
4	UB	230	
4	UC	230	
4	UD	230	
4	UE	230	
4	UF	230	
4	VA	230	
4	VB	230	
4	VC	230	
4	VD	230	

Continued on next page...

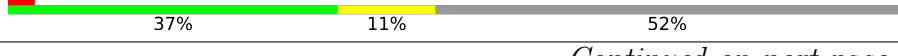
Continued from previous page...

Mol	Chain	Length	Quality of chain
4	VE	230	
4	VF	230	
4	VG	230	
4	VH	230	
4	VI	230	
4	VJ	230	
4	VK	230	
4	VL	230	
4	VM	230	
4	VN	230	
4	VO	230	
4	VP	230	
4	VQ	230	
4	VR	230	
4	VS	230	
4	VT	230	
4	VU	230	
4	VV	230	
4	VW	230	
4	VX	230	
4	VY	230	
4	VZ	230	
4	WA	230	
4	WB	230	
4	WC	230	















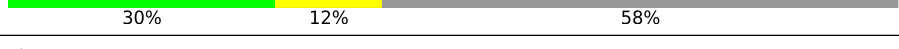

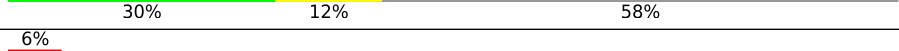
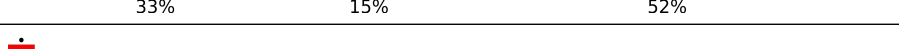
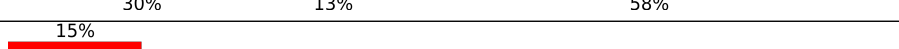
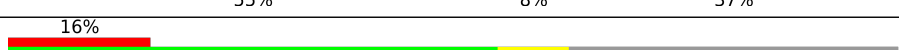

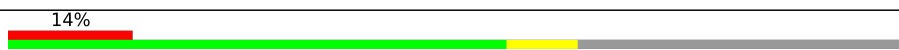

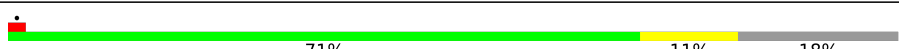
Continued on next page...

Continued from previous page...

Mol	Chain	Length	Quality of chain
4	WD	230	30% 13% 58%
4	WE	230	36% 12% 52%
4	WF	230	30% 12% 58%
4	XA	230	38% 10% 52%
4	XB	230	11% 30% 12% 58%
4	XC	230	38% 10% 52%
4	XD	230	30% 12% 58%
4	XE	230	38% 10% 52%
4	XF	230	30% 12% 58%
4	XG	230	39% 10% 52%
4	XH	230	10% 30% 12% 58%
4	XI	230	9% 38% 10% 52%
4	XJ	230	8% 30% 12% 58%
4	XK	230	6% 38% 10% 52%
4	XL	230	30% 12% 58%
4	XM	230	38% 10% 52%
4	XN	230	5% 30% 13% 58%
4	XO	230	38% 10% 52%
4	XP	230	6% 30% 12% 58%
4	XQ	230	5% 37% 11% 52%
4	XR	230	5% 30% 12% 58%
4	XS	230	7% 37% 11% 52%
4	XT	230	8% 30% 12% 58%
4	XU	230	38% 10% 52%
4	XV	230	8% 30% 12% 58%

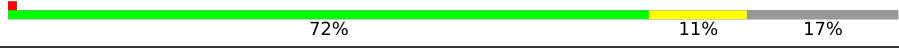
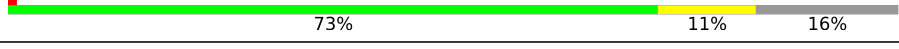

Continued on next page...

Continued from previous page...

Mol	Chain	Length	Quality of chain
4	XW	230	 38% 10% 52%
4	XX	230	 30% 12% 58%
4	XY	230	 7% 38% 10% 52%
4	XZ	230	 5% 30% 12% 58%
4	YA	230	 7% 38% 10% 52%
4	YB	230	 9% 30% 12% 58%
4	YC	230	 39% 10% 52%
4	YD	230	 30% 12% 58%
4	YE	230	 6% 33% 15% 52%
4	YF	230	 30% 13% 58%
5	AM	254	 15% 55% 8% 37%
5	DM	254	 16% 55% 8% 37%
5	GM	254	 14% 55% 8% 37%
5	JM	254	 14% 56% 8% 37%
5	MM	254	 13% 56% 8% 37%
6	PA	407	 71% 11% 18%
6	PB	407	 75% 14% 11%
6	PC	407	 73% 12% 15%
6	PD	407	 70% 12% 18%
6	PE	407	 74% 13% 14%
6	PF	407	 71% 11% 18%
6	PG	407	 72% 11% 17%
6	PH	407	 73% 11% 16%
6	PI	407	 72% 10% 18%
6	PJ	407	 74% 13% 14%

Continued on next page...

Continued from previous page...

Mol	Chain	Length	Quality of chain
6	PK	407	 <p>74% 13% 13%</p>
6	PL	407	 <p>75% 15% 10%</p>

2 Entry composition [i](#)

There are 6 unique types of molecules in this entry. The entry contains 638242 atoms, of which 0 are hydrogens and 0 are deuteriums.

In the tables below, the AltConf column contains the number of residues with at least one atom in alternate conformation and the Trace column contains the number of residues modelled with at most 2 atoms.

- Molecule 1 is a protein called Major capsid protein.

Mol	Chain	Residues	Atoms					AltConf	Trace
			Total	C	N	O	S		
1	AB	313	2510	1616	404	481	9	0	0
1	AC	300	2405	1549	390	457	9	0	0
1	AJ	309	2488	1604	400	475	9	0	0
1	AK	313	2510	1616	404	481	9	0	0
1	AL	313	2510	1616	404	481	9	0	0
1	AS	309	2488	1604	400	475	9	0	0
1	AT	313	2510	1616	404	481	9	0	0
1	AU	313	2510	1616	404	481	9	0	0
1	BB	309	2488	1604	400	475	9	0	0
1	BC	313	2510	1616	404	481	9	0	0
1	BD	313	2510	1616	404	481	9	0	0
1	BK	311	2505	1614	402	479	10	0	0
1	BL	313	2510	1616	404	481	9	0	0
1	BM	313	2510	1616	404	481	9	0	0
1	BT	309	2488	1604	400	475	9	0	0
1	BU	313	2510	1616	404	481	9	0	0
1	BV	311	2505	1614	402	479	10	0	0

Continued on next page...

Continued from previous page...

Mol	Chain	Residues	Atoms					AltConf	Trace
1	CC	313	Total	C	N	O	S	0	0
			2510	1616	404	481	9		
1	CD	297	Total	C	N	O	S	0	0
			2383	1532	385	457	9		
1	CE	313	Total	C	N	O	S	0	0
			2510	1616	404	481	9		
1	CL	313	Total	C	N	O	S	0	0
			2510	1616	404	481	9		
1	CM	313	Total	C	N	O	S	0	0
			2510	1616	404	481	9		
1	CN	297	Total	C	N	O	S	0	0
			2383	1532	385	457	9		
1	CU	313	Total	C	N	O	S	0	0
			2510	1616	404	481	9		
1	CV	313	Total	C	N	O	S	0	0
			2510	1616	404	481	9		
1	CW	313	Total	C	N	O	S	0	0
			2510	1616	404	481	9		
1	DB	313	Total	C	N	O	S	0	0
			2510	1616	404	481	9		
1	DC	300	Total	C	N	O	S	0	0
			2405	1549	390	457	9		
1	DJ	309	Total	C	N	O	S	0	0
			2488	1604	400	475	9		
1	DK	313	Total	C	N	O	S	0	0
			2510	1616	404	481	9		
1	DL	313	Total	C	N	O	S	0	0
			2510	1616	404	481	9		
1	DS	309	Total	C	N	O	S	0	0
			2488	1604	400	475	9		
1	DT	313	Total	C	N	O	S	0	0
			2510	1616	404	481	9		
1	DU	313	Total	C	N	O	S	0	0
			2510	1616	404	481	9		
1	EB	309	Total	C	N	O	S	0	0
			2488	1604	400	475	9		
1	EC	313	Total	C	N	O	S	0	0
			2510	1616	404	481	9		
1	ED	313	Total	C	N	O	S	0	0
			2510	1616	404	481	9		
1	EK	311	Total	C	N	O	S	0	0
			2505	1614	402	479	10		

Continued on next page...

Continued from previous page...

Mol	Chain	Residues	Atoms					AltConf	Trace
1	EL	313	Total	C	N	O	S	0	0
			2510	1616	404	481	9		
1	EM	313	Total	C	N	O	S	0	0
			2510	1616	404	481	9		
1	ET	309	Total	C	N	O	S	0	0
			2488	1604	400	475	9		
1	EU	313	Total	C	N	O	S	0	0
			2510	1616	404	481	9		
1	EV	311	Total	C	N	O	S	0	0
			2505	1614	402	479	10		
1	FC	313	Total	C	N	O	S	0	0
			2510	1616	404	481	9		
1	FD	297	Total	C	N	O	S	0	0
			2383	1532	385	457	9		
1	FE	313	Total	C	N	O	S	0	0
			2510	1616	404	481	9		
1	FL	313	Total	C	N	O	S	0	0
			2510	1616	404	481	9		
1	FM	313	Total	C	N	O	S	0	0
			2510	1616	404	481	9		
1	FN	297	Total	C	N	O	S	0	0
			2383	1532	385	457	9		
1	FU	313	Total	C	N	O	S	0	0
			2510	1616	404	481	9		
1	FV	313	Total	C	N	O	S	0	0
			2510	1616	404	481	9		
1	FW	313	Total	C	N	O	S	0	0
			2510	1616	404	481	9		
1	GB	313	Total	C	N	O	S	0	0
			2510	1616	404	481	9		
1	GC	300	Total	C	N	O	S	0	0
			2405	1549	390	457	9		
1	GJ	309	Total	C	N	O	S	0	0
			2488	1604	400	475	9		
1	GK	313	Total	C	N	O	S	0	0
			2510	1616	404	481	9		
1	GL	313	Total	C	N	O	S	0	0
			2510	1616	404	481	9		
1	GS	309	Total	C	N	O	S	0	0
			2488	1604	400	475	9		
1	GT	313	Total	C	N	O	S	0	0
			2510	1616	404	481	9		

Continued on next page...

Continued from previous page...

Mol	Chain	Residues	Atoms					AltConf	Trace
1	GU	313	Total	C	N	O	S	0	0
			2510	1616	404	481	9		
1	HB	309	Total	C	N	O	S	0	0
			2488	1604	400	475	9		
1	HC	313	Total	C	N	O	S	0	0
			2510	1616	404	481	9		
1	HD	313	Total	C	N	O	S	0	0
			2510	1616	404	481	9		
1	HK	311	Total	C	N	O	S	0	0
			2505	1614	402	479	10		
1	HL	313	Total	C	N	O	S	0	0
			2510	1616	404	481	9		
1	HM	313	Total	C	N	O	S	0	0
			2510	1616	404	481	9		
1	HT	309	Total	C	N	O	S	0	0
			2488	1604	400	475	9		
1	HU	313	Total	C	N	O	S	0	0
			2510	1616	404	481	9		
1	HV	311	Total	C	N	O	S	0	0
			2505	1614	402	479	10		
1	IC	313	Total	C	N	O	S	0	0
			2510	1616	404	481	9		
1	ID	297	Total	C	N	O	S	0	0
			2383	1532	385	457	9		
1	IE	313	Total	C	N	O	S	0	0
			2510	1616	404	481	9		
1	IL	313	Total	C	N	O	S	0	0
			2510	1616	404	481	9		
1	IM	313	Total	C	N	O	S	0	0
			2510	1616	404	481	9		
1	IN	297	Total	C	N	O	S	0	0
			2383	1532	385	457	9		
1	IU	313	Total	C	N	O	S	0	0
			2510	1616	404	481	9		
1	IV	313	Total	C	N	O	S	0	0
			2510	1616	404	481	9		
1	IW	313	Total	C	N	O	S	0	0
			2510	1616	404	481	9		
1	JB	313	Total	C	N	O	S	0	0
			2510	1616	404	481	9		
1	JC	300	Total	C	N	O	S	0	0
			2405	1549	390	457	9		

Continued on next page...

Continued from previous page...

Mol	Chain	Residues	Atoms					AltConf	Trace
1	JJ	309	Total	C	N	O	S	0	0
			2488	1604	400	475	9		
1	JK	313	Total	C	N	O	S	0	0
			2510	1616	404	481	9		
1	JL	313	Total	C	N	O	S	0	0
			2510	1616	404	481	9		
1	JS	309	Total	C	N	O	S	0	0
			2488	1604	400	475	9		
1	JT	313	Total	C	N	O	S	0	0
			2510	1616	404	481	9		
1	JU	313	Total	C	N	O	S	0	0
			2510	1616	404	481	9		
1	KB	309	Total	C	N	O	S	0	0
			2488	1604	400	475	9		
1	KC	313	Total	C	N	O	S	0	0
			2510	1616	404	481	9		
1	KD	313	Total	C	N	O	S	0	0
			2510	1616	404	481	9		
1	KK	311	Total	C	N	O	S	0	0
			2505	1614	402	479	10		
1	KL	313	Total	C	N	O	S	0	0
			2510	1616	404	481	9		
1	KM	313	Total	C	N	O	S	0	0
			2510	1616	404	481	9		
1	KT	309	Total	C	N	O	S	0	0
			2488	1604	400	475	9		
1	KU	313	Total	C	N	O	S	0	0
			2510	1616	404	481	9		
1	KV	311	Total	C	N	O	S	0	0
			2505	1614	402	479	10		
1	LC	313	Total	C	N	O	S	0	0
			2510	1616	404	481	9		
1	LD	297	Total	C	N	O	S	0	0
			2383	1532	385	457	9		
1	LE	313	Total	C	N	O	S	0	0
			2510	1616	404	481	9		
1	LL	313	Total	C	N	O	S	0	0
			2510	1616	404	481	9		
1	LM	313	Total	C	N	O	S	0	0
			2510	1616	404	481	9		
1	LN	297	Total	C	N	O	S	0	0
			2383	1532	385	457	9		

Continued on next page...

Continued from previous page...

Mol	Chain	Residues	Atoms					AltConf	Trace
1	LU	313	Total	C	N	O	S	0	0
			2510	1616	404	481	9		
1	LV	313	Total	C	N	O	S	0	0
			2510	1616	404	481	9		
1	LW	313	Total	C	N	O	S	0	0
			2510	1616	404	481	9		
1	MB	313	Total	C	N	O	S	0	0
			2510	1616	404	481	9		
1	MC	300	Total	C	N	O	S	0	0
			2405	1549	390	457	9		
1	MJ	309	Total	C	N	O	S	0	0
			2488	1604	400	475	9		
1	MK	313	Total	C	N	O	S	0	0
			2510	1616	404	481	9		
1	ML	313	Total	C	N	O	S	0	0
			2510	1616	404	481	9		
1	MS	309	Total	C	N	O	S	0	0
			2488	1604	400	475	9		
1	MT	313	Total	C	N	O	S	0	0
			2510	1616	404	481	9		
1	MU	313	Total	C	N	O	S	0	0
			2510	1616	404	481	9		
1	NB	309	Total	C	N	O	S	0	0
			2488	1604	400	475	9		
1	NC	313	Total	C	N	O	S	0	0
			2510	1616	404	481	9		
1	ND	313	Total	C	N	O	S	0	0
			2510	1616	404	481	9		
1	NK	311	Total	C	N	O	S	0	0
			2505	1614	402	479	10		
1	NL	313	Total	C	N	O	S	0	0
			2510	1616	404	481	9		
1	NM	313	Total	C	N	O	S	0	0
			2510	1616	404	481	9		
1	NT	309	Total	C	N	O	S	0	0
			2488	1604	400	475	9		
1	NU	313	Total	C	N	O	S	0	0
			2510	1616	404	481	9		
1	NV	311	Total	C	N	O	S	0	0
			2505	1614	402	479	10		
1	OC	313	Total	C	N	O	S	0	0
			2510	1616	404	481	9		

Continued on next page...

Continued from previous page...

Mol	Chain	Residues	Atoms					AltConf	Trace
1	OD	297	Total	C	N	O	S	0	0
			2383	1532	385	457	9		
1	OE	313	Total	C	N	O	S	0	0
			2510	1616	404	481	9		
1	OL	313	Total	C	N	O	S	0	0
			2510	1616	404	481	9		
1	OM	313	Total	C	N	O	S	0	0
			2510	1616	404	481	9		
1	ON	297	Total	C	N	O	S	0	0
			2383	1532	385	457	9		
1	OU	313	Total	C	N	O	S	0	0
			2510	1616	404	481	9		
1	OV	313	Total	C	N	O	S	0	0
			2510	1616	404	481	9		
1	OW	313	Total	C	N	O	S	0	0
			2510	1616	404	481	9		

- Molecule 2 is a protein called Decorator protein P03.

Mol	Chain	Residues	Atoms					AltConf	Trace
2	AD	120	Total	C	N	O	S	0	0
			917	584	151	180	2		
2	AO	158	Total	C	N	O	S	0	0
			1198	750	202	242	4		
2	AW	153	Total	C	N	O	S	0	0
			1164	733	194	233	4		
2	AX	160	Total	C	N	O	S	0	0
			1211	759	204	244	4		
2	BF	158	Total	C	N	O	S	0	0
			1194	747	201	242	4		
2	BG	154	Total	C	N	O	S	0	0
			1173	739	196	234	4		
2	BN	175	Total	C	N	O	S	0	0
			1337	840	225	268	4		
2	BO	153	Total	C	N	O	S	0	0
			1165	733	195	233	4		
2	BW	157	Total	C	N	O	S	0	0
			1189	744	200	241	4		
2	BX	166	Total	C	N	O	S	0	0
			1275	804	213	254	4		
2	CF	168	Total	C	N	O	S	0	0
			1288	813	215	256	4		

Continued on next page...

Continued from previous page...

Mol	Chain	Residues	Atoms					AltConf	Trace
			Total	C	N	O	S		
2	CG	152	1160	730	194	232	4	0	0
2	CH	154	1173	739	196	234	4	0	0
2	CP	153	1165	733	195	233	4	0	0
2	CQ	170	1304	823	218	259	4	0	0
2	DD	120	917	584	151	180	2	0	0
2	DO	158	1198	750	202	242	4	0	0
2	DW	153	1164	733	194	233	4	0	0
2	DX	160	1211	759	204	244	4	0	0
2	EF	158	1194	747	201	242	4	0	0
2	EG	154	1173	739	196	234	4	0	0
2	EN	175	1337	840	225	268	4	0	0
2	EO	153	1165	733	195	233	4	0	0
2	EW	157	1189	744	200	241	4	0	0
2	EX	166	1275	804	213	254	4	0	0
2	FF	168	1288	813	215	256	4	0	0
2	FG	152	1160	730	194	232	4	0	0
2	FH	154	1173	739	196	234	4	0	0
2	FP	153	1165	733	195	233	4	0	0
2	FQ	170	1304	823	218	259	4	0	0
2	GD	120	917	584	151	180	2	0	0
2	GO	158	1198	750	202	242	4	0	0

Continued on next page...

Continued from previous page...

Mol	Chain	Residues	Atoms					AltConf	Trace
2	GW	153	Total	C	N	O	S	0	0
			1164	733	194	233	4		
2	GX	160	Total	C	N	O	S	0	0
			1211	759	204	244	4		
2	HF	158	Total	C	N	O	S	0	0
			1194	747	201	242	4		
2	HG	154	Total	C	N	O	S	0	0
			1173	739	196	234	4		
2	HN	175	Total	C	N	O	S	0	0
			1337	840	225	268	4		
2	HO	153	Total	C	N	O	S	0	0
			1165	733	195	233	4		
2	HW	157	Total	C	N	O	S	0	0
			1189	744	200	241	4		
2	HX	166	Total	C	N	O	S	0	0
			1275	804	213	254	4		
2	IF	168	Total	C	N	O	S	0	0
			1288	813	215	256	4		
2	IG	152	Total	C	N	O	S	0	0
			1160	730	194	232	4		
2	IH	154	Total	C	N	O	S	0	0
			1173	739	196	234	4		
2	IP	153	Total	C	N	O	S	0	0
			1165	733	195	233	4		
2	IQ	170	Total	C	N	O	S	0	0
			1304	823	218	259	4		
2	JD	120	Total	C	N	O	S	0	0
			917	584	151	180	2		
2	JO	158	Total	C	N	O	S	0	0
			1198	750	202	242	4		
2	JW	153	Total	C	N	O	S	0	0
			1164	733	194	233	4		
2	JX	160	Total	C	N	O	S	0	0
			1211	759	204	244	4		
2	KF	158	Total	C	N	O	S	0	0
			1194	747	201	242	4		
2	KG	154	Total	C	N	O	S	0	0
			1173	739	196	234	4		
2	KN	175	Total	C	N	O	S	0	0
			1337	840	225	268	4		
2	KO	153	Total	C	N	O	S	0	0
			1165	733	195	233	4		

Continued on next page...

Continued from previous page...

Mol	Chain	Residues	Atoms					AltConf	Trace
			Total	C	N	O	S		
2	KW	157	1189	744	200	241	4	0	0
2	KX	166	1275	804	213	254	4	0	0
2	LF	168	1288	813	215	256	4	0	0
2	LG	152	1160	730	194	232	4	0	0
2	LH	154	1173	739	196	234	4	0	0
2	LP	153	1165	733	195	233	4	0	0
2	LQ	170	1304	823	218	259	4	0	0
2	MD	120	917	584	151	180	2	0	0
2	MO	158	1198	750	202	242	4	0	0
2	MW	153	1164	733	194	233	4	0	0
2	MX	160	1211	759	204	244	4	0	0
2	NF	158	1194	747	201	242	4	0	0
2	NG	154	1173	739	196	234	4	0	0
2	NN	175	1337	840	225	268	4	0	0
2	NO	153	1165	733	195	233	4	0	0
2	NW	157	1189	744	200	241	4	0	0
2	NX	166	1275	804	213	254	4	0	0
2	OF	168	1288	813	215	256	4	0	0
2	OG	152	1160	730	194	232	4	0	0
2	OH	154	1173	739	196	234	4	0	0
2	OP	153	1165	733	195	233	4	0	0

Continued on next page...

Continued from previous page...

Mol	Chain	Residues	Atoms					AltConf	Trace
			Total	C	N	O	S		
2	OQ	170	1304	823	218	259	4	0	0

- Molecule 3 is a protein called Decorator protein P05.

Mol	Chain	Residues	Atoms					AltConf	Trace
			Total	C	N	O	S		
3	AF	144	1137	726	191	218	2	0	0
3	AN	151	1187	755	201	229	2	0	0
3	AV	154	1208	769	205	231	3	0	0
3	BE	154	1208	769	205	231	3	0	0
3	BP	151	1186	755	201	228	2	0	0
3	BY	151	1186	755	201	228	2	0	0
3	CO	152	1195	761	203	229	2	0	0
3	DF	144	1137	726	191	218	2	0	0
3	DN	151	1187	755	201	229	2	0	0
3	DV	154	1208	769	205	231	3	0	0
3	EE	154	1208	769	205	231	3	0	0
3	EP	151	1186	755	201	228	2	0	0
3	EY	151	1186	755	201	228	2	0	0
3	FO	152	1195	761	203	229	2	0	0
3	GF	144	1137	726	191	218	2	0	0
3	GN	151	1187	755	201	229	2	0	0
3	GV	154	1208	769	205	231	3	0	0
3	HE	154	1208	769	205	231	3	0	0

Continued on next page...

Continued from previous page...

Mol	Chain	Residues	Atoms				AltConf	Trace	
3	HP	151	Total	C	N	O	S	0	0
			1186	755	201	228	2		
3	HY	151	Total	C	N	O	S	0	0
			1186	755	201	228	2		
3	IO	152	Total	C	N	O	S	0	0
			1195	761	203	229	2		
3	JF	144	Total	C	N	O	S	0	0
			1137	726	191	218	2		
3	JN	151	Total	C	N	O	S	0	0
			1187	755	201	229	2		
3	JV	154	Total	C	N	O	S	0	0
			1208	769	205	231	3		
3	KE	154	Total	C	N	O	S	0	0
			1208	769	205	231	3		
3	KP	151	Total	C	N	O	S	0	0
			1186	755	201	228	2		
3	KY	151	Total	C	N	O	S	0	0
			1186	755	201	228	2		
3	LO	152	Total	C	N	O	S	0	0
			1195	761	203	229	2		
3	MF	144	Total	C	N	O	S	0	0
			1137	726	191	218	2		
3	MN	151	Total	C	N	O	S	0	0
			1187	755	201	229	2		
3	MV	154	Total	C	N	O	S	0	0
			1208	769	205	231	3		
3	NE	154	Total	C	N	O	S	0	0
			1208	769	205	231	3		
3	NP	151	Total	C	N	O	S	0	0
			1186	755	201	228	2		
3	NY	151	Total	C	N	O	S	0	0
			1186	755	201	228	2		
3	OO	152	Total	C	N	O	S	0	0
			1195	761	203	229	2		

- Molecule 4 is a protein called Scaffold protein.

Mol	Chain	Residues	Atoms				AltConf	Trace
4	AH	37	Total	C	N	O	0	0
			315	203	55	57		
4	AI	29	Total	C	N	O	0	0
			255	165	46	44		

Continued on next page...

Continued from previous page...

Mol	Chain	Residues	Atoms				AltConf	Trace
			Total	C	N	O		
4	AP	37	315	203	55	57	0	0
4	AQ	37	315	203	55	57	0	0
4	AR	37	315	203	55	57	0	0
4	AY	37	315	203	55	57	0	0
4	AZ	37	315	203	55	57	0	0
4	BA	37	315	203	55	57	0	0
4	BH	37	315	203	55	57	0	0
4	BI	37	315	203	55	57	0	0
4	BJ	37	315	203	55	57	0	0
4	BQ	28	248	160	45	43	0	0
4	BR	37	315	203	55	57	0	0
4	BS	37	315	203	55	57	0	0
4	BZ	37	315	203	55	57	0	0
4	CA	26	233	149	43	41	0	0
4	CB	29	255	165	46	44	0	0
4	CI	37	315	203	55	57	0	0
4	CJ	29	255	165	46	44	0	0
4	CK	37	315	203	55	57	0	0
4	CR	37	315	203	55	57	0	0
4	CS	37	315	203	55	57	0	0
4	CT	29	255	165	46	44	0	0

Continued on next page...

Continued from previous page...

Mol	Chain	Residues	Atoms				AltConf	Trace
			Total	C	N	O		
4	CX	30	266	174	47	45	0	0
4	CY	30	266	174	47	45	0	0
4	CZ	30	266	174	47	45	0	0
4	DH	37	315	203	55	57	0	0
4	DI	29	255	165	46	44	0	0
4	DP	37	315	203	55	57	0	0
4	DQ	37	315	203	55	57	0	0
4	DR	37	315	203	55	57	0	0
4	DY	37	315	203	55	57	0	0
4	DZ	37	315	203	55	57	0	0
4	EA	37	315	203	55	57	0	0
4	EH	37	315	203	55	57	0	0
4	EI	37	315	203	55	57	0	0
4	EJ	37	315	203	55	57	0	0
4	EQ	28	248	160	45	43	0	0
4	ER	37	315	203	55	57	0	0
4	ES	37	315	203	55	57	0	0
4	EZ	37	315	203	55	57	0	0
4	FA	37	315	203	55	57	0	0
4	FB	29	255	165	46	44	0	0
4	FI	37	315	203	55	57	0	0

Continued on next page...

Continued from previous page...

Mol	Chain	Residues	Atoms				AltConf	Trace
			Total	C	N	O		
4	FJ	29	255	165	46	44	0	0
4	FK	37	315	203	55	57	0	0
4	FR	37	315	203	55	57	0	0
4	FS	37	315	203	55	57	0	0
4	FT	29	255	165	46	44	0	0
4	FX	30	266	174	47	45	0	0
4	FY	30	266	174	47	45	0	0
4	FZ	30	266	174	47	45	0	0
4	GH	37	315	203	55	57	0	0
4	GI	29	255	165	46	44	0	0
4	GP	37	315	203	55	57	0	0
4	GQ	37	315	203	55	57	0	0
4	GR	37	315	203	55	57	0	0
4	GY	37	315	203	55	57	0	0
4	GZ	37	315	203	55	57	0	0
4	HA	37	315	203	55	57	0	0
4	HH	37	315	203	55	57	0	0
4	HI	37	315	203	55	57	0	0
4	HJ	37	315	203	55	57	0	0
4	HQ	28	248	160	45	43	0	0
4	HR	37	315	203	55	57	0	0

Continued on next page...

Continued from previous page...

Mol	Chain	Residues	Atoms				AltConf	Trace
			Total	C	N	O		
4	HS	37	315	203	55	57	0	0
4	HZ	37	315	203	55	57	0	0
4	IA	37	315	203	55	57	0	0
4	IB	29	255	165	46	44	0	0
4	II	37	315	203	55	57	0	0
4	IJ	29	255	165	46	44	0	0
4	IK	37	315	203	55	57	0	0
4	IR	37	315	203	55	57	0	0
4	IS	37	315	203	55	57	0	0
4	IT	29	255	165	46	44	0	0
4	IX	30	266	174	47	45	0	0
4	IY	30	266	174	47	45	0	0
4	IZ	30	266	174	47	45	0	0
4	JH	37	315	203	55	57	0	0
4	JI	29	255	165	46	44	0	0
4	JP	37	315	203	55	57	0	0
4	JQ	37	315	203	55	57	0	0
4	JR	37	315	203	55	57	0	0
4	JY	37	315	203	55	57	0	0
4	JZ	37	315	203	55	57	0	0
4	KA	37	315	203	55	57	0	0

Continued on next page...

Continued from previous page...

Mol	Chain	Residues	Atoms				AltConf	Trace
			Total	C	N	O		
4	KH	37	315	203	55	57	0	0
4	KI	37	315	203	55	57	0	0
4	KJ	37	315	203	55	57	0	0
4	KQ	28	248	160	45	43	0	0
4	KR	37	315	203	55	57	0	0
4	KS	37	315	203	55	57	0	0
4	KZ	37	315	203	55	57	0	0
4	LA	37	315	203	55	57	0	0
4	LB	29	255	165	46	44	0	0
4	LI	37	315	203	55	57	0	0
4	LJ	29	255	165	46	44	0	0
4	LK	37	315	203	55	57	0	0
4	LR	37	315	203	55	57	0	0
4	LS	37	315	203	55	57	0	0
4	LT	29	255	165	46	44	0	0
4	LX	30	266	174	47	45	0	0
4	LY	30	266	174	47	45	0	0
4	LZ	30	266	174	47	45	0	0
4	MH	37	315	203	55	57	0	0
4	MI	29	255	165	46	44	0	0
4	MP	37	315	203	55	57	0	0

Continued on next page...

Continued from previous page...

Mol	Chain	Residues	Atoms				AltConf	Trace
			Total	C	N	O		
4	MQ	37	315	203	55	57	0	0
4	MR	37	315	203	55	57	0	0
4	MY	37	315	203	55	57	0	0
4	MZ	37	315	203	55	57	0	0
4	NA	37	315	203	55	57	0	0
4	NH	37	315	203	55	57	0	0
4	NI	37	315	203	55	57	0	0
4	NJ	37	315	203	55	57	0	0
4	NQ	28	248	160	45	43	0	0
4	NR	37	315	203	55	57	0	0
4	NS	37	315	203	55	57	0	0
4	NZ	37	315	203	55	57	0	0
4	OA	26	233	149	43	41	0	0
4	OB	29	255	165	46	44	0	0
4	OI	37	315	203	55	57	0	0
4	OJ	29	255	165	46	44	0	0
4	OK	37	315	203	55	57	0	0
4	OR	37	315	203	55	57	0	0
4	OS	37	315	203	55	57	0	0
4	OT	29	255	165	46	44	0	0
4	OX	30	266	174	47	45	0	0

Continued on next page...

Continued from previous page...

Mol	Chain	Residues	Atoms					AltConf	Trace
4	OY	30	Total	C	N	O			
			266	174	47	45	0	0	
4	OZ	30	Total	C	N	O			
			266	174	47	45	0	0	
4	QA	111	Total	C	N	O	S		
			904	572	163	168	1	0	
4	QB	111	Total	C	N	O	S		
			904	572	163	168	1	0	
4	QC	89	Total	C	N	O	S		
			717	458	129	129	1	0	
4	QD	89	Total	C	N	O	S		
			717	458	129	129	1	0	
4	QE	111	Total	C	N	O	S		
			904	572	163	168	1	0	
4	QF	89	Total	C	N	O	S		
			717	458	129	129	1	0	
4	QG	111	Total	C	N	O	S		
			904	572	163	168	1	0	
4	QH	111	Total	C	N	O	S		
			904	572	163	168	1	0	
4	QI	111	Total	C	N	O	S		
			904	572	163	168	1	0	
4	QJ	89	Total	C	N	O	S		
			717	458	129	129	1	0	
4	RA	111	Total	C	N	O	S		
			904	572	163	168	1	0	
4	RB	111	Total	C	N	O	S		
			904	572	163	168	1	0	
4	SA	111	Total	C	N	O	S		
			904	572	163	168	1	0	
4	SB	97	Total	C	N	O	S		
			790	501	143	145	1	0	
4	SC	111	Total	C	N	O	S		
			904	572	163	168	1	0	
4	SD	97	Total	C	N	O	S		
			790	501	143	145	1	0	
4	SE	111	Total	C	N	O	S		
			904	572	163	168	1	0	
4	SF	111	Total	C	N	O	S		
			904	572	163	168	1	0	
4	SG	97	Total	C	N	O	S		
			790	501	143	145	1	0	

Continued on next page...

Continued from previous page...

Mol	Chain	Residues	Atoms					AltConf	Trace
			Total	C	N	O	S		
4	SH	111	904	572	163	168	1	0	0
4	SI	97	790	501	143	145	1	0	0
4	SJ	111	904	572	163	168	1	0	0
4	SK	97	790	501	143	145	1	0	0
4	SL	111	904	572	163	168	1	0	0
4	SM	111	904	572	163	168	1	0	0
4	SN	97	790	501	143	145	1	0	0
4	SO	111	904	572	163	168	1	0	0
4	TA	111	904	572	163	168	1	0	0
4	TB	97	790	501	143	145	1	0	0
4	TC	111	904	572	163	168	1	0	0
4	TD	97	790	501	143	145	1	0	0
4	TE	111	904	572	163	168	1	0	0
4	TF	97	790	501	143	145	1	0	0
4	TG	111	904	572	163	168	1	0	0
4	TH	97	790	501	143	145	1	0	0
4	TI	111	904	572	163	168	1	0	0
4	TJ	97	790	501	143	145	1	0	0
4	TK	111	904	572	163	168	1	0	0
4	TL	97	790	501	143	145	1	0	0
4	TM	111	904	572	163	168	1	0	0

Continued on next page...

Continued from previous page...

Mol	Chain	Residues	Atoms					AltConf	Trace
			Total	C	N	O	S		
4	TN	97	Total 790	C 501	N 143	O 145	S 1	0	0
4	TO	111	Total 904	C 572	N 163	O 168	S 1	0	0
4	TP	97	Total 790	C 501	N 143	O 145	S 1	0	0
4	TQ	111	Total 904	C 572	N 163	O 168	S 1	0	0
4	TR	97	Total 790	C 501	N 143	O 145	S 1	0	0
4	TS	111	Total 904	C 572	N 163	O 168	S 1	0	0
4	TT	97	Total 790	C 501	N 143	O 145	S 1	0	0
4	TU	111	Total 904	C 572	N 163	O 168	S 1	0	0
4	TV	97	Total 790	C 501	N 143	O 145	S 1	0	0
4	TW	111	Total 904	C 572	N 163	O 168	S 1	0	0
4	TX	97	Total 790	C 501	N 143	O 145	S 1	0	0
4	TY	111	Total 904	C 572	N 163	O 168	S 1	0	0
4	TZ	97	Total 790	C 501	N 143	O 145	S 1	0	0
4	UA	111	Total 904	C 572	N 163	O 168	S 1	0	0
4	UB	97	Total 790	C 501	N 143	O 145	S 1	0	0
4	UC	111	Total 904	C 572	N 163	O 168	S 1	0	0
4	UD	97	Total 790	C 501	N 143	O 145	S 1	0	0
4	UE	111	Total 904	C 572	N 163	O 168	S 1	0	0
4	UF	93	Total 754	C 477	N 135	O 141	S 1	0	0
4	VA	111	Total 904	C 572	N 163	O 168	S 1	0	0
4	VB	97	Total 790	C 501	N 143	O 145	S 1	0	0

Continued on next page...

Continued from previous page...

Mol	Chain	Residues	Atoms					AltConf	Trace
			Total	C	N	O	S		
4	VC	111	904	572	163	168	1	0	0
4	VD	97	790	501	143	145	1	0	0
4	VE	111	904	572	163	168	1	0	0
4	VF	97	790	501	143	145	1	0	0
4	VG	111	904	572	163	168	1	0	0
4	VH	97	790	501	143	145	1	0	0
4	VI	111	904	572	163	168	1	0	0
4	VJ	97	790	501	143	145	1	0	0
4	VK	111	904	572	163	168	1	0	0
4	VL	97	790	501	143	145	1	0	0
4	VM	111	904	572	163	168	1	0	0
4	VN	97	790	501	143	145	1	0	0
4	VO	111	904	572	163	168	1	0	0
4	VP	97	790	501	143	145	1	0	0
4	VQ	111	904	572	163	168	1	0	0
4	VR	97	790	501	143	145	1	0	0
4	VS	111	904	572	163	168	1	0	0
4	VT	97	790	501	143	145	1	0	0
4	VU	111	904	572	163	168	1	0	0
4	VV	97	790	501	143	145	1	0	0
4	VW	111	904	572	163	168	1	0	0

Continued on next page...

Continued from previous page...

Mol	Chain	Residues	Atoms					AltConf	Trace
			Total	C	N	O	S		
4	VX	97	Total 790	C 501	N 143	O 145	S 1	0	0
4	VY	111	Total 904	C 572	N 163	O 168	S 1	0	0
4	VZ	97	Total 790	C 501	N 143	O 145	S 1	0	0
4	WA	111	Total 904	C 572	N 163	O 168	S 1	0	0
4	WB	97	Total 790	C 501	N 143	O 145	S 1	0	0
4	WC	111	Total 904	C 572	N 163	O 168	S 1	0	0
4	WD	97	Total 790	C 501	N 143	O 145	S 1	0	0
4	WE	111	Total 904	C 572	N 163	O 168	S 1	0	0
4	WF	97	Total 790	C 501	N 143	O 145	S 1	0	0
4	XA	111	Total 904	C 572	N 163	O 168	S 1	0	0
4	XB	97	Total 790	C 501	N 143	O 145	S 1	0	0
4	XC	111	Total 904	C 572	N 163	O 168	S 1	0	0
4	XD	97	Total 790	C 501	N 143	O 145	S 1	0	0
4	XE	111	Total 904	C 572	N 163	O 168	S 1	0	0
4	XF	97	Total 790	C 501	N 143	O 145	S 1	0	0
4	XG	111	Total 904	C 572	N 163	O 168	S 1	0	0
4	XH	97	Total 790	C 501	N 143	O 145	S 1	0	0
4	XI	111	Total 904	C 572	N 163	O 168	S 1	0	0
4	XJ	97	Total 790	C 501	N 143	O 145	S 1	0	0
4	XK	111	Total 904	C 572	N 163	O 168	S 1	0	0
4	XL	97	Total 790	C 501	N 143	O 145	S 1	0	0

Continued on next page...

Continued from previous page...

Mol	Chain	Residues	Atoms					AltConf	Trace
			Total	C	N	O	S		
4	XM	111	904	572	163	168	1	0	0
4	XN	97	790	501	143	145	1	0	0
4	XO	111	904	572	163	168	1	0	0
4	XP	97	790	501	143	145	1	0	0
4	XQ	111	904	572	163	168	1	0	0
4	XR	97	790	501	143	145	1	0	0
4	XS	111	904	572	163	168	1	0	0
4	XT	97	790	501	143	145	1	0	0
4	XU	111	904	572	163	168	1	0	0
4	XV	97	790	501	143	145	1	0	0
4	XW	111	904	572	163	168	1	0	0
4	XX	97	790	501	143	145	1	0	0
4	XY	111	904	572	163	168	1	0	0
4	XZ	97	790	501	143	145	1	0	0
4	YA	111	904	572	163	168	1	0	0
4	YB	97	790	501	143	145	1	0	0
4	YC	111	904	572	163	168	1	0	0
4	YD	97	790	501	143	145	1	0	0
4	YE	111	904	572	163	168	1	0	0
4	YF	97	790	501	143	145	1	0	0

- Molecule 5 is a protein called Decorator protein P04.

Mol	Chain	Residues	Atoms					AltConf	Trace
5	AM	161	Total	C	N	O	S	0	0
			1252	801	199	245	7		
5	DM	161	Total	C	N	O	S	0	0
			1252	801	199	245	7		
5	GM	161	Total	C	N	O	S	0	0
			1252	801	199	245	7		
5	JM	161	Total	C	N	O	S	0	0
			1252	801	199	245	7		
5	MM	161	Total	C	N	O	S	0	0
			1252	801	199	245	7		

- Molecule 6 is a protein called Portal protein.

Mol	Chain	Residues	Atoms					AltConf	Trace
6	PA	333	Total	C	N	O	S	0	0
			2747	1777	440	522	8		
6	PB	362	Total	C	N	O	S	0	0
			2959	1901	478	572	8		
6	PC	345	Total	C	N	O	S	0	0
			2829	1826	453	542	8		
6	PD	335	Total	C	N	O	S	0	0
			2765	1788	443	526	8		
6	PE	352	Total	C	N	O	S	0	0
			2888	1860	466	554	8		
6	PF	334	Total	C	N	O	S	0	0
			2756	1782	442	524	8		
6	PG	338	Total	C	N	O	S	0	0
			2789	1800	450	531	8		
6	PH	343	Total	C	N	O	S	0	0
			2830	1825	457	540	8		
6	PI	334	Total	C	N	O	S	0	0
			2754	1780	441	525	8		
6	PJ	352	Total	C	N	O	S	0	0
			2888	1860	466	554	8		
6	PK	353	Total	C	N	O	S	0	0
			2894	1863	467	556	8		
6	PL	367	Total	C	N	O	S	0	0
			3000	1924	488	580	8		

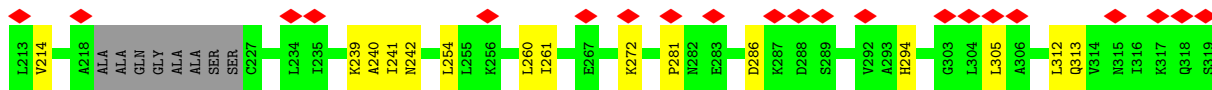

• Molecule 1: Major capsid protein

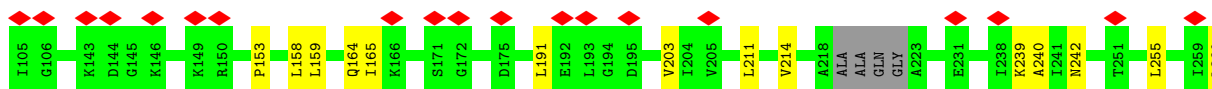
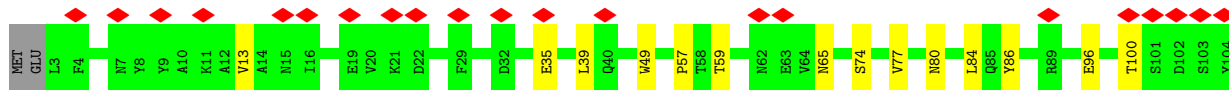
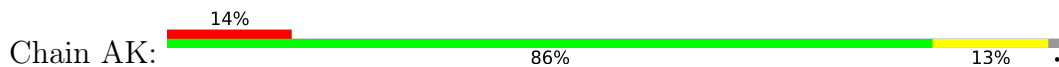

• Molecule 1: Major capsid protein

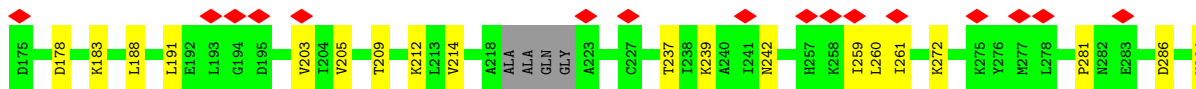
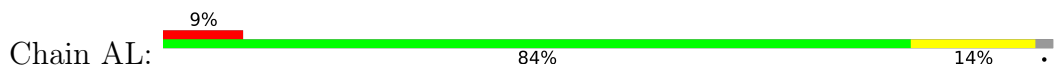

• Molecule 1: Major capsid protein

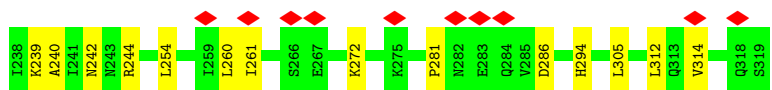
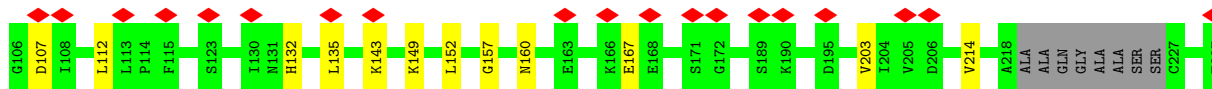
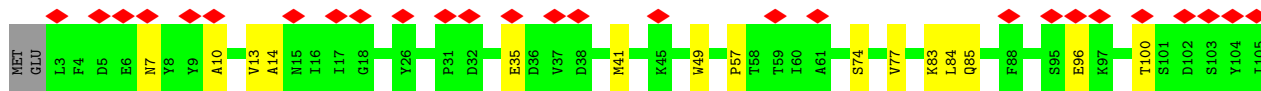
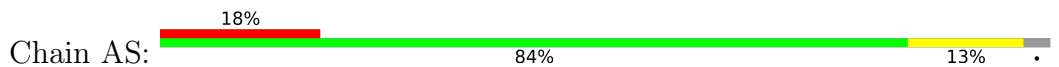

• Molecule 1: Major capsid protein

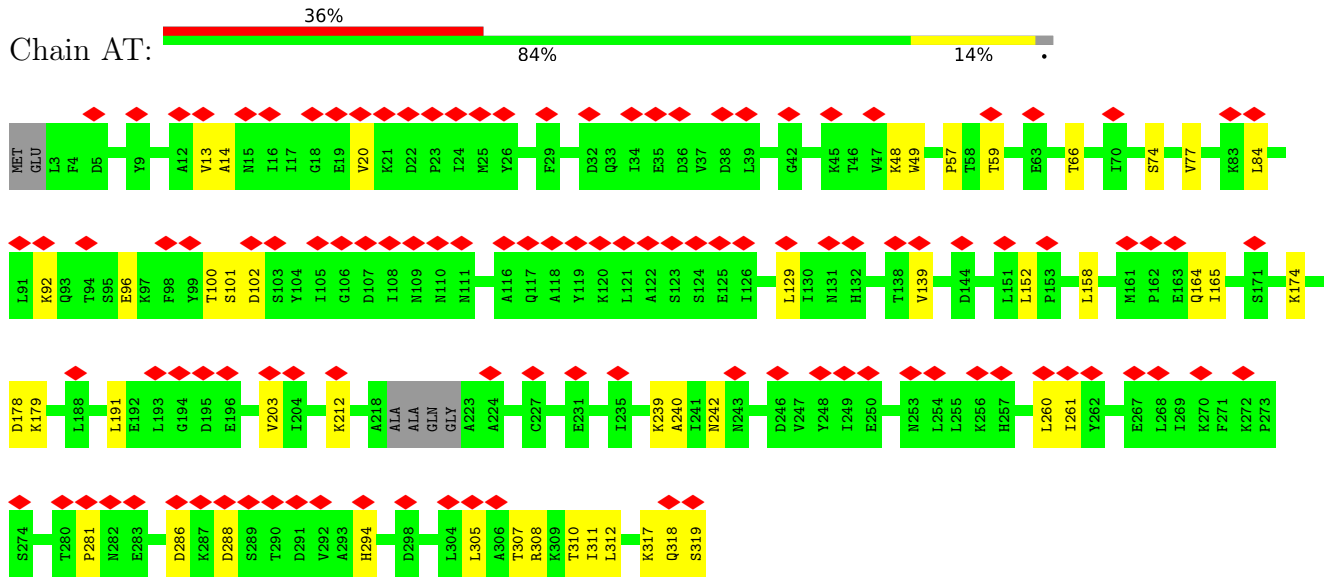

• Molecule 1: Major capsid protein

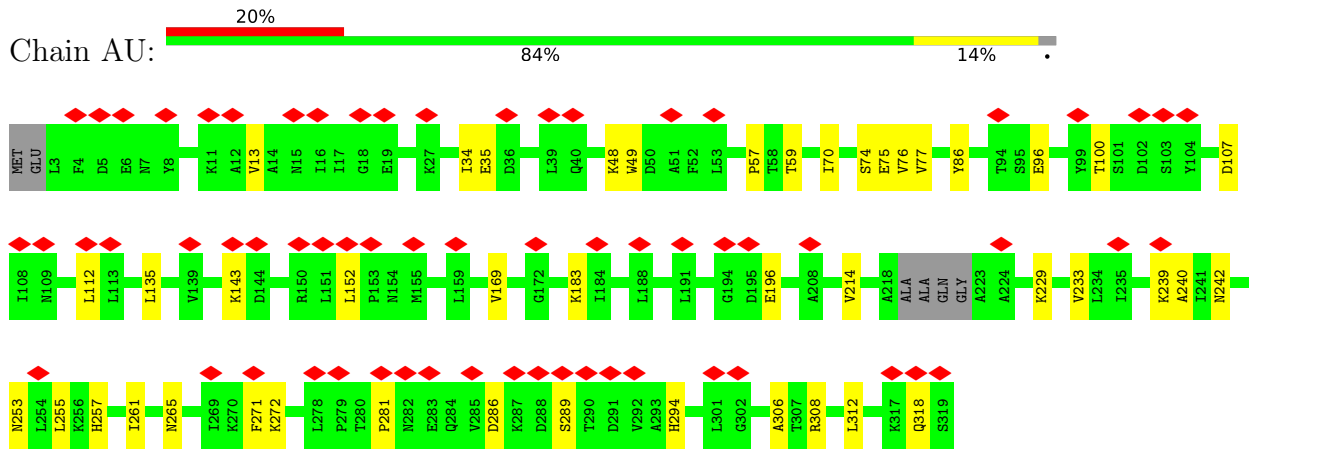

• Molecule 1: Major capsid protein

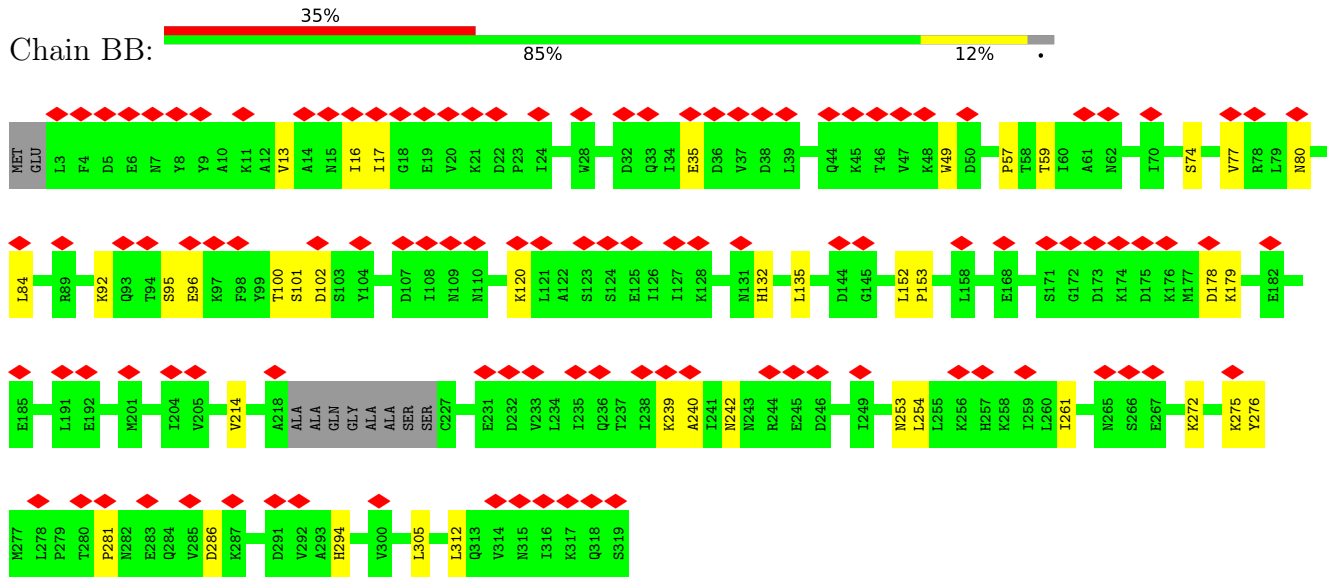

• Molecule 1: Major capsid protein

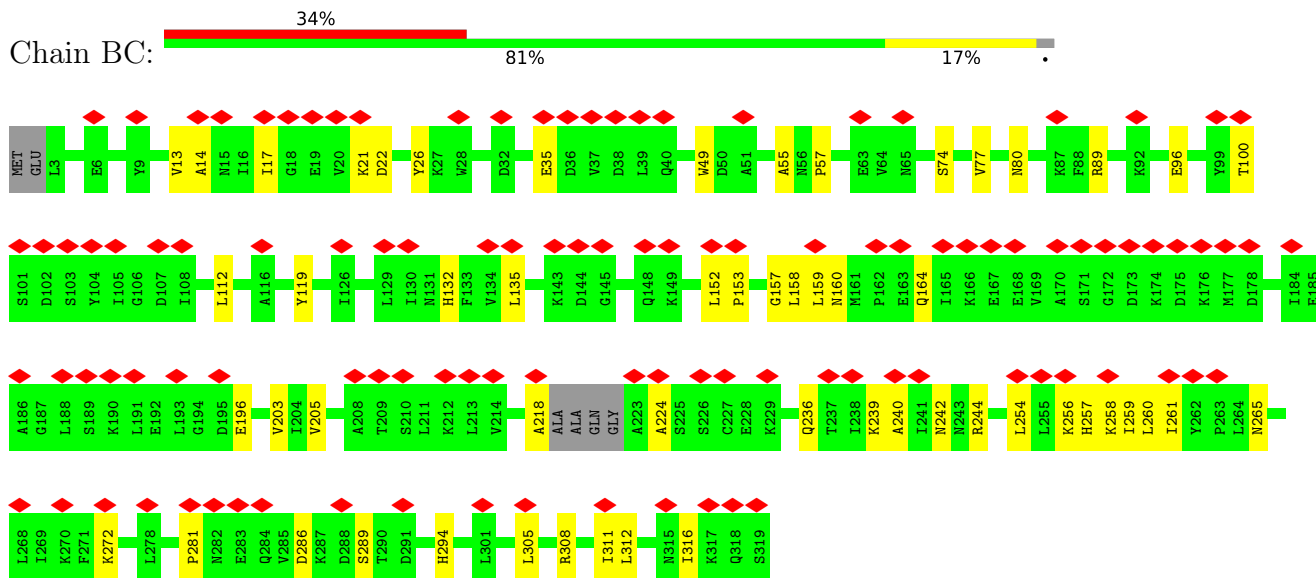

• Molecule 1: Major capsid protein

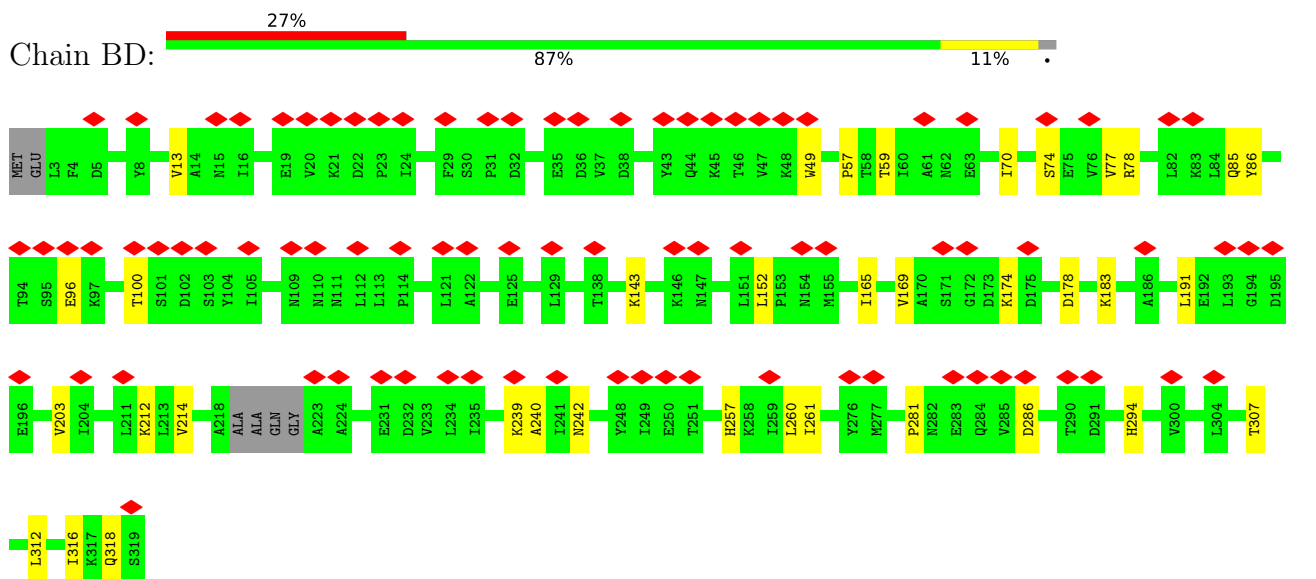

• Molecule 1: Major capsid protein

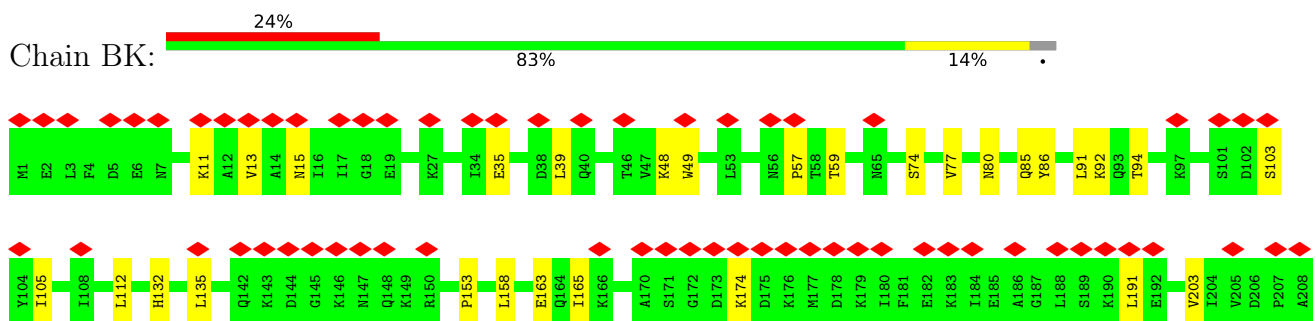

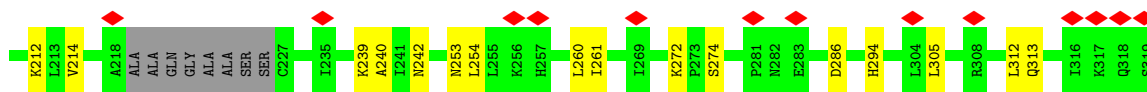

• Molecule 1: Major capsid protein

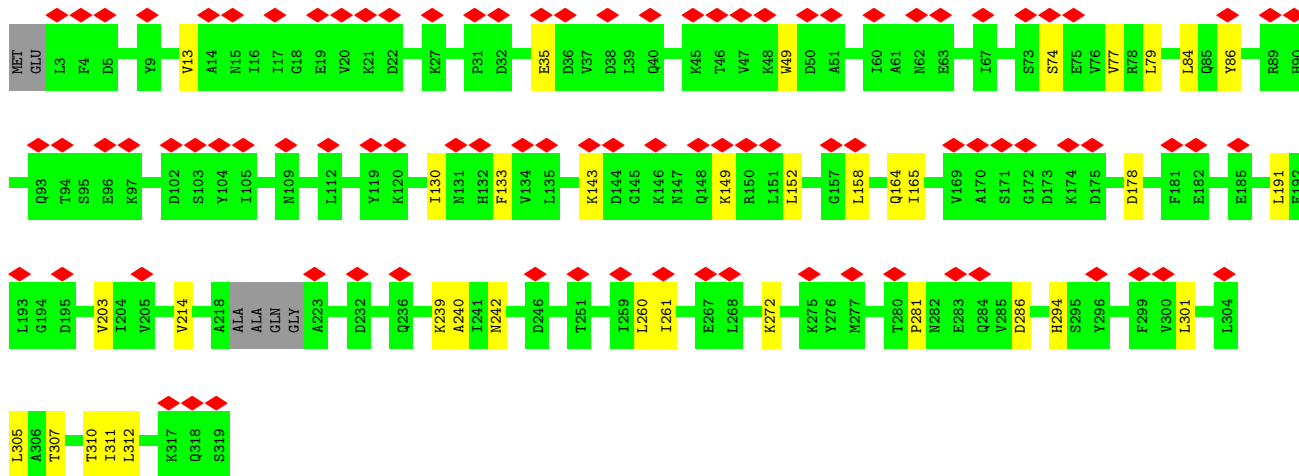
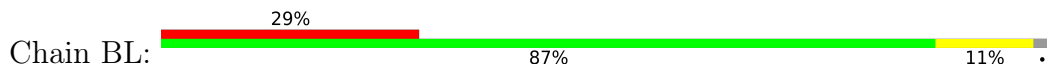

• Molecule 1: Major capsid protein

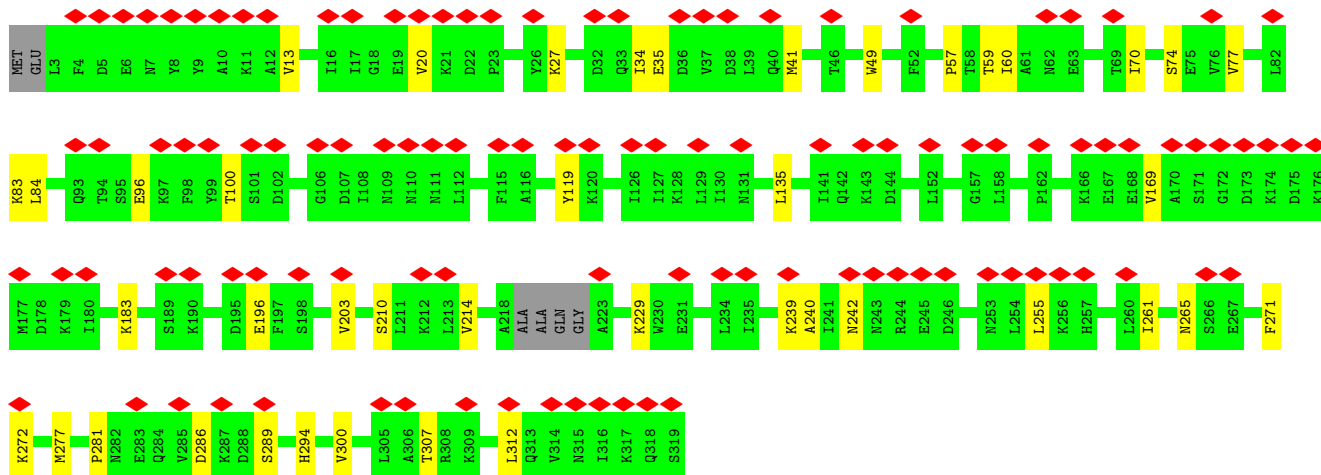
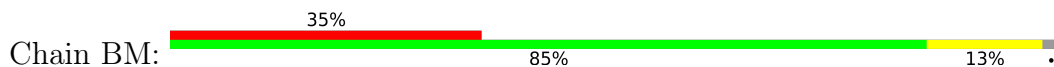

• Molecule 1: Major capsid protein

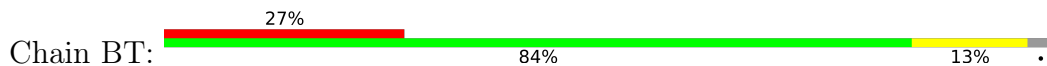

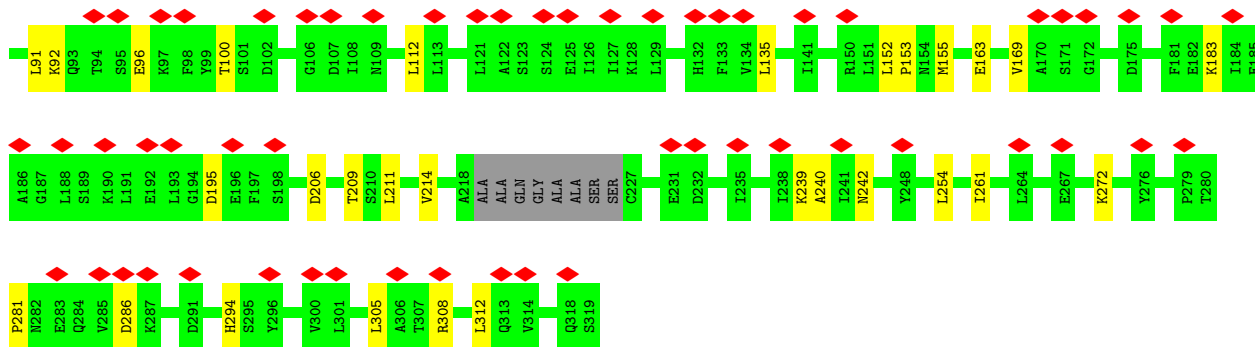

• Molecule 1: Major capsid protein

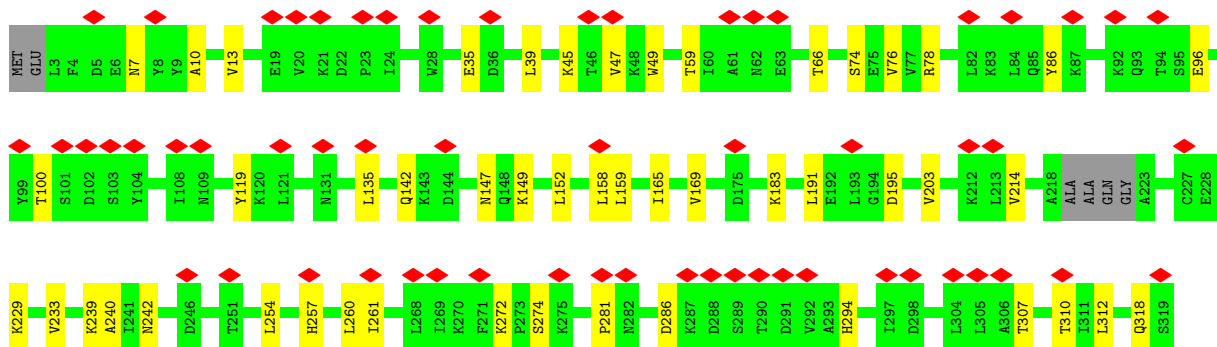
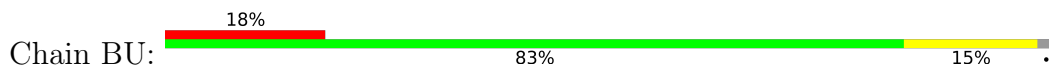

• Molecule 1: Major capsid protein

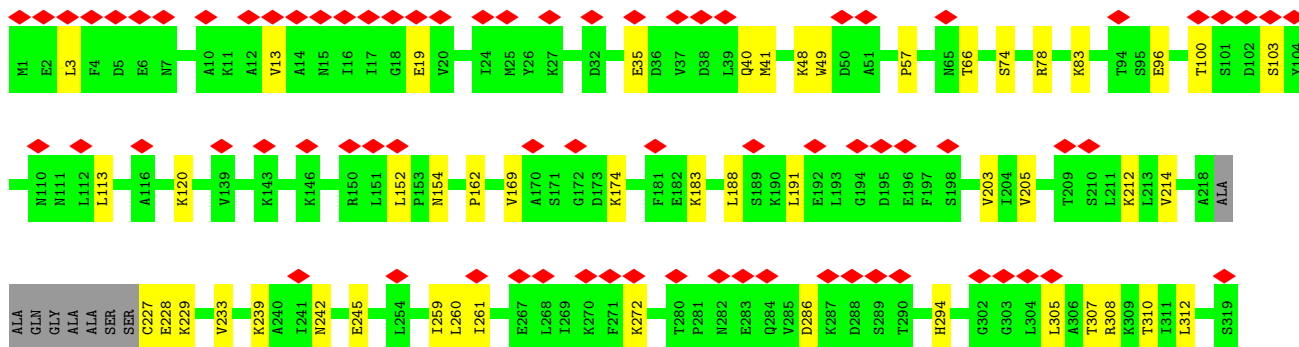
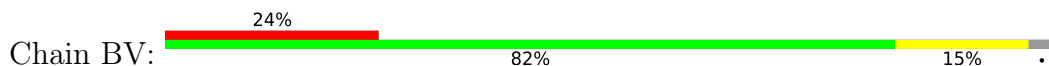

• Molecule 1: Major capsid protein

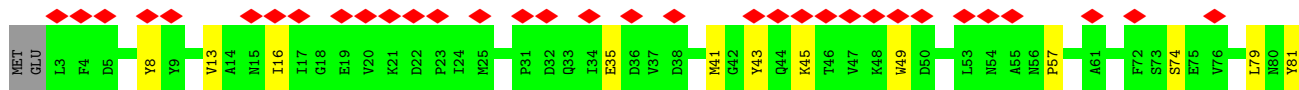
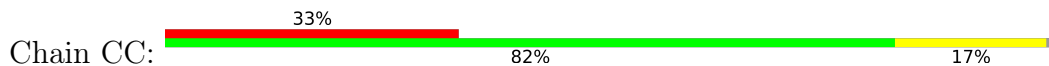

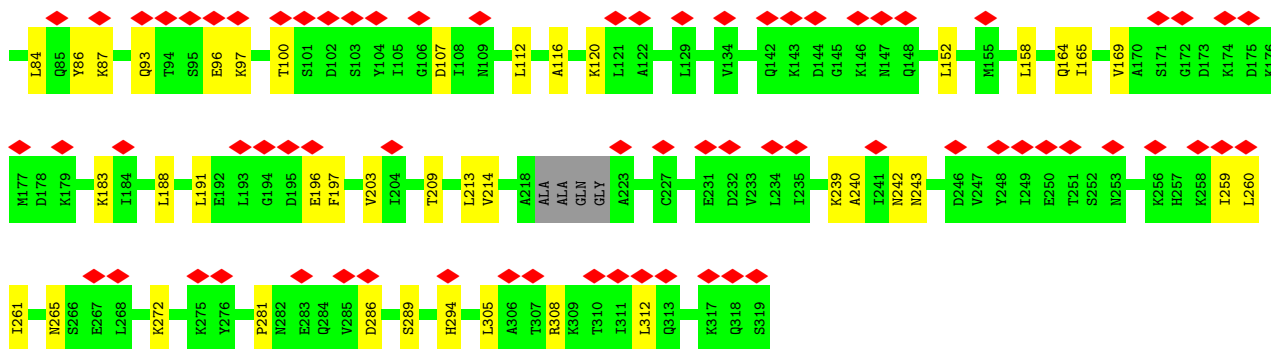

• Molecule 1: Major capsid protein

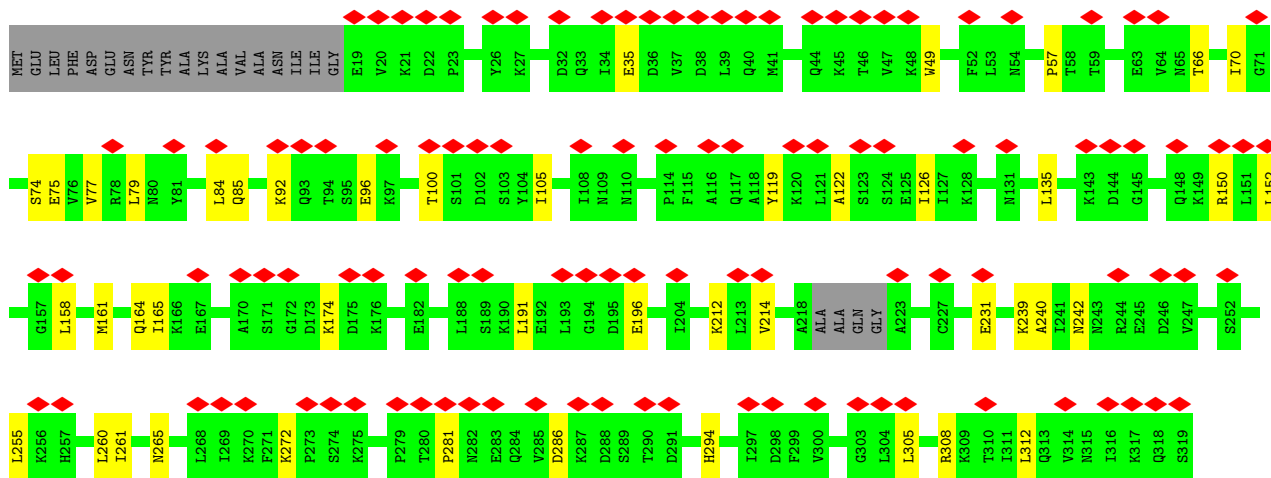
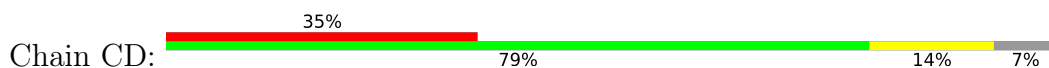

• Molecule 1: Major capsid protein

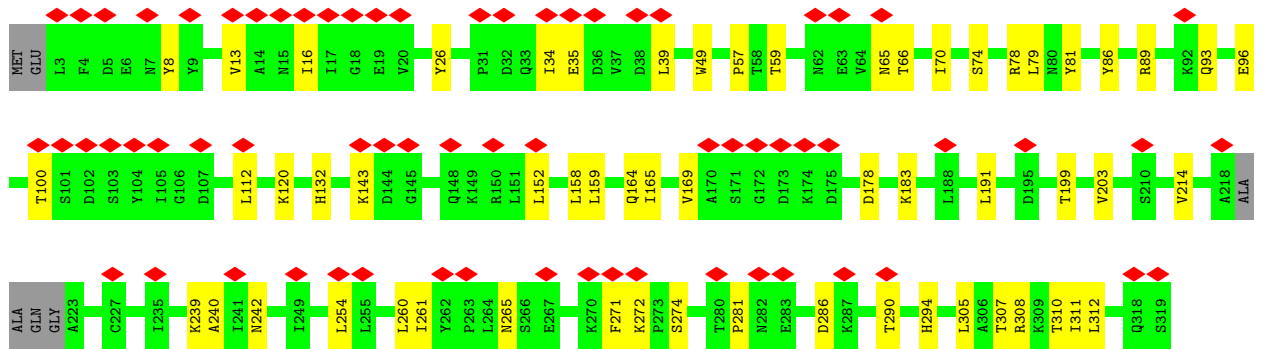
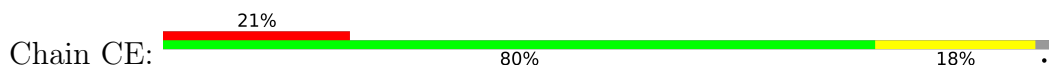

• Molecule 1: Major capsid protein

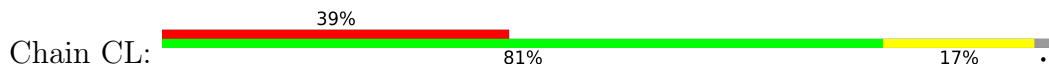

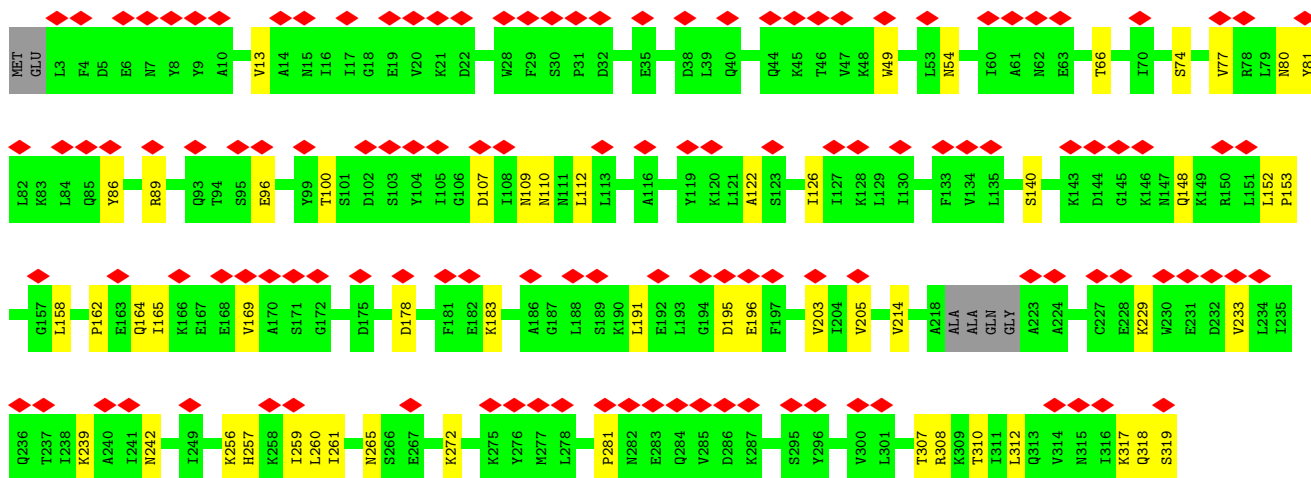

• Molecule 1: Major capsid protein

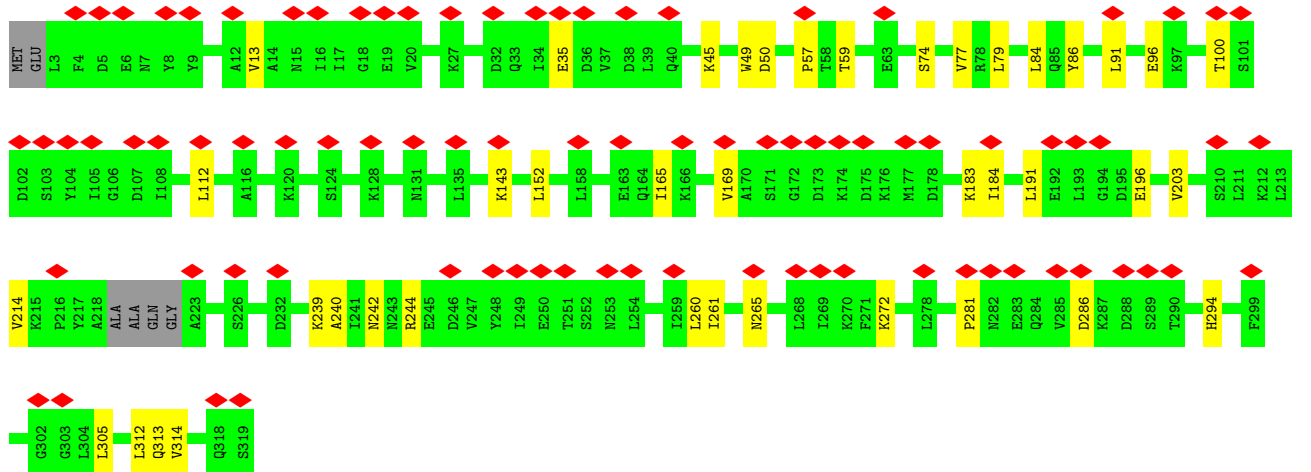
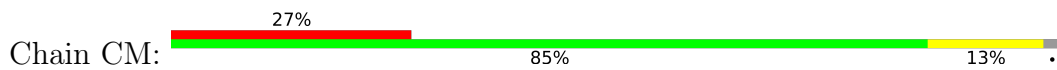

• Molecule 1: Major capsid protein

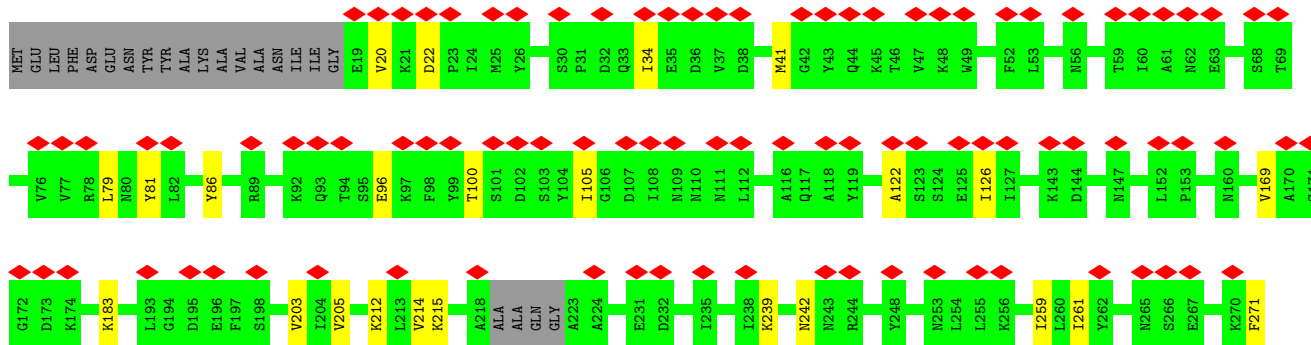
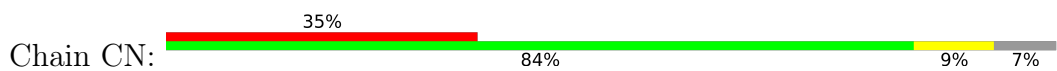

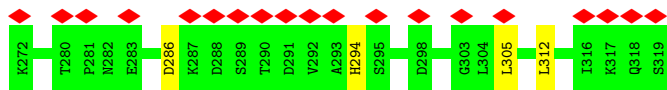

• Molecule 1: Major capsid protein

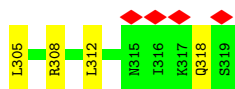
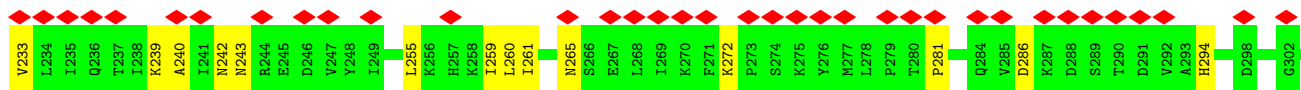
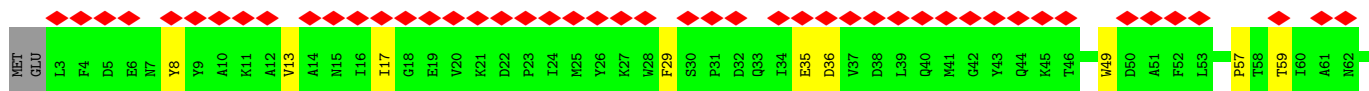
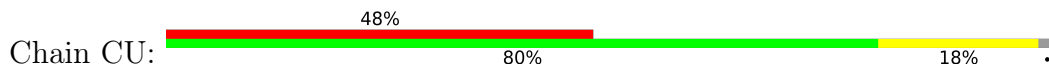

• Molecule 1: Major capsid protein

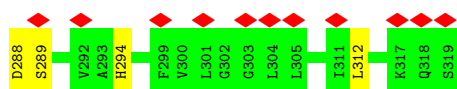
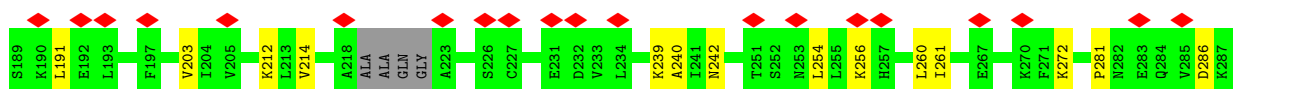
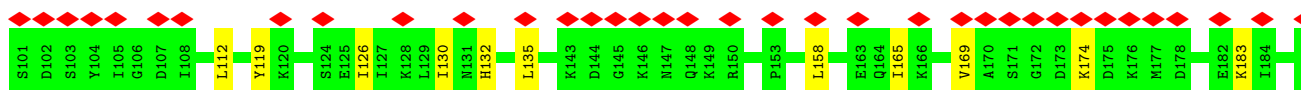
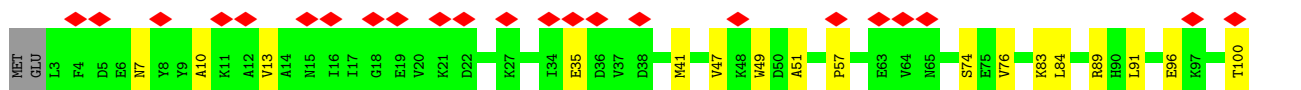
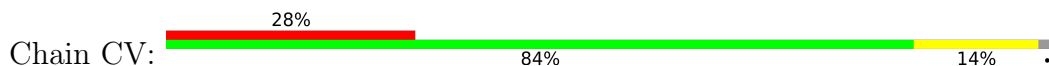

• Molecule 1: Major capsid protein

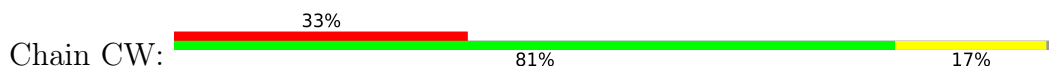

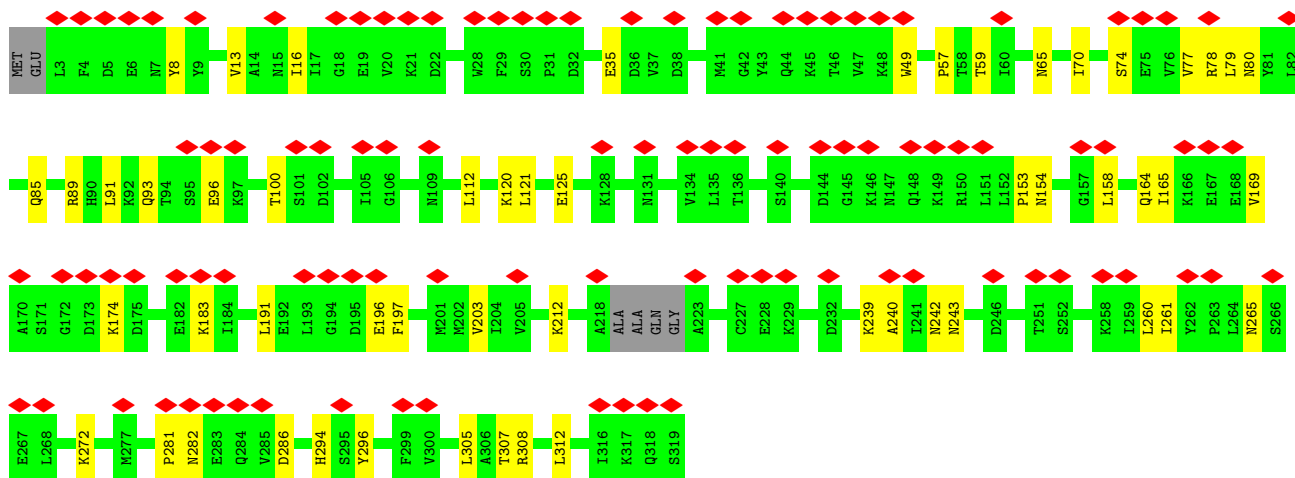

• Molecule 1: Major capsid protein

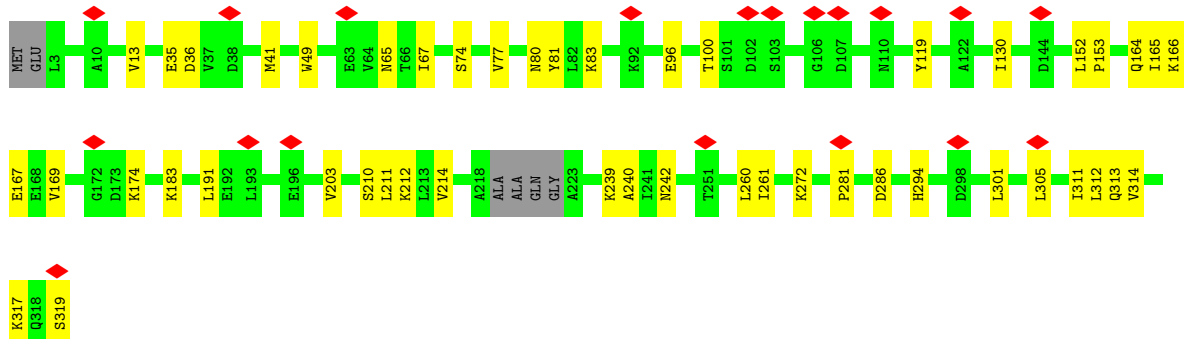
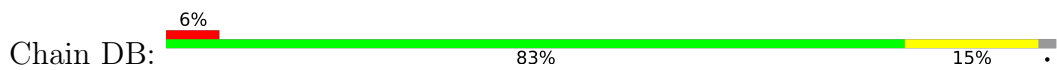

• Molecule 1: Major capsid protein

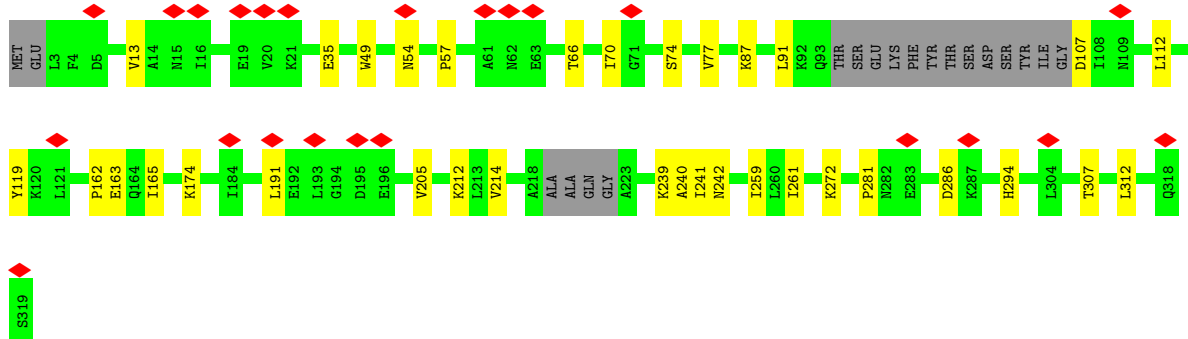
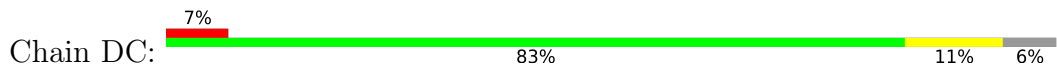

• Molecule 1: Major capsid protein

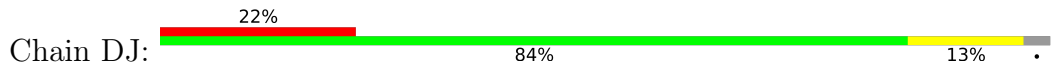

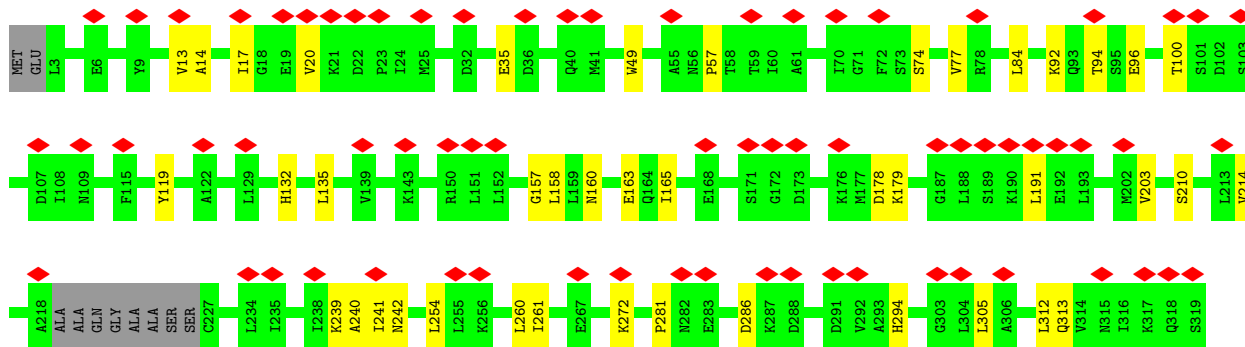

• Molecule 1: Major capsid protein

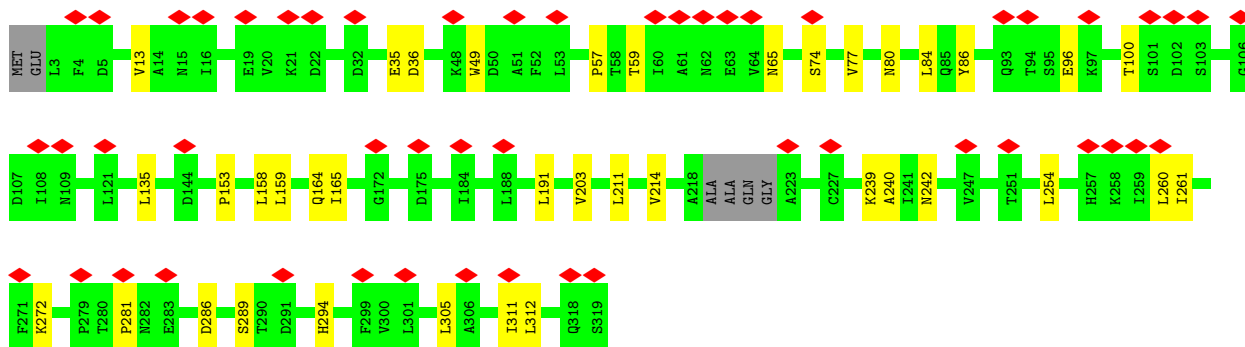
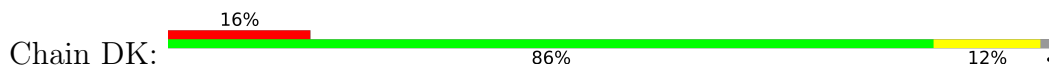

• Molecule 1: Major capsid protein

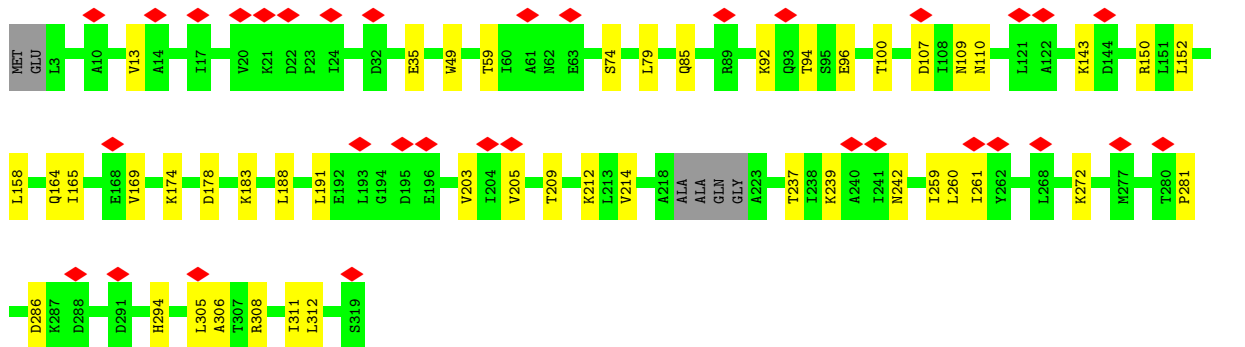
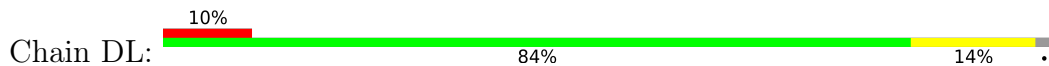

• Molecule 1: Major capsid protein

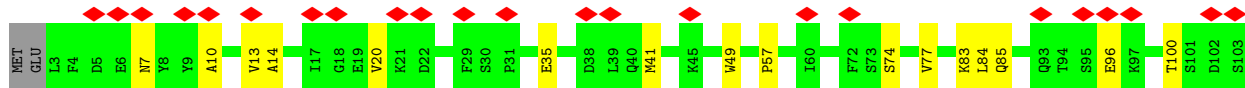
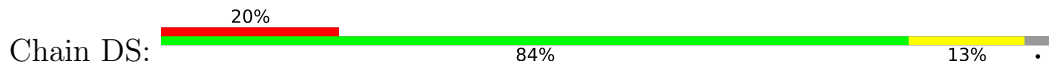

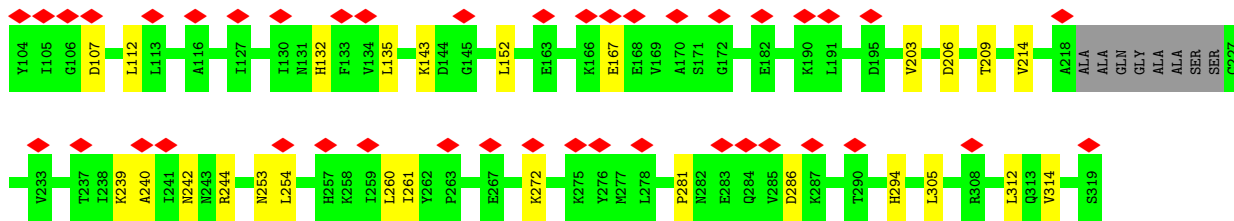

• Molecule 1: Major capsid protein

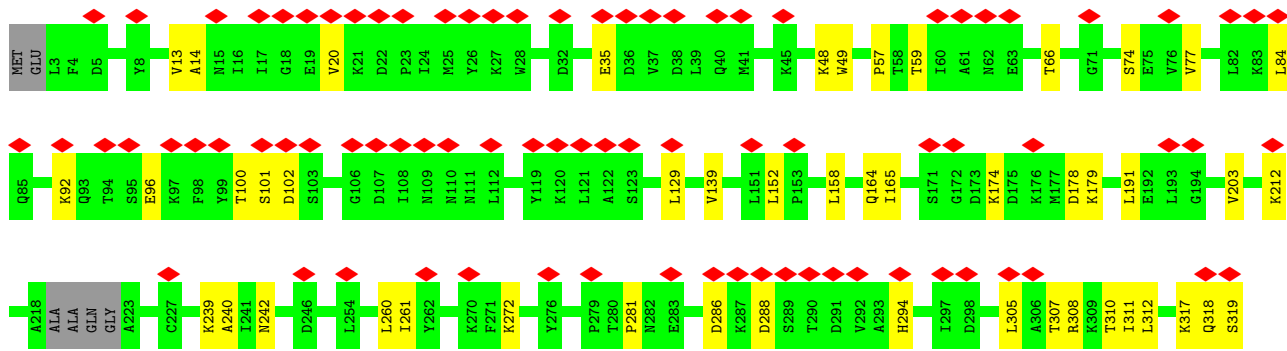
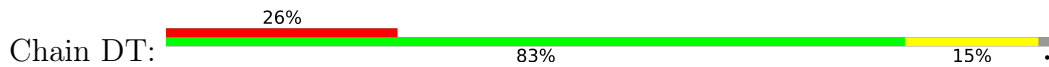

• Molecule 1: Major capsid protein

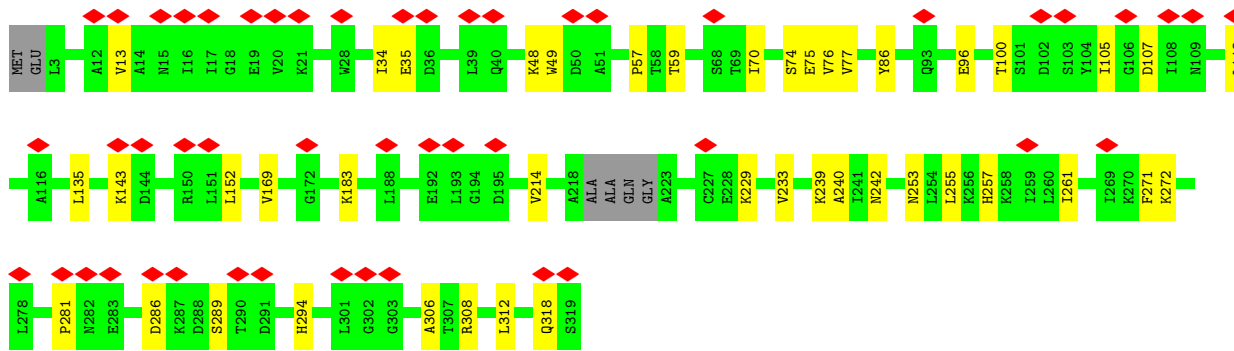
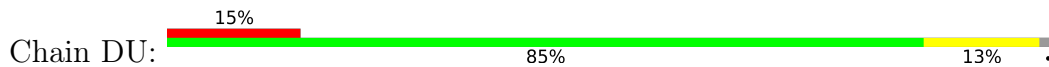

• Molecule 1: Major capsid protein

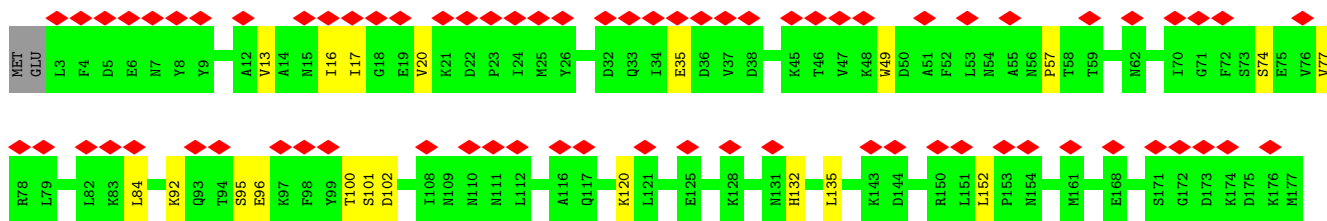
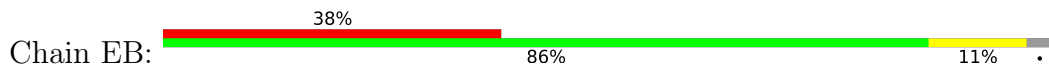

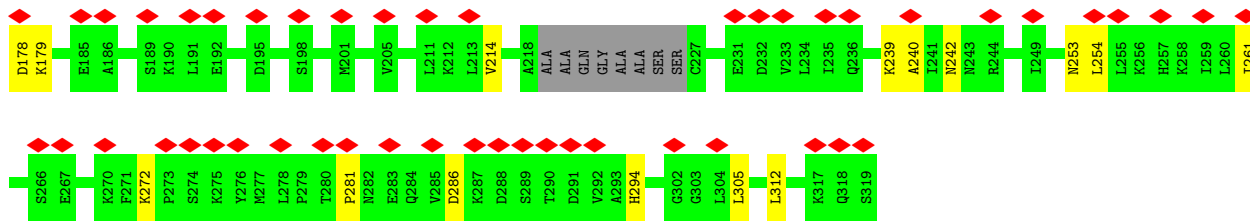

• Molecule 1: Major capsid protein

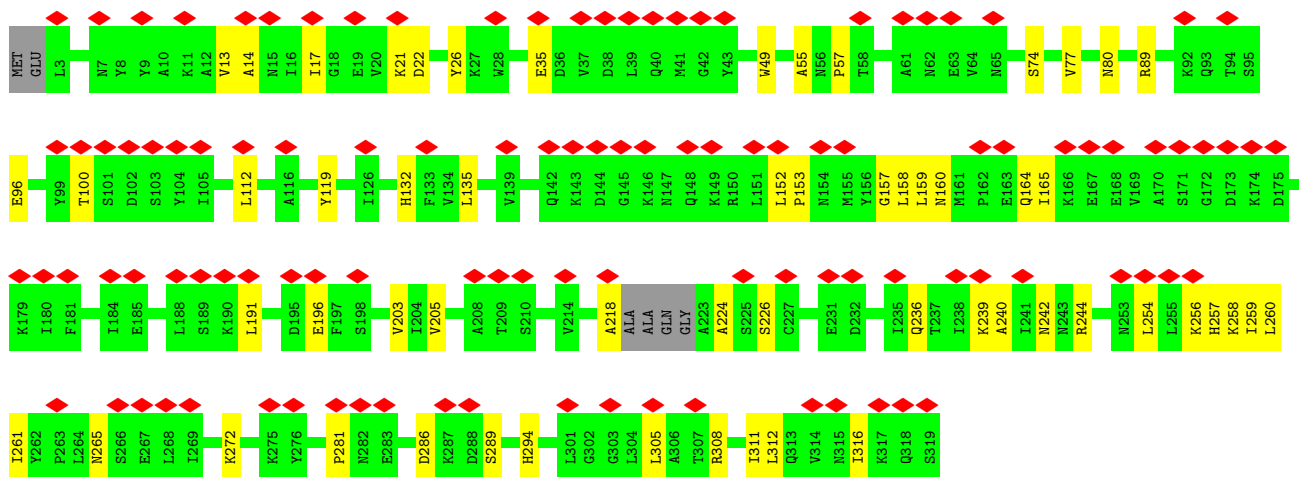
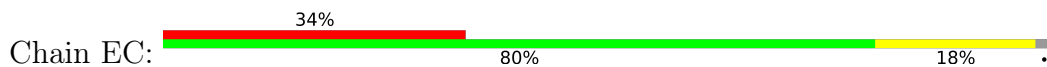

• Molecule 1: Major capsid protein

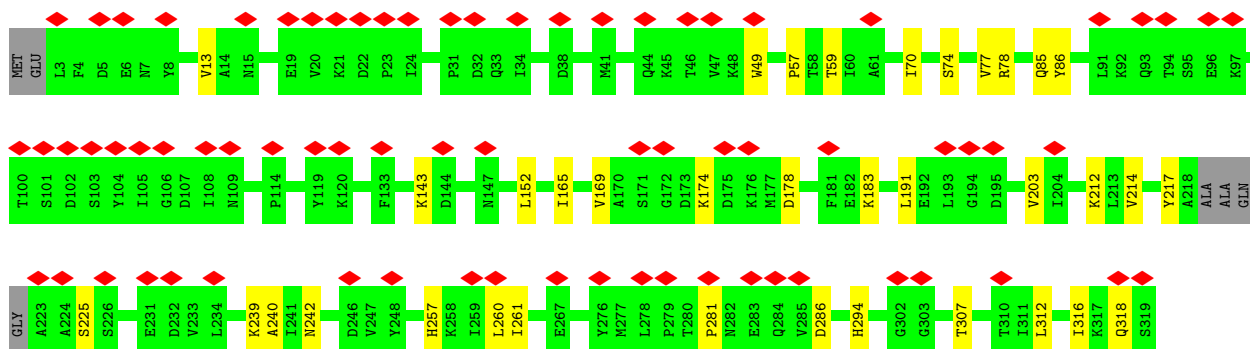
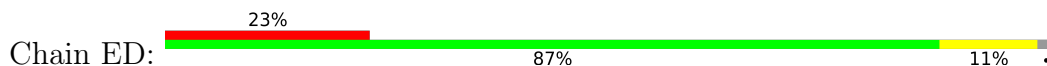

• Molecule 1: Major capsid protein

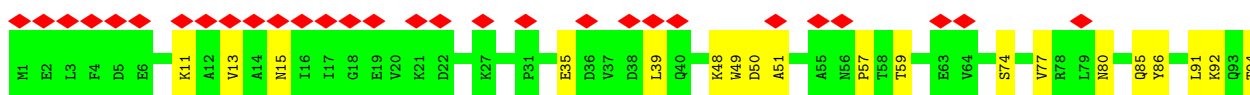
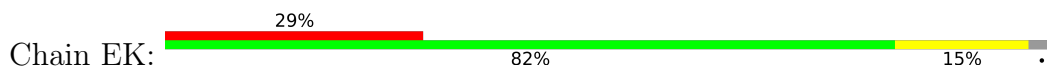

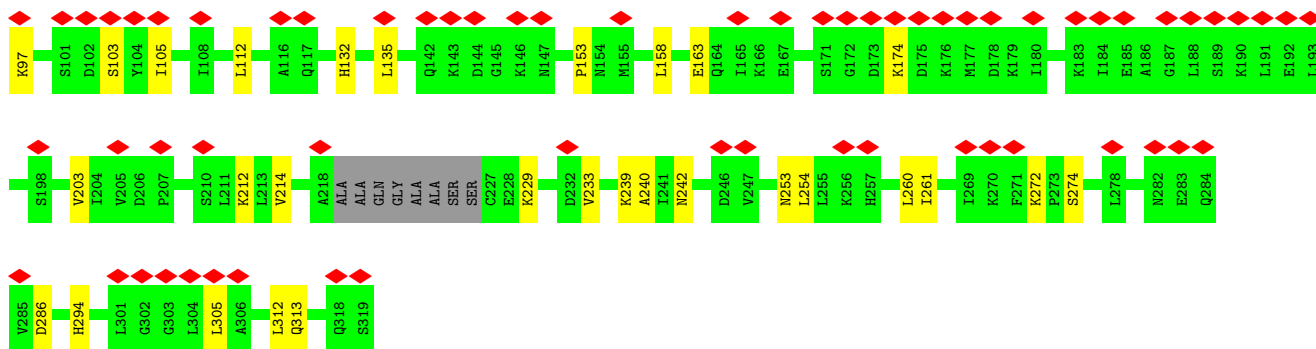

• Molecule 1: Major capsid protein

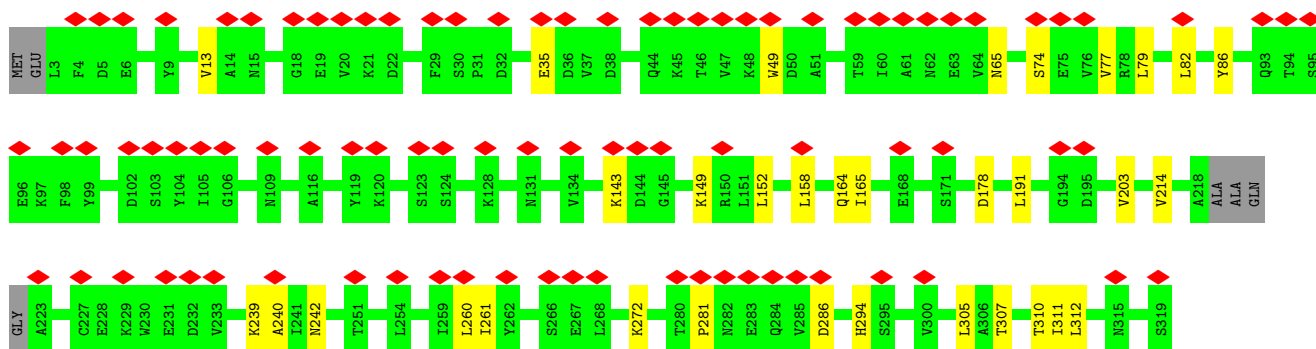
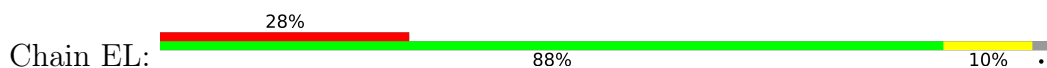

• Molecule 1: Major capsid protein

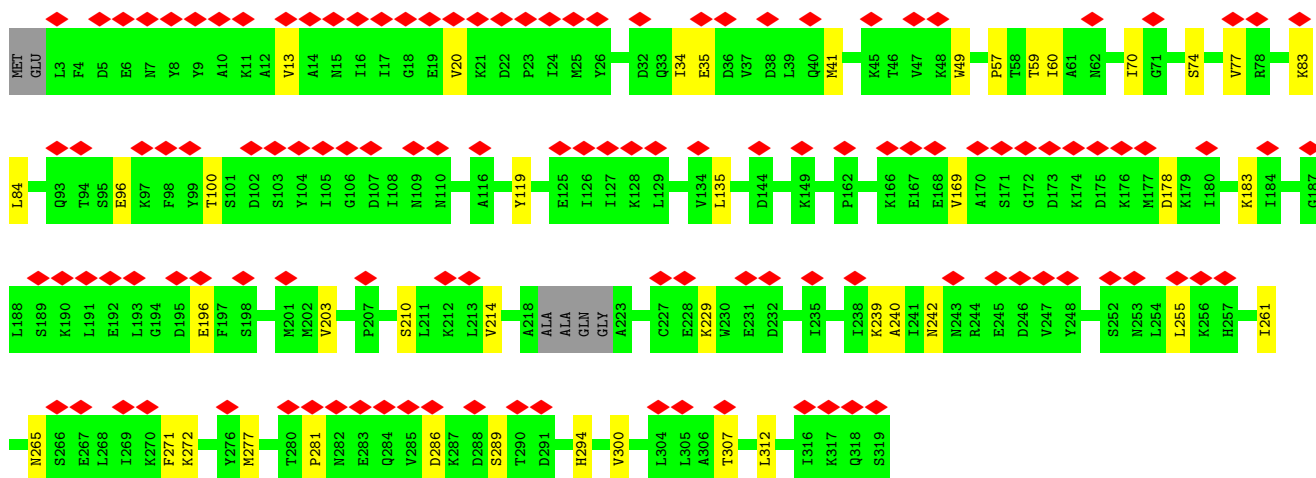
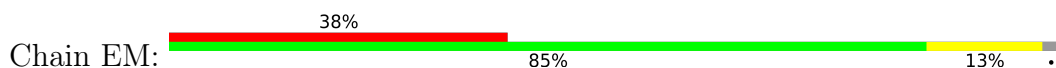

• Molecule 1: Major capsid protein

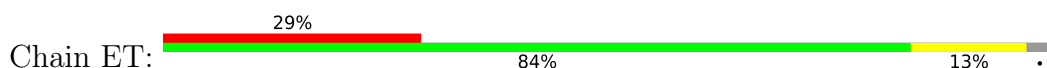

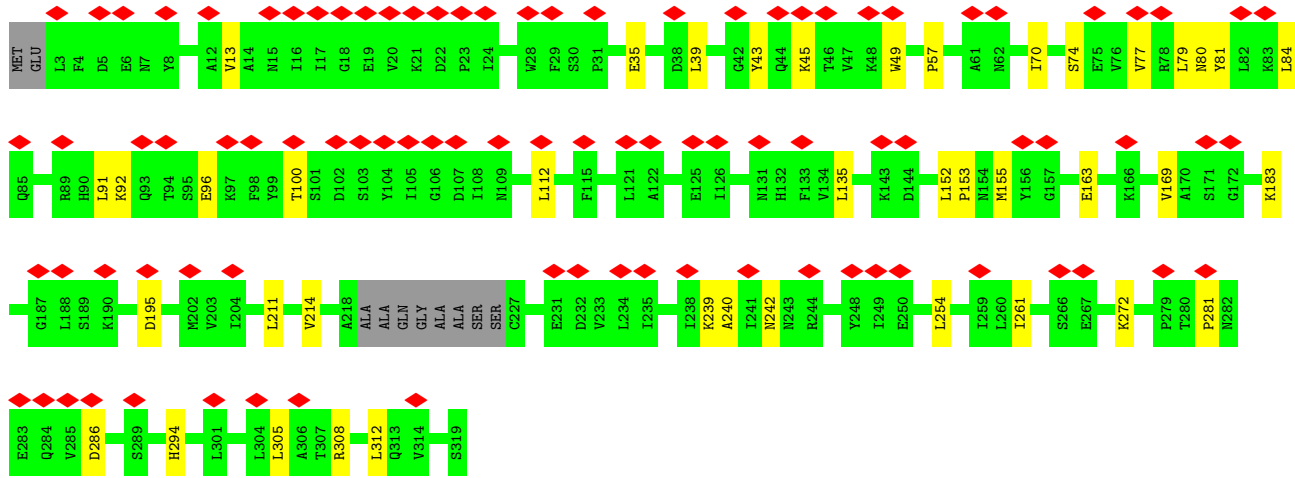

• Molecule 1: Major capsid protein

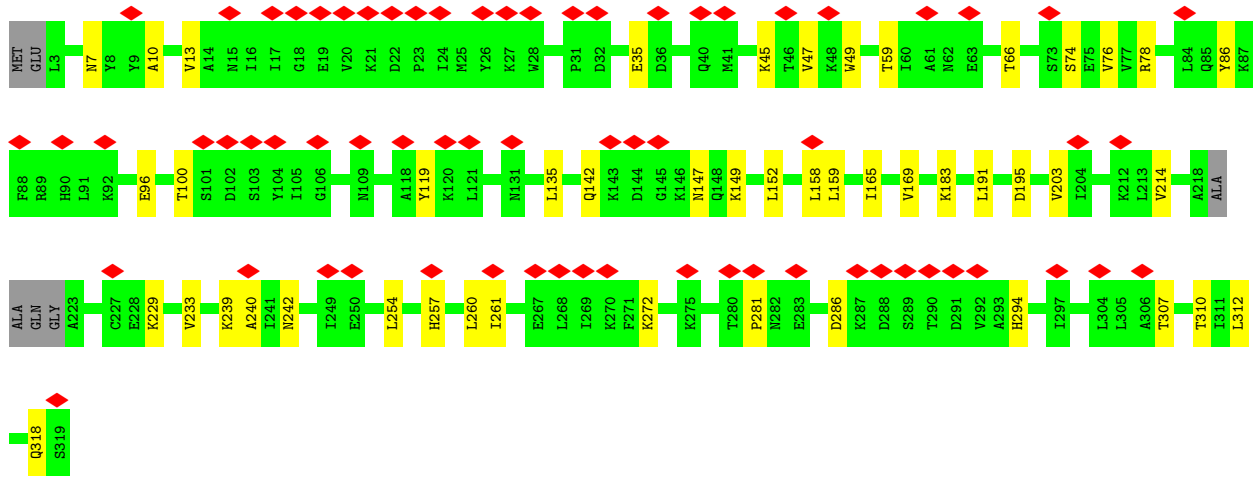
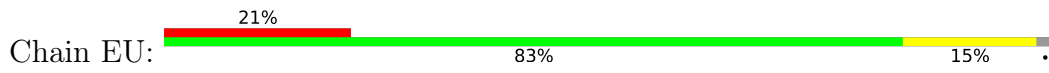

• Molecule 1: Major capsid protein

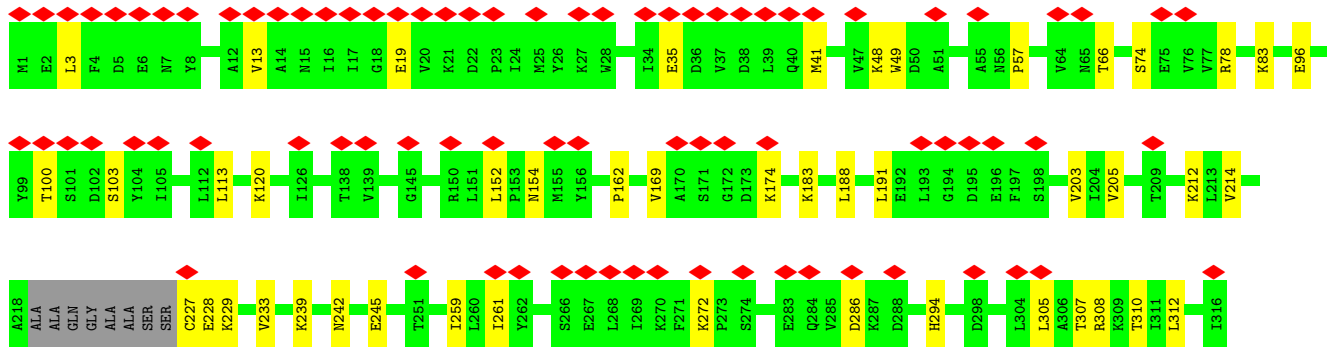
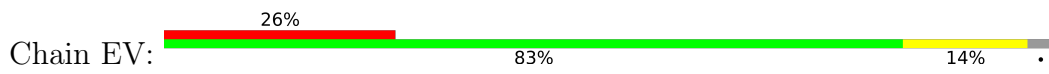



• Molecule 1: Major capsid protein

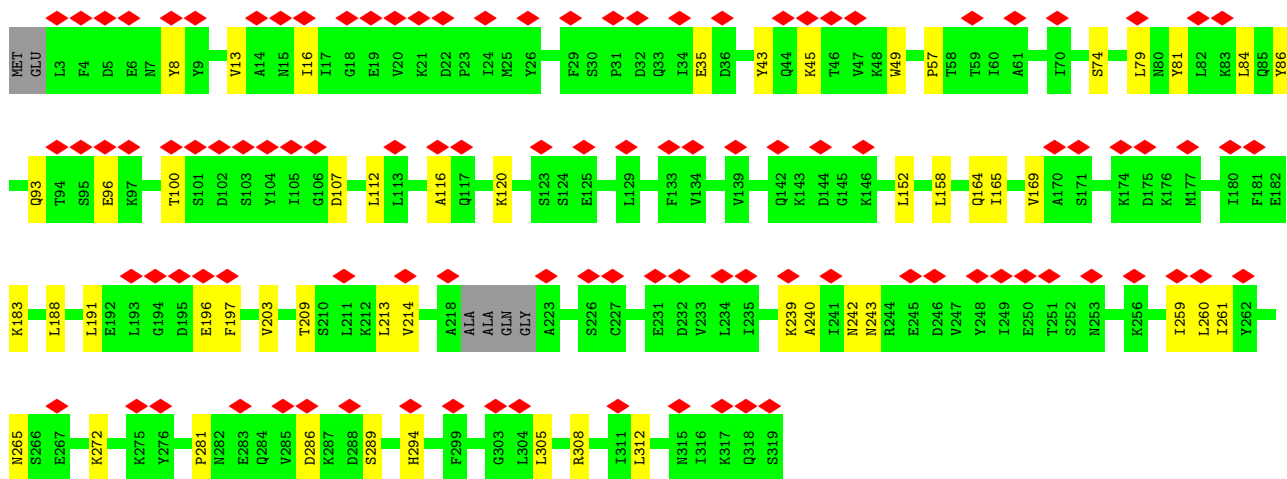
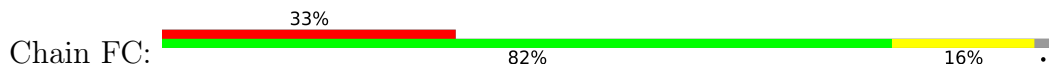

• Molecule 1: Major capsid protein

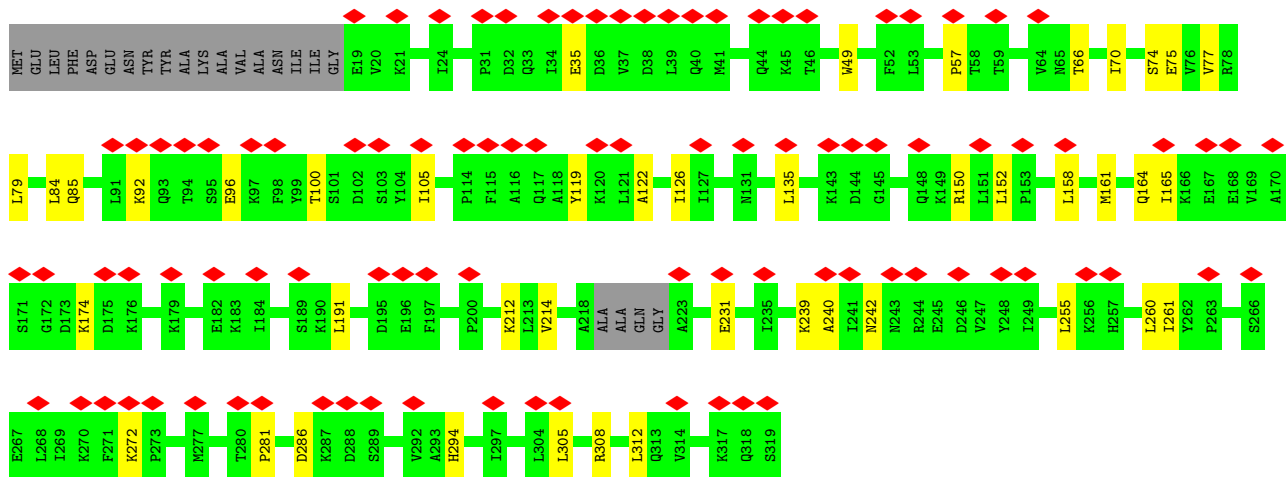
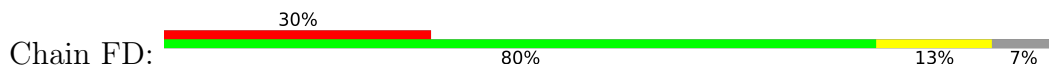

• Molecule 1: Major capsid protein

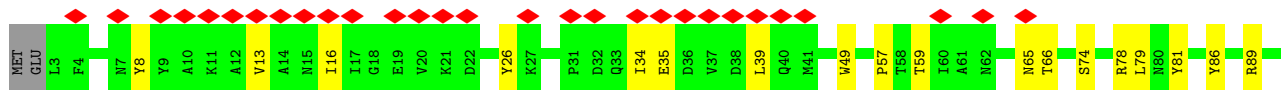
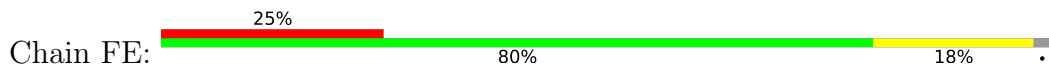

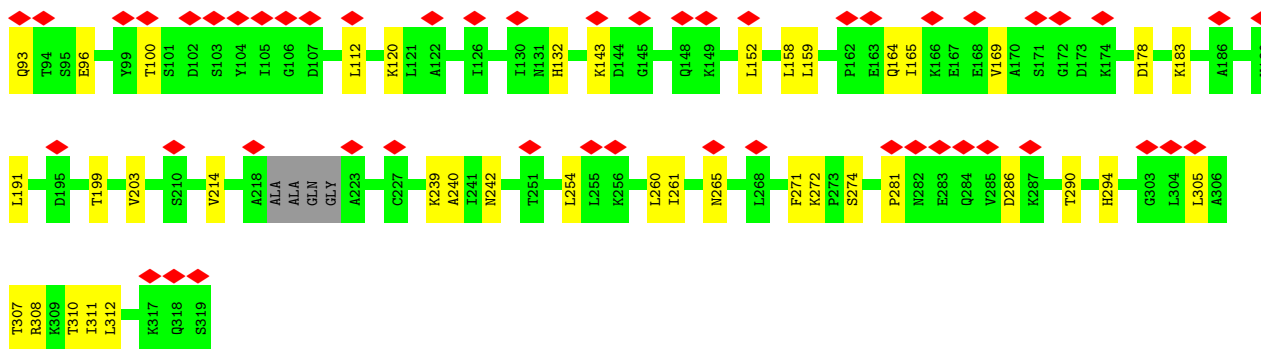

• Molecule 1: Major capsid protein

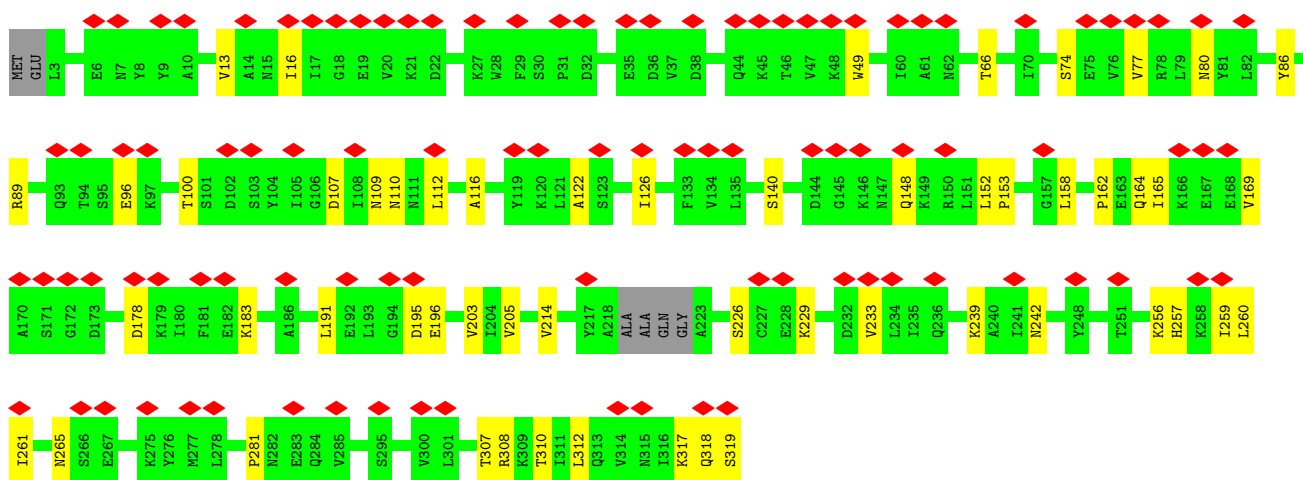
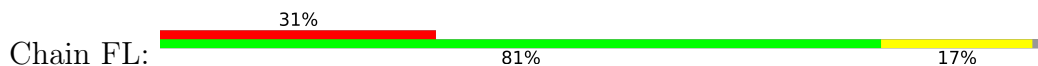

• Molecule 1: Major capsid protein

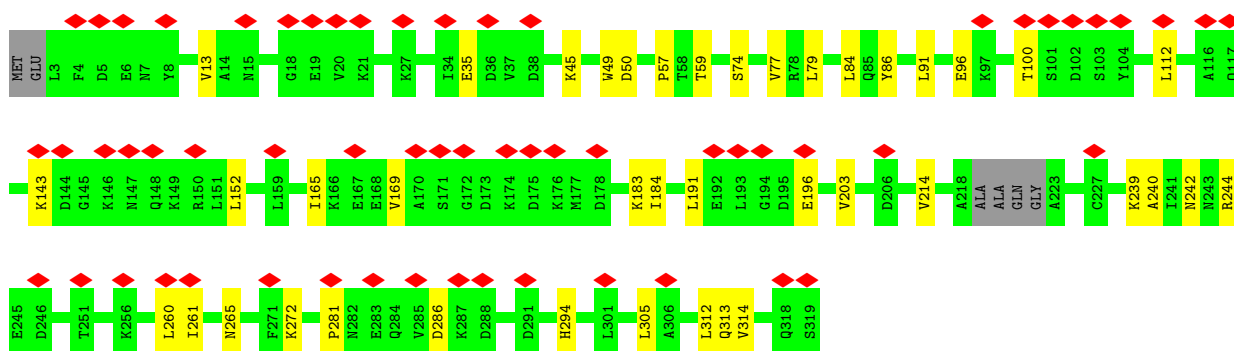
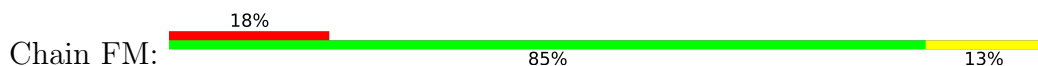

• Molecule 1: Major capsid protein

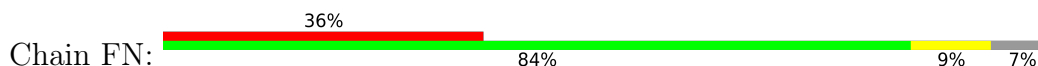

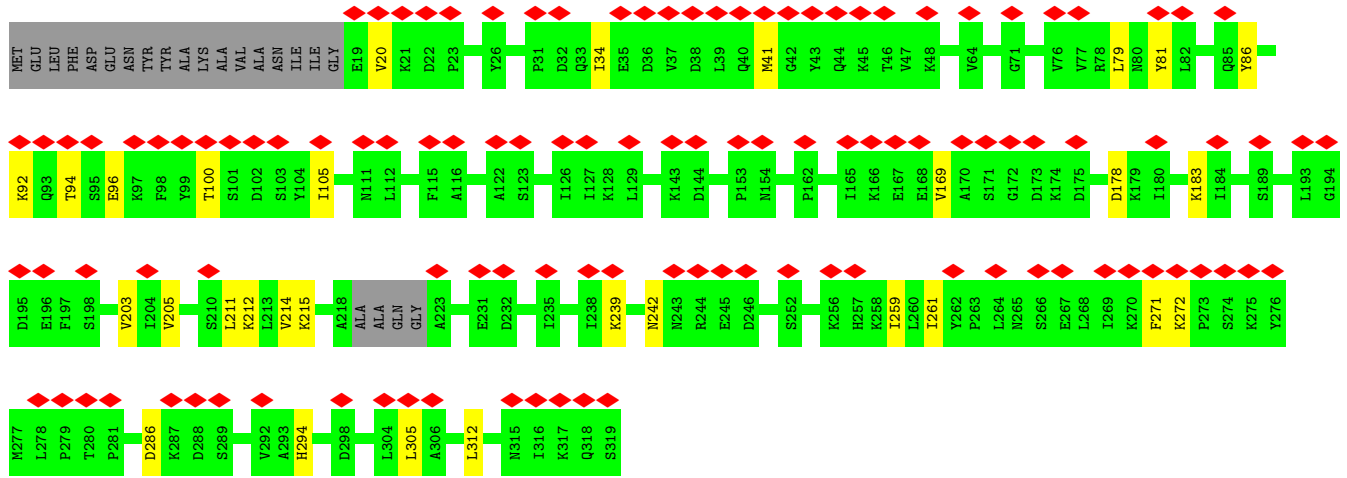

• Molecule 1: Major capsid protein

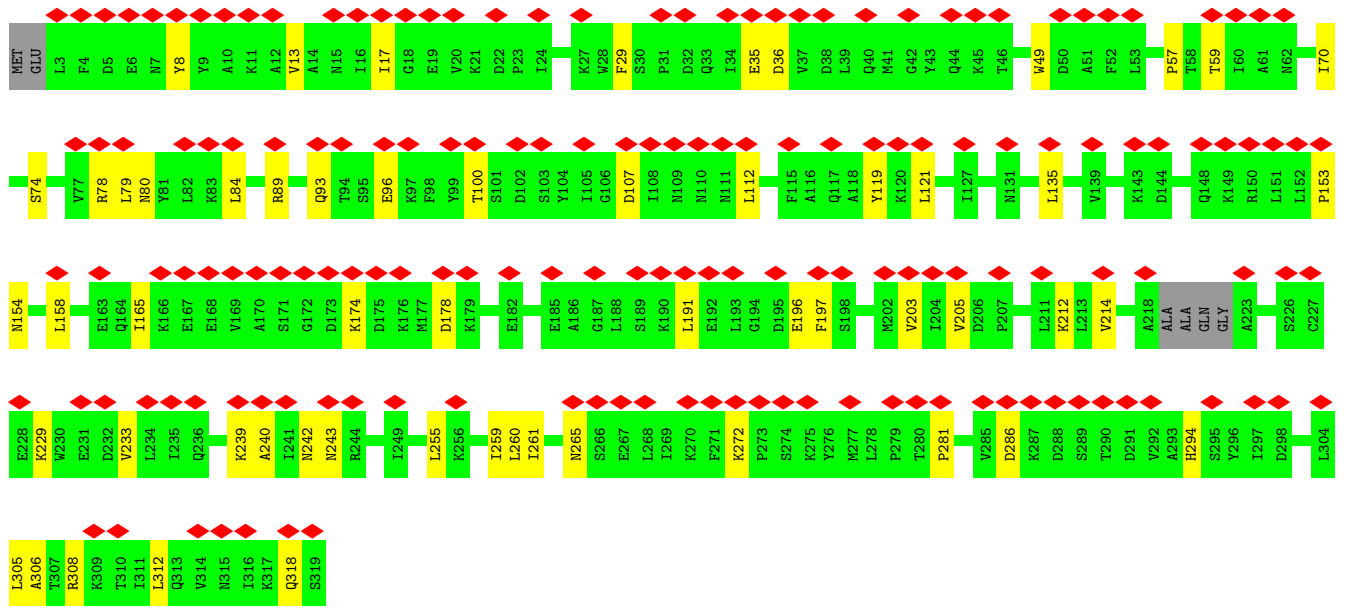
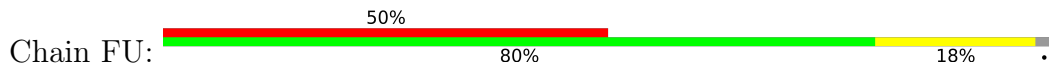

• Molecule 1: Major capsid protein

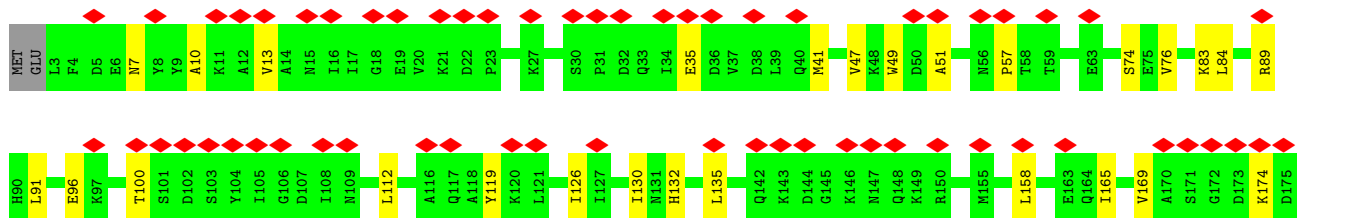
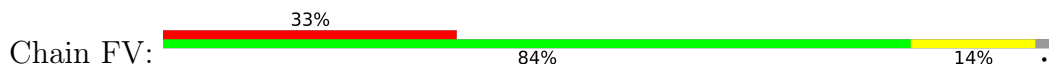

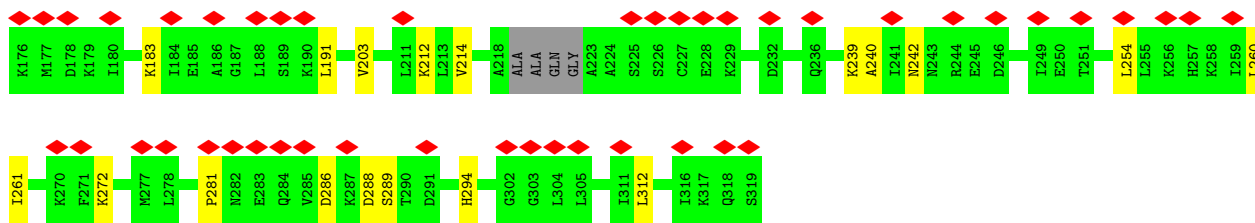

• Molecule 1: Major capsid protein

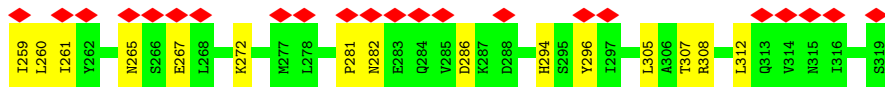
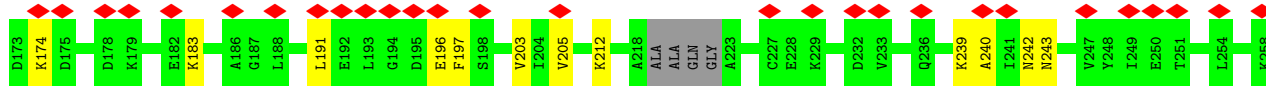
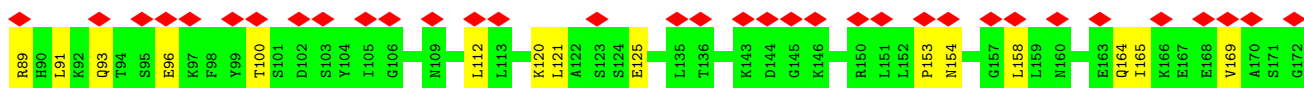
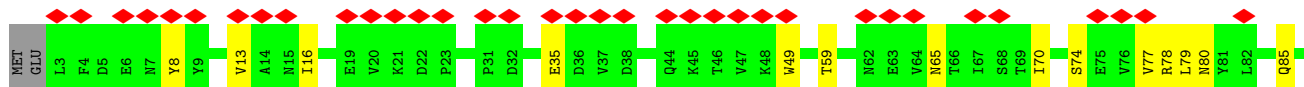
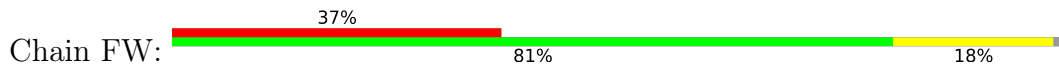

• Molecule 1: Major capsid protein

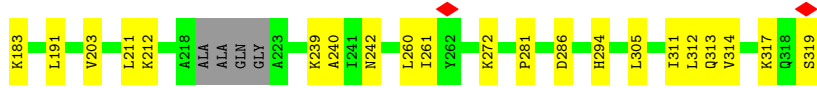
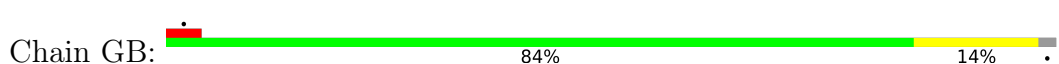

• Molecule 1: Major capsid protein

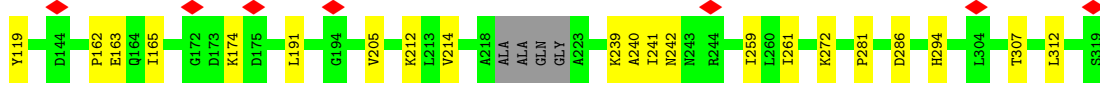
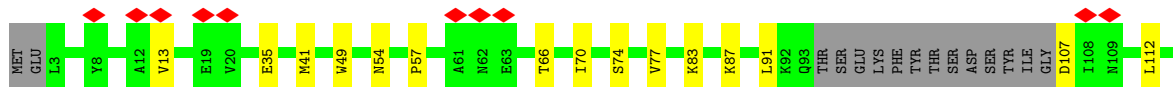
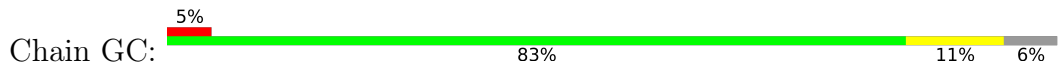

• Molecule 1: Major capsid protein

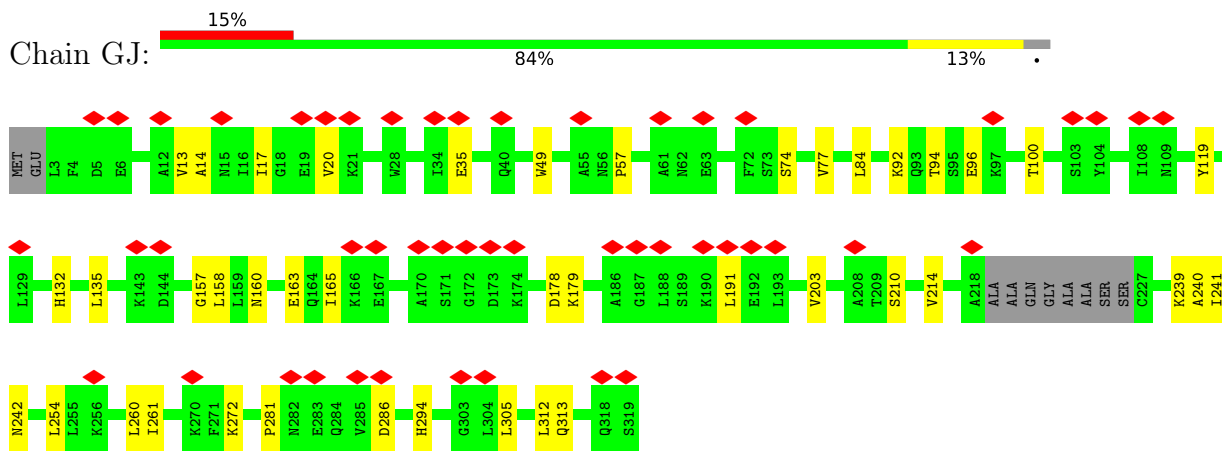

• Molecule 1: Major capsid protein

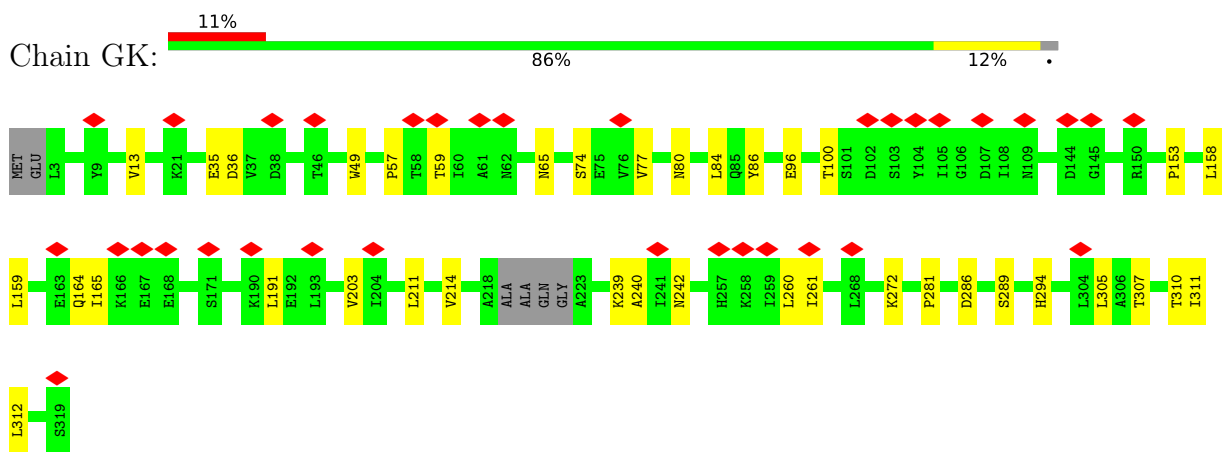

• Molecule 1: Major capsid protein

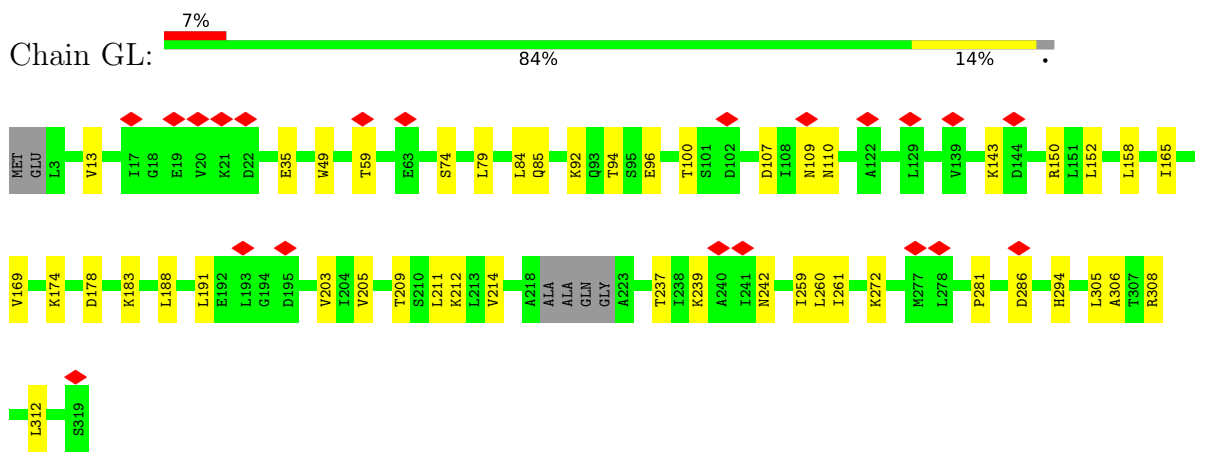

• Molecule 1: Major capsid protein

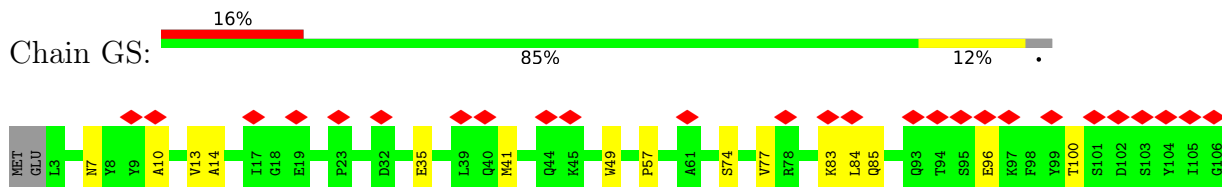

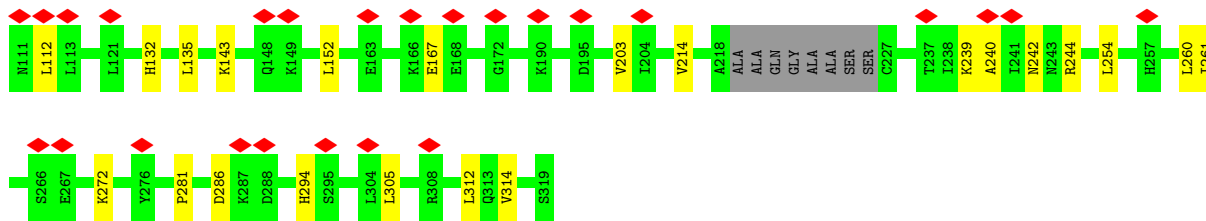

• Molecule 1: Major capsid protein

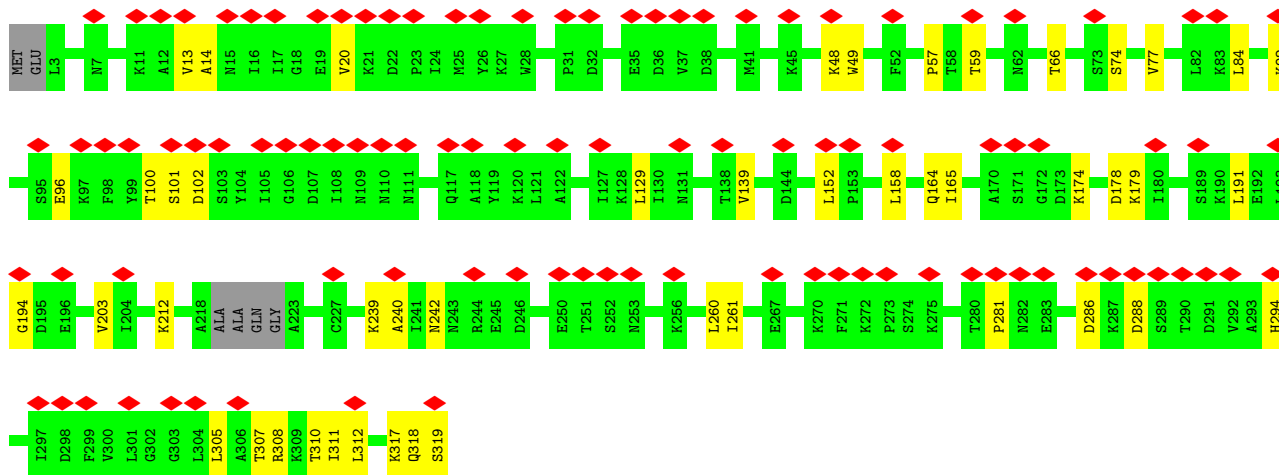
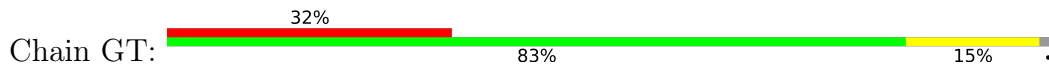

• Molecule 1: Major capsid protein

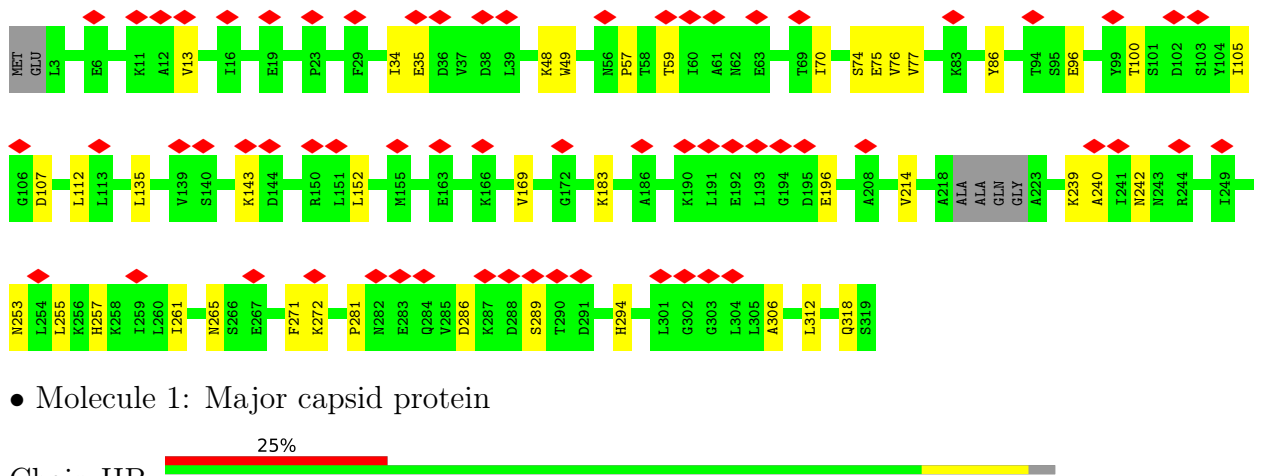
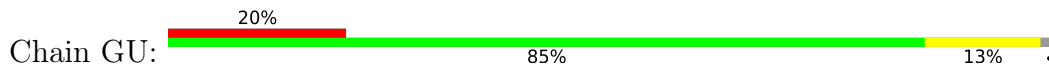

• Molecule 1: Major capsid protein

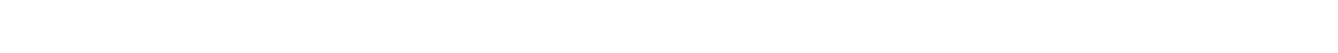
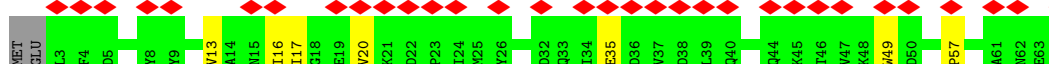

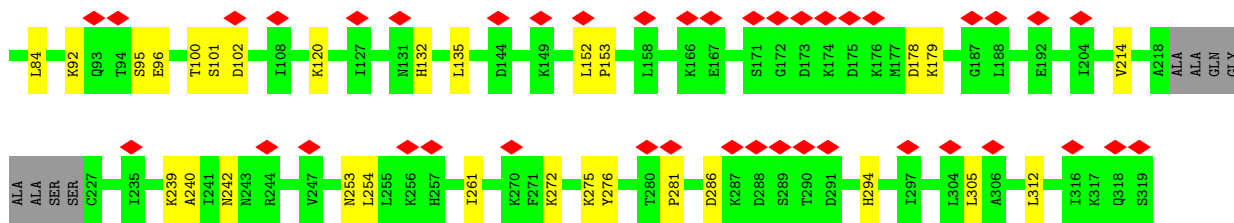

• Molecule 1: Major capsid protein

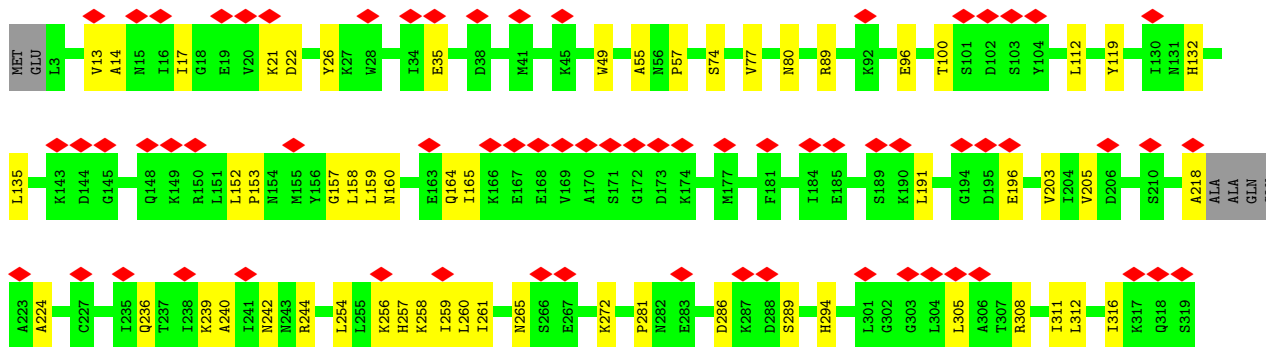
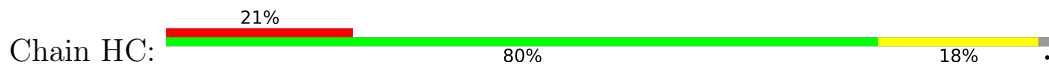

• Molecule 1: Major capsid protein

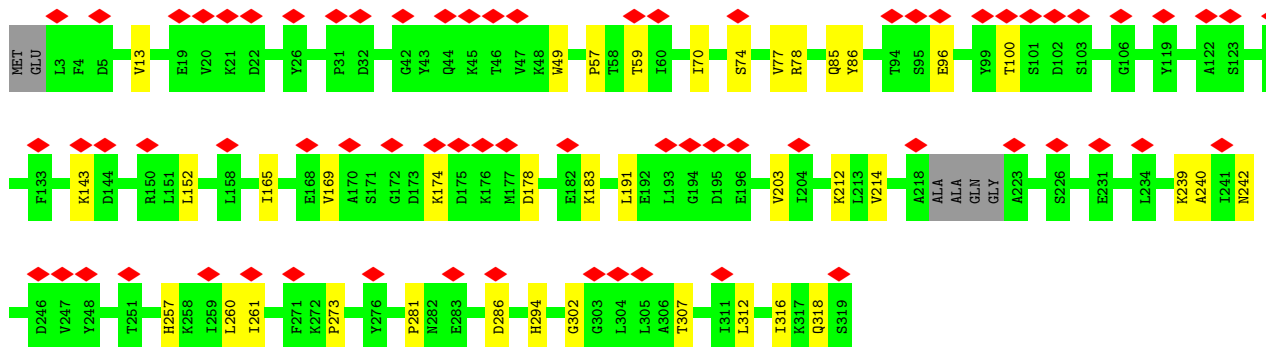
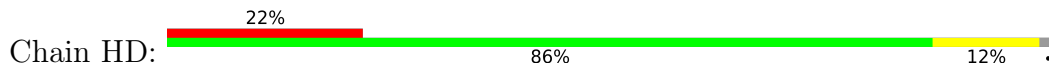

• Molecule 1: Major capsid protein

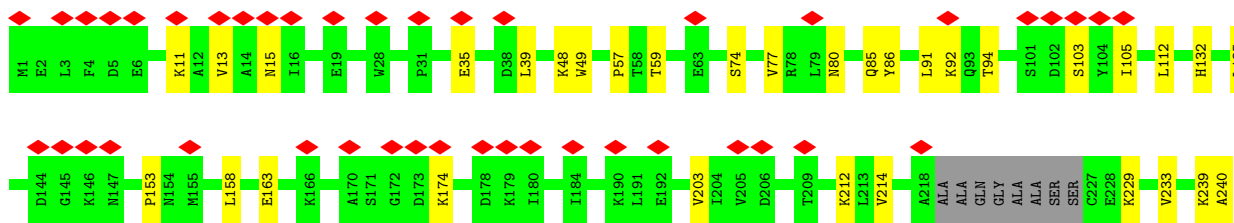
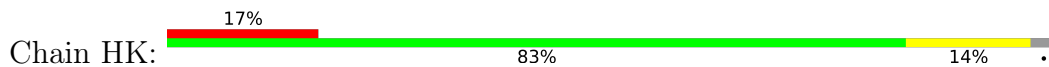



• Molecule 1: Major capsid protein

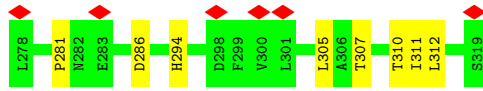
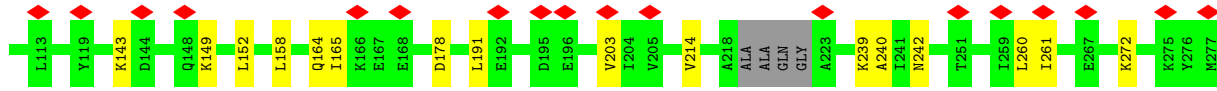
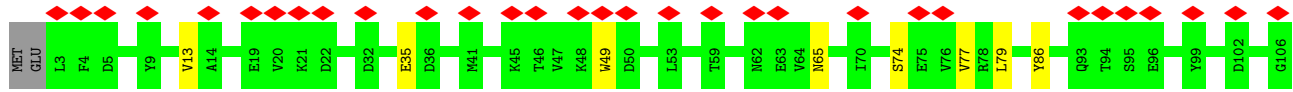
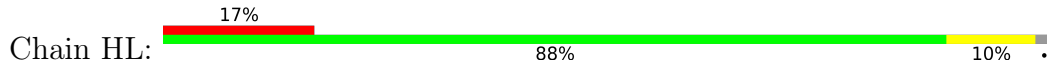

• Molecule 1: Major capsid protein

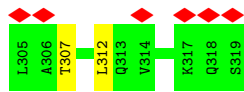
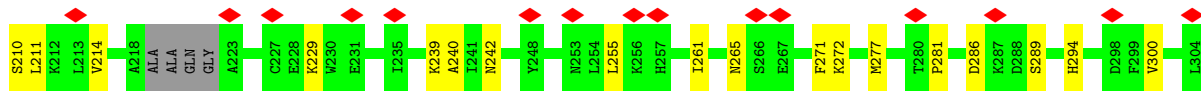
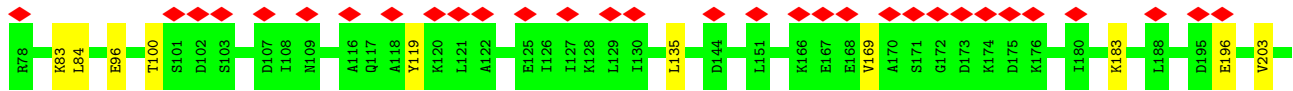
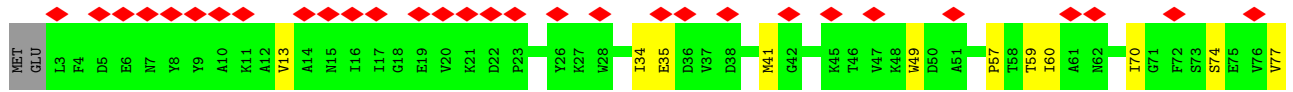
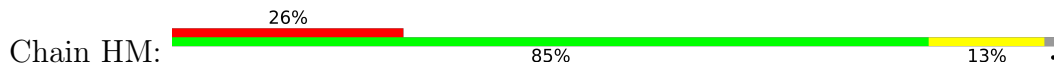

• Molecule 1: Major capsid protein

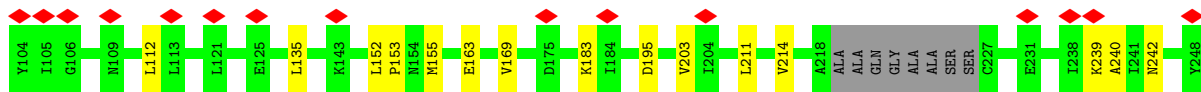
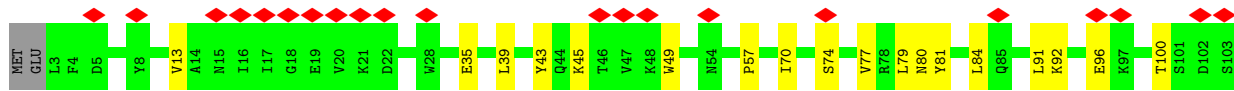
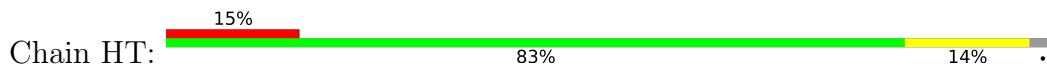

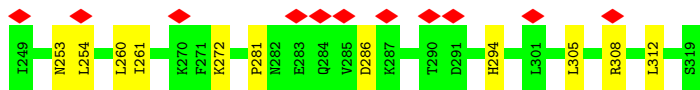

• Molecule 1: Major capsid protein

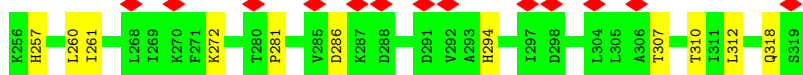
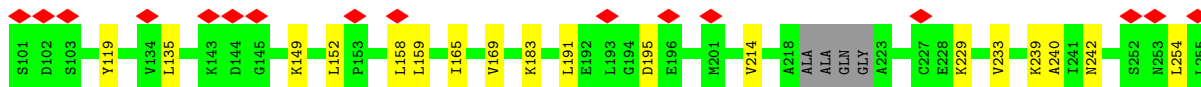
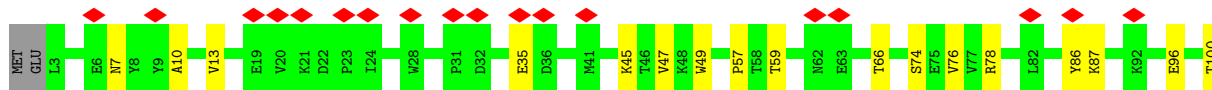
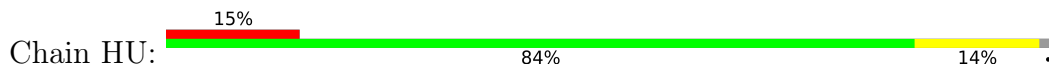

• Molecule 1: Major capsid protein

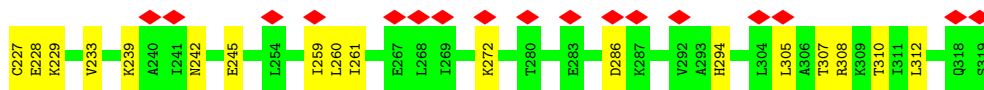
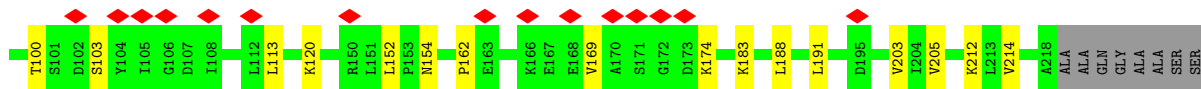
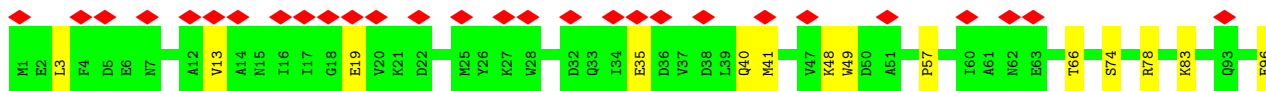
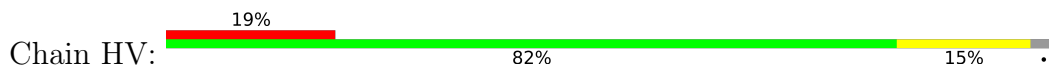

• Molecule 1: Major capsid protein

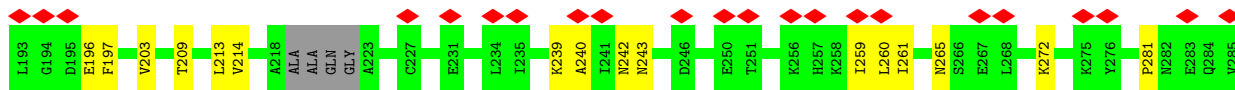
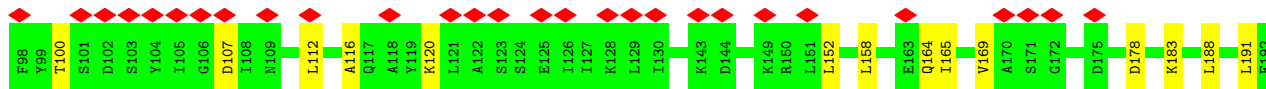
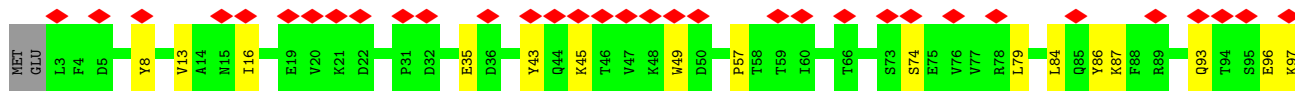
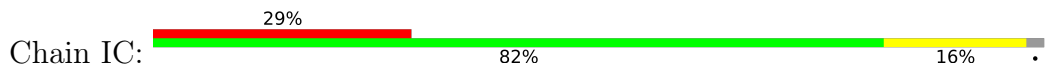

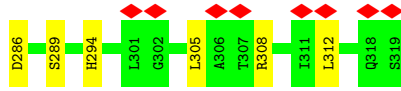

• Molecule 1: Major capsid protein

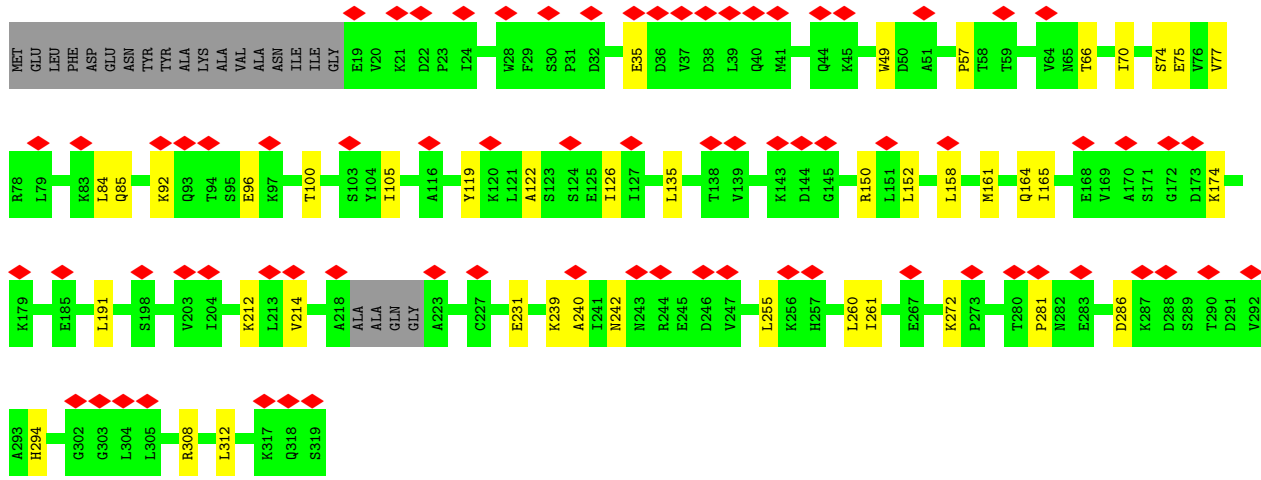
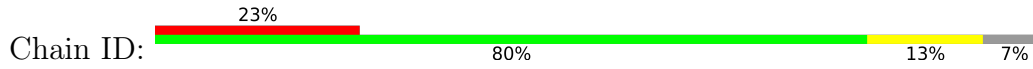

• Molecule 1: Major capsid protein

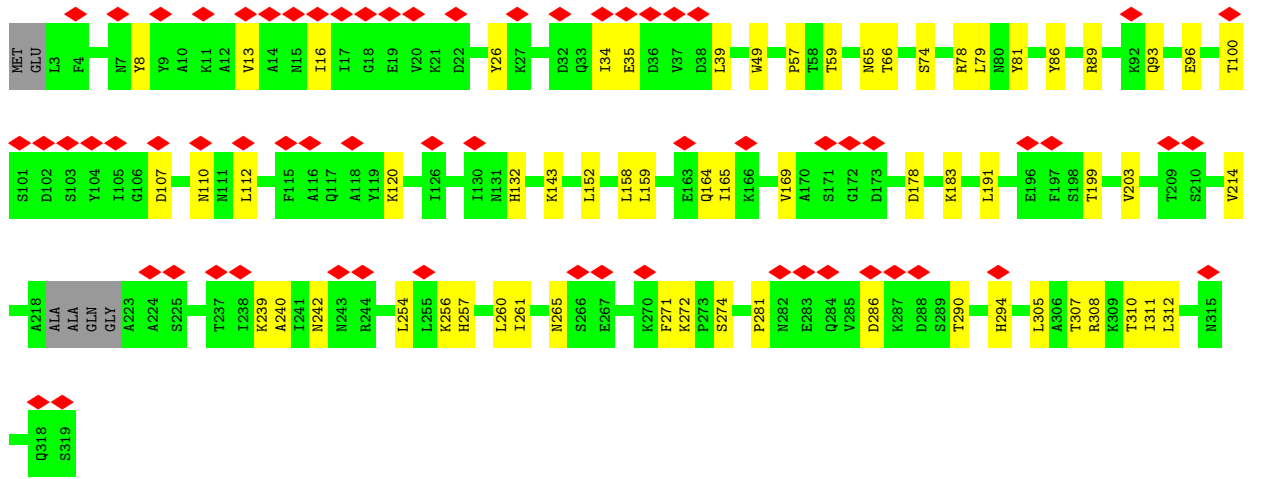
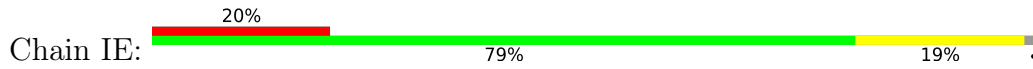

• Molecule 1: Major capsid protein

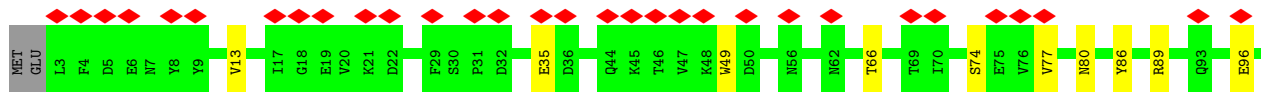
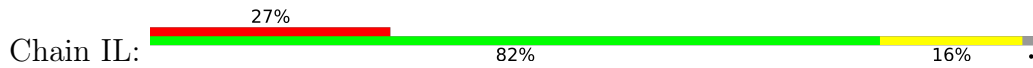

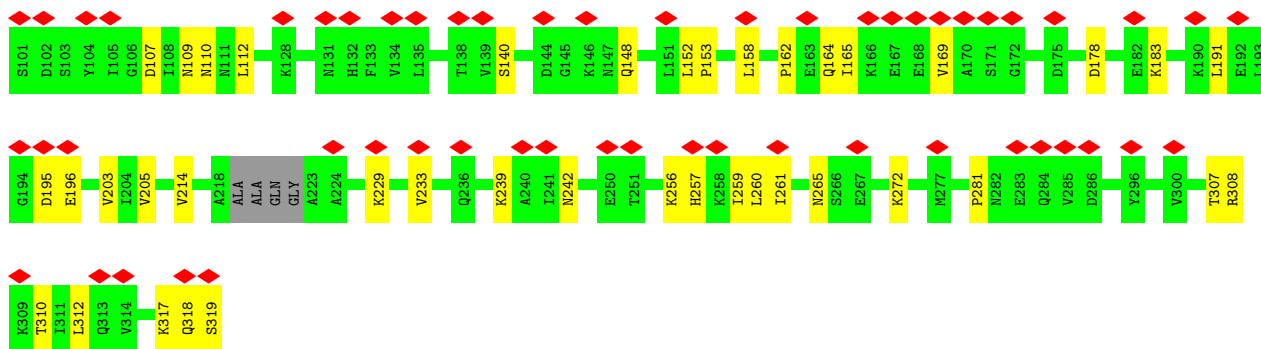

• Molecule 1: Major capsid protein

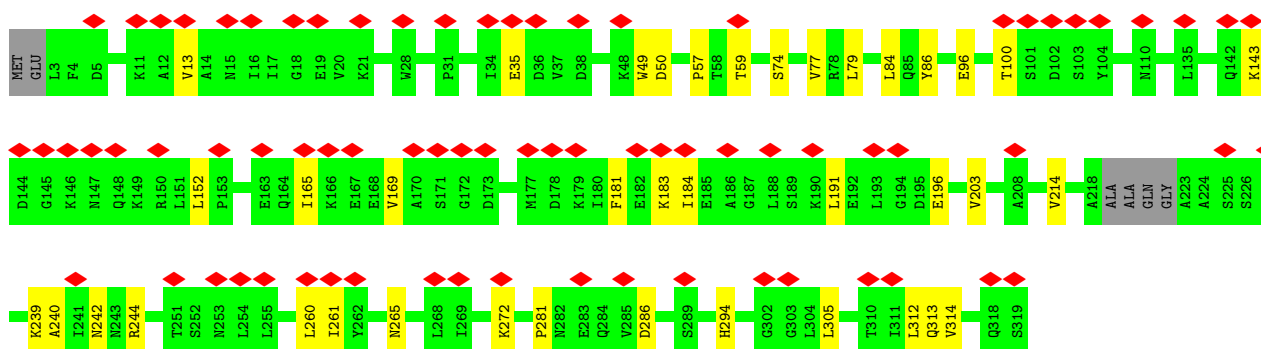
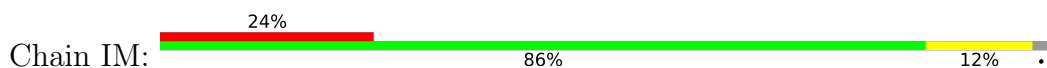

• Molecule 1: Major capsid protein

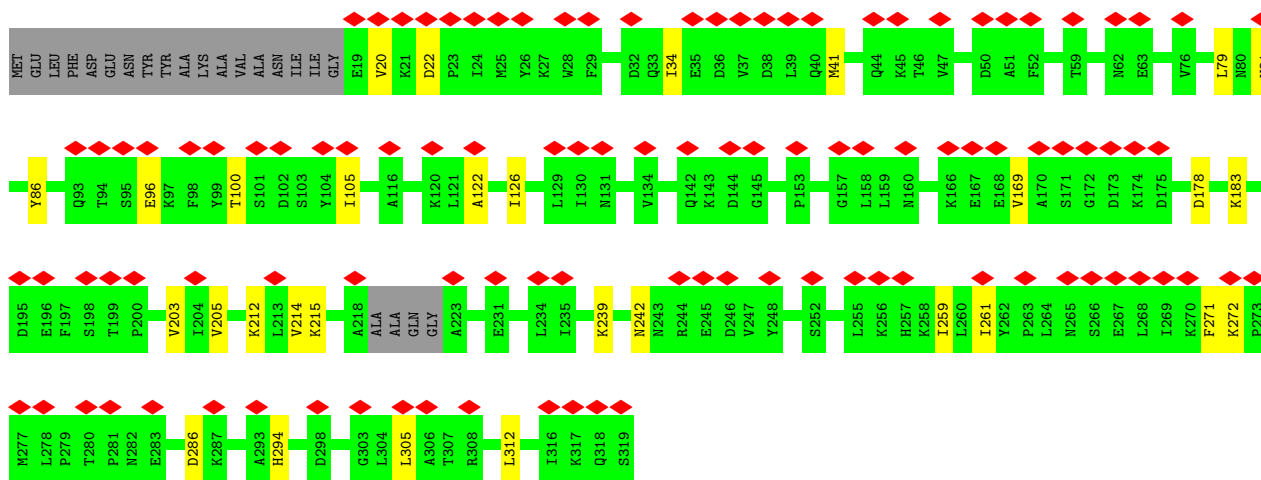
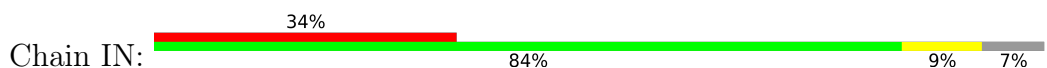

• Molecule 1: Major capsid protein

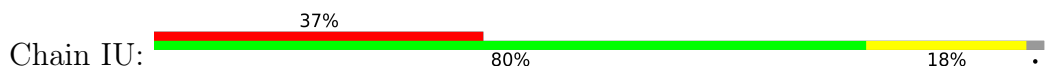

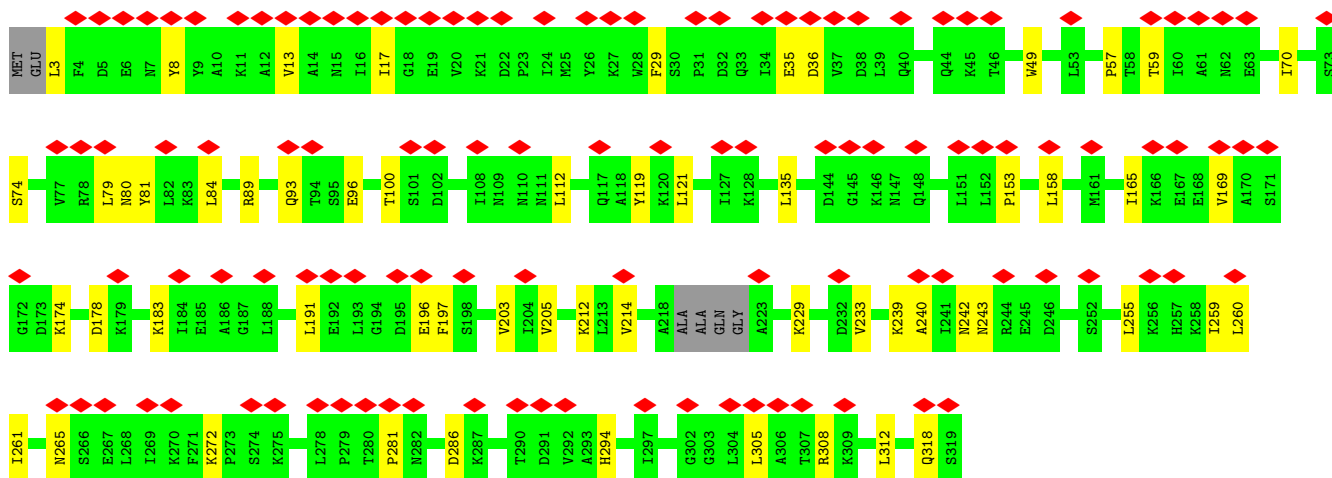

• Molecule 1: Major capsid protein

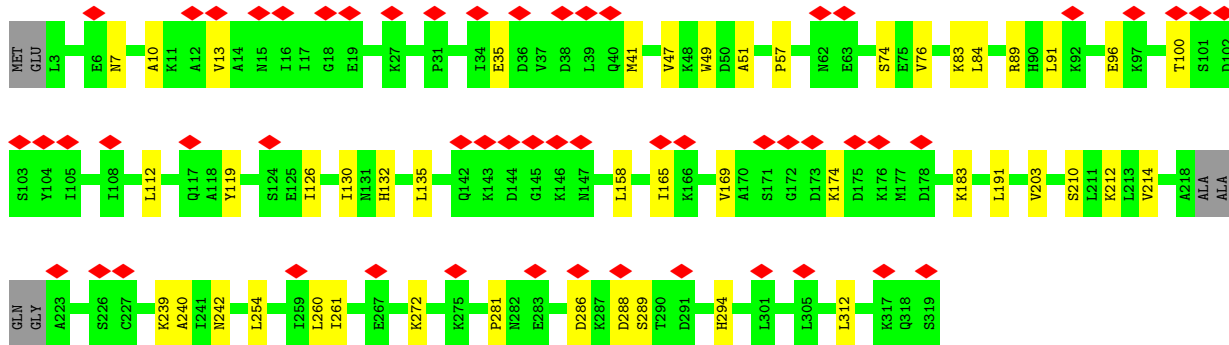
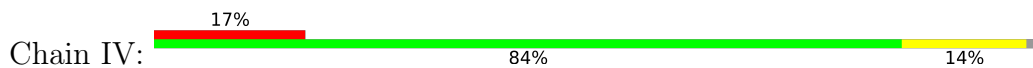

• Molecule 1: Major capsid protein

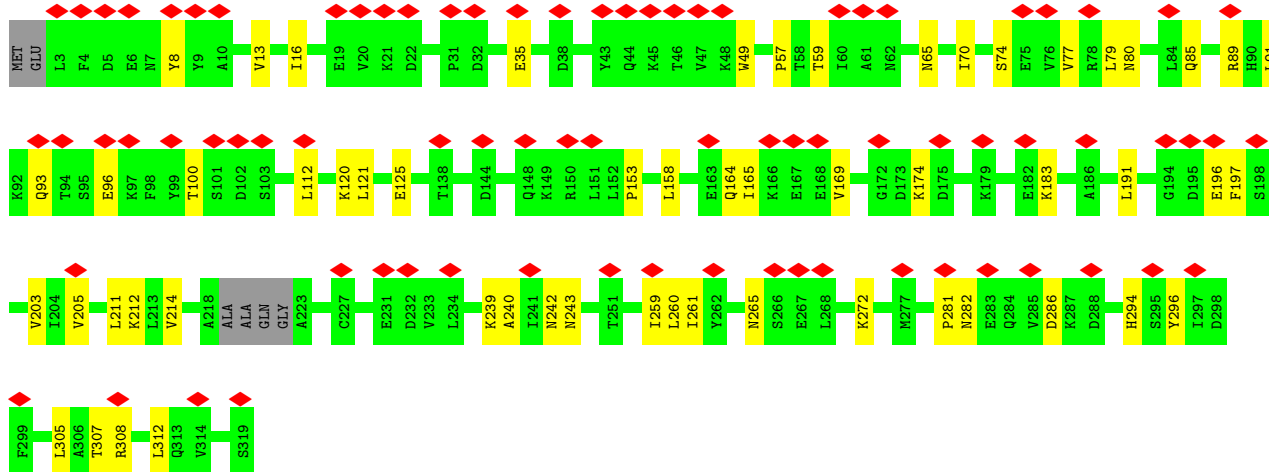
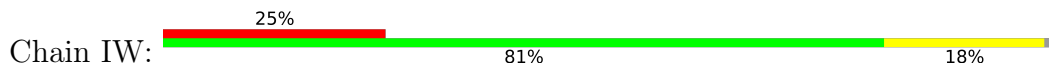

• Molecule 1: Major capsid protein

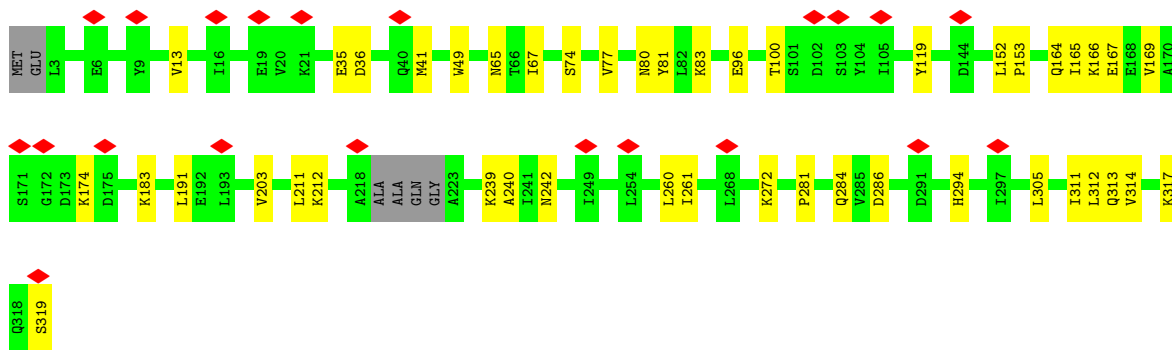
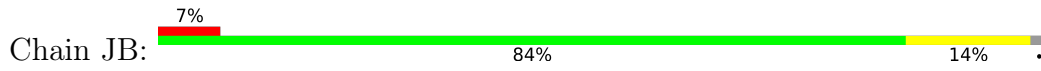

• Molecule 1: Major capsid protein

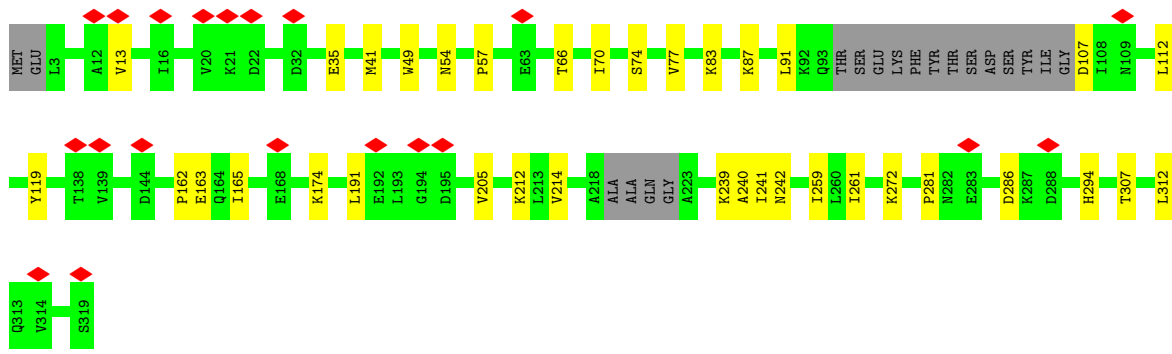
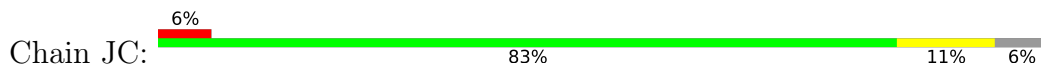

• Molecule 1: Major capsid protein

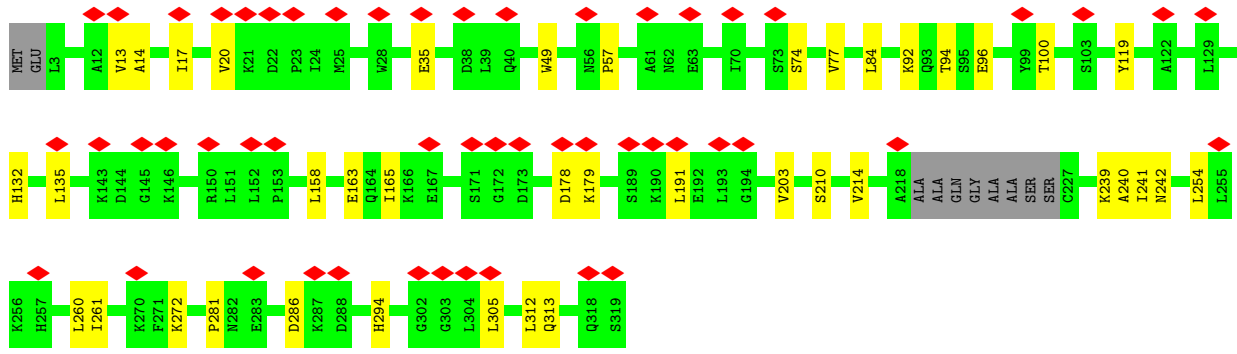
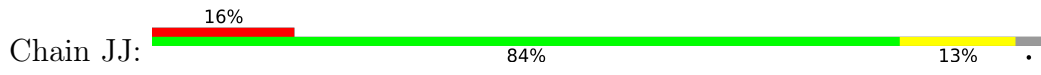

• Molecule 1: Major capsid protein

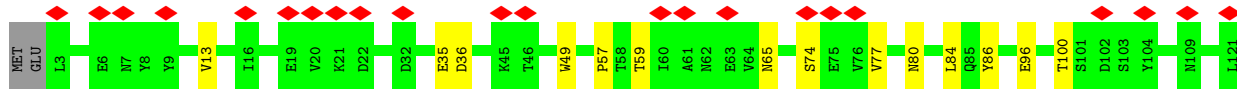
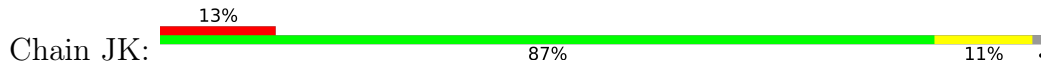

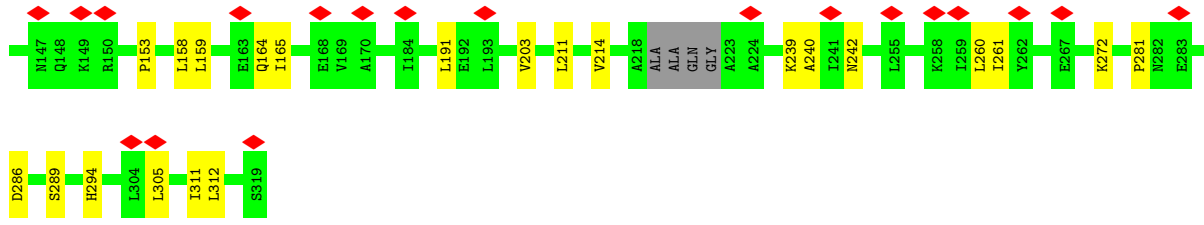

• Molecule 1: Major capsid protein

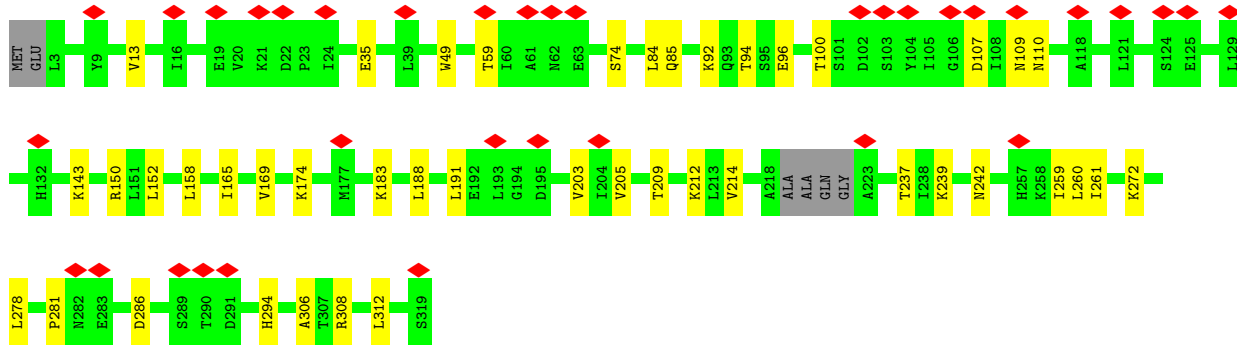
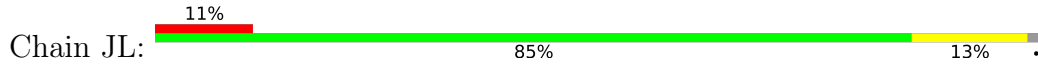

• Molecule 1: Major capsid protein

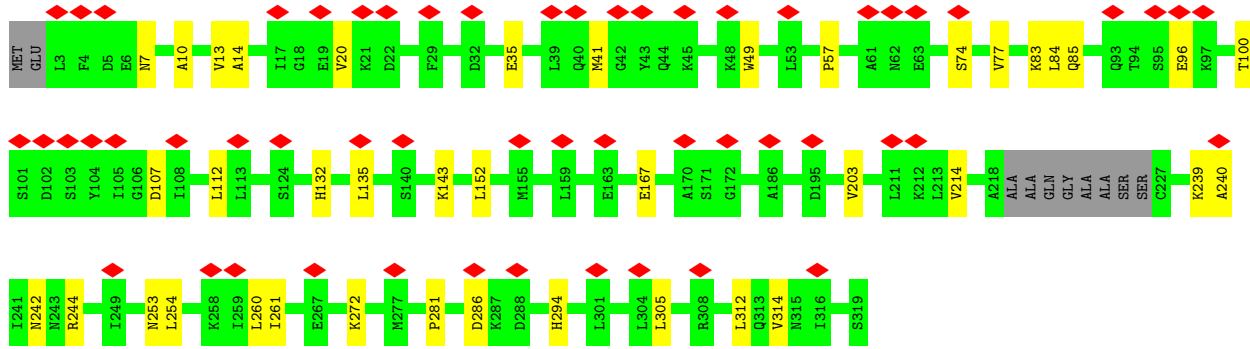
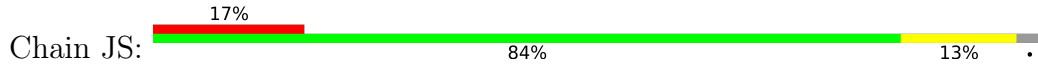

• Molecule 1: Major capsid protein

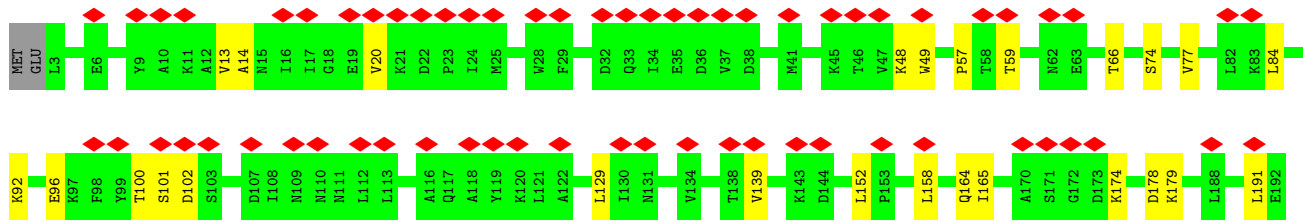
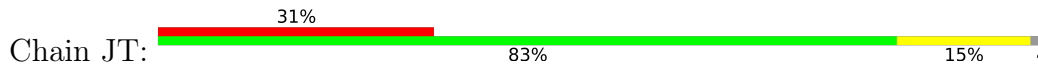

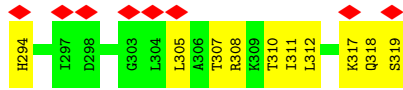
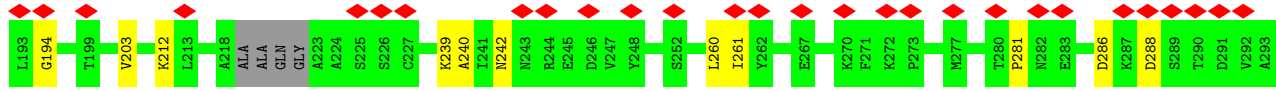

• Molecule 1: Major capsid protein

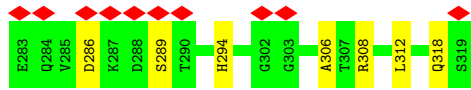
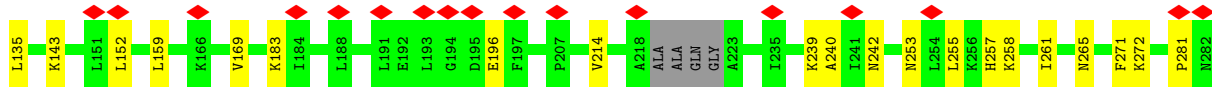
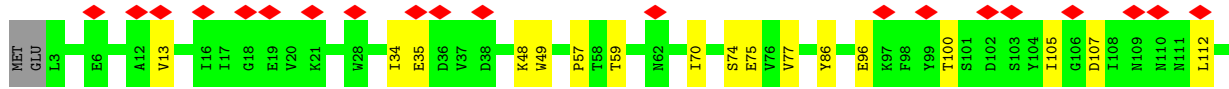
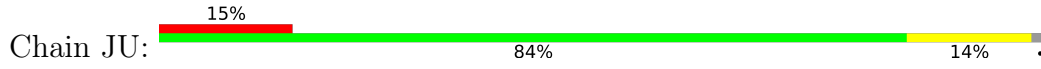

• Molecule 1: Major capsid protein

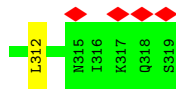
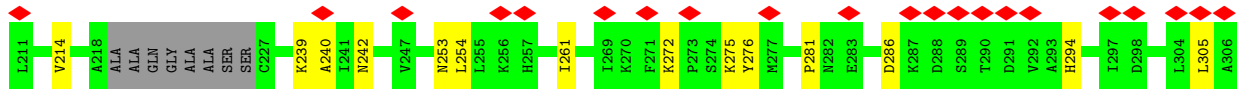
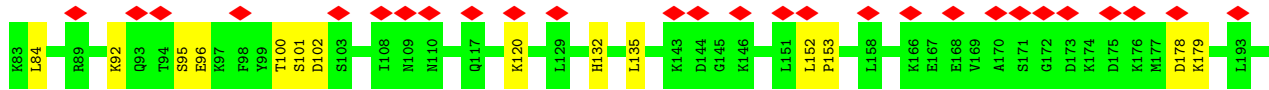
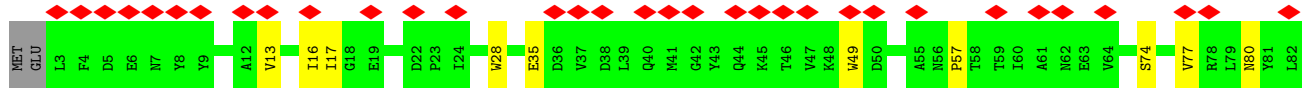
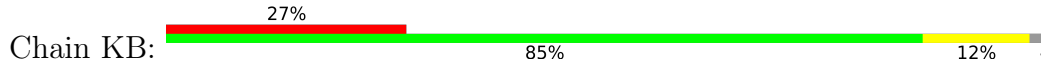

• Molecule 1: Major capsid protein

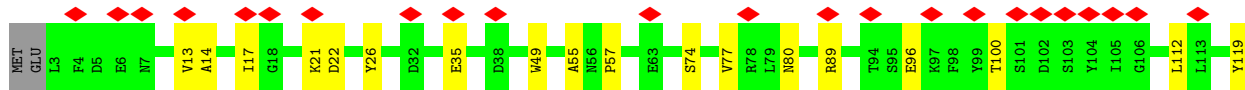
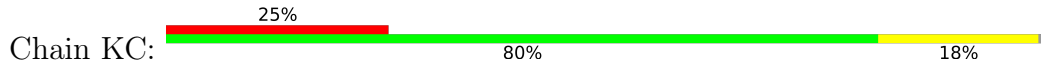

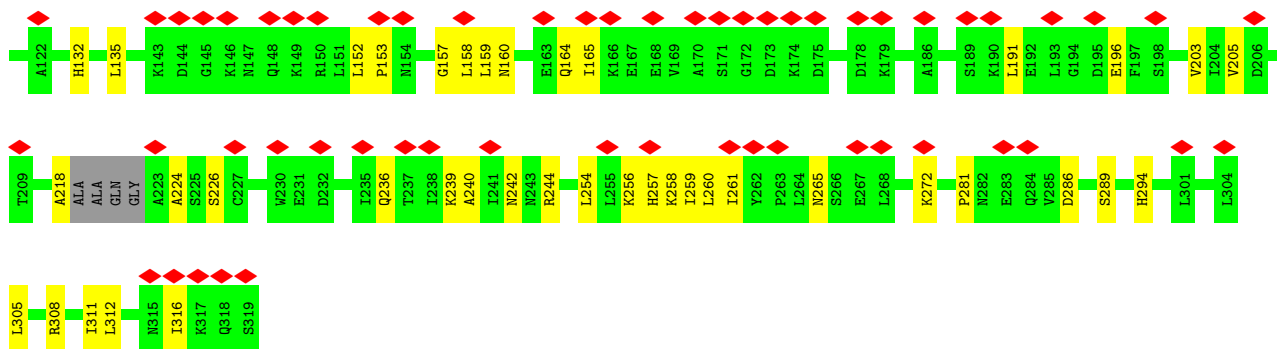

• Molecule 1: Major capsid protein

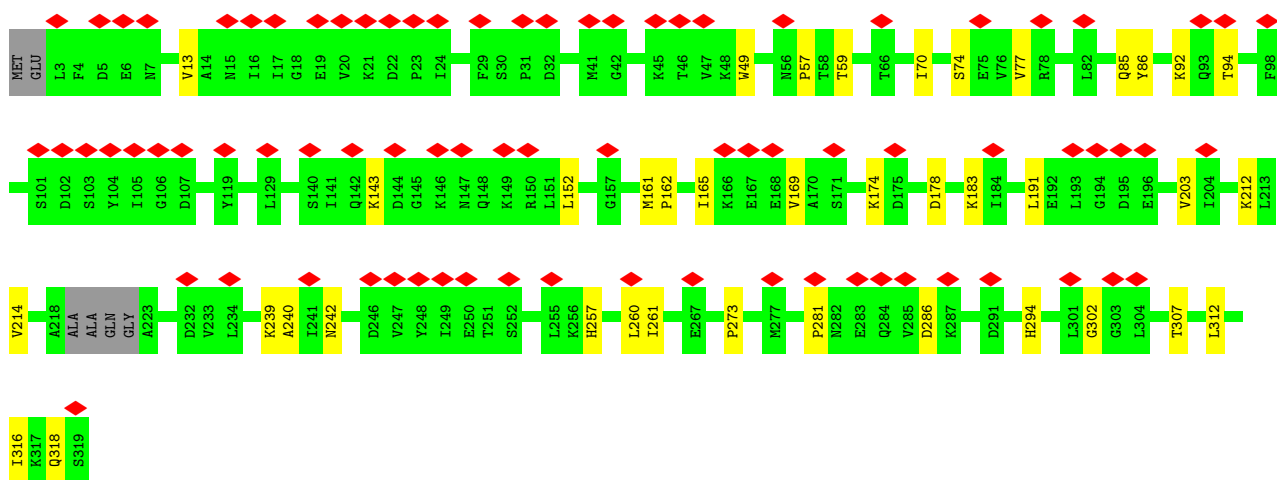
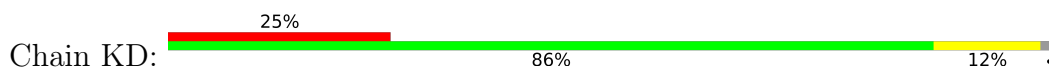

• Molecule 1: Major capsid protein

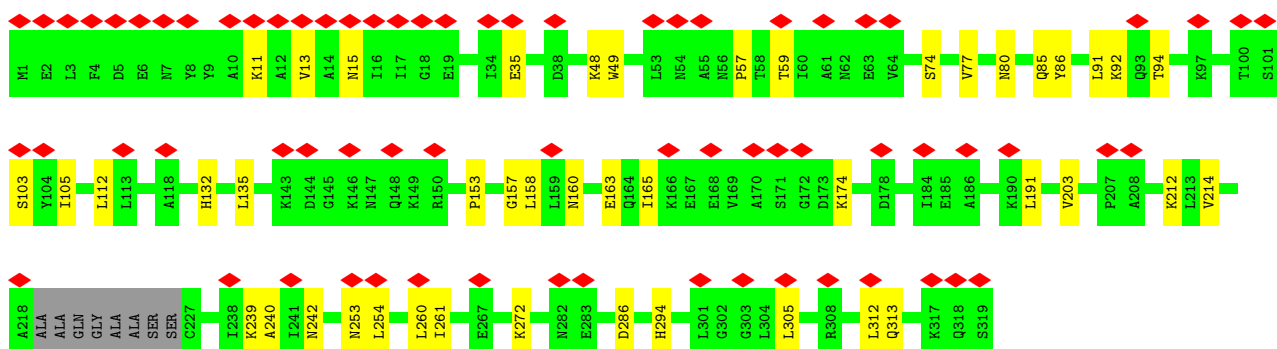
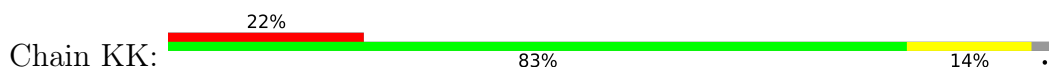

• Molecule 1: Major capsid protein

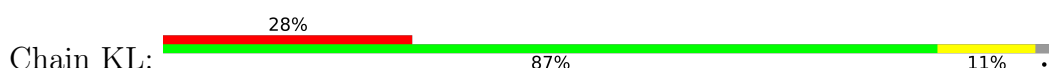

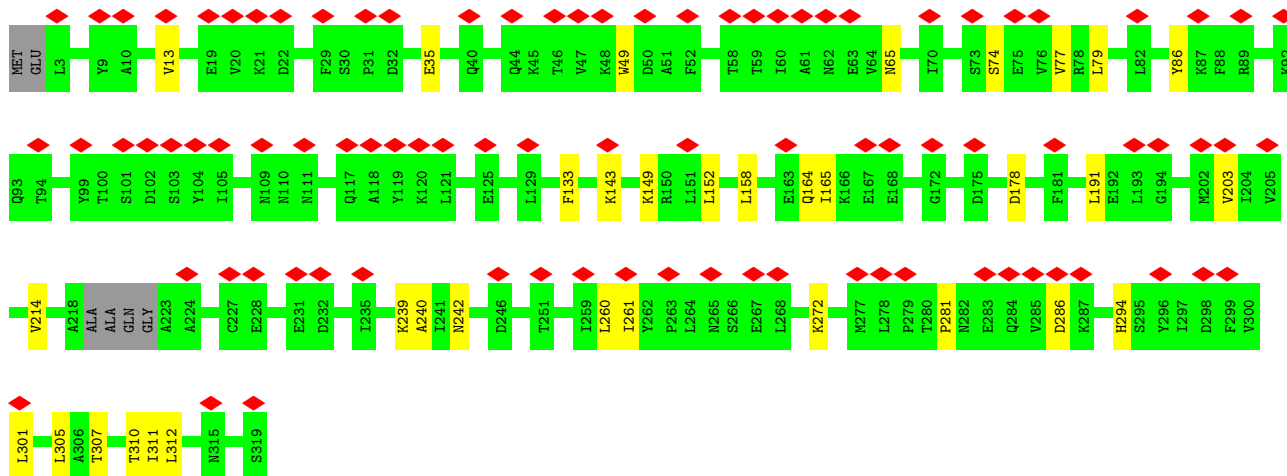

• Molecule 1: Major capsid protein

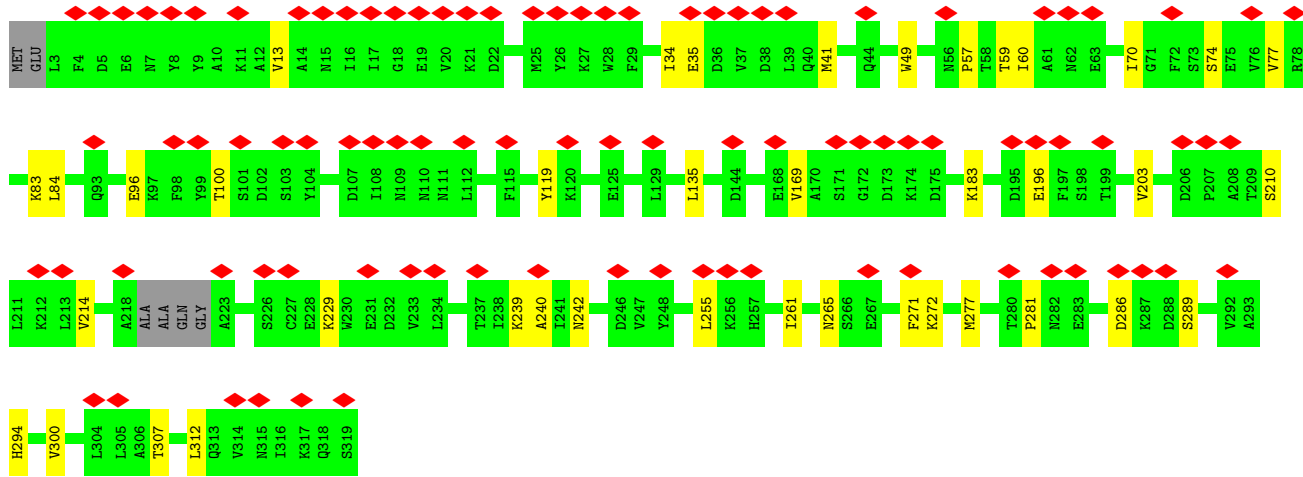
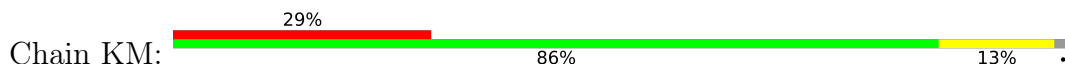

• Molecule 1: Major capsid protein

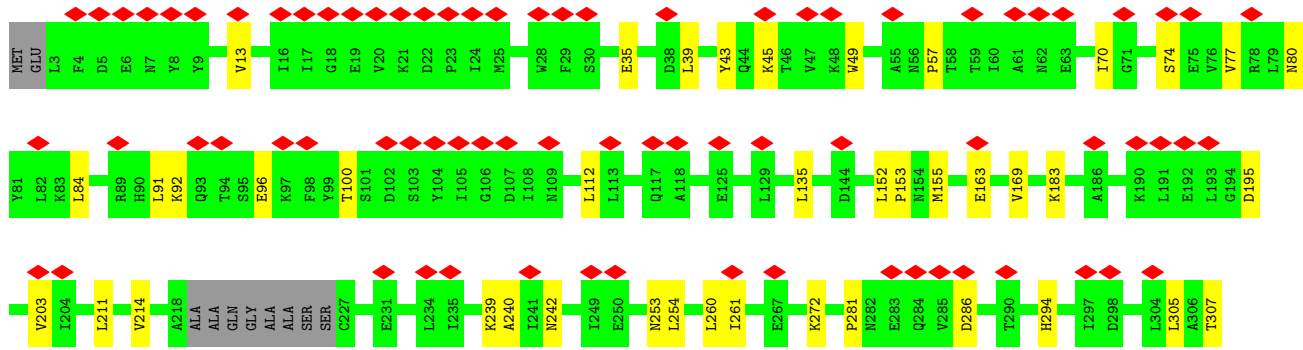
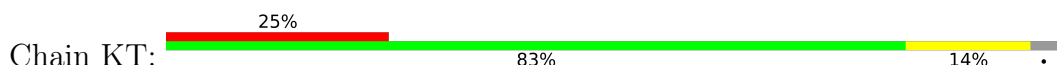

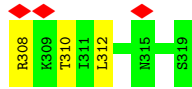

• Molecule 1: Major capsid protein

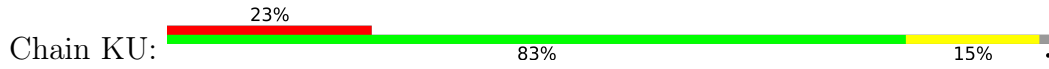

Chain KU:

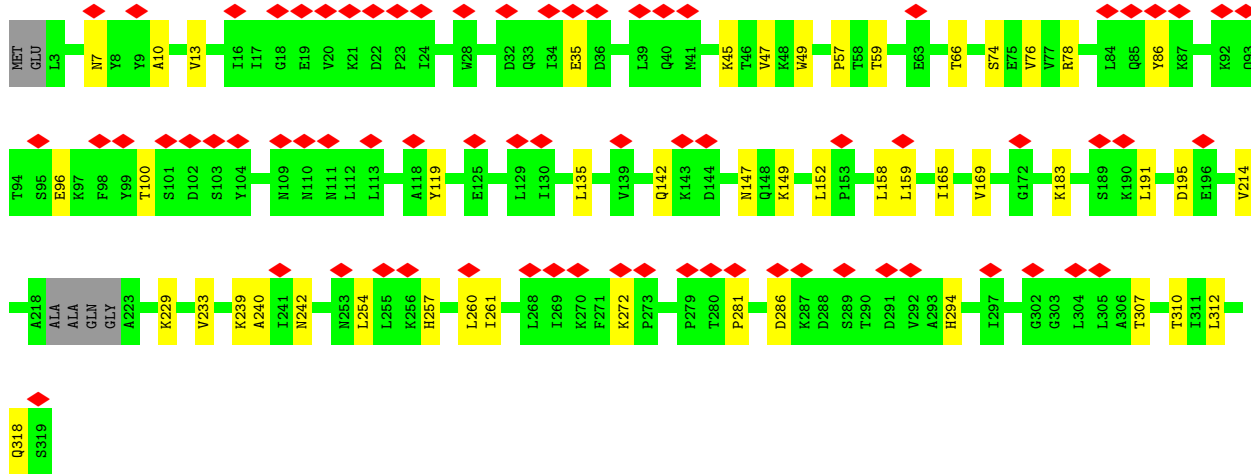

• Molecule 1: Major capsid protein

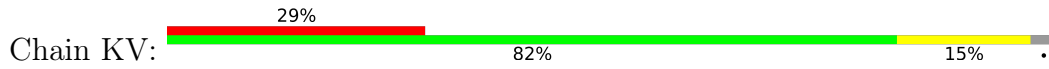

Chain KV:

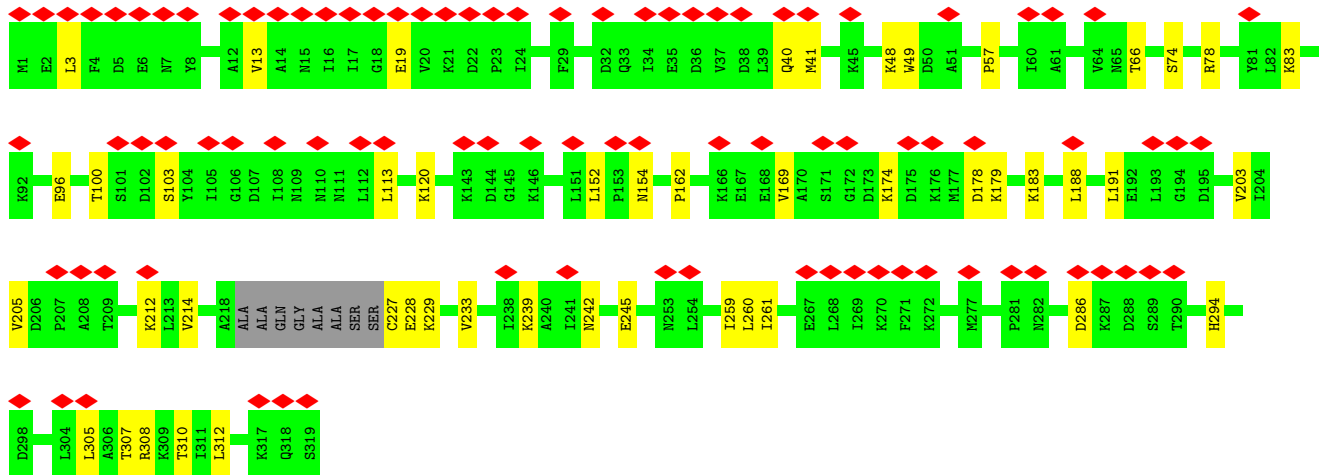

• Molecule 1: Major capsid protein

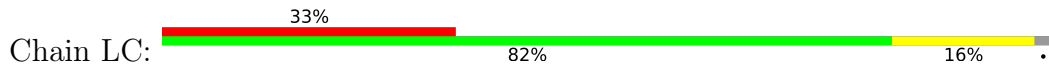

Chain LC:

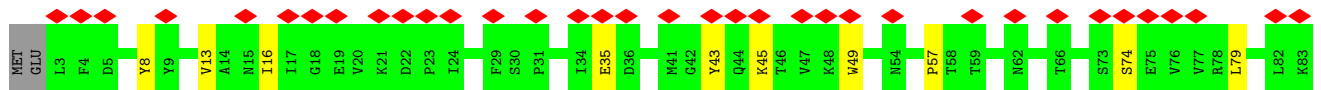

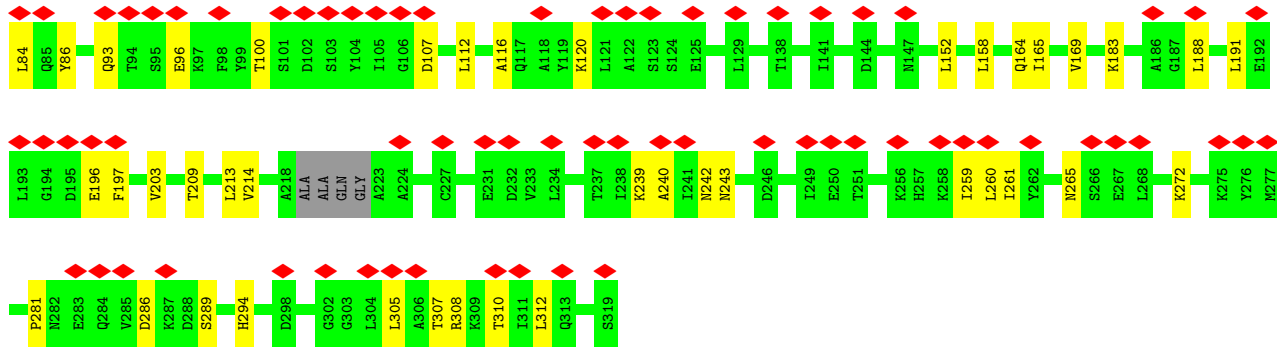

• Molecule 1: Major capsid protein

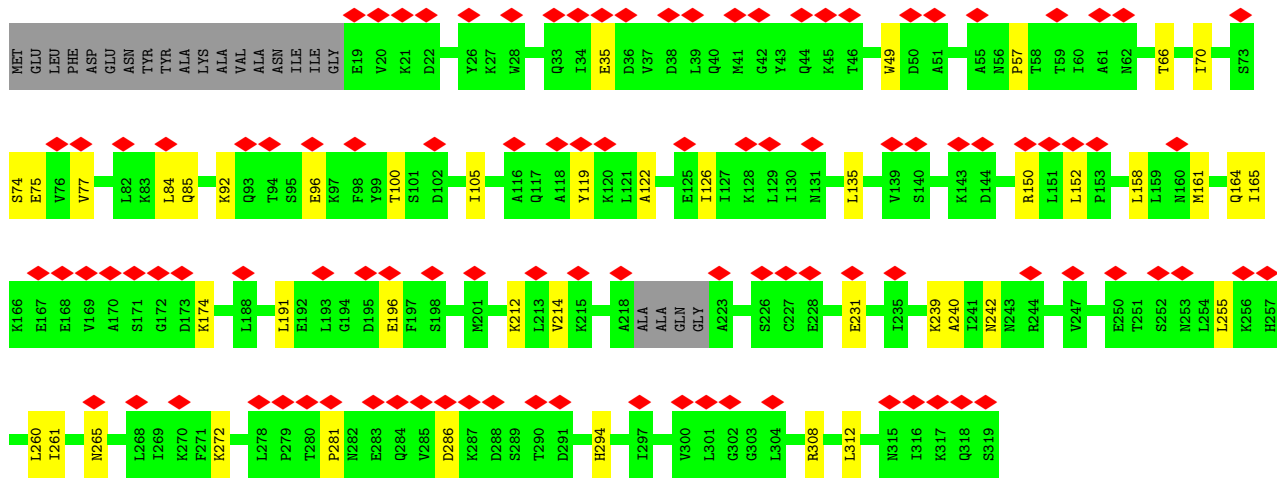
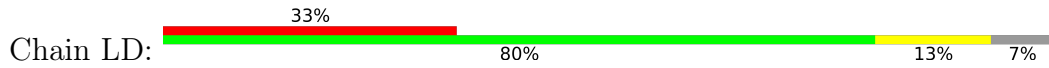

• Molecule 1: Major capsid protein

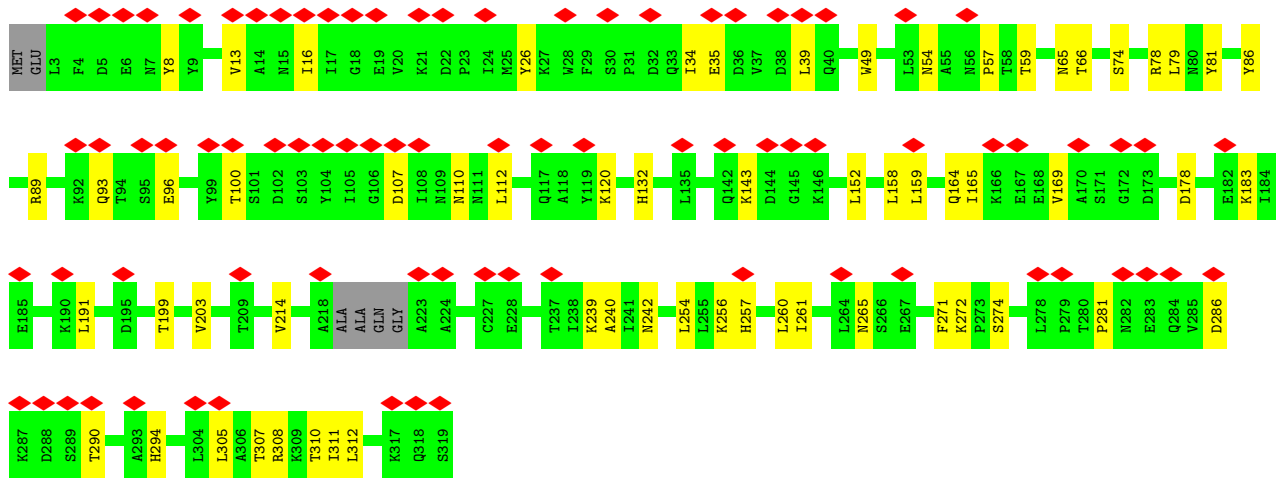
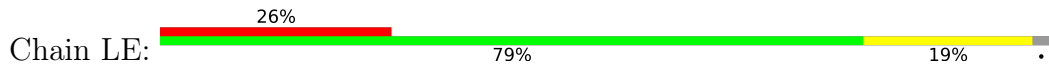

• Molecule 1: Major capsid protein

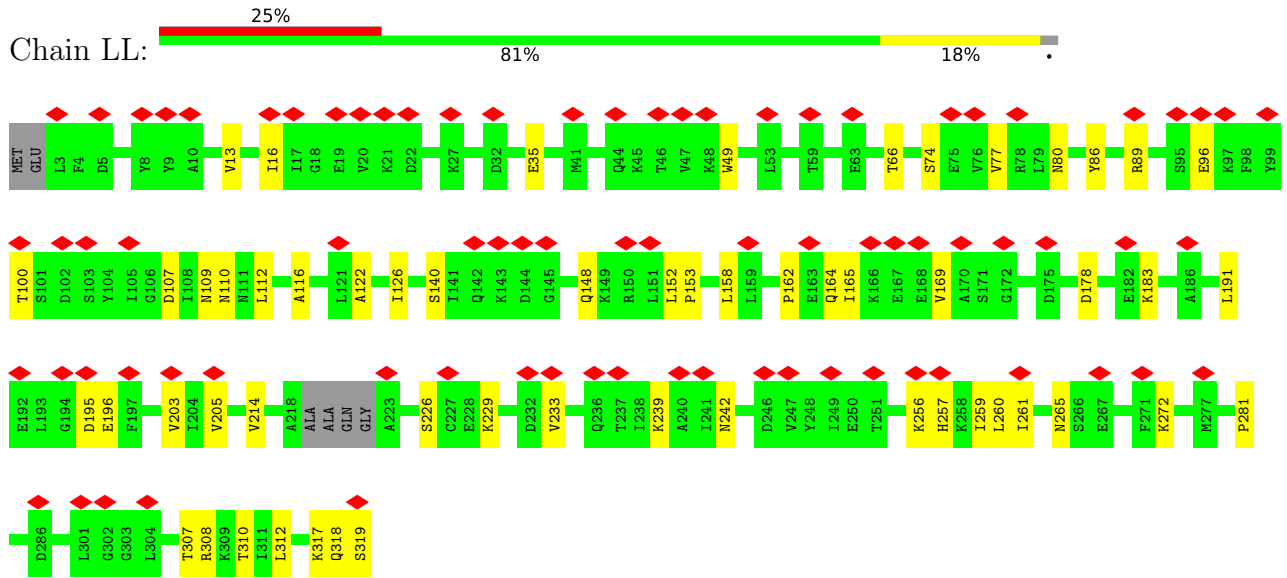

• Molecule 1: Major capsid protein

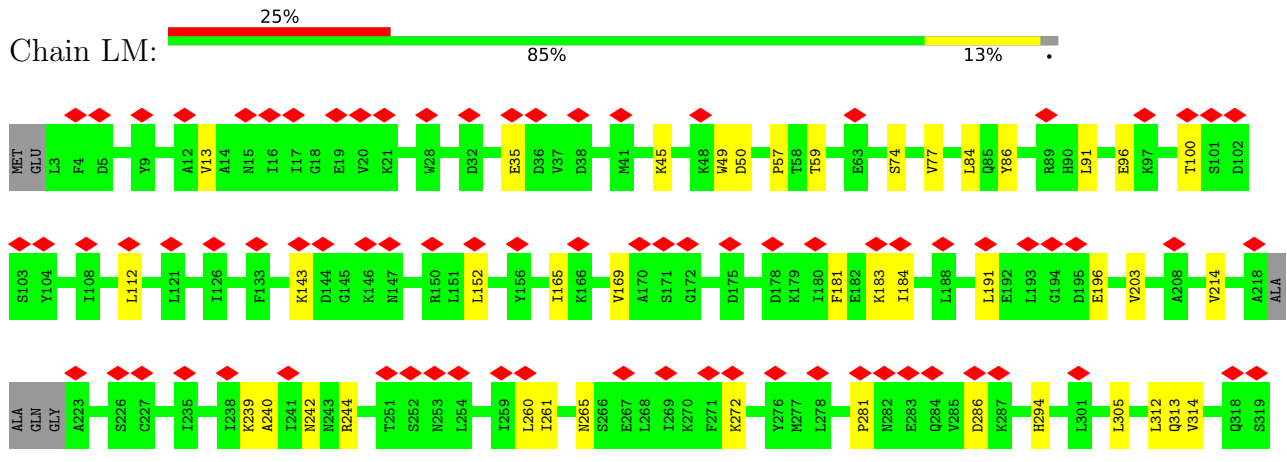

• Molecule 1: Major capsid protein

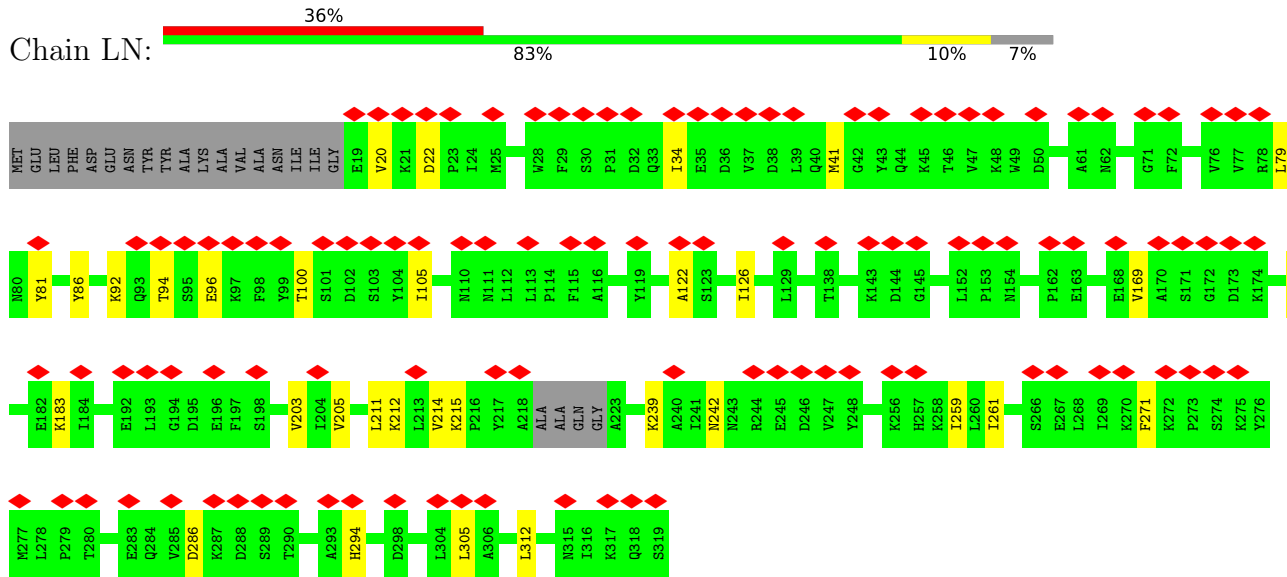

• Molecule 1: Major capsid protein

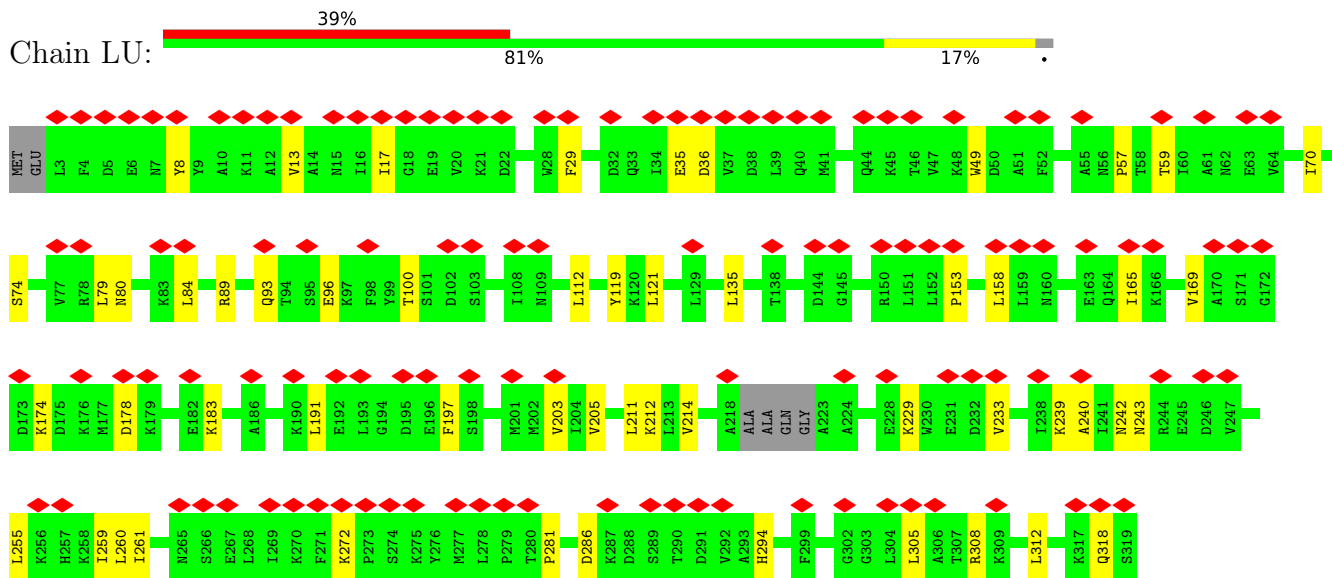

• Molecule 1: Major capsid protein

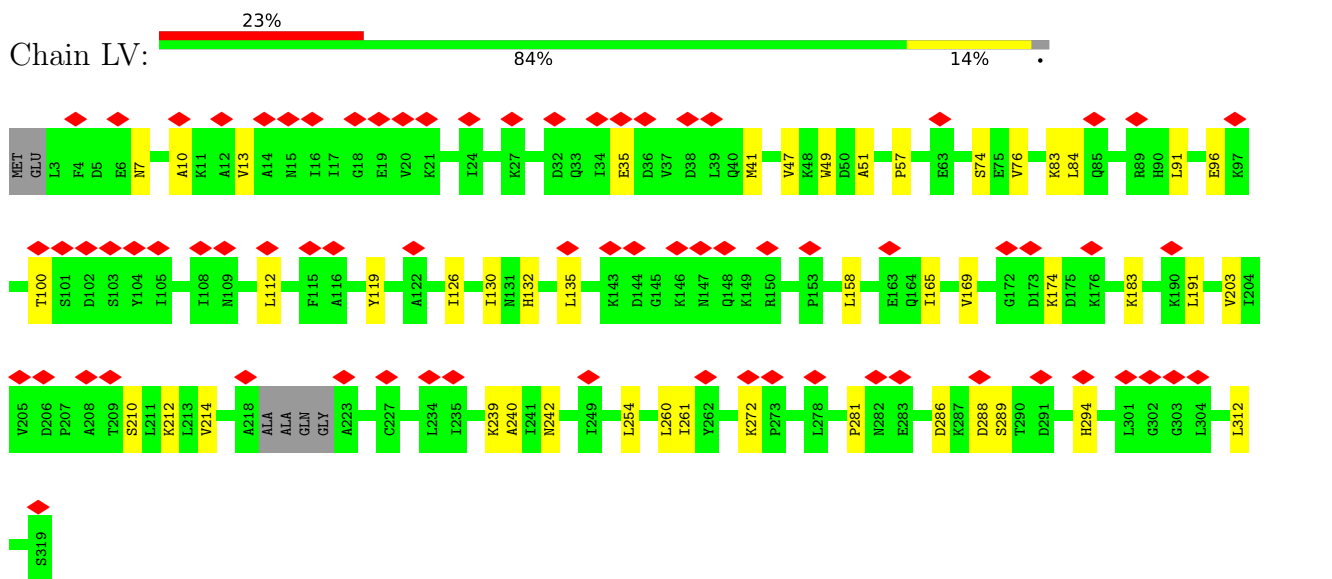

• Molecule 1: Major capsid protein

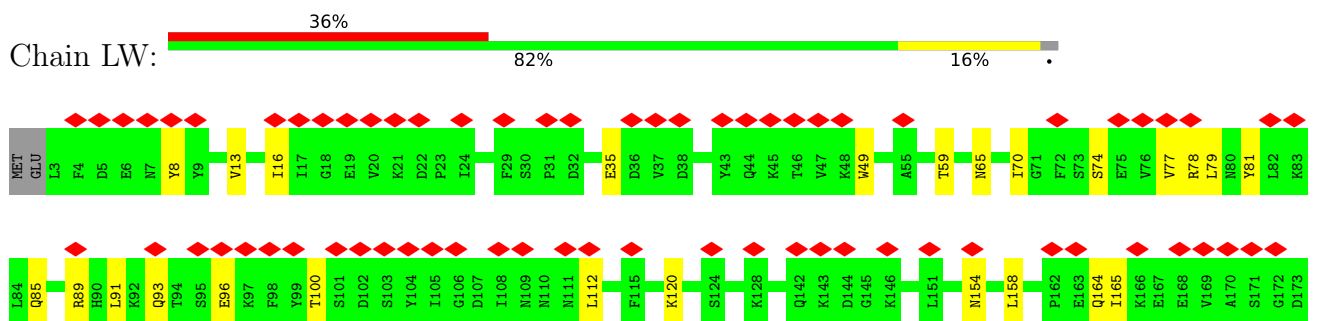

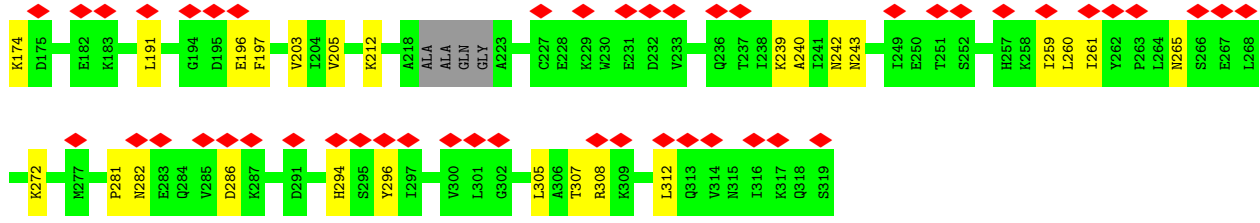

• Molecule 1: Major capsid protein

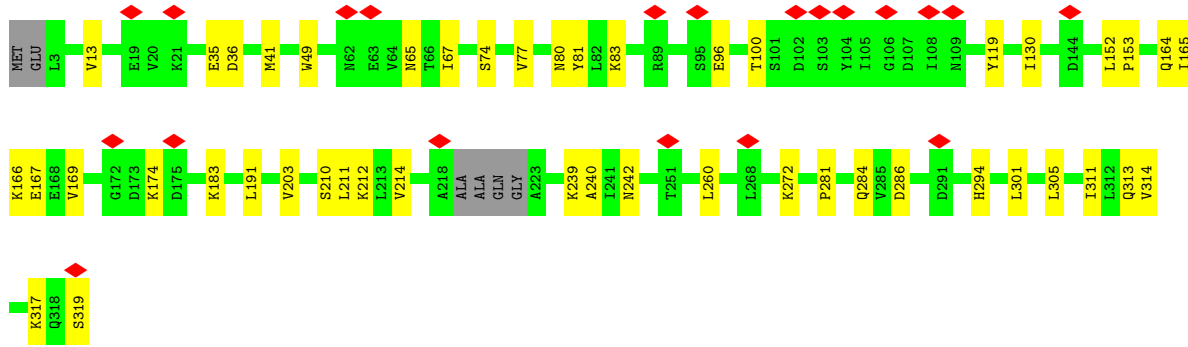
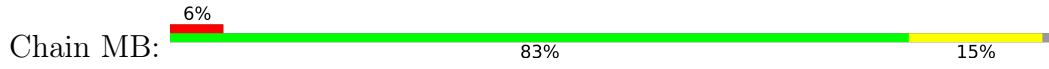

• Molecule 1: Major capsid protein

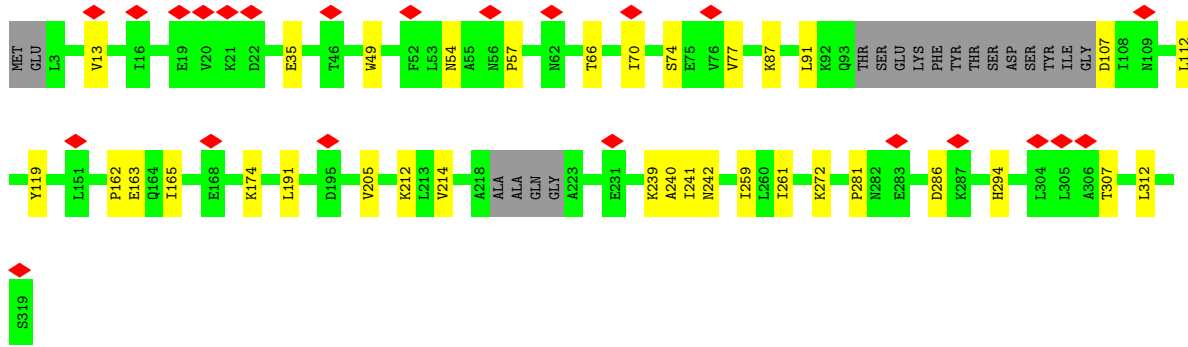
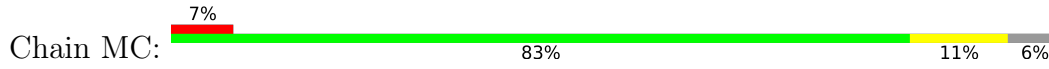

• Molecule 1: Major capsid protein

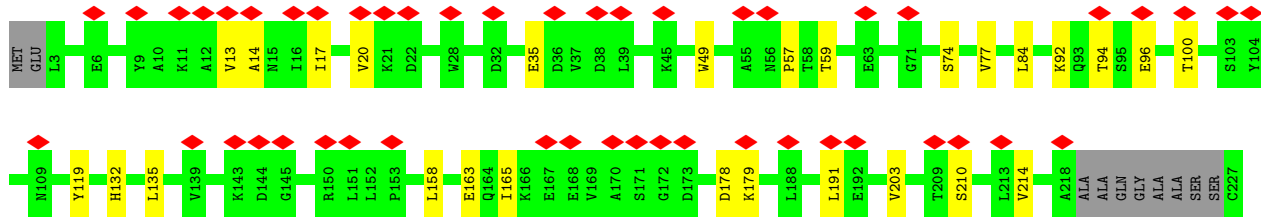
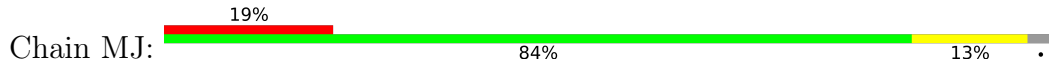

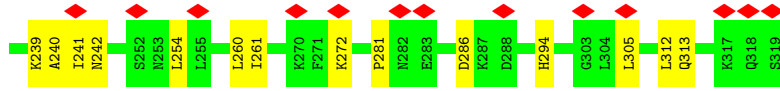

• Molecule 1: Major capsid protein

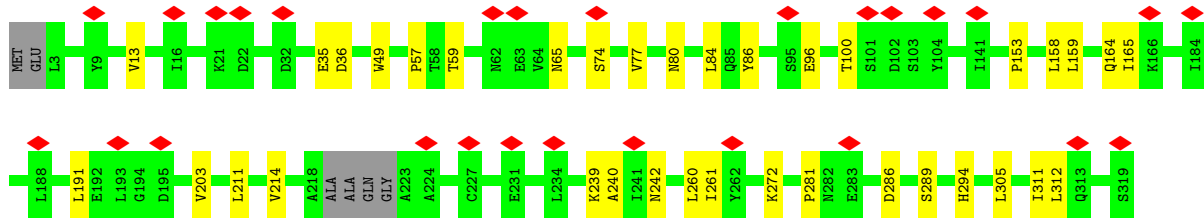
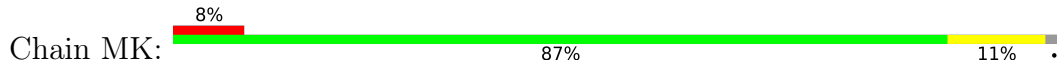

• Molecule 1: Major capsid protein

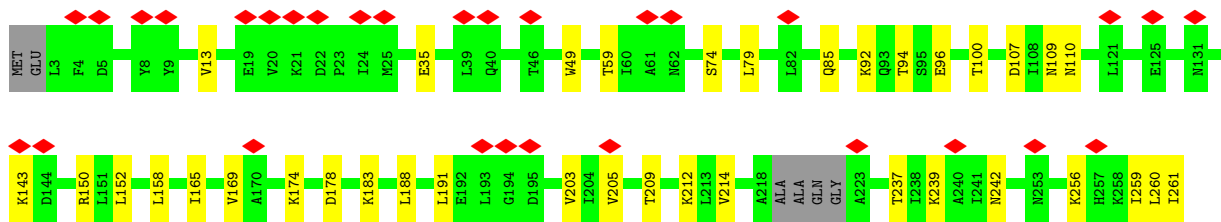
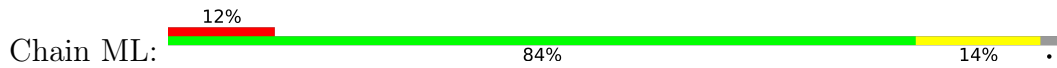

• Molecule 1: Major capsid protein

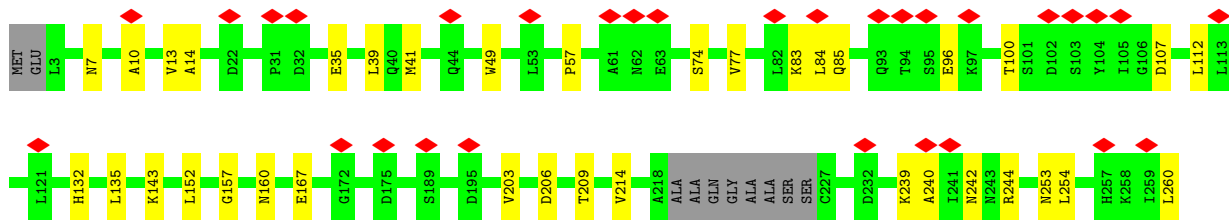
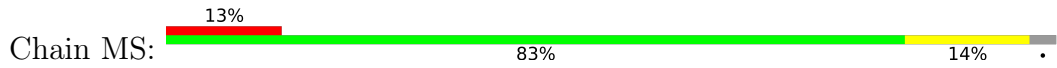

• Molecule 1: Major capsid protein

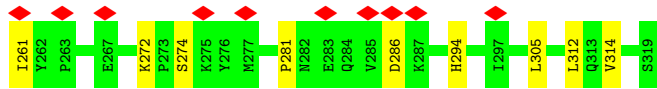
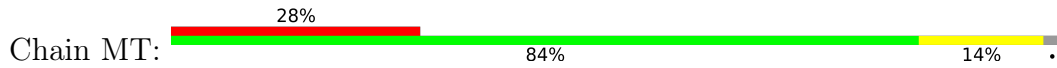

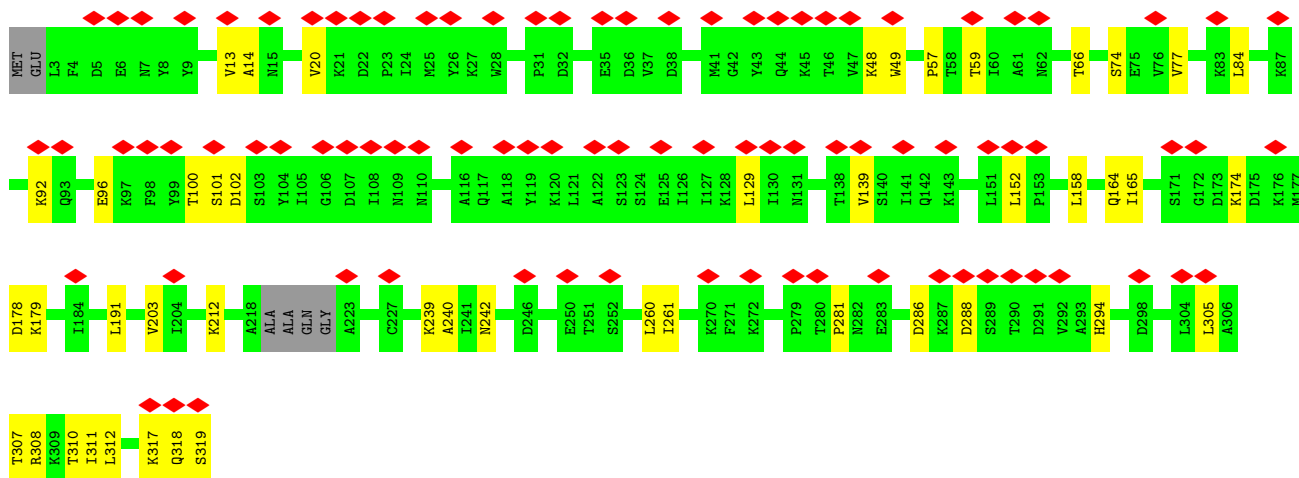

• Molecule 1: Major capsid protein

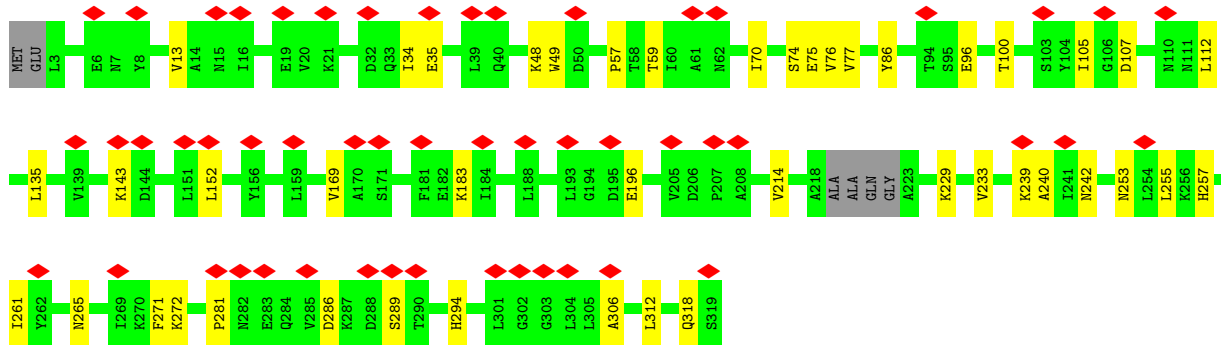
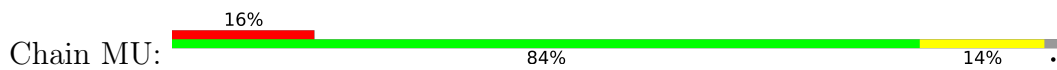

• Molecule 1: Major capsid protein

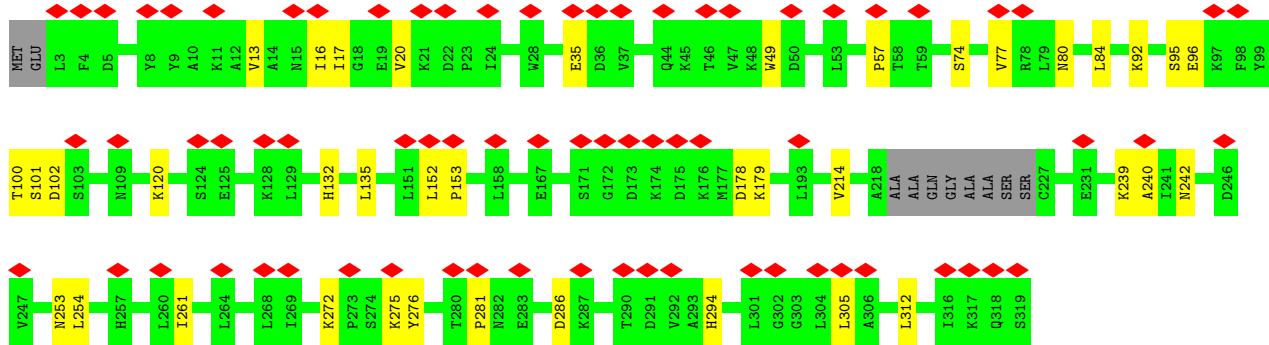
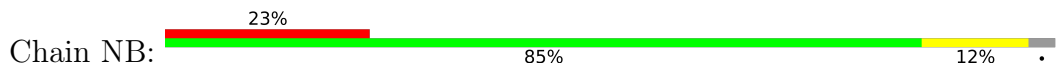

• Molecule 1: Major capsid protein

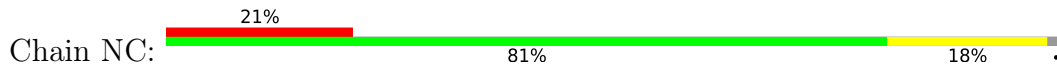

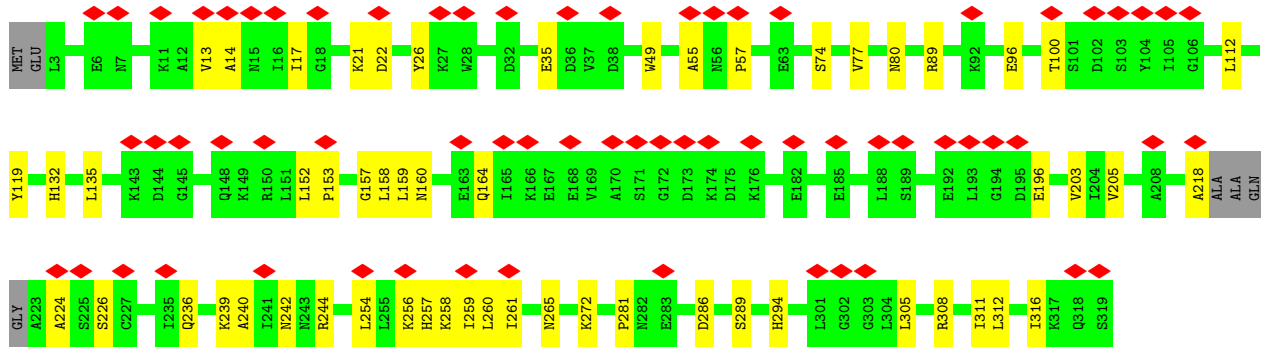

• Molecule 1: Major capsid protein

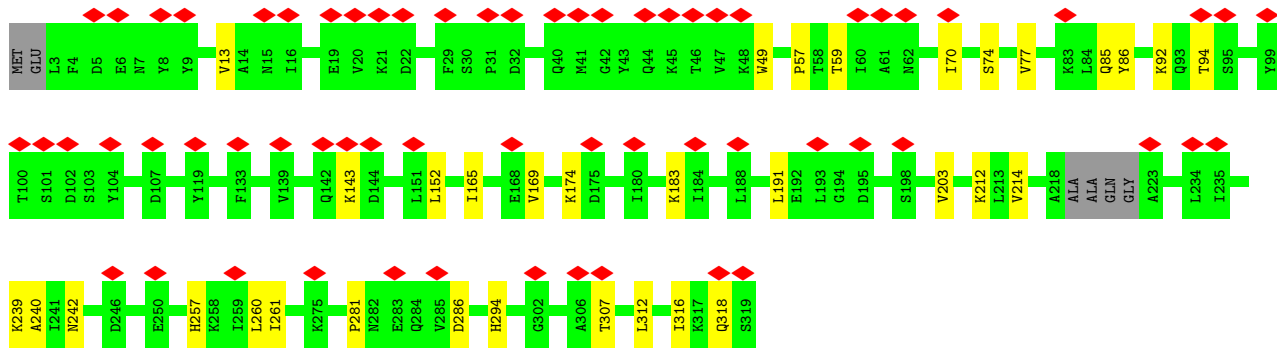

• Molecule 1: Major capsid protein

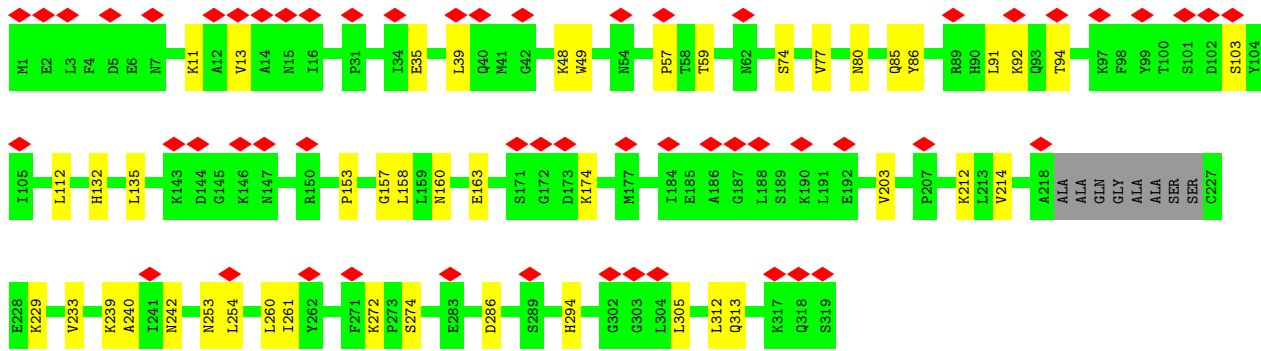
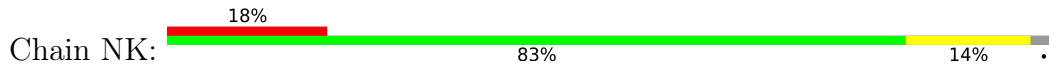

• Molecule 1: Major capsid protein

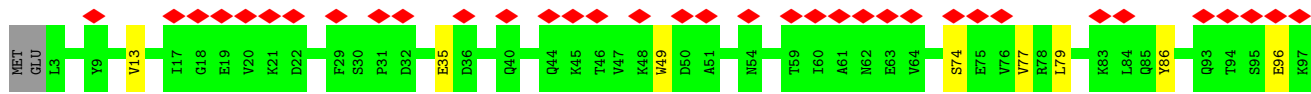
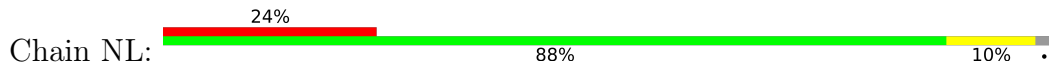

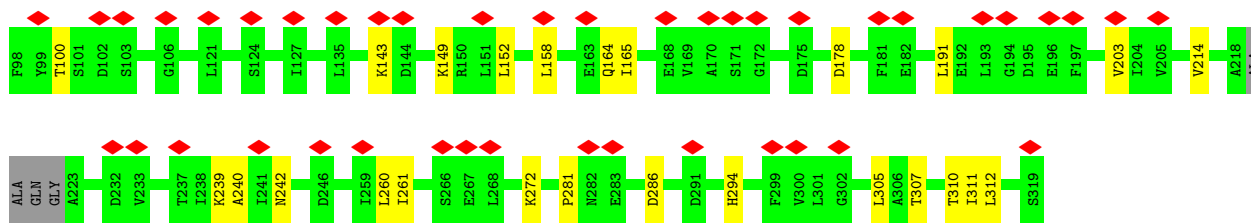

• Molecule 1: Major capsid protein

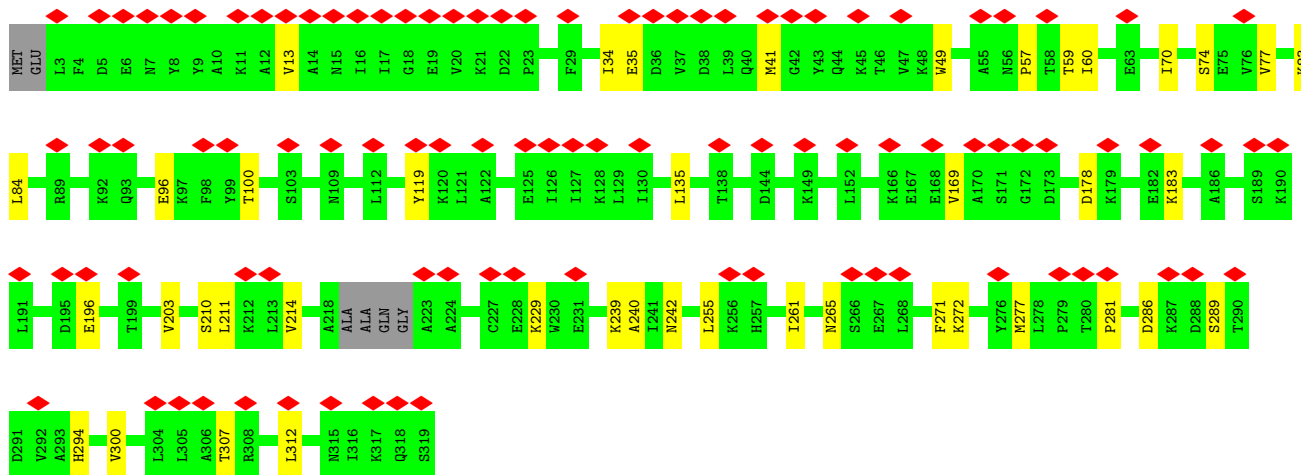
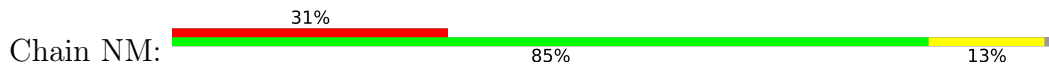

• Molecule 1: Major capsid protein

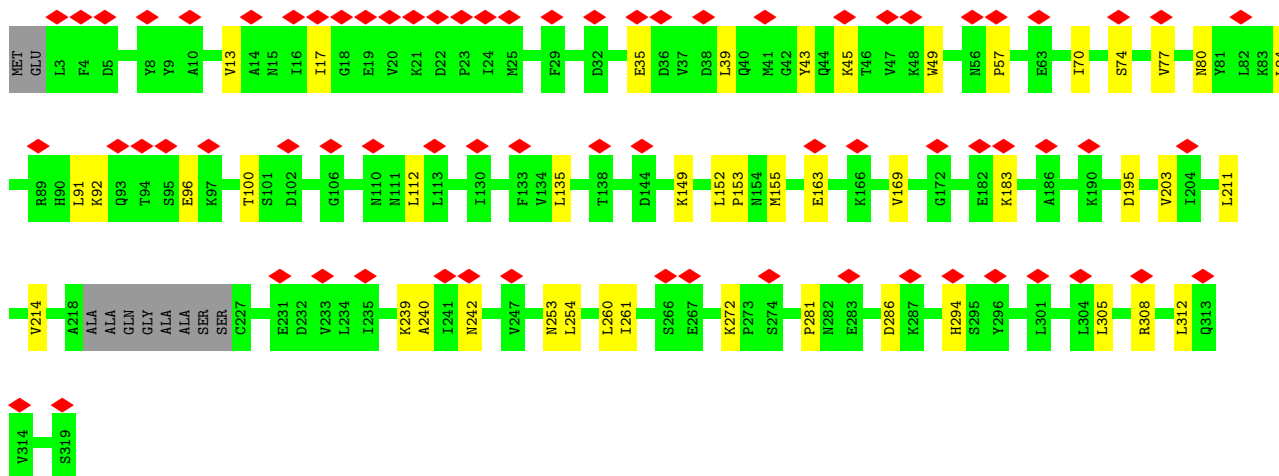
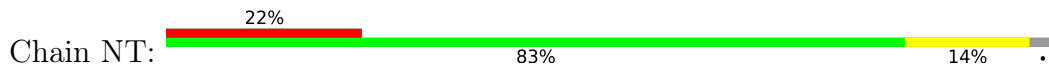

• Molecule 1: Major capsid protein

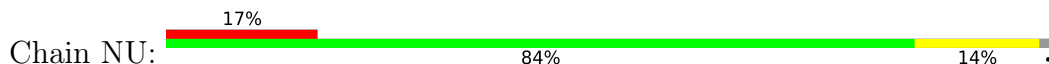

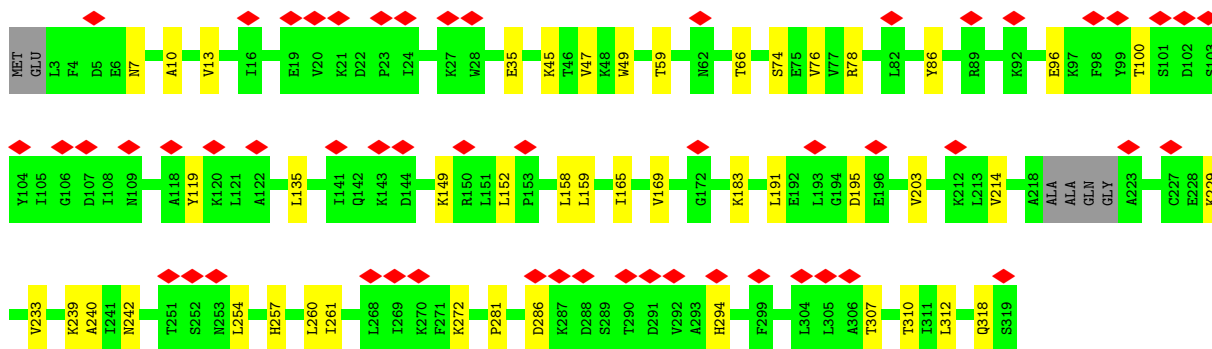

• Molecule 1: Major capsid protein

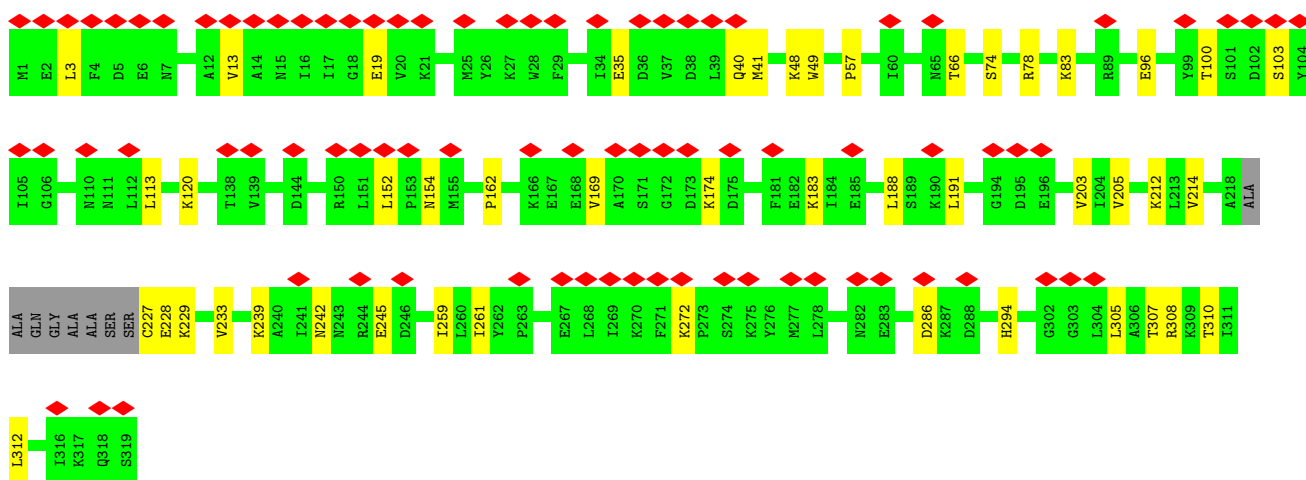
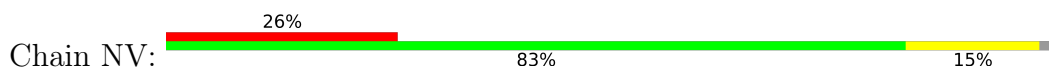

• Molecule 1: Major capsid protein

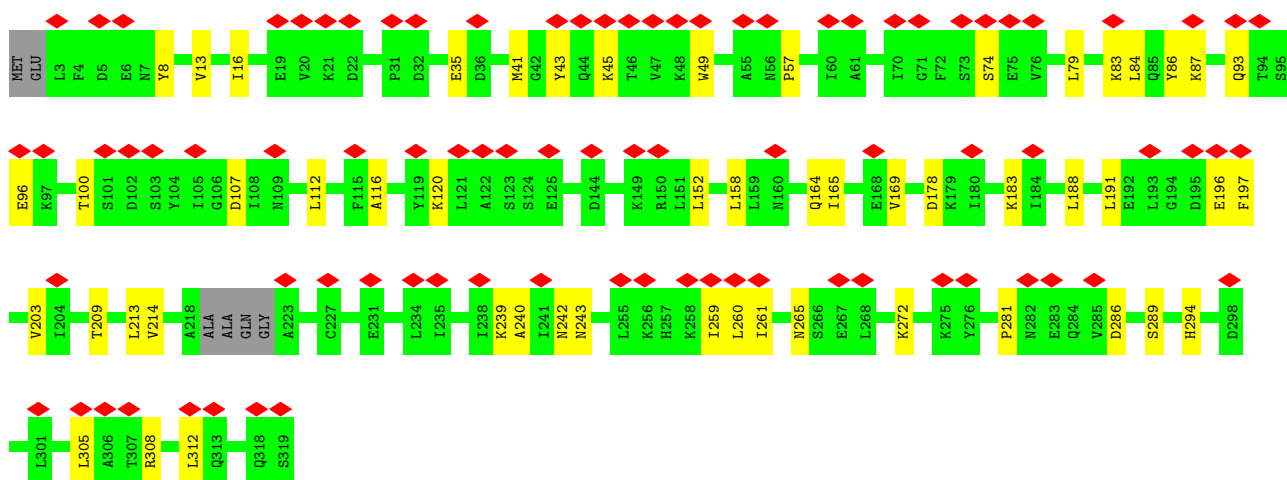
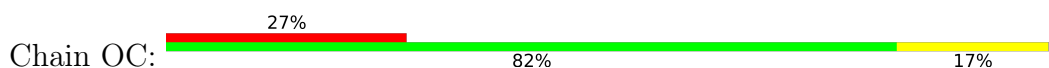

• Molecule 1: Major capsid protein

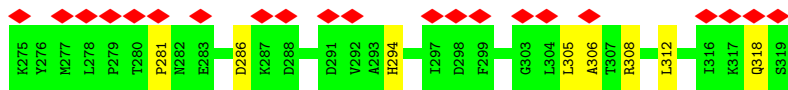

• Molecule 1: Major capsid protein

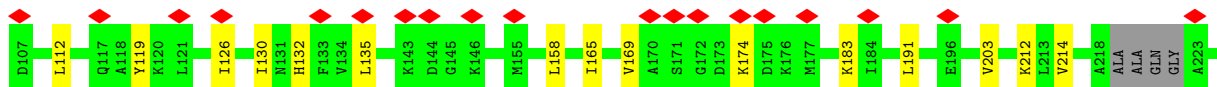
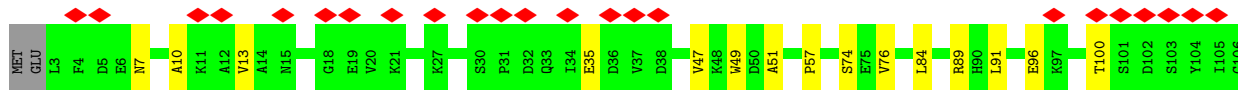
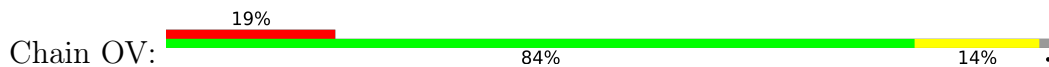

• Molecule 1: Major capsid protein

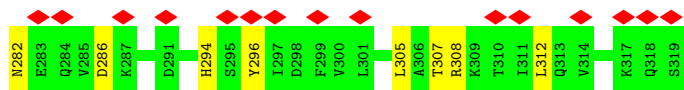
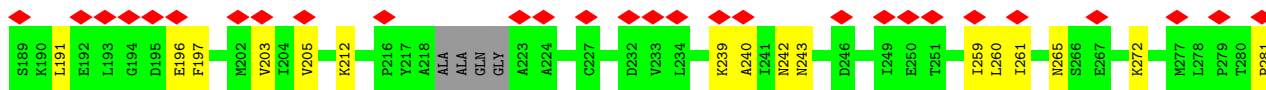
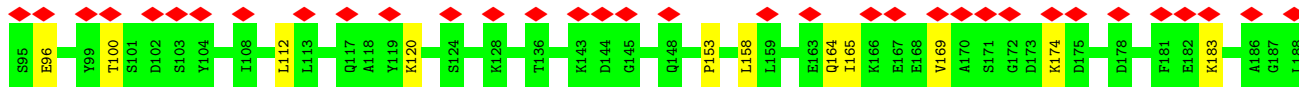
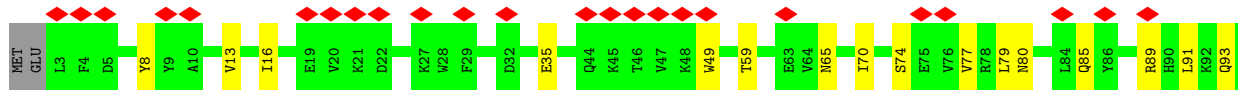
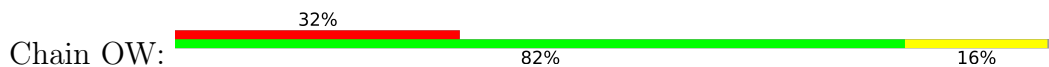

• Molecule 2: Decorator protein P03

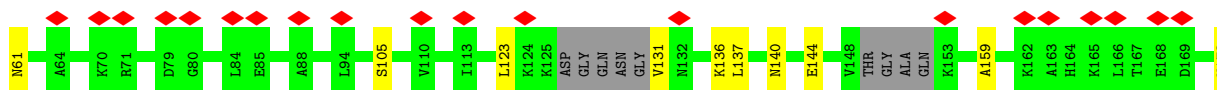
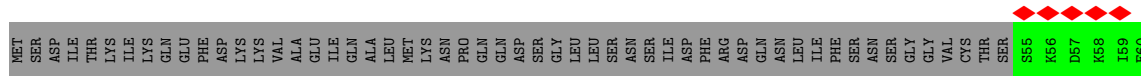

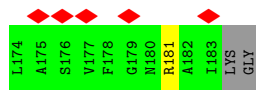

• Molecule 2: Decorator protein P03

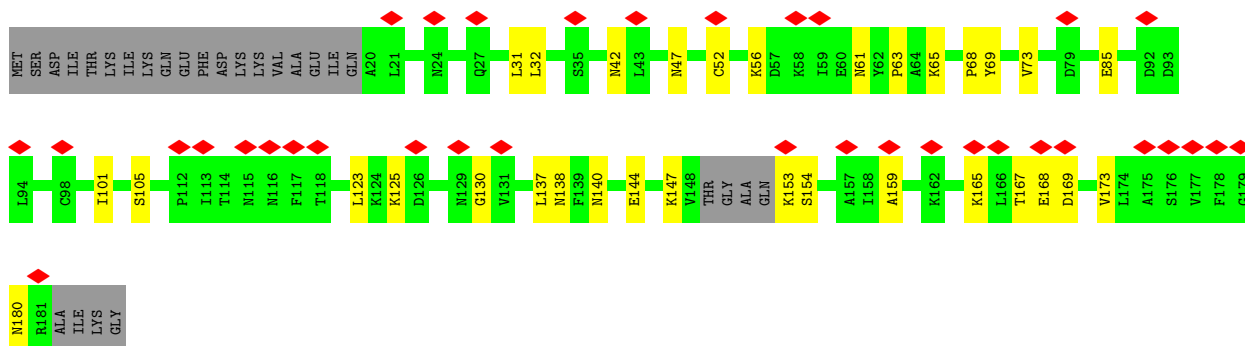

• Molecule 2: Decorator protein P03

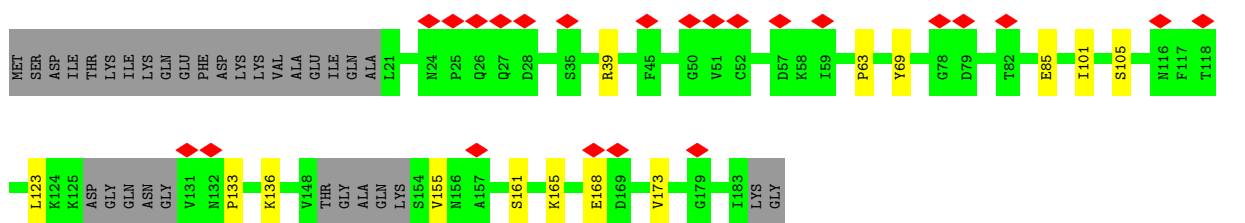
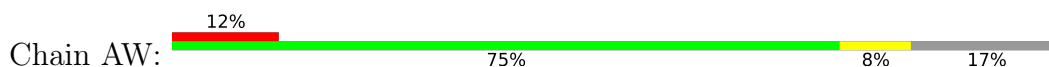

• Molecule 2: Decorator protein P03

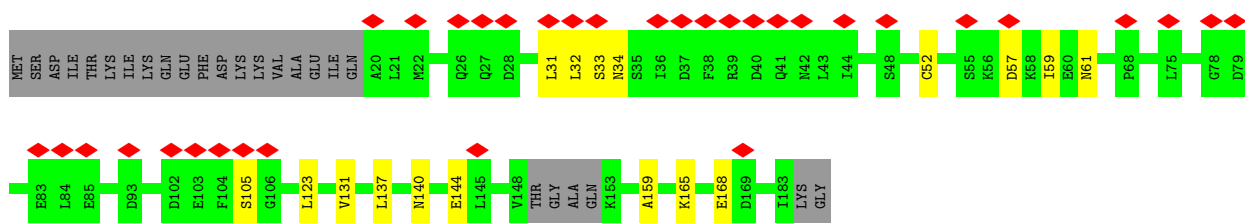
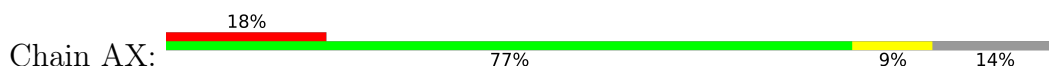

• Molecule 2: Decorator protein P03

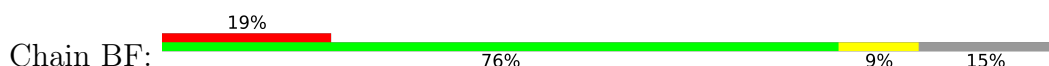



• Molecule 2: Decorator protein P03

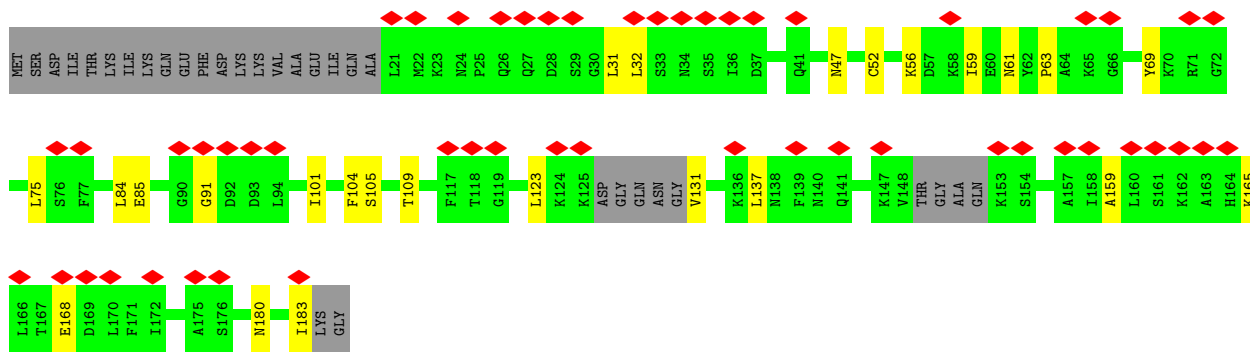

• Molecule 2: Decorator protein P03

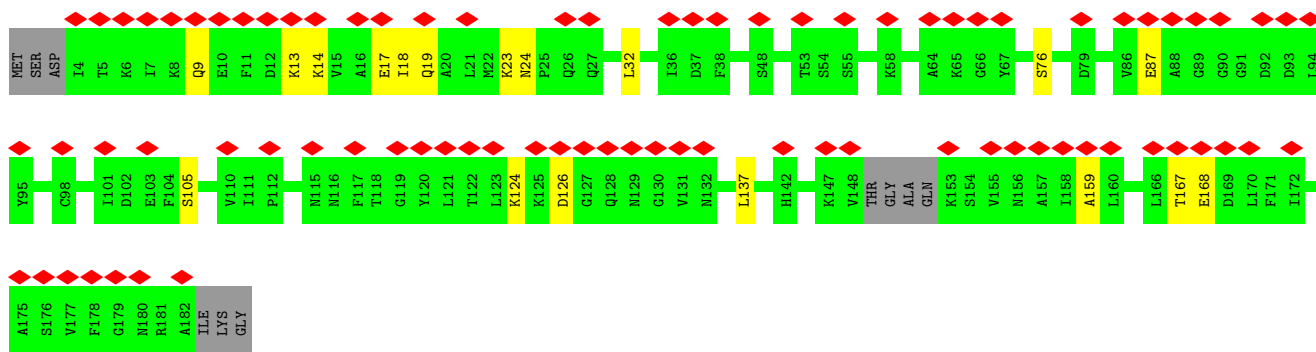
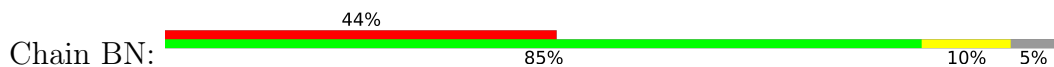

• Molecule 2: Decorator protein P03

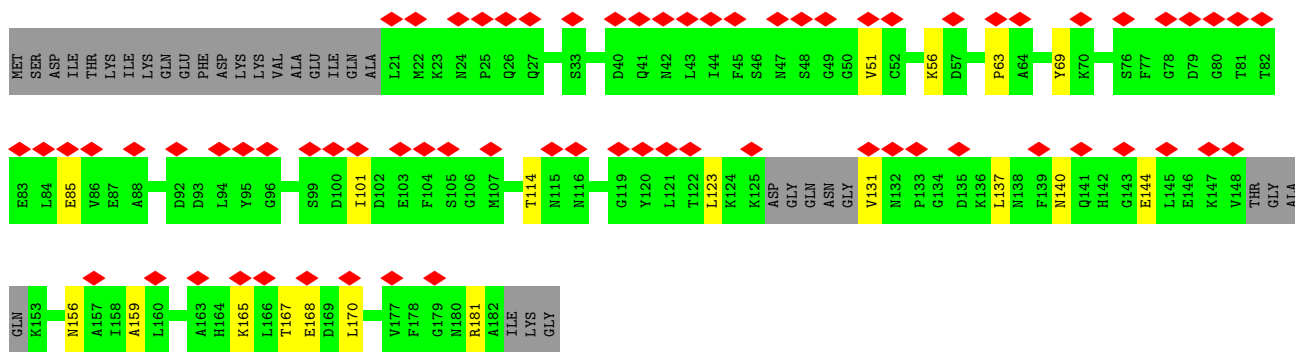
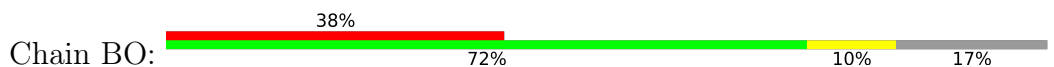

• Molecule 2: Decorator protein P03

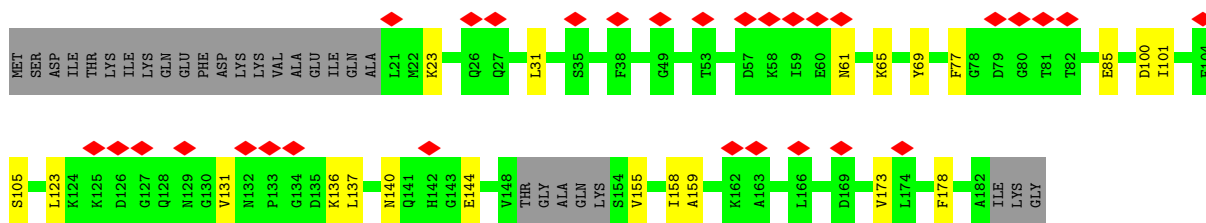
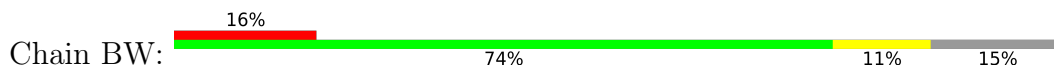

• Molecule 2: Decorator protein P03

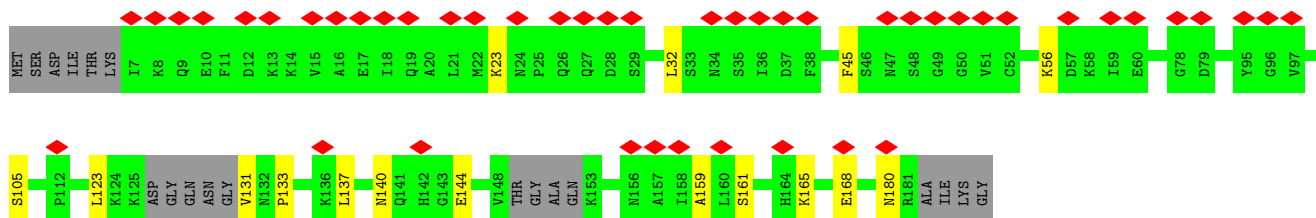
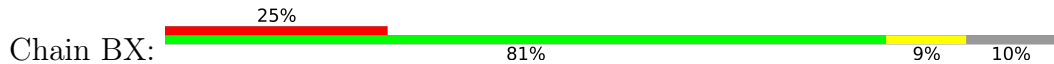

• Molecule 2: Decorator protein P03

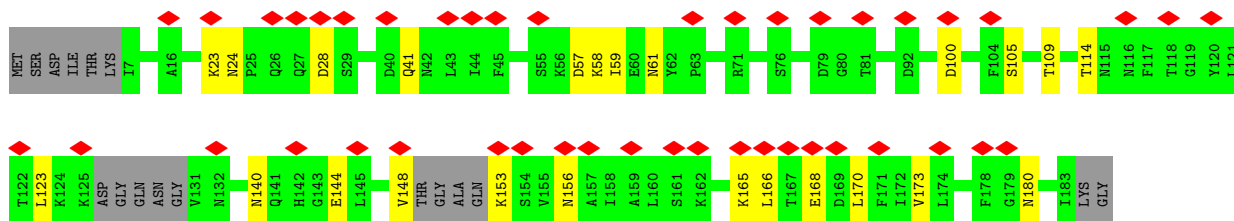
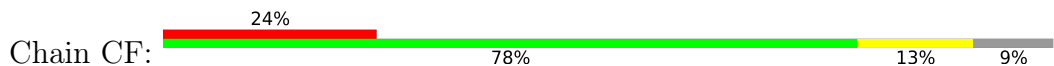

• Molecule 2: Decorator protein P03

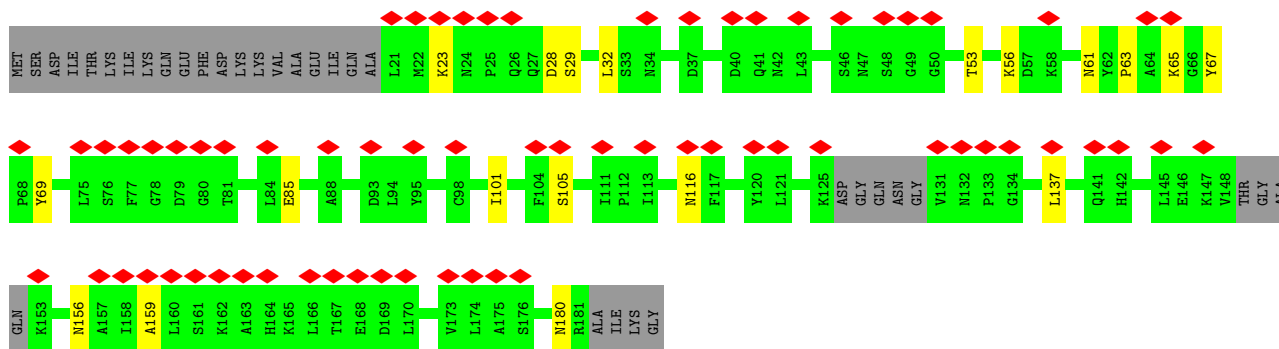
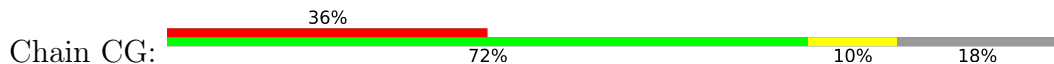

• Molecule 2: Decorator protein P03



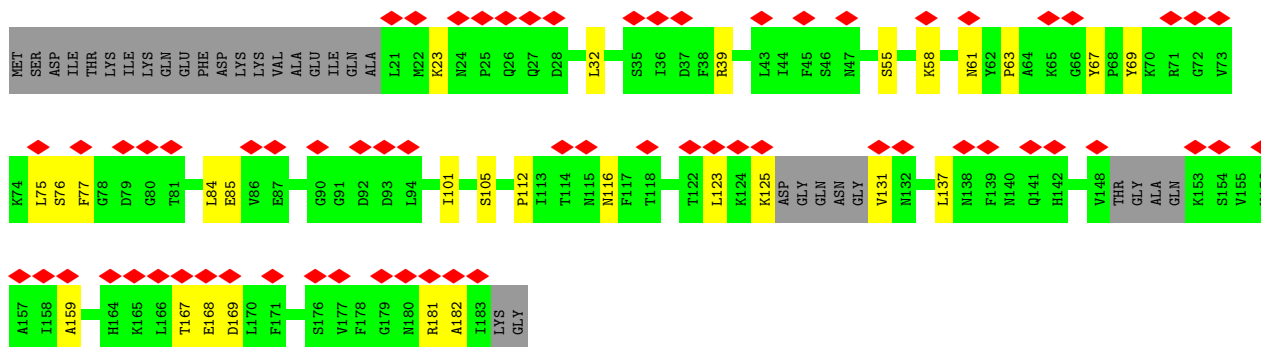

• Molecule 2: Decorator protein P03

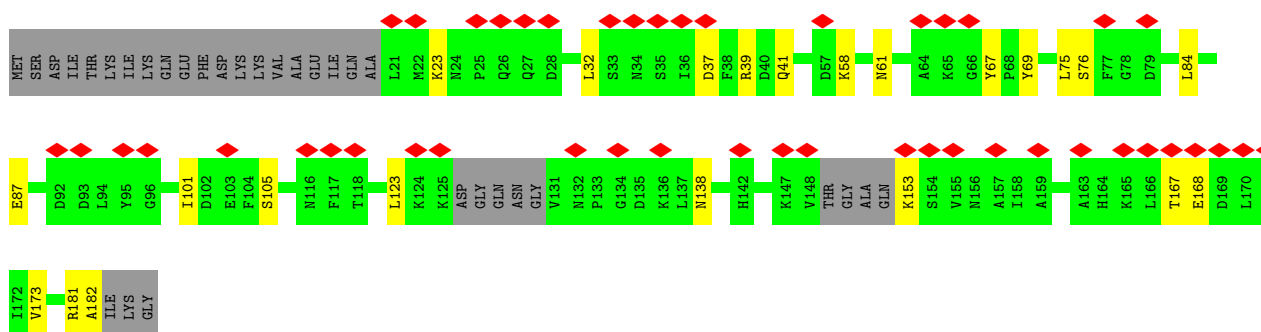

• Molecule 2: Decorator protein P03

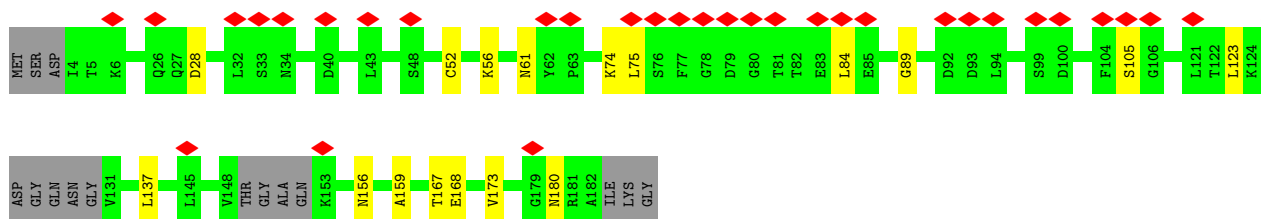
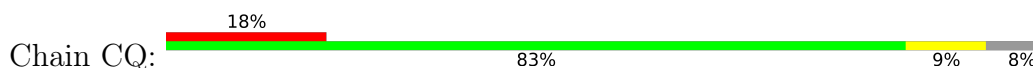

• Molecule 2: Decorator protein P03

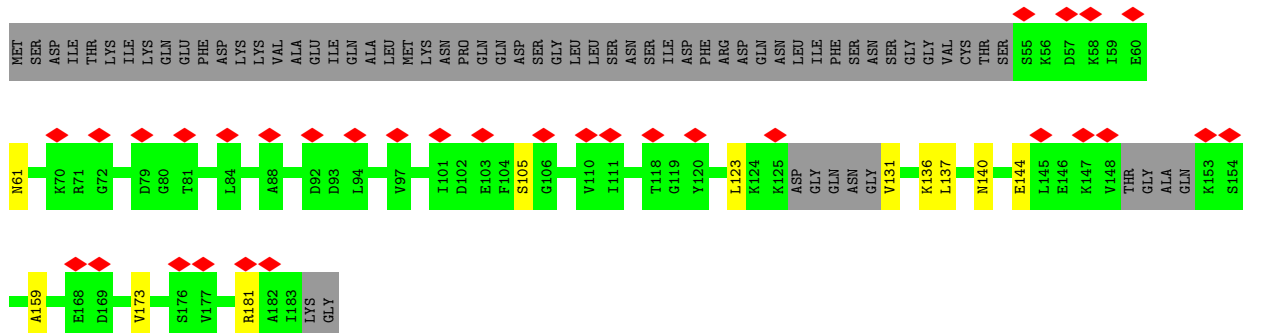

• Molecule 2: Decorator protein P03

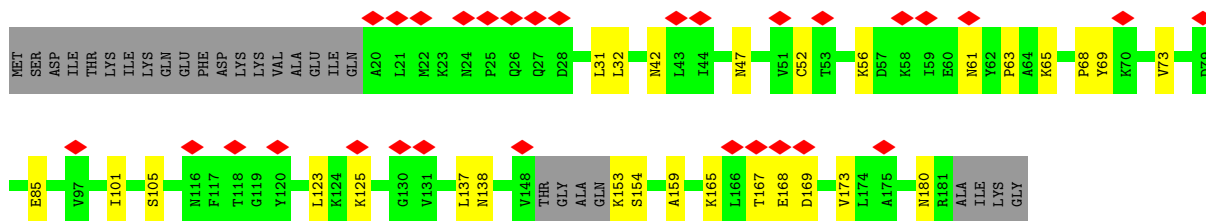
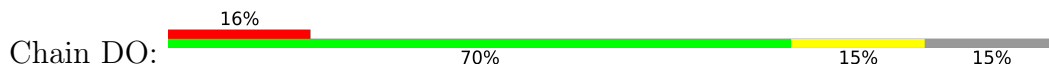

• Molecule 2: Decorator protein P03

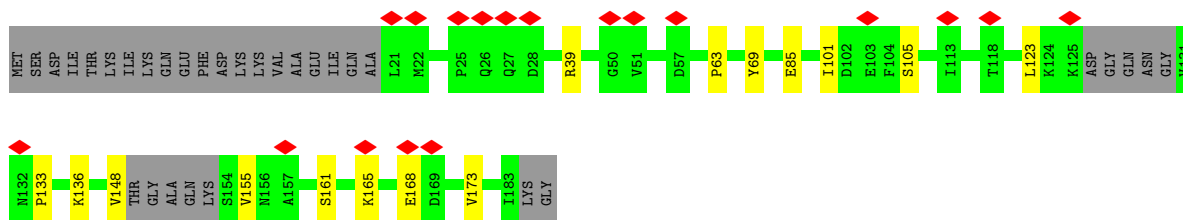
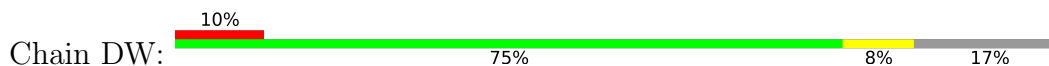

• Molecule 2: Decorator protein P03

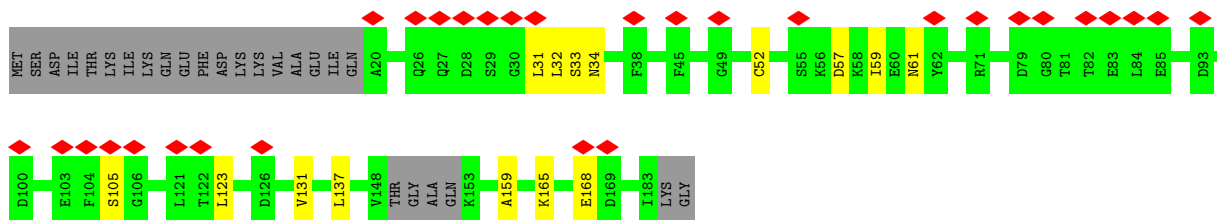
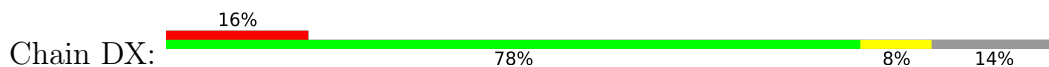

• Molecule 2: Decorator protein P03

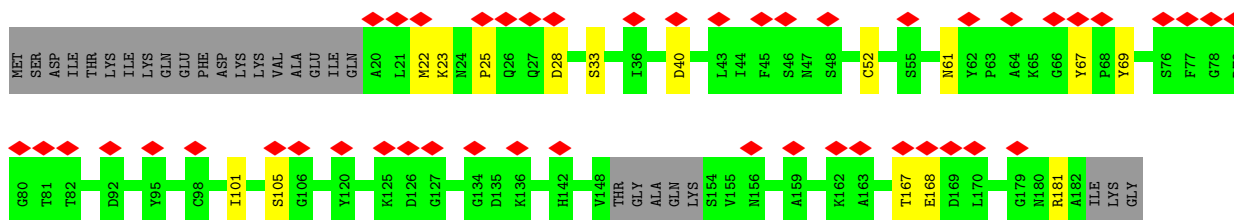
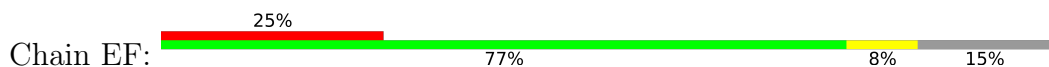

• Molecule 2: Decorator protein P03

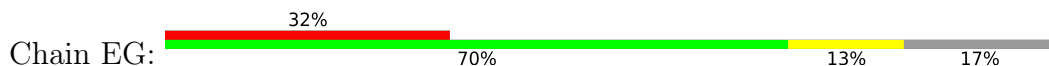

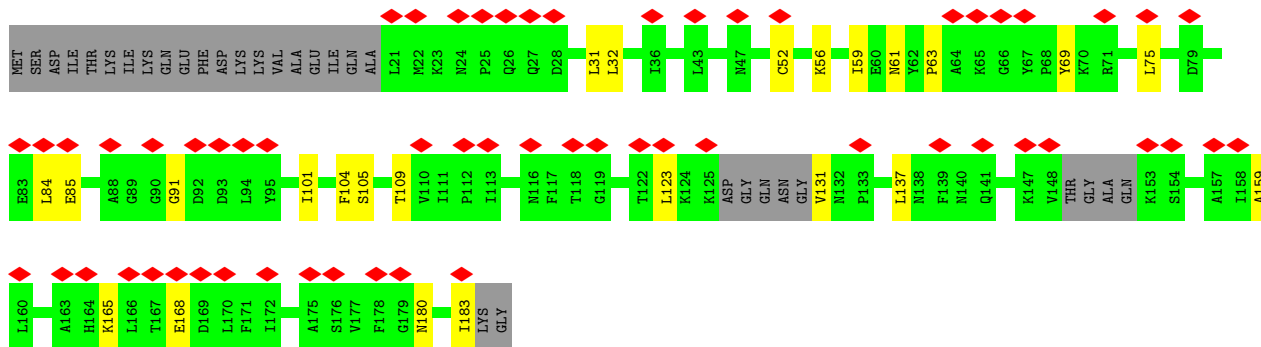

• Molecule 2: Decorator protein P03

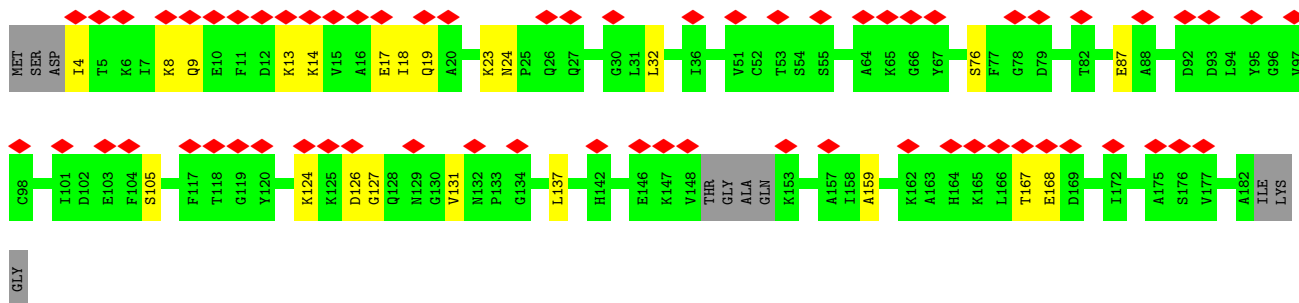
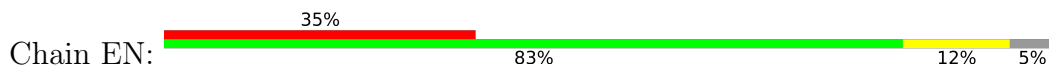

• Molecule 2: Decorator protein P03

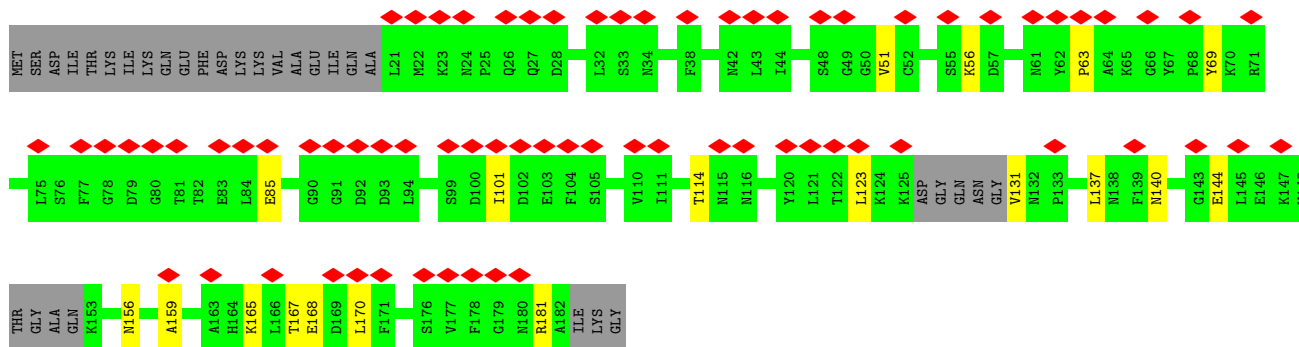
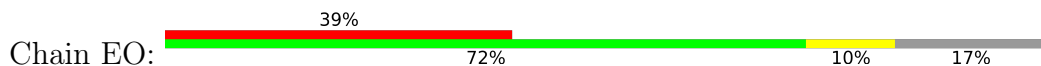

• Molecule 2: Decorator protein P03

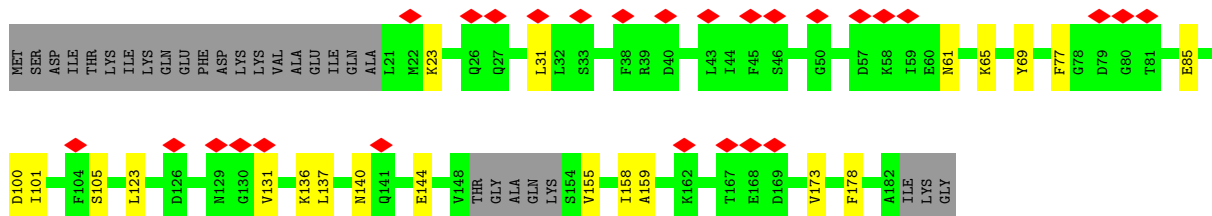
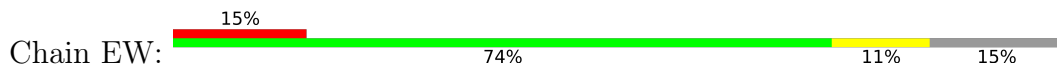

• Molecule 2: Decorator protein P03

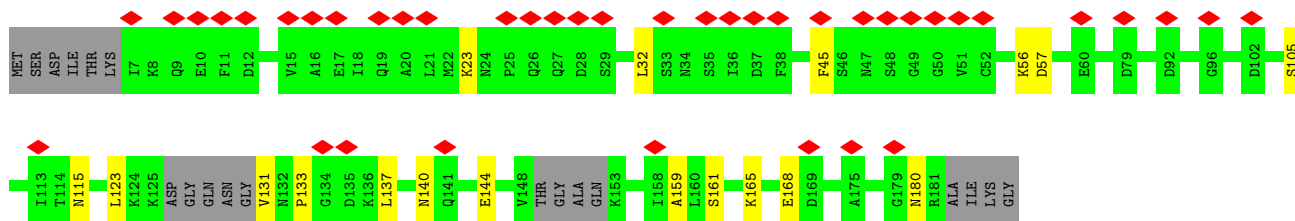
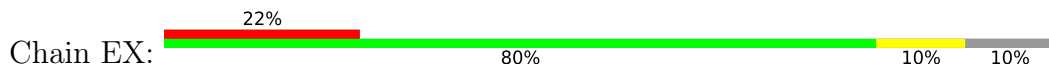

• Molecule 2: Decorator protein P03

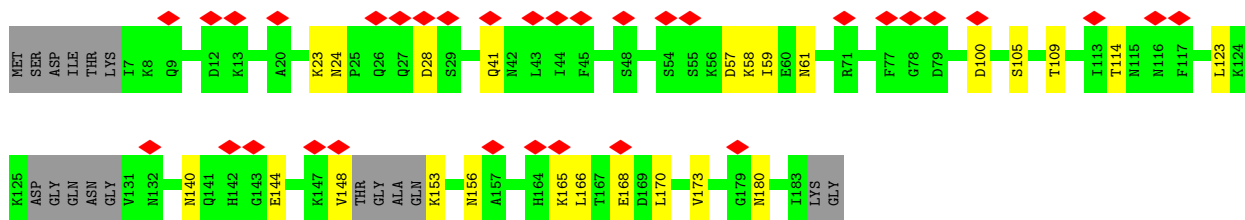
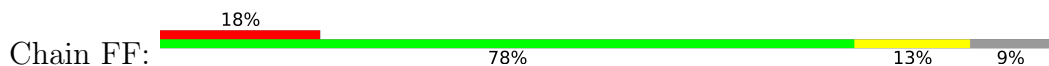

• Molecule 2: Decorator protein P03

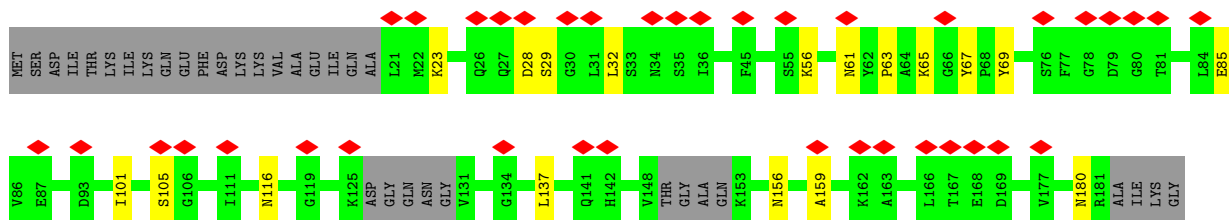
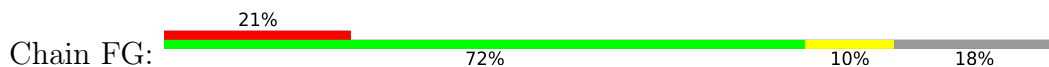

• Molecule 2: Decorator protein P03

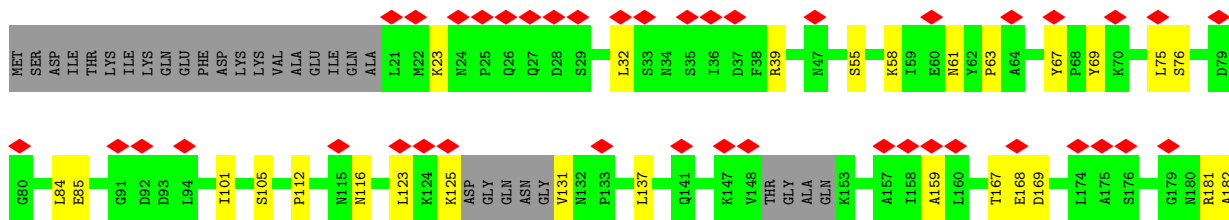

• Molecule 2: Decorator protein P03



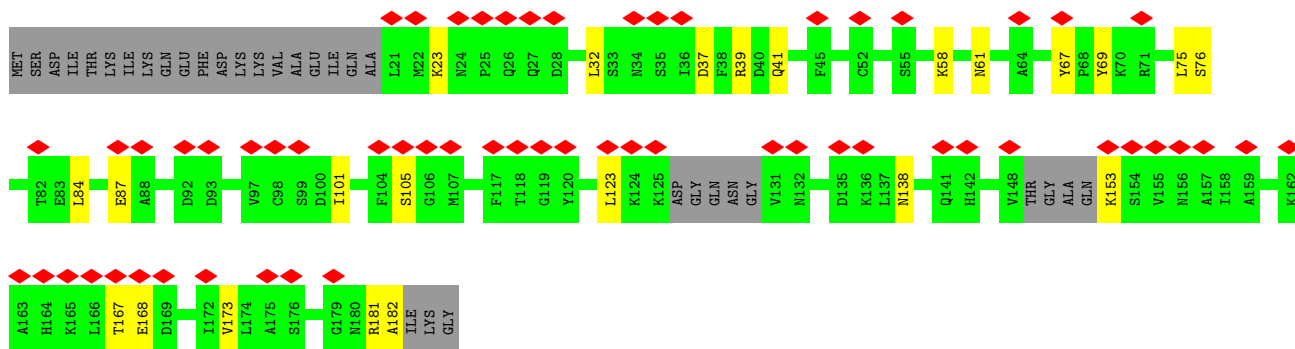

• Molecule 2: Decorator protein P03

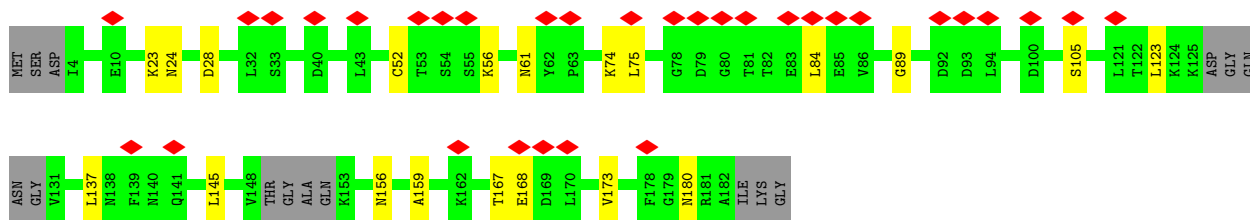
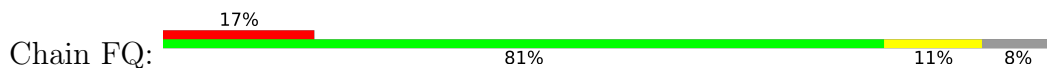

• Molecule 2: Decorator protein P03

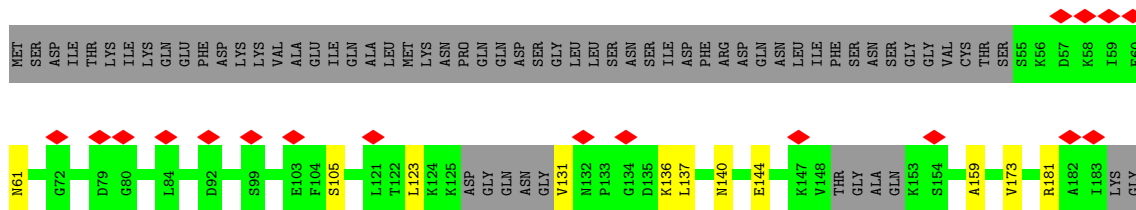

• Molecule 2: Decorator protein P03

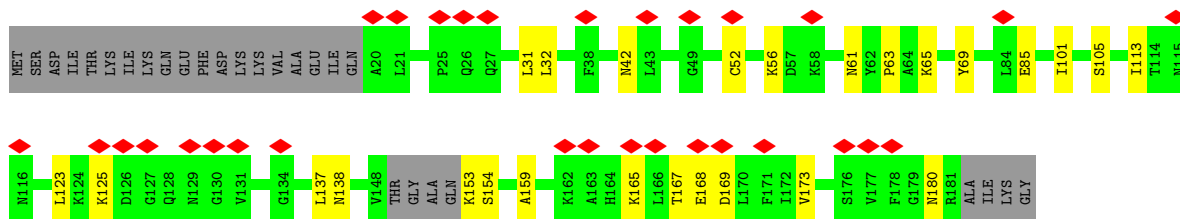
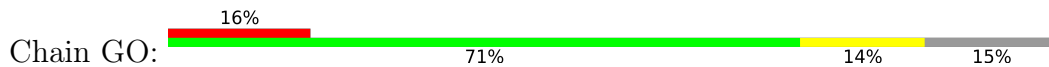

• Molecule 2: Decorator protein P03

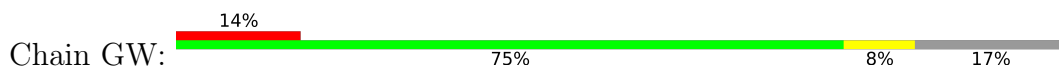

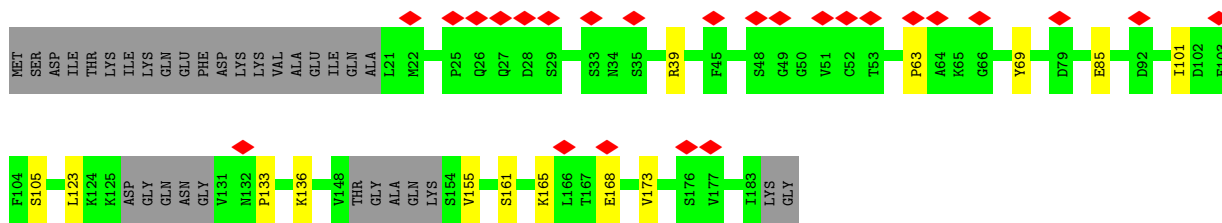

• Molecule 2: Decorator protein P03

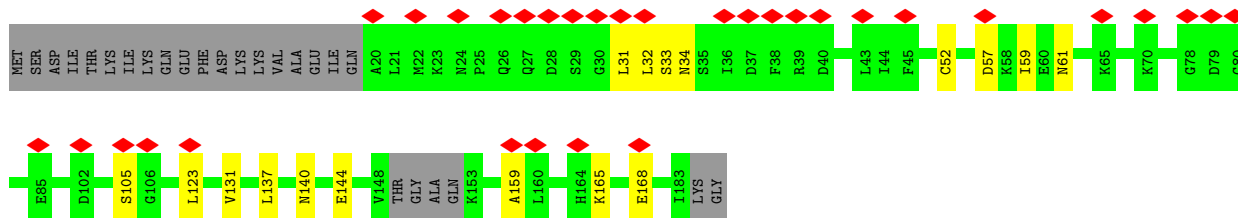
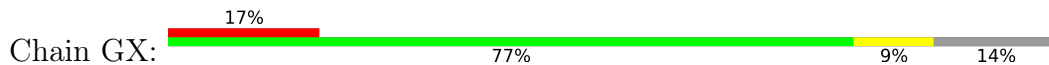

• Molecule 2: Decorator protein P03

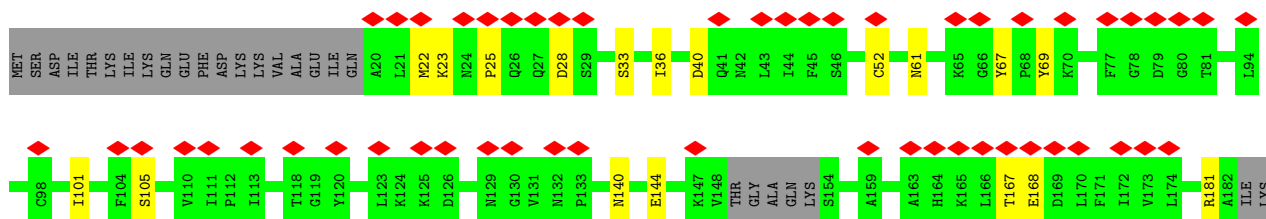
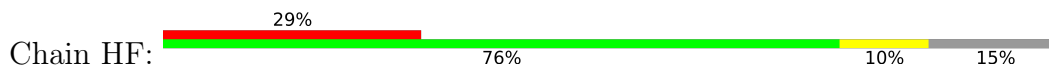

• Molecule 2: Decorator protein P03

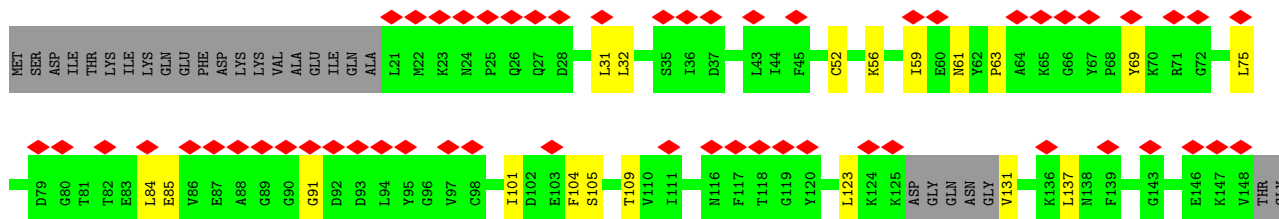
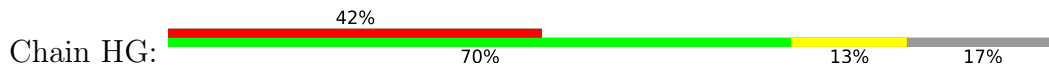

• Molecule 2: Decorator protein P03

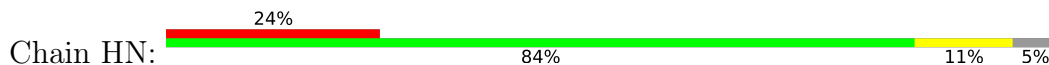

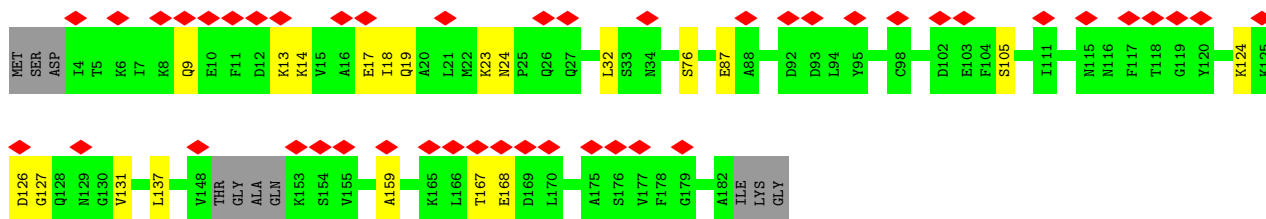

• Molecule 2: Decorator protein P03

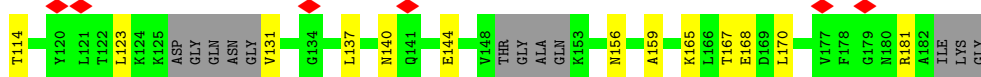
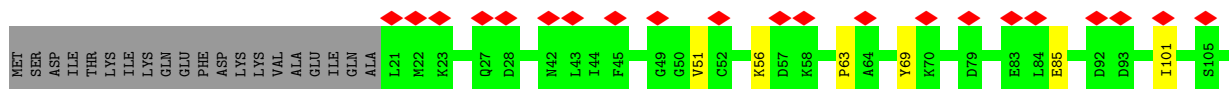
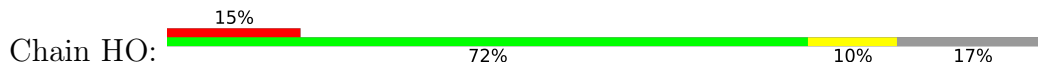

• Molecule 2: Decorator protein P03

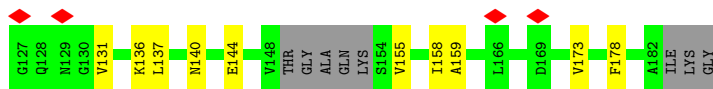
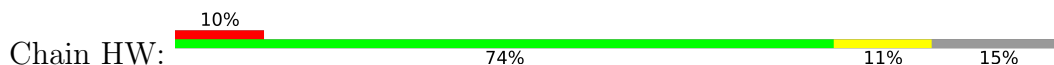

• Molecule 2: Decorator protein P03

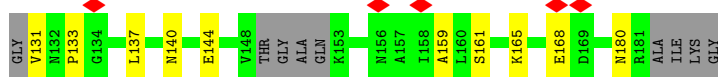
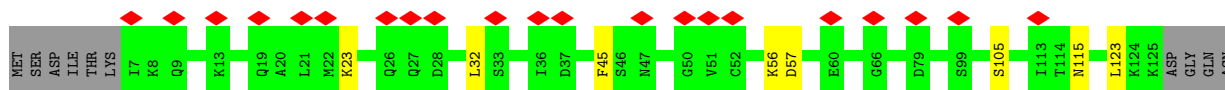
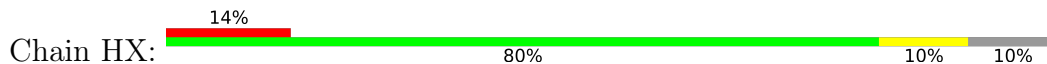

• Molecule 2: Decorator protein P03

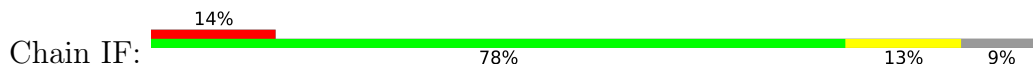

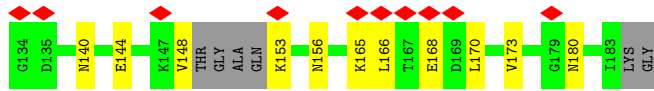

• Molecule 2: Decorator protein P03

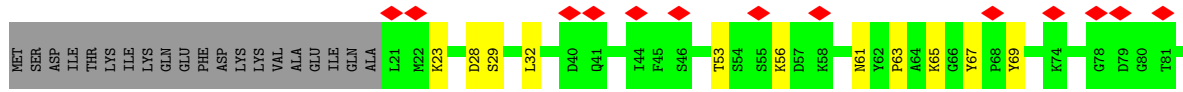
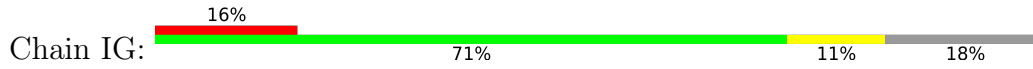

• Molecule 2: Decorator protein P03

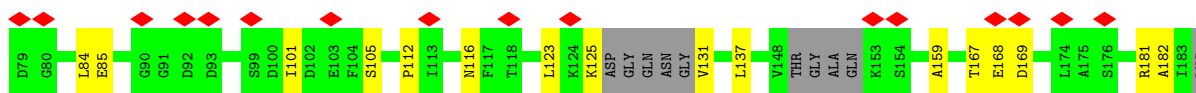
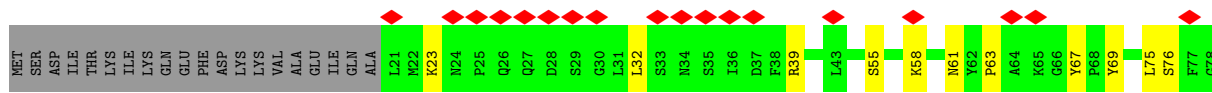

GLY

• Molecule 2: Decorator protein P03

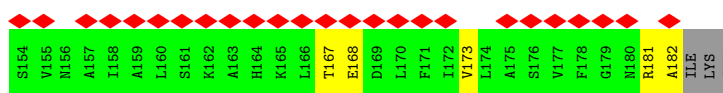
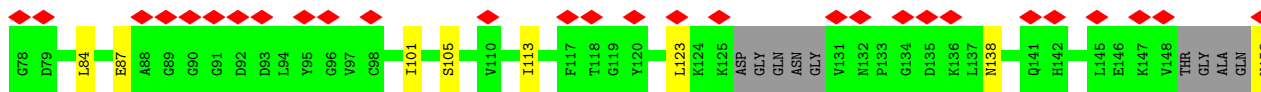
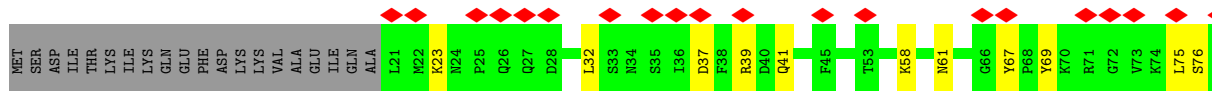

• Molecule 2: Decorator protein P03

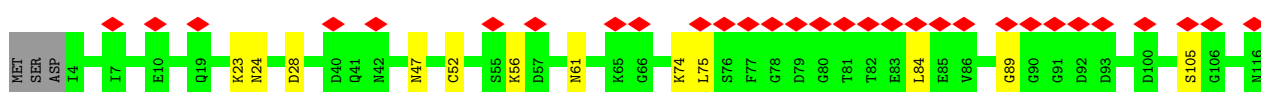
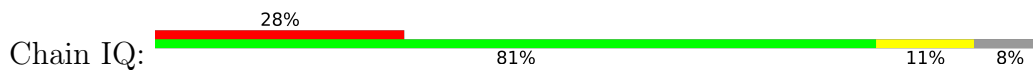

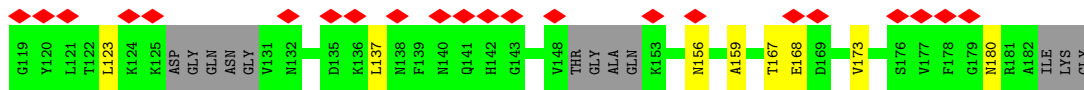

• Molecule 2: Decorator protein P03

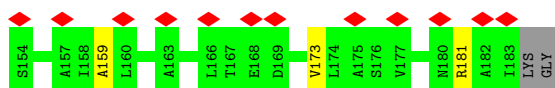
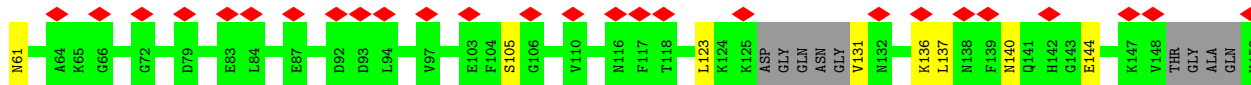
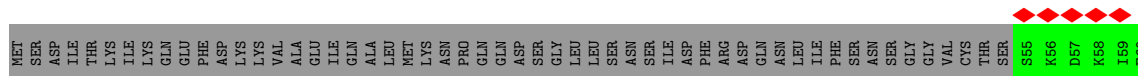

• Molecule 2: Decorator protein P03

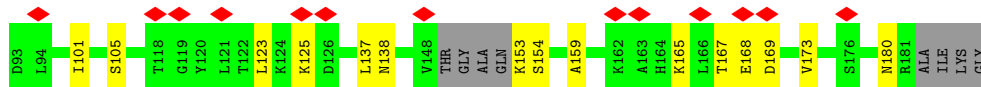
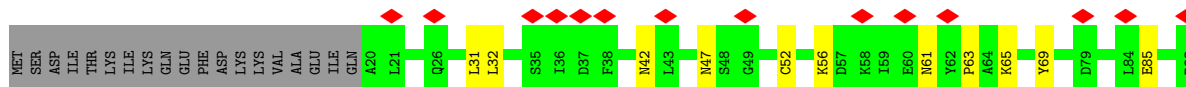

• Molecule 2: Decorator protein P03

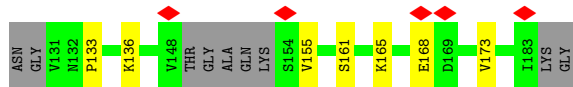
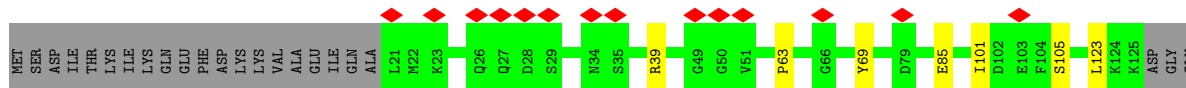
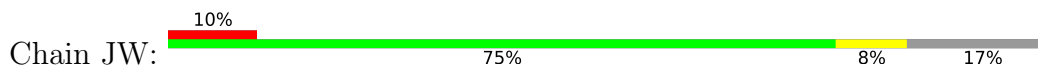

• Molecule 2: Decorator protein P03

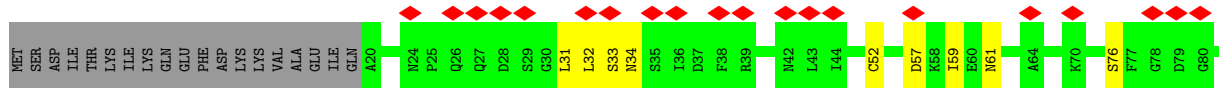
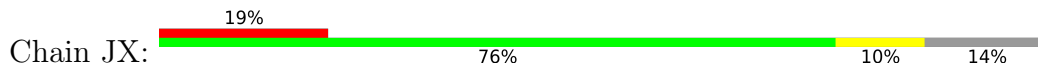



• Molecule 2: Decorator protein P03

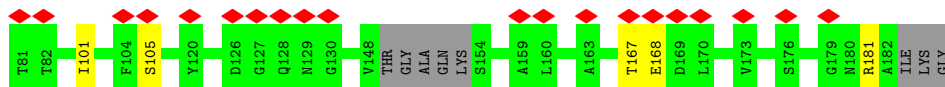
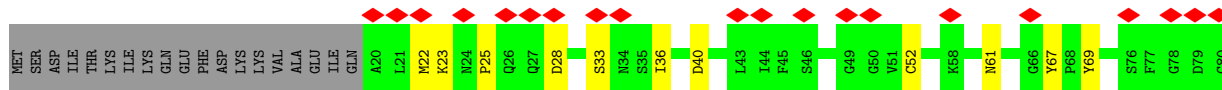
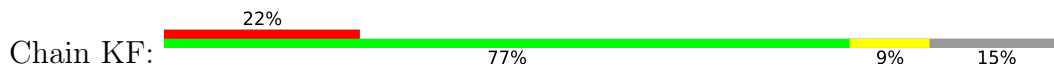

• Molecule 2: Decorator protein P03

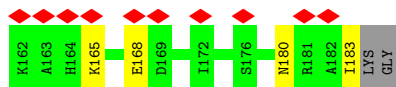
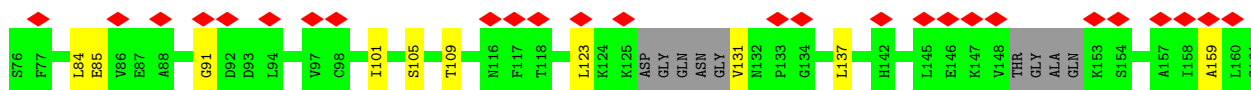
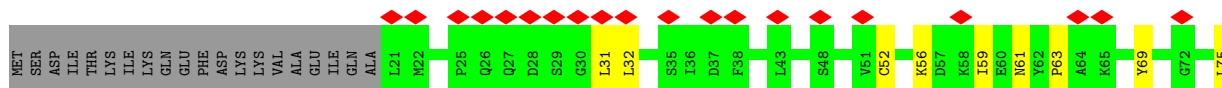
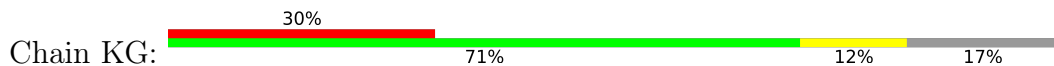

• Molecule 2: Decorator protein P03

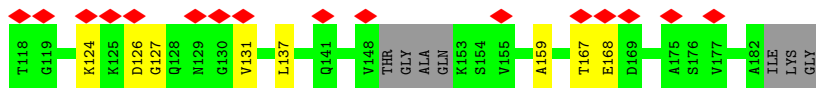
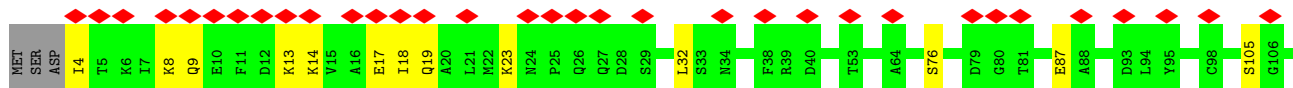
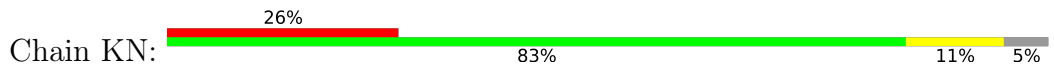

• Molecule 2: Decorator protein P03

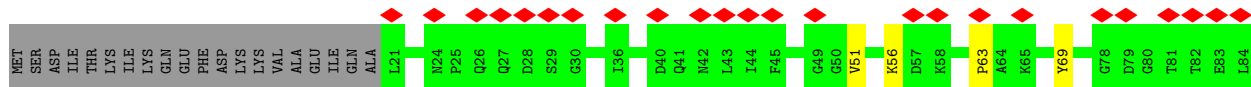
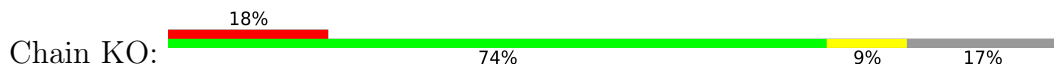

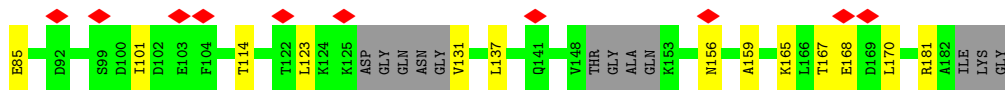

• Molecule 2: Decorator protein P03

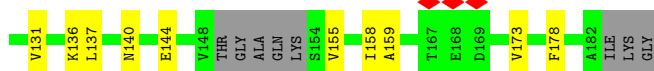
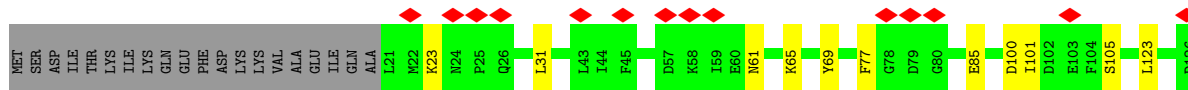
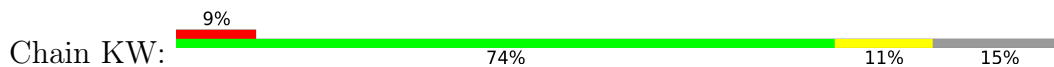

• Molecule 2: Decorator protein P03

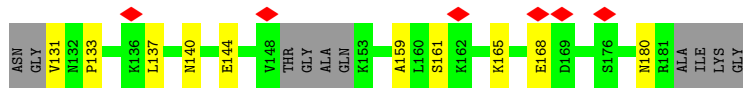
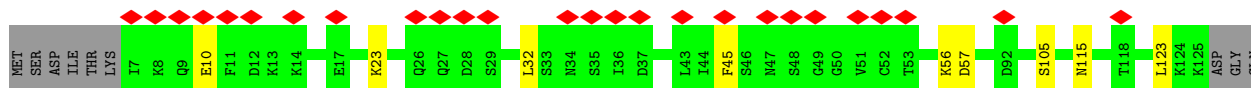
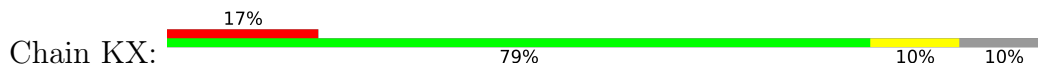

• Molecule 2: Decorator protein P03

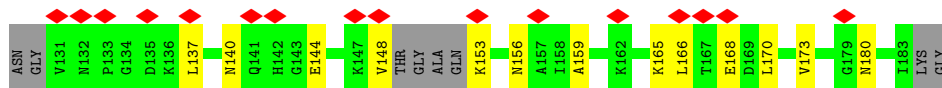
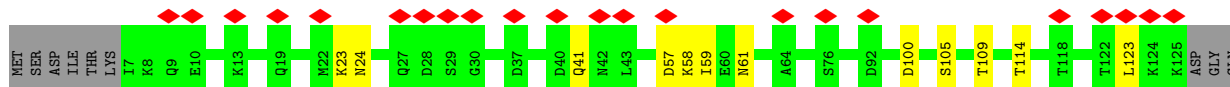
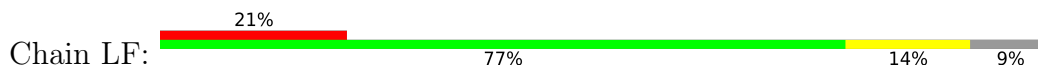

• Molecule 2: Decorator protein P03

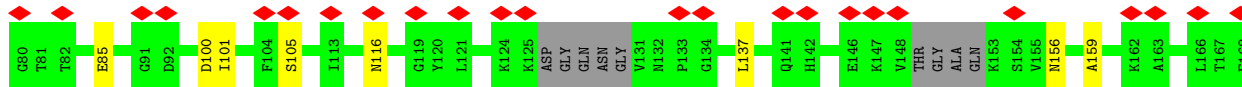
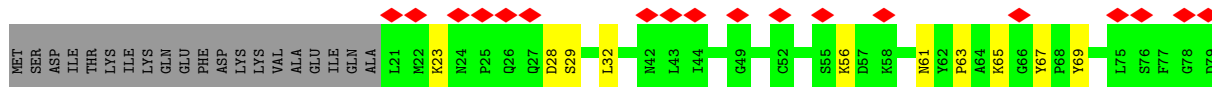
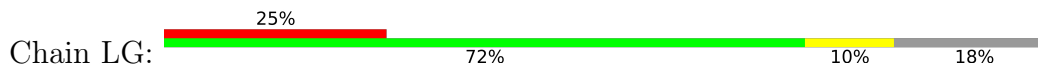

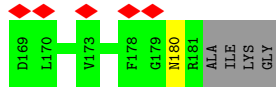

• Molecule 2: Decorator protein P03

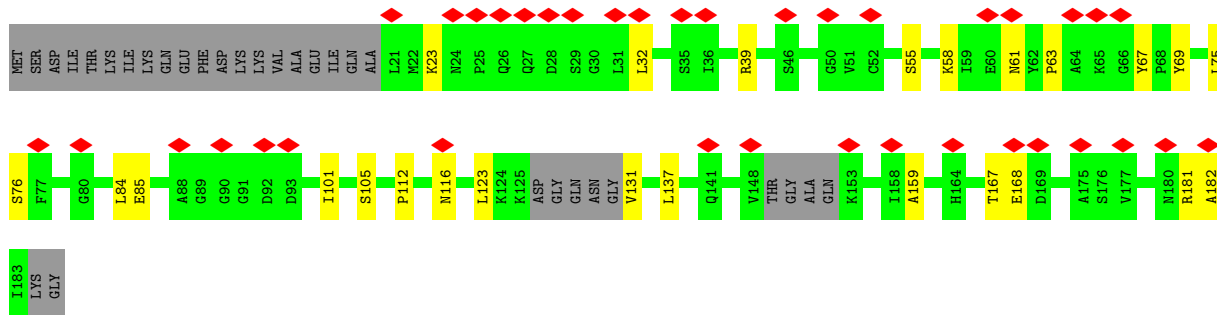
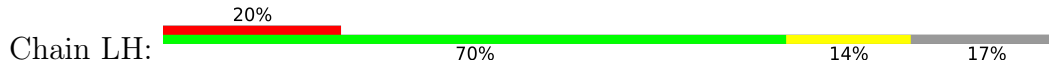

• Molecule 2: Decorator protein P03

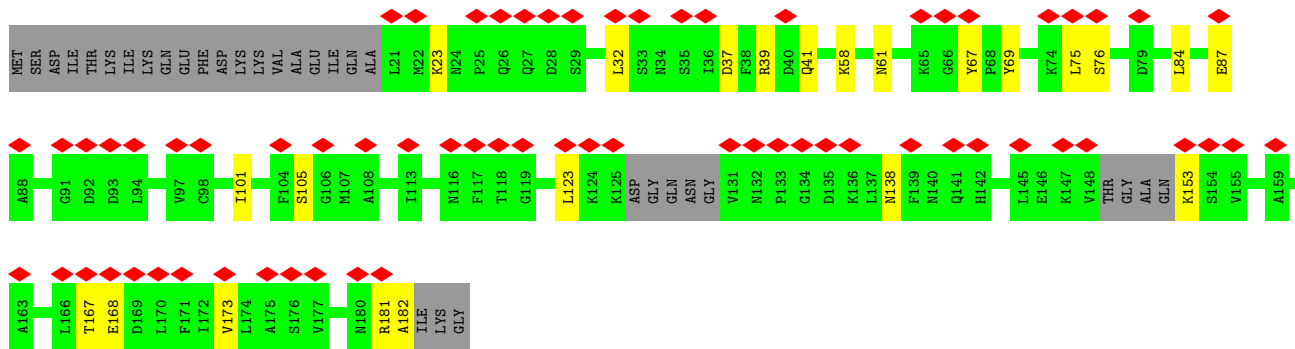
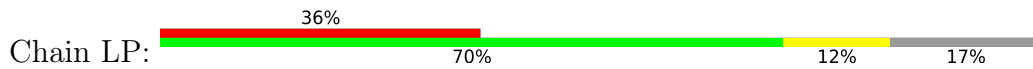

• Molecule 2: Decorator protein P03

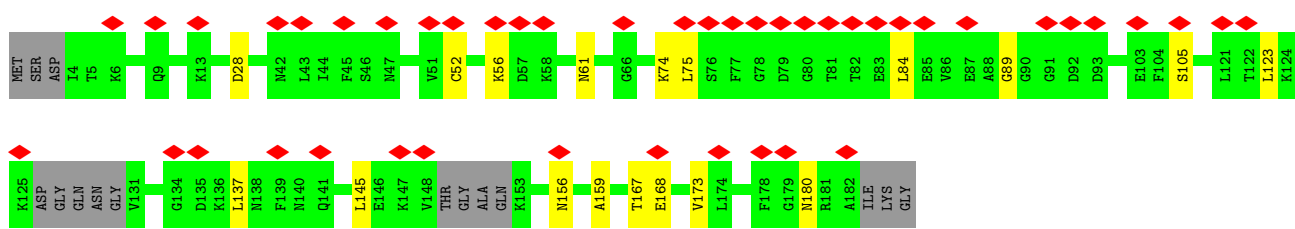
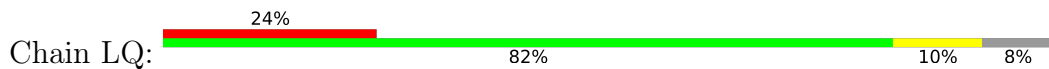

• Molecule 2: Decorator protein P03

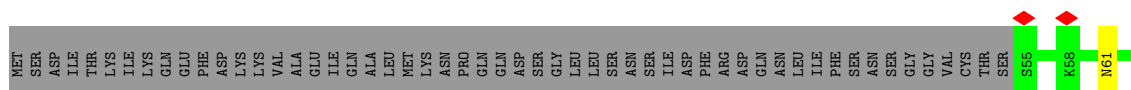

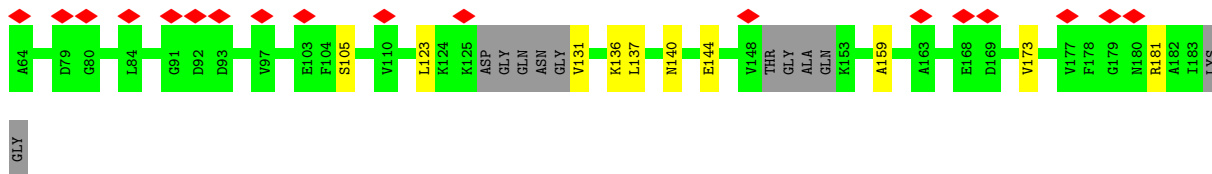

• Molecule 2: Decorator protein P03

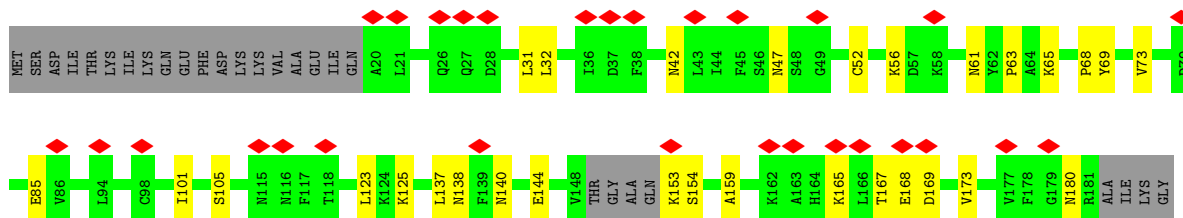

• Molecule 2: Decorator protein P03

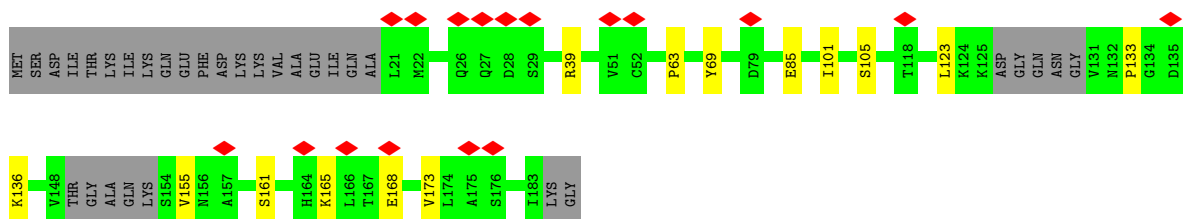
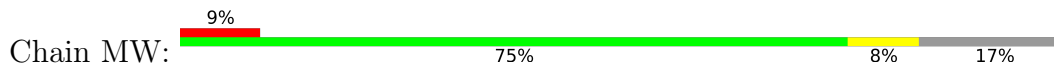

• Molecule 2: Decorator protein P03

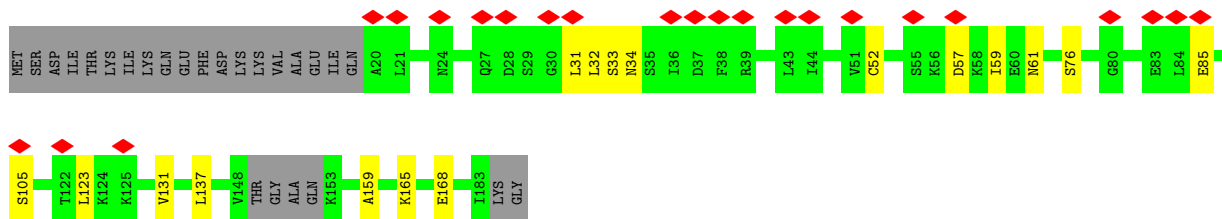
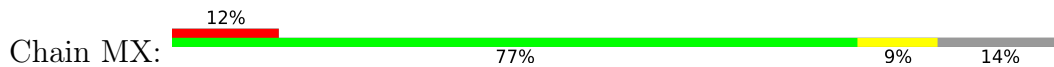

• Molecule 2: Decorator protein P03

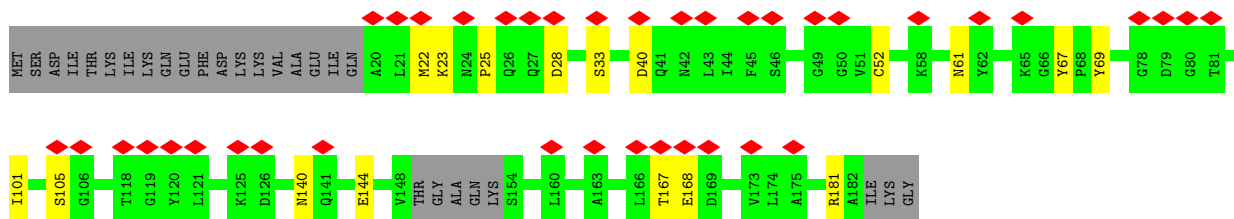
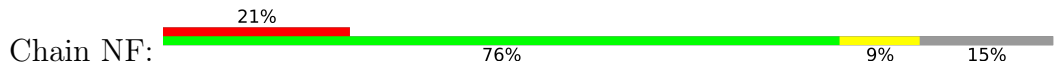

• Molecule 2: Decorator protein P03

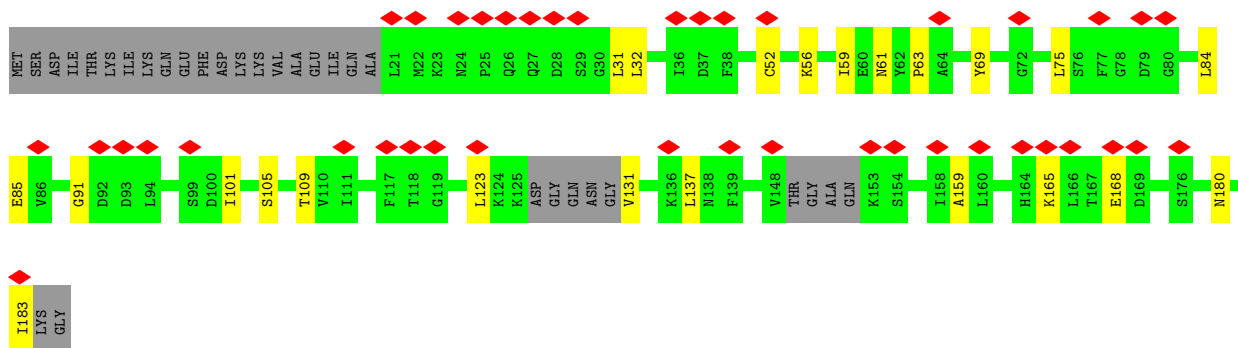
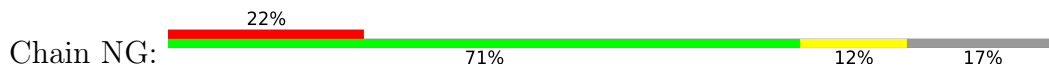

• Molecule 2: Decorator protein P03

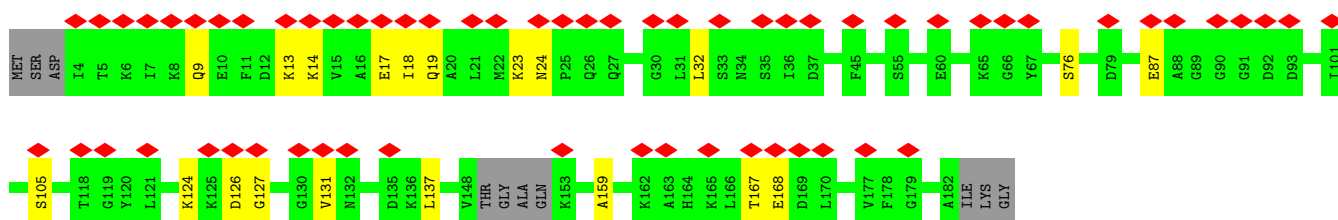
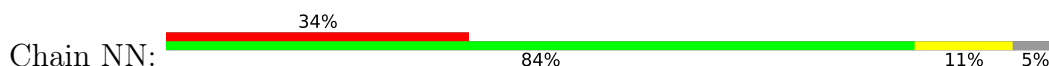

• Molecule 2: Decorator protein P03

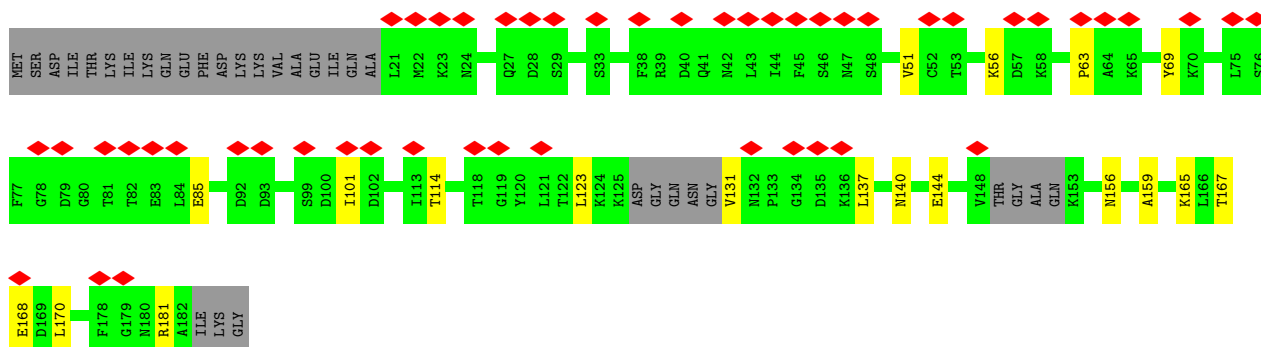
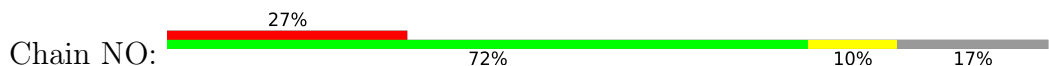

• Molecule 2: Decorator protein P03

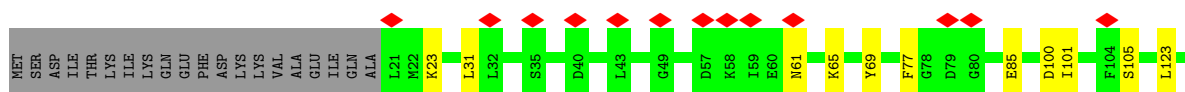
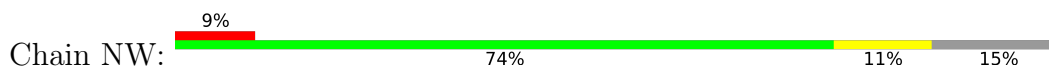

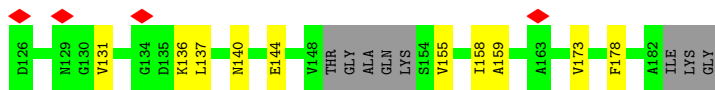

- Molecule 2: Decorator protein P03

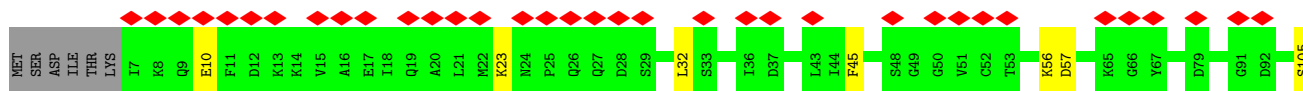
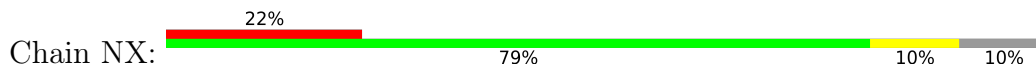

- Molecule 2: Decorator protein P03

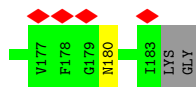
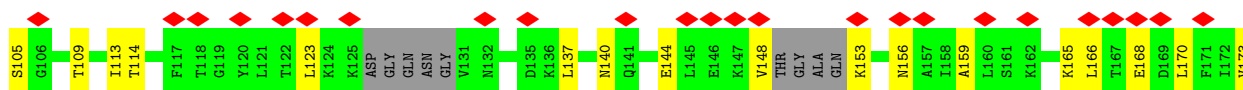
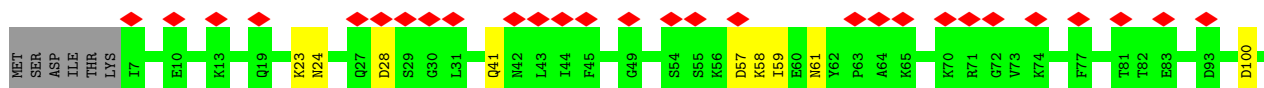
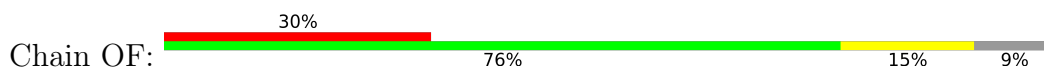

- Molecule 2: Decorator protein P03

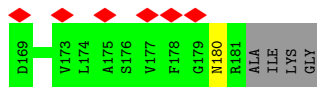
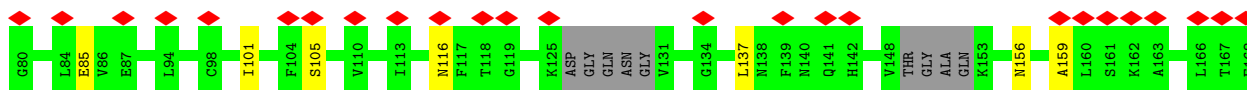
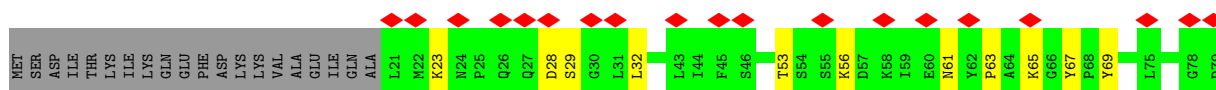
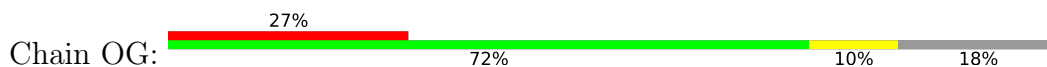

- Molecule 2: Decorator protein P03



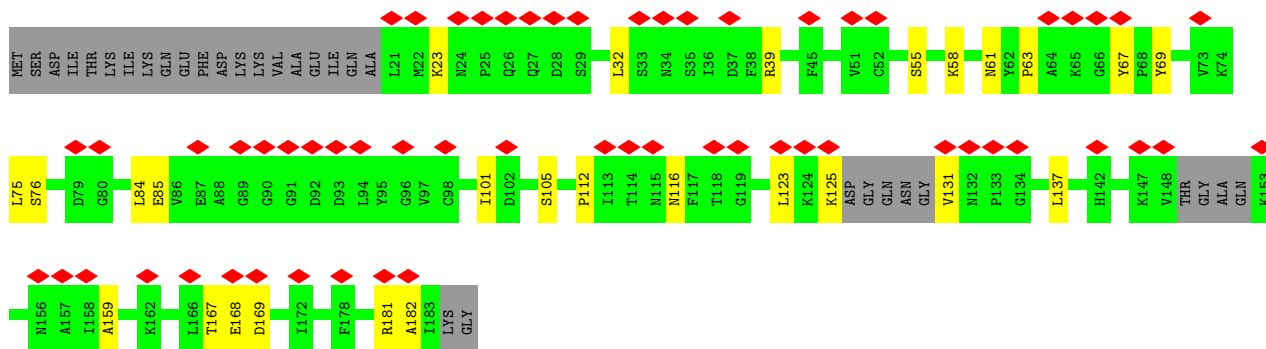

• Molecule 2: Decorator protein P03

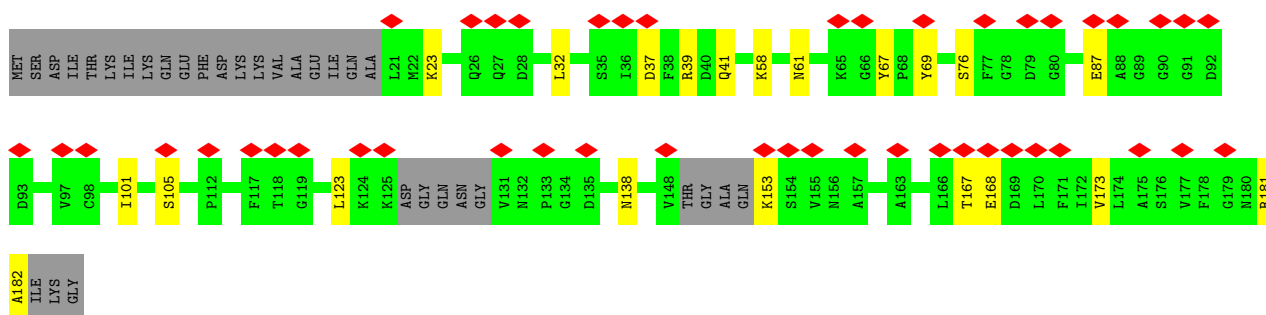
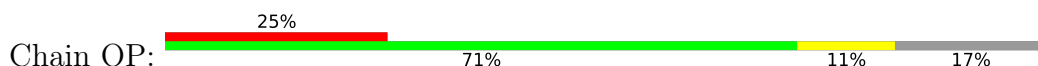

• Molecule 2: Decorator protein P03

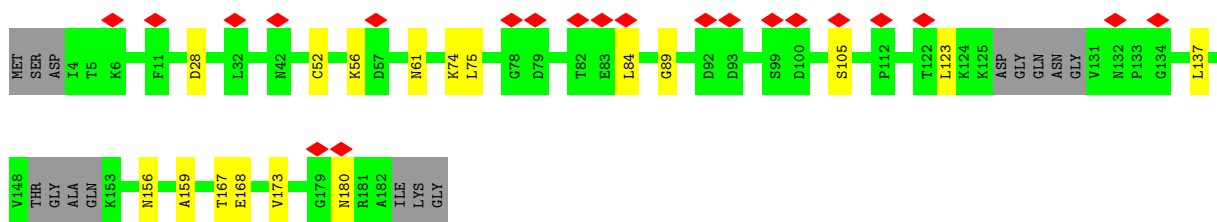
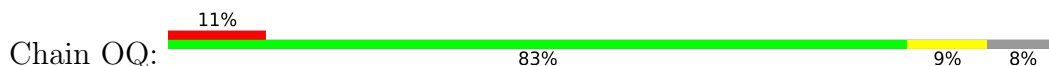

• Molecule 3: Decorator protein P05

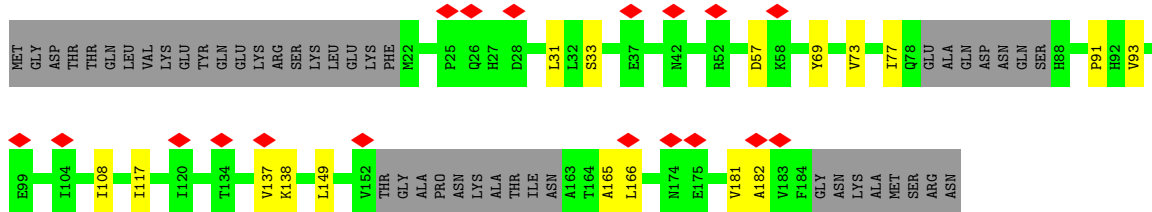

• Molecule 3: Decorator protein P05



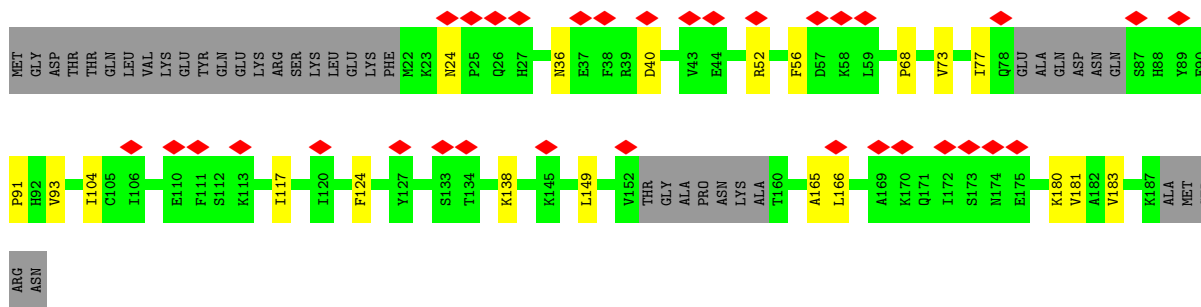

• Molecule 3: Decorator protein P05

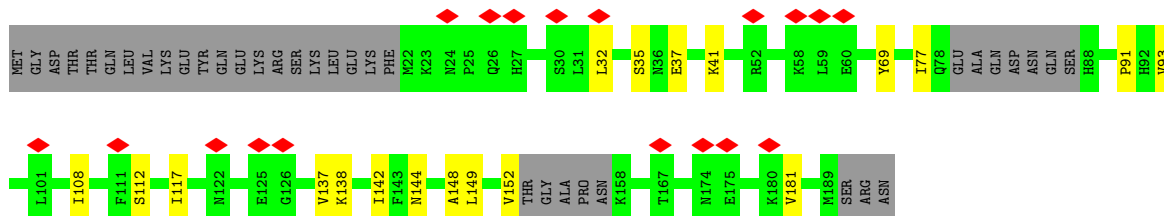
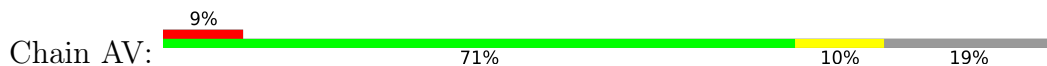

• Molecule 3: Decorator protein P05

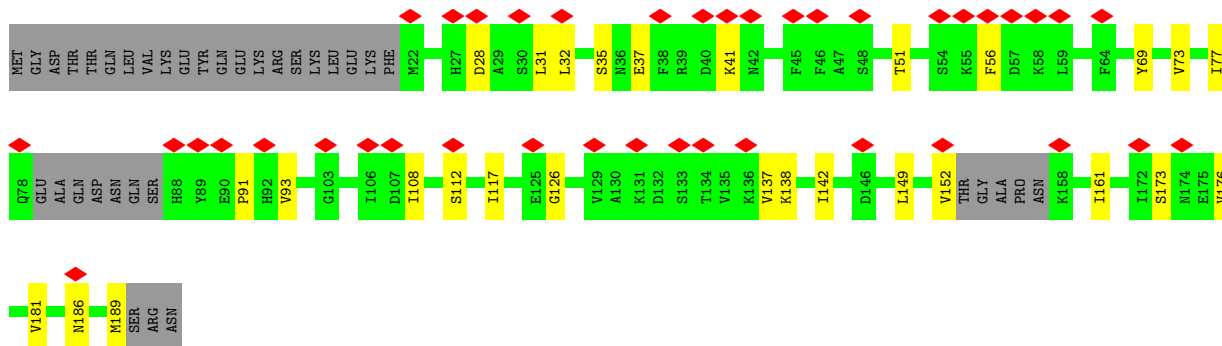

• Molecule 3: Decorator protein P05

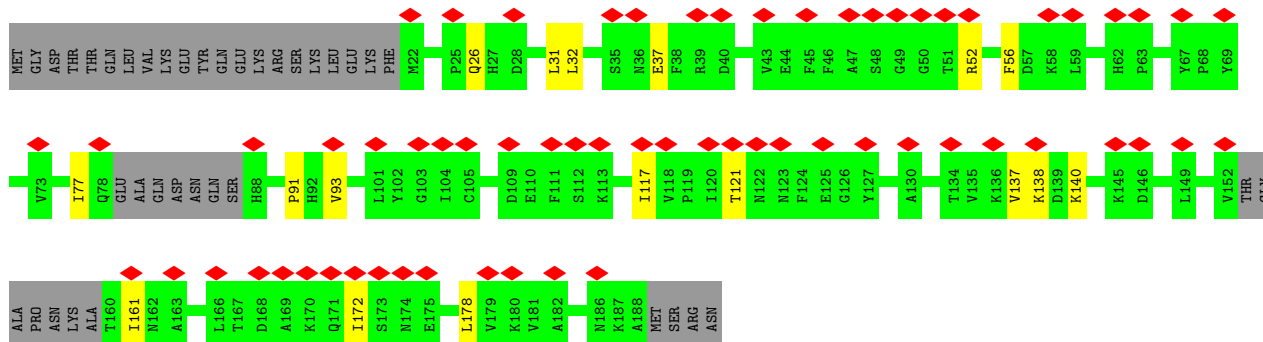
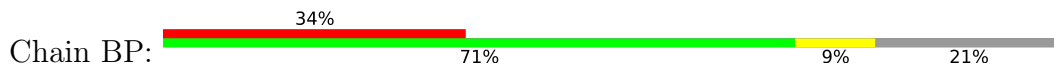

• Molecule 3: Decorator protein P05

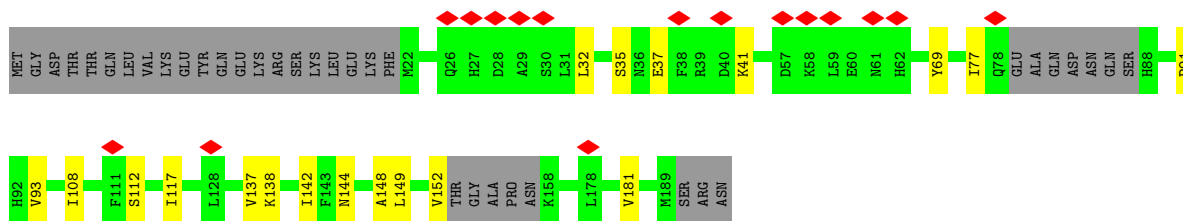
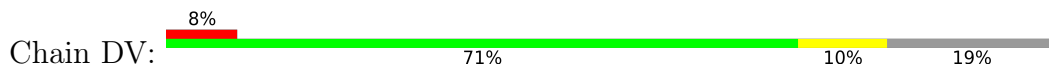

• Molecule 3: Decorator protein P05

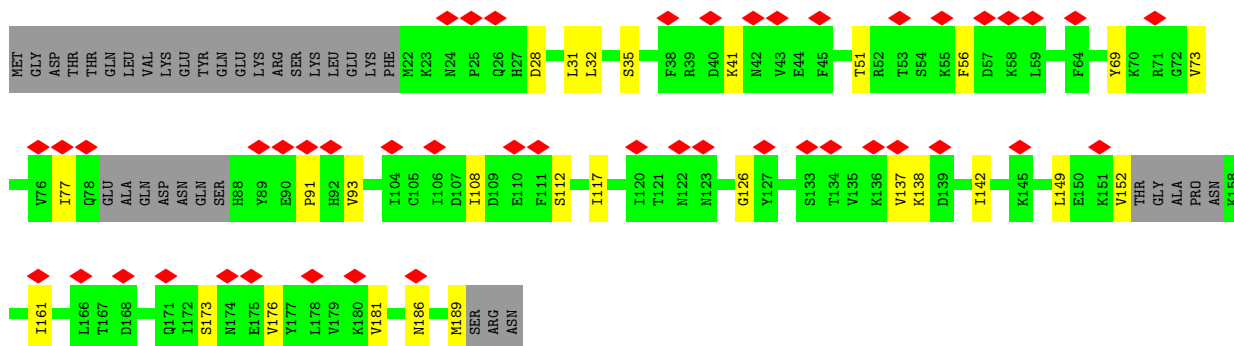

• Molecule 3: Decorator protein P05

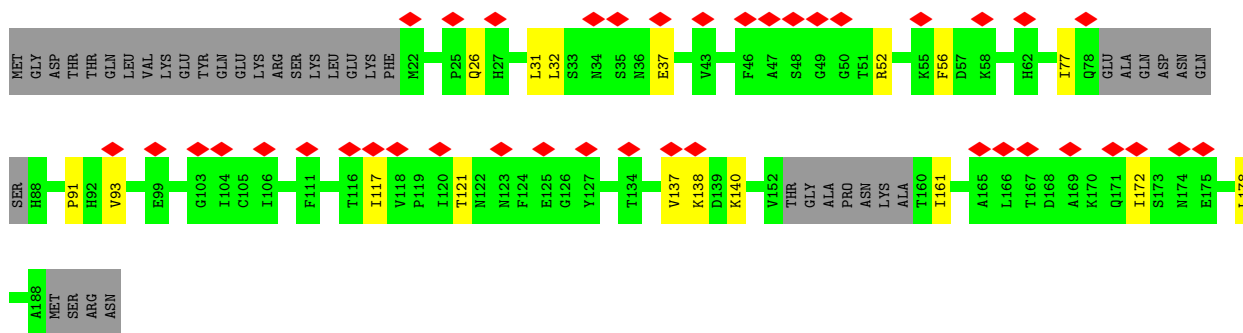

• Molecule 3: Decorator protein P05

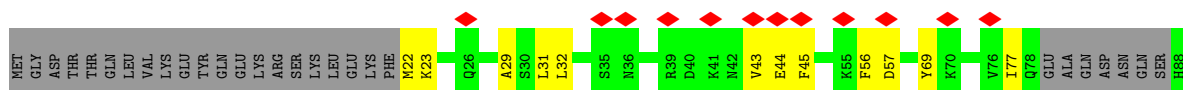

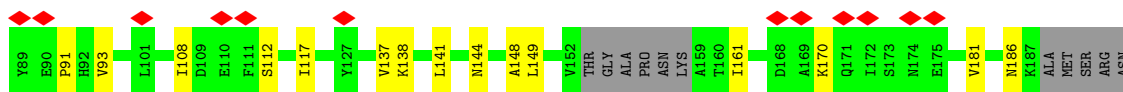

• Molecule 3: Decorator protein P05

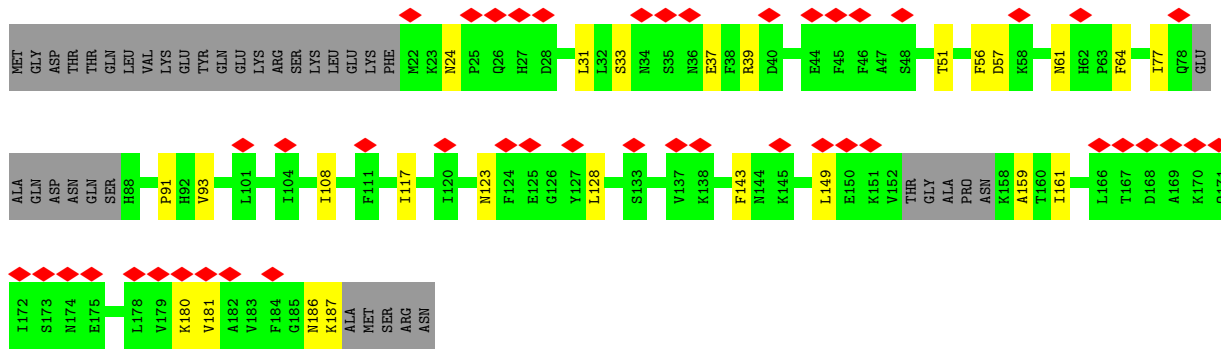

• Molecule 3: Decorator protein P05

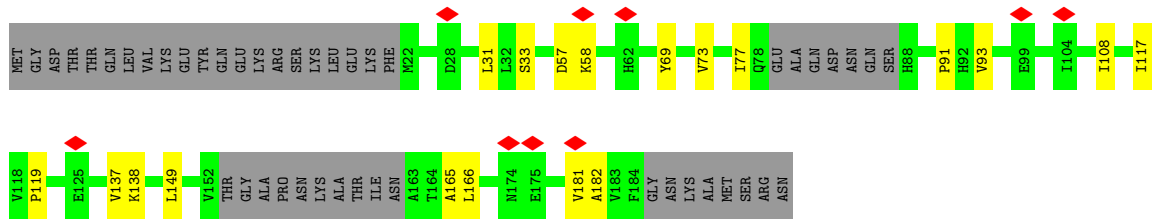

• Molecule 3: Decorator protein P05

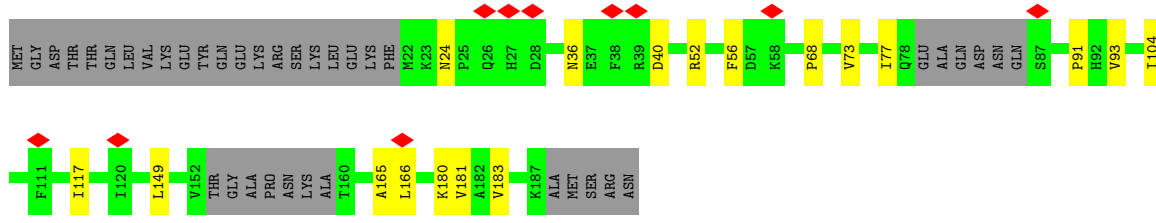
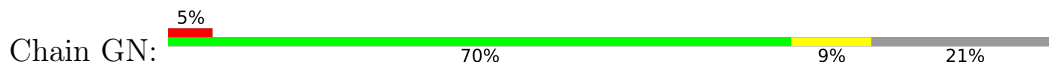

• Molecule 3: Decorator protein P05

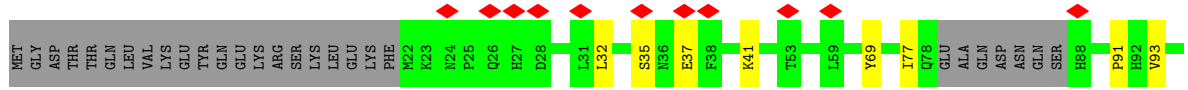
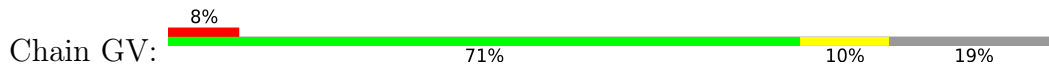

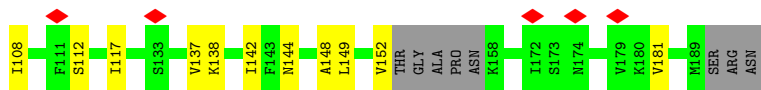

• Molecule 3: Decorator protein P05

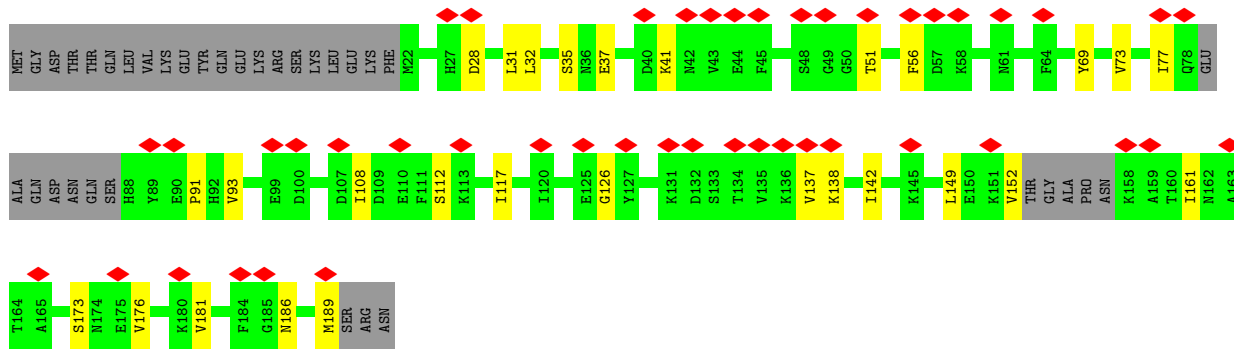

• Molecule 3: Decorator protein P05

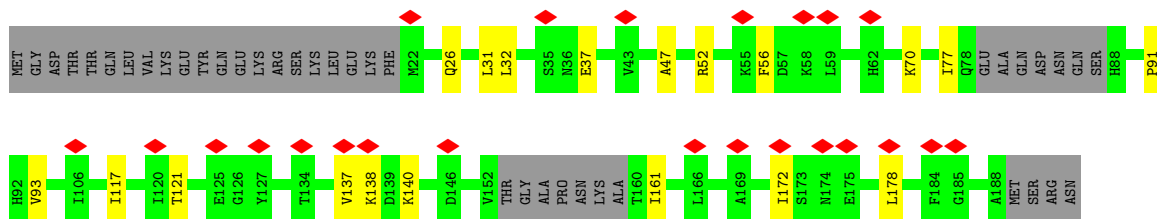

• Molecule 3: Decorator protein P05

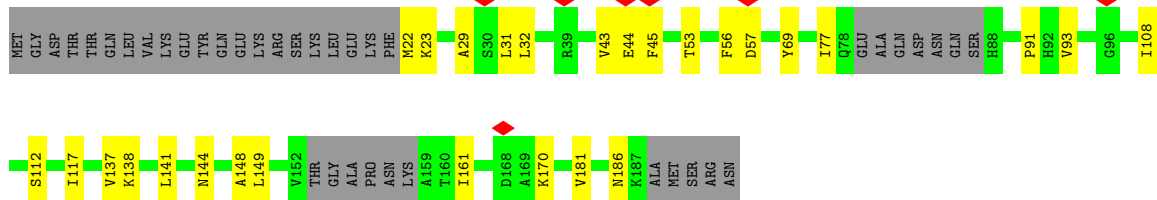

• Molecule 3: Decorator protein P05

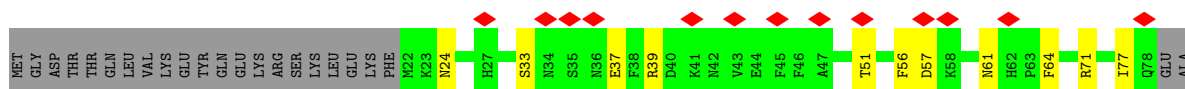

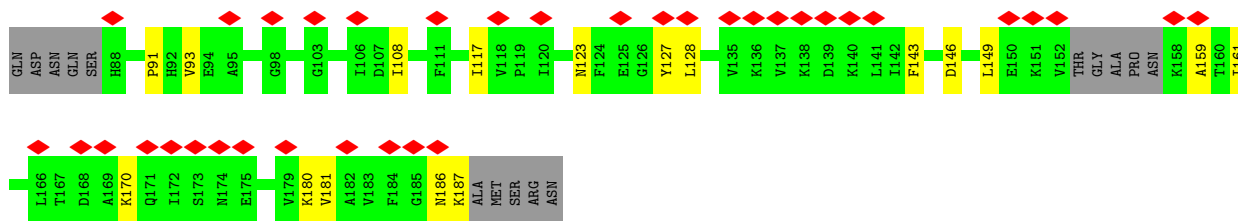

• Molecule 3: Decorator protein P05

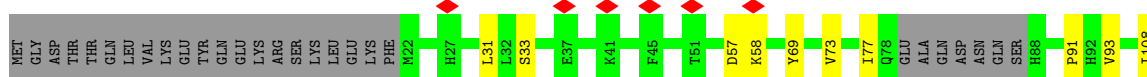

• Molecule 3: Decorator protein P05

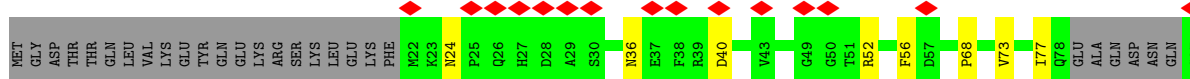

• Molecule 3: Decorator protein P05

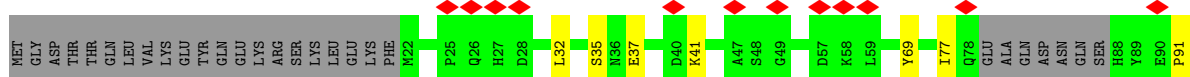
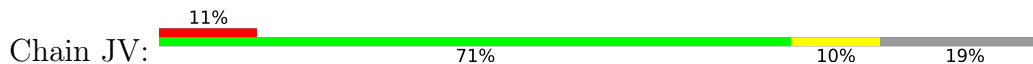

• Molecule 3: Decorator protein P05



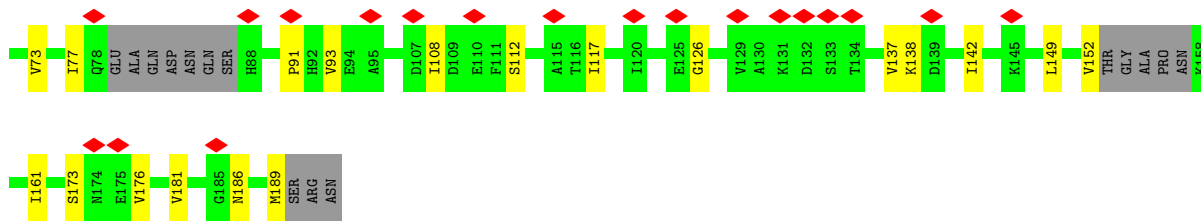

• Molecule 3: Decorator protein P05

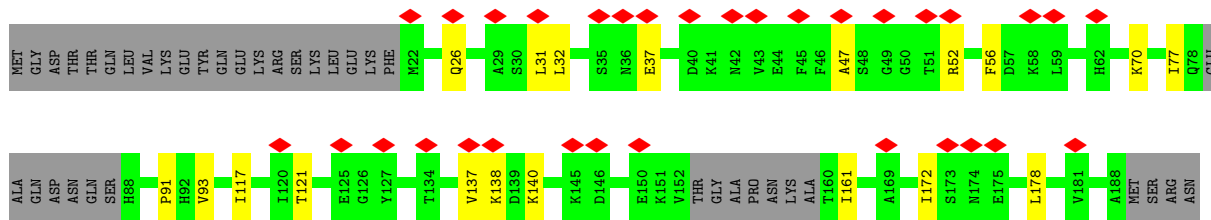

• Molecule 3: Decorator protein P05

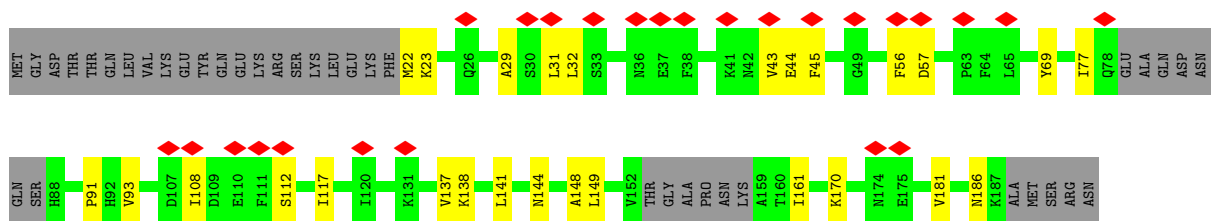

• Molecule 3: Decorator protein P05

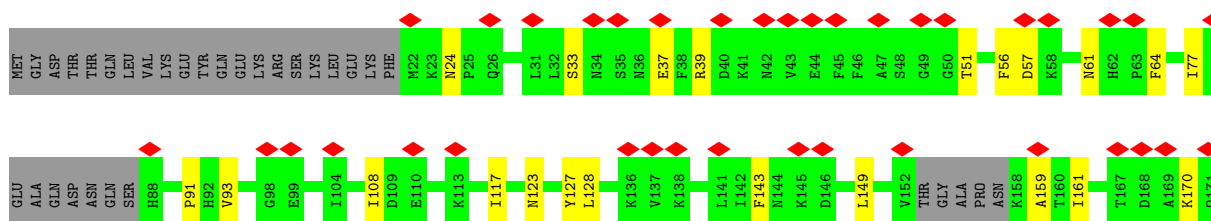

• Molecule 3: Decorator protein P05



• Molecule 3: Decorator protein P05



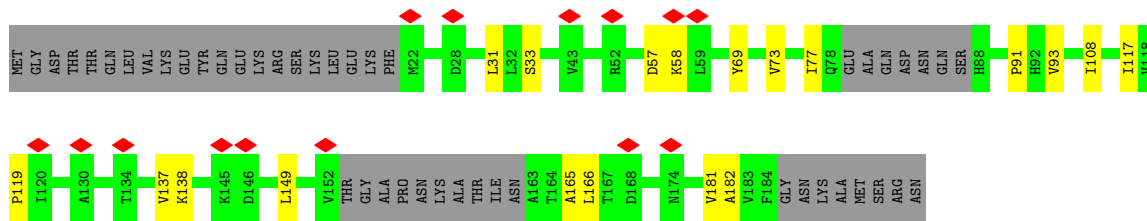

• Molecule 3: Decorator protein P05

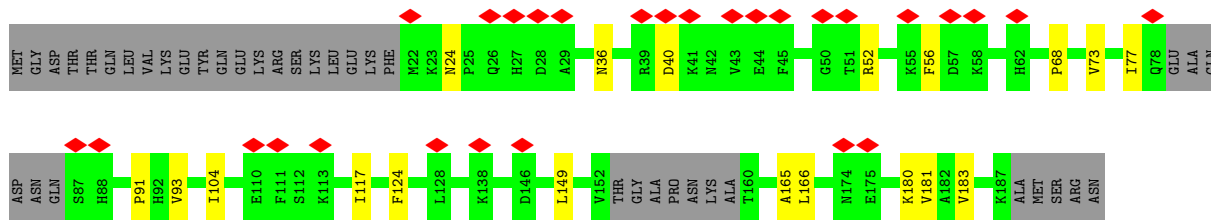

• Molecule 3: Decorator protein P05

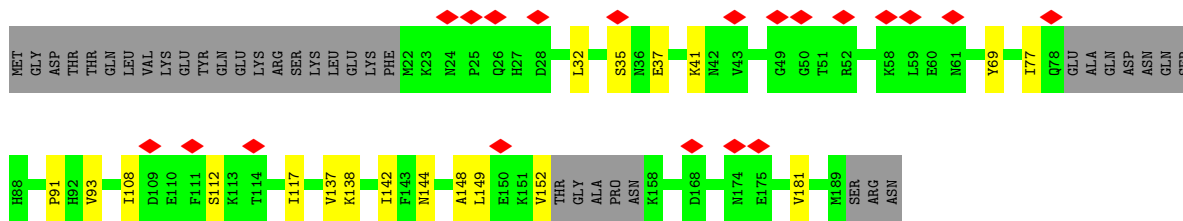
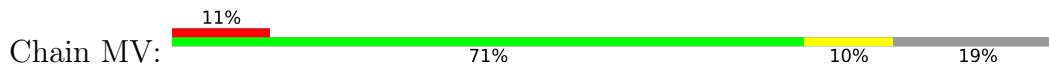

• Molecule 3: Decorator protein P05

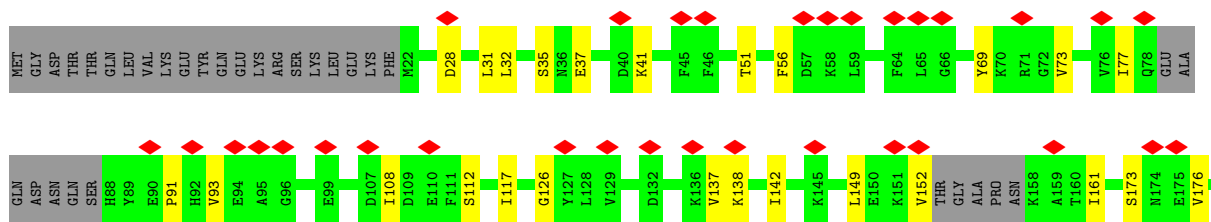

• Molecule 3: Decorator protein P05

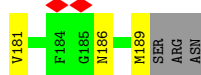

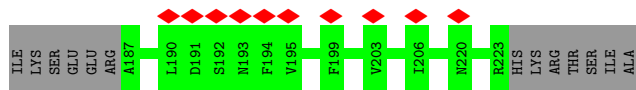

• Molecule 4: Scaffold protein

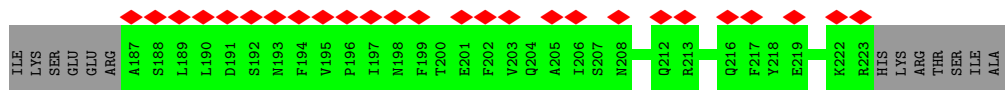
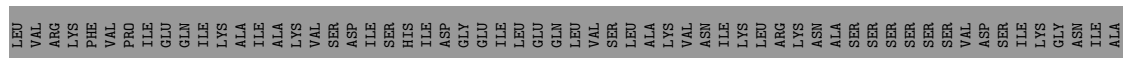
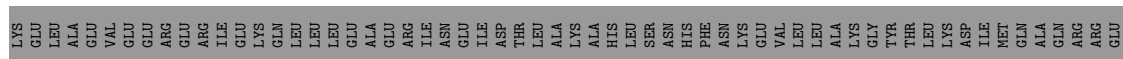
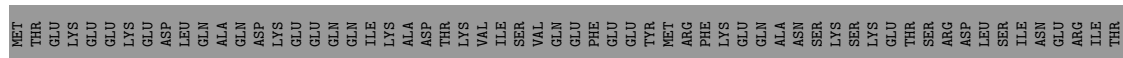

• Molecule 4: Scaffold protein

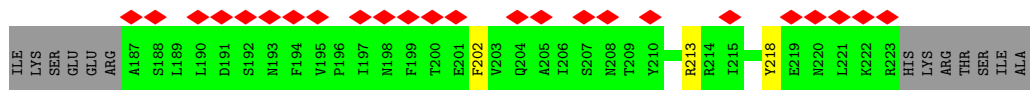
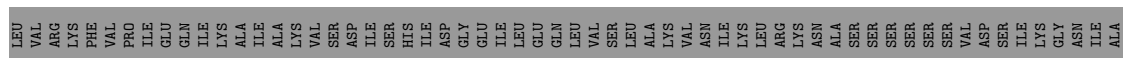
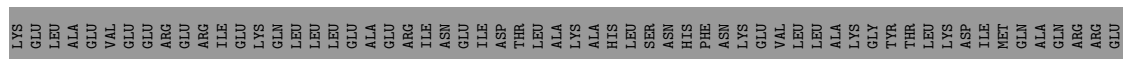
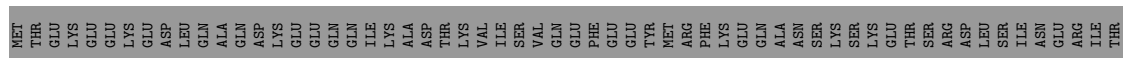

• Molecule 4: Scaffold protein

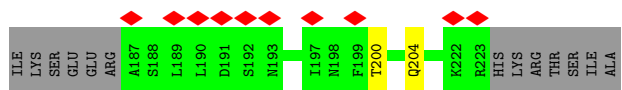
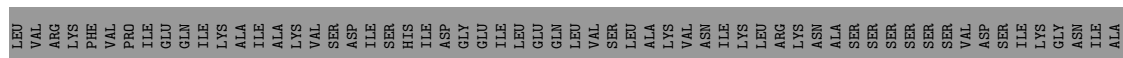
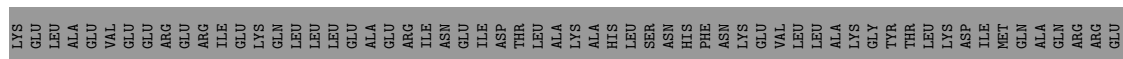
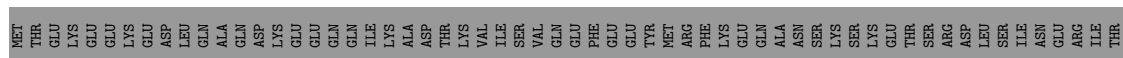

• Molecule 4: Scaffold protein

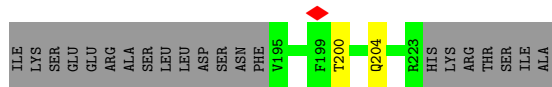

• Molecule 4: Scaffold protein

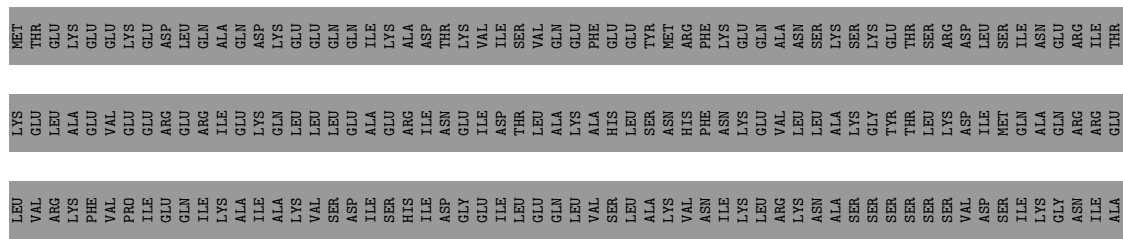

• Molecule 4: Scaffold protein

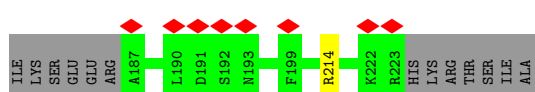
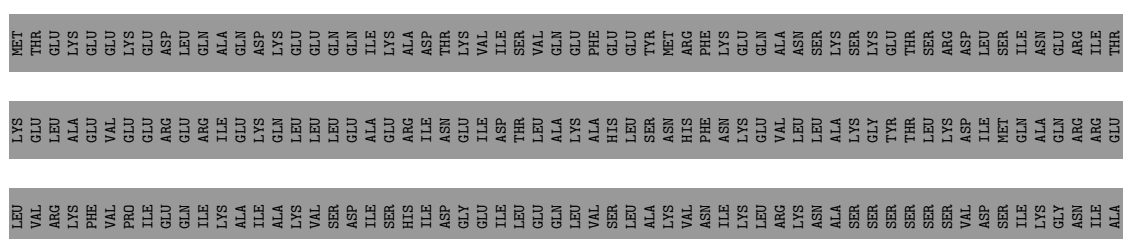

• Molecule 4: Scaffold protein

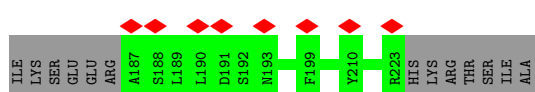
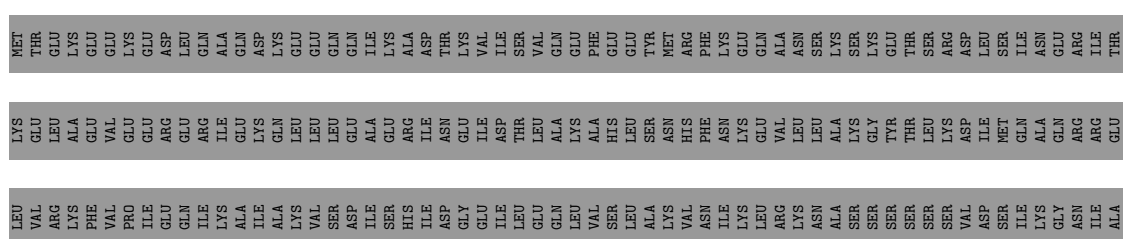

• Molecule 4: Scaffold protein

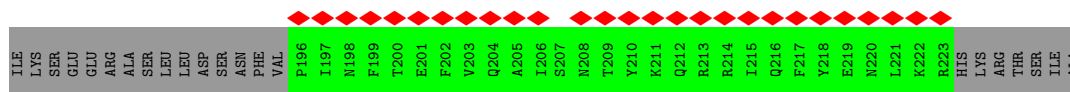

• Molecule 4: Scaffold protein

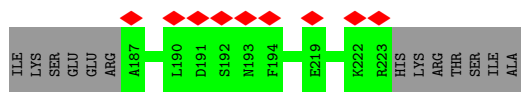
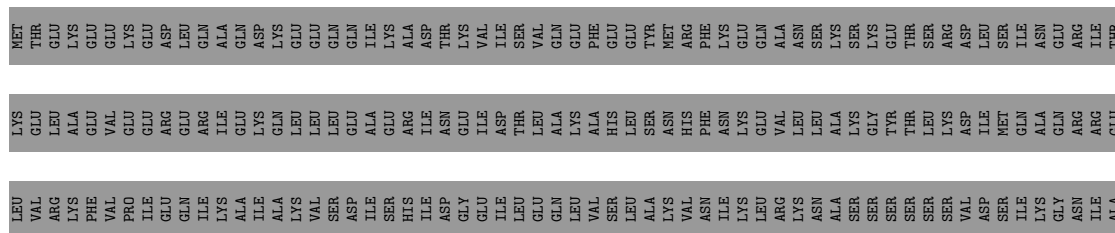

• Molecule 4: Scaffold protein

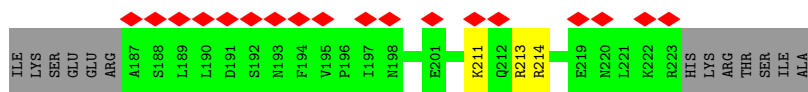
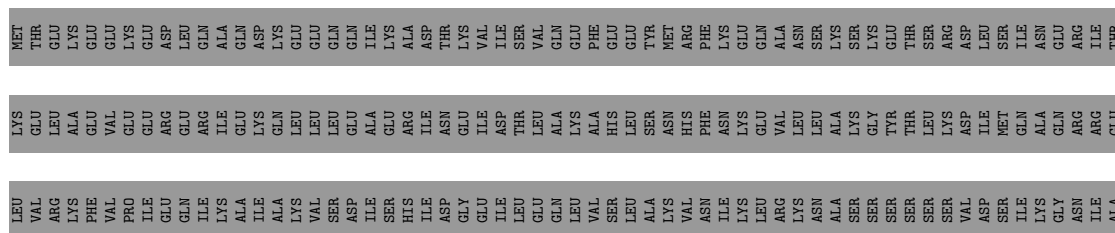

• Molecule 4: Scaffold protein

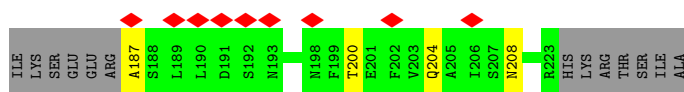
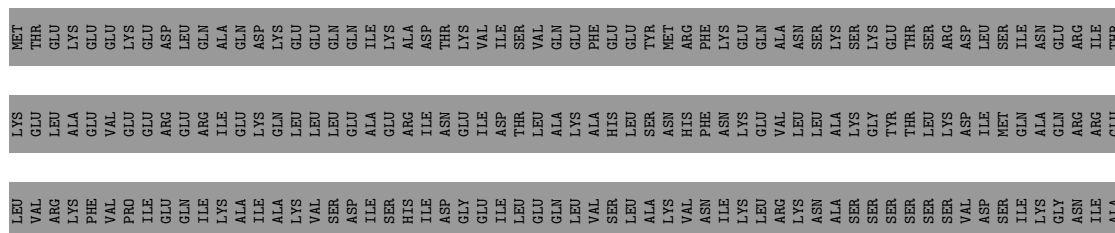

• Molecule 4: Scaffold protein

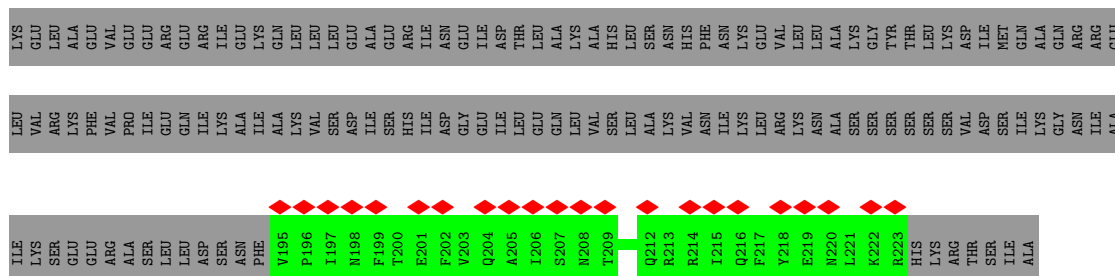

• Molecule 4: Scaffold protein

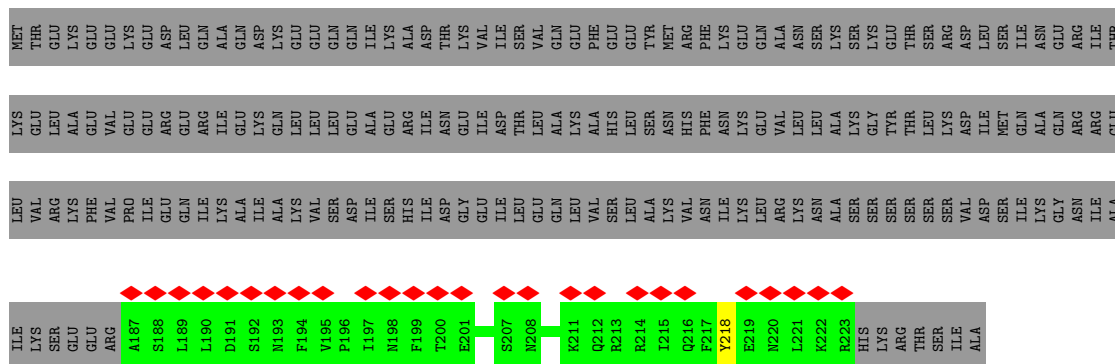

• Molecule 4: Scaffold protein

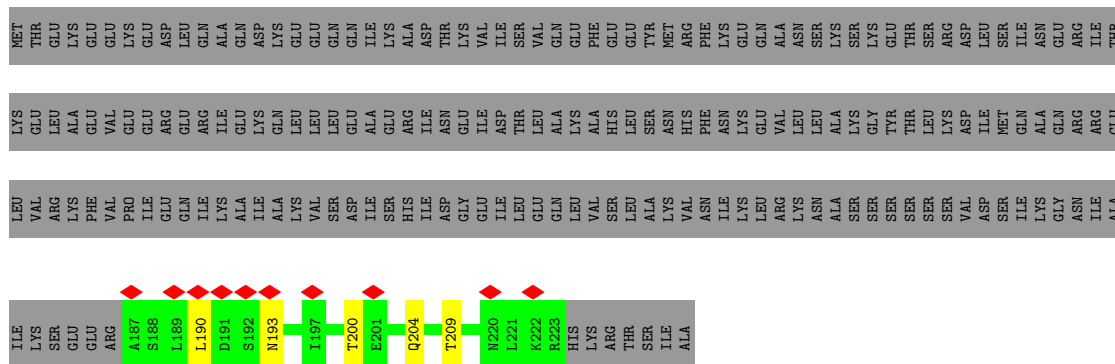

• Molecule 4: Scaffold protein

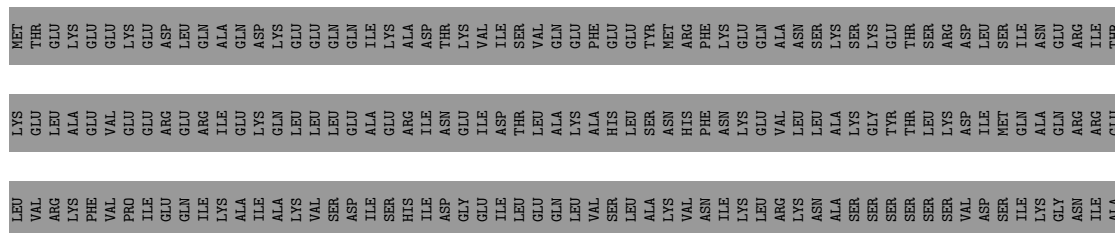

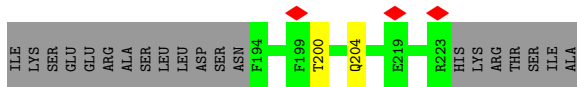

• Molecule 4: Scaffold protein

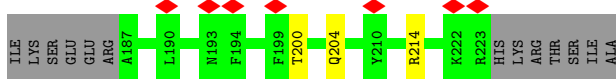
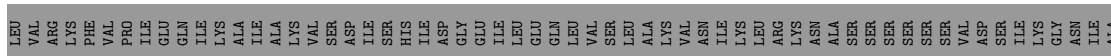
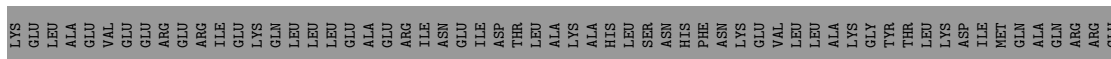
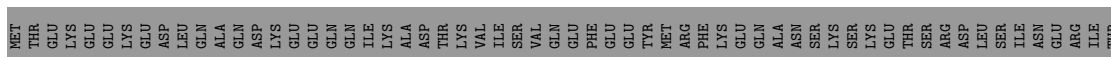

• Molecule 4: Scaffold protein

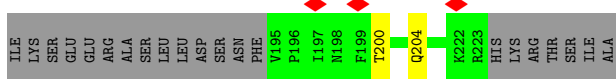
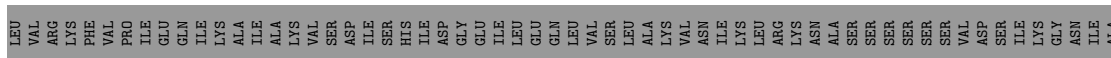
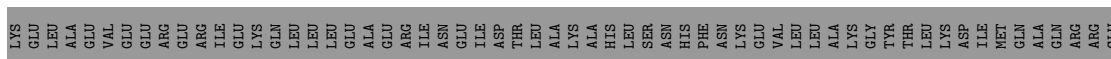
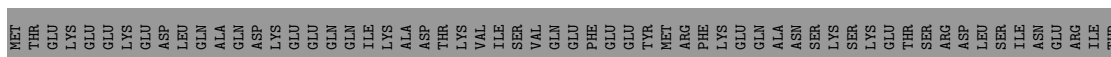

• Molecule 4: Scaffold protein

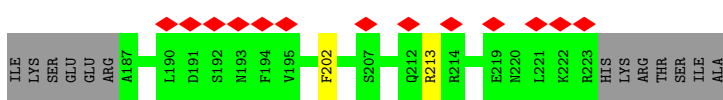
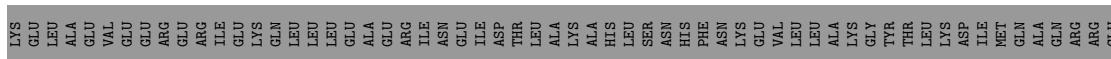
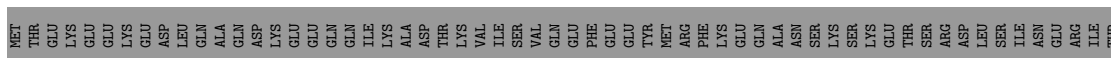

• Molecule 4: Scaffold protein

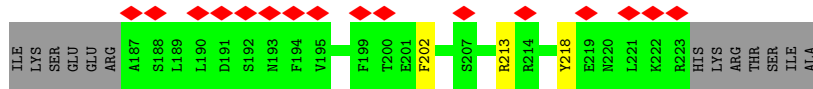

• Molecule 4: Scaffold protein

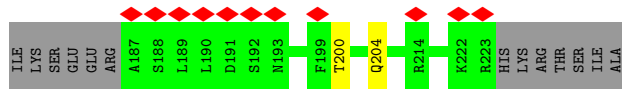
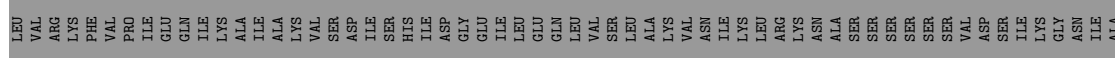
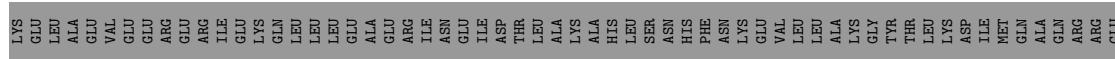

• Molecule 4: Scaffold protein

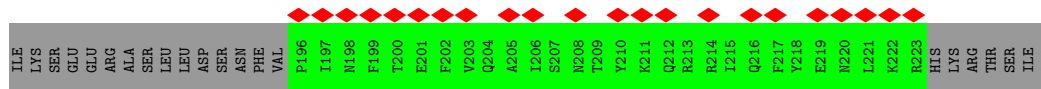
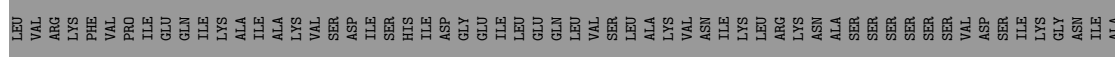
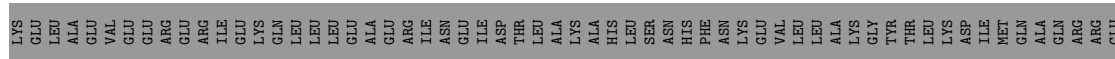

• Molecule 4: Scaffold protein

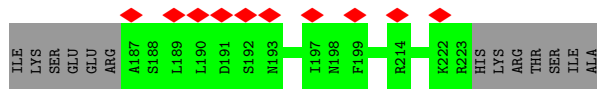
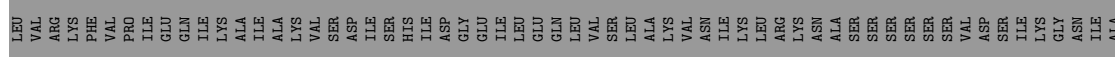
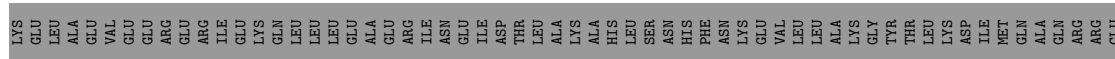

• Molecule 4: Scaffold protein

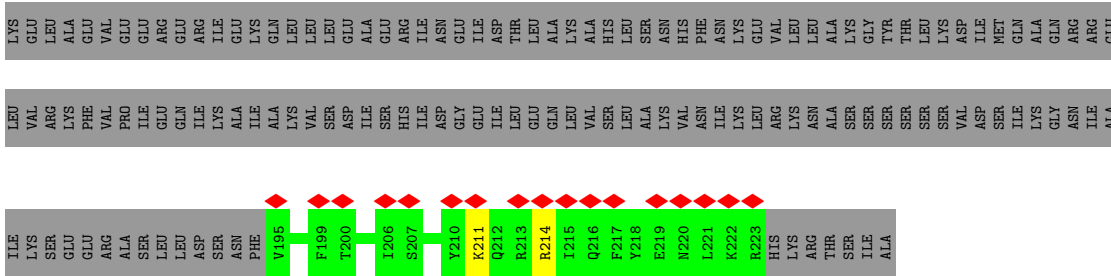

• Molecule 4: Scaffold protein

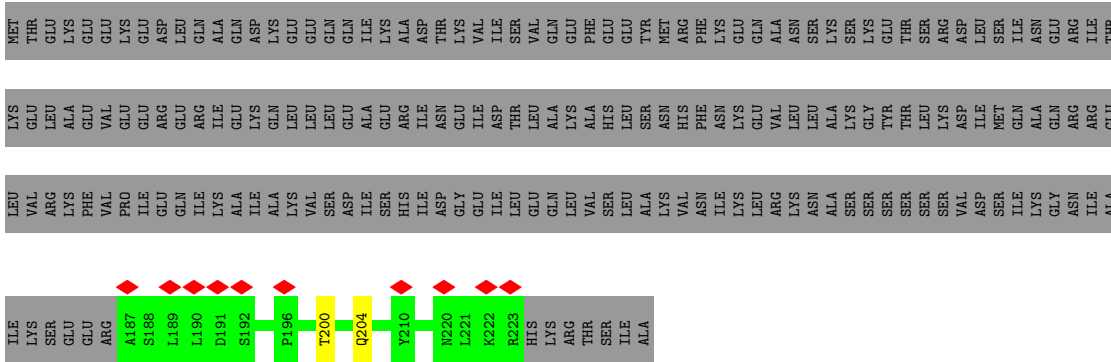

• Molecule 4: Scaffold protein

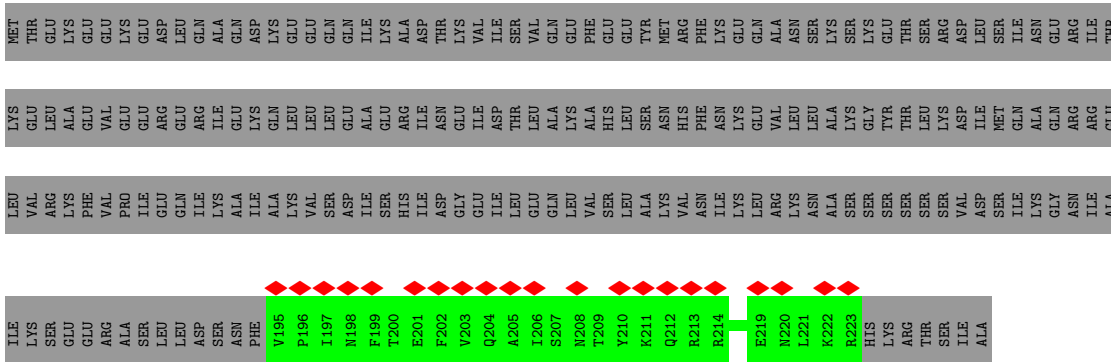

• Molecule 4: Scaffold protein

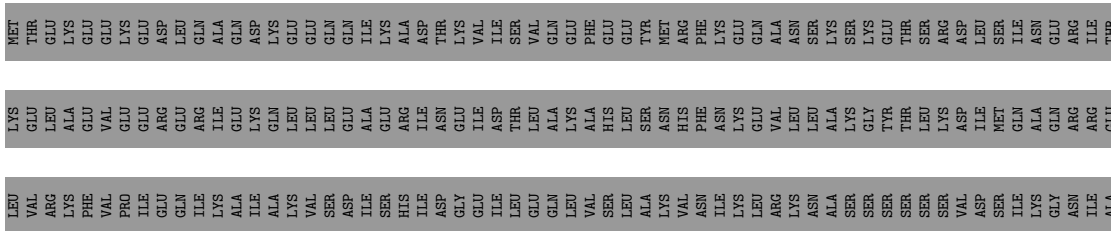

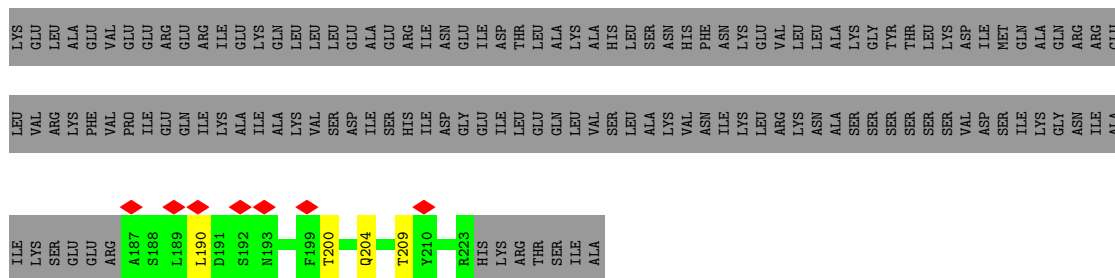

• Molecule 4: Scaffold protein

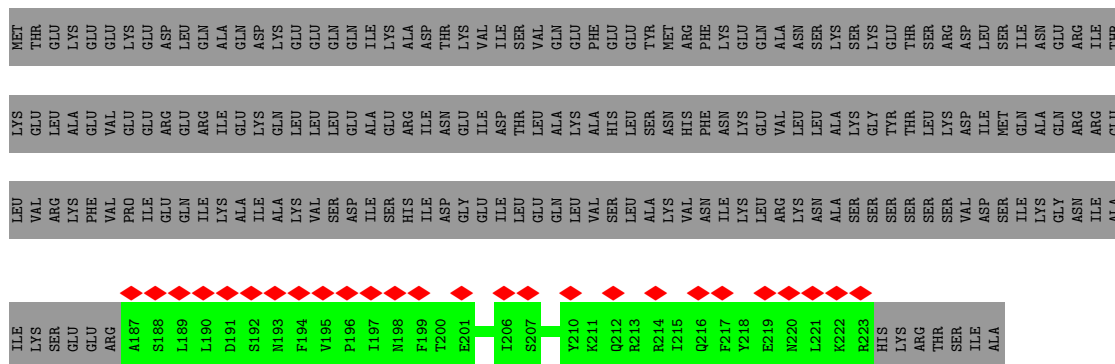

• Molecule 4: Scaffold protein

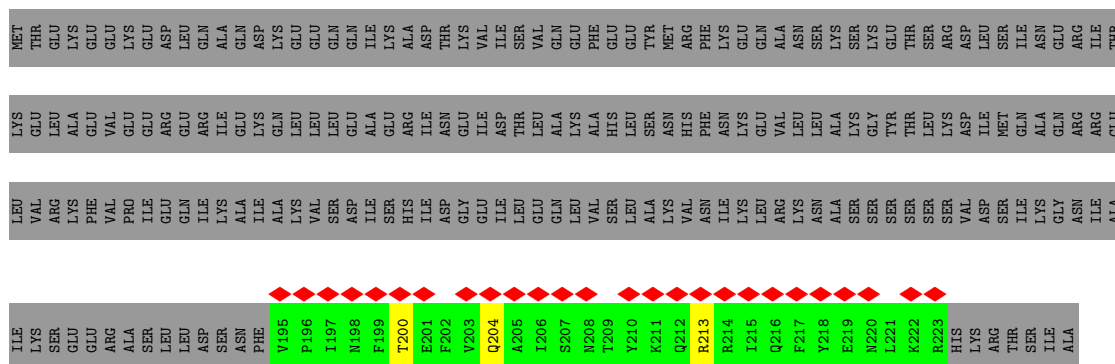

• Molecule 4: Scaffold protein

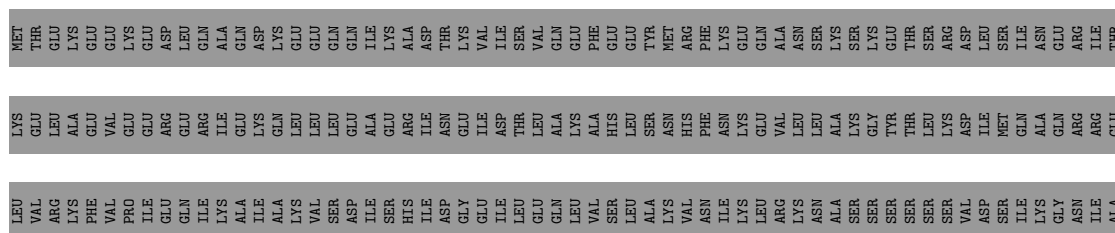

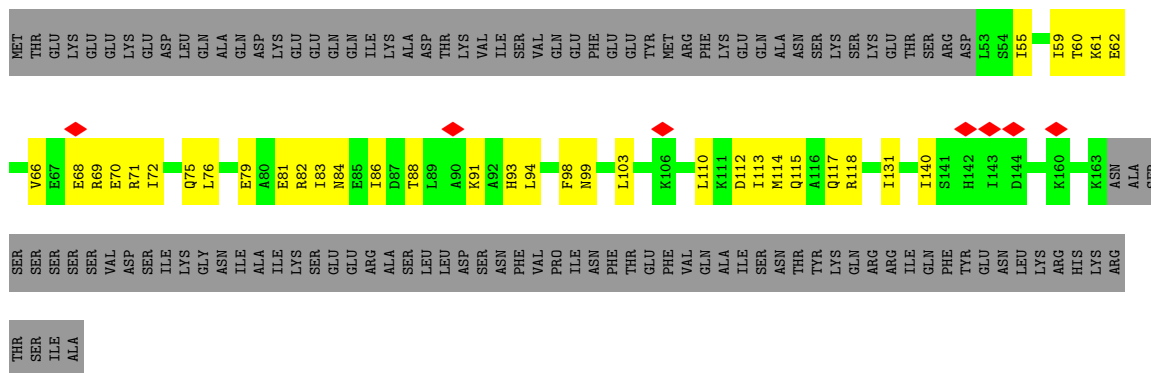

• Molecule 4: Scaffold protein

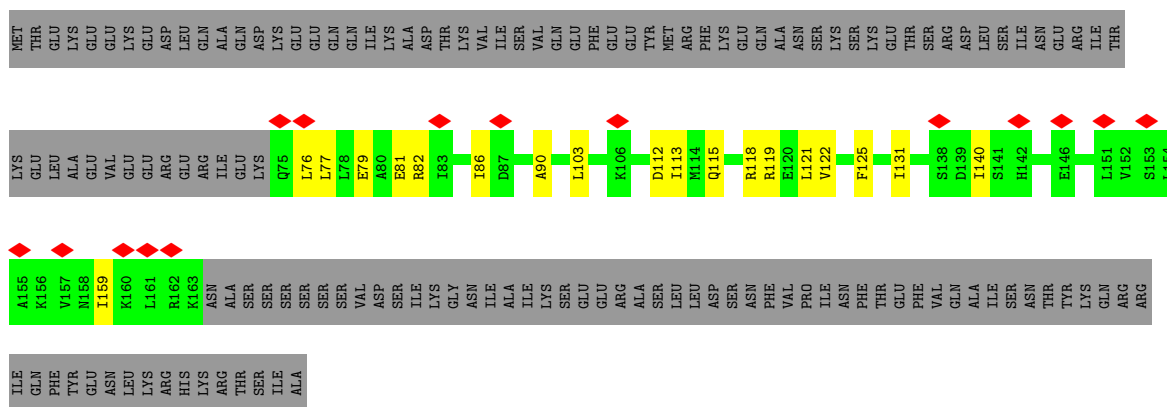

• Molecule 4: Scaffold protein

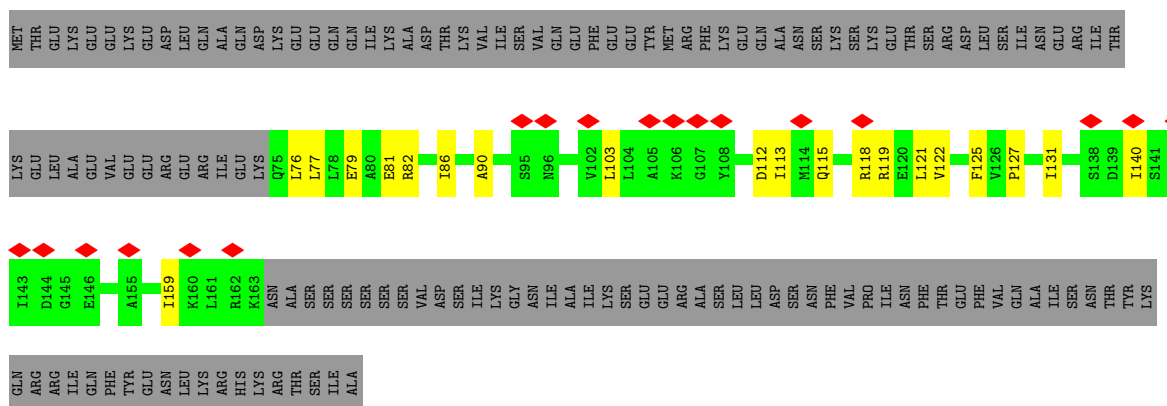

• Molecule 4: Scaffold protein

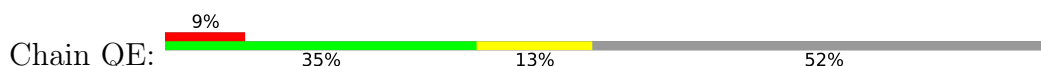

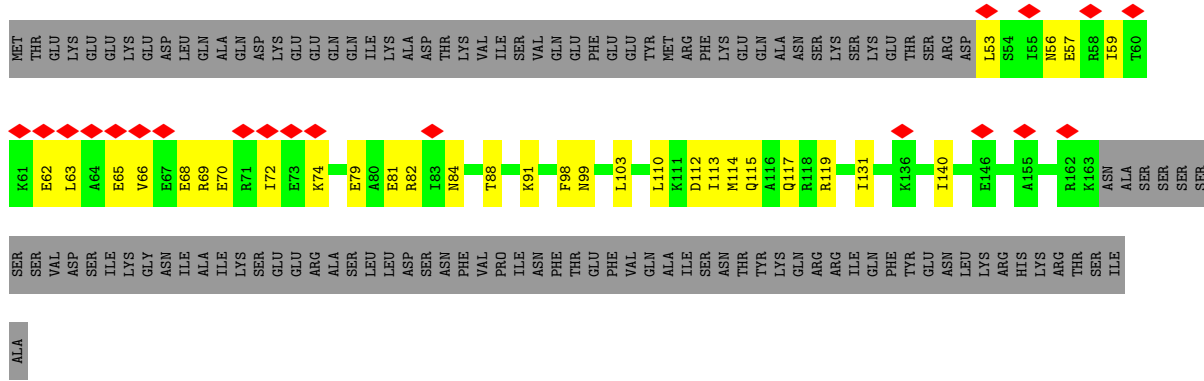

• Molecule 4: Scaffold protein

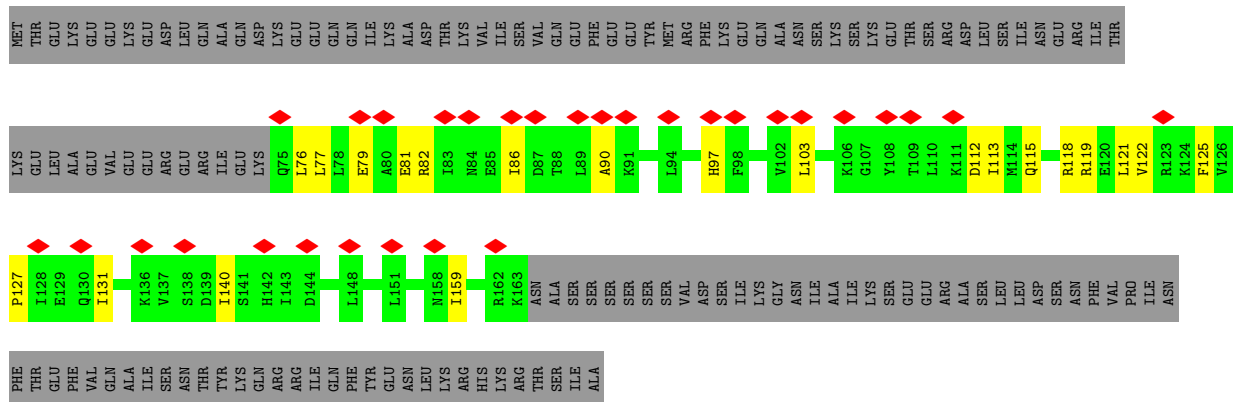

• Molecule 4: Scaffold protein

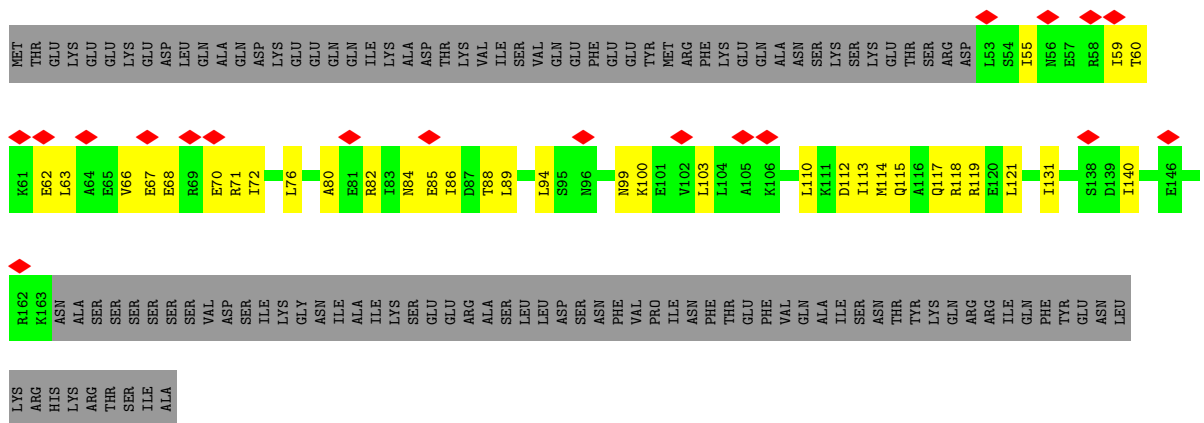
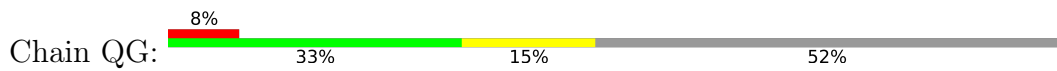

• Molecule 4: Scaffold protein

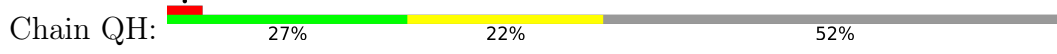

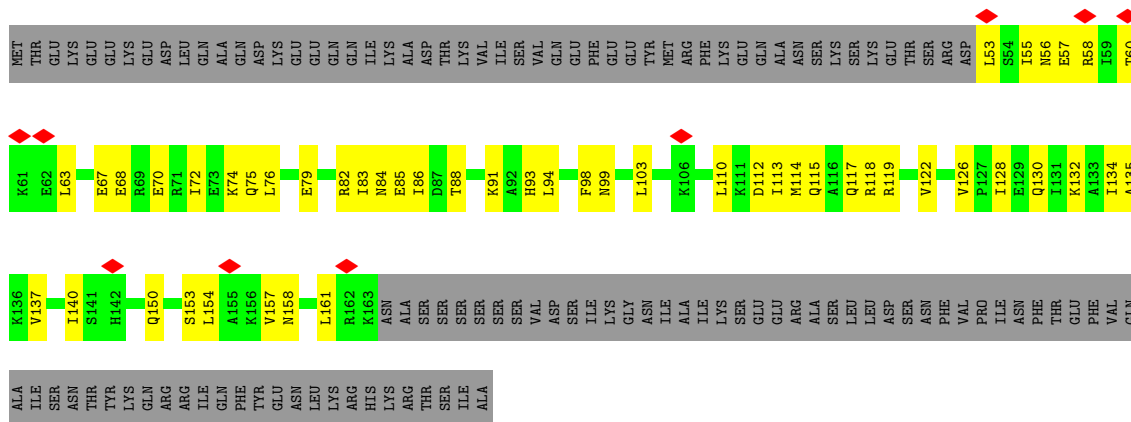

• Molecule 4: Scaffold protein

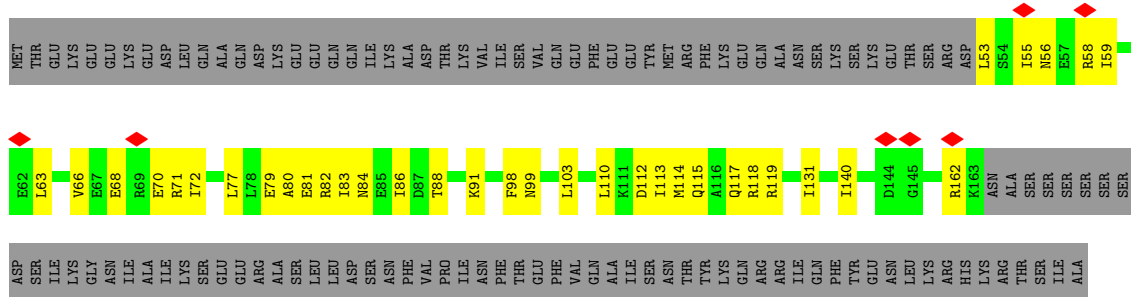
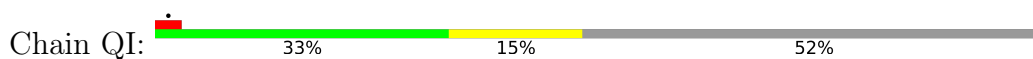

• Molecule 4: Scaffold protein

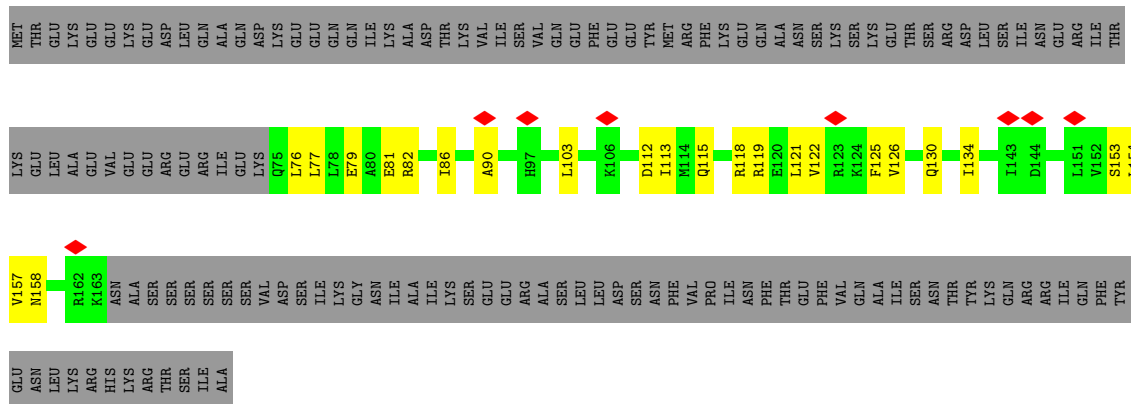

• Molecule 4: Scaffold protein

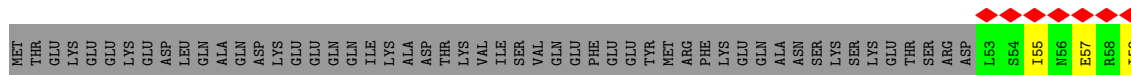
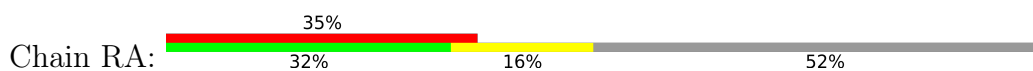

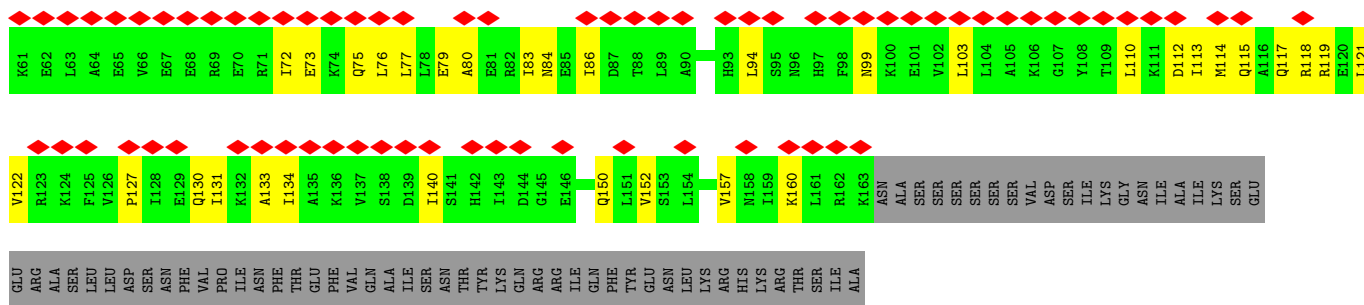

• Molecule 4: Scaffold protein

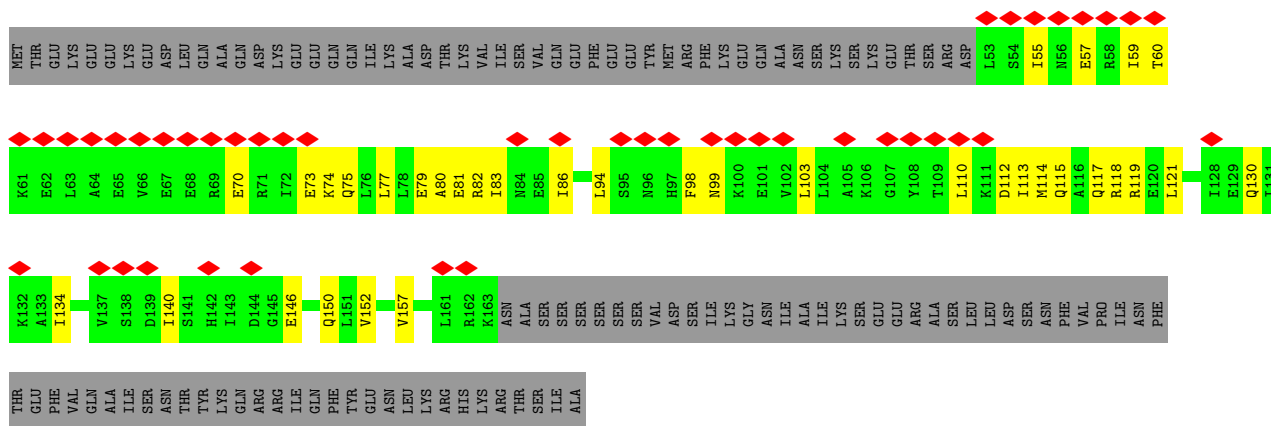
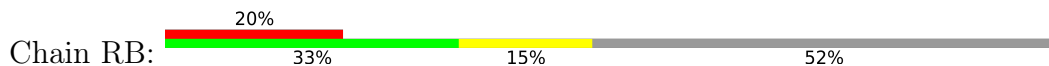

• Molecule 4: Scaffold protein

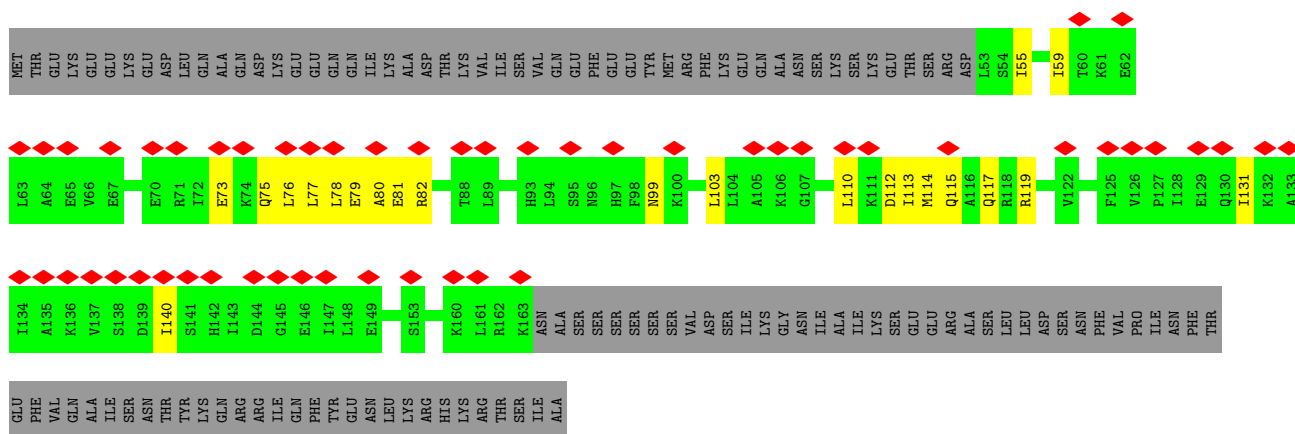
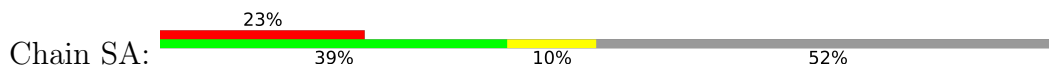

• Molecule 4: Scaffold protein



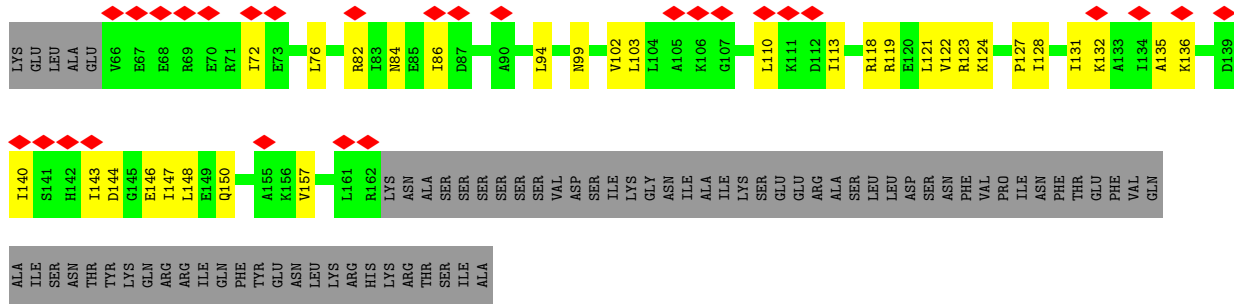

• Molecule 4: Scaffold protein

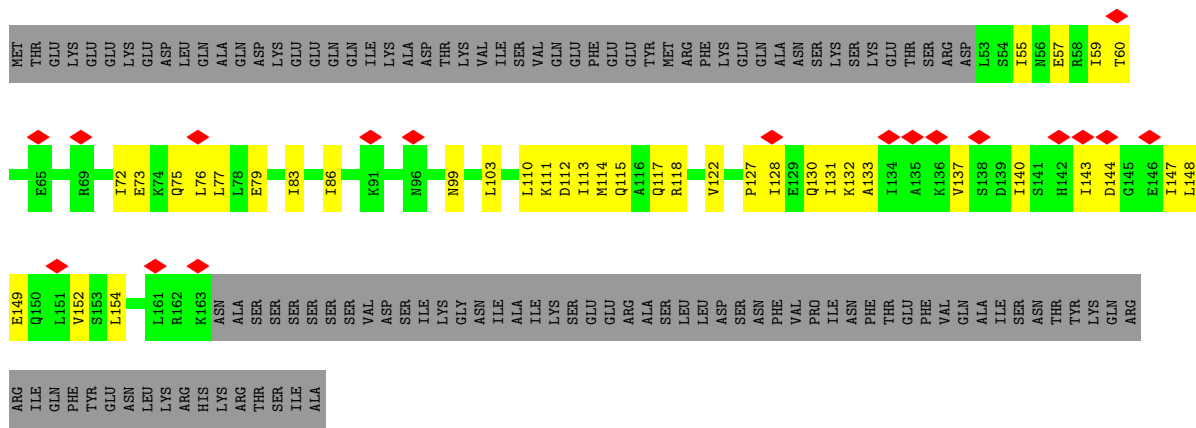
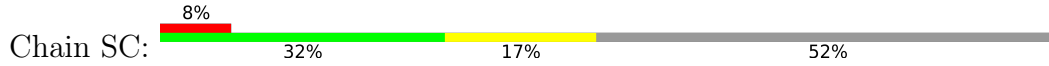

• Molecule 4: Scaffold protein

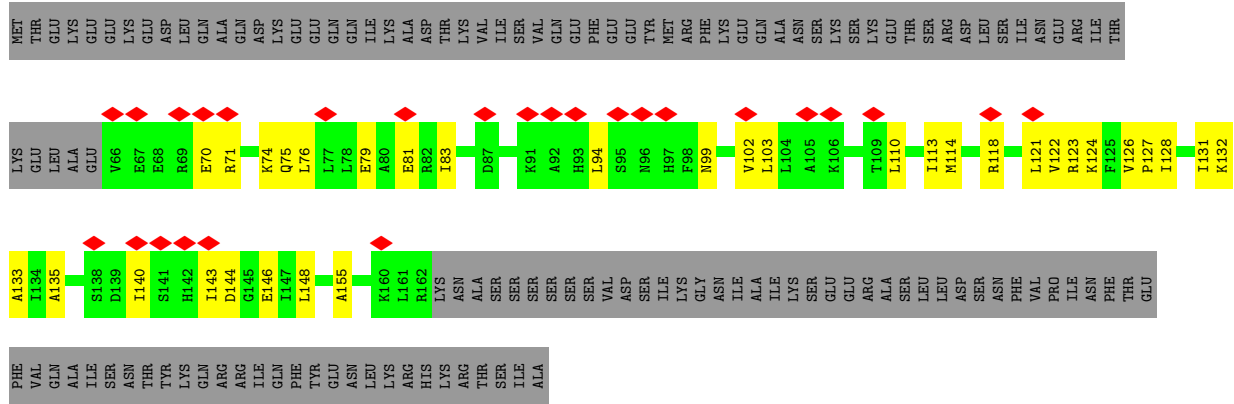

• Molecule 4: Scaffold protein

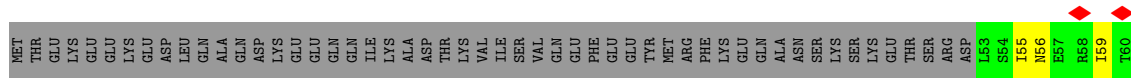
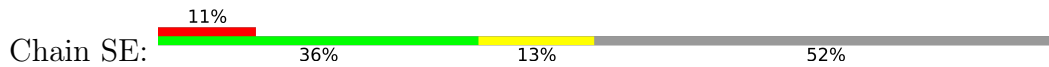

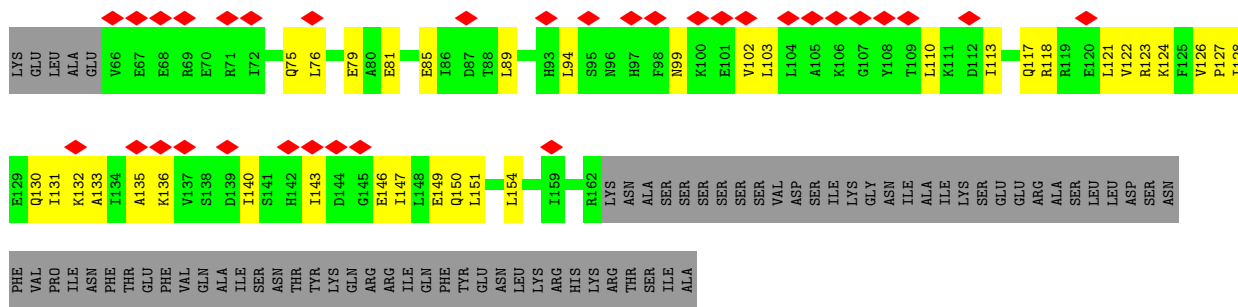

• Molecule 4: Scaffold protein

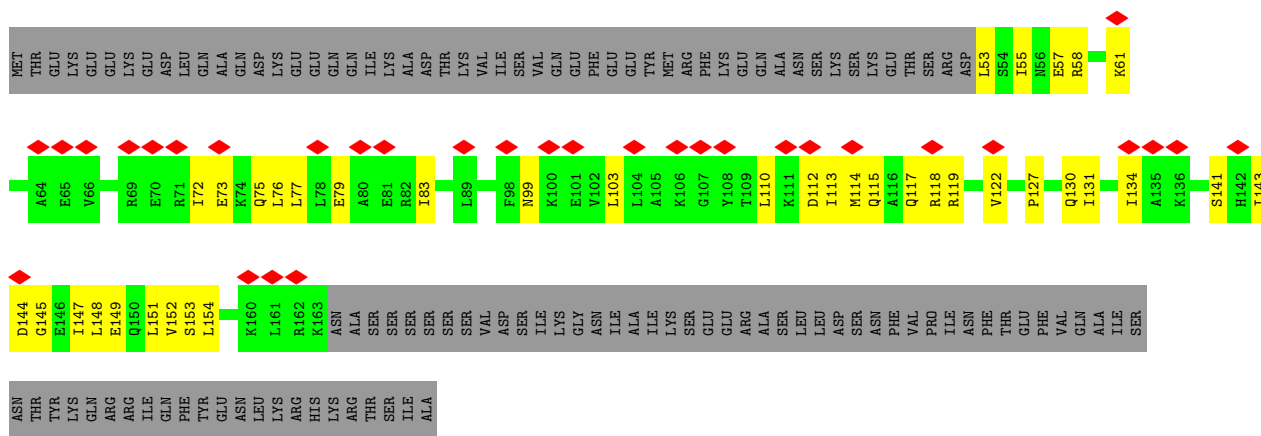
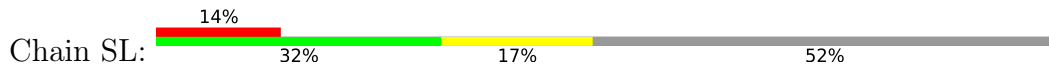

• Molecule 4: Scaffold protein

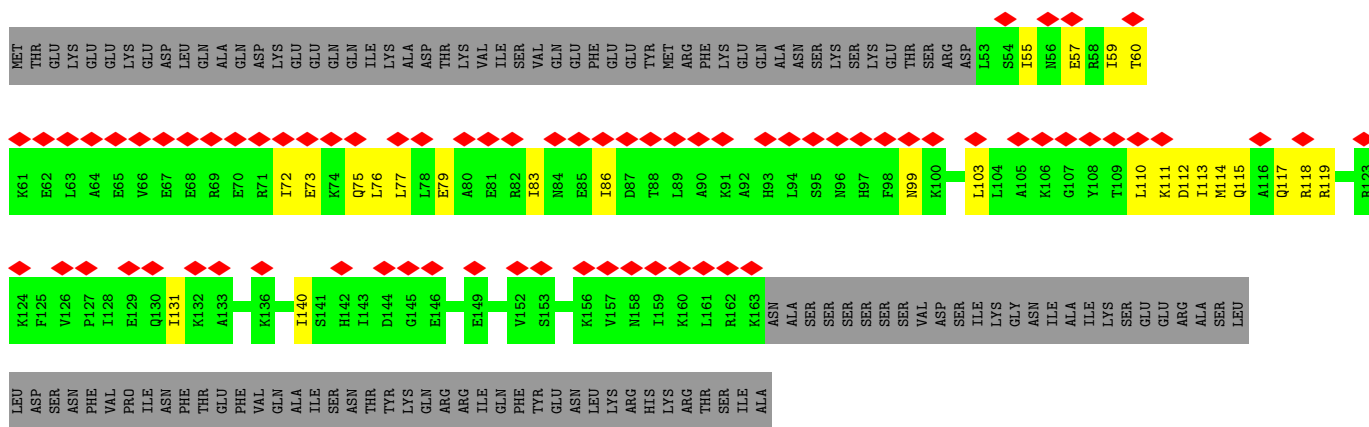
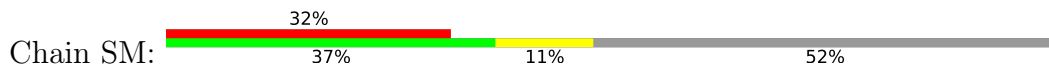

• Molecule 4: Scaffold protein

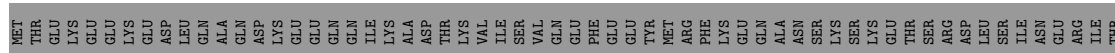

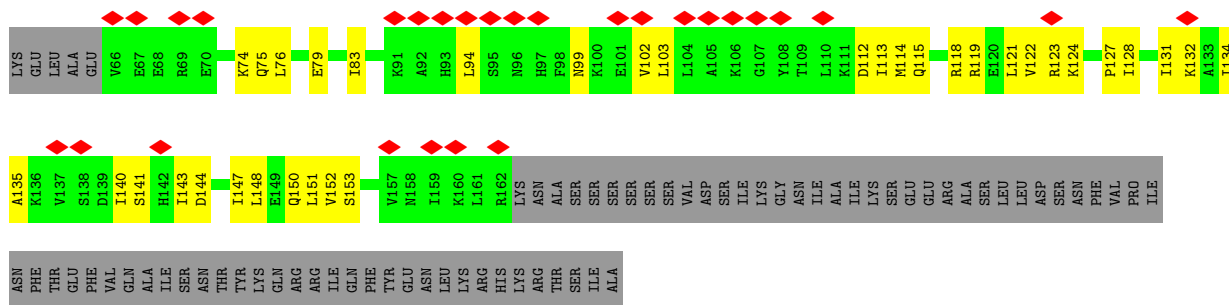

• Molecule 4: Scaffold protein

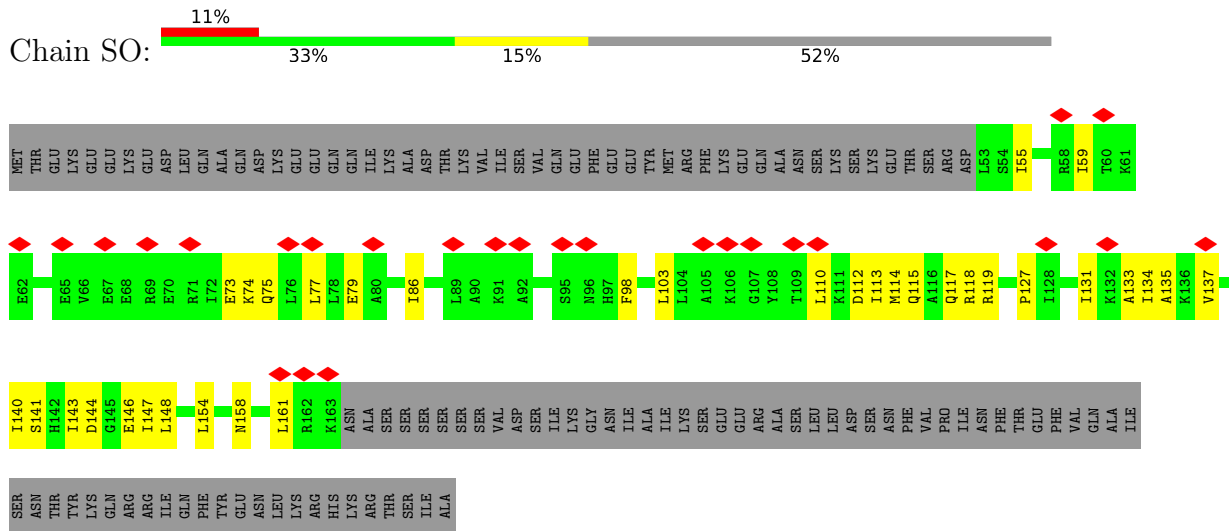

• Molecule 4: Scaffold protein

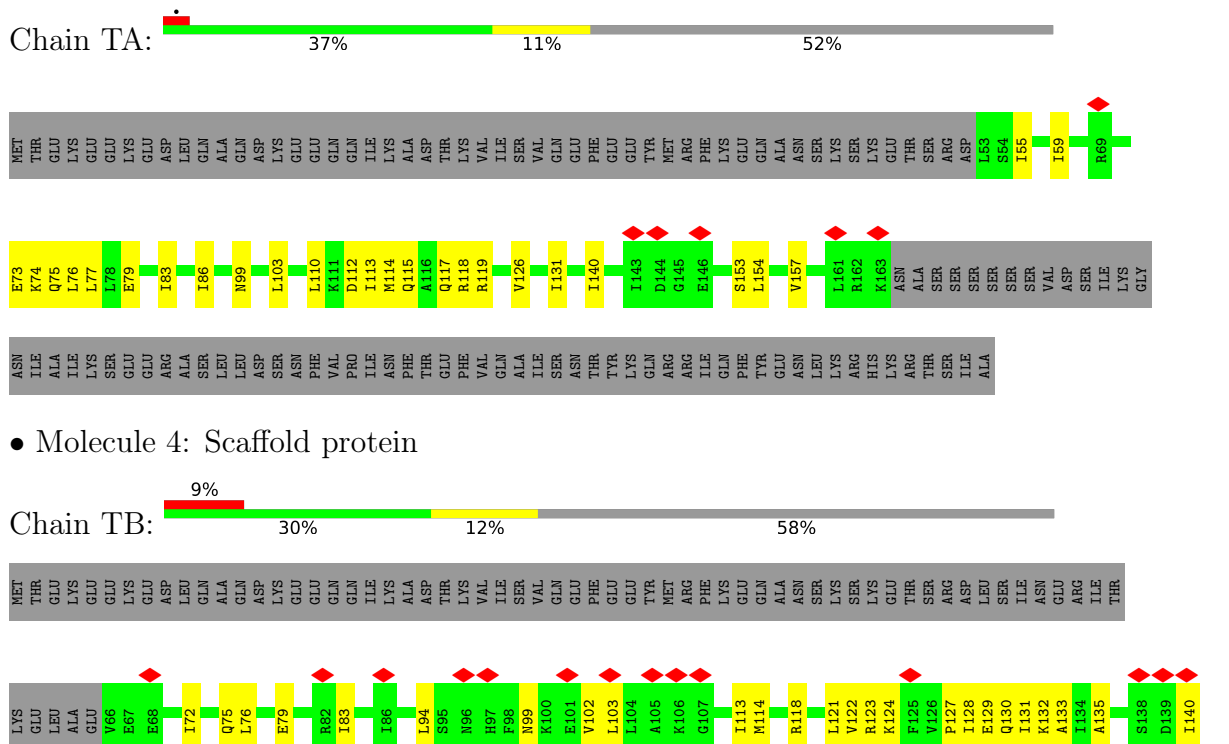

• Molecule 4: Scaffold protein

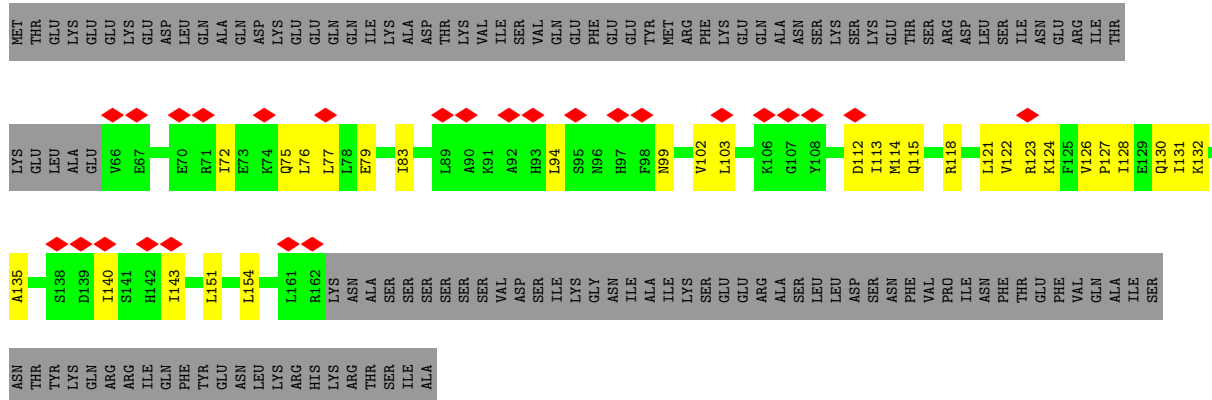
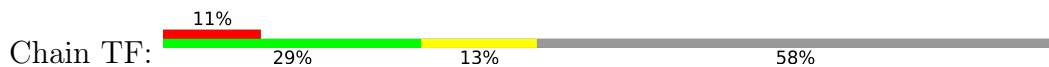

• Molecule 4: Scaffold protein

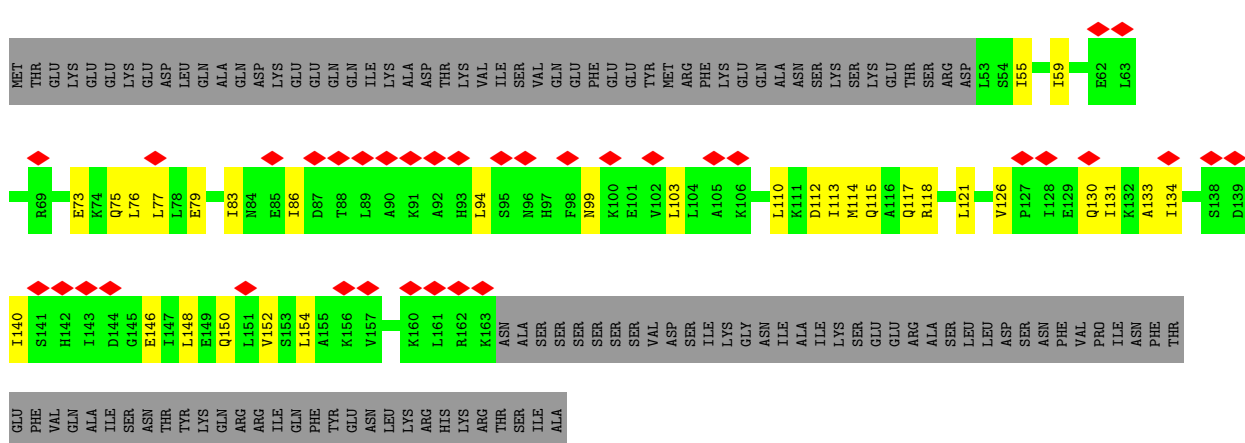
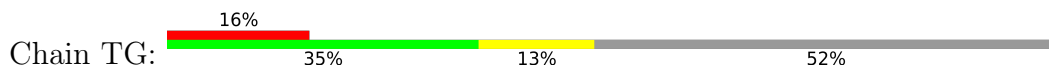

• Molecule 4: Scaffold protein

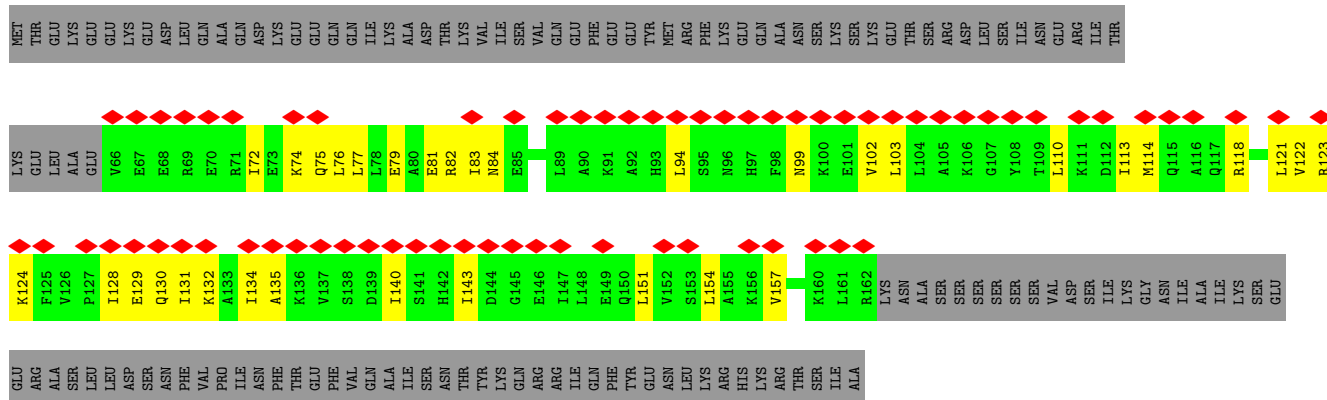

• Molecule 4: Scaffold protein

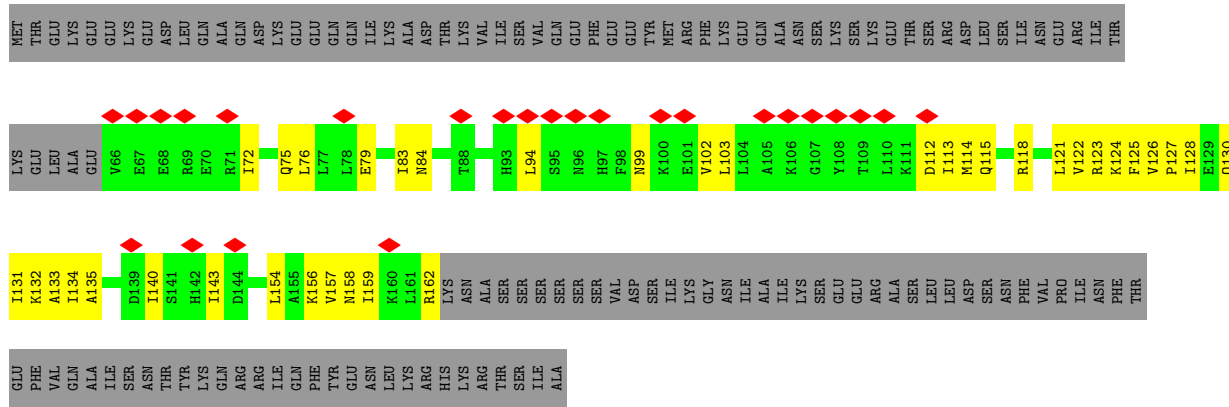

• Molecule 4: Scaffold protein

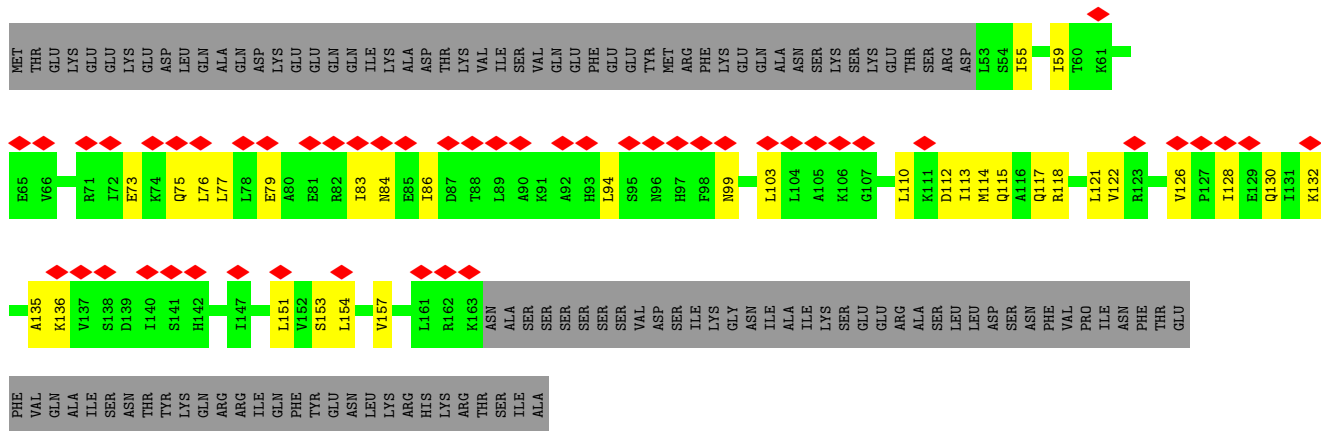
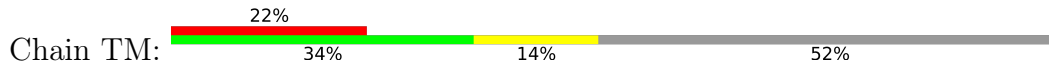

• Molecule 4: Scaffold protein

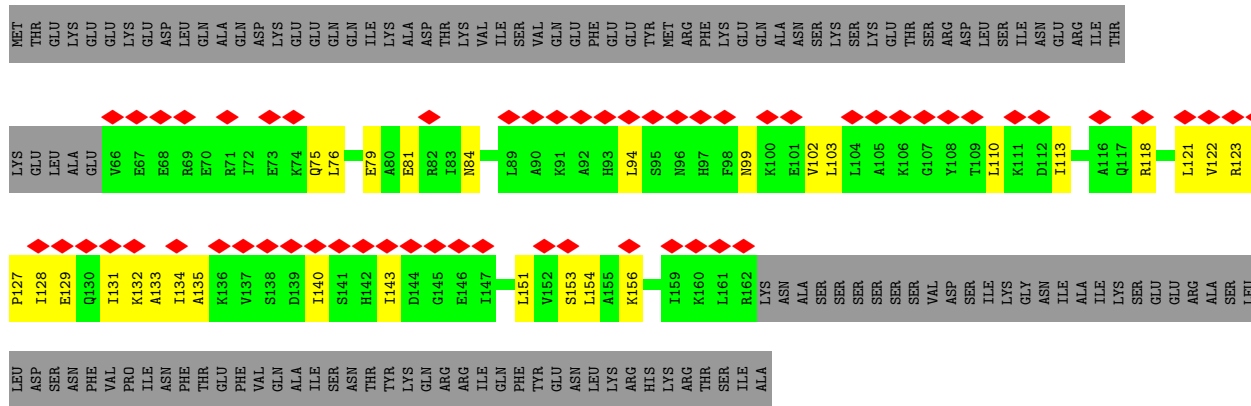
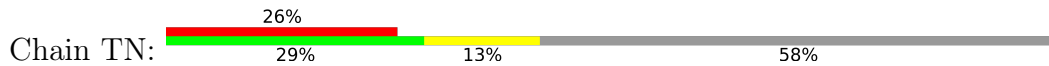

• Molecule 4: Scaffold protein

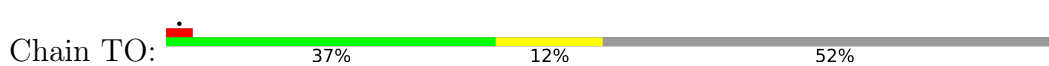

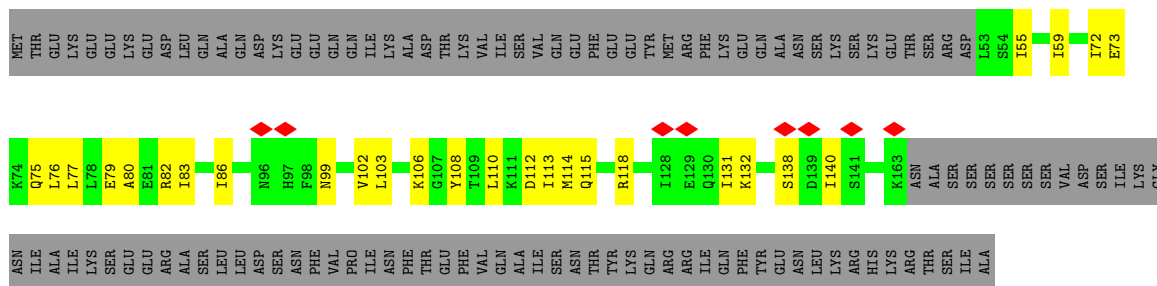

• Molecule 4: Scaffold protein

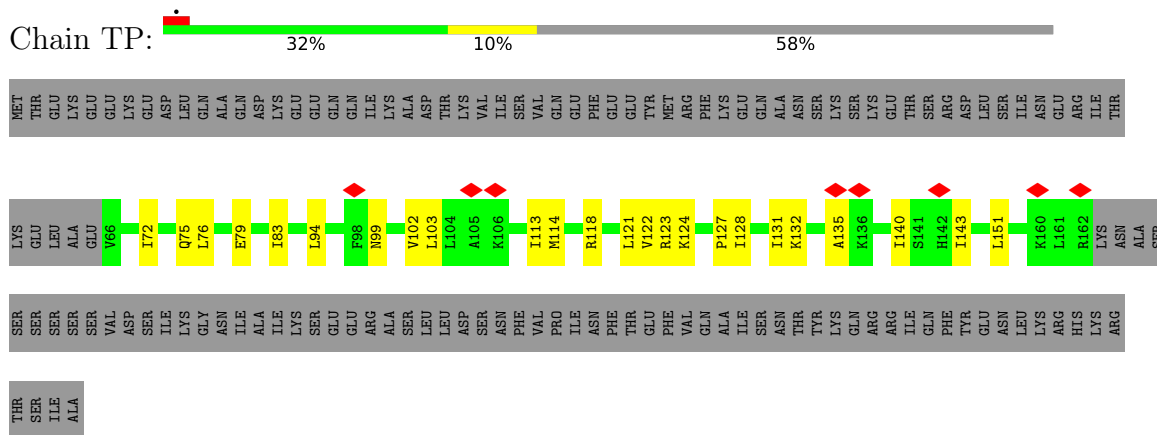

• Molecule 4: Scaffold protein

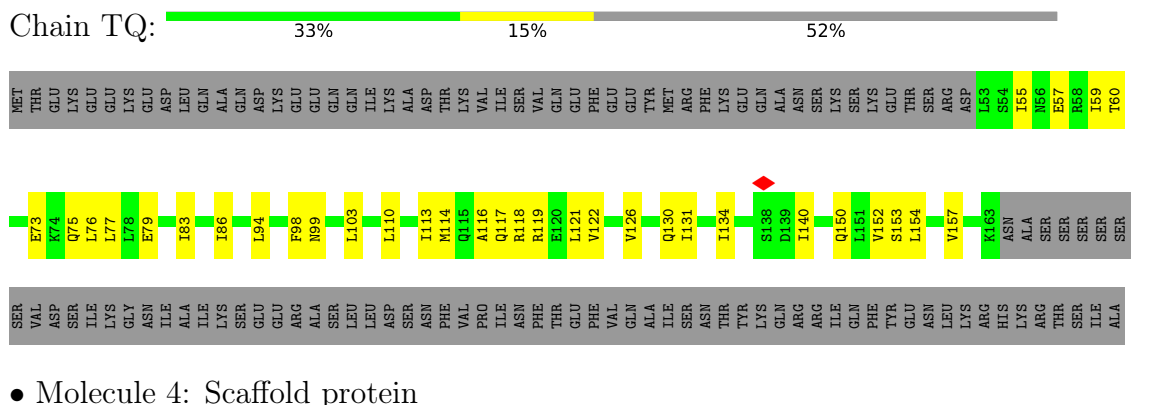

• Molecule 4: Scaffold protein

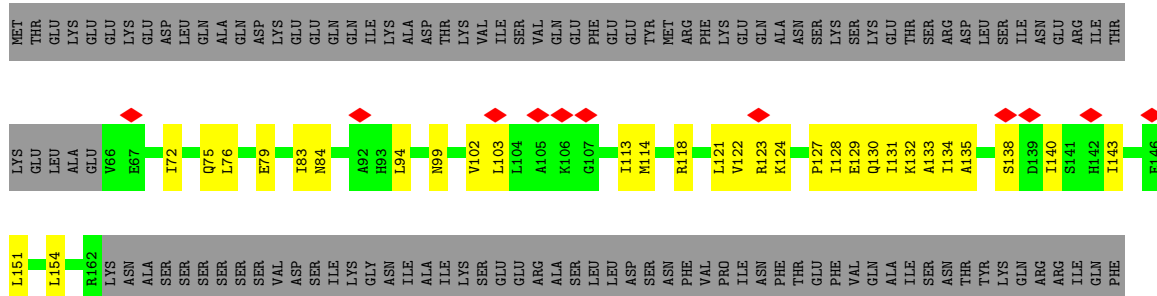

TYR
GLU
ASN
LEU
LYS
ARG
HIS
LYS
ASP
ARG
THR
SER
ILE
ALA

• Molecule 4: Scaffold protein

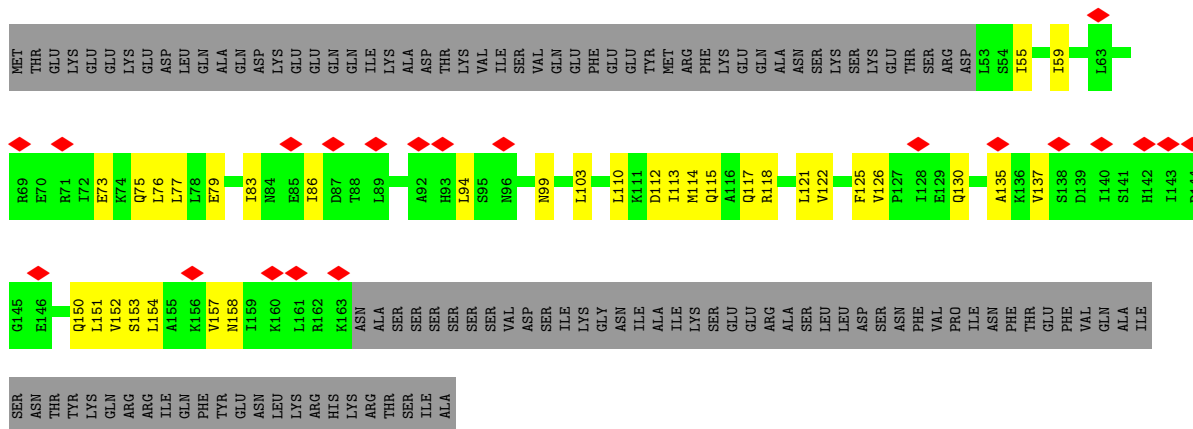
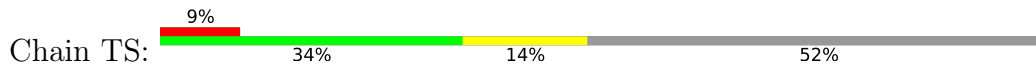

• Molecule 4: Scaffold protein

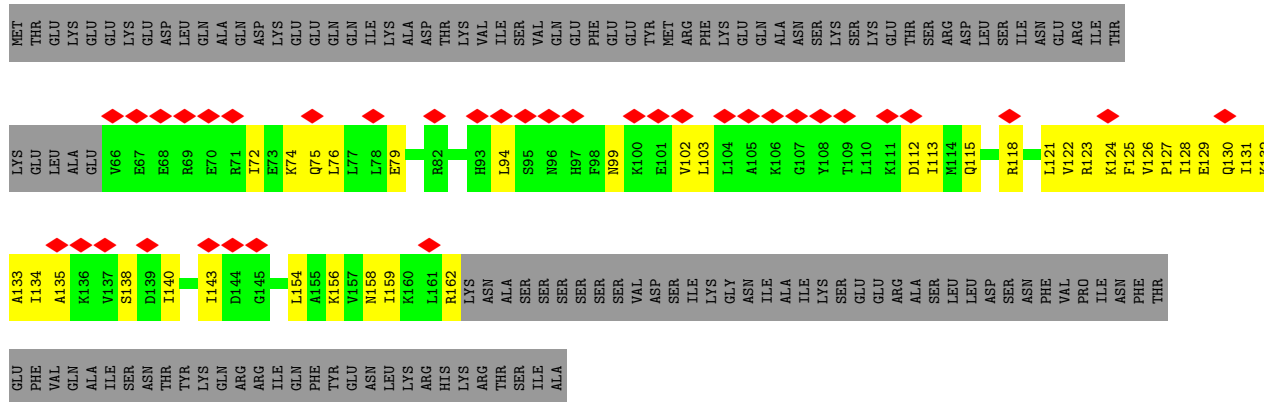
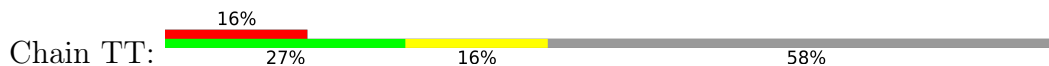

• Molecule 4: Scaffold protein

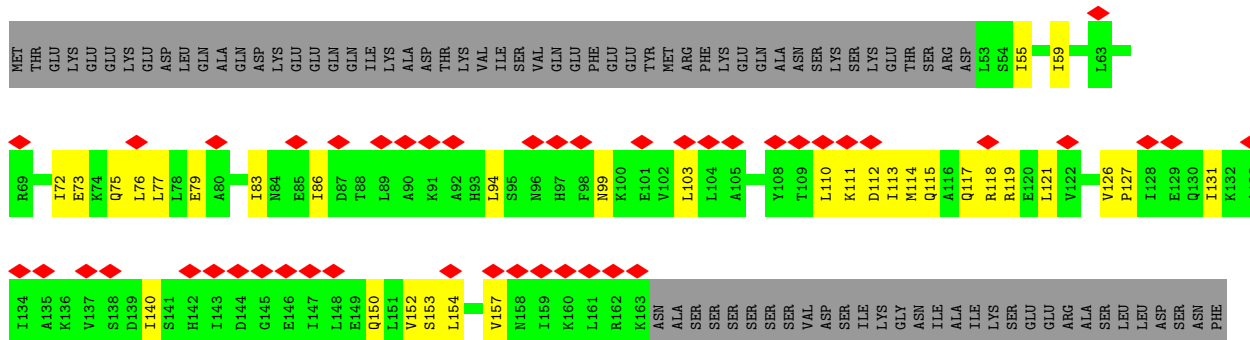
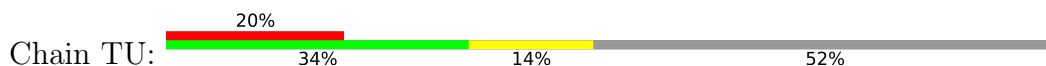

VAL PRO ILE ASN PHE THR PHE PHE VAL VAL GLN ALA ILE SER ASN THR THR LYS LYS LYS ARG ARG ILE ILE GLN PHE PHE TYR TYR VAL ASN ASN LEU LYS LYS HIS ARG LYS LYS ARG THR THR SER SER ILE ILE ALA

● Molecule 4: Scaffold protein



MET THR LYS LEU ALA GLU P66 P67 P68 P69 P70 P71 P72 P73 P74 P75 P76 P77 P78 P79 P80 P81 P82 P83 P84 P85 P86 P87 P88 P89 P90 P91 P92 P93 P94 P95 P96 P97 P98 P99 K100 K101 V102 V103 L104 L105 K106 K107 L108 L109 L110 L111 D112 L113 M114 Q115 A116 Q117 R118 L121

LYS LEU ALA GLU P66 P67 P68 P69 P70 P71 P72 P73 P74 P75 P76 P77 P78 P79 P80 P81 P82 P83 P84 P85 P86 P87 P88 P89 P90 P91 P92 P93 P94 P95 P96 P97 P98 P99 K100 K101 V102 V103 L104 L105 K106 K107 L108 L109 L110 L111 D112 L113 M114 Q115 A116 Q117 R118 L121

V122 R123 K124 F125 V126 P127 I128 E129 Q130 I131 K132 A133 A134 A135 K136 V137 S138 D139 I140 S141 H142 H143 D144 E145 E146 I147 L148 E149 Q150 L151 V152 S153 K156 V157 M158 I159 K160 K161 L161 LYS ASN ALA SER SER SER SER SER VAL ASP SER ILE LYS GLY ASN ILE ALA ILE LYS

SER GLU ARG ALA SER LEU LEU ASP SER PHE VAL PRO ILE PHE THR THR VAL ALA THR SER ASN THR TYR MET ARG PHE LEU GLN ARG HIS LYS ASN THR SER ARG THR SER ILE ALA

● Molecule 4: Scaffold protein

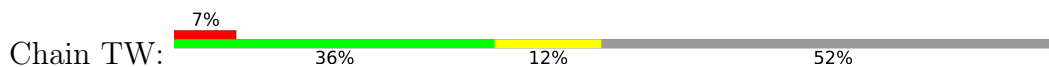

MET THR LYS LEU ASP GLN ALA GLN ASP LYS LEU GLN ILE LYS ALA ASP THR LYS VAL ALA THR LYS LEU GLN ARG HIS ASN THR SER ARG ASP L53 S54 I55 I59 A64

R69 Q75 L76 E79 I83 N84 H93 L94 S95 N96 H97 V102 L103 K106 G107 Y108 I109 K111 D112 M114 Q115 Q117 R118 E119 E120 L121 V126 P127 I128 E129 Q130 I131 K132 A133 K136 V137 S138 D139 I140 L154 V157 K160 L161 R162 K163 ASN

ALA SER SER SER SER VAL ASP ILE ILE GLY ASN ILE ILE LYS SER GLU ARG ALA THR SER LEU LEU ASP SER PHE VAL PRO ILE ILE ASN PHE THR ARG PHE VAL GLN ALA ILE ILE ASN THR LYS SER ARG ARG ILE PHE TYR TYR GLN ARG ARG ASP LEU SER TYR GLU ASN LEU LYS ARG HIS

LYS ARG THR SER ILE ALA

● Molecule 4: Scaffold protein

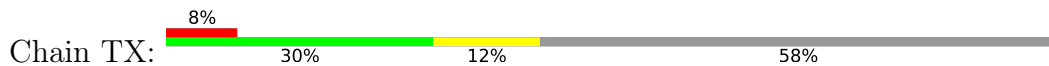

MET THR LYS LEU ALA GLU P66 P67 P68 P69 P70 P71 P72 P73 P74 P75 P76 P77 P78 P79 P80 P81 P82 P83 P84 P85 P86 P87 P88 P89 P90 P91 P92 P93 P94 P95 P96 P97 P98 P99 K100 K101 V102 V103 L104 L105 K106 K107 L108 L109 L110 L111 D112 M114 Q115 A116 Q117 R118 I113 M114 R118 L121 V122 R123 K124 F125 V126 P127 I128 E129 Q130 I131 K132 A135 K136 V137 S138 D139 I140 L141 S141 H142 I143 D144 G145

LYS LEU ALA GLU P66 P67 P68 P69 P70 P71 P72 P73 P74 P75 P76 P77 P78 P79 P80 P81 P82 P83 P84 P85 P86 P87 P88 P89 P90 P91 P92 P93 P94 P95 P96 P97 P98 P99 K100 K101 V102 V103 L104 L105 K106 K107 L108 L109 L110 L111 D112 M114 Q115 A116 Q117 R118 I113 M114 R118 L121 V122 R123 K124 F125 V126 P127 I128 E129 Q130 I131 K132 A135 K136 V137 S138 D139 I140 L141 S141 H142 I143 D144 G145

E146 L151 V152 S153 K156 V157 M158 L161 R162 LYS ASN ALA SER SER SER SER SER VAL ASP ILE ILE GLY ASN ILE ILE ILE ILE LYS SER SER MET ARG PHE ALA LYS LEU LEU LEU ASP SER ASN PHE PHE THR THR PHE VAL GLN ALA ILE ILE ASN ARG ARG THR THR

LYS GLN ARG ILE PHE TYR GLU ASN LEU LYS ARG HIS LYS ARG THR SER ILE ALA

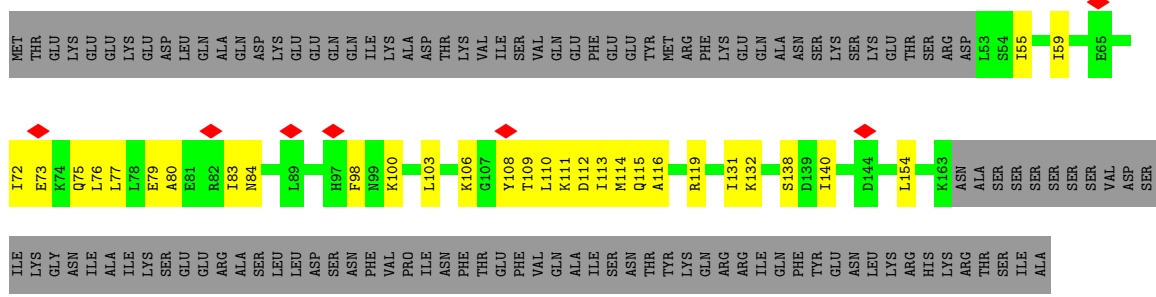
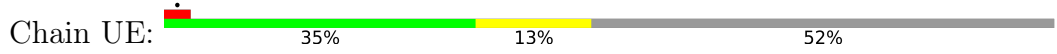

• Molecule 4: Scaffold protein

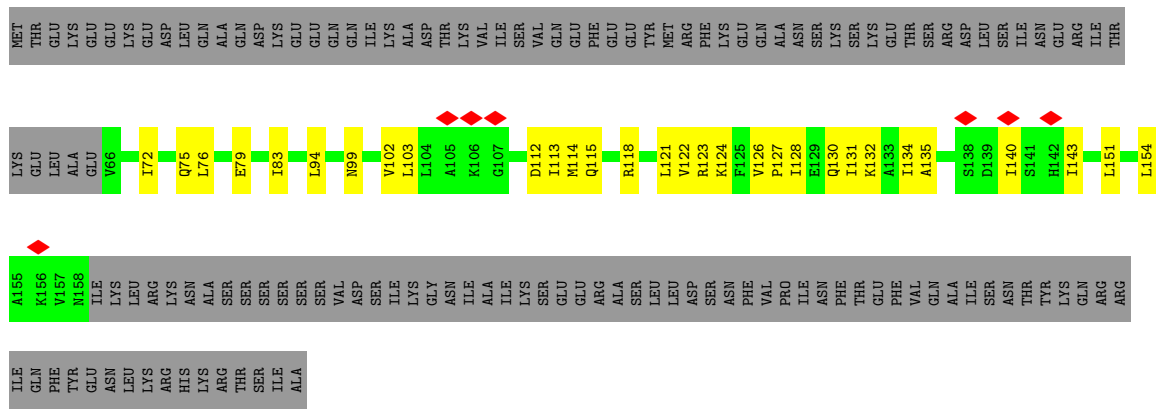

• Molecule 4: Scaffold protein

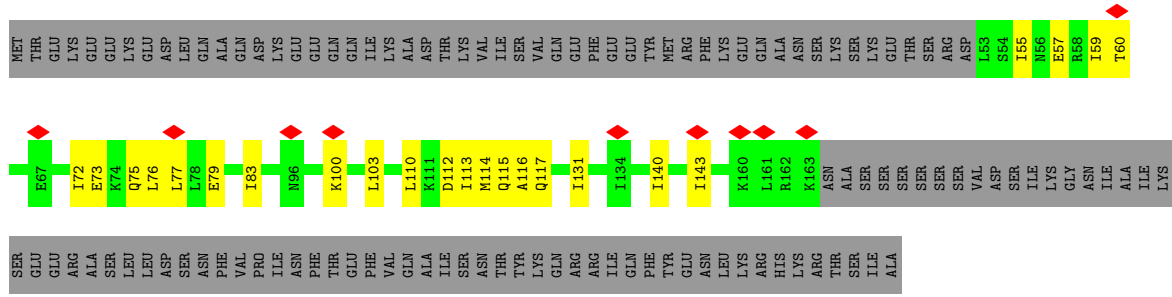
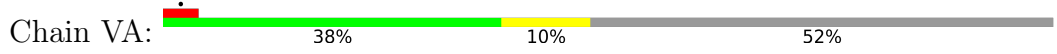

• Molecule 4: Scaffold protein

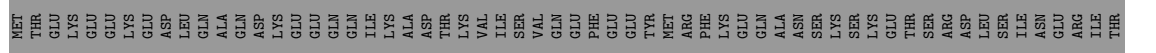
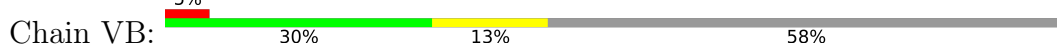

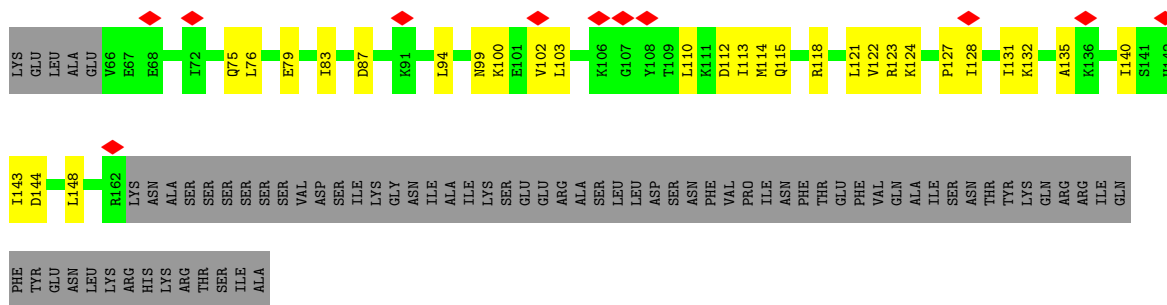

- Molecule 4: Scaffold protein

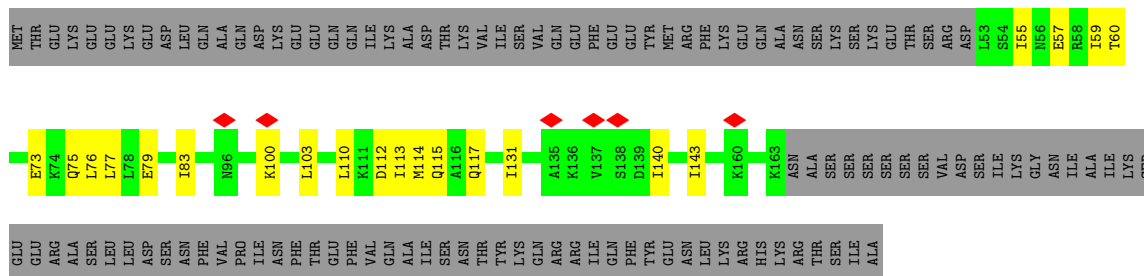

- Molecule 4: Scaffold protein

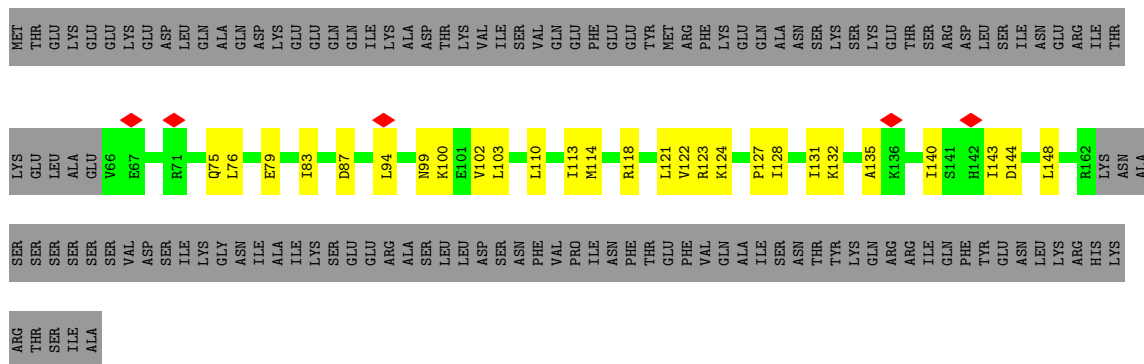
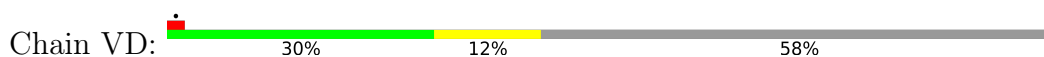

- Molecule 4: Scaffold protein

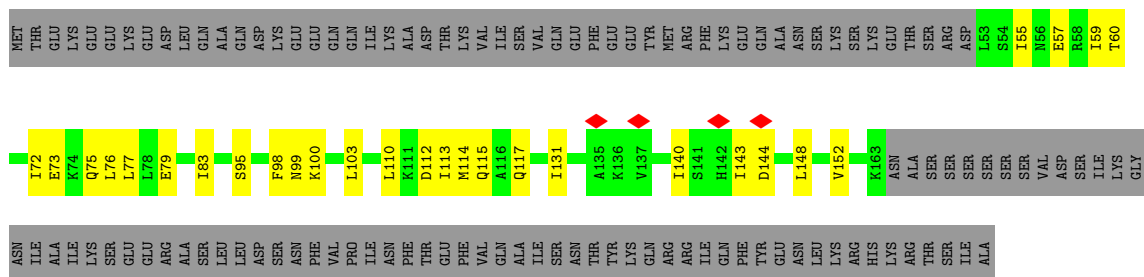
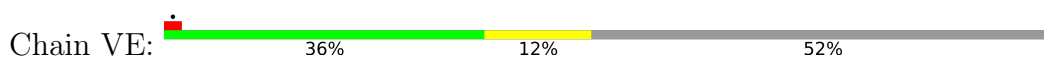

- Molecule 4: Scaffold protein

ILE
ALA
ILE
ILE
LYS
SER
GLU
GLU
ARG
ALA
SER
LEU
LEU
LEU
LEU
ALA
ASP
SER
ASN
PHE
VAL
GLN
PRO
PRO
ILE
ILE
ASN
PHE
THR
THR
THR
PHE
VAL
GLN
ILE
ALA
SER
SER
SER
THR
TYR
TYR
LYS
GLN
ARG
ARG
ILE
ILE
GLN
PHE
TYR
GLU
GLN
ASN
ASN
LEU
LEU
LYS
ARG
HIS
LYS
LYS
ARG
THR
THR
SER
ILE
ILE
ALA

- Molecule 4: Scaffold protein

Chain VJ: 29% 13% 58%

MET THR GLU LYS GLU LYS ASP LEU GLN GLN ALA GLN ASP LYS ASN PHE VAL GLN PRO PRO ILE ILE ASN PHE THR THR THR PHE VAL GLN ILE ALA SER SER SER THR TYR TYR LYS GLN ARG ARG ILE ILE GLN PHE TYR GLU GLN ASN ASN LEU LEU LYS ARG HIS LYS LYS ARG THR THR SER ILE ILE ALA

LYS GLU LEU ALA ALA Y66 Y67 R71 Q75 L76 E79 L83 D87 L94 S95 N96 N99 K100 E101 V102 L103 K106 L110 I113 M114 B118 L121 V122 R123 K124 P127 I128 I131 K132 L135 A135 K136 I140 I143 D144 L148 R162

LYS ASN ALA SER SER SER VAL ASP GLN GLN ALA ILE ILE ILE SER SER GLU GLU ARG ALA SER LEU SER ASP GLN SER ASN VAL PHE VAL PRO ILE ILE ASN PHE THR GLU PHE VAL GLN ALA ILE SER ASN THR LYS THR LYS GLN ARG ARG ILE ILE PHE GLN TYR TYR THR THR SER ARG ASP ILE SER ILE TYR TYR GLU LEU ASN LEU LYS

ARG HIS LYS ARG THR SER SER SER ILE ALA

- Molecule 4: Scaffold protein

Chain VK: 37% 11% 52%

MET THR GLU LYS GLU LYS ASP LEU GLN GLN ALA GLN ASP LYS ASN PHE VAL GLN PRO PRO ILE ILE ASN PHE THR THR THR PHE VAL GLN ILE ALA SER SER SER THR TYR TYR LYS GLN ARG ARG ILE ILE PHE GLN TYR TYR GLU LEU ASN LEU LYS ARG HIS LYS LYS ARG THR THR ILE ILE ALA

K74 Q75 L77 E79 I83 S95 F98 N99 K100 L103 L110 L111 D112 I113 M114 Q115 A116 Q117 I131 I140 I143 D144 L148 K163 ASN ALA SER SER SER SER SER VAL ASP ILE ILE SER SER SER SER VAL ILE ILE ILE SER SER SER SER TYR TYR THR THR THR THR SER ARG ASP L53 S54 I55 I59 I72 E73

SER LEU LEU ASP GLU ASN PHE VAL PRO ILE ILE ASN PHE THR THR GLU PHE VAL GLN ALA ILE ILE SER ASN THR TYR LYS GLN ARG ARG ILE ILE GLN PHE TYR TYR LYS ASN VAL PHE VAL PRO ILE ILE SER ASN THR TYR THR ILE ILE ALA

- Molecule 4: Scaffold protein

Chain VL: 30% 12% 58%

MET THR GLU LYS GLU LYS ASP LEU GLN GLN ALA GLN ASP LYS ASN PHE VAL GLN PRO PRO ILE ILE ASN PHE THR THR THR PHE VAL GLN ILE ALA SER SER SER THR TYR TYR LYS GLN ARG ARG ILE ILE GLN PHE TYR TYR LYS ASN VAL PHE VAL PRO ILE ILE SER ASN THR TYR THR ILE ILE ALA

LYS GLU LEU ALA ALA Y66 Y67 E70 R71 Q75 L76 E79 I83 D87 K91 L94 N99 K100 E101 V102 L103 K106 L110 I113 M114 B118 L121 V122 R123 K124 P127 I128 I131 K132 L135 A135 I140 I143 D144 L148

R162
LYS ARG HIS LYS ARG THR SER SER SER SER VAL ASP GLN GLN ALA ILE ILE ILE SER SER GLU GLU ARG ALA SER LEU LEU ASP SER ASN VAL PHE VAL PRO ILE ILE ASN PHE THR THR THR PHE VAL GLN ALA ILE SER ASN THR TYR TYR THR THR THR SER ARG ARG ILE ILE GLN PHE TYR TYR GLU LEU ASN LEU LYS

LYS ARG HIS LYS ARG THR SER SER SER ILE ALA

- Molecule 4: Scaffold protein

Chain VM: 37% 11% 52%

• Molecule 4: Scaffold protein

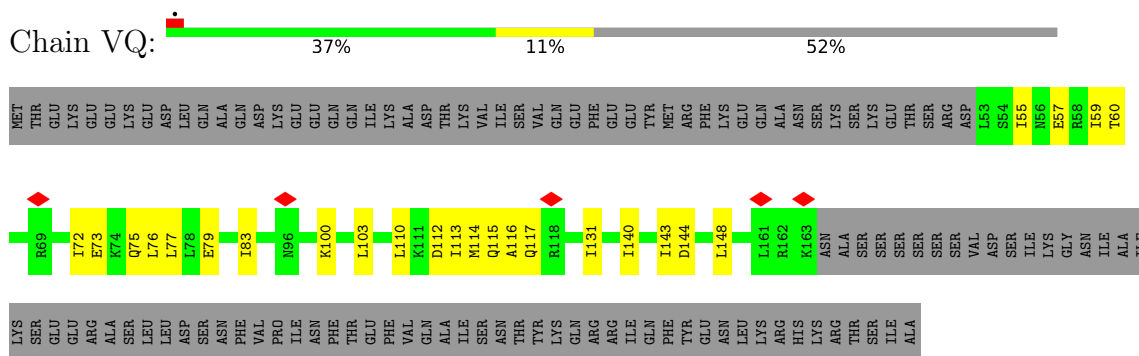

• Molecule 4: Scaffold protein

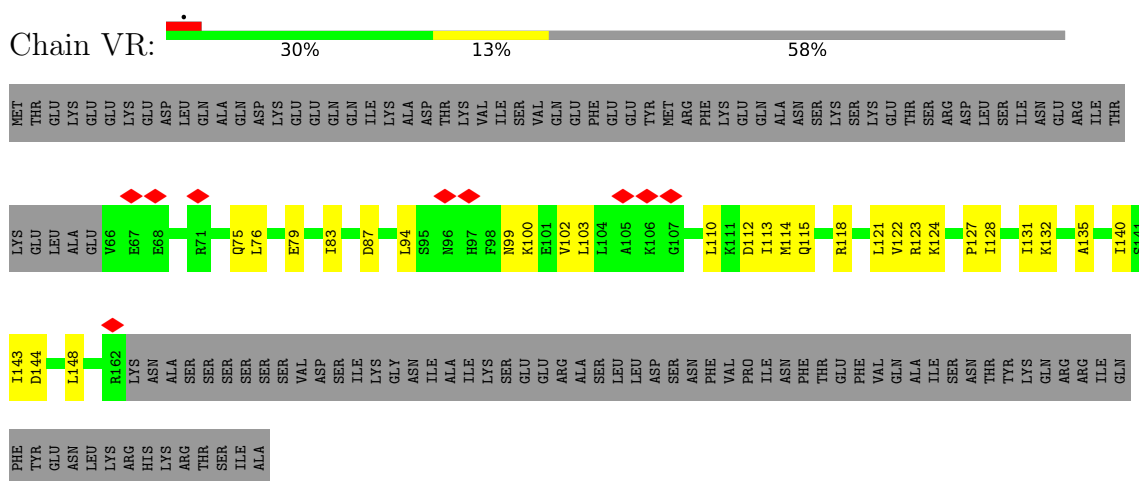

• Molecule 4: Scaffold protein

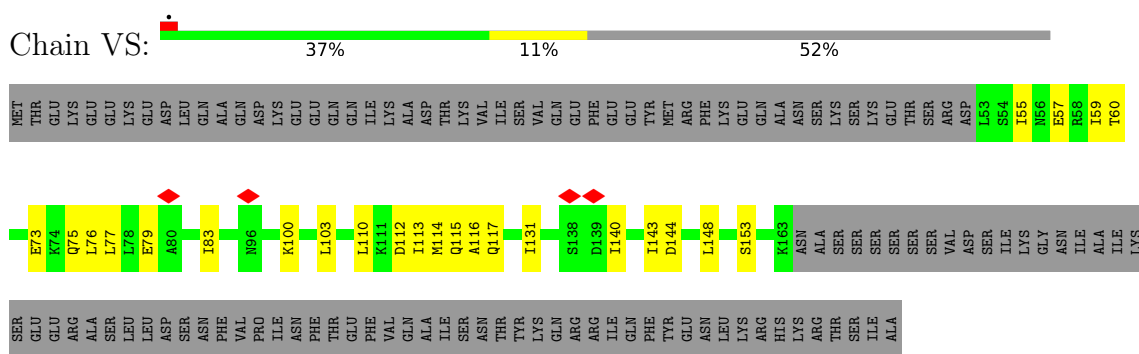

• Molecule 4: Scaffold protein

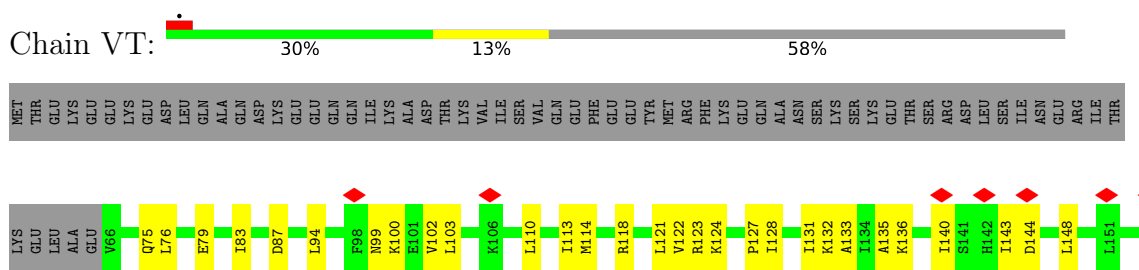

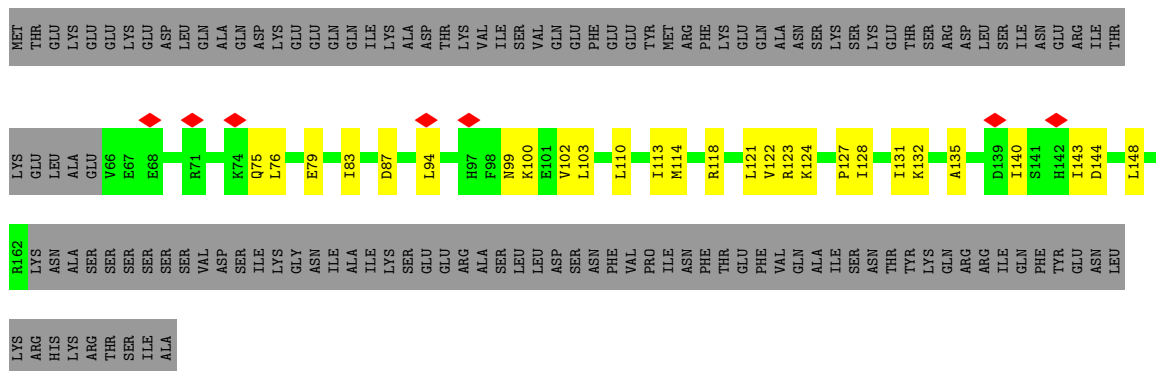

• Molecule 4: Scaffold protein

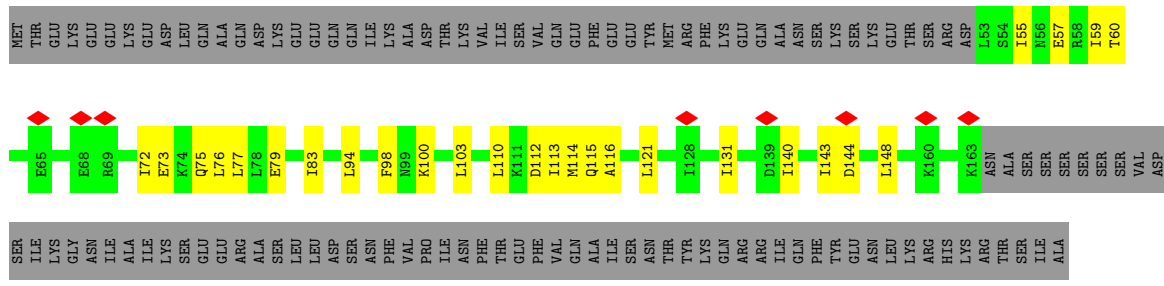
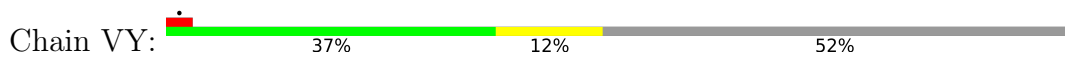

• Molecule 4: Scaffold protein

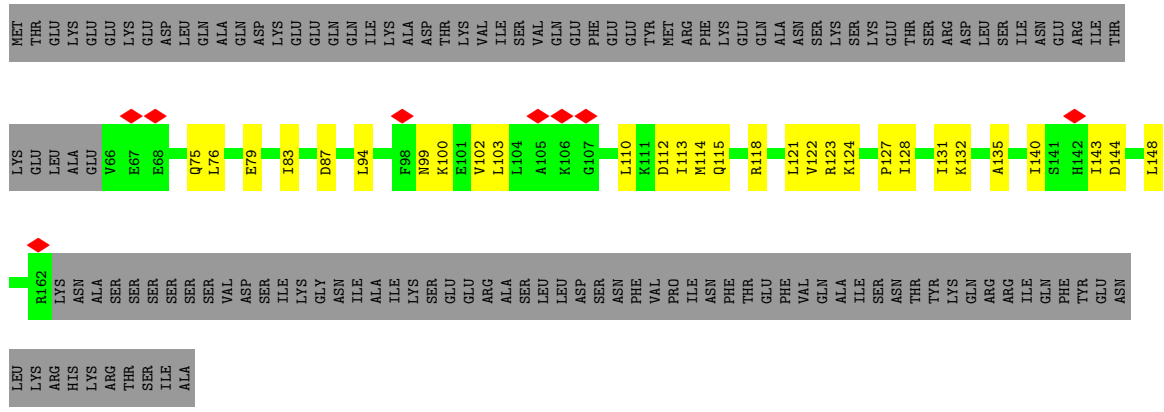
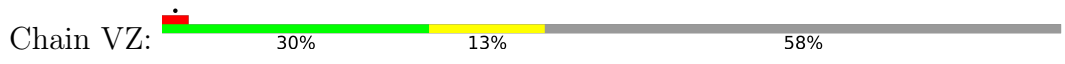

• Molecule 4: Scaffold protein

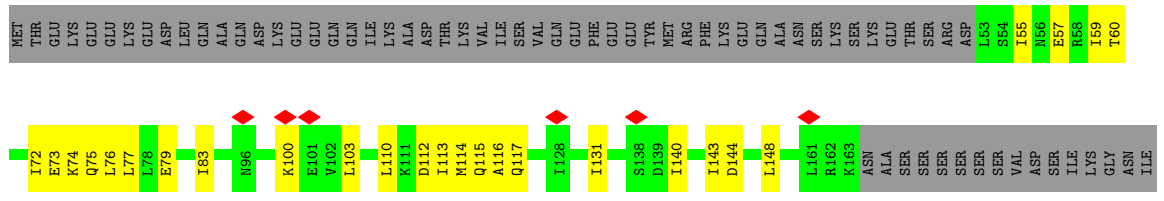
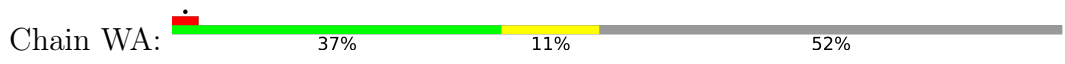

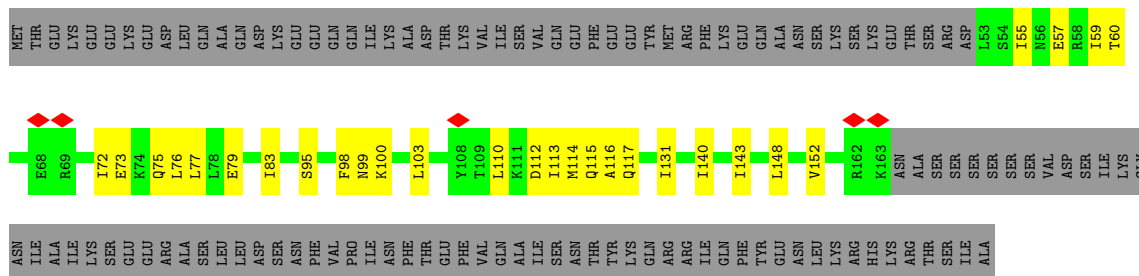

• Molecule 4: Scaffold protein

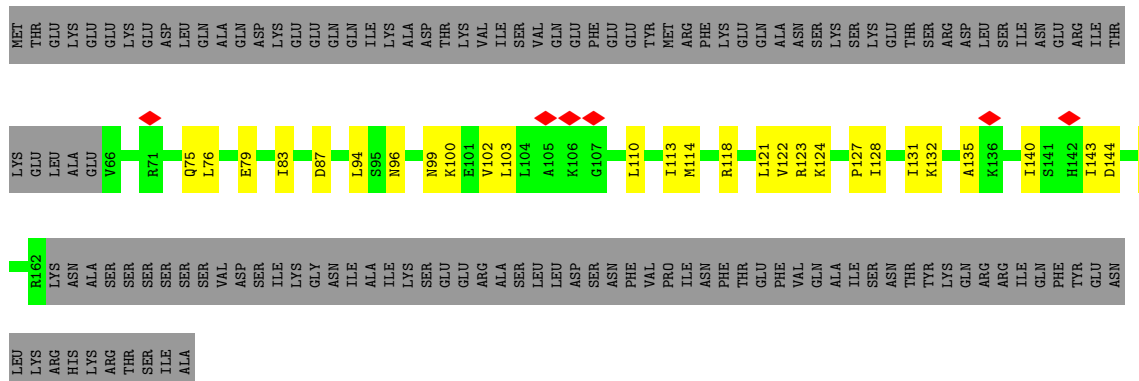
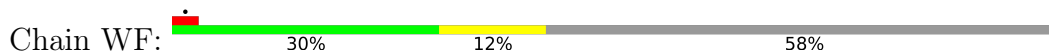

• Molecule 4: Scaffold protein

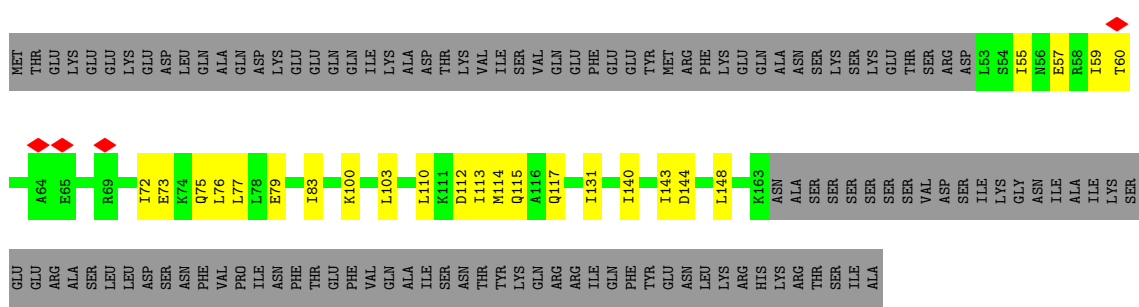
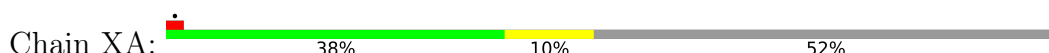

• Molecule 4: Scaffold protein

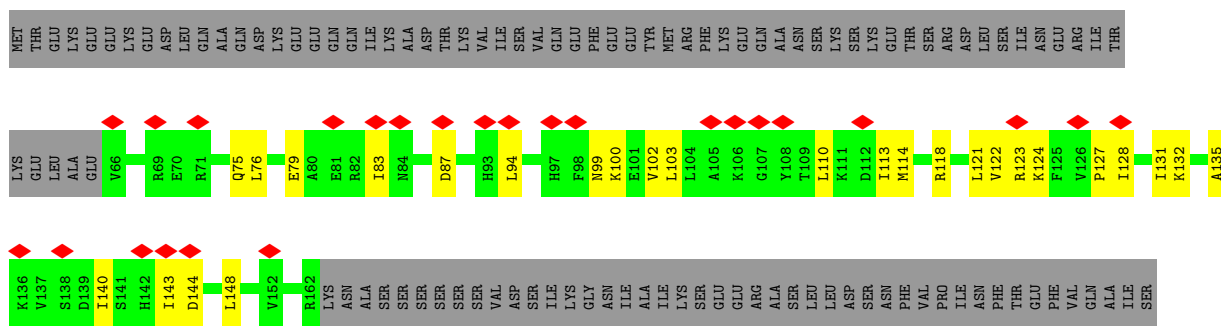
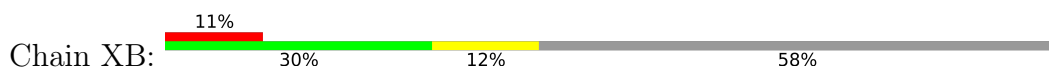

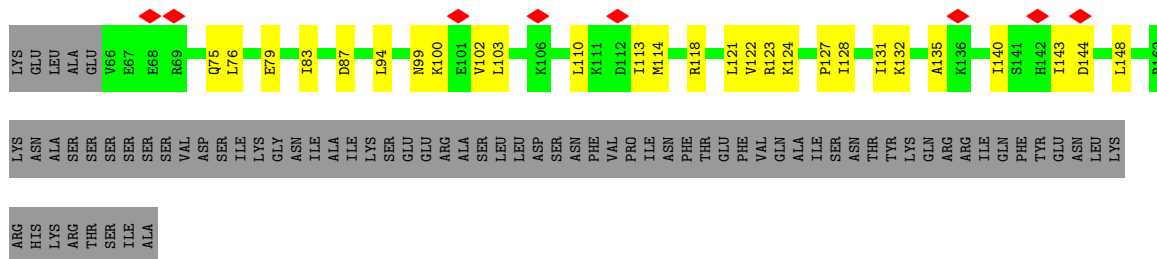

• Molecule 4: Scaffold protein

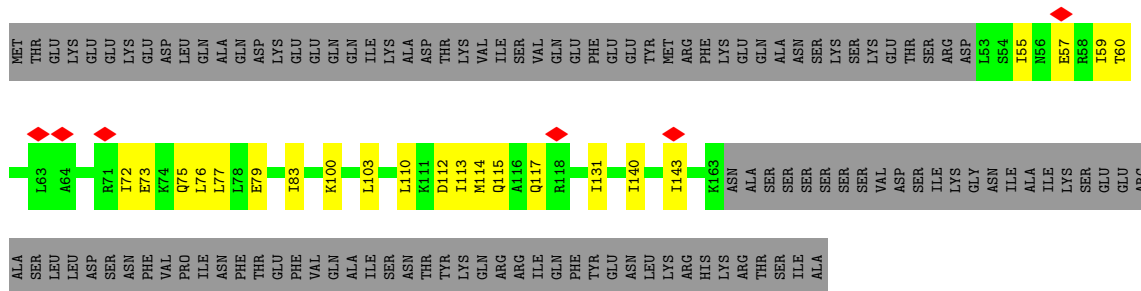

• Molecule 4: Scaffold protein

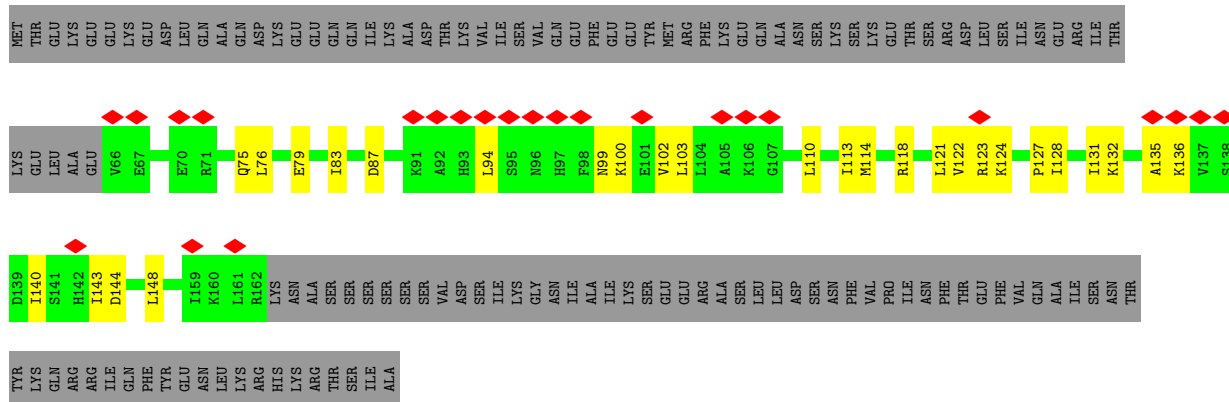
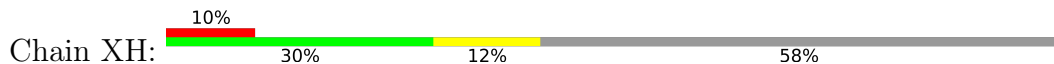

• Molecule 4: Scaffold protein

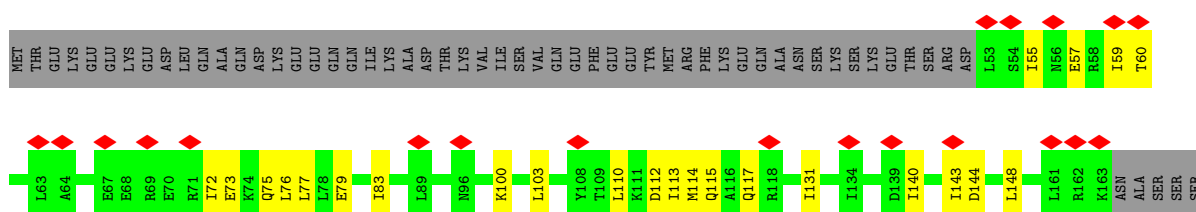
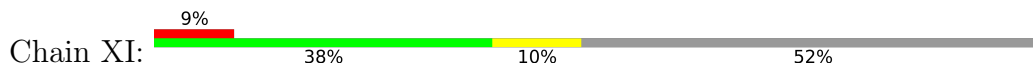

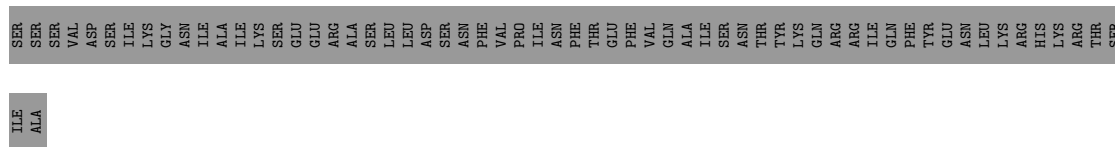

● Molecule 4: Scaffold protein

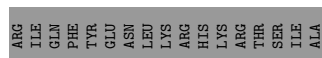
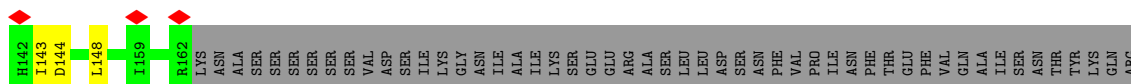
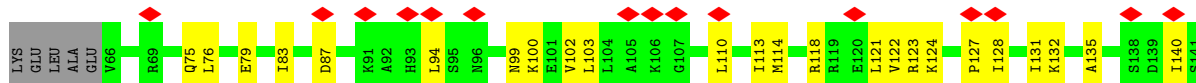
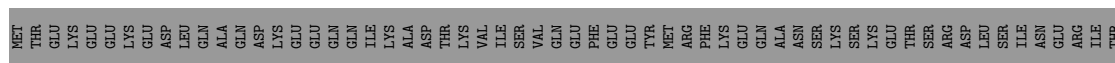
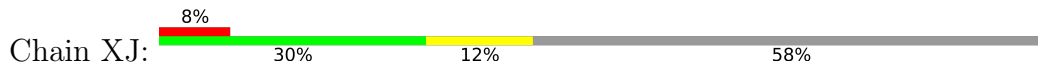

● Molecule 4: Scaffold protein

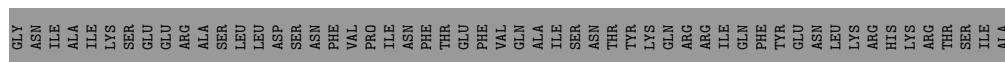
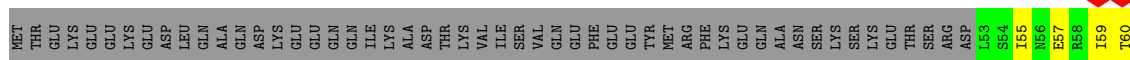
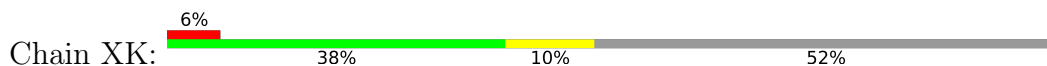

● Molecule 4: Scaffold protein

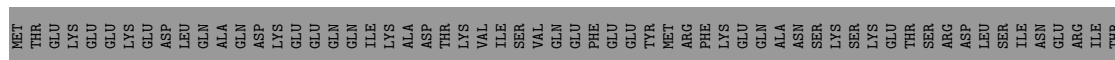
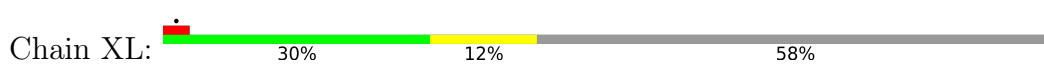

● Molecule 4: Scaffold protein

Chain XM: 38% 10% 52%

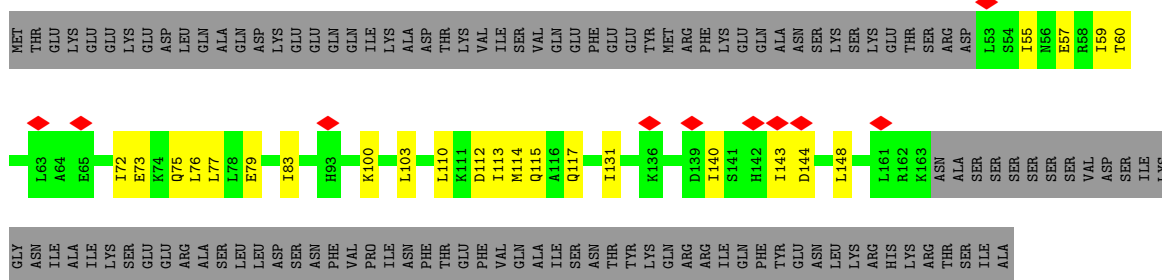

- Molecule 4: Scaffold protein

Chain XN: 5% 30% 13% 58%

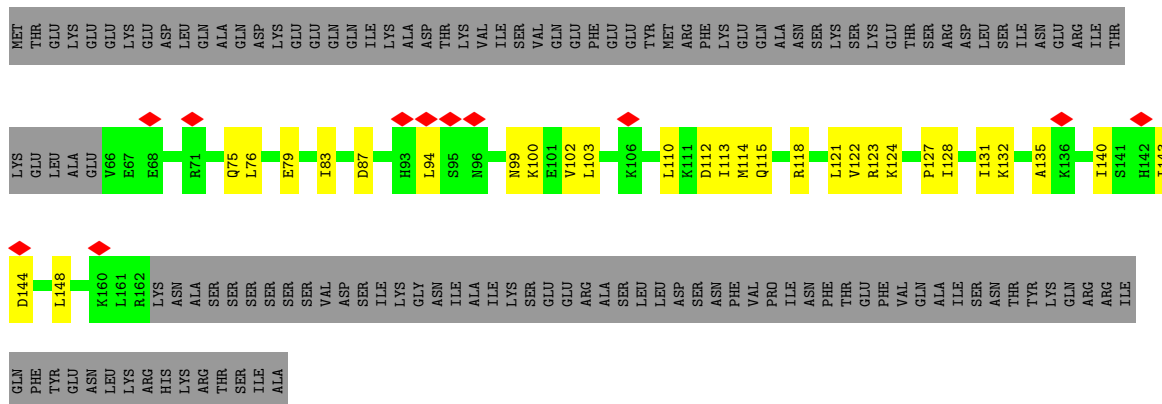

- Molecule 4: Scaffold protein

Chain XO: 38% 10% 52%

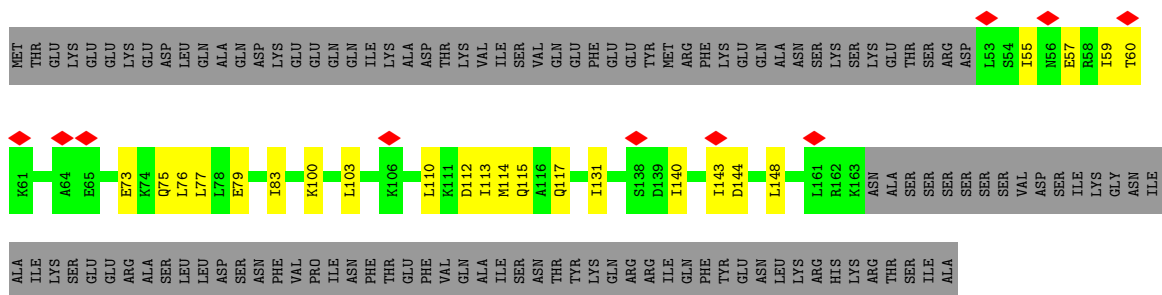

- Molecule 4: Scaffold protein

Chain XP: 6% 30% 12% 58%

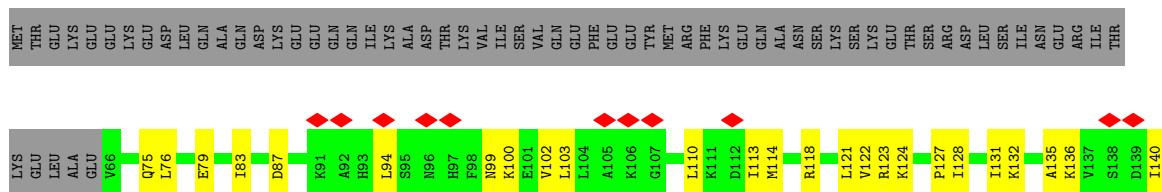

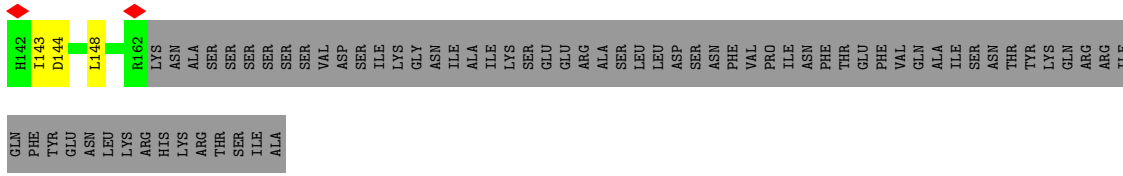

Molecule 4: Scaffold protein

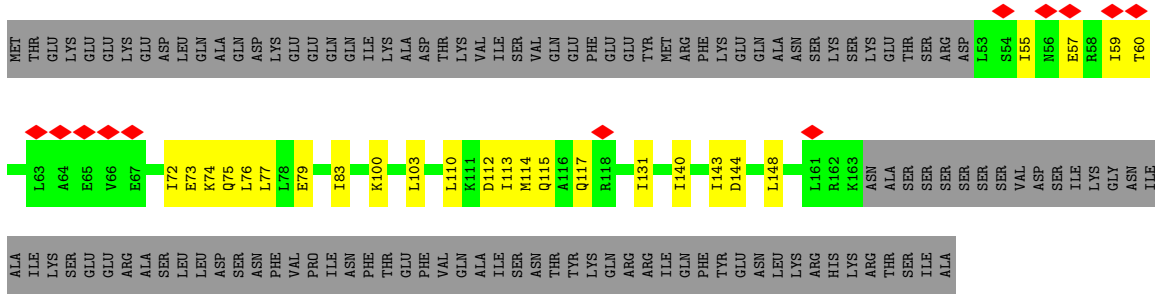
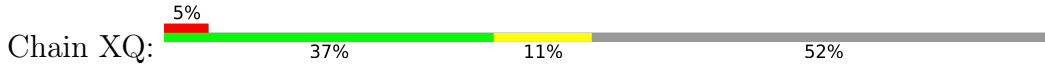

Molecule 4: Scaffold protein

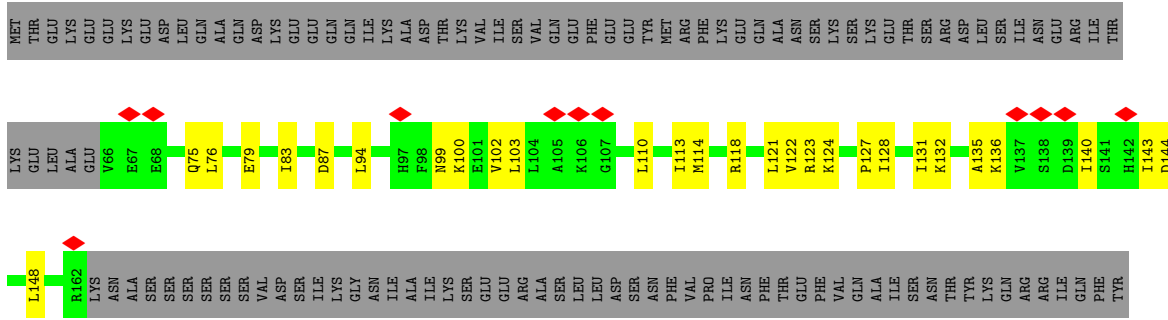
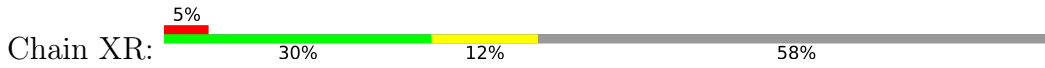

Molecule 4: Scaffold protein

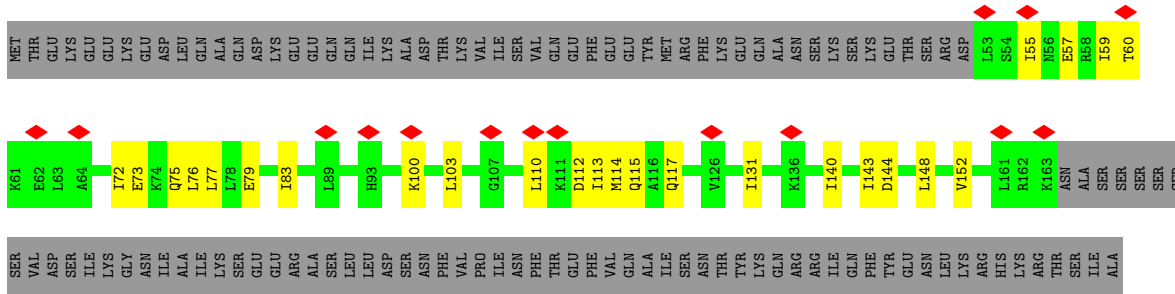
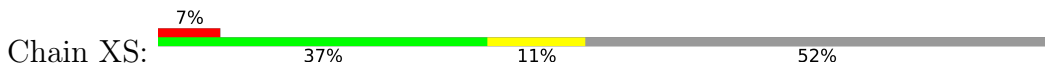

Molecule 4: Scaffold protein

• Molecule 4: Scaffold protein

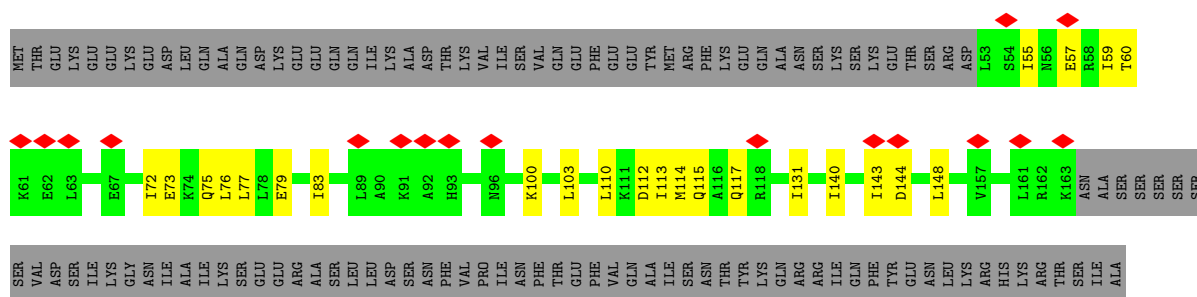
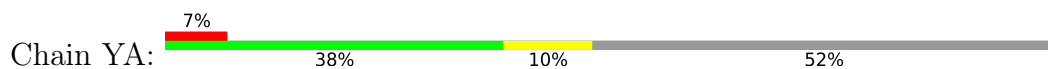

• Molecule 4: Scaffold protein

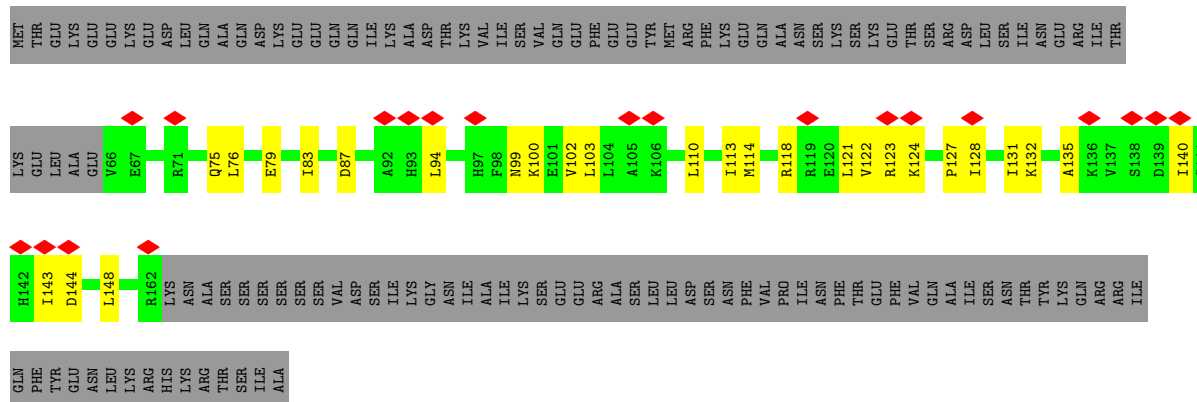
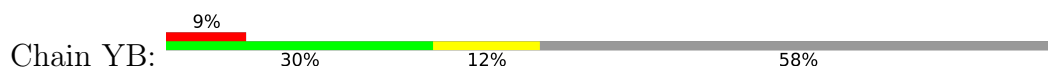

• Molecule 4: Scaffold protein

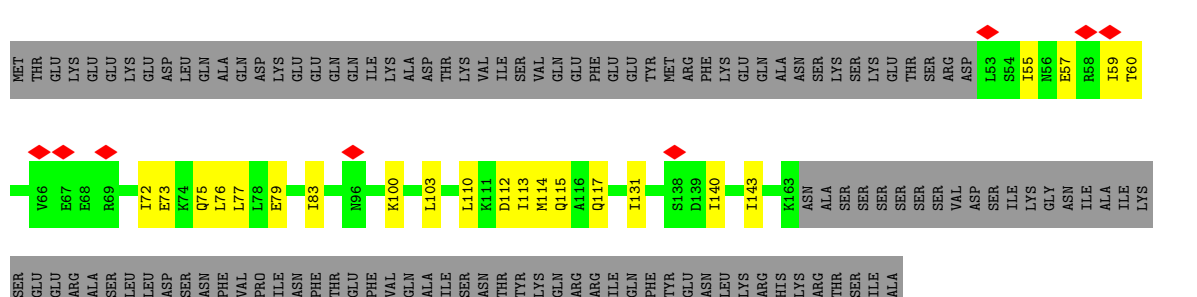
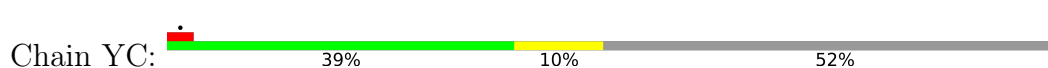

• Molecule 4: Scaffold protein

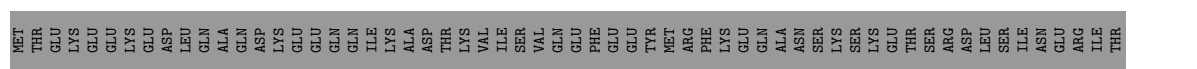
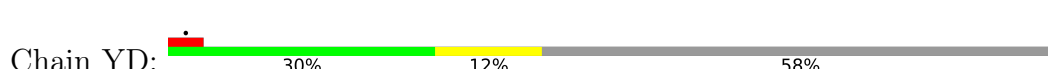

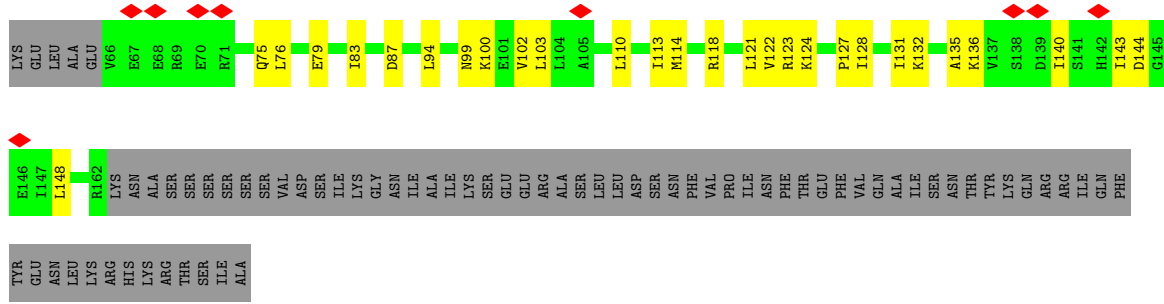

• Molecule 4: Scaffold protein

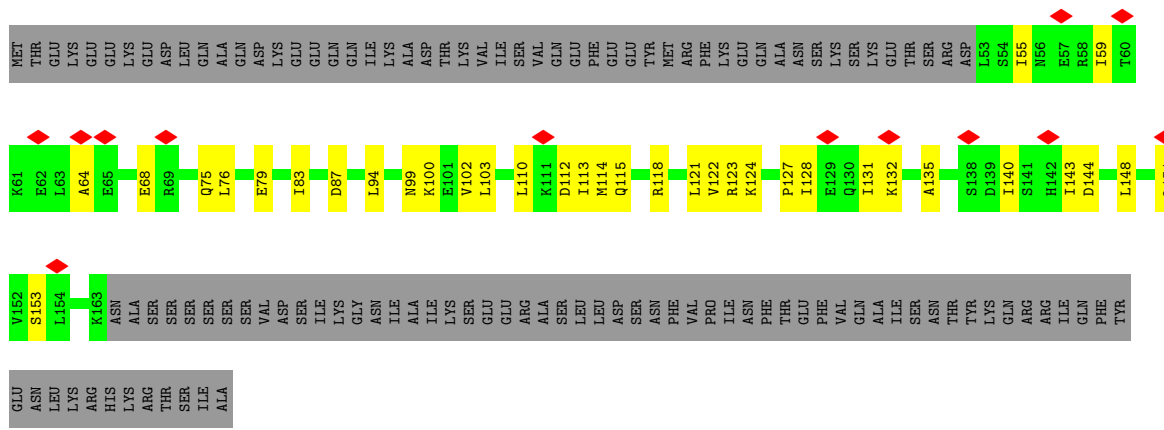
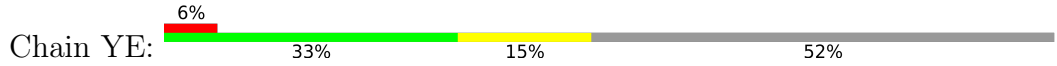

• Molecule 4: Scaffold protein

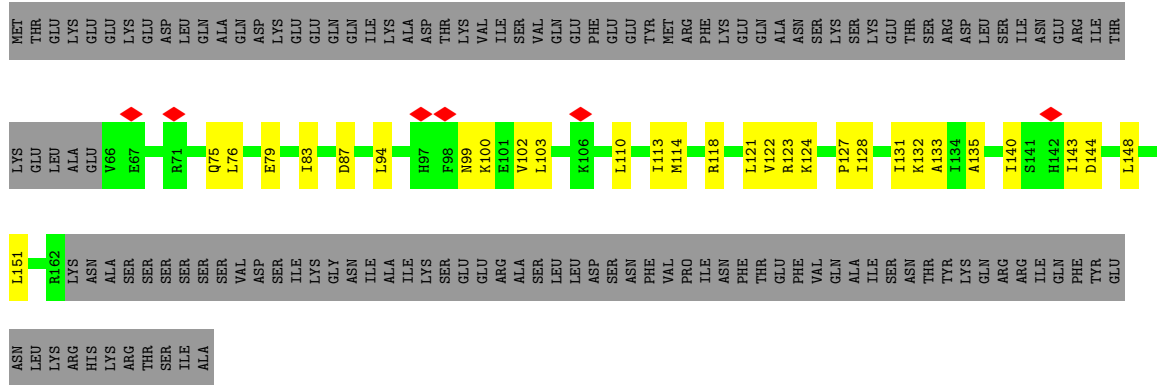
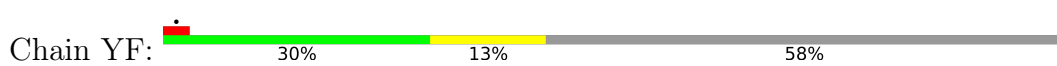

• Molecule 5: Decorator protein P04



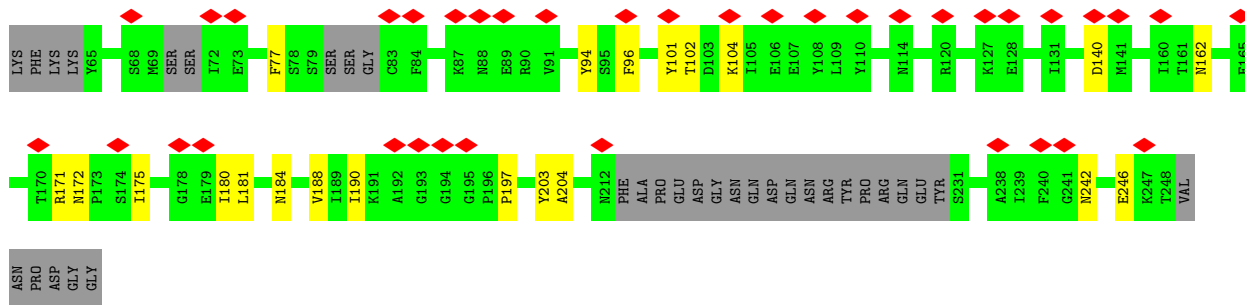

• Molecule 5: Decorator protein P04

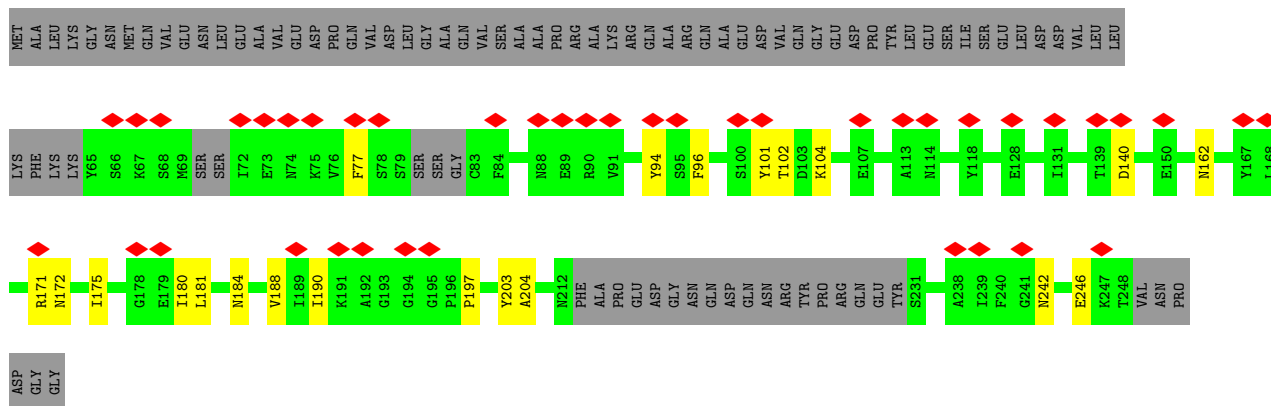

• Molecule 5: Decorator protein P04

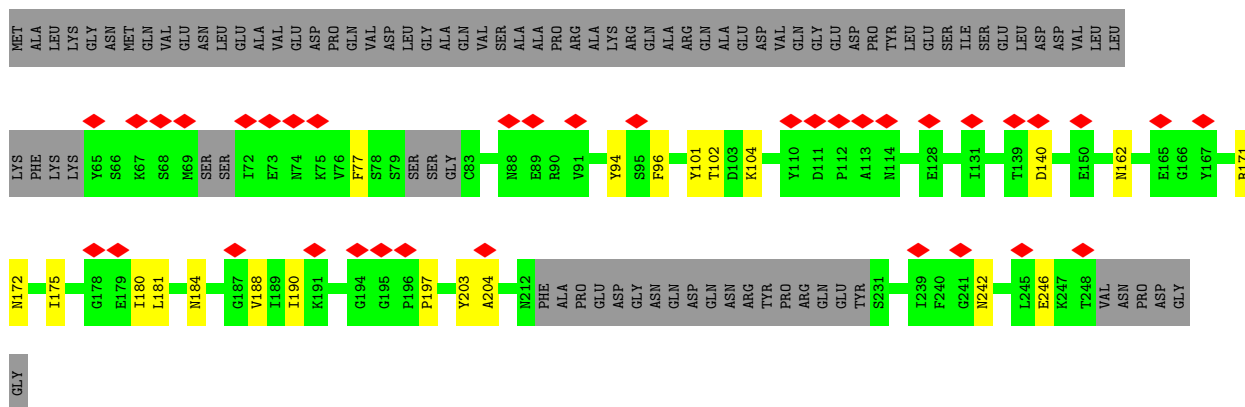

• Molecule 5: Decorator protein P04

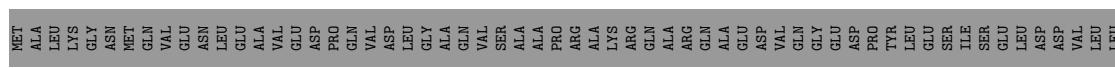

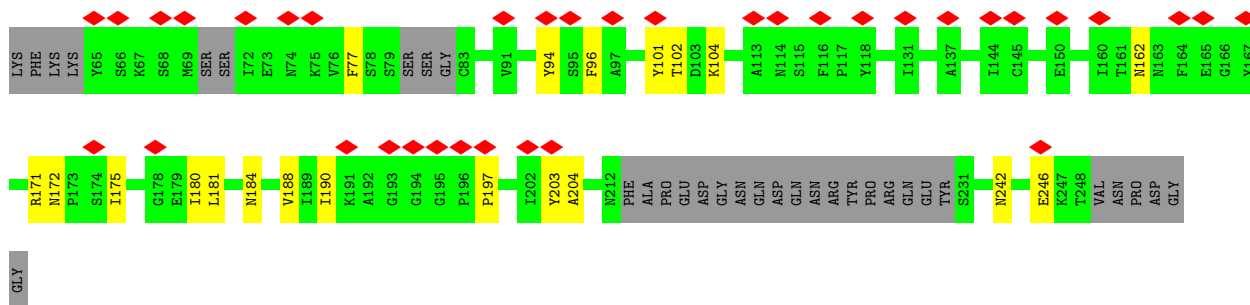

- Molecule 5: Decorator protein P04

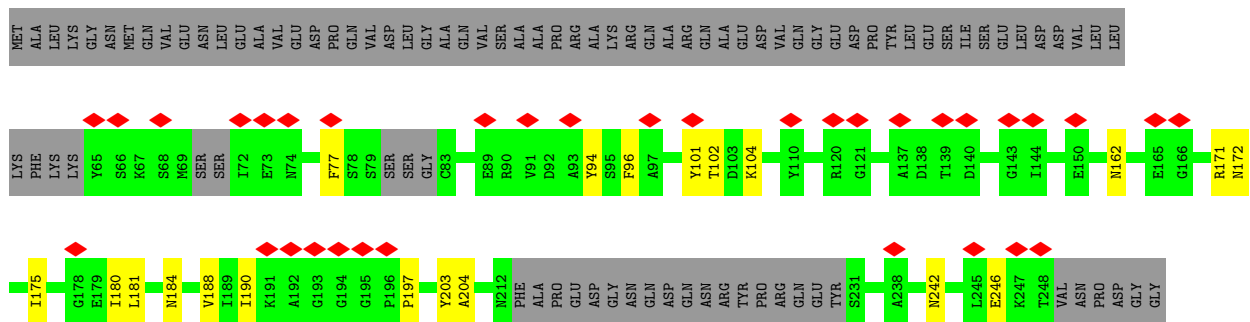

- Molecule 6: Portal protein

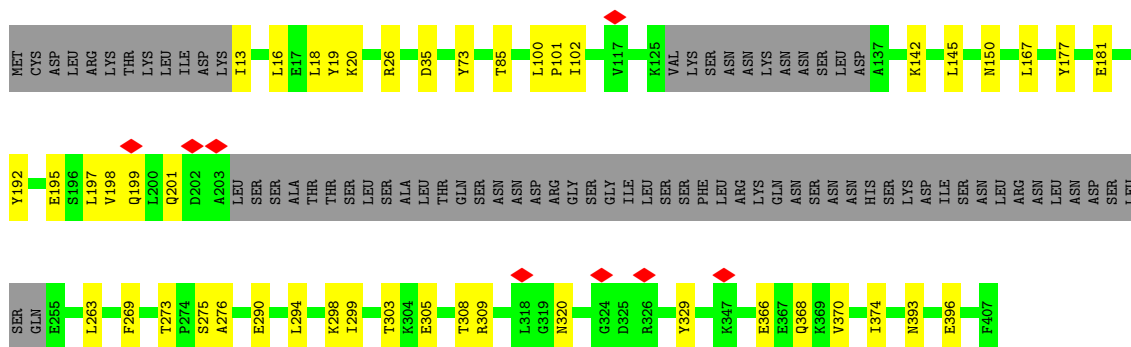

- Molecule 6: Portal protein

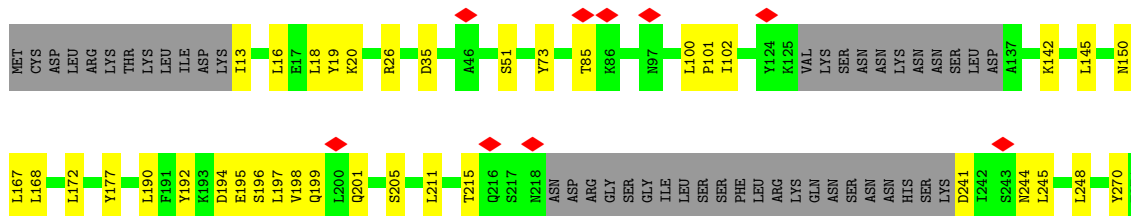
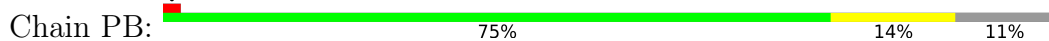



• Molecule 6: Portal protein

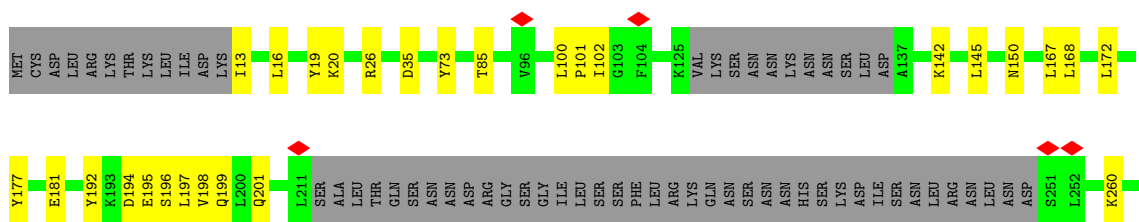
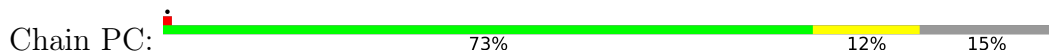

• Molecule 6: Portal protein

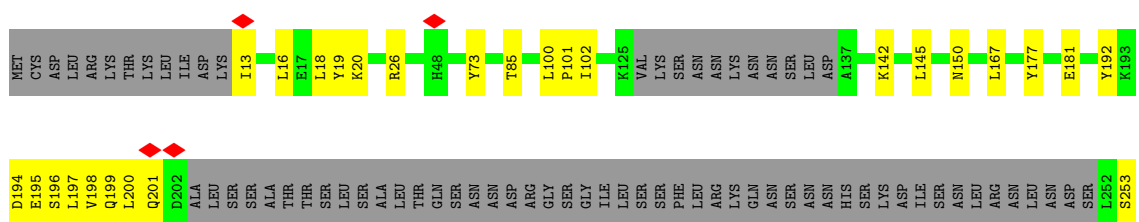

• Molecule 6: Portal protein

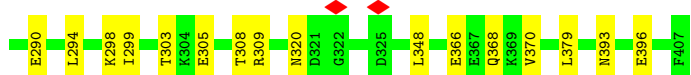
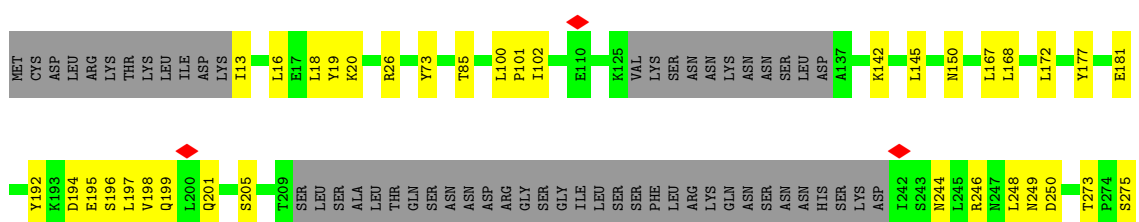

• Molecule 6: Portal protein



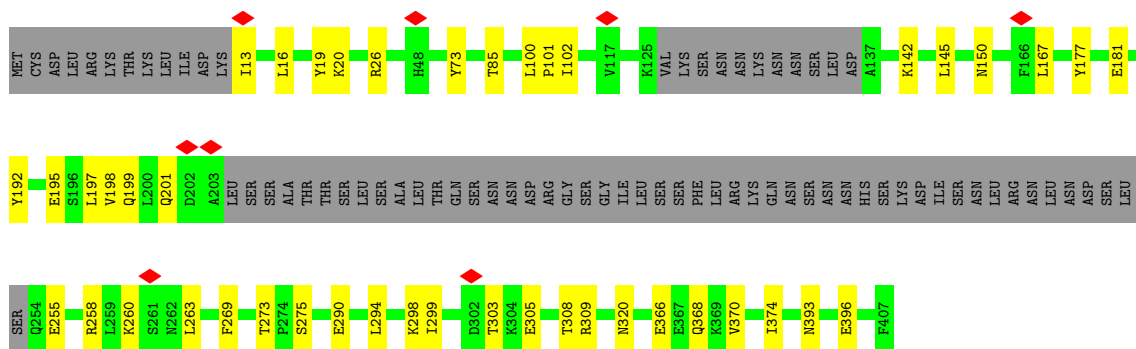

● Molecule 6: Portal protein

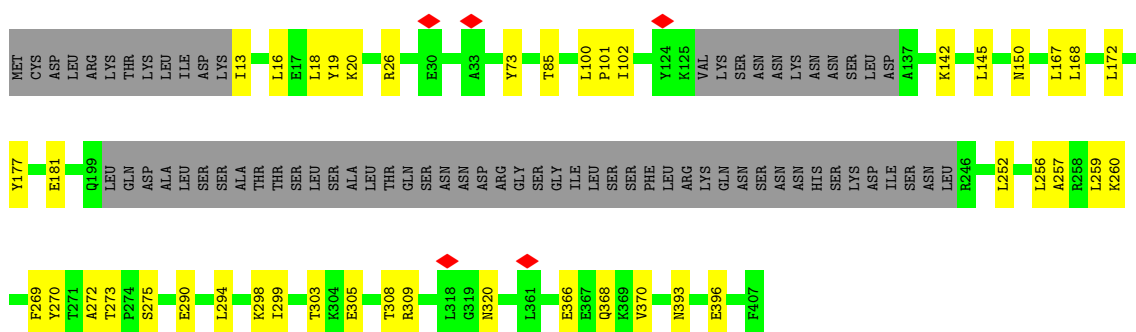

● Molecule 6: Portal protein

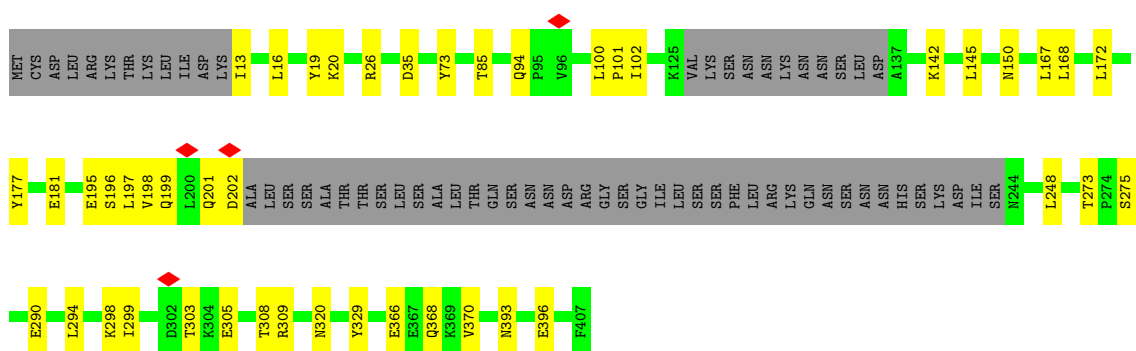
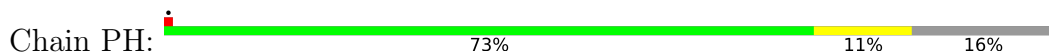

● Molecule 6: Portal protein

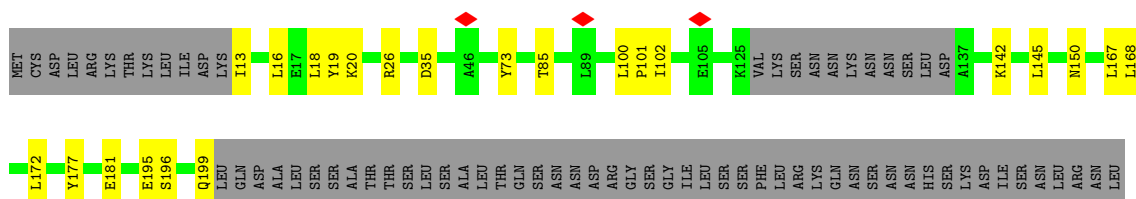

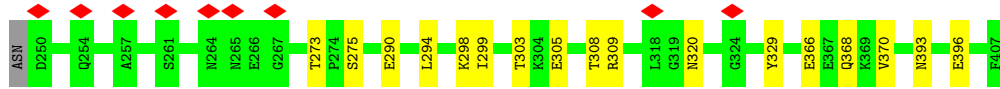

• Molecule 6: Portal protein

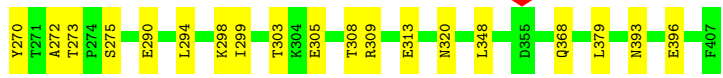
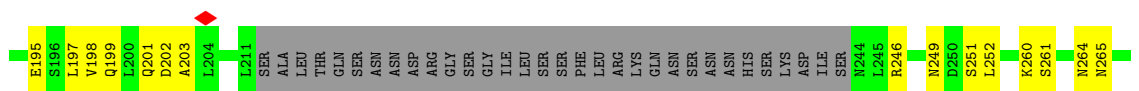
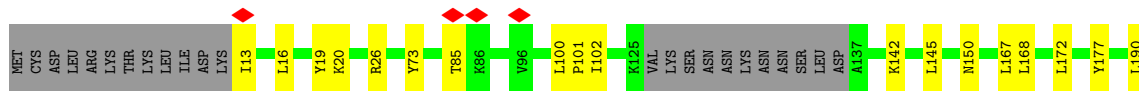
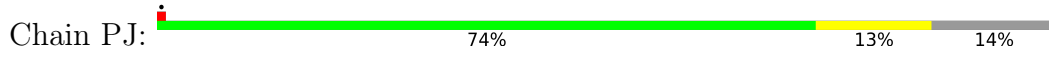

• Molecule 6: Portal protein

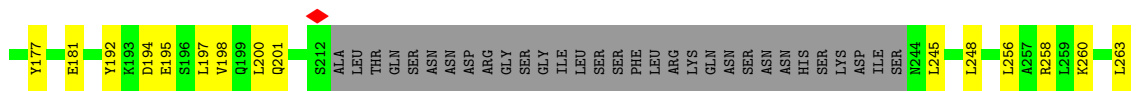
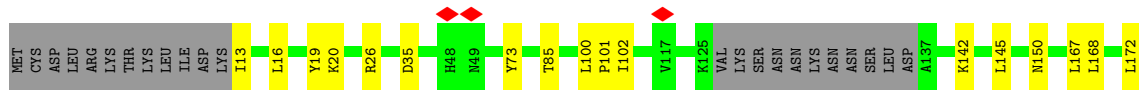
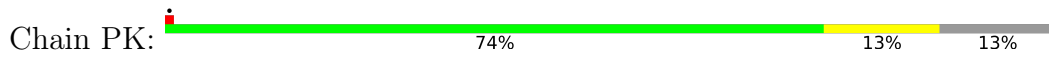

• Molecule 6: Portal protein

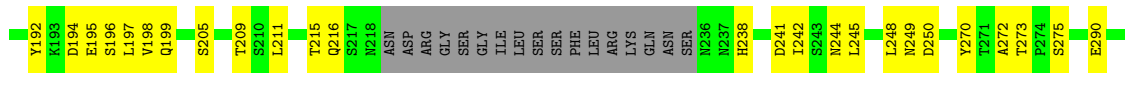
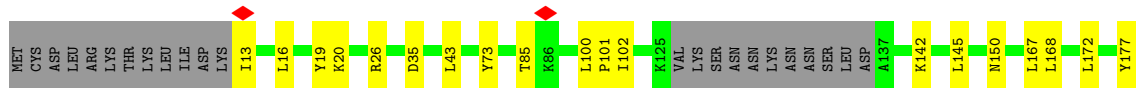
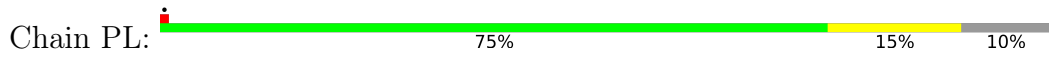

4 Experimental information

Property	Value	Source
EM reconstruction method	SINGLE PARTICLE	Depositor
Imposed symmetry	POINT, C1	Depositor
Number of particles used	25958	Depositor
Resolution determination method	FSC 0.143 CUT-OFF	Depositor
CTF correction method	PHASE FLIPPING AND AMPLITUDE CORRECTION	Depositor
Microscope	FEI TITAN KRIOS	Depositor
Voltage (kV)	300	Depositor
Electron dose ($e^-/\text{\AA}^2$)	44	Depositor
Minimum defocus (nm)	500	Depositor
Maximum defocus (nm)	1800	Depositor
Magnification	16500	Depositor
Image detector	GATAN K3 (6k x 4k)	Depositor
Maximum map value	0.014	Depositor
Minimum map value	-0.006	Depositor
Average map value	-0.000	Depositor
Map value standard deviation	0.001	Depositor
Recommended contour level	0.003	Depositor
Map size (\AA)	533.50397, 533.50397, 533.50397	wwPDB
Map dimensions	640, 640, 640	wwPDB
Map angles ($^\circ$)	90.0, 90.0, 90.0	wwPDB
Pixel spacing (\AA)	0.8335999, 0.8335999, 0.8335999	Depositor

5 Model quality [i](#)

5.1 Standard geometry [i](#)

The Z score for a bond length (or angle) is the number of standard deviations the observed value is removed from the expected value. A bond length (or angle) with $|Z| > 5$ is considered an outlier worth inspection. RMSZ is the root-mean-square of all Z scores of the bond lengths (or angles).

Mol	Chain	Bond lengths		Bond angles	
		RMSZ	# Z >5	RMSZ	# Z >5
1	AB	0.24	0/2558	0.42	0/3458
1	AC	0.24	0/2449	0.42	0/3309
1	AJ	0.23	0/2536	0.42	0/3428
1	AK	0.24	0/2558	0.43	0/3458
1	AL	0.24	0/2558	0.42	0/3458
1	AS	0.24	0/2536	0.42	0/3428
1	AT	0.24	0/2558	0.42	0/3458
1	AU	0.24	0/2558	0.42	0/3458
1	BB	0.24	0/2536	0.42	0/3428
1	BC	0.24	0/2558	0.43	0/3458
1	BD	0.24	0/2558	0.42	0/3458
1	BK	0.24	0/2553	0.43	0/3450
1	BL	0.24	0/2558	0.43	0/3458
1	BM	0.24	0/2558	0.42	0/3458
1	BT	0.24	0/2536	0.42	0/3428
1	BU	0.24	0/2558	0.42	0/3458
1	BV	0.24	0/2553	0.43	0/3450
1	CC	0.24	0/2558	0.42	0/3458
1	CD	0.24	0/2428	0.43	0/3281
1	CE	0.24	0/2558	0.42	0/3458
1	CL	0.24	0/2558	0.42	0/3458
1	CM	0.24	0/2558	0.43	0/3458
1	CN	0.24	0/2428	0.42	0/3281
1	CU	0.24	0/2558	0.42	0/3458
1	CV	0.24	0/2558	0.42	0/3458
1	CW	0.24	0/2558	0.42	0/3458
1	DB	0.24	0/2558	0.42	0/3458
1	DC	0.24	0/2449	0.42	0/3309
1	DJ	0.23	0/2536	0.42	0/3428
1	DK	0.24	0/2558	0.42	0/3458
1	DL	0.24	0/2558	0.42	0/3458
1	DS	0.24	0/2536	0.42	0/3428
1	DT	0.24	0/2558	0.42	0/3458
1	DU	0.24	0/2558	0.42	0/3458

Mol	Chain	Bond lengths		Bond angles	
		RMSZ	# Z >5	RMSZ	# Z >5
1	EB	0.24	0/2536	0.42	0/3428
1	EC	0.24	0/2558	0.43	0/3458
1	ED	0.24	0/2558	0.42	0/3458
1	EK	0.24	0/2553	0.43	0/3450
1	EL	0.24	0/2558	0.43	0/3458
1	EM	0.24	0/2558	0.42	0/3458
1	ET	0.24	0/2536	0.42	0/3428
1	EU	0.24	0/2558	0.42	0/3458
1	EV	0.24	0/2553	0.43	0/3450
1	FC	0.24	0/2558	0.42	0/3458
1	FD	0.24	0/2428	0.43	0/3281
1	FE	0.24	0/2558	0.42	0/3458
1	FL	0.24	0/2558	0.42	0/3458
1	FM	0.24	0/2558	0.43	0/3458
1	FN	0.24	0/2428	0.42	0/3281
1	FU	0.24	0/2558	0.42	0/3458
1	FV	0.24	0/2558	0.42	0/3458
1	FW	0.24	0/2558	0.42	0/3458
1	GB	0.24	0/2558	0.42	0/3458
1	GC	0.24	0/2449	0.42	0/3309
1	GJ	0.23	0/2536	0.42	0/3428
1	GK	0.24	0/2558	0.43	0/3458
1	GL	0.24	0/2558	0.42	0/3458
1	GS	0.24	0/2536	0.42	0/3428
1	GT	0.24	0/2558	0.42	0/3458
1	GU	0.24	0/2558	0.42	0/3458
1	HB	0.24	0/2536	0.42	0/3428
1	HC	0.24	0/2558	0.43	0/3458
1	HD	0.24	0/2558	0.42	0/3458
1	HK	0.24	0/2553	0.43	0/3450
1	HL	0.24	0/2558	0.43	0/3458
1	HM	0.24	0/2558	0.42	0/3458
1	HT	0.24	0/2536	0.42	0/3428
1	HU	0.24	0/2558	0.42	0/3458
1	HV	0.24	0/2553	0.43	0/3450
1	IC	0.24	0/2558	0.42	0/3458
1	ID	0.24	0/2428	0.43	0/3281
1	IE	0.24	0/2558	0.42	0/3458
1	IL	0.24	0/2558	0.42	0/3458
1	IM	0.24	0/2558	0.43	0/3458
1	IN	0.24	0/2428	0.42	0/3281
1	IU	0.24	0/2558	0.42	0/3458
1	IV	0.24	0/2558	0.42	0/3458

Mol	Chain	Bond lengths		Bond angles	
		RMSZ	# Z >5	RMSZ	# Z >5
1	IW	0.24	0/2558	0.42	0/3458
1	JB	0.24	0/2558	0.42	0/3458
1	JC	0.24	0/2449	0.42	0/3309
1	JJ	0.24	0/2536	0.42	0/3428
1	JK	0.24	0/2558	0.43	0/3458
1	JL	0.24	0/2558	0.42	0/3458
1	JS	0.24	0/2536	0.42	0/3428
1	JT	0.24	0/2558	0.42	0/3458
1	JU	0.24	0/2558	0.42	0/3458
1	KB	0.24	0/2536	0.42	0/3428
1	KC	0.24	0/2558	0.43	0/3458
1	KD	0.24	0/2558	0.42	0/3458
1	KK	0.24	0/2553	0.43	0/3450
1	KL	0.24	0/2558	0.43	0/3458
1	KM	0.24	0/2558	0.42	0/3458
1	KT	0.24	0/2536	0.42	0/3428
1	KU	0.24	0/2558	0.42	0/3458
1	KV	0.24	0/2553	0.43	0/3450
1	LC	0.24	0/2558	0.42	0/3458
1	LD	0.24	0/2428	0.43	0/3281
1	LE	0.24	0/2558	0.42	0/3458
1	LL	0.24	0/2558	0.42	0/3458
1	LM	0.24	0/2558	0.43	0/3458
1	LN	0.24	0/2428	0.42	0/3281
1	LU	0.24	0/2558	0.42	0/3458
1	LV	0.24	0/2558	0.42	0/3458
1	LW	0.24	0/2558	0.42	0/3458
1	MB	0.24	0/2558	0.42	0/3458
1	MC	0.24	0/2449	0.42	0/3309
1	MJ	0.24	0/2536	0.42	0/3428
1	MK	0.24	0/2558	0.43	0/3458
1	ML	0.24	0/2558	0.42	0/3458
1	MS	0.24	0/2536	0.42	0/3428
1	MT	0.23	0/2558	0.42	0/3458
1	MU	0.24	0/2558	0.42	0/3458
1	NB	0.24	0/2536	0.42	0/3428
1	NC	0.24	0/2558	0.43	0/3458
1	ND	0.24	0/2558	0.42	0/3458
1	NK	0.24	0/2553	0.43	0/3450
1	NL	0.24	0/2558	0.43	0/3458
1	NM	0.24	0/2558	0.42	0/3458
1	NT	0.24	0/2536	0.42	0/3428
1	NU	0.24	0/2558	0.42	0/3458

Mol	Chain	Bond lengths		Bond angles	
		RMSZ	# Z >5	RMSZ	# Z >5
1	NV	0.24	0/2553	0.43	0/3450
1	OC	0.24	0/2558	0.42	0/3458
1	OD	0.24	0/2428	0.43	0/3281
1	OE	0.24	0/2558	0.42	0/3458
1	OL	0.24	0/2558	0.42	0/3458
1	OM	0.24	0/2558	0.43	0/3458
1	ON	0.24	0/2428	0.42	0/3281
1	OU	0.24	0/2558	0.42	0/3458
1	OV	0.24	0/2558	0.42	0/3458
1	OW	0.24	0/2558	0.42	0/3458
2	AD	0.24	0/931	0.44	0/1252
2	AO	0.24	0/1216	0.44	0/1637
2	AW	0.24	0/1181	0.45	0/1590
2	AX	0.24	0/1229	0.44	0/1655
2	BF	0.24	0/1212	0.44	0/1633
2	BG	0.24	0/1190	0.44	0/1601
2	BN	0.24	0/1356	0.44	0/1823
2	BO	0.24	0/1182	0.45	0/1590
2	BW	0.24	0/1207	0.44	0/1626
2	BX	0.24	0/1293	0.42	0/1737
2	CF	0.24	0/1306	0.44	0/1755
2	CG	0.24	0/1177	0.44	0/1583
2	CH	0.24	0/1190	0.44	0/1601
2	CP	0.24	0/1182	0.43	0/1590
2	CQ	0.24	0/1322	0.44	0/1776
2	DD	0.24	0/931	0.44	0/1252
2	DO	0.25	0/1216	0.44	0/1637
2	DW	0.24	0/1181	0.45	0/1590
2	DX	0.24	0/1229	0.44	0/1655
2	EF	0.24	0/1212	0.44	0/1633
2	EG	0.24	0/1190	0.44	0/1601
2	EN	0.24	0/1356	0.44	0/1823
2	EO	0.24	0/1182	0.44	0/1590
2	EW	0.24	0/1207	0.44	0/1626
2	EX	0.24	0/1293	0.43	0/1737
2	FF	0.24	0/1306	0.43	0/1755
2	FG	0.24	0/1177	0.44	0/1583
2	FH	0.24	0/1190	0.44	0/1601
2	FP	0.24	0/1182	0.43	0/1590
2	FQ	0.24	0/1322	0.44	0/1776
2	GD	0.24	0/931	0.44	0/1252
2	GO	0.24	0/1216	0.44	0/1637
2	GW	0.24	0/1181	0.44	0/1590

Mol	Chain	Bond lengths		Bond angles	
		RMSZ	# Z >5	RMSZ	# Z >5
2	GX	0.24	0/1229	0.45	0/1655
2	HF	0.24	0/1212	0.44	0/1633
2	HG	0.24	0/1190	0.44	0/1601
2	HN	0.24	0/1356	0.44	0/1823
2	HO	0.24	0/1182	0.45	0/1590
2	HW	0.24	0/1207	0.44	0/1626
2	HX	0.24	0/1293	0.42	0/1737
2	IF	0.24	0/1306	0.44	0/1755
2	IG	0.24	0/1177	0.44	0/1583
2	IH	0.24	0/1190	0.44	0/1601
2	IP	0.24	0/1182	0.43	0/1590
2	IQ	0.24	0/1322	0.44	0/1776
2	JD	0.24	0/931	0.44	0/1252
2	JO	0.24	0/1216	0.44	0/1637
2	JW	0.24	0/1181	0.45	0/1590
2	JX	0.24	0/1229	0.44	0/1655
2	KF	0.24	0/1212	0.44	0/1633
2	KG	0.24	0/1190	0.44	0/1601
2	KN	0.24	0/1356	0.44	0/1823
2	KO	0.24	0/1182	0.44	0/1590
2	KW	0.24	0/1207	0.44	0/1626
2	KX	0.24	0/1293	0.43	0/1737
2	LF	0.24	0/1306	0.43	0/1755
2	LG	0.24	0/1177	0.44	0/1583
2	LH	0.24	0/1190	0.44	0/1601
2	LP	0.24	0/1182	0.43	0/1590
2	LQ	0.24	0/1322	0.44	0/1776
2	MD	0.24	0/931	0.44	0/1252
2	MO	0.24	0/1216	0.44	0/1637
2	MW	0.24	0/1181	0.44	0/1590
2	MX	0.24	0/1229	0.44	0/1655
2	NF	0.24	0/1212	0.44	0/1633
2	NG	0.24	0/1190	0.44	0/1601
2	NN	0.24	0/1356	0.44	0/1823
2	NO	0.24	0/1182	0.45	0/1590
2	NW	0.24	0/1207	0.44	0/1626
2	NX	0.24	0/1293	0.43	0/1737
2	OF	0.24	0/1306	0.43	0/1755
2	OG	0.24	0/1177	0.44	0/1583
2	OH	0.24	0/1190	0.44	0/1601
2	OP	0.24	0/1182	0.43	0/1590
2	OQ	0.24	0/1322	0.44	0/1776
3	AF	0.24	0/1158	0.44	0/1559

Mol	Chain	Bond lengths		Bond angles	
		RMSZ	# Z >5	RMSZ	# Z >5
3	AN	0.24	0/1208	0.45	0/1626
3	AV	0.24	0/1229	0.45	0/1653
3	BE	0.25	0/1229	0.46	0/1653
3	BP	0.24	0/1207	0.45	0/1625
3	BY	0.24	0/1207	0.44	0/1625
3	CO	0.24	0/1216	0.45	0/1636
3	DF	0.23	0/1158	0.44	0/1559
3	DN	0.24	0/1208	0.45	0/1626
3	DV	0.24	0/1229	0.45	0/1653
3	EE	0.24	0/1229	0.46	0/1653
3	EP	0.24	0/1207	0.45	0/1625
3	EY	0.24	0/1207	0.44	0/1625
3	FO	0.24	0/1216	0.45	0/1636
3	GF	0.24	0/1158	0.44	0/1559
3	GN	0.24	0/1208	0.45	0/1626
3	GV	0.24	0/1229	0.45	0/1653
3	HE	0.25	0/1229	0.46	0/1653
3	HP	0.24	0/1207	0.45	0/1625
3	HY	0.24	0/1207	0.44	0/1625
3	IO	0.24	0/1216	0.45	0/1636
3	JF	0.24	0/1158	0.44	0/1559
3	JN	0.24	0/1208	0.45	0/1626
3	JV	0.24	0/1229	0.45	0/1653
3	KE	0.24	0/1229	0.46	0/1653
3	KP	0.24	0/1207	0.45	0/1625
3	KY	0.24	0/1207	0.44	0/1625
3	LO	0.24	0/1216	0.45	0/1636
3	MF	0.24	0/1158	0.44	0/1559
3	MN	0.24	0/1208	0.45	0/1626
3	MV	0.24	0/1229	0.45	0/1653
3	NE	0.24	0/1229	0.46	0/1653
3	NP	0.24	0/1207	0.45	0/1625
3	NY	0.24	0/1207	0.44	0/1625
3	OO	0.24	0/1216	0.45	0/1636
4	AH	0.25	0/321	0.44	0/432
4	AI	0.24	0/260	0.45	0/349
4	AP	0.24	0/321	0.43	0/432
4	AQ	0.25	0/321	0.42	0/432
4	AR	0.25	0/321	0.43	0/432
4	AY	0.24	0/321	0.42	0/432
4	AZ	0.25	0/321	0.42	0/432
4	BA	0.25	0/321	0.43	0/432
4	BH	0.24	0/321	0.43	0/432

Mol	Chain	Bond lengths		Bond angles	
		RMSZ	# Z >5	RMSZ	# Z >5
4	BI	0.26	0/321	0.43	0/432
4	BJ	0.24	0/321	0.43	0/432
4	BQ	0.24	0/253	0.45	0/338
4	BR	0.25	0/321	0.44	0/432
4	BS	0.24	0/321	0.43	0/432
4	BZ	0.24	0/321	0.42	0/432
4	CA	0.24	0/237	0.45	0/316
4	CB	0.24	0/260	0.45	0/349
4	CI	0.25	0/321	0.44	0/432
4	CJ	0.24	0/260	0.45	0/349
4	CK	0.25	0/321	0.43	0/432
4	CR	0.25	0/321	0.43	0/432
4	CS	0.24	0/321	0.42	0/432
4	CT	0.24	0/260	0.45	0/349
4	CX	0.25	0/272	0.44	0/365
4	CY	0.25	0/272	0.45	0/365
4	CZ	0.24	0/272	0.44	0/365
4	DH	0.25	0/321	0.43	0/432
4	DI	0.24	0/260	0.45	0/349
4	DP	0.24	0/321	0.43	0/432
4	DQ	0.24	0/321	0.42	0/432
4	DR	0.25	0/321	0.43	0/432
4	DY	0.25	0/321	0.42	0/432
4	DZ	0.25	0/321	0.42	0/432
4	EA	0.25	0/321	0.43	0/432
4	EH	0.24	0/321	0.42	0/432
4	EI	0.25	0/321	0.43	0/432
4	EJ	0.25	0/321	0.43	0/432
4	EQ	0.24	0/253	0.45	0/338
4	ER	0.25	0/321	0.43	0/432
4	ES	0.24	0/321	0.43	0/432
4	EZ	0.24	0/321	0.42	0/432
4	FA	0.25	0/321	0.43	0/432
4	FB	0.24	0/260	0.45	0/349
4	FI	0.25	0/321	0.43	0/432
4	FJ	0.24	0/260	0.44	0/349
4	FK	0.25	0/321	0.43	0/432
4	FR	0.25	0/321	0.43	0/432
4	FS	0.25	0/321	0.42	0/432
4	FT	0.25	0/260	0.45	0/349
4	FX	0.25	0/272	0.44	0/365
4	FY	0.25	0/272	0.45	0/365
4	FZ	0.25	0/272	0.44	0/365

Mol	Chain	Bond lengths		Bond angles	
		RMSZ	# Z >5	RMSZ	# Z >5
4	GH	0.25	0/321	0.43	0/432
4	GI	0.24	0/260	0.45	0/349
4	GP	0.24	0/321	0.42	0/432
4	GQ	0.25	0/321	0.42	0/432
4	GR	0.25	0/321	0.43	0/432
4	GY	0.24	0/321	0.42	0/432
4	GZ	0.25	0/321	0.42	0/432
4	HA	0.24	0/321	0.42	0/432
4	HH	0.24	0/321	0.42	0/432
4	HI	0.25	0/321	0.43	0/432
4	HJ	0.24	0/321	0.43	0/432
4	HQ	0.24	0/253	0.44	0/338
4	HR	0.25	0/321	0.43	0/432
4	HS	0.24	0/321	0.43	0/432
4	HZ	0.24	0/321	0.42	0/432
4	IA	0.25	0/321	0.43	0/432
4	IB	0.24	0/260	0.45	0/349
4	II	0.25	0/321	0.43	0/432
4	IJ	0.24	0/260	0.44	0/349
4	IK	0.25	0/321	0.43	0/432
4	IR	0.25	0/321	0.43	0/432
4	IS	0.25	0/321	0.42	0/432
4	IT	0.25	0/260	0.44	0/349
4	IX	0.25	0/272	0.44	0/365
4	IY	0.25	0/272	0.45	0/365
4	IZ	0.25	0/272	0.44	0/365
4	JH	0.25	0/321	0.43	0/432
4	JI	0.24	0/260	0.46	0/349
4	JP	0.24	0/321	0.43	0/432
4	JQ	0.24	0/321	0.42	0/432
4	JR	0.25	0/321	0.42	0/432
4	JY	0.24	0/321	0.42	0/432
4	JZ	0.25	0/321	0.43	0/432
4	KA	0.25	0/321	0.42	0/432
4	KH	0.24	0/321	0.43	0/432
4	KI	0.25	0/321	0.44	0/432
4	KJ	0.25	0/321	0.43	0/432
4	KQ	0.24	0/253	0.44	0/338
4	KR	0.25	0/321	0.44	0/432
4	KS	0.24	0/321	0.43	0/432
4	KZ	0.24	0/321	0.42	0/432
4	LA	0.25	0/321	0.44	0/432
4	LB	0.24	0/260	0.44	0/349

Mol	Chain	Bond lengths		Bond angles	
		RMSZ	# Z >5	RMSZ	# Z >5
4	LI	0.25	0/321	0.44	0/432
4	LJ	0.24	0/260	0.44	0/349
4	LK	0.25	0/321	0.43	0/432
4	LR	0.25	0/321	0.43	0/432
4	LS	0.24	0/321	0.42	0/432
4	LT	0.25	0/260	0.45	0/349
4	LX	0.25	0/272	0.44	0/365
4	LY	0.25	0/272	0.46	0/365
4	LZ	0.24	0/272	0.44	0/365
4	MH	0.25	0/321	0.43	0/432
4	MI	0.24	0/260	0.45	0/349
4	MP	0.24	0/321	0.43	0/432
4	MQ	0.25	0/321	0.42	0/432
4	MR	0.25	0/321	0.43	0/432
4	MY	0.24	0/321	0.43	0/432
4	MZ	0.25	0/321	0.42	0/432
4	NA	0.24	0/321	0.43	0/432
4	NH	0.24	0/321	0.43	0/432
4	NI	0.25	0/321	0.44	0/432
4	NJ	0.24	0/321	0.42	0/432
4	NQ	0.24	0/253	0.44	0/338
4	NR	0.24	0/321	0.43	0/432
4	NS	0.24	0/321	0.44	0/432
4	NZ	0.24	0/321	0.42	0/432
4	OA	0.25	0/237	0.45	0/316
4	OB	0.24	0/260	0.45	0/349
4	OI	0.25	0/321	0.43	0/432
4	OJ	0.24	0/260	0.44	0/349
4	OK	0.25	0/321	0.43	0/432
4	OR	0.25	0/321	0.43	0/432
4	OS	0.25	0/321	0.42	0/432
4	OT	0.25	0/260	0.45	0/349
4	OX	0.25	0/272	0.44	0/365
4	OY	0.24	0/272	0.46	0/365
4	OZ	0.24	0/272	0.44	0/365
4	QA	0.24	0/910	0.50	0/1218
4	QB	0.24	0/910	0.49	0/1218
4	QC	0.23	0/723	0.47	0/969
4	QD	0.23	0/723	0.47	0/969
4	QE	0.25	0/910	0.51	0/1218
4	QF	0.23	0/723	0.47	0/969
4	QG	0.25	0/910	0.50	0/1218
4	QH	0.27	0/910	0.54	0/1218

Mol	Chain	Bond lengths		Bond angles	
		RMSZ	# Z >5	RMSZ	# Z >5
4	QI	0.26	0/910	0.51	0/1218
4	QJ	0.24	0/723	0.49	0/969
4	RA	0.24	0/910	0.47	0/1218
4	RB	0.24	0/910	0.48	0/1218
4	SA	0.23	0/910	0.47	0/1218
4	SB	0.24	0/796	0.49	0/1066
4	SC	0.24	0/910	0.47	0/1218
4	SD	0.24	0/796	0.48	0/1066
4	SE	0.24	0/910	0.49	0/1218
4	SF	0.24	0/910	0.47	0/1218
4	SG	0.24	0/796	0.51	0/1066
4	SH	0.25	0/910	0.49	0/1218
4	SI	0.24	0/796	0.47	0/1066
4	SJ	0.24	0/910	0.48	0/1218
4	SK	0.24	0/796	0.50	0/1066
4	SL	0.24	0/910	0.49	0/1218
4	SM	0.23	0/910	0.46	0/1218
4	SN	0.26	0/796	0.50	0/1066
4	SO	0.24	0/910	0.48	0/1218
4	TA	0.24	0/910	0.46	0/1218
4	TB	0.23	0/796	0.47	0/1066
4	TC	0.24	0/910	0.46	0/1218
4	TD	0.24	0/796	0.48	0/1066
4	TE	0.24	0/910	0.47	0/1218
4	TF	0.23	0/796	0.47	0/1066
4	TG	0.24	0/910	0.47	0/1218
4	TH	0.24	0/796	0.48	0/1066
4	TI	0.24	0/910	0.48	0/1218
4	TJ	0.23	0/796	0.47	0/1066
4	TK	0.24	0/910	0.47	0/1218
4	TL	0.24	0/796	0.48	0/1066
4	TM	0.27	0/910	0.48	0/1218
4	TN	0.23	0/796	0.48	0/1066
4	TO	0.23	0/910	0.46	0/1218
4	TP	0.23	0/796	0.47	0/1066
4	TQ	0.24	0/910	0.47	0/1218
4	TR	0.23	0/796	0.47	0/1066
4	TS	0.24	0/910	0.47	0/1218
4	TT	0.24	0/796	0.47	0/1066
4	TU	0.24	0/910	0.48	0/1218
4	TV	0.23	0/796	0.48	0/1066
4	TW	0.24	0/910	0.48	0/1218
4	TX	0.24	0/796	0.47	0/1066

Mol	Chain	Bond lengths		Bond angles	
		RMSZ	# Z >5	RMSZ	# Z >5
4	TY	0.25	0/910	0.47	0/1218
4	TZ	0.23	0/796	0.47	0/1066
4	UA	0.25	0/910	0.48	0/1218
4	UB	0.25	0/796	0.50	0/1066
4	UC	0.26	0/910	0.49	0/1218
4	UD	0.23	0/796	0.47	0/1066
4	UE	0.25	0/910	0.48	0/1218
4	UF	0.23	0/760	0.46	0/1019
4	VA	0.23	0/910	0.45	0/1218
4	VB	0.23	0/796	0.47	0/1066
4	VC	0.23	0/910	0.46	0/1218
4	VD	0.23	0/796	0.47	0/1066
4	VE	0.23	0/910	0.46	0/1218
4	VF	0.23	0/796	0.47	0/1066
4	VG	0.24	0/910	0.46	0/1218
4	VH	0.23	0/796	0.47	0/1066
4	VI	0.23	0/910	0.45	0/1218
4	VJ	0.23	0/796	0.47	0/1066
4	VK	0.23	0/910	0.46	0/1218
4	VL	0.23	0/796	0.47	0/1066
4	VM	0.23	0/910	0.45	0/1218
4	VN	0.23	0/796	0.47	0/1066
4	VO	0.23	0/910	0.46	0/1218
4	VP	0.23	0/796	0.48	0/1066
4	VQ	0.23	0/910	0.45	0/1218
4	VR	0.23	0/796	0.47	0/1066
4	VS	0.23	0/910	0.46	0/1218
4	VT	0.23	0/796	0.47	0/1066
4	VU	0.23	0/910	0.46	0/1218
4	VV	0.23	0/796	0.47	0/1066
4	VW	0.23	0/910	0.45	0/1218
4	VX	0.23	0/796	0.47	0/1066
4	VY	0.23	0/910	0.46	0/1218
4	VZ	0.23	0/796	0.47	0/1066
4	WA	0.23	0/910	0.46	0/1218
4	WB	0.23	0/796	0.47	0/1066
4	WC	0.23	0/910	0.46	0/1218
4	WD	0.23	0/796	0.47	0/1066
4	WE	0.23	0/910	0.46	0/1218
4	WF	0.23	0/796	0.47	0/1066
4	XA	0.23	0/910	0.46	0/1218
4	XB	0.23	0/796	0.47	0/1066
4	XC	0.23	0/910	0.46	0/1218

Mol	Chain	Bond lengths		Bond angles	
		RMSZ	# Z >5	RMSZ	# Z >5
4	XD	0.23	0/796	0.47	0/1066
4	XE	0.23	0/910	0.46	0/1218
4	XF	0.23	0/796	0.47	0/1066
4	XG	0.23	0/910	0.46	0/1218
4	XH	0.23	0/796	0.47	0/1066
4	XI	0.23	0/910	0.46	0/1218
4	XJ	0.23	0/796	0.47	0/1066
4	XK	0.23	0/910	0.46	0/1218
4	XL	0.23	0/796	0.47	0/1066
4	XM	0.23	0/910	0.46	0/1218
4	XN	0.23	0/796	0.47	0/1066
4	XO	0.23	0/910	0.46	0/1218
4	XP	0.23	0/796	0.47	0/1066
4	XQ	0.23	0/910	0.45	0/1218
4	XR	0.23	0/796	0.47	0/1066
4	XS	0.23	0/910	0.46	0/1218
4	XT	0.23	0/796	0.47	0/1066
4	XU	0.23	0/910	0.46	0/1218
4	XV	0.23	0/796	0.47	0/1066
4	XW	0.23	0/910	0.46	0/1218
4	XX	0.23	0/796	0.47	0/1066
4	XY	0.23	0/910	0.46	0/1218
4	XZ	0.23	0/796	0.47	0/1066
4	YA	0.23	0/910	0.46	0/1218
4	YB	0.23	0/796	0.47	0/1066
4	YC	0.23	0/910	0.46	0/1218
4	YD	0.23	0/796	0.47	0/1066
4	YE	0.24	0/910	0.49	0/1218
4	YF	0.23	0/796	0.47	0/1066
5	AM	0.26	0/1274	0.46	0/1721
5	DM	0.26	0/1274	0.46	0/1721
5	GM	0.26	0/1274	0.46	0/1721
5	JM	0.26	0/1274	0.46	0/1721
5	MM	0.26	0/1274	0.46	0/1721
6	PA	0.25	0/2796	0.44	0/3762
6	PB	0.25	0/3008	0.43	0/4051
6	PC	0.25	0/2878	0.44	0/3874
6	PD	0.25	0/2814	0.43	0/3786
6	PE	0.25	0/2937	0.43	0/3954
6	PF	0.25	0/2805	0.44	0/3774
6	PG	0.25	0/2838	0.43	0/3818
6	PH	0.25	0/2879	0.43	0/3874
6	PI	0.25	0/2803	0.42	0/3771

Mol	Chain	Bond lengths		Bond angles	
		RMSZ	# Z >5	RMSZ	# Z >5
6	PJ	0.25	0/2937	0.43	0/3954
6	PK	0.25	0/2943	0.45	0/3962
6	PL	0.25	0/3050	0.43	0/4107
All	All	0.24	0/648660	0.44	0/874123

There are no bond length outliers.

There are no bond angle outliers.

There are no chirality outliers.

There are no planarity outliers.

5.2 Too-close contacts [\(i\)](#)

In the following table, the Non-H and H(model) columns list the number of non-hydrogen atoms and hydrogen atoms in the chain respectively. The H(added) column lists the number of hydrogen atoms added and optimized by MolProbity. The Clashes column lists the number of clashes within the asymmetric unit, whereas Symm-Clashes lists symmetry-related clashes.

Mol	Chain	Non-H	H(model)	H(added)	Clashes	Symm-Clashes
1	AB	2510	0	2547	28	0
1	AC	2405	0	2453	28	0
1	AJ	2488	0	2527	28	0
1	AK	2510	0	2547	30	0
1	AL	2510	0	2547	29	0
1	AS	2488	0	2527	28	0
1	AT	2510	0	2547	29	0
1	AU	2510	0	2547	32	0
1	BB	2488	0	2527	26	0
1	BC	2510	0	2547	40	0
1	BD	2510	0	2547	26	0
1	BK	2505	0	2545	31	0
1	BL	2510	0	2547	27	0
1	BM	2510	0	2547	32	0
1	BT	2488	0	2527	29	0
1	BU	2510	0	2547	32	0
1	BV	2505	0	2545	34	0
1	CC	2510	0	2547	36	0
1	CD	2383	0	2425	31	0
1	CE	2510	0	2547	41	0
1	CL	2510	0	2547	39	0
1	CM	2510	0	2547	28	0

Continued on next page...

Continued from previous page...

Mol	Chain	Non-H	H(model)	H(added)	Clashes	Symm-Clashes
1	CN	2383	0	2425	17	0
1	CU	2510	0	2547	38	0
1	CV	2510	0	2547	29	0
1	CW	2510	0	2547	34	0
1	DB	2510	0	2547	28	0
1	DC	2405	0	2453	28	0
1	DJ	2488	0	2527	29	0
1	DK	2510	0	2547	29	0
1	DL	2510	0	2547	30	0
1	DS	2488	0	2527	29	0
1	DT	2510	0	2547	30	0
1	DU	2510	0	2547	32	0
1	EB	2488	0	2527	24	0
1	EC	2510	0	2547	42	0
1	ED	2510	0	2547	26	0
1	EK	2505	0	2545	33	0
1	EL	2510	0	2547	26	0
1	EM	2510	0	2547	32	0
1	ET	2488	0	2527	30	0
1	EU	2510	0	2547	31	0
1	EV	2505	0	2545	33	0
1	FC	2510	0	2547	34	0
1	FD	2383	0	2425	30	0
1	FE	2510	0	2547	39	0
1	FL	2510	0	2547	39	0
1	FM	2510	0	2547	28	0
1	FN	2383	0	2425	19	0
1	FU	2510	0	2547	38	0
1	FV	2510	0	2547	29	0
1	FW	2510	0	2547	35	0
1	GB	2510	0	2547	26	0
1	GC	2405	0	2453	28	0
1	GJ	2488	0	2527	29	0
1	GK	2510	0	2547	29	0
1	GL	2510	0	2547	32	0
1	GS	2488	0	2527	26	0
1	GT	2510	0	2547	30	0
1	GU	2510	0	2547	32	0
1	HB	2488	0	2527	26	0
1	HC	2510	0	2547	41	0
1	HD	2510	0	2547	27	0
1	HK	2505	0	2545	31	0

Continued on next page...

Continued from previous page...

Mol	Chain	Non-H	H(model)	H(added)	Clashes	Symm-Clashes
1	HL	2510	0	2547	25	0
1	HM	2510	0	2547	31	0
1	HT	2488	0	2527	32	0
1	HU	2510	0	2547	31	0
1	HV	2505	0	2545	35	0
1	IC	2510	0	2547	35	0
1	ID	2383	0	2425	29	0
1	IE	2510	0	2547	43	0
1	IL	2510	0	2547	38	0
1	IM	2510	0	2547	27	0
1	IN	2383	0	2425	19	0
1	IU	2510	0	2547	38	0
1	IV	2510	0	2547	30	0
1	IW	2510	0	2547	35	0
1	JB	2510	0	2547	27	0
1	JC	2405	0	2453	29	0
1	JJ	2488	0	2527	28	0
1	JK	2510	0	2547	28	0
1	JL	2510	0	2547	29	0
1	JS	2488	0	2527	28	0
1	JT	2510	0	2547	30	0
1	JU	2510	0	2547	32	0
1	KB	2488	0	2527	26	0
1	KC	2510	0	2547	42	0
1	KD	2510	0	2547	27	0
1	KK	2505	0	2545	31	0
1	KL	2510	0	2547	26	0
1	KM	2510	0	2547	30	0
1	KT	2488	0	2527	31	0
1	KU	2510	0	2547	31	0
1	KV	2505	0	2545	34	0
1	LC	2510	0	2547	33	0
1	LD	2383	0	2425	30	0
1	LE	2510	0	2547	42	0
1	LL	2510	0	2547	41	0
1	LM	2510	0	2547	28	0
1	LN	2383	0	2425	20	0
1	LU	2510	0	2547	35	0
1	LV	2510	0	2547	29	0
1	LW	2510	0	2547	32	0
1	MB	2510	0	2547	28	0
1	MC	2405	0	2453	28	0

Continued on next page...

Continued from previous page...

Mol	Chain	Non-H	H(model)	H(added)	Clashes	Symm-Clashes
1	MJ	2488	0	2527	29	0
1	MK	2510	0	2547	27	0
1	ML	2510	0	2547	30	0
1	MS	2488	0	2527	30	0
1	MT	2510	0	2547	29	0
1	MU	2510	0	2547	32	0
1	NB	2488	0	2527	26	0
1	NC	2510	0	2547	40	0
1	ND	2510	0	2547	23	0
1	NK	2505	0	2545	31	0
1	NL	2510	0	2547	25	0
1	NM	2510	0	2547	32	0
1	NT	2488	0	2527	32	0
1	NU	2510	0	2547	30	0
1	NV	2505	0	2545	34	0
1	OC	2510	0	2547	35	0
1	OD	2383	0	2425	30	0
1	OE	2510	0	2547	39	0
1	OL	2510	0	2547	35	0
1	OM	2510	0	2547	29	0
1	ON	2383	0	2425	20	0
1	OU	2510	0	2547	39	0
1	OV	2510	0	2547	29	0
1	OW	2510	0	2547	32	0
2	AD	917	0	912	7	0
2	AO	1198	0	1172	25	0
2	AW	1164	0	1145	8	0
2	AX	1211	0	1188	16	0
2	BF	1194	0	1164	13	0
2	BG	1173	0	1158	20	0
2	BN	1337	0	1324	12	0
2	BO	1165	0	1147	11	0
2	BW	1189	0	1159	13	0
2	BX	1275	0	1263	10	0
2	CF	1288	0	1279	16	0
2	CG	1160	0	1142	15	0
2	CH	1173	0	1158	23	0
2	CP	1165	0	1147	15	0
2	CQ	1304	0	1299	12	0
2	DD	917	0	912	7	0
2	DO	1198	0	1172	23	0
2	DW	1164	0	1145	9	0

Continued on next page...

Continued from previous page...

Mol	Chain	Non-H	H(model)	H(added)	Clashes	Symm-Clashes
2	DX	1211	0	1188	15	0
2	EF	1194	0	1164	12	0
2	EG	1173	0	1158	19	0
2	EN	1337	0	1324	13	0
2	EO	1165	0	1147	11	0
2	EW	1189	0	1159	14	0
2	EX	1275	0	1263	11	0
2	FF	1288	0	1279	17	0
2	FG	1160	0	1142	14	0
2	FH	1173	0	1158	22	0
2	FP	1165	0	1147	15	0
2	FQ	1304	0	1299	14	0
2	GD	917	0	912	7	0
2	GO	1198	0	1172	22	0
2	GW	1164	0	1145	8	0
2	GX	1211	0	1188	16	0
2	HF	1194	0	1164	14	0
2	HG	1173	0	1158	19	0
2	HN	1337	0	1324	13	0
2	HO	1165	0	1147	11	0
2	HW	1189	0	1159	13	0
2	HX	1275	0	1263	11	0
2	IF	1288	0	1279	17	0
2	IG	1160	0	1142	16	0
2	IH	1173	0	1158	22	0
2	IP	1165	0	1147	16	0
2	IQ	1304	0	1299	14	0
2	JD	917	0	912	7	0
2	JO	1198	0	1172	22	0
2	JW	1164	0	1145	8	0
2	JX	1211	0	1188	18	0
2	KF	1194	0	1164	14	0
2	KG	1173	0	1158	18	0
2	KN	1337	0	1324	14	0
2	KO	1165	0	1147	10	0
2	KW	1189	0	1159	13	0
2	KX	1275	0	1263	12	0
2	LF	1288	0	1279	16	0
2	LG	1160	0	1142	15	0
2	LH	1173	0	1158	21	0
2	LP	1165	0	1147	15	0
2	LQ	1304	0	1299	13	0

Continued on next page...

Continued from previous page...

Mol	Chain	Non-H	H(model)	H(added)	Clashes	Symm-Clashes
2	MD	917	0	912	7	0
2	MO	1198	0	1172	24	0
2	MW	1164	0	1145	8	0
2	MX	1211	0	1188	16	0
2	NF	1194	0	1164	13	0
2	NG	1173	0	1158	18	0
2	NN	1337	0	1324	13	0
2	NO	1165	0	1147	11	0
2	NW	1189	0	1159	13	0
2	NX	1275	0	1263	12	0
2	OF	1288	0	1279	19	0
2	OG	1160	0	1142	15	0
2	OH	1173	0	1158	22	0
2	OP	1165	0	1147	14	0
2	OQ	1304	0	1299	12	0
3	AF	1137	0	1125	11	0
3	AN	1187	0	1176	14	0
3	AV	1208	0	1203	11	0
3	BE	1208	0	1203	19	0
3	BP	1186	0	1176	12	0
3	BY	1186	0	1176	20	0
3	CO	1195	0	1189	18	0
3	DF	1137	0	1125	13	0
3	DN	1187	0	1176	13	0
3	DV	1208	0	1203	11	0
3	EE	1208	0	1203	18	0
3	EP	1186	0	1176	12	0
3	EY	1186	0	1176	22	0
3	FO	1195	0	1189	19	0
3	GF	1137	0	1125	12	0
3	GN	1187	0	1176	12	0
3	GV	1208	0	1203	11	0
3	HE	1208	0	1203	19	0
3	HP	1186	0	1176	13	0
3	HY	1186	0	1176	23	0
3	IO	1195	0	1189	20	0
3	JF	1137	0	1125	12	0
3	JN	1187	0	1176	13	0
3	JV	1208	0	1203	11	0
3	KE	1208	0	1203	19	0
3	KP	1186	0	1176	13	0
3	KY	1186	0	1176	21	0

Continued on next page...

Continued from previous page...

Mol	Chain	Non-H	H(model)	H(added)	Clashes	Symm-Clashes
3	LO	1195	0	1189	19	0
3	MF	1137	0	1125	12	0
3	MN	1187	0	1176	13	0
3	MV	1208	0	1203	11	0
3	NE	1208	0	1203	19	0
3	NP	1186	0	1176	12	0
3	NY	1186	0	1176	20	0
3	OO	1195	0	1189	19	0
4	AH	315	0	312	2	0
4	AI	255	0	256	1	0
4	AP	315	0	312	2	0
4	AQ	315	0	312	0	0
4	AR	315	0	312	0	0
4	AY	315	0	312	2	0
4	AZ	315	0	312	2	0
4	BA	315	0	312	0	0
4	BH	315	0	312	0	0
4	BI	315	0	312	4	0
4	BJ	315	0	312	1	0
4	BQ	248	0	248	0	0
4	BR	315	0	312	0	0
4	BS	315	0	312	2	0
4	BZ	315	0	312	2	0
4	CA	233	0	229	1	0
4	CB	255	0	256	1	0
4	CI	315	0	312	3	0
4	CJ	255	0	256	0	0
4	CK	315	0	312	1	0
4	CR	315	0	312	2	0
4	CS	315	0	312	0	0
4	CT	255	0	256	3	0
4	CX	266	0	265	2	0
4	CY	266	0	265	0	0
4	CZ	266	0	265	1	0
4	DH	315	0	312	2	0
4	DI	255	0	256	1	0
4	DP	315	0	312	2	0
4	DQ	315	0	312	1	0
4	DR	315	0	312	0	0
4	DY	315	0	312	3	0
4	DZ	315	0	312	2	0
4	EA	315	0	312	0	0

Continued on next page...

Continued from previous page...

Mol	Chain	Non-H	H(model)	H(added)	Clashes	Symm-Clashes
4	EH	315	0	312	1	0
4	EI	315	0	312	4	0
4	EJ	315	0	312	1	0
4	EQ	248	0	248	0	0
4	ER	315	0	312	0	0
4	ES	315	0	312	2	0
4	EZ	315	0	312	2	0
4	FA	315	0	312	1	0
4	FB	255	0	256	1	0
4	FI	315	0	312	1	0
4	FJ	255	0	256	0	0
4	FK	315	0	312	1	0
4	FR	315	0	312	3	0
4	FS	315	0	312	0	0
4	FT	255	0	256	2	0
4	FX	266	0	265	2	0
4	FY	266	0	265	0	0
4	FZ	266	0	265	1	0
4	GH	315	0	312	2	0
4	GI	255	0	256	1	0
4	GP	315	0	312	2	0
4	GQ	315	0	312	1	0
4	GR	315	0	312	0	0
4	GY	315	0	312	3	0
4	GZ	315	0	312	2	0
4	HA	315	0	312	0	0
4	HH	315	0	312	1	0
4	HI	315	0	312	4	0
4	HJ	315	0	312	1	0
4	HQ	248	0	248	0	0
4	HR	315	0	312	0	0
4	HS	315	0	312	1	0
4	HZ	315	0	312	2	0
4	IA	315	0	312	1	0
4	IB	255	0	256	1	0
4	II	315	0	312	1	0
4	IJ	255	0	256	0	0
4	IK	315	0	312	1	0
4	IR	315	0	312	3	0
4	IS	315	0	312	0	0
4	IT	255	0	256	3	0
4	IX	266	0	265	3	0

Continued on next page...

Continued from previous page...

Mol	Chain	Non-H	H(model)	H(added)	Clashes	Symm-Clashes
4	IY	266	0	265	0	0
4	IZ	266	0	265	1	0
4	JH	315	0	312	2	0
4	JI	255	0	256	1	0
4	JP	315	0	312	2	0
4	JQ	315	0	312	1	0
4	JR	315	0	312	0	0
4	JY	315	0	312	3	0
4	JZ	315	0	312	2	0
4	KA	315	0	312	0	0
4	KH	315	0	312	0	0
4	KI	315	0	312	4	0
4	KJ	315	0	312	1	0
4	KQ	248	0	248	0	0
4	KR	315	0	312	0	0
4	KS	315	0	312	0	0
4	KZ	315	0	312	2	0
4	LA	315	0	312	1	0
4	LB	255	0	256	1	0
4	LI	315	0	312	1	0
4	LJ	255	0	256	0	0
4	LK	315	0	312	1	0
4	LR	315	0	312	2	0
4	LS	315	0	312	0	0
4	LT	255	0	256	3	0
4	LX	266	0	265	2	0
4	LY	266	0	265	0	0
4	LZ	266	0	265	1	0
4	MH	315	0	312	2	0
4	MI	255	0	256	1	0
4	MP	315	0	312	2	0
4	MQ	315	0	312	1	0
4	MR	315	0	312	0	0
4	MY	315	0	312	2	0
4	MZ	315	0	312	2	0
4	NA	315	0	312	0	0
4	NH	315	0	312	1	0
4	NI	315	0	312	4	0
4	NJ	315	0	312	1	0
4	NQ	248	0	248	0	0
4	NR	315	0	312	0	0
4	NS	315	0	312	1	0

Continued on next page...

Continued from previous page...

Mol	Chain	Non-H	H(model)	H(added)	Clashes	Symm-Clashes
4	NZ	315	0	312	2	0
4	OA	233	0	229	1	0
4	OB	255	0	256	1	0
4	OI	315	0	312	2	0
4	OJ	255	0	256	0	0
4	OK	315	0	312	1	0
4	OR	315	0	312	2	0
4	OS	315	0	312	0	0
4	OT	255	0	256	3	0
4	OX	266	0	265	3	0
4	OY	266	0	265	0	0
4	OZ	266	0	265	1	0
4	QA	904	0	967	20	0
4	QB	904	0	967	28	0
4	QC	717	0	773	12	0
4	QD	717	0	773	13	0
4	QE	904	0	967	25	0
4	QF	717	0	773	14	0
4	QG	904	0	967	27	0
4	QH	904	0	967	49	0
4	QI	904	0	967	37	0
4	QJ	717	0	773	16	0
4	RA	904	0	967	31	0
4	RB	904	0	967	33	0
4	SA	904	0	967	16	0
4	SB	790	0	843	25	0
4	SC	904	0	967	30	0
4	SD	790	0	843	27	0
4	SE	904	0	967	26	0
4	SF	904	0	967	15	0
4	SG	790	0	843	21	0
4	SH	904	0	967	30	0
4	SI	790	0	843	30	0
4	SJ	904	0	967	38	0
4	SK	790	0	843	27	0
4	SL	904	0	967	32	0
4	SM	904	0	967	18	0
4	SN	790	0	843	32	0
4	SO	904	0	967	27	0
4	TA	904	0	967	20	0
4	TB	790	0	843	19	0
4	TC	904	0	967	20	0

Continued on next page...

Continued from previous page...

Mol	Chain	Non-H	H(model)	H(added)	Clashes	Symm-Clashes
4	TD	790	0	843	27	0
4	TE	904	0	967	18	0
4	TF	790	0	843	21	0
4	TG	904	0	967	27	0
4	TH	790	0	843	32	0
4	TI	904	0	967	33	0
4	TJ	790	0	843	23	0
4	TK	904	0	967	30	0
4	TL	790	0	843	29	0
4	TM	904	0	967	25	0
4	TN	790	0	843	26	0
4	TO	904	0	967	26	0
4	TP	790	0	843	16	0
4	TQ	904	0	967	29	0
4	TR	790	0	843	26	0
4	TS	904	0	967	27	0
4	TT	790	0	843	27	0
4	TU	904	0	967	27	0
4	TV	790	0	843	26	0
4	TW	904	0	967	29	0
4	TX	790	0	843	23	0
4	TY	904	0	967	32	0
4	TZ	790	0	843	19	0
4	UA	904	0	967	25	0
4	UB	790	0	843	33	0
4	UC	904	0	967	22	0
4	UD	790	0	843	24	0
4	UE	904	0	967	32	0
4	UF	754	0	795	21	0
4	VA	904	0	967	16	0
4	VB	790	0	843	18	0
4	VC	904	0	967	13	0
4	VD	790	0	843	17	0
4	VE	904	0	967	19	0
4	VF	790	0	843	16	0
4	VG	904	0	967	19	0
4	VH	790	0	843	16	0
4	VI	904	0	967	20	0
4	VJ	790	0	843	19	0
4	VK	904	0	967	19	0
4	VL	790	0	843	16	0
4	VM	904	0	967	17	0

Continued on next page...

Continued from previous page...

Mol	Chain	Non-H	H(model)	H(added)	Clashes	Symm-Clashes
4	VN	790	0	843	16	0
4	VO	904	0	967	19	0
4	VP	790	0	843	17	0
4	VQ	904	0	967	17	0
4	VR	790	0	843	19	0
4	VS	904	0	967	18	0
4	VT	790	0	843	21	0
4	VU	904	0	967	19	0
4	VV	790	0	843	19	0
4	VW	904	0	967	18	0
4	VX	790	0	843	17	0
4	VY	904	0	967	18	0
4	VZ	790	0	843	20	0
4	WA	904	0	967	17	0
4	WB	790	0	843	17	0
4	WC	904	0	967	16	0
4	WD	790	0	843	18	0
4	WE	904	0	967	22	0
4	WF	790	0	843	18	0
4	XA	904	0	967	15	0
4	XB	790	0	843	18	0
4	XC	904	0	967	15	0
4	XD	790	0	843	18	0
4	XE	904	0	967	15	0
4	XF	790	0	843	17	0
4	XG	904	0	967	14	0
4	XH	790	0	843	18	0
4	XI	904	0	967	15	0
4	XJ	790	0	843	17	0
4	XK	904	0	967	15	0
4	XL	790	0	843	17	0
4	XM	904	0	967	15	0
4	XN	790	0	843	18	0
4	XO	904	0	967	14	0
4	XP	790	0	843	19	0
4	XQ	904	0	967	16	0
4	XR	790	0	843	18	0
4	XS	904	0	967	16	0
4	XT	790	0	843	17	0
4	XU	904	0	967	15	0
4	XV	790	0	843	18	0
4	XW	904	0	967	15	0

Continued on next page...

Continued from previous page...

Mol	Chain	Non-H	H(model)	H(added)	Clashes	Symm-Clashes
4	XX	790	0	843	18	0
4	XY	904	0	967	15	0
4	XZ	790	0	843	16	0
4	YA	904	0	967	15	0
4	YB	790	0	843	18	0
4	YC	904	0	967	14	0
4	YD	790	0	843	19	0
4	YE	904	0	967	22	0
4	YF	790	0	843	18	0
5	AM	1252	0	1235	16	0
5	DM	1252	0	1235	16	0
5	GM	1252	0	1235	16	0
5	JM	1252	0	1235	15	0
5	MM	1252	0	1235	15	0
6	PA	2747	0	2752	31	0
6	PB	2959	0	2961	38	0
6	PC	2829	0	2837	34	0
6	PD	2765	0	2771	39	0
6	PE	2888	0	2894	37	0
6	PF	2756	0	2760	33	0
6	PG	2789	0	2793	29	0
6	PH	2830	0	2833	30	0
6	PI	2754	0	2757	25	0
6	PJ	2888	0	2894	35	0
6	PK	2894	0	2899	38	0
6	PL	3000	0	2998	41	0
All	All	638242	0	648519	7437	0

The all-atom clashscore is defined as the number of clashes found per 1000 atoms (including hydrogen atoms). The all-atom clashscore for this structure is 6.

The worst 5 of 7437 close contacts within the same asymmetric unit are listed below, sorted by their clash magnitude.

Atom-1	Atom-2	Interatomic distance (Å)	Clash overlap (Å)
4:SF:80:ALA:HB1	4:SG:84:ASN:HB2	1.58	0.85
6:PE:195:GLU:HA	6:PE:199:GLN:HG2	1.57	0.85
4:QI:80:ALA:HB3	4:RB:80:ALA:HB3	1.58	0.85
6:PB:195:GLU:HA	6:PB:199:GLN:HG2	1.58	0.83
6:PL:195:GLU:HA	6:PL:199:GLN:HG2	1.60	0.83

There are no symmetry-related clashes.

5.3 Torsion angles [i](#)

5.3.1 Protein backbone [i](#)

In the following table, the Percentiles column shows the percent Ramachandran outliers of the chain as a percentile score with respect to all PDB entries followed by that with respect to all EM entries.

The Analysed column shows the number of residues for which the backbone conformation was analysed, and the total number of residues.

Mol	Chain	Analysed	Favoured	Allowed	Outliers	Percentiles	
1	AB	309/319 (97%)	303 (98%)	6 (2%)	0	100	100
1	AC	294/319 (92%)	289 (98%)	5 (2%)	0	100	100
1	AJ	305/319 (96%)	303 (99%)	2 (1%)	0	100	100
1	AK	309/319 (97%)	306 (99%)	3 (1%)	0	100	100
1	AL	309/319 (97%)	304 (98%)	5 (2%)	0	100	100
1	AS	305/319 (96%)	300 (98%)	5 (2%)	0	100	100
1	AT	309/319 (97%)	306 (99%)	3 (1%)	0	100	100
1	AU	309/319 (97%)	303 (98%)	6 (2%)	0	100	100
1	BB	305/319 (96%)	301 (99%)	4 (1%)	0	100	100
1	BC	309/319 (97%)	305 (99%)	4 (1%)	0	100	100
1	BD	309/319 (97%)	306 (99%)	3 (1%)	0	100	100
1	BK	307/319 (96%)	302 (98%)	5 (2%)	0	100	100
1	BL	309/319 (97%)	306 (99%)	3 (1%)	0	100	100
1	BM	309/319 (97%)	305 (99%)	4 (1%)	0	100	100
1	BT	305/319 (96%)	302 (99%)	3 (1%)	0	100	100
1	BU	309/319 (97%)	308 (100%)	1 (0%)	0	100	100
1	BV	307/319 (96%)	302 (98%)	5 (2%)	0	100	100
1	CC	309/319 (97%)	306 (99%)	3 (1%)	0	100	100
1	CD	293/319 (92%)	288 (98%)	5 (2%)	0	100	100
1	CE	309/319 (97%)	306 (99%)	3 (1%)	0	100	100
1	CL	309/319 (97%)	306 (99%)	3 (1%)	0	100	100
1	CM	309/319 (97%)	306 (99%)	3 (1%)	0	100	100
1	CN	293/319 (92%)	287 (98%)	6 (2%)	0	100	100
1	CU	309/319 (97%)	305 (99%)	4 (1%)	0	100	100
1	CV	309/319 (97%)	305 (99%)	4 (1%)	0	100	100

Continued on next page...

Continued from previous page...

Mol	Chain	Analysed	Favoured	Allowed	Outliers	Percentiles	
1	CW	309/319 (97%)	307 (99%)	2 (1%)	0	100	100
1	DB	309/319 (97%)	303 (98%)	6 (2%)	0	100	100
1	DC	294/319 (92%)	288 (98%)	6 (2%)	0	100	100
1	DJ	305/319 (96%)	303 (99%)	2 (1%)	0	100	100
1	DK	309/319 (97%)	305 (99%)	4 (1%)	0	100	100
1	DL	309/319 (97%)	304 (98%)	5 (2%)	0	100	100
1	DS	305/319 (96%)	301 (99%)	4 (1%)	0	100	100
1	DT	309/319 (97%)	306 (99%)	3 (1%)	0	100	100
1	DU	309/319 (97%)	304 (98%)	5 (2%)	0	100	100
1	EB	305/319 (96%)	301 (99%)	4 (1%)	0	100	100
1	EC	309/319 (97%)	305 (99%)	4 (1%)	0	100	100
1	ED	309/319 (97%)	306 (99%)	3 (1%)	0	100	100
1	EK	307/319 (96%)	302 (98%)	5 (2%)	0	100	100
1	EL	309/319 (97%)	306 (99%)	3 (1%)	0	100	100
1	EM	309/319 (97%)	305 (99%)	4 (1%)	0	100	100
1	ET	305/319 (96%)	302 (99%)	3 (1%)	0	100	100
1	EU	309/319 (97%)	308 (100%)	1 (0%)	0	100	100
1	EV	307/319 (96%)	302 (98%)	5 (2%)	0	100	100
1	FC	309/319 (97%)	306 (99%)	3 (1%)	0	100	100
1	FD	293/319 (92%)	288 (98%)	5 (2%)	0	100	100
1	FE	309/319 (97%)	306 (99%)	3 (1%)	0	100	100
1	FL	309/319 (97%)	306 (99%)	3 (1%)	0	100	100
1	FM	309/319 (97%)	306 (99%)	3 (1%)	0	100	100
1	FN	293/319 (92%)	287 (98%)	6 (2%)	0	100	100
1	FU	309/319 (97%)	305 (99%)	4 (1%)	0	100	100
1	FV	309/319 (97%)	306 (99%)	3 (1%)	0	100	100
1	FW	309/319 (97%)	307 (99%)	2 (1%)	0	100	100
1	GB	309/319 (97%)	303 (98%)	6 (2%)	0	100	100
1	GC	294/319 (92%)	288 (98%)	6 (2%)	0	100	100
1	GJ	305/319 (96%)	303 (99%)	2 (1%)	0	100	100
1	GK	309/319 (97%)	305 (99%)	4 (1%)	0	100	100

Continued on next page...

Continued from previous page...

Mol	Chain	Analysed	Favoured	Allowed	Outliers	Percentiles	
1	GL	309/319 (97%)	304 (98%)	5 (2%)	0	100	100
1	GS	305/319 (96%)	301 (99%)	4 (1%)	0	100	100
1	GT	309/319 (97%)	306 (99%)	3 (1%)	0	100	100
1	GU	309/319 (97%)	304 (98%)	5 (2%)	0	100	100
1	HB	305/319 (96%)	301 (99%)	4 (1%)	0	100	100
1	HC	309/319 (97%)	305 (99%)	4 (1%)	0	100	100
1	HD	309/319 (97%)	306 (99%)	3 (1%)	0	100	100
1	HK	307/319 (96%)	302 (98%)	5 (2%)	0	100	100
1	HL	309/319 (97%)	305 (99%)	4 (1%)	0	100	100
1	HM	309/319 (97%)	305 (99%)	4 (1%)	0	100	100
1	HT	305/319 (96%)	302 (99%)	3 (1%)	0	100	100
1	HU	309/319 (97%)	308 (100%)	1 (0%)	0	100	100
1	HV	307/319 (96%)	302 (98%)	5 (2%)	0	100	100
1	IC	309/319 (97%)	306 (99%)	3 (1%)	0	100	100
1	ID	293/319 (92%)	289 (99%)	4 (1%)	0	100	100
1	IE	309/319 (97%)	306 (99%)	3 (1%)	0	100	100
1	IL	309/319 (97%)	306 (99%)	3 (1%)	0	100	100
1	IM	309/319 (97%)	306 (99%)	3 (1%)	0	100	100
1	IN	293/319 (92%)	288 (98%)	5 (2%)	0	100	100
1	IU	309/319 (97%)	305 (99%)	4 (1%)	0	100	100
1	IV	309/319 (97%)	306 (99%)	3 (1%)	0	100	100
1	IW	309/319 (97%)	307 (99%)	2 (1%)	0	100	100
1	JB	309/319 (97%)	303 (98%)	6 (2%)	0	100	100
1	JC	294/319 (92%)	288 (98%)	6 (2%)	0	100	100
1	JJ	305/319 (96%)	303 (99%)	2 (1%)	0	100	100
1	JK	309/319 (97%)	306 (99%)	3 (1%)	0	100	100
1	JL	309/319 (97%)	304 (98%)	5 (2%)	0	100	100
1	JS	305/319 (96%)	301 (99%)	4 (1%)	0	100	100
1	JT	309/319 (97%)	306 (99%)	3 (1%)	0	100	100
1	JU	309/319 (97%)	304 (98%)	5 (2%)	0	100	100
1	KB	305/319 (96%)	301 (99%)	4 (1%)	0	100	100

Continued on next page...

Continued from previous page...

Mol	Chain	Analysed	Favoured	Allowed	Outliers	Percentiles	
1	KC	309/319 (97%)	305 (99%)	4 (1%)	0	100	100
1	KD	309/319 (97%)	306 (99%)	3 (1%)	0	100	100
1	KK	307/319 (96%)	302 (98%)	5 (2%)	0	100	100
1	KL	309/319 (97%)	305 (99%)	4 (1%)	0	100	100
1	KM	309/319 (97%)	305 (99%)	4 (1%)	0	100	100
1	KT	305/319 (96%)	302 (99%)	3 (1%)	0	100	100
1	KU	309/319 (97%)	308 (100%)	1 (0%)	0	100	100
1	KV	307/319 (96%)	302 (98%)	5 (2%)	0	100	100
1	LC	309/319 (97%)	306 (99%)	3 (1%)	0	100	100
1	LD	293/319 (92%)	288 (98%)	5 (2%)	0	100	100
1	LE	309/319 (97%)	306 (99%)	3 (1%)	0	100	100
1	LL	309/319 (97%)	306 (99%)	3 (1%)	0	100	100
1	LM	309/319 (97%)	306 (99%)	3 (1%)	0	100	100
1	LN	293/319 (92%)	287 (98%)	6 (2%)	0	100	100
1	LU	309/319 (97%)	305 (99%)	4 (1%)	0	100	100
1	LV	309/319 (97%)	305 (99%)	4 (1%)	0	100	100
1	LW	309/319 (97%)	307 (99%)	2 (1%)	0	100	100
1	MB	309/319 (97%)	303 (98%)	6 (2%)	0	100	100
1	MC	294/319 (92%)	288 (98%)	6 (2%)	0	100	100
1	MJ	305/319 (96%)	303 (99%)	2 (1%)	0	100	100
1	MK	309/319 (97%)	305 (99%)	4 (1%)	0	100	100
1	ML	309/319 (97%)	304 (98%)	5 (2%)	0	100	100
1	MS	305/319 (96%)	301 (99%)	4 (1%)	0	100	100
1	MT	309/319 (97%)	306 (99%)	3 (1%)	0	100	100
1	MU	309/319 (97%)	303 (98%)	6 (2%)	0	100	100
1	NB	305/319 (96%)	301 (99%)	4 (1%)	0	100	100
1	NC	309/319 (97%)	305 (99%)	4 (1%)	0	100	100
1	ND	309/319 (97%)	306 (99%)	3 (1%)	0	100	100
1	NK	307/319 (96%)	302 (98%)	5 (2%)	0	100	100
1	NL	309/319 (97%)	305 (99%)	4 (1%)	0	100	100
1	NM	309/319 (97%)	305 (99%)	4 (1%)	0	100	100

Continued on next page...

Continued from previous page...

Mol	Chain	Analysed	Favoured	Allowed	Outliers	Percentiles	
1	NT	305/319 (96%)	302 (99%)	3 (1%)	0	100	100
1	NU	309/319 (97%)	308 (100%)	1 (0%)	0	100	100
1	NV	307/319 (96%)	302 (98%)	5 (2%)	0	100	100
1	OC	309/319 (97%)	306 (99%)	3 (1%)	0	100	100
1	OD	293/319 (92%)	288 (98%)	5 (2%)	0	100	100
1	OE	309/319 (97%)	306 (99%)	3 (1%)	0	100	100
1	OL	309/319 (97%)	306 (99%)	3 (1%)	0	100	100
1	OM	309/319 (97%)	306 (99%)	3 (1%)	0	100	100
1	ON	293/319 (92%)	287 (98%)	6 (2%)	0	100	100
1	OU	309/319 (97%)	305 (99%)	4 (1%)	0	100	100
1	OV	309/319 (97%)	306 (99%)	3 (1%)	0	100	100
1	OW	309/319 (97%)	307 (99%)	2 (1%)	0	100	100
2	AD	114/185 (62%)	113 (99%)	1 (1%)	0	100	100
2	AO	154/185 (83%)	152 (99%)	2 (1%)	0	100	100
2	AW	147/185 (80%)	146 (99%)	1 (1%)	0	100	100
2	AX	156/185 (84%)	153 (98%)	3 (2%)	0	100	100
2	BF	154/185 (83%)	153 (99%)	1 (1%)	0	100	100
2	BG	148/185 (80%)	147 (99%)	1 (1%)	0	100	100
2	BN	171/185 (92%)	167 (98%)	4 (2%)	0	100	100
2	BO	147/185 (80%)	145 (99%)	2 (1%)	0	100	100
2	BW	153/185 (83%)	152 (99%)	1 (1%)	0	100	100
2	BX	160/185 (86%)	160 (100%)	0	0	100	100
2	CF	162/185 (88%)	161 (99%)	1 (1%)	0	100	100
2	CG	146/185 (79%)	145 (99%)	1 (1%)	0	100	100
2	CH	148/185 (80%)	147 (99%)	1 (1%)	0	100	100
2	CP	147/185 (80%)	146 (99%)	1 (1%)	0	100	100
2	CQ	164/185 (89%)	163 (99%)	1 (1%)	0	100	100
2	DD	114/185 (62%)	113 (99%)	1 (1%)	0	100	100
2	DO	154/185 (83%)	152 (99%)	2 (1%)	0	100	100
2	DW	147/185 (80%)	146 (99%)	1 (1%)	0	100	100
2	DX	156/185 (84%)	152 (97%)	4 (3%)	0	100	100

Continued on next page...

Continued from previous page...

Mol	Chain	Analysed	Favoured	Allowed	Outliers	Percentiles	
2	EF	154/185 (83%)	153 (99%)	1 (1%)	0	100	100
2	EG	148/185 (80%)	147 (99%)	1 (1%)	0	100	100
2	EN	171/185 (92%)	167 (98%)	4 (2%)	0	100	100
2	EO	147/185 (80%)	145 (99%)	2 (1%)	0	100	100
2	EW	153/185 (83%)	152 (99%)	1 (1%)	0	100	100
2	EX	160/185 (86%)	160 (100%)	0	0	100	100
2	FF	162/185 (88%)	161 (99%)	1 (1%)	0	100	100
2	FG	146/185 (79%)	145 (99%)	1 (1%)	0	100	100
2	FH	148/185 (80%)	147 (99%)	1 (1%)	0	100	100
2	FP	147/185 (80%)	146 (99%)	1 (1%)	0	100	100
2	FQ	164/185 (89%)	163 (99%)	1 (1%)	0	100	100
2	GD	114/185 (62%)	113 (99%)	1 (1%)	0	100	100
2	GO	154/185 (83%)	152 (99%)	2 (1%)	0	100	100
2	GW	147/185 (80%)	146 (99%)	1 (1%)	0	100	100
2	GX	156/185 (84%)	153 (98%)	3 (2%)	0	100	100
2	HF	154/185 (83%)	153 (99%)	1 (1%)	0	100	100
2	HG	148/185 (80%)	147 (99%)	1 (1%)	0	100	100
2	HN	171/185 (92%)	167 (98%)	4 (2%)	0	100	100
2	HO	147/185 (80%)	145 (99%)	2 (1%)	0	100	100
2	HW	153/185 (83%)	152 (99%)	1 (1%)	0	100	100
2	HX	160/185 (86%)	160 (100%)	0	0	100	100
2	IF	162/185 (88%)	161 (99%)	1 (1%)	0	100	100
2	IG	146/185 (79%)	145 (99%)	1 (1%)	0	100	100
2	IH	148/185 (80%)	147 (99%)	1 (1%)	0	100	100
2	IP	147/185 (80%)	146 (99%)	1 (1%)	0	100	100
2	IQ	164/185 (89%)	163 (99%)	1 (1%)	0	100	100
2	JD	114/185 (62%)	113 (99%)	1 (1%)	0	100	100
2	JO	154/185 (83%)	152 (99%)	2 (1%)	0	100	100
2	JW	147/185 (80%)	146 (99%)	1 (1%)	0	100	100
2	JX	156/185 (84%)	153 (98%)	3 (2%)	0	100	100
2	KF	154/185 (83%)	153 (99%)	1 (1%)	0	100	100

Continued on next page...

Continued from previous page...

Mol	Chain	Analysed	Favoured	Allowed	Outliers	Percentiles	
2	KG	148/185 (80%)	147 (99%)	1 (1%)	0	100	100
2	KN	171/185 (92%)	167 (98%)	4 (2%)	0	100	100
2	KO	147/185 (80%)	145 (99%)	2 (1%)	0	100	100
2	KW	153/185 (83%)	152 (99%)	1 (1%)	0	100	100
2	KX	160/185 (86%)	159 (99%)	1 (1%)	0	100	100
2	LF	162/185 (88%)	161 (99%)	1 (1%)	0	100	100
2	LG	146/185 (79%)	145 (99%)	1 (1%)	0	100	100
2	LH	148/185 (80%)	147 (99%)	1 (1%)	0	100	100
2	LP	147/185 (80%)	146 (99%)	1 (1%)	0	100	100
2	LQ	164/185 (89%)	163 (99%)	1 (1%)	0	100	100
2	MD	114/185 (62%)	113 (99%)	1 (1%)	0	100	100
2	MO	154/185 (83%)	152 (99%)	2 (1%)	0	100	100
2	MW	147/185 (80%)	146 (99%)	1 (1%)	0	100	100
2	MX	156/185 (84%)	153 (98%)	3 (2%)	0	100	100
2	NF	154/185 (83%)	153 (99%)	1 (1%)	0	100	100
2	NG	148/185 (80%)	147 (99%)	1 (1%)	0	100	100
2	NN	171/185 (92%)	167 (98%)	4 (2%)	0	100	100
2	NO	147/185 (80%)	145 (99%)	2 (1%)	0	100	100
2	NW	153/185 (83%)	152 (99%)	1 (1%)	0	100	100
2	NX	160/185 (86%)	160 (100%)	0	0	100	100
2	OF	162/185 (88%)	161 (99%)	1 (1%)	0	100	100
2	OG	146/185 (79%)	145 (99%)	1 (1%)	0	100	100
2	OH	148/185 (80%)	147 (99%)	1 (1%)	0	100	100
2	OP	147/185 (80%)	146 (99%)	1 (1%)	0	100	100
2	OQ	164/185 (89%)	163 (99%)	1 (1%)	0	100	100
3	AF	138/190 (73%)	135 (98%)	3 (2%)	0	100	100
3	AN	145/190 (76%)	143 (99%)	2 (1%)	0	100	100
3	AV	148/190 (78%)	145 (98%)	3 (2%)	0	100	100
3	BE	148/190 (78%)	145 (98%)	3 (2%)	0	100	100
3	BP	145/190 (76%)	143 (99%)	2 (1%)	0	100	100
3	BY	145/190 (76%)	141 (97%)	4 (3%)	0	100	100

Continued on next page...

Continued from previous page...

Mol	Chain	Analysed	Favoured	Allowed	Outliers	Percentiles	
3	CO	146/190 (77%)	145 (99%)	1 (1%)	0	100	100
3	DF	138/190 (73%)	135 (98%)	3 (2%)	0	100	100
3	DN	145/190 (76%)	143 (99%)	2 (1%)	0	100	100
3	DV	148/190 (78%)	145 (98%)	3 (2%)	0	100	100
3	EE	148/190 (78%)	145 (98%)	3 (2%)	0	100	100
3	EP	145/190 (76%)	143 (99%)	2 (1%)	0	100	100
3	EY	145/190 (76%)	141 (97%)	4 (3%)	0	100	100
3	FO	146/190 (77%)	145 (99%)	1 (1%)	0	100	100
3	GF	138/190 (73%)	135 (98%)	3 (2%)	0	100	100
3	GN	145/190 (76%)	141 (97%)	4 (3%)	0	100	100
3	GV	148/190 (78%)	145 (98%)	3 (2%)	0	100	100
3	HE	148/190 (78%)	145 (98%)	3 (2%)	0	100	100
3	HP	145/190 (76%)	143 (99%)	2 (1%)	0	100	100
3	HY	145/190 (76%)	141 (97%)	4 (3%)	0	100	100
3	IO	146/190 (77%)	145 (99%)	1 (1%)	0	100	100
3	JF	138/190 (73%)	135 (98%)	3 (2%)	0	100	100
3	JN	145/190 (76%)	142 (98%)	3 (2%)	0	100	100
3	JV	148/190 (78%)	145 (98%)	3 (2%)	0	100	100
3	KE	148/190 (78%)	145 (98%)	3 (2%)	0	100	100
3	KP	145/190 (76%)	143 (99%)	2 (1%)	0	100	100
3	KY	145/190 (76%)	141 (97%)	4 (3%)	0	100	100
3	LO	146/190 (77%)	145 (99%)	1 (1%)	0	100	100
3	MF	138/190 (73%)	135 (98%)	3 (2%)	0	100	100
3	MN	145/190 (76%)	141 (97%)	4 (3%)	0	100	100
3	MV	148/190 (78%)	145 (98%)	3 (2%)	0	100	100
3	NE	148/190 (78%)	145 (98%)	3 (2%)	0	100	100
3	NP	145/190 (76%)	143 (99%)	2 (1%)	0	100	100
3	NY	145/190 (76%)	141 (97%)	4 (3%)	0	100	100
3	OO	146/190 (77%)	145 (99%)	1 (1%)	0	100	100
4	AH	35/230 (15%)	35 (100%)	0	0	100	100
4	AI	27/230 (12%)	27 (100%)	0	0	100	100

Continued on next page...

Continued from previous page...

Mol	Chain	Analysed	Favoured	Allowed	Outliers	Percentiles	
4	AP	35/230 (15%)	35 (100%)	0	0	100	100
4	AQ	35/230 (15%)	35 (100%)	0	0	100	100
4	AR	35/230 (15%)	35 (100%)	0	0	100	100
4	AY	35/230 (15%)	35 (100%)	0	0	100	100
4	AZ	35/230 (15%)	35 (100%)	0	0	100	100
4	BA	35/230 (15%)	35 (100%)	0	0	100	100
4	BH	35/230 (15%)	35 (100%)	0	0	100	100
4	BI	35/230 (15%)	35 (100%)	0	0	100	100
4	BJ	35/230 (15%)	35 (100%)	0	0	100	100
4	BQ	26/230 (11%)	26 (100%)	0	0	100	100
4	BR	35/230 (15%)	35 (100%)	0	0	100	100
4	BS	35/230 (15%)	35 (100%)	0	0	100	100
4	BZ	35/230 (15%)	35 (100%)	0	0	100	100
4	CA	24/230 (10%)	24 (100%)	0	0	100	100
4	CB	27/230 (12%)	27 (100%)	0	0	100	100
4	CI	35/230 (15%)	35 (100%)	0	0	100	100
4	CJ	27/230 (12%)	27 (100%)	0	0	100	100
4	CK	35/230 (15%)	35 (100%)	0	0	100	100
4	CR	35/230 (15%)	34 (97%)	1 (3%)	0	100	100
4	CS	35/230 (15%)	35 (100%)	0	0	100	100
4	CT	27/230 (12%)	27 (100%)	0	0	100	100
4	CX	28/230 (12%)	28 (100%)	0	0	100	100
4	CY	28/230 (12%)	28 (100%)	0	0	100	100
4	CZ	28/230 (12%)	28 (100%)	0	0	100	100
4	DH	35/230 (15%)	35 (100%)	0	0	100	100
4	DI	27/230 (12%)	27 (100%)	0	0	100	100
4	DP	35/230 (15%)	35 (100%)	0	0	100	100
4	DQ	35/230 (15%)	35 (100%)	0	0	100	100
4	DR	35/230 (15%)	35 (100%)	0	0	100	100
4	DY	35/230 (15%)	35 (100%)	0	0	100	100
4	DZ	35/230 (15%)	35 (100%)	0	0	100	100

Continued on next page...

Continued from previous page...

Mol	Chain	Analysed	Favoured	Allowed	Outliers	Percentiles	
4	EA	35/230 (15%)	35 (100%)	0	0	100	100
4	EH	35/230 (15%)	35 (100%)	0	0	100	100
4	EI	35/230 (15%)	35 (100%)	0	0	100	100
4	EJ	35/230 (15%)	35 (100%)	0	0	100	100
4	EQ	26/230 (11%)	26 (100%)	0	0	100	100
4	ER	35/230 (15%)	35 (100%)	0	0	100	100
4	ES	35/230 (15%)	35 (100%)	0	0	100	100
4	EZ	35/230 (15%)	35 (100%)	0	0	100	100
4	FA	35/230 (15%)	35 (100%)	0	0	100	100
4	FB	27/230 (12%)	27 (100%)	0	0	100	100
4	FI	35/230 (15%)	35 (100%)	0	0	100	100
4	FJ	27/230 (12%)	27 (100%)	0	0	100	100
4	FK	35/230 (15%)	35 (100%)	0	0	100	100
4	FR	35/230 (15%)	35 (100%)	0	0	100	100
4	FS	35/230 (15%)	35 (100%)	0	0	100	100
4	FT	27/230 (12%)	27 (100%)	0	0	100	100
4	FX	28/230 (12%)	28 (100%)	0	0	100	100
4	FY	28/230 (12%)	28 (100%)	0	0	100	100
4	FZ	28/230 (12%)	28 (100%)	0	0	100	100
4	GH	35/230 (15%)	35 (100%)	0	0	100	100
4	GI	27/230 (12%)	27 (100%)	0	0	100	100
4	GP	35/230 (15%)	35 (100%)	0	0	100	100
4	GQ	35/230 (15%)	35 (100%)	0	0	100	100
4	GR	35/230 (15%)	35 (100%)	0	0	100	100
4	GY	35/230 (15%)	35 (100%)	0	0	100	100
4	GZ	35/230 (15%)	35 (100%)	0	0	100	100
4	HA	35/230 (15%)	35 (100%)	0	0	100	100
4	HH	35/230 (15%)	35 (100%)	0	0	100	100
4	HI	35/230 (15%)	35 (100%)	0	0	100	100
4	HJ	35/230 (15%)	35 (100%)	0	0	100	100
4	HQ	26/230 (11%)	26 (100%)	0	0	100	100

Continued on next page...

Continued from previous page...

Mol	Chain	Analysed	Favoured	Allowed	Outliers	Percentiles	
4	HR	35/230 (15%)	35 (100%)	0	0	100	100
4	HS	35/230 (15%)	35 (100%)	0	0	100	100
4	HZ	35/230 (15%)	35 (100%)	0	0	100	100
4	IA	35/230 (15%)	35 (100%)	0	0	100	100
4	IB	27/230 (12%)	27 (100%)	0	0	100	100
4	II	35/230 (15%)	35 (100%)	0	0	100	100
4	IJ	27/230 (12%)	27 (100%)	0	0	100	100
4	IK	35/230 (15%)	35 (100%)	0	0	100	100
4	IR	35/230 (15%)	35 (100%)	0	0	100	100
4	IS	35/230 (15%)	35 (100%)	0	0	100	100
4	IT	27/230 (12%)	27 (100%)	0	0	100	100
4	IX	28/230 (12%)	28 (100%)	0	0	100	100
4	IY	28/230 (12%)	28 (100%)	0	0	100	100
4	IZ	28/230 (12%)	28 (100%)	0	0	100	100
4	JH	35/230 (15%)	35 (100%)	0	0	100	100
4	JI	27/230 (12%)	27 (100%)	0	0	100	100
4	JP	35/230 (15%)	35 (100%)	0	0	100	100
4	JQ	35/230 (15%)	35 (100%)	0	0	100	100
4	JR	35/230 (15%)	35 (100%)	0	0	100	100
4	JY	35/230 (15%)	35 (100%)	0	0	100	100
4	JZ	35/230 (15%)	35 (100%)	0	0	100	100
4	KA	35/230 (15%)	35 (100%)	0	0	100	100
4	KH	35/230 (15%)	35 (100%)	0	0	100	100
4	KI	35/230 (15%)	35 (100%)	0	0	100	100
4	KJ	35/230 (15%)	35 (100%)	0	0	100	100
4	KQ	26/230 (11%)	26 (100%)	0	0	100	100
4	KR	35/230 (15%)	35 (100%)	0	0	100	100
4	KS	35/230 (15%)	35 (100%)	0	0	100	100
4	KZ	35/230 (15%)	35 (100%)	0	0	100	100
4	LA	35/230 (15%)	35 (100%)	0	0	100	100
4	LB	27/230 (12%)	27 (100%)	0	0	100	100

Continued on next page...

Continued from previous page...

Mol	Chain	Analysed	Favoured	Allowed	Outliers	Percentiles	
4	LI	35/230 (15%)	35 (100%)	0	0	100	100
4	LJ	27/230 (12%)	27 (100%)	0	0	100	100
4	LK	35/230 (15%)	35 (100%)	0	0	100	100
4	LR	35/230 (15%)	35 (100%)	0	0	100	100
4	LS	35/230 (15%)	35 (100%)	0	0	100	100
4	LT	27/230 (12%)	27 (100%)	0	0	100	100
4	LX	28/230 (12%)	28 (100%)	0	0	100	100
4	LY	28/230 (12%)	28 (100%)	0	0	100	100
4	LZ	28/230 (12%)	28 (100%)	0	0	100	100
4	MH	35/230 (15%)	35 (100%)	0	0	100	100
4	MI	27/230 (12%)	27 (100%)	0	0	100	100
4	MP	35/230 (15%)	35 (100%)	0	0	100	100
4	MQ	35/230 (15%)	35 (100%)	0	0	100	100
4	MR	35/230 (15%)	35 (100%)	0	0	100	100
4	MY	35/230 (15%)	35 (100%)	0	0	100	100
4	MZ	35/230 (15%)	35 (100%)	0	0	100	100
4	NA	35/230 (15%)	35 (100%)	0	0	100	100
4	NH	35/230 (15%)	35 (100%)	0	0	100	100
4	NI	35/230 (15%)	35 (100%)	0	0	100	100
4	NJ	35/230 (15%)	35 (100%)	0	0	100	100
4	NQ	26/230 (11%)	26 (100%)	0	0	100	100
4	NR	35/230 (15%)	35 (100%)	0	0	100	100
4	NS	35/230 (15%)	35 (100%)	0	0	100	100
4	NZ	35/230 (15%)	35 (100%)	0	0	100	100
4	OA	24/230 (10%)	24 (100%)	0	0	100	100
4	OB	27/230 (12%)	27 (100%)	0	0	100	100
4	OI	35/230 (15%)	34 (97%)	1 (3%)	0	100	100
4	OJ	27/230 (12%)	27 (100%)	0	0	100	100
4	OK	35/230 (15%)	35 (100%)	0	0	100	100
4	OR	35/230 (15%)	35 (100%)	0	0	100	100
4	OS	35/230 (15%)	35 (100%)	0	0	100	100

Continued on next page...

Continued from previous page...

Mol	Chain	Analysed	Favoured	Allowed	Outliers	Percentiles	
4	OT	27/230 (12%)	27 (100%)	0	0	100	100
4	OX	28/230 (12%)	28 (100%)	0	0	100	100
4	OY	28/230 (12%)	28 (100%)	0	0	100	100
4	OZ	28/230 (12%)	28 (100%)	0	0	100	100
4	QA	109/230 (47%)	106 (97%)	3 (3%)	0	100	100
4	QB	109/230 (47%)	106 (97%)	3 (3%)	0	100	100
4	QC	87/230 (38%)	85 (98%)	2 (2%)	0	100	100
4	QD	87/230 (38%)	85 (98%)	2 (2%)	0	100	100
4	QE	109/230 (47%)	106 (97%)	3 (3%)	0	100	100
4	QF	87/230 (38%)	85 (98%)	2 (2%)	0	100	100
4	QG	109/230 (47%)	105 (96%)	4 (4%)	0	100	100
4	QH	109/230 (47%)	107 (98%)	2 (2%)	0	100	100
4	QI	109/230 (47%)	106 (97%)	3 (3%)	0	100	100
4	QJ	87/230 (38%)	85 (98%)	2 (2%)	0	100	100
4	RA	109/230 (47%)	106 (97%)	3 (3%)	0	100	100
4	RB	109/230 (47%)	107 (98%)	2 (2%)	0	100	100
4	SA	109/230 (47%)	107 (98%)	2 (2%)	0	100	100
4	SB	95/230 (41%)	90 (95%)	5 (5%)	0	100	100
4	SC	109/230 (47%)	107 (98%)	2 (2%)	0	100	100
4	SD	95/230 (41%)	90 (95%)	5 (5%)	0	100	100
4	SE	109/230 (47%)	107 (98%)	2 (2%)	0	100	100
4	SF	109/230 (47%)	107 (98%)	2 (2%)	0	100	100
4	SG	95/230 (41%)	88 (93%)	7 (7%)	0	100	100
4	SH	109/230 (47%)	106 (97%)	3 (3%)	0	100	100
4	SI	95/230 (41%)	86 (90%)	9 (10%)	0	100	100
4	SJ	109/230 (47%)	106 (97%)	3 (3%)	0	100	100
4	SK	95/230 (41%)	88 (93%)	7 (7%)	0	100	100
4	SL	109/230 (47%)	107 (98%)	2 (2%)	0	100	100
4	SM	109/230 (47%)	107 (98%)	2 (2%)	0	100	100
4	SN	95/230 (41%)	90 (95%)	5 (5%)	0	100	100
4	SO	109/230 (47%)	106 (97%)	3 (3%)	0	100	100

Continued on next page...

Continued from previous page...

Mol	Chain	Analysed	Favoured	Allowed	Outliers	Percentiles	
4	TA	109/230 (47%)	107 (98%)	2 (2%)	0	100	100
4	TB	95/230 (41%)	88 (93%)	7 (7%)	0	100	100
4	TC	109/230 (47%)	107 (98%)	2 (2%)	0	100	100
4	TD	95/230 (41%)	88 (93%)	7 (7%)	0	100	100
4	TE	109/230 (47%)	107 (98%)	2 (2%)	0	100	100
4	TF	95/230 (41%)	88 (93%)	7 (7%)	0	100	100
4	TG	109/230 (47%)	107 (98%)	2 (2%)	0	100	100
4	TH	95/230 (41%)	88 (93%)	7 (7%)	0	100	100
4	TI	109/230 (47%)	107 (98%)	2 (2%)	0	100	100
4	TJ	95/230 (41%)	88 (93%)	7 (7%)	0	100	100
4	TK	109/230 (47%)	107 (98%)	2 (2%)	0	100	100
4	TL	95/230 (41%)	88 (93%)	7 (7%)	0	100	100
4	TM	109/230 (47%)	106 (97%)	3 (3%)	0	100	100
4	TN	95/230 (41%)	89 (94%)	6 (6%)	0	100	100
4	TO	109/230 (47%)	107 (98%)	2 (2%)	0	100	100
4	TP	95/230 (41%)	88 (93%)	7 (7%)	0	100	100
4	TQ	109/230 (47%)	107 (98%)	2 (2%)	0	100	100
4	TR	95/230 (41%)	88 (93%)	7 (7%)	0	100	100
4	TS	109/230 (47%)	107 (98%)	2 (2%)	0	100	100
4	TT	95/230 (41%)	89 (94%)	6 (6%)	0	100	100
4	TU	109/230 (47%)	107 (98%)	2 (2%)	0	100	100
4	TV	95/230 (41%)	88 (93%)	7 (7%)	0	100	100
4	TW	109/230 (47%)	107 (98%)	2 (2%)	0	100	100
4	TX	95/230 (41%)	88 (93%)	7 (7%)	0	100	100
4	TY	109/230 (47%)	107 (98%)	2 (2%)	0	100	100
4	TZ	95/230 (41%)	89 (94%)	6 (6%)	0	100	100
4	UA	109/230 (47%)	107 (98%)	2 (2%)	0	100	100
4	UB	95/230 (41%)	89 (94%)	6 (6%)	0	100	100
4	UC	109/230 (47%)	107 (98%)	2 (2%)	0	100	100
4	UD	95/230 (41%)	88 (93%)	7 (7%)	0	100	100
4	UE	109/230 (47%)	108 (99%)	1 (1%)	0	100	100

Continued on next page...

Continued from previous page...

Mol	Chain	Analysed	Favoured	Allowed	Outliers	Percentiles	
4	UF	91/230 (40%)	84 (92%)	7 (8%)	0	100	100
4	VA	109/230 (47%)	107 (98%)	2 (2%)	0	100	100
4	VB	95/230 (41%)	88 (93%)	7 (7%)	0	100	100
4	VC	109/230 (47%)	107 (98%)	2 (2%)	0	100	100
4	VD	95/230 (41%)	88 (93%)	7 (7%)	0	100	100
4	VE	109/230 (47%)	107 (98%)	2 (2%)	0	100	100
4	VF	95/230 (41%)	88 (93%)	7 (7%)	0	100	100
4	VG	109/230 (47%)	107 (98%)	2 (2%)	0	100	100
4	VH	95/230 (41%)	88 (93%)	7 (7%)	0	100	100
4	VI	109/230 (47%)	107 (98%)	2 (2%)	0	100	100
4	VJ	95/230 (41%)	88 (93%)	7 (7%)	0	100	100
4	VK	109/230 (47%)	107 (98%)	2 (2%)	0	100	100
4	VL	95/230 (41%)	88 (93%)	7 (7%)	0	100	100
4	VM	109/230 (47%)	107 (98%)	2 (2%)	0	100	100
4	VN	95/230 (41%)	88 (93%)	7 (7%)	0	100	100
4	VO	109/230 (47%)	107 (98%)	2 (2%)	0	100	100
4	VP	95/230 (41%)	89 (94%)	6 (6%)	0	100	100
4	VQ	109/230 (47%)	107 (98%)	2 (2%)	0	100	100
4	VR	95/230 (41%)	88 (93%)	7 (7%)	0	100	100
4	VS	109/230 (47%)	107 (98%)	2 (2%)	0	100	100
4	VT	95/230 (41%)	89 (94%)	6 (6%)	0	100	100
4	VU	109/230 (47%)	107 (98%)	2 (2%)	0	100	100
4	VV	95/230 (41%)	88 (93%)	7 (7%)	0	100	100
4	VW	109/230 (47%)	107 (98%)	2 (2%)	0	100	100
4	VX	95/230 (41%)	89 (94%)	6 (6%)	0	100	100
4	VY	109/230 (47%)	107 (98%)	2 (2%)	0	100	100
4	VZ	95/230 (41%)	89 (94%)	6 (6%)	0	100	100
4	WA	109/230 (47%)	107 (98%)	2 (2%)	0	100	100
4	WB	95/230 (41%)	88 (93%)	7 (7%)	0	100	100
4	WC	109/230 (47%)	107 (98%)	2 (2%)	0	100	100
4	WD	95/230 (41%)	88 (93%)	7 (7%)	0	100	100

Continued on next page...

Continued from previous page...

Mol	Chain	Analysed	Favoured	Allowed	Outliers	Percentiles	
4	WE	109/230 (47%)	107 (98%)	2 (2%)	0	100	100
4	WF	95/230 (41%)	88 (93%)	7 (7%)	0	100	100
4	XA	109/230 (47%)	107 (98%)	2 (2%)	0	100	100
4	XB	95/230 (41%)	88 (93%)	7 (7%)	0	100	100
4	XC	109/230 (47%)	107 (98%)	2 (2%)	0	100	100
4	XD	95/230 (41%)	88 (93%)	7 (7%)	0	100	100
4	XE	109/230 (47%)	107 (98%)	2 (2%)	0	100	100
4	XF	95/230 (41%)	88 (93%)	7 (7%)	0	100	100
4	XG	109/230 (47%)	107 (98%)	2 (2%)	0	100	100
4	XH	95/230 (41%)	88 (93%)	7 (7%)	0	100	100
4	XI	109/230 (47%)	107 (98%)	2 (2%)	0	100	100
4	XJ	95/230 (41%)	88 (93%)	7 (7%)	0	100	100
4	XK	109/230 (47%)	107 (98%)	2 (2%)	0	100	100
4	XL	95/230 (41%)	88 (93%)	7 (7%)	0	100	100
4	XM	109/230 (47%)	107 (98%)	2 (2%)	0	100	100
4	XN	95/230 (41%)	88 (93%)	7 (7%)	0	100	100
4	XO	109/230 (47%)	107 (98%)	2 (2%)	0	100	100
4	XP	95/230 (41%)	88 (93%)	7 (7%)	0	100	100
4	XQ	109/230 (47%)	107 (98%)	2 (2%)	0	100	100
4	XR	95/230 (41%)	88 (93%)	7 (7%)	0	100	100
4	XS	109/230 (47%)	107 (98%)	2 (2%)	0	100	100
4	XT	95/230 (41%)	88 (93%)	7 (7%)	0	100	100
4	XU	109/230 (47%)	107 (98%)	2 (2%)	0	100	100
4	XV	95/230 (41%)	88 (93%)	7 (7%)	0	100	100
4	XW	109/230 (47%)	107 (98%)	2 (2%)	0	100	100
4	XX	95/230 (41%)	88 (93%)	7 (7%)	0	100	100
4	XY	109/230 (47%)	107 (98%)	2 (2%)	0	100	100
4	XZ	95/230 (41%)	88 (93%)	7 (7%)	0	100	100
4	YA	109/230 (47%)	107 (98%)	2 (2%)	0	100	100
4	YB	95/230 (41%)	88 (93%)	7 (7%)	0	100	100
4	YC	109/230 (47%)	107 (98%)	2 (2%)	0	100	100

Continued on next page...

Continued from previous page...

Mol	Chain	Analysed	Favoured	Allowed	Outliers	Percentiles	
4	YD	95/230 (41%)	88 (93%)	7 (7%)	0	100	100
4	YE	109/230 (47%)	101 (93%)	8 (7%)	0	100	100
4	YF	95/230 (41%)	88 (93%)	7 (7%)	0	100	100
5	AM	153/254 (60%)	152 (99%)	1 (1%)	0	100	100
5	DM	153/254 (60%)	152 (99%)	1 (1%)	0	100	100
5	GM	153/254 (60%)	152 (99%)	1 (1%)	0	100	100
5	JM	153/254 (60%)	152 (99%)	1 (1%)	0	100	100
5	MM	153/254 (60%)	152 (99%)	1 (1%)	0	100	100
6	PA	327/407 (80%)	325 (99%)	2 (1%)	0	100	100
6	PB	356/407 (88%)	352 (99%)	4 (1%)	0	100	100
6	PC	339/407 (83%)	337 (99%)	2 (1%)	0	100	100
6	PD	329/407 (81%)	326 (99%)	3 (1%)	0	100	100
6	PE	346/407 (85%)	341 (99%)	5 (1%)	0	100	100
6	PF	328/407 (81%)	325 (99%)	3 (1%)	0	100	100
6	PG	332/407 (82%)	327 (98%)	5 (2%)	0	100	100
6	PH	337/407 (83%)	332 (98%)	5 (2%)	0	100	100
6	PI	328/407 (81%)	322 (98%)	6 (2%)	0	100	100
6	PJ	346/407 (85%)	343 (99%)	3 (1%)	0	100	100
6	PK	347/407 (85%)	344 (99%)	3 (1%)	0	100	100
6	PL	361/407 (89%)	355 (98%)	6 (2%)	0	100	100
All	All	77883/126339 (62%)	76609 (98%)	1274 (2%)	0	100	100

There are no Ramachandran outliers to report.

5.3.2 Protein sidechains [i](#)

In the following table, the Percentiles column shows the percent sidechain outliers of the chain as a percentile score with respect to all PDB entries followed by that with respect to all EM entries.

The Analysed column shows the number of residues for which the sidechain conformation was analysed, and the total number of residues.

Mol	Chain	Analysed	Rotameric	Outliers	Percentiles	
1	AB	283/286 (99%)	283 (100%)	0	100	100

Continued on next page...

Continued from previous page...

Mol	Chain	Analysed	Rotameric	Outliers	Percentiles	
1	AC	271/286 (95%)	271 (100%)	0	100	100
1	AJ	281/286 (98%)	281 (100%)	0	100	100
1	AK	283/286 (99%)	283 (100%)	0	100	100
1	AL	283/286 (99%)	283 (100%)	0	100	100
1	AS	281/286 (98%)	281 (100%)	0	100	100
1	AT	283/286 (99%)	283 (100%)	0	100	100
1	AU	283/286 (99%)	283 (100%)	0	100	100
1	BB	281/286 (98%)	281 (100%)	0	100	100
1	BC	283/286 (99%)	283 (100%)	0	100	100
1	BD	283/286 (99%)	283 (100%)	0	100	100
1	BK	283/286 (99%)	283 (100%)	0	100	100
1	BL	283/286 (99%)	283 (100%)	0	100	100
1	BM	283/286 (99%)	283 (100%)	0	100	100
1	BT	281/286 (98%)	281 (100%)	0	100	100
1	BU	283/286 (99%)	283 (100%)	0	100	100
1	BV	283/286 (99%)	283 (100%)	0	100	100
1	CC	283/286 (99%)	283 (100%)	0	100	100
1	CD	271/286 (95%)	271 (100%)	0	100	100
1	CE	283/286 (99%)	283 (100%)	0	100	100
1	CL	283/286 (99%)	283 (100%)	0	100	100
1	CM	283/286 (99%)	283 (100%)	0	100	100
1	CN	271/286 (95%)	271 (100%)	0	100	100
1	CU	283/286 (99%)	283 (100%)	0	100	100
1	CV	283/286 (99%)	283 (100%)	0	100	100
1	CW	283/286 (99%)	283 (100%)	0	100	100
1	DB	283/286 (99%)	283 (100%)	0	100	100
1	DC	271/286 (95%)	271 (100%)	0	100	100
1	DJ	281/286 (98%)	281 (100%)	0	100	100
1	DK	283/286 (99%)	283 (100%)	0	100	100
1	DL	283/286 (99%)	283 (100%)	0	100	100
1	DS	281/286 (98%)	281 (100%)	0	100	100

Continued on next page...

Continued from previous page...

Mol	Chain	Analysed	Rotameric	Outliers	Percentiles	
1	DT	283/286 (99%)	283 (100%)	0	100	100
1	DU	283/286 (99%)	283 (100%)	0	100	100
1	EB	281/286 (98%)	281 (100%)	0	100	100
1	EC	283/286 (99%)	283 (100%)	0	100	100
1	ED	283/286 (99%)	283 (100%)	0	100	100
1	EK	283/286 (99%)	283 (100%)	0	100	100
1	EL	283/286 (99%)	283 (100%)	0	100	100
1	EM	283/286 (99%)	283 (100%)	0	100	100
1	ET	281/286 (98%)	281 (100%)	0	100	100
1	EU	283/286 (99%)	283 (100%)	0	100	100
1	EV	283/286 (99%)	283 (100%)	0	100	100
1	FC	283/286 (99%)	283 (100%)	0	100	100
1	FD	271/286 (95%)	271 (100%)	0	100	100
1	FE	283/286 (99%)	283 (100%)	0	100	100
1	FL	283/286 (99%)	283 (100%)	0	100	100
1	FM	283/286 (99%)	283 (100%)	0	100	100
1	FN	271/286 (95%)	271 (100%)	0	100	100
1	FU	283/286 (99%)	283 (100%)	0	100	100
1	FV	283/286 (99%)	283 (100%)	0	100	100
1	FW	283/286 (99%)	283 (100%)	0	100	100
1	GB	283/286 (99%)	283 (100%)	0	100	100
1	GC	271/286 (95%)	271 (100%)	0	100	100
1	GJ	281/286 (98%)	281 (100%)	0	100	100
1	GK	283/286 (99%)	283 (100%)	0	100	100
1	GL	283/286 (99%)	283 (100%)	0	100	100
1	GS	281/286 (98%)	281 (100%)	0	100	100
1	GT	283/286 (99%)	283 (100%)	0	100	100
1	GU	283/286 (99%)	283 (100%)	0	100	100
1	HB	281/286 (98%)	281 (100%)	0	100	100
1	HC	283/286 (99%)	283 (100%)	0	100	100
1	HD	283/286 (99%)	283 (100%)	0	100	100

Continued on next page...

Continued from previous page...

Mol	Chain	Analysed	Rotameric	Outliers	Percentiles	
1	HK	283/286 (99%)	283 (100%)	0	100	100
1	HL	283/286 (99%)	283 (100%)	0	100	100
1	HM	283/286 (99%)	283 (100%)	0	100	100
1	HT	281/286 (98%)	281 (100%)	0	100	100
1	HU	283/286 (99%)	283 (100%)	0	100	100
1	HV	283/286 (99%)	283 (100%)	0	100	100
1	IC	283/286 (99%)	283 (100%)	0	100	100
1	ID	271/286 (95%)	271 (100%)	0	100	100
1	IE	283/286 (99%)	283 (100%)	0	100	100
1	IL	283/286 (99%)	283 (100%)	0	100	100
1	IM	283/286 (99%)	283 (100%)	0	100	100
1	IN	271/286 (95%)	271 (100%)	0	100	100
1	IU	283/286 (99%)	283 (100%)	0	100	100
1	IV	283/286 (99%)	283 (100%)	0	100	100
1	IW	283/286 (99%)	283 (100%)	0	100	100
1	JB	283/286 (99%)	283 (100%)	0	100	100
1	JC	271/286 (95%)	271 (100%)	0	100	100
1	JJ	281/286 (98%)	281 (100%)	0	100	100
1	JK	283/286 (99%)	283 (100%)	0	100	100
1	JL	283/286 (99%)	283 (100%)	0	100	100
1	JS	281/286 (98%)	281 (100%)	0	100	100
1	JT	283/286 (99%)	283 (100%)	0	100	100
1	JU	283/286 (99%)	283 (100%)	0	100	100
1	KB	281/286 (98%)	281 (100%)	0	100	100
1	KC	283/286 (99%)	283 (100%)	0	100	100
1	KD	283/286 (99%)	283 (100%)	0	100	100
1	KK	283/286 (99%)	283 (100%)	0	100	100
1	KL	283/286 (99%)	283 (100%)	0	100	100
1	KM	283/286 (99%)	283 (100%)	0	100	100
1	KT	281/286 (98%)	281 (100%)	0	100	100
1	KU	283/286 (99%)	283 (100%)	0	100	100

Continued on next page...

Continued from previous page...

Mol	Chain	Analysed	Rotameric	Outliers	Percentiles	
1	KV	283/286 (99%)	283 (100%)	0	100	100
1	LC	283/286 (99%)	283 (100%)	0	100	100
1	LD	271/286 (95%)	271 (100%)	0	100	100
1	LE	283/286 (99%)	283 (100%)	0	100	100
1	LL	283/286 (99%)	283 (100%)	0	100	100
1	LM	283/286 (99%)	283 (100%)	0	100	100
1	LN	271/286 (95%)	271 (100%)	0	100	100
1	LU	283/286 (99%)	283 (100%)	0	100	100
1	LV	283/286 (99%)	283 (100%)	0	100	100
1	LW	283/286 (99%)	283 (100%)	0	100	100
1	MB	283/286 (99%)	283 (100%)	0	100	100
1	MC	271/286 (95%)	271 (100%)	0	100	100
1	MJ	281/286 (98%)	281 (100%)	0	100	100
1	MK	283/286 (99%)	283 (100%)	0	100	100
1	ML	283/286 (99%)	283 (100%)	0	100	100
1	MS	281/286 (98%)	281 (100%)	0	100	100
1	MT	283/286 (99%)	283 (100%)	0	100	100
1	MU	283/286 (99%)	283 (100%)	0	100	100
1	NB	281/286 (98%)	281 (100%)	0	100	100
1	NC	283/286 (99%)	283 (100%)	0	100	100
1	ND	283/286 (99%)	283 (100%)	0	100	100
1	NK	283/286 (99%)	283 (100%)	0	100	100
1	NL	283/286 (99%)	283 (100%)	0	100	100
1	NM	283/286 (99%)	283 (100%)	0	100	100
1	NT	281/286 (98%)	281 (100%)	0	100	100
1	NU	283/286 (99%)	283 (100%)	0	100	100
1	NV	283/286 (99%)	283 (100%)	0	100	100
1	OC	283/286 (99%)	283 (100%)	0	100	100
1	OD	271/286 (95%)	271 (100%)	0	100	100
1	OE	283/286 (99%)	283 (100%)	0	100	100
1	OL	283/286 (99%)	283 (100%)	0	100	100

Continued on next page...

Continued from previous page...

Mol	Chain	Analysed	Rotameric	Outliers	Percentiles	
1	OM	283/286 (99%)	283 (100%)	0	100	100
1	ON	271/286 (95%)	271 (100%)	0	100	100
1	OU	283/286 (99%)	283 (100%)	0	100	100
1	OV	283/286 (99%)	283 (100%)	0	100	100
1	OW	283/286 (99%)	283 (100%)	0	100	100
2	AD	99/154 (64%)	99 (100%)	0	100	100
2	AO	132/154 (86%)	132 (100%)	0	100	100
2	AW	129/154 (84%)	129 (100%)	0	100	100
2	AX	133/154 (86%)	133 (100%)	0	100	100
2	BF	131/154 (85%)	131 (100%)	0	100	100
2	BG	130/154 (84%)	130 (100%)	0	100	100
2	BN	147/154 (96%)	147 (100%)	0	100	100
2	BO	129/154 (84%)	129 (100%)	0	100	100
2	BW	131/154 (85%)	131 (100%)	0	100	100
2	BX	141/154 (92%)	141 (100%)	0	100	100
2	CF	142/154 (92%)	142 (100%)	0	100	100
2	CG	129/154 (84%)	129 (100%)	0	100	100
2	CH	130/154 (84%)	130 (100%)	0	100	100
2	CP	129/154 (84%)	129 (100%)	0	100	100
2	CQ	144/154 (94%)	144 (100%)	0	100	100
2	DD	99/154 (64%)	99 (100%)	0	100	100
2	DO	132/154 (86%)	132 (100%)	0	100	100
2	DW	129/154 (84%)	129 (100%)	0	100	100
2	DX	133/154 (86%)	133 (100%)	0	100	100
2	EF	131/154 (85%)	131 (100%)	0	100	100
2	EG	130/154 (84%)	130 (100%)	0	100	100
2	EN	147/154 (96%)	147 (100%)	0	100	100
2	EO	129/154 (84%)	129 (100%)	0	100	100
2	EW	131/154 (85%)	131 (100%)	0	100	100
2	EX	141/154 (92%)	141 (100%)	0	100	100
2	FF	142/154 (92%)	142 (100%)	0	100	100

Continued on next page...

Continued from previous page...

Mol	Chain	Analysed	Rotameric	Outliers	Percentiles	
2	FG	129/154 (84%)	129 (100%)	0	100	100
2	FH	130/154 (84%)	130 (100%)	0	100	100
2	FP	129/154 (84%)	129 (100%)	0	100	100
2	FQ	144/154 (94%)	144 (100%)	0	100	100
2	GD	99/154 (64%)	99 (100%)	0	100	100
2	GO	132/154 (86%)	132 (100%)	0	100	100
2	GW	129/154 (84%)	129 (100%)	0	100	100
2	GX	133/154 (86%)	133 (100%)	0	100	100
2	HF	131/154 (85%)	131 (100%)	0	100	100
2	HG	130/154 (84%)	130 (100%)	0	100	100
2	HN	147/154 (96%)	147 (100%)	0	100	100
2	HO	129/154 (84%)	129 (100%)	0	100	100
2	HW	131/154 (85%)	131 (100%)	0	100	100
2	HX	141/154 (92%)	141 (100%)	0	100	100
2	IF	142/154 (92%)	142 (100%)	0	100	100
2	IG	129/154 (84%)	129 (100%)	0	100	100
2	IH	130/154 (84%)	130 (100%)	0	100	100
2	IP	129/154 (84%)	129 (100%)	0	100	100
2	IQ	144/154 (94%)	144 (100%)	0	100	100
2	JD	99/154 (64%)	99 (100%)	0	100	100
2	JO	132/154 (86%)	132 (100%)	0	100	100
2	JW	129/154 (84%)	129 (100%)	0	100	100
2	JX	133/154 (86%)	133 (100%)	0	100	100
2	KF	131/154 (85%)	131 (100%)	0	100	100
2	KG	130/154 (84%)	130 (100%)	0	100	100
2	KN	147/154 (96%)	147 (100%)	0	100	100
2	KO	129/154 (84%)	129 (100%)	0	100	100
2	KW	131/154 (85%)	131 (100%)	0	100	100
2	KX	141/154 (92%)	141 (100%)	0	100	100
2	LF	142/154 (92%)	142 (100%)	0	100	100
2	LG	129/154 (84%)	129 (100%)	0	100	100

Continued on next page...

Continued from previous page...

Mol	Chain	Analysed	Rotameric	Outliers	Percentiles	
2	LH	130/154 (84%)	130 (100%)	0	100	100
2	LP	129/154 (84%)	129 (100%)	0	100	100
2	LQ	144/154 (94%)	144 (100%)	0	100	100
2	MD	99/154 (64%)	99 (100%)	0	100	100
2	MO	132/154 (86%)	132 (100%)	0	100	100
2	MW	129/154 (84%)	129 (100%)	0	100	100
2	MX	133/154 (86%)	133 (100%)	0	100	100
2	NF	131/154 (85%)	131 (100%)	0	100	100
2	NG	130/154 (84%)	130 (100%)	0	100	100
2	NN	147/154 (96%)	147 (100%)	0	100	100
2	NO	129/154 (84%)	129 (100%)	0	100	100
2	NW	131/154 (85%)	131 (100%)	0	100	100
2	NX	141/154 (92%)	141 (100%)	0	100	100
2	OF	142/154 (92%)	142 (100%)	0	100	100
2	OG	129/154 (84%)	129 (100%)	0	100	100
2	OH	130/154 (84%)	130 (100%)	0	100	100
2	OP	129/154 (84%)	129 (100%)	0	100	100
2	OQ	144/154 (94%)	144 (100%)	0	100	100
3	AF	124/163 (76%)	124 (100%)	0	100	100
3	AN	130/163 (80%)	130 (100%)	0	100	100
3	AV	131/163 (80%)	131 (100%)	0	100	100
3	BE	131/163 (80%)	131 (100%)	0	100	100
3	BP	129/163 (79%)	129 (100%)	0	100	100
3	BY	129/163 (79%)	129 (100%)	0	100	100
3	CO	130/163 (80%)	130 (100%)	0	100	100
3	DF	124/163 (76%)	124 (100%)	0	100	100
3	DN	130/163 (80%)	130 (100%)	0	100	100
3	DV	131/163 (80%)	131 (100%)	0	100	100
3	EE	131/163 (80%)	131 (100%)	0	100	100
3	EP	129/163 (79%)	129 (100%)	0	100	100
3	EY	129/163 (79%)	129 (100%)	0	100	100

Continued on next page...

Continued from previous page...

Mol	Chain	Analysed	Rotameric	Outliers	Percentiles	
3	FO	130/163 (80%)	130 (100%)	0	100	100
3	GF	124/163 (76%)	124 (100%)	0	100	100
3	GN	130/163 (80%)	130 (100%)	0	100	100
3	GV	131/163 (80%)	131 (100%)	0	100	100
3	HE	131/163 (80%)	131 (100%)	0	100	100
3	HP	129/163 (79%)	129 (100%)	0	100	100
3	HY	129/163 (79%)	129 (100%)	0	100	100
3	IO	130/163 (80%)	130 (100%)	0	100	100
3	JF	124/163 (76%)	124 (100%)	0	100	100
3	JN	130/163 (80%)	130 (100%)	0	100	100
3	JV	131/163 (80%)	131 (100%)	0	100	100
3	KE	131/163 (80%)	131 (100%)	0	100	100
3	KP	129/163 (79%)	129 (100%)	0	100	100
3	KY	129/163 (79%)	129 (100%)	0	100	100
3	LO	130/163 (80%)	130 (100%)	0	100	100
3	MF	124/163 (76%)	124 (100%)	0	100	100
3	MN	130/163 (80%)	130 (100%)	0	100	100
3	MV	131/163 (80%)	131 (100%)	0	100	100
3	NE	131/163 (80%)	131 (100%)	0	100	100
3	NP	129/163 (79%)	129 (100%)	0	100	100
3	NY	129/163 (79%)	129 (100%)	0	100	100
3	OO	130/163 (80%)	130 (100%)	0	100	100
4	AH	35/210 (17%)	35 (100%)	0	100	100
4	AI	28/210 (13%)	28 (100%)	0	100	100
4	AP	35/210 (17%)	35 (100%)	0	100	100
4	AQ	35/210 (17%)	35 (100%)	0	100	100
4	AR	35/210 (17%)	35 (100%)	0	100	100
4	AY	35/210 (17%)	35 (100%)	0	100	100
4	AZ	35/210 (17%)	35 (100%)	0	100	100
4	BA	35/210 (17%)	35 (100%)	0	100	100
4	BH	35/210 (17%)	35 (100%)	0	100	100

Continued on next page...

Continued from previous page...

Mol	Chain	Analysed	Rotameric	Outliers	Percentiles	
4	BI	35/210 (17%)	35 (100%)	0	100	100
4	BJ	35/210 (17%)	35 (100%)	0	100	100
4	BQ	27/210 (13%)	27 (100%)	0	100	100
4	BR	35/210 (17%)	35 (100%)	0	100	100
4	BS	35/210 (17%)	35 (100%)	0	100	100
4	BZ	35/210 (17%)	35 (100%)	0	100	100
4	CA	25/210 (12%)	25 (100%)	0	100	100
4	CB	28/210 (13%)	28 (100%)	0	100	100
4	CI	35/210 (17%)	35 (100%)	0	100	100
4	CJ	28/210 (13%)	28 (100%)	0	100	100
4	CK	35/210 (17%)	35 (100%)	0	100	100
4	CR	35/210 (17%)	35 (100%)	0	100	100
4	CS	35/210 (17%)	35 (100%)	0	100	100
4	CT	28/210 (13%)	28 (100%)	0	100	100
4	CX	29/210 (14%)	29 (100%)	0	100	100
4	CY	29/210 (14%)	29 (100%)	0	100	100
4	CZ	29/210 (14%)	29 (100%)	0	100	100
4	DH	35/210 (17%)	35 (100%)	0	100	100
4	DI	28/210 (13%)	28 (100%)	0	100	100
4	DP	35/210 (17%)	35 (100%)	0	100	100
4	DQ	35/210 (17%)	35 (100%)	0	100	100
4	DR	35/210 (17%)	35 (100%)	0	100	100
4	DY	35/210 (17%)	35 (100%)	0	100	100
4	DZ	35/210 (17%)	35 (100%)	0	100	100
4	EA	35/210 (17%)	35 (100%)	0	100	100
4	EH	35/210 (17%)	35 (100%)	0	100	100
4	EI	35/210 (17%)	35 (100%)	0	100	100
4	EJ	35/210 (17%)	35 (100%)	0	100	100
4	EQ	27/210 (13%)	27 (100%)	0	100	100
4	ER	35/210 (17%)	35 (100%)	0	100	100
4	ES	35/210 (17%)	35 (100%)	0	100	100

Continued on next page...

Continued from previous page...

Mol	Chain	Analysed	Rotameric	Outliers	Percentiles	
4	EZ	35/210 (17%)	35 (100%)	0	100	100
4	FA	35/210 (17%)	35 (100%)	0	100	100
4	FB	28/210 (13%)	28 (100%)	0	100	100
4	FI	35/210 (17%)	35 (100%)	0	100	100
4	FJ	28/210 (13%)	28 (100%)	0	100	100
4	FK	35/210 (17%)	35 (100%)	0	100	100
4	FR	35/210 (17%)	35 (100%)	0	100	100
4	FS	35/210 (17%)	35 (100%)	0	100	100
4	FT	28/210 (13%)	28 (100%)	0	100	100
4	FX	29/210 (14%)	29 (100%)	0	100	100
4	FY	29/210 (14%)	29 (100%)	0	100	100
4	FZ	29/210 (14%)	29 (100%)	0	100	100
4	GH	35/210 (17%)	35 (100%)	0	100	100
4	GI	28/210 (13%)	28 (100%)	0	100	100
4	GP	35/210 (17%)	35 (100%)	0	100	100
4	GQ	35/210 (17%)	35 (100%)	0	100	100
4	GR	35/210 (17%)	35 (100%)	0	100	100
4	GY	35/210 (17%)	35 (100%)	0	100	100
4	GZ	35/210 (17%)	35 (100%)	0	100	100
4	HA	35/210 (17%)	35 (100%)	0	100	100
4	HH	35/210 (17%)	35 (100%)	0	100	100
4	HI	35/210 (17%)	35 (100%)	0	100	100
4	HJ	35/210 (17%)	35 (100%)	0	100	100
4	HQ	27/210 (13%)	27 (100%)	0	100	100
4	HR	35/210 (17%)	35 (100%)	0	100	100
4	HS	35/210 (17%)	35 (100%)	0	100	100
4	HZ	35/210 (17%)	35 (100%)	0	100	100
4	IA	35/210 (17%)	35 (100%)	0	100	100
4	IB	28/210 (13%)	28 (100%)	0	100	100
4	II	35/210 (17%)	35 (100%)	0	100	100
4	IJ	28/210 (13%)	28 (100%)	0	100	100

Continued on next page...

Continued from previous page...

Mol	Chain	Analysed	Rotameric	Outliers	Percentiles	
4	IK	35/210 (17%)	35 (100%)	0	100	100
4	IR	35/210 (17%)	35 (100%)	0	100	100
4	IS	35/210 (17%)	35 (100%)	0	100	100
4	IT	28/210 (13%)	28 (100%)	0	100	100
4	IX	29/210 (14%)	29 (100%)	0	100	100
4	IY	29/210 (14%)	29 (100%)	0	100	100
4	IZ	29/210 (14%)	29 (100%)	0	100	100
4	JH	35/210 (17%)	35 (100%)	0	100	100
4	JI	28/210 (13%)	28 (100%)	0	100	100
4	JP	35/210 (17%)	35 (100%)	0	100	100
4	JQ	35/210 (17%)	35 (100%)	0	100	100
4	JR	35/210 (17%)	35 (100%)	0	100	100
4	JY	35/210 (17%)	35 (100%)	0	100	100
4	JZ	35/210 (17%)	35 (100%)	0	100	100
4	KA	35/210 (17%)	35 (100%)	0	100	100
4	KH	35/210 (17%)	35 (100%)	0	100	100
4	KI	35/210 (17%)	35 (100%)	0	100	100
4	KJ	35/210 (17%)	35 (100%)	0	100	100
4	KQ	27/210 (13%)	27 (100%)	0	100	100
4	KR	35/210 (17%)	35 (100%)	0	100	100
4	KS	35/210 (17%)	35 (100%)	0	100	100
4	KZ	35/210 (17%)	35 (100%)	0	100	100
4	LA	35/210 (17%)	35 (100%)	0	100	100
4	LB	28/210 (13%)	28 (100%)	0	100	100
4	LI	35/210 (17%)	35 (100%)	0	100	100
4	LJ	28/210 (13%)	28 (100%)	0	100	100
4	LK	35/210 (17%)	35 (100%)	0	100	100
4	LR	35/210 (17%)	35 (100%)	0	100	100
4	LS	35/210 (17%)	35 (100%)	0	100	100
4	LT	28/210 (13%)	28 (100%)	0	100	100
4	LX	29/210 (14%)	29 (100%)	0	100	100

Continued on next page...

Continued from previous page...

Mol	Chain	Analysed	Rotameric	Outliers	Percentiles	
4	LY	29/210 (14%)	29 (100%)	0	100	100
4	LZ	29/210 (14%)	29 (100%)	0	100	100
4	MH	35/210 (17%)	35 (100%)	0	100	100
4	MI	28/210 (13%)	28 (100%)	0	100	100
4	MP	35/210 (17%)	35 (100%)	0	100	100
4	MQ	35/210 (17%)	35 (100%)	0	100	100
4	MR	35/210 (17%)	35 (100%)	0	100	100
4	MY	35/210 (17%)	35 (100%)	0	100	100
4	MZ	35/210 (17%)	35 (100%)	0	100	100
4	NA	35/210 (17%)	35 (100%)	0	100	100
4	NH	35/210 (17%)	35 (100%)	0	100	100
4	NI	35/210 (17%)	35 (100%)	0	100	100
4	NJ	35/210 (17%)	35 (100%)	0	100	100
4	NQ	27/210 (13%)	27 (100%)	0	100	100
4	NR	35/210 (17%)	35 (100%)	0	100	100
4	NS	35/210 (17%)	35 (100%)	0	100	100
4	NZ	35/210 (17%)	35 (100%)	0	100	100
4	OA	25/210 (12%)	25 (100%)	0	100	100
4	OB	28/210 (13%)	28 (100%)	0	100	100
4	OI	35/210 (17%)	35 (100%)	0	100	100
4	OJ	28/210 (13%)	28 (100%)	0	100	100
4	OK	35/210 (17%)	35 (100%)	0	100	100
4	OR	35/210 (17%)	35 (100%)	0	100	100
4	OS	35/210 (17%)	35 (100%)	0	100	100
4	OT	28/210 (13%)	28 (100%)	0	100	100
4	OX	29/210 (14%)	29 (100%)	0	100	100
4	OY	29/210 (14%)	29 (100%)	0	100	100
4	OZ	29/210 (14%)	29 (100%)	0	100	100
4	QA	100/210 (48%)	100 (100%)	0	100	100
4	QB	100/210 (48%)	100 (100%)	0	100	100
4	QC	79/210 (38%)	79 (100%)	0	100	100

Continued on next page...

Continued from previous page...

Mol	Chain	Analysed	Rotameric	Outliers	Percentiles	
4	QD	79/210 (38%)	79 (100%)	0	100	100
4	QE	100/210 (48%)	100 (100%)	0	100	100
4	QF	79/210 (38%)	79 (100%)	0	100	100
4	QG	100/210 (48%)	100 (100%)	0	100	100
4	QH	100/210 (48%)	100 (100%)	0	100	100
4	QI	100/210 (48%)	100 (100%)	0	100	100
4	QJ	79/210 (38%)	79 (100%)	0	100	100
4	RA	100/210 (48%)	100 (100%)	0	100	100
4	RB	100/210 (48%)	100 (100%)	0	100	100
4	SA	100/210 (48%)	100 (100%)	0	100	100
4	SB	87/210 (41%)	87 (100%)	0	100	100
4	SC	100/210 (48%)	100 (100%)	0	100	100
4	SD	87/210 (41%)	87 (100%)	0	100	100
4	SE	100/210 (48%)	100 (100%)	0	100	100
4	SF	100/210 (48%)	100 (100%)	0	100	100
4	SG	87/210 (41%)	87 (100%)	0	100	100
4	SH	100/210 (48%)	100 (100%)	0	100	100
4	SI	87/210 (41%)	87 (100%)	0	100	100
4	SJ	100/210 (48%)	100 (100%)	0	100	100
4	SK	87/210 (41%)	87 (100%)	0	100	100
4	SL	100/210 (48%)	100 (100%)	0	100	100
4	SM	100/210 (48%)	100 (100%)	0	100	100
4	SN	87/210 (41%)	87 (100%)	0	100	100
4	SO	100/210 (48%)	100 (100%)	0	100	100
4	TA	100/210 (48%)	100 (100%)	0	100	100
4	TB	87/210 (41%)	87 (100%)	0	100	100
4	TC	100/210 (48%)	100 (100%)	0	100	100
4	TD	87/210 (41%)	87 (100%)	0	100	100
4	TE	100/210 (48%)	100 (100%)	0	100	100
4	TF	87/210 (41%)	87 (100%)	0	100	100
4	TG	100/210 (48%)	100 (100%)	0	100	100

Continued on next page...

Continued from previous page...

Mol	Chain	Analysed	Rotameric	Outliers	Percentiles	
4	TH	87/210 (41%)	87 (100%)	0	100	100
4	TI	100/210 (48%)	100 (100%)	0	100	100
4	TJ	87/210 (41%)	87 (100%)	0	100	100
4	TK	100/210 (48%)	100 (100%)	0	100	100
4	TL	87/210 (41%)	87 (100%)	0	100	100
4	TM	100/210 (48%)	100 (100%)	0	100	100
4	TN	87/210 (41%)	87 (100%)	0	100	100
4	TO	100/210 (48%)	100 (100%)	0	100	100
4	TP	87/210 (41%)	87 (100%)	0	100	100
4	TQ	100/210 (48%)	100 (100%)	0	100	100
4	TR	87/210 (41%)	87 (100%)	0	100	100
4	TS	100/210 (48%)	100 (100%)	0	100	100
4	TT	87/210 (41%)	87 (100%)	0	100	100
4	TU	100/210 (48%)	100 (100%)	0	100	100
4	TV	87/210 (41%)	87 (100%)	0	100	100
4	TW	100/210 (48%)	100 (100%)	0	100	100
4	TX	87/210 (41%)	87 (100%)	0	100	100
4	TY	100/210 (48%)	100 (100%)	0	100	100
4	TZ	87/210 (41%)	87 (100%)	0	100	100
4	UA	100/210 (48%)	100 (100%)	0	100	100
4	UB	87/210 (41%)	87 (100%)	0	100	100
4	UC	100/210 (48%)	100 (100%)	0	100	100
4	UD	87/210 (41%)	87 (100%)	0	100	100
4	UE	100/210 (48%)	100 (100%)	0	100	100
4	UF	83/210 (40%)	83 (100%)	0	100	100
4	VA	100/210 (48%)	100 (100%)	0	100	100
4	VB	87/210 (41%)	87 (100%)	0	100	100
4	VC	100/210 (48%)	100 (100%)	0	100	100
4	VD	87/210 (41%)	87 (100%)	0	100	100
4	VE	100/210 (48%)	100 (100%)	0	100	100
4	VF	87/210 (41%)	87 (100%)	0	100	100

Continued on next page...

Continued from previous page...

Mol	Chain	Analysed	Rotameric	Outliers	Percentiles	
4	VG	100/210 (48%)	100 (100%)	0	100	100
4	VH	87/210 (41%)	87 (100%)	0	100	100
4	VI	100/210 (48%)	100 (100%)	0	100	100
4	VJ	87/210 (41%)	87 (100%)	0	100	100
4	VK	100/210 (48%)	100 (100%)	0	100	100
4	VL	87/210 (41%)	87 (100%)	0	100	100
4	VM	100/210 (48%)	100 (100%)	0	100	100
4	VN	87/210 (41%)	87 (100%)	0	100	100
4	VO	100/210 (48%)	100 (100%)	0	100	100
4	VP	87/210 (41%)	87 (100%)	0	100	100
4	VQ	100/210 (48%)	100 (100%)	0	100	100
4	VR	87/210 (41%)	87 (100%)	0	100	100
4	VS	100/210 (48%)	100 (100%)	0	100	100
4	VT	87/210 (41%)	87 (100%)	0	100	100
4	VU	100/210 (48%)	100 (100%)	0	100	100
4	VV	87/210 (41%)	87 (100%)	0	100	100
4	VW	100/210 (48%)	100 (100%)	0	100	100
4	VX	87/210 (41%)	87 (100%)	0	100	100
4	VY	100/210 (48%)	100 (100%)	0	100	100
4	VZ	87/210 (41%)	87 (100%)	0	100	100
4	WA	100/210 (48%)	100 (100%)	0	100	100
4	WB	87/210 (41%)	87 (100%)	0	100	100
4	WC	100/210 (48%)	100 (100%)	0	100	100
4	WD	87/210 (41%)	87 (100%)	0	100	100
4	WE	100/210 (48%)	100 (100%)	0	100	100
4	WF	87/210 (41%)	87 (100%)	0	100	100
4	XA	100/210 (48%)	100 (100%)	0	100	100
4	XB	87/210 (41%)	87 (100%)	0	100	100
4	XC	100/210 (48%)	100 (100%)	0	100	100
4	XD	87/210 (41%)	87 (100%)	0	100	100
4	XE	100/210 (48%)	100 (100%)	0	100	100

Continued on next page...

Continued from previous page...

Mol	Chain	Analysed	Rotameric	Outliers	Percentiles	
4	XF	87/210 (41%)	87 (100%)	0	100	100
4	XG	100/210 (48%)	100 (100%)	0	100	100
4	XH	87/210 (41%)	87 (100%)	0	100	100
4	XI	100/210 (48%)	100 (100%)	0	100	100
4	XJ	87/210 (41%)	87 (100%)	0	100	100
4	XK	100/210 (48%)	100 (100%)	0	100	100
4	XL	87/210 (41%)	87 (100%)	0	100	100
4	XM	100/210 (48%)	100 (100%)	0	100	100
4	XN	87/210 (41%)	87 (100%)	0	100	100
4	XO	100/210 (48%)	100 (100%)	0	100	100
4	XP	87/210 (41%)	87 (100%)	0	100	100
4	XQ	100/210 (48%)	100 (100%)	0	100	100
4	XR	87/210 (41%)	87 (100%)	0	100	100
4	XS	100/210 (48%)	100 (100%)	0	100	100
4	XT	87/210 (41%)	87 (100%)	0	100	100
4	XU	100/210 (48%)	100 (100%)	0	100	100
4	XV	87/210 (41%)	87 (100%)	0	100	100
4	XW	100/210 (48%)	100 (100%)	0	100	100
4	XX	87/210 (41%)	87 (100%)	0	100	100
4	XY	100/210 (48%)	100 (100%)	0	100	100
4	XZ	87/210 (41%)	87 (100%)	0	100	100
4	YA	100/210 (48%)	100 (100%)	0	100	100
4	YB	87/210 (41%)	87 (100%)	0	100	100
4	YC	100/210 (48%)	100 (100%)	0	100	100
4	YD	87/210 (41%)	87 (100%)	0	100	100
4	YE	100/210 (48%)	100 (100%)	0	100	100
4	YF	87/210 (41%)	87 (100%)	0	100	100
5	AM	141/218 (65%)	141 (100%)	0	100	100
5	DM	141/218 (65%)	141 (100%)	0	100	100
5	GM	141/218 (65%)	141 (100%)	0	100	100
5	JM	141/218 (65%)	141 (100%)	0	100	100

Continued on next page...

Continued from previous page...

Mol	Chain	Analysed	Rotameric	Outliers	Percentiles	
5	MM	141/218 (65%)	141 (100%)	0	100	100
6	PA	304/374 (81%)	304 (100%)	0	100	100
6	PB	331/374 (88%)	331 (100%)	0	100	100
6	PC	315/374 (84%)	315 (100%)	0	100	100
6	PD	307/374 (82%)	307 (100%)	0	100	100
6	PE	322/374 (86%)	322 (100%)	0	100	100
6	PF	305/374 (82%)	305 (100%)	0	100	100
6	PG	310/374 (83%)	310 (100%)	0	100	100
6	PH	315/374 (84%)	315 (100%)	0	100	100
6	PI	306/374 (82%)	306 (100%)	0	100	100
6	PJ	322/374 (86%)	322 (100%)	0	100	100
6	PK	323/374 (86%)	323 (100%)	0	100	100
6	PL	336/374 (90%)	336 (100%)	0	100	100
All	All	71241/113143 (63%)	71241 (100%)	0	100	100

There are no protein residues with a non-rotameric sidechain to report.

Sometimes sidechains can be flipped to improve hydrogen bonding and reduce clashes. 5 of 156 such sidechains are listed below:

Mol	Chain	Res	Type
1	ND	44	GLN
4	TG	150	GLN
2	NN	24	ASN
6	PE	249	ASN
4	TX	84	ASN

5.3.3 RNA [i](#)

There are no RNA molecules in this entry.

5.4 Non-standard residues in protein, DNA, RNA chains [i](#)

There are no non-standard protein/DNA/RNA residues in this entry.

5.5 Carbohydrates [i](#)

There are no monosaccharides in this entry.

5.6 Ligand geometry [i](#)

There are no ligands in this entry.

5.7 Other polymers [i](#)

There are no such residues in this entry.

5.8 Polymer linkage issues [i](#)

There are no chain breaks in this entry.

6 Map visualisation [i](#)

This section contains visualisations of the EMDB entry EMD-17675. These allow visual inspection of the internal detail of the map and identification of artifacts.

Images derived from a raw map, generated by summing the deposited half-maps, are presented below the corresponding image components of the primary map to allow further visual inspection and comparison with those of the primary map.

6.1 Orthogonal projections [i](#)

6.1.1 Primary map

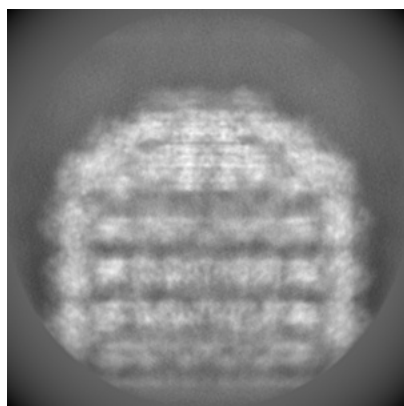

X

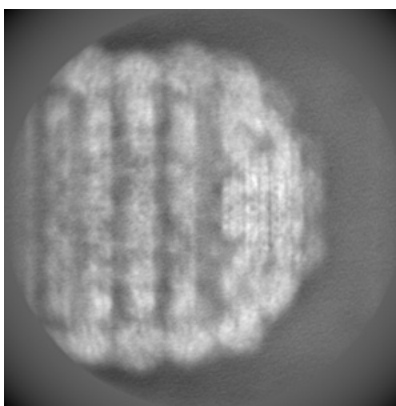

Y

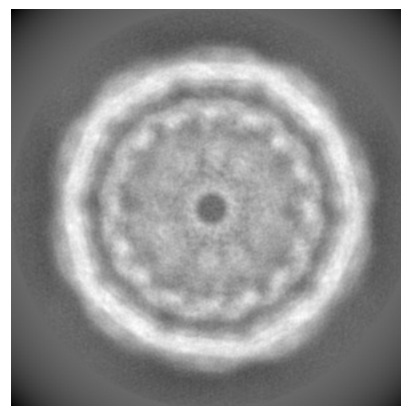

Z

6.1.2 Raw map

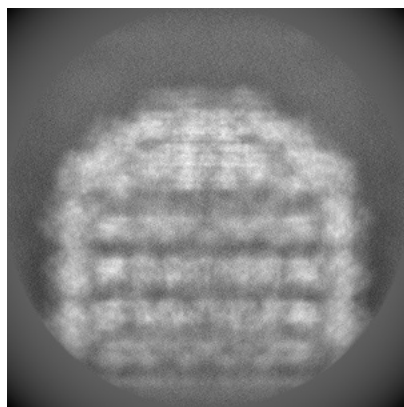

X

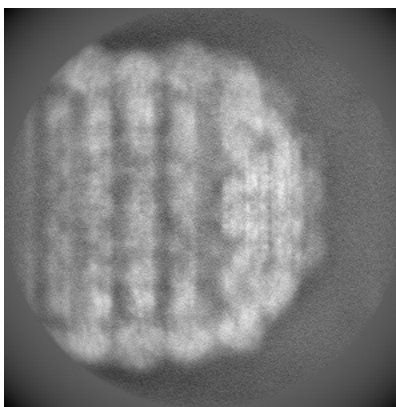

Y

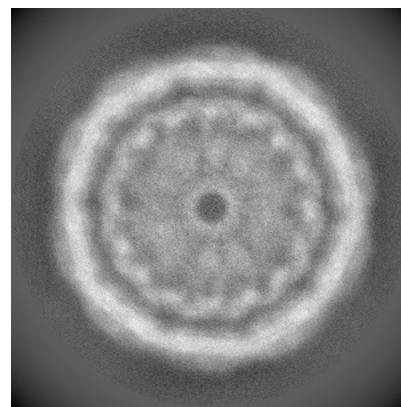

Z

The images above show the map projected in three orthogonal directions.

6.2 Central slices [i](#)

6.2.1 Primary map

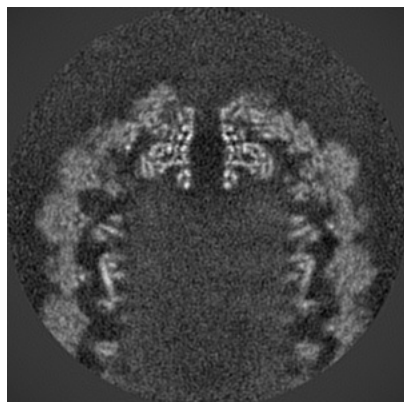

X Index: 320

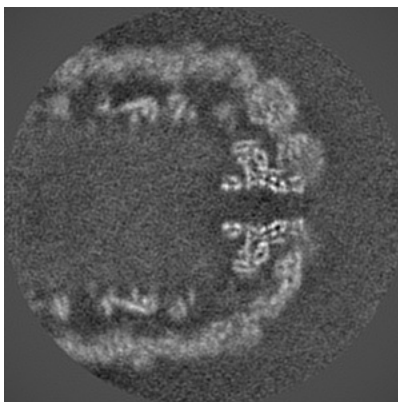

Y Index: 320

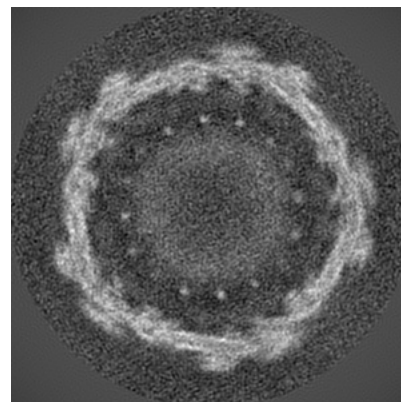

Z Index: 320

6.2.2 Raw map

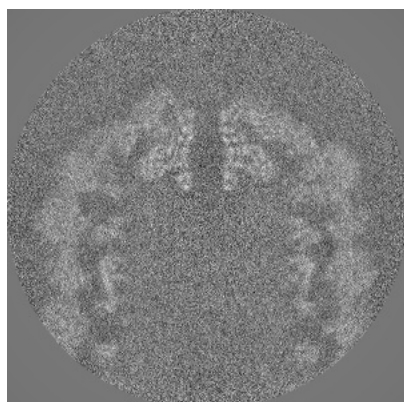

X Index: 320

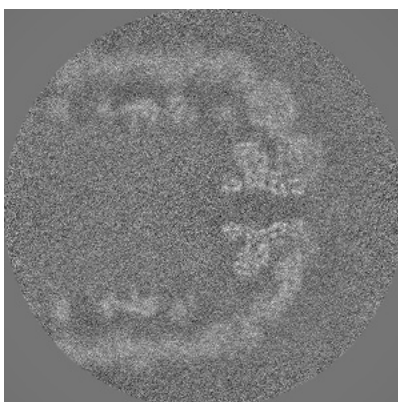

Y Index: 320

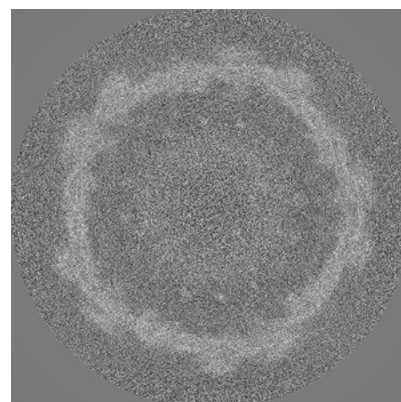

Z Index: 320

The images above show central slices of the map in three orthogonal directions.

6.3 Largest variance slices [i](#)

6.3.1 Primary map

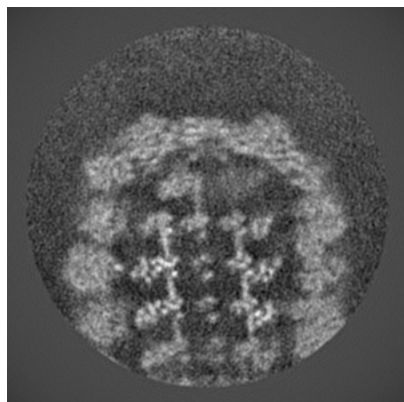

X Index: 179

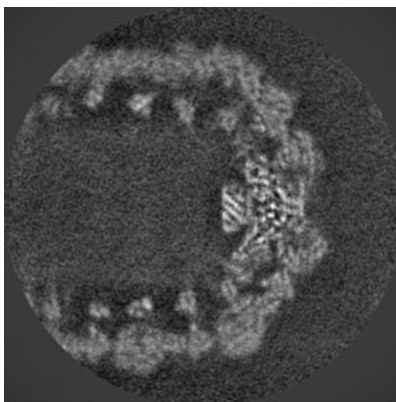

Y Index: 290

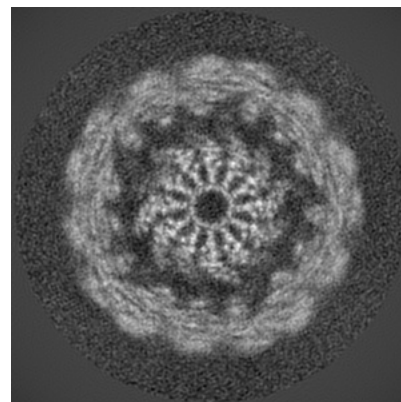

Z Index: 389

6.3.2 Raw map

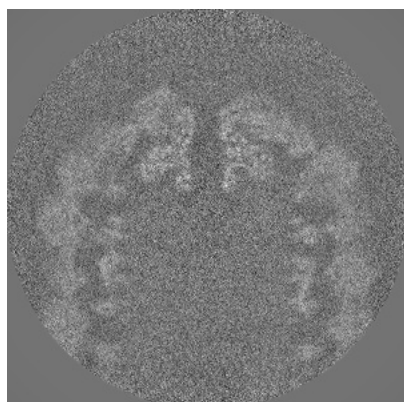

X Index: 323

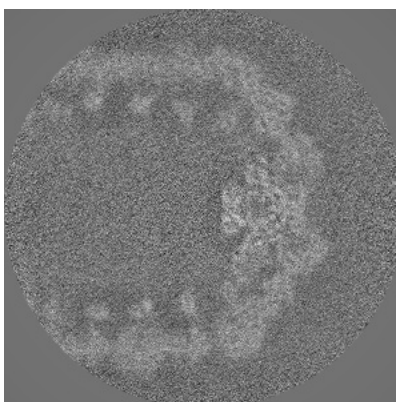

Y Index: 292

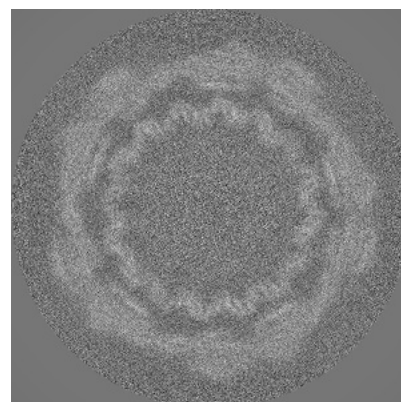

Z Index: 288

The images above show the largest variance slices of the map in three orthogonal directions.

6.4 Orthogonal standard-deviation projections (False-color) [i](#)

6.4.1 Primary map

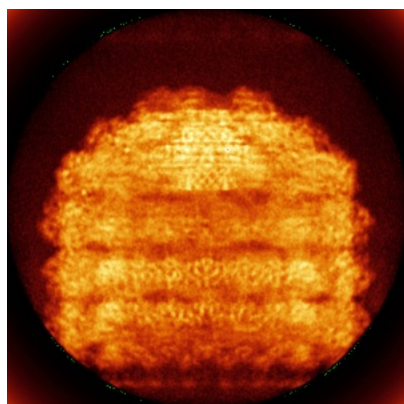

X

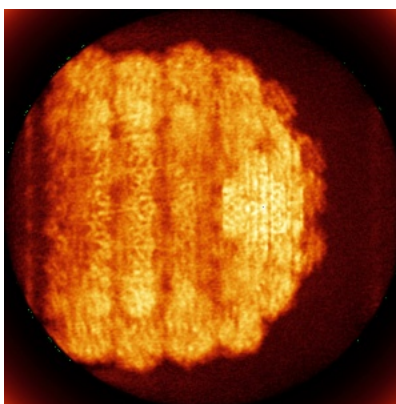

Y

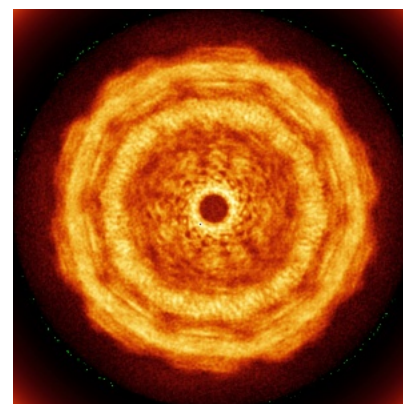

Z

6.4.2 Raw map

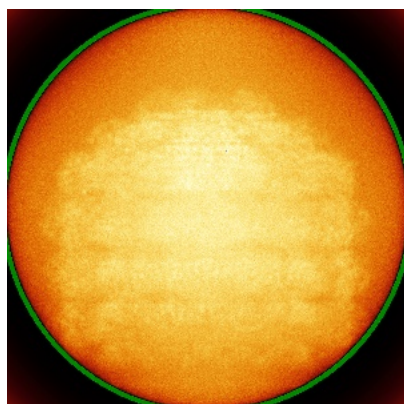

X

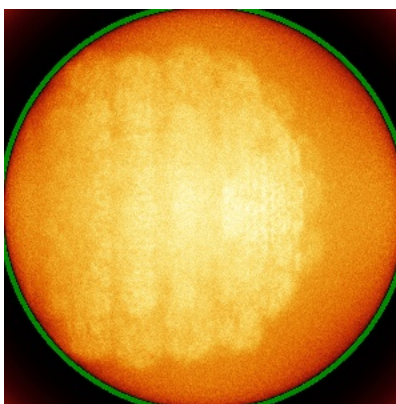

Y

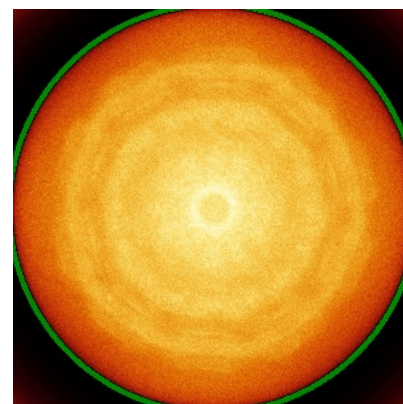

Z

The images above show the map standard deviation projections with false color in three orthogonal directions. Minimum values are shown in green, max in blue, and dark to light orange shades represent small to large values respectively.

6.5 Orthogonal surface views [i](#)

6.5.1 Primary map

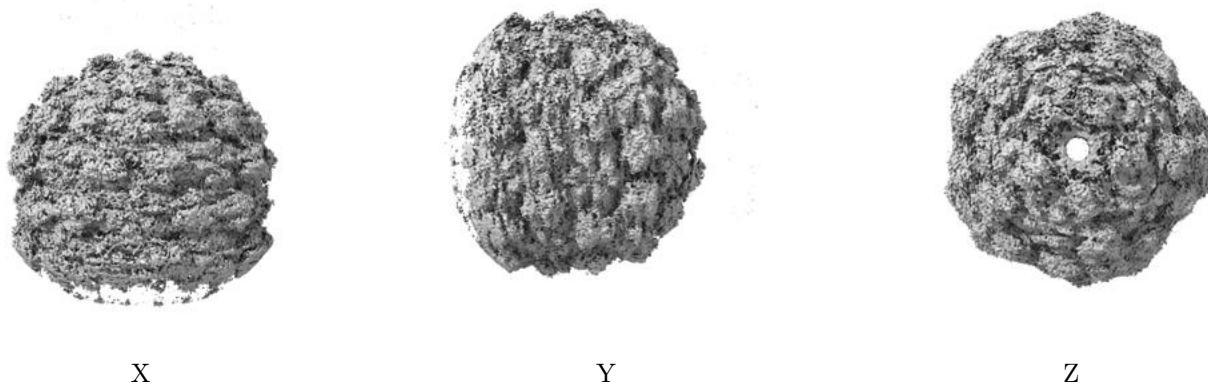

The images above show the 3D surface view of the map at the recommended contour level 0.003. These images, in conjunction with the slice images, may facilitate assessment of whether an appropriate contour level has been provided.

6.5.2 Raw map

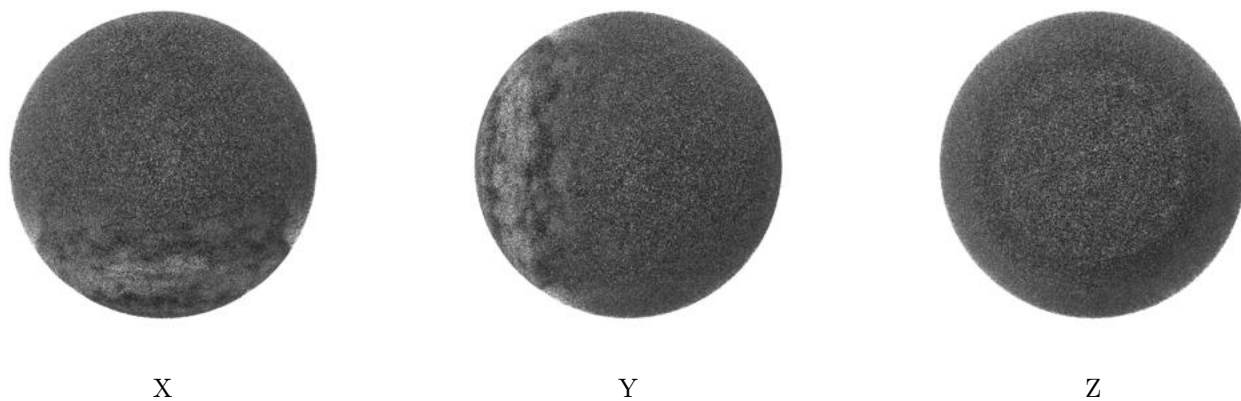

These images show the 3D surface of the raw map. The raw map's contour level was selected so that its surface encloses the same volume as the primary map does at its recommended contour level.

6.6 Mask visualisation [i](#)

This section shows the 3D surface view of the primary map at 50% transparency overlaid with the specified mask at 0% transparency

A mask typically either:

- Encompasses the whole structure
- Separates out a domain, a functional unit, a monomer or an area of interest from a larger structure

6.6.1 emd_17675_msk_1.map [i](#)

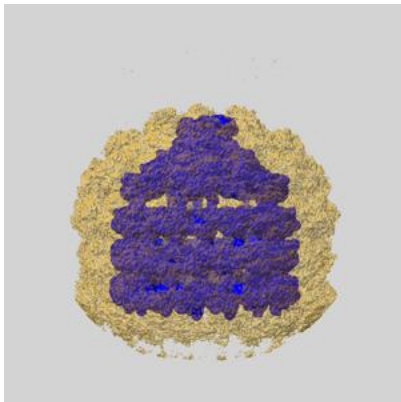

X

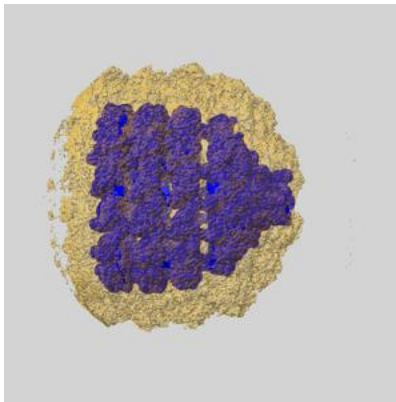

Y

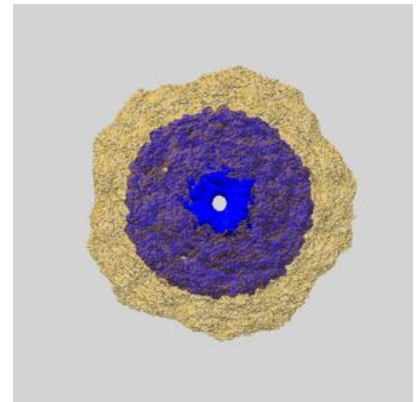

Z

7 Map analysis [i](#)

This section contains the results of statistical analysis of the map.

7.1 Map-value distribution [i](#)

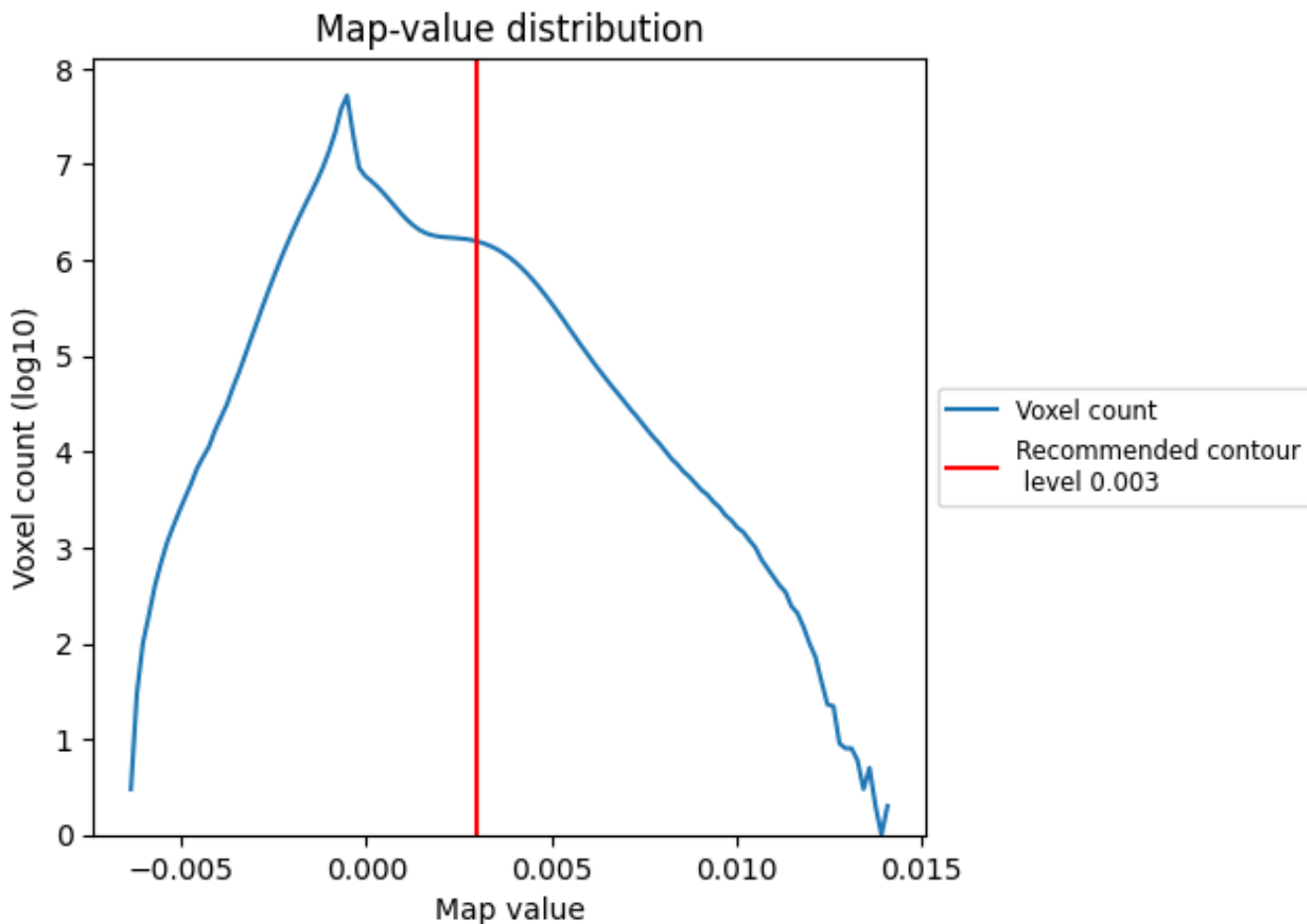

The map-value distribution is plotted in 128 intervals along the x-axis. The y-axis is logarithmic. A spike in this graph at zero usually indicates that the volume has been masked.

7.2 Volume estimate [\(i\)](#)

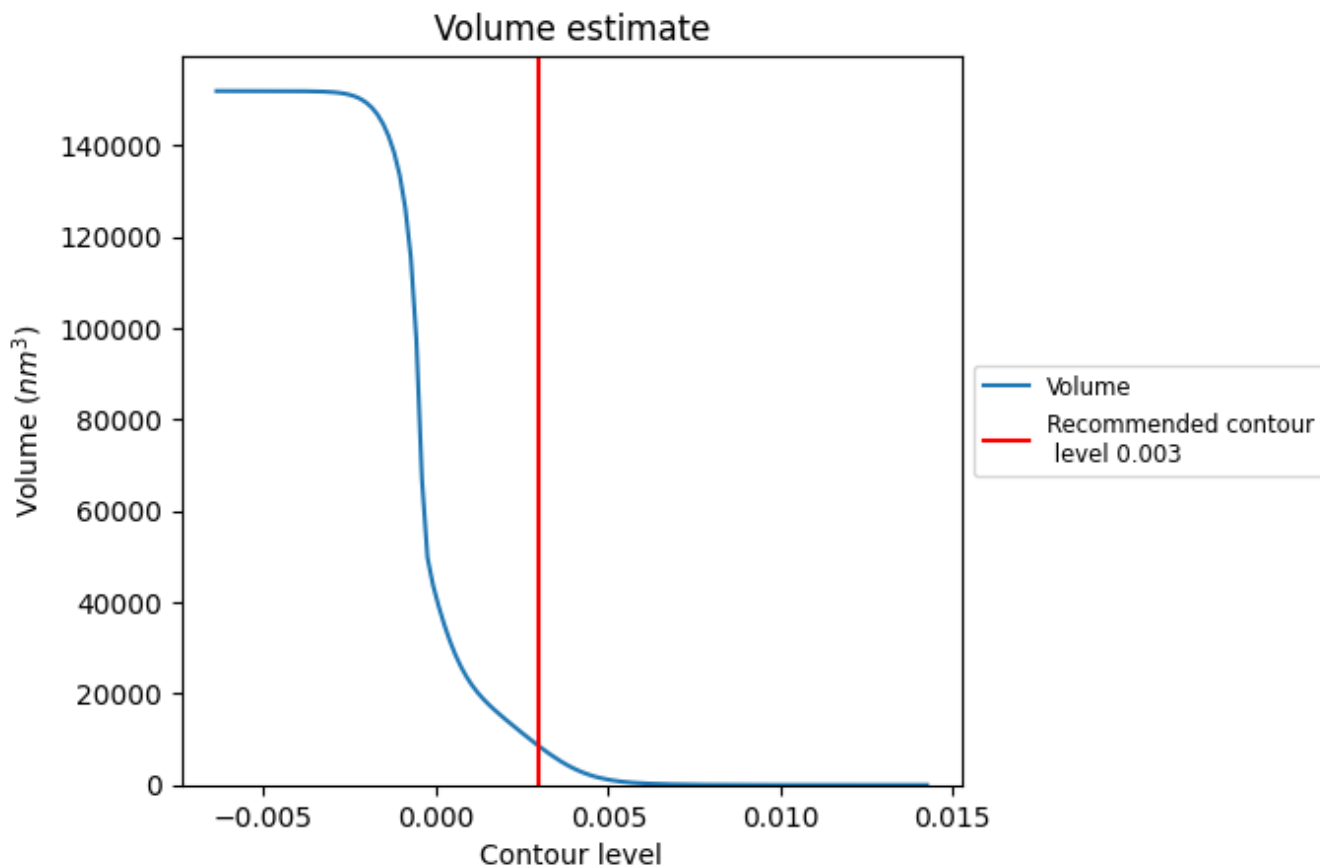

The volume at the recommended contour level is 8440 nm³; this corresponds to an approximate mass of 7624 kDa.

The volume estimate graph shows how the enclosed volume varies with the contour level. The recommended contour level is shown as a vertical line and the intersection between the line and the curve gives the volume of the enclosed surface at the given level.

7.3 Rotationally averaged power spectrum i

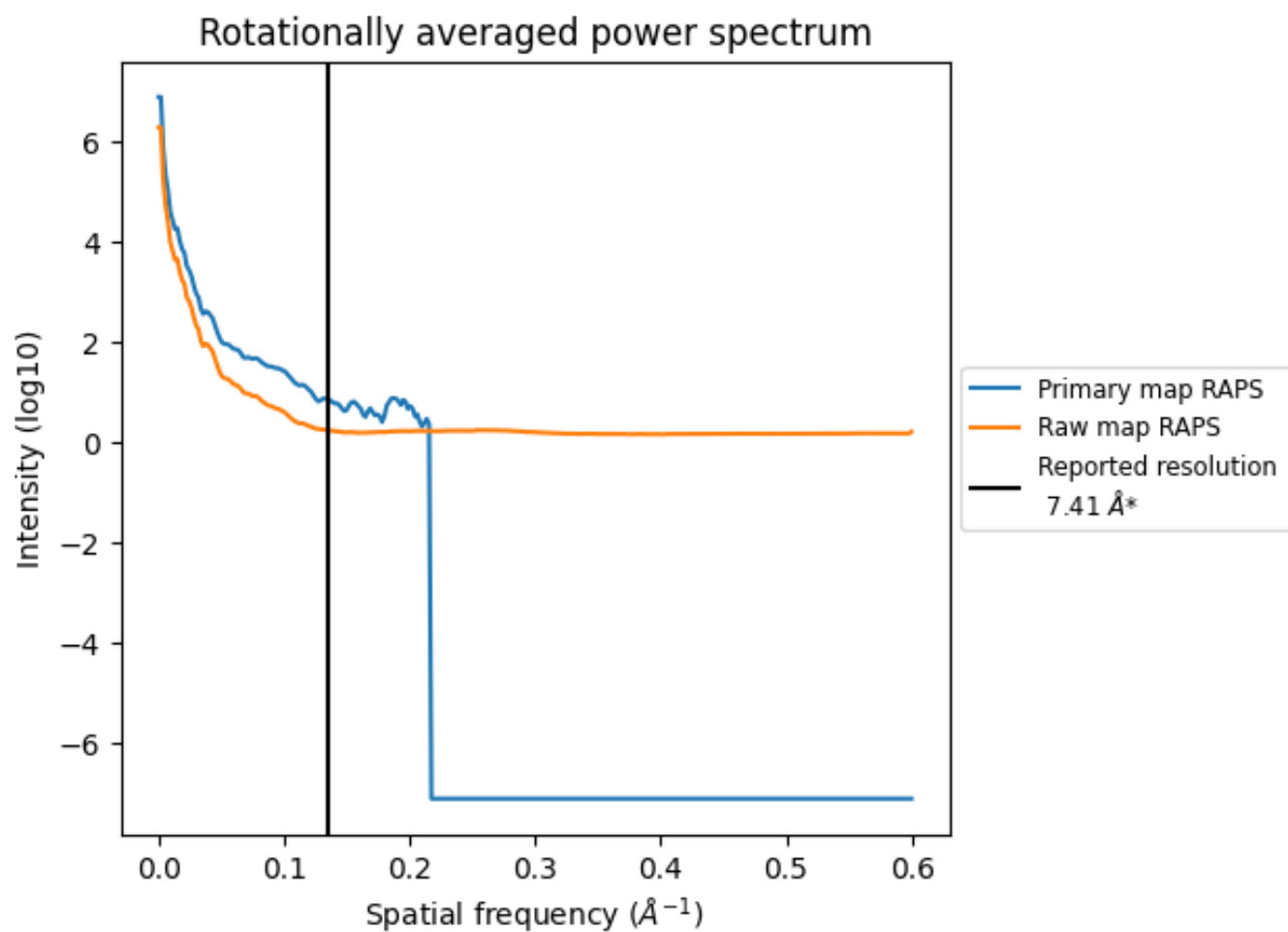

*Reported resolution corresponds to spatial frequency of 0.135 Å⁻¹

8 Fourier-Shell correlation [i](#)

Fourier-Shell Correlation (FSC) is the most commonly used method to estimate the resolution of single-particle and subtomogram-averaged maps. The shape of the curve depends on the imposed symmetry, mask and whether or not the two 3D reconstructions used were processed from a common reference. The reported resolution is shown as a black line. A curve is displayed for the half-bit criterion in addition to lines showing the 0.143 gold standard cut-off and 0.5 cut-off.

8.1 FSC [i](#)

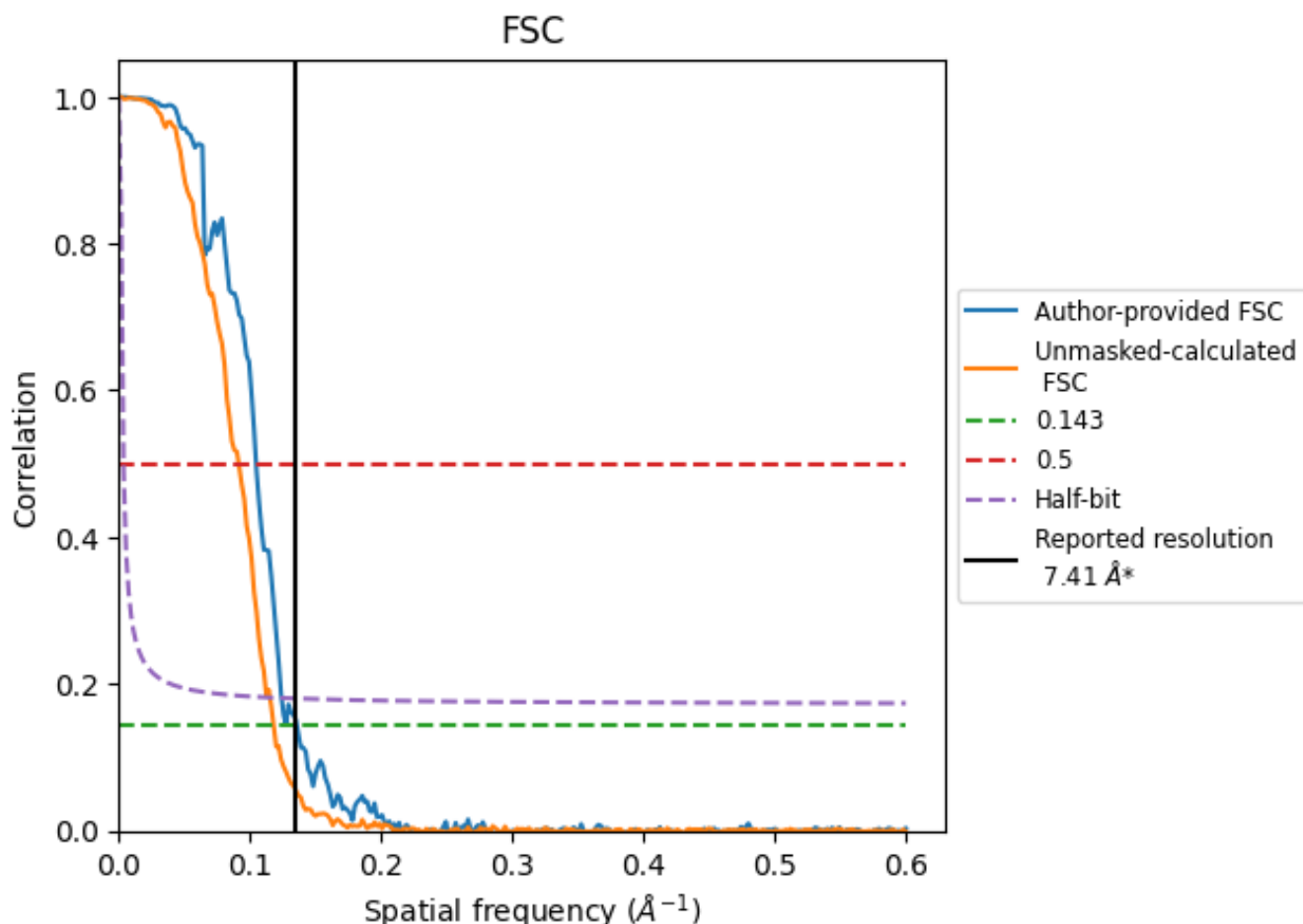

*Reported resolution corresponds to spatial frequency of 0.135 Å⁻¹

8.2 Resolution estimates [i](#)

Resolution estimate (Å)	Estimation criterion (FSC cut-off)		
	0.143	0.5	Half-bit
Reported by author	7.41	-	-
Author-provided FSC curve	7.37	9.56	8.06
Unmasked-calculated*	8.47	10.93	8.67

*Resolution estimate based on FSC curve calculated by comparison of deposited half-maps. The value from deposited half-maps intersecting FSC 0.143 CUT-OFF 8.47 differs from the reported value 7.41 by more than 10 %

9 Map-model fit [i](#)

This section contains information regarding the fit between EMDB map EMD-17675 and PDB model 8PHU. Per-residue inclusion information can be found in section 3 on page 49.

9.1 Map-model overlay [i](#)

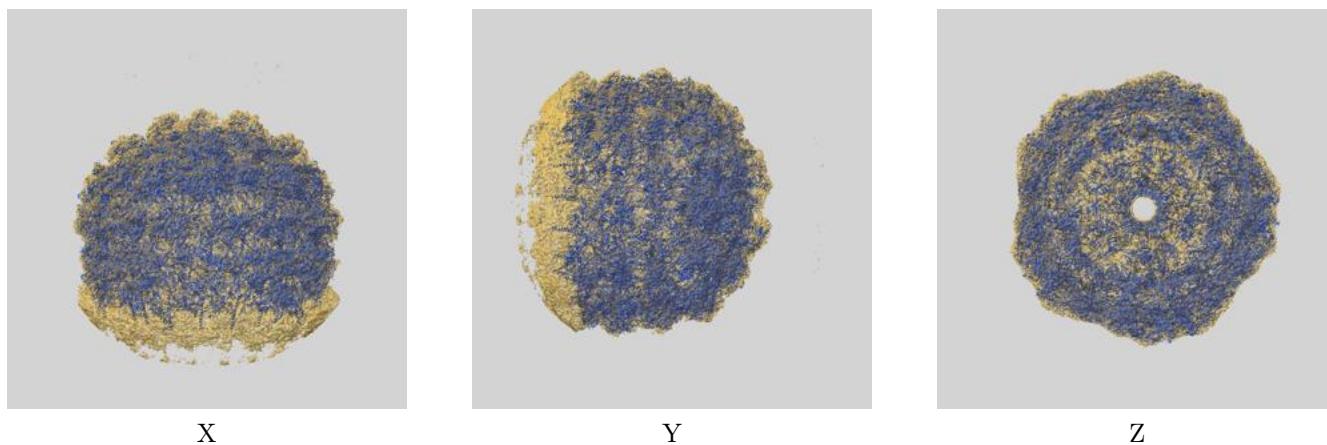

The images above show the 3D surface view of the map at the recommended contour level 0.003 at 50% transparency in yellow overlaid with a ribbon representation of the model coloured in blue. These images allow for the visual assessment of the quality of fit between the atomic model and the map.

9.2 Q-score mapped to coordinate model [i](#)

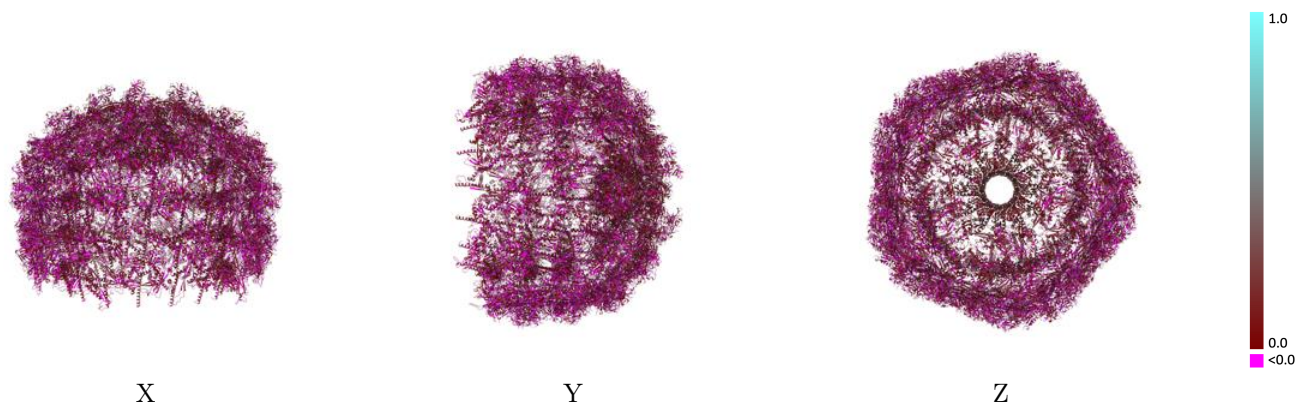

The images above show the model with each residue coloured according to its Q-score. This shows their resolvability in the map with higher Q-score values reflecting better resolvability. Please note: Q-score is calculating the resolvability of atoms, and thus high values are only expected at resolutions at which atoms can be resolved. Low Q-score values may therefore be expected for many entries.

9.3 Atom inclusion mapped to coordinate model [i](#)

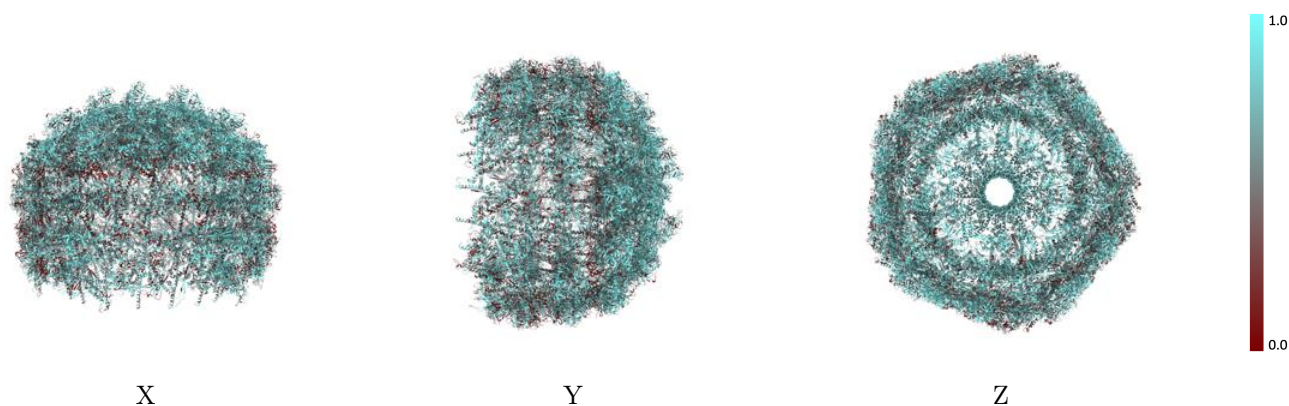

The images above show the model with each residue coloured according to its atom inclusion. This shows to what extent they are inside the map at the recommended contour level (0.003).

9.4 Atom inclusion [i](#)

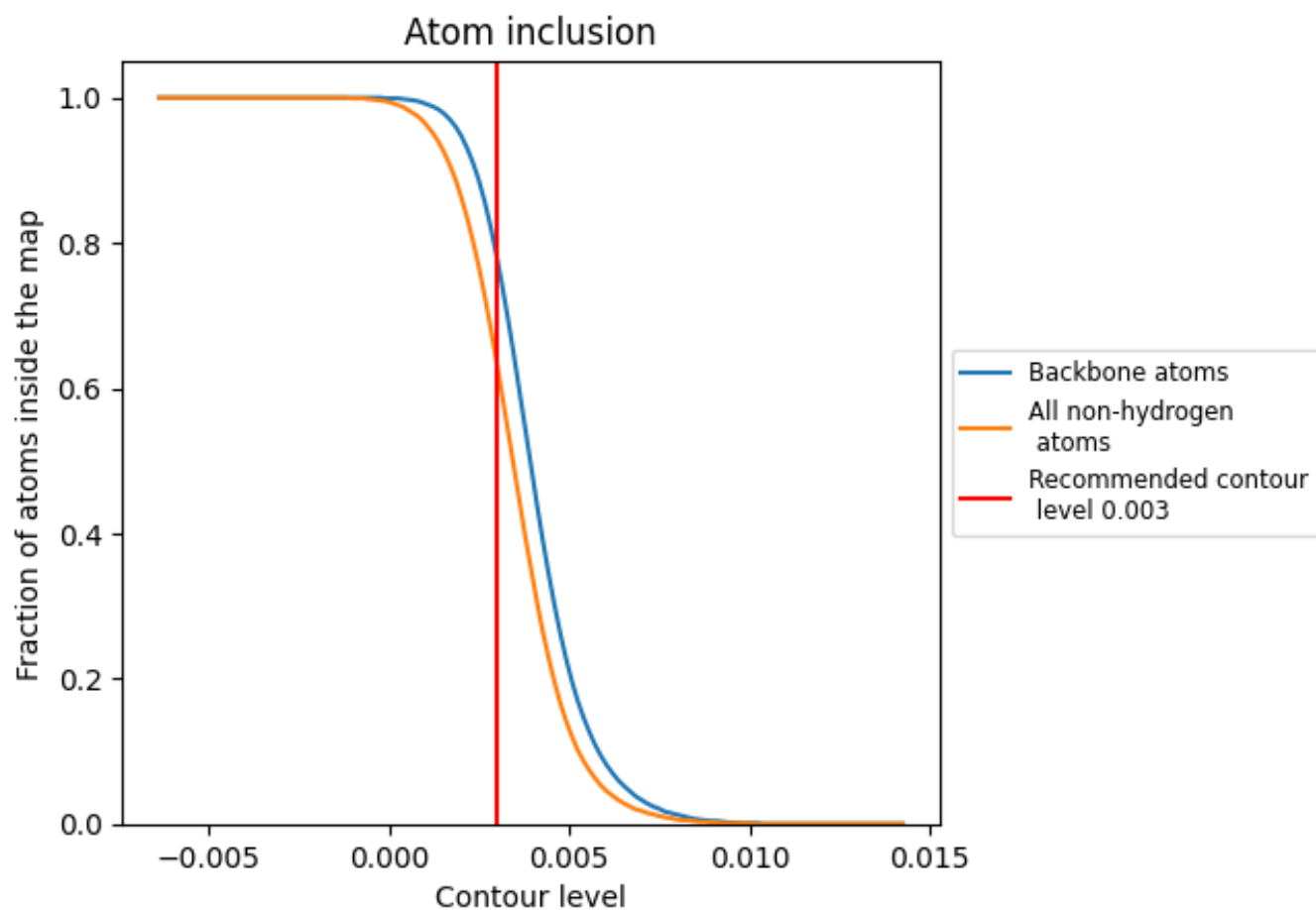

At the recommended contour level, 78% of all backbone atoms, 63% of all non-hydrogen atoms, are inside the map.

9.5 Map-model fit summary

The table lists the average atom inclusion at the recommended contour level (0.003) and Q-score for the entire model and for each chain.

Chain	Atom inclusion	Q-score
All	0.6330	0.0960
AB	0.7840	0.1350
AC	0.7800	0.1150
AD	0.6450	0.1040
AF	0.6990	0.0970
AH	0.5900	0.1260
AI	0.7250	0.1300
AJ	0.6210	0.0850
AK	0.7070	0.0830
AL	0.7460	0.0980
AM	0.6370	0.0650
AN	0.6590	0.0960
AO	0.6490	0.0980
AP	0.4690	0.0730
AQ	0.5730	0.1040
AR	0.5640	0.0960
AS	0.6820	0.0900
AT	0.5210	0.0590
AU	0.6630	0.0840
AV	0.7500	0.0530
AW	0.7330	0.0760
AX	0.6760	0.0750
AY	0.5410	0.0920
AZ	0.3880	0.1330
BA	0.5830	0.0670
BB	0.5250	0.0590
BC	0.5640	0.0800
BD	0.5850	0.0740
BE	0.5690	0.0620
BF	0.6690	0.0550
BG	0.5580	0.0490
BH	0.3390	0.0670
BI	0.3230	0.1010
BJ	0.5340	0.1150
BK	0.6540	0.0810























































































Continued on next page...

Continued from previous page...

Chain	Atom inclusion	Q-score
BL	0.5850	0.0560
BM	0.5170	0.0600
BN	0.4250	0.0530
BO	0.4520	0.0730
BP	0.4890	0.0640
BQ	0.1000	0.0410
BR	0.5280	0.1150
BS	0.4360	0.1070
BT	0.5930	0.0730
BU	0.6660	0.0960
BV	0.6330	0.0880
BW	0.7110	0.0880
BX	0.6080	0.0650
BY	0.6870	0.0750
BZ	0.6090	0.1510
CA	0.6490	0.1310
CB	0.3080	0.1170
CC	0.5380	0.0530
CD	0.5480	0.0550
CE	0.6530	0.0750
CF	0.6020	0.0610
CG	0.4570	0.0670
CH	0.4800	0.0510
CI	0.5930	0.1270
CJ	0.2750	0.1300
CK	0.2220	0.1130
CL	0.5170	0.0670
CM	0.6060	0.0630
CN	0.5130	0.0520
CO	0.6410	0.0400
CP	0.5780	0.0540
CQ	0.6840	0.0510
CR	0.5340	0.0970
CS	0.3090	0.0530
CT	0.1660	0.0770
CU	0.4190	0.0430
CV	0.6120	0.0850
CW	0.5530	0.0550
CX	0.3260	0.1170
CY	0.2170	0.0580
CZ	0.6200	0.1280
DB	0.7830	0.1310





















































































Continued on next page...

Continued from previous page...

Chain	Atom inclusion	Q-score
DC	 0.7690	 0.1200
DD	 0.5850	 0.0740
DF	 0.7360	 0.1010
DH	 0.6480	 0.1320
DI	 0.7570	 0.1480
DJ	 0.6560	 0.0790
DK	 0.7040	 0.1040
DL	 0.7540	 0.1070
DM	 0.6250	 0.0690
DN	 0.6450	 0.0720
DO	 0.6440	 0.0900
DP	 0.4660	 0.0730
DQ	 0.6680	 0.1320
DR	 0.6030	 0.1230
DS	 0.6530	 0.0650
DT	 0.6000	 0.0900
DU	 0.6910	 0.0920
DV	 0.7600	 0.0650
DW	 0.7580	 0.1110
DX	 0.6930	 0.0710
DY	 0.5500	 0.1040
DZ	 0.3940	 0.1190
EA	 0.6190	 0.1120
EB	 0.5170	 0.0780
EC	 0.5440	 0.0800
ED	 0.6410	 0.0830
EE	 0.5540	 0.0740
EF	 0.5710	 0.0700
EG	 0.4960	 0.0600
EH	 0.4430	 0.1020
EI	 0.3840	 0.1130
EJ	 0.5640	 0.1380
EK	 0.6170	 0.0680
EL	 0.6000	 0.0550
EM	 0.5080	 0.0650
EN	 0.4980	 0.0630
EO	 0.4580	 0.0260
EP	 0.6120	 0.0680
EQ	 0.0540	 0.0380
ER	 0.5370	 0.0930
ES	 0.3520	 0.0610
ET	 0.5940	 0.0600





















































































Continued on next page...

Continued from previous page...

Chain	Atom inclusion	Q-score
EU	 0.6510	 0.0950
EV	 0.5870	 0.0820
EW	 0.7390	 0.0620
EX	 0.6760	 0.0650
EY	 0.7010	 0.0550
EZ	 0.5900	 0.1060
FA	 0.6220	 0.1270
FB	 0.1860	 0.1090
FC	 0.5640	 0.0720
FD	 0.5630	 0.0730
FE	 0.6260	 0.0720
FF	 0.6630	 0.0620
FG	 0.6000	 0.0530
FH	 0.5950	 0.0540
FI	 0.4720	 0.0930
FJ	 0.1980	 0.1280
FK	 0.3030	 0.0830
FL	 0.5730	 0.0840
FM	 0.6830	 0.0790
FN	 0.5200	 0.0550
FO	 0.5980	 0.0670
FP	 0.4970	 0.0660
FQ	 0.6940	 0.0580
FR	 0.5540	 0.1270
FS	 0.3710	 0.0890
FT	 0.1130	 0.0800
FU	 0.4220	 0.0620
FV	 0.5770	 0.0660
FW	 0.5240	 0.0510
FX	 0.3450	 0.1030
FY	 0.3260	 0.0820
FZ	 0.6820	 0.1470
GB	 0.7900	 0.1550
GC	 0.8040	 0.1320
GD	 0.6760	 0.1270
GF	 0.7820	 0.1360
GH	 0.6870	 0.1140
GI	 0.7450	 0.1540
GJ	 0.7050	 0.1030
GK	 0.7240	 0.1130
GL	 0.7820	 0.1320
GM	 0.6400	 0.1020





















































































Continued on next page...

Continued from previous page...

Chain	Atom inclusion	Q-score
GN	 0.7580	 0.1230
GO	 0.6710	 0.1220
GP	 0.5340	 0.1000
GQ	 0.6970	 0.1480
GR	 0.6710	 0.1440
GS	 0.6850	 0.1080
GT	 0.5630	 0.1020
GU	 0.6270	 0.1040
GV	 0.7330	 0.0570
GW	 0.7240	 0.0960
GX	 0.6460	 0.0810
GY	 0.6350	 0.1260
GZ	 0.4530	 0.1160
HA	 0.6510	 0.0950
HB	 0.6000	 0.0840
HC	 0.6400	 0.0820
HD	 0.6350	 0.0790
HE	 0.5700	 0.0720
HF	 0.5410	 0.0750
HG	 0.4480	 0.0690
HH	 0.4950	 0.1190
HI	 0.3910	 0.1140
HJ	 0.5640	 0.1210
HK	 0.7220	 0.0950
HL	 0.6840	 0.0770
HM	 0.6240	 0.0820
HN	 0.6060	 0.0610
HO	 0.6590	 0.0590
HP	 0.7180	 0.0510
HQ	 0.0790	 0.0360
HR	 0.5930	 0.1090
HS	 0.3910	 0.1060
HT	 0.7040	 0.0820
HU	 0.6820	 0.1060
HV	 0.6540	 0.1050
HW	 0.7890	 0.0860
HX	 0.7490	 0.0760
HY	 0.7810	 0.0790
HZ	 0.6190	 0.1120
IA	 0.5600	 0.0810
IB	 0.1540	 0.0540
IC	 0.5970	 0.0540





















































































Continued on next page...

Continued from previous page...

Chain	Atom inclusion	Q-score
ID	 0.6360	 0.0660
IE	 0.6670	 0.0720
IF	 0.7320	 0.0730
IG	 0.6500	 0.0650
IH	 0.6790	 0.0240
II	 0.5340	 0.1080
IJ	 0.2830	 0.0760
IK	 0.3130	 0.0940
IL	 0.6030	 0.0670
IM	 0.6490	 0.0860
IN	 0.5250	 0.0540
IO	 0.5560	 0.0650
IP	 0.4370	 0.0520
IQ	 0.5800	 0.0830
IR	 0.5860	 0.1300
IS	 0.3970	 0.1230
IT	 0.1500	 0.0950
IU	 0.5240	 0.0830
IV	 0.6840	 0.0680
IW	 0.6140	 0.0620
IX	 0.3530	 0.0730
IY	 0.2750	 0.0840
IZ	 0.7170	 0.1580
JB	 0.7830	 0.1290
JC	 0.7870	 0.1070
JD	 0.5260	 0.0940
JF	 0.7510	 0.1080
JH	 0.6580	 0.1280
JI	 0.7130	 0.1030
JJ	 0.6740	 0.0860
JK	 0.7220	 0.0930
JL	 0.7540	 0.1140
JM	 0.6300	 0.0580
JN	 0.6820	 0.0930
JO	 0.6720	 0.0900
JP	 0.5370	 0.1170
JQ	 0.6640	 0.1180
JR	 0.6380	 0.1210
JS	 0.6770	 0.0790
JT	 0.5560	 0.0620
JU	 0.6880	 0.0940
JV	 0.7130	 0.0470





















































































Continued on next page...

Continued from previous page...

Chain	Atom inclusion	Q-score
JW	 0.7380	 0.0970
JX	 0.6420	 0.0400
JY	 0.5730	 0.1050
JZ	 0.3620	 0.1070
KA	 0.6770	 0.1040
KB	 0.5960	 0.0890
KC	 0.6220	 0.0730
KD	 0.6170	 0.0760
KE	 0.6200	 0.0470
KF	 0.6160	 0.0710
KG	 0.5530	 0.0600
KH	 0.4720	 0.0940
KI	 0.4460	 0.0780
KJ	 0.5110	 0.0940
KK	 0.6440	 0.0730
KL	 0.5940	 0.0780
KM	 0.5720	 0.0610
KN	 0.6080	 0.0610
KO	 0.6670	 0.0860
KP	 0.6600	 0.0480
KQ	 0.2080	 0.1050
KR	 0.5500	 0.0940
KS	 0.4850	 0.1310
KT	 0.6390	 0.0600
KU	 0.6080	 0.0920
KV	 0.5830	 0.0940
KW	 0.7810	 0.0850
KX	 0.6950	 0.0560
KY	 0.6880	 0.0730
KZ	 0.6160	 0.1230
LA	 0.5280	 0.0800
LB	 0.3850	 0.0710
LC	 0.5590	 0.0590
LD	 0.5480	 0.0630
LE	 0.6070	 0.0600
LF	 0.6330	 0.0560
LG	 0.5880	 0.0650
LH	 0.6350	 0.0580
LI	 0.5700	 0.1140
LJ	 0.3120	 0.0920
LK	 0.2280	 0.0700
LL	 0.6040	 0.0840





















































































Continued on next page...

Continued from previous page...

Chain	Atom inclusion	Q-score
LM	 0.6210	 0.0650
LN	 0.5220	 0.0590
LO	 0.5730	 0.0530
LP	 0.4720	 0.0460
LQ	 0.6180	 0.0750
LR	 0.5930	 0.1220
LS	 0.2870	 0.0760
LT	 0.1420	 0.0840
LU	 0.5240	 0.0600
LV	 0.6350	 0.0700
LW	 0.5180	 0.0630
LX	 0.2520	 0.0750
LY	 0.3410	 0.0640
LZ	 0.6550	 0.1070
MB	 0.7870	 0.1460
MC	 0.7770	 0.1250
MD	 0.6890	 0.1030
MF	 0.7520	 0.1110
MH	 0.6770	 0.1360
MI	 0.7000	 0.1180
MJ	 0.6710	 0.0690
MK	 0.7240	 0.0900
ML	 0.7350	 0.0970
MM	 0.6790	 0.0880
MN	 0.6800	 0.0880
MO	 0.6650	 0.0710
MP	 0.4820	 0.0740
MQ	 0.6350	 0.0960
MR	 0.5670	 0.1030
MS	 0.7330	 0.0870
MT	 0.6130	 0.0840
MU	 0.6900	 0.1040
MV	 0.7640	 0.0660
MW	 0.7630	 0.0910
MX	 0.7110	 0.0790
MY	 0.5930	 0.1030
MZ	 0.4140	 0.0890
NA	 0.5930	 0.0900
NB	 0.6480	 0.0690
NC	 0.6780	 0.0790
ND	 0.6670	 0.0650
NE	 0.6380	 0.0480





















































































Continued on next page...

Continued from previous page...

Chain	Atom inclusion	Q-score
NF	 0.6520	 0.0630
NG	 0.5870	 0.0730
NH	 0.4330	 0.0970
NI	 0.4430	 0.0680
NJ	 0.5470	 0.1260
NK	 0.7030	 0.0790
NL	 0.6210	 0.0630
NM	 0.5710	 0.0650
NN	 0.5380	 0.0620
NO	 0.5690	 0.0430
NP	 0.5700	 0.0500
NQ	 0.1080	 0.0220
NR	 0.5860	 0.0920
NS	 0.4460	 0.0970
NT	 0.6490	 0.0600
NU	 0.6890	 0.1070
NV	 0.6060	 0.0750
NW	 0.7730	 0.0650
NX	 0.6440	 0.0650
NY	 0.7100	 0.0830
NZ	 0.6680	 0.1180
OA	 0.6220	 0.1290
OB	 0.1300	 0.0470
OC	 0.6020	 0.0610
OD	 0.5620	 0.0660
OE	 0.5890	 0.0560
OF	 0.5650	 0.0500
OG	 0.5470	 0.0740
OH	 0.5160	 0.0380
OI	 0.6320	 0.1050
OJ	 0.2510	 0.1140
OK	 0.2340	 0.0700
OL	 0.6660	 0.0710
OM	 0.6570	 0.0840
ON	 0.5550	 0.0450
OO	 0.7110	 0.0690
OP	 0.5820	 0.0650
OQ	 0.7330	 0.0570
OR	 0.6220	 0.1150
OS	 0.2670	 0.0700
OT	 0.1620	 0.0590
OU	 0.5520	 0.0690

Continued on next page...

Continued from previous page...

Chain	Atom inclusion	Q-score
OV	 0.6710	 0.0890
OW	 0.5820	 0.0620
OX	 0.2600	 0.0540
OY	 0.2790	 0.0540
OZ	 0.6780	 0.1490
PA	 0.7620	 0.1990
PB	 0.7470	 0.1910
PC	 0.7800	 0.2010
PD	 0.7810	 0.2010
PE	 0.7880	 0.2090
PF	 0.7750	 0.2010
PG	 0.7620	 0.2080
PH	 0.7780	 0.2080
PI	 0.7660	 0.1970
PJ	 0.7800	 0.2060
PK	 0.7750	 0.1950
PL	 0.7680	 0.2050
QA	 0.7310	 0.1620
QB	 0.7270	 0.1530
QC	 0.7110	 0.1320
QD	 0.5950	 0.1360
QE	 0.6580	 0.1550
QF	 0.5450	 0.1300
QG	 0.6670	 0.1690
QH	 0.7600	 0.1820
QI	 0.7550	 0.1670
QJ	 0.7420	 0.1840
RA	 0.2450	 0.0840
RB	 0.4610	 0.1100
SA	 0.4430	 0.0870
SB	 0.5030	 0.1390
SC	 0.6200	 0.1410
SD	 0.5560	 0.1420
SE	 0.6380	 0.1590
SF	 0.2840	 0.0570
SG	 0.2400	 0.0570
SH	 0.5230	 0.0750
SI	 0.4540	 0.1120
SJ	 0.5830	 0.1220
SK	 0.5320	 0.1250
SL	 0.5520	 0.1200
SM	 0.3010	 0.0640





















































































Continued on next page...

Continued from previous page...

Chain	Atom inclusion	Q-score
SN	0.5900	0.1240
SO	0.6430	0.1450
TA	0.7360	0.1480
TB	0.5670	0.1280
TC	0.7440	0.1550
TD	0.6180	0.1140
TE	0.7110	0.1270
TF	0.5910	0.1370
TG	0.5300	0.1230
TH	0.2720	0.0840
TI	0.7310	0.1550
TJ	0.6210	0.1150
TK	0.7590	0.1330
TL	0.5970	0.1320
TM	0.4810	0.1230
TN	0.3590	0.1210
TO	0.7380	0.1160
TP	0.6840	0.1440
TQ	0.7880	0.1610
TR	0.7160	0.1490
TS	0.6520	0.1270
TT	0.4920	0.1170
TU	0.4870	0.1090
TV	0.3530	0.1100
TW	0.6880	0.1250
TX	0.6330	0.1040
TY	0.6920	0.1310
TZ	0.5340	0.1160
UA	0.2910	0.0920
UB	0.1860	0.1060
UC	0.6300	0.1060
UD	0.6390	0.1090
UE	0.7730	0.1330
UF	0.6860	0.1380
VA	0.7450	0.1630
VB	0.6580	0.1350
VC	0.7360	0.1560
VD	0.7110	0.1680
VE	0.7360	0.1550
VF	0.6990	0.1530
VG	0.7620	0.1670
VH	0.7140	0.1450





























Continued on next page...

Continued from previous page...

Chain	Atom inclusion	Q-score
VI	 0.7700	 0.1660
VJ	 0.7550	 0.1630
VK	 0.8060	 0.1860
VL	 0.6890	 0.1660
VM	 0.7670	 0.1650
VN	 0.7320	 0.1540
VO	 0.7610	 0.1620
VP	 0.7700	 0.1790
VQ	 0.7710	 0.1690
VR	 0.6520	 0.1510
VS	 0.7380	 0.1650
VT	 0.7230	 0.1550
VU	 0.7630	 0.1640
VV	 0.7140	 0.1610
VW	 0.7340	 0.1580
VX	 0.6960	 0.1550
VY	 0.7490	 0.1580
VZ	 0.6860	 0.1580
WA	 0.7620	 0.1600
WB	 0.7240	 0.1480
WC	 0.7670	 0.1660
WD	 0.7050	 0.1470
WE	 0.7690	 0.1610
WF	 0.7380	 0.1550
XA	 0.7250	 0.1610
XB	 0.5730	 0.1280
XC	 0.7200	 0.1550
XD	 0.6590	 0.1330
XE	 0.7460	 0.1760
XF	 0.7030	 0.1390
XG	 0.7010	 0.1370
XH	 0.5700	 0.1440
XI	 0.6890	 0.1500
XJ	 0.6220	 0.1560
XK	 0.7000	 0.1640
XL	 0.7140	 0.1460
XM	 0.7360	 0.1510
XN	 0.6430	 0.1530
XO	 0.7100	 0.1530
XP	 0.6230	 0.1470
XQ	 0.6850	 0.1590
XR	 0.6710	 0.1630

Continued on next page...

Continued from previous page...

Chain	Atom inclusion	Q-score
XS	 0.6620	 0.1430
XT	 0.5900	 0.1570
XU	 0.6790	 0.1610
XV	 0.5860	 0.1660
XW	 0.7190	 0.1560
XX	 0.6830	 0.1400
XY	 0.6990	 0.1670
XZ	 0.6270	 0.1320
YA	 0.6630	 0.1490
YB	 0.5790	 0.1470
YC	 0.7280	 0.1500
YD	 0.6920	 0.1470
YE	 0.6890	 0.1510
YF	 0.7120	 0.1490