



# Full wwPDB X-ray Structure Validation Report ⓘ

May 19, 2022 – 03:41 pm BST

PDB ID : 7PMZ  
Title : Crystal structure of Streptomyces coelicolor guaB (IMP dehydrogenase) bound to ATP and ppGpp at 2.0 Å resolution  
Authors : Fernandez-Justel, D.; Revuelta, J.L.; Buey, R.M.  
Deposited on : 2021-09-04  
Resolution : 2.03 Å (reported)

This is a Full wwPDB X-ray Structure Validation Report for a publicly released PDB entry.

We welcome your comments at [validation@mail.wwpdb.org](mailto:validation@mail.wwpdb.org)

A user guide is available at

<https://www.wwpdb.org/validation/2017/XrayValidationReportHelp>

with specific help available everywhere you see the ⓘ symbol.

---

The following versions of software and data (see [references ⓘ](#)) were used in the production of this report:

MolProbity : 4.02b-467  
Mogul : 1.8.4, CSD as541be (2020)  
Xtriage (Phenix) : 1.13  
EDS : 2.28.1  
buster-report : 1.1.7 (2018)  
Percentile statistics : 20191225.v01 (using entries in the PDB archive December 25th 2019)  
Refmac : 5.8.0267  
CCP4 : 7.1.010 (Gargrove)  
Ideal geometry (proteins) : Engh & Huber (2001)  
Ideal geometry (DNA, RNA) : Parkinson et al. (1996)  
Validation Pipeline (wwPDB-VP) : 2.28.1

# 1 Overall quality at a glance

The following experimental techniques were used to determine the structure:

*X-RAY DIFFRACTION*

The reported resolution of this entry is 2.03 Å.

Percentile scores (ranging between 0-100) for global validation metrics of the entry are shown in the following graphic. The table shows the number of entries on which the scores are based.

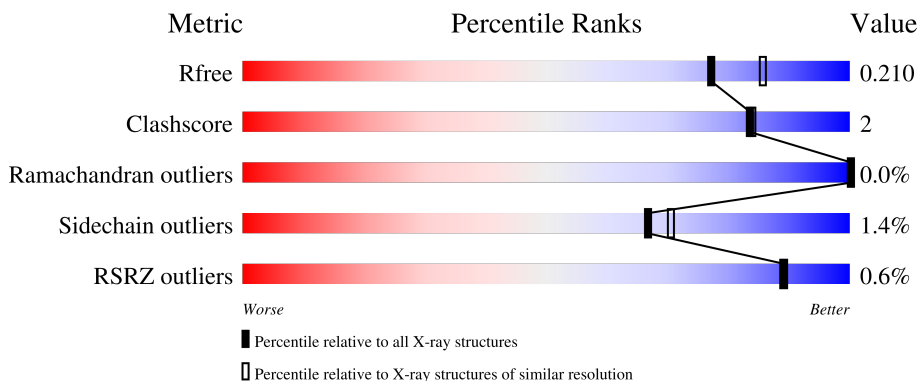

Metric	Whole archive (#Entries)	Similar resolution (#Entries, resolution range(Å))
$R_{free}$	130704	10434 (2.04-2.00)
Clashscore	141614	11643 (2.04-2.00)
Ramachandran outliers	138981	11493 (2.04-2.00)
Sidechain outliers	138945	11492 (2.04-2.00)
RSRZ outliers	127900	10220 (2.04-2.00)

The table below summarises the geometric issues observed across the polymeric chains and their fit to the electron density. The red, orange, yellow and green segments of the lower bar indicate the fraction of residues that contain outliers for  $\geq 3$ , 2, 1 and 0 types of geometric quality criteria respectively. A grey segment represents the fraction of residues that are not modelled. The numeric value for each fraction is indicated below the corresponding segment, with a dot representing fractions  $\leq 5\%$ . The upper red bar (where present) indicates the fraction of residues that have poor fit to the electron density. The numeric value is given above the bar.

Mol	Chain	Length	Quality of chain
1	A	504	 79% 6% 15%
1	B	504	 80% 6% 15%
1	C	504	 80% 5% 15%
1	D	504	 80% 5% 15%
1	E	504	 81% 5% 15%

*Continued on next page...*

*Continued from previous page...*

Mol	Chain	Length	Quality of chain
1	F	504	 80% 5% 15%
1	G	504	 % 81% • 15%
1	H	504	 82% • 15%
1	I	504	 % 80% • 15%
1	J	504	 82% • 15%
1	K	504	 82% • 15%
1	L	504	 79% 6% 15%
1	M	504	 81% • 15%
1	N	504	 % 80% • • 15%
1	O	504	 % 79% 5% 16%
1	P	504	 % 79% 6% 15%

## 2 Entry composition [i](#)

There are 5 unique types of molecules in this entry. The entry contains 101645 atoms, of which 48699 are hydrogens and 0 are deuteriums.

In the tables below, the ZeroOcc column contains the number of atoms modelled with zero occupancy, the AltConf column contains the number of residues with at least one atom in alternate conformation and the Trace column contains the number of residues modelled with at most 2 atoms.

- Molecule 1 is a protein called Inosine-5'-monophosphate dehydrogenase.

Mol	Chain	Residues	Atoms					ZeroOcc	AltConf	Trace	
			Total	C	H	N	O				S
1	A	428	Total 6157	C 1912	H 3101	N 547	O 582	S 15	0	0	0
1	B	430	Total 6058	C 1894	H 3025	N 540	O 585	S 14	0	0	0
1	C	427	Total 5937	C 1860	H 2959	N 532	O 572	S 14	0	0	0
1	D	428	Total 6102	C 1902	H 3062	N 539	O 584	S 15	0	0	0
1	E	428	Total 6173	C 1916	H 3103	N 550	O 589	S 15	0	0	0
1	F	428	Total 6214	C 1924	H 3131	N 551	O 593	S 15	0	0	0
1	G	426	Total 5871	C 1852	H 2915	N 529	O 560	S 15	0	0	0
1	H	428	Total 6211	C 1923	H 3132	N 551	O 590	S 15	0	0	0
1	I	427	Total 5740	C 1818	H 2829	N 518	O 561	S 14	0	0	0
1	J	428	Total 6056	C 1893	H 3032	N 534	O 582	S 15	0	0	0
1	K	428	Total 6098	C 1903	H 3062	N 536	O 582	S 15	0	0	0
1	L	427	Total 6111	C 1901	H 3073	N 543	O 579	S 15	0	0	0
1	M	428	Total 6137	C 1908	H 3085	N 545	O 584	S 15	0	0	0
1	N	428	Total 6067	C 1893	H 3041	N 536	O 582	S 15	0	0	0
1	O	425	Total 5780	C 1831	H 2850	N 522	O 565	S 12	0	0	0
1	P	428	Total 5922	C 1864	H 2947	N 528	O 568	S 15	0	0	0

There are 48 discrepancies between the modelled and reference sequences:

Chain	Residue	Modelled	Actual	Comment	Reference
A	-2	GLY	-	expression tag	UNP Q9L0I7
A	-1	SER	-	expression tag	UNP Q9L0I7
A	0	HIS	-	expression tag	UNP Q9L0I7
B	-2	GLY	-	expression tag	UNP Q9L0I7
B	-1	SER	-	expression tag	UNP Q9L0I7
B	0	HIS	-	expression tag	UNP Q9L0I7
C	-2	GLY	-	expression tag	UNP Q9L0I7
C	-1	SER	-	expression tag	UNP Q9L0I7
C	0	HIS	-	expression tag	UNP Q9L0I7
D	-2	GLY	-	expression tag	UNP Q9L0I7
D	-1	SER	-	expression tag	UNP Q9L0I7
D	0	HIS	-	expression tag	UNP Q9L0I7
E	-2	GLY	-	expression tag	UNP Q9L0I7
E	-1	SER	-	expression tag	UNP Q9L0I7
E	0	HIS	-	expression tag	UNP Q9L0I7
F	-2	GLY	-	expression tag	UNP Q9L0I7
F	-1	SER	-	expression tag	UNP Q9L0I7
F	0	HIS	-	expression tag	UNP Q9L0I7
G	-2	GLY	-	expression tag	UNP Q9L0I7
G	-1	SER	-	expression tag	UNP Q9L0I7
G	0	HIS	-	expression tag	UNP Q9L0I7
H	-2	GLY	-	expression tag	UNP Q9L0I7
H	-1	SER	-	expression tag	UNP Q9L0I7
H	0	HIS	-	expression tag	UNP Q9L0I7
I	-2	GLY	-	expression tag	UNP Q9L0I7
I	-1	SER	-	expression tag	UNP Q9L0I7
I	0	HIS	-	expression tag	UNP Q9L0I7
J	-2	GLY	-	expression tag	UNP Q9L0I7
J	-1	SER	-	expression tag	UNP Q9L0I7
J	0	HIS	-	expression tag	UNP Q9L0I7
K	-2	GLY	-	expression tag	UNP Q9L0I7
K	-1	SER	-	expression tag	UNP Q9L0I7
K	0	HIS	-	expression tag	UNP Q9L0I7
L	-2	GLY	-	expression tag	UNP Q9L0I7
L	-1	SER	-	expression tag	UNP Q9L0I7
L	0	HIS	-	expression tag	UNP Q9L0I7
M	-2	GLY	-	expression tag	UNP Q9L0I7
M	-1	SER	-	expression tag	UNP Q9L0I7
M	0	HIS	-	expression tag	UNP Q9L0I7
N	-2	GLY	-	expression tag	UNP Q9L0I7
N	-1	SER	-	expression tag	UNP Q9L0I7
N	0	HIS	-	expression tag	UNP Q9L0I7

*Continued on next page...*

Continued from previous page...

Chain	Residue	Modelled	Actual	Comment	Reference
O	-2	GLY	-	expression tag	UNP Q9L0I7
O	-1	SER	-	expression tag	UNP Q9L0I7
O	0	HIS	-	expression tag	UNP Q9L0I7
P	-2	GLY	-	expression tag	UNP Q9L0I7
P	-1	SER	-	expression tag	UNP Q9L0I7
P	0	HIS	-	expression tag	UNP Q9L0I7

- Molecule 2 is ADENOSINE-5'-TRIPHOSPHATE (three-letter code: ATP) (formula:  $C_{10}H_{16}N_5O_{13}P_3$ ) (labeled as "Ligand of Interest" by depositor).

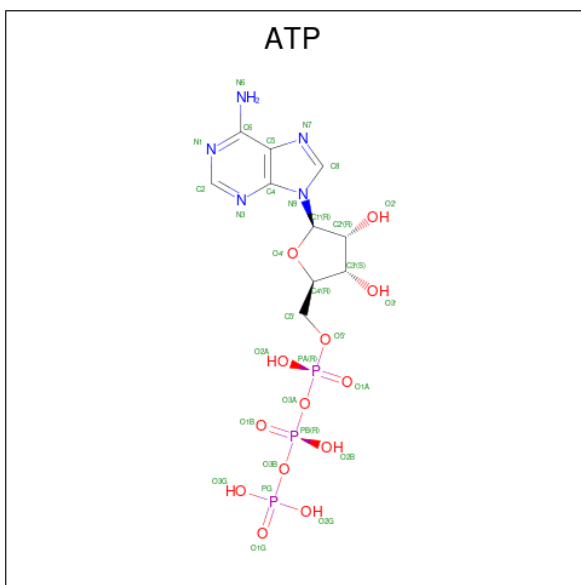

Mol	Chain	Residues	Atoms					ZeroOcc	AltConf	
			Total	C	H	N	O			P
2	A	1	Total	C	H	N	O	P	0	0
			42	10	11	5	13	3		
2	B	1	Total	C	H	N	O	P	0	0
			42	10	11	5	13	3		
2	C	1	Total	C	H	N	O	P	0	0
			42	10	11	5	13	3		
2	D	1	Total	C	H	N	O	P	0	0
			42	10	11	5	13	3		
2	E	1	Total	C	H	N	O	P	0	0
			42	10	11	5	13	3		
2	F	1	Total	C	H	N	O	P	0	0
			42	10	11	5	13	3		
2	G	1	Total	C	H	N	O	P	0	0
			42	10	11	5	13	3		
2	H	1	Total	C	H	N	O	P	0	0
			42	10	11	5	13	3		

Continued on next page...

Continued from previous page...

Mol	Chain	Residues	Atoms					ZeroOcc	AltConf	
2	I	1	Total	C	H	N	O	P	0	0
			42	10	11	5	13	3		
2	J	1	Total	C	H	N	O	P	0	0
			42	10	11	5	13	3		
2	K	1	Total	C	H	N	O	P	0	0
			42	10	11	5	13	3		
2	L	1	Total	C	H	N	O	P	0	0
			42	10	11	5	13	3		
2	M	1	Total	C	H	N	O	P	0	0
			42	10	11	5	13	3		
2	N	1	Total	C	H	N	O	P	0	0
			42	10	11	5	13	3		
2	O	1	Total	C	H	N	O	P	0	0
			42	10	11	5	13	3		
2	P	1	Total	C	H	N	O	P	0	0
			42	10	11	5	13	3		

- Molecule 3 is GUANOSINE-5',3'-TETRAPHOSPHATE (three-letter code: G4P) (formula:  $C_{10}H_{17}N_5O_{17}P_4$ ) (labeled as "Ligand of Interest" by depositor).

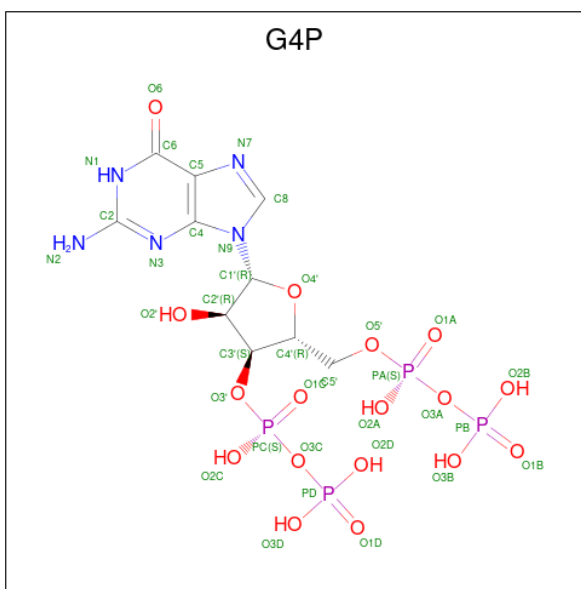

Mol	Chain	Residues	Atoms					ZeroOcc	AltConf	
3	A	1	Total	C	H	N	O	P	0	0
			47	10	11	5	17	4		
3	B	1	Total	C	H	N	O	P	0	0
			47	10	11	5	17	4		
3	C	1	Total	C	H	N	O	P	0	0
			47	10	11	5	17	4		

Continued on next page...

Continued from previous page...

Mol	Chain	Residues	Atoms					ZeroOcc	AltConf	
3	D	1	Total	C	H	N	O	P	0	0
			47	10	11	5	17	4		
3	E	1	Total	C	H	N	O	P	0	0
			47	10	11	5	17	4		
3	F	1	Total	C	H	N	O	P	0	0
			47	10	11	5	17	4		
3	G	1	Total	C	H	N	O	P	0	0
			47	10	11	5	17	4		
3	H	1	Total	C	H	N	O	P	0	0
			47	10	11	5	17	4		
3	I	1	Total	C	H	N	O	P	0	0
			47	10	11	5	17	4		
3	J	1	Total	C	H	N	O	P	0	0
			47	10	11	5	17	4		
3	K	1	Total	C	H	N	O	P	0	0
			47	10	11	5	17	4		
3	L	1	Total	C	H	N	O	P	0	0
			47	10	11	5	17	4		
3	M	1	Total	C	H	N	O	P	0	0
			47	10	11	5	17	4		
3	N	1	Total	C	H	N	O	P	0	0
			47	10	11	5	17	4		
3	O	1	Total	C	H	N	O	P	0	0
			47	10	11	5	17	4		
3	P	1	Total	C	H	N	O	P	0	0
			47	10	11	5	17	4		

- Molecule 4 is MAGNESIUM ION (three-letter code: MG) (formula: Mg) (labeled as "Ligand of Interest" by depositor).

Mol	Chain	Residues	Atoms		ZeroOcc	AltConf
4	A	2	Total	Mg	0	0
			2	2		
4	B	2	Total	Mg	0	0
			2	2		
4	C	2	Total	Mg	0	0
			2	2		
4	D	2	Total	Mg	0	0
			2	2		
4	E	2	Total	Mg	0	0
			2	2		
4	F	2	Total	Mg	0	0
			2	2		

Continued on next page...



*Continued from previous page...*

Mol	Chain	Residues	Atoms		ZeroOcc	AltConf
4	G	2	Total 2	Mg 2	0	0
4	H	2	Total 2	Mg 2	0	0
4	I	2	Total 2	Mg 2	0	0
4	J	2	Total 2	Mg 2	0	0
4	K	2	Total 2	Mg 2	0	0
4	L	2	Total 2	Mg 2	0	0
4	M	2	Total 2	Mg 2	0	0
4	N	2	Total 2	Mg 2	0	0
4	O	2	Total 2	Mg 2	0	0
4	P	2	Total 2	Mg 2	0	0

- Molecule 5 is water.

Mol	Chain	Residues	Atoms		ZeroOcc	AltConf
5	A	264	Total 264	O 264	0	0
5	B	237	Total 237	O 237	0	0
5	C	223	Total 223	O 223	0	0
5	D	240	Total 240	O 240	0	0
5	E	299	Total 299	O 299	0	0
5	F	279	Total 279	O 279	0	0
5	G	192	Total 192	O 192	0	0
5	H	273	Total 273	O 273	0	0
5	I	174	Total 174	O 174	0	0

*Continued on next page...*

*Continued from previous page...*

<b>Mol</b>	<b>Chain</b>	<b>Residues</b>	<b>Atoms</b>		<b>ZeroOcc</b>	<b>AltConf</b>
5	J	192	Total 192	O 192	0	0
5	K	245	Total 245	O 245	0	0
5	L	238	Total 238	O 238	0	0
5	M	222	Total 222	O 222	0	0
5	N	172	Total 172	O 172	0	0
5	O	153	Total 153	O 153	0	0
5	P	152	Total 152	O 152	0	0

### 3 Residue-property plots [i](#)

These plots are drawn for all protein, RNA, DNA and oligosaccharide chains in the entry. The first graphic for a chain summarises the proportions of the various outlier classes displayed in the second graphic. The second graphic shows the sequence view annotated by issues in geometry and electron density. Residues are color-coded according to the number of geometric quality criteria for which they contain at least one outlier: green = 0, yellow = 1, orange = 2 and red = 3 or more. A red dot above a residue indicates a poor fit to the electron density ( $RSRZ > 2$ ). Stretches of 2 or more consecutive residues without any outlier are shown as a green connector. Residues present in the sample, but not in the model, are shown in grey.

- Molecule 1: Inosine-5'-monophosphate dehydrogenase

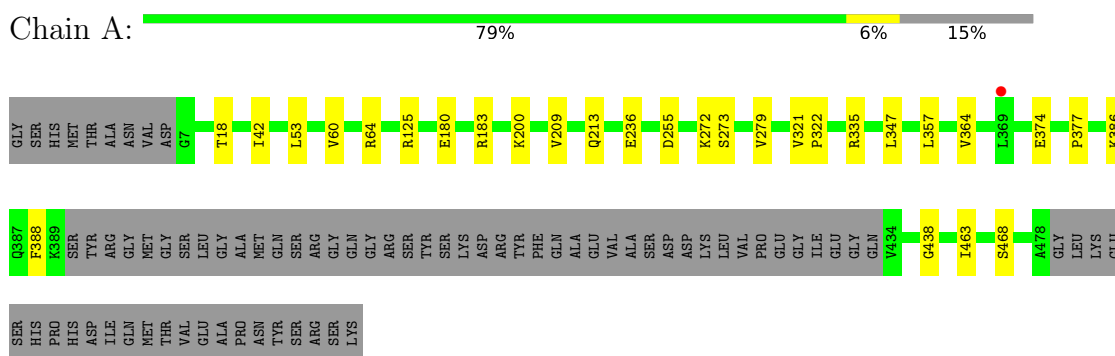

- Molecule 1: Inosine-5'-monophosphate dehydrogenase

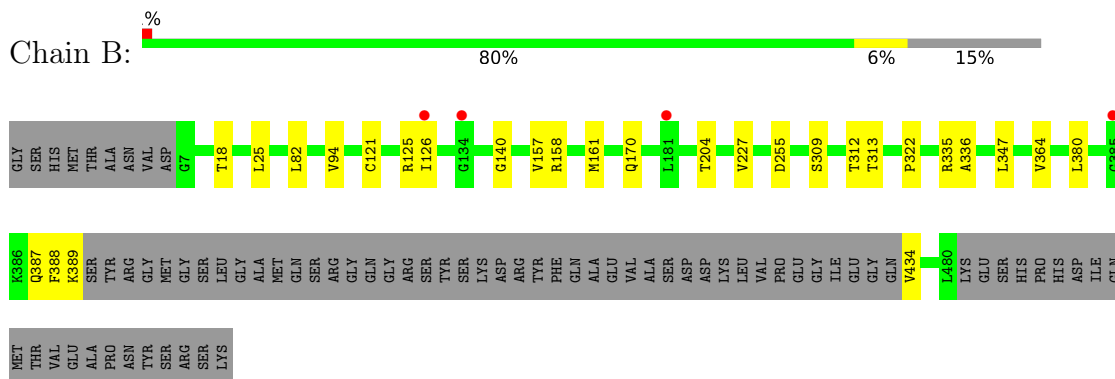

- Molecule 1: Inosine-5'-monophosphate dehydrogenase

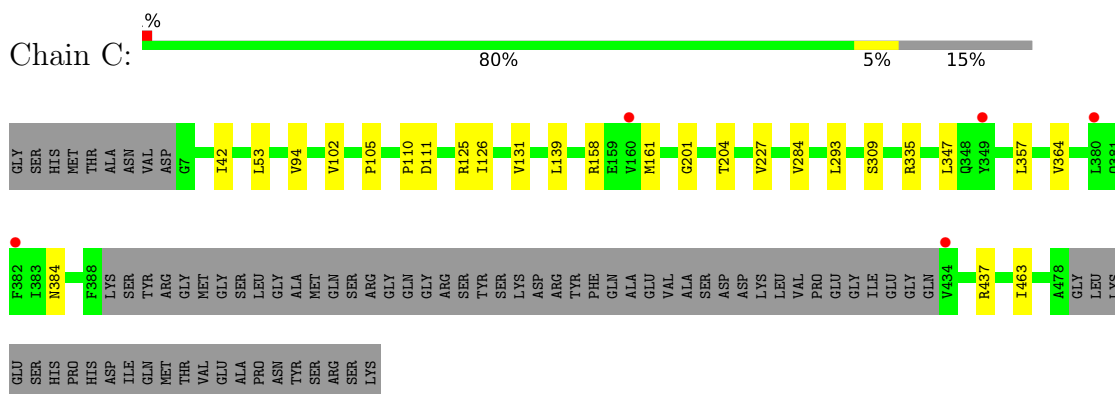



- Molecule 1: Inosine-5'-monophosphate dehydrogenase

Chain H: 82% 15%

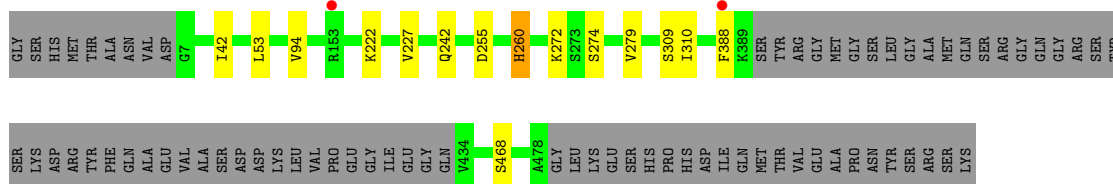

- Molecule 1: Inosine-5'-monophosphate dehydrogenase

Chain I: 80% 15%

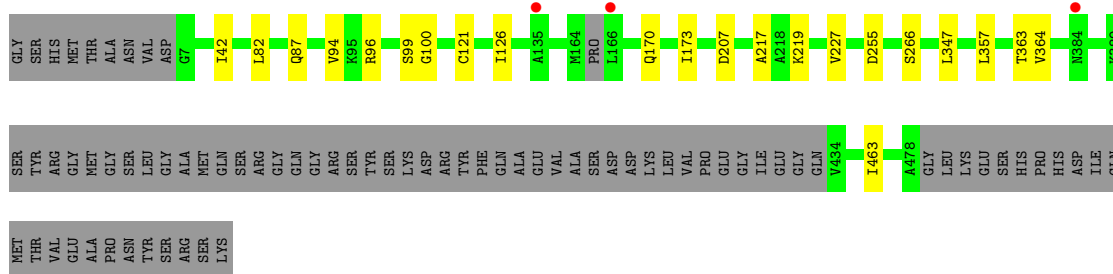

- Molecule 1: Inosine-5'-monophosphate dehydrogenase

Chain J: 82% 15%

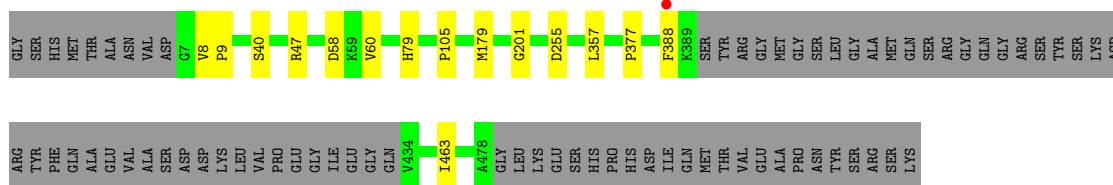

- Molecule 1: Inosine-5'-monophosphate dehydrogenase

Chain K: 82% 15%

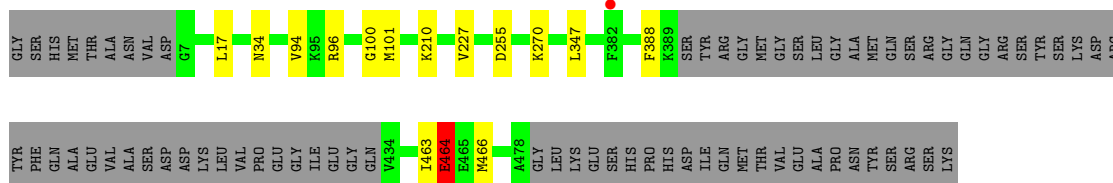

- Molecule 1: Inosine-5'-monophosphate dehydrogenase

Chain L: 79% 6% 15%

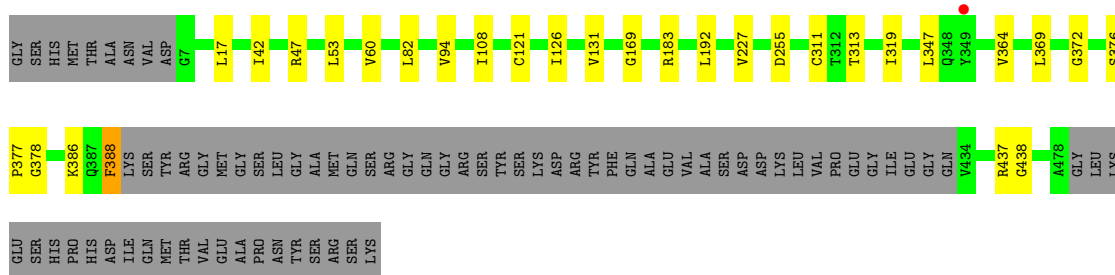

• Molecule 1: Inosine-5'-monophosphate dehydrogenase

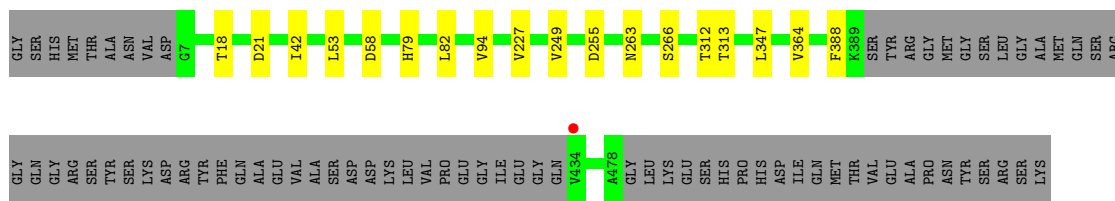
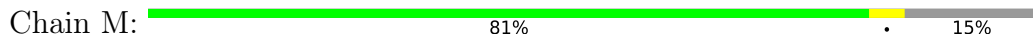

• Molecule 1: Inosine-5'-monophosphate dehydrogenase

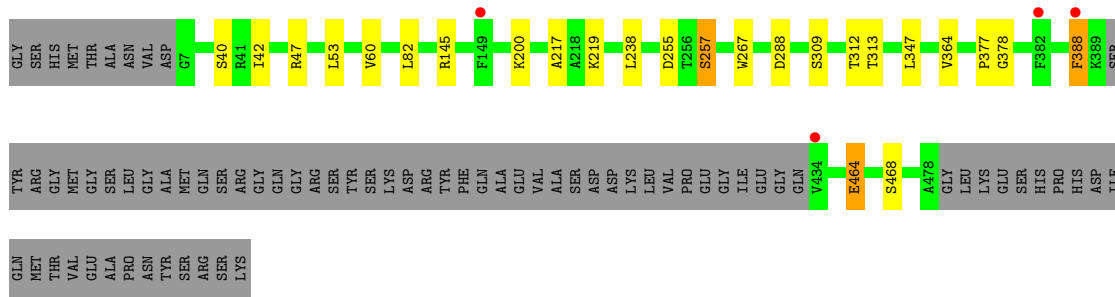
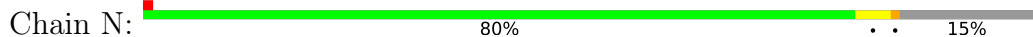

• Molecule 1: Inosine-5'-monophosphate dehydrogenase

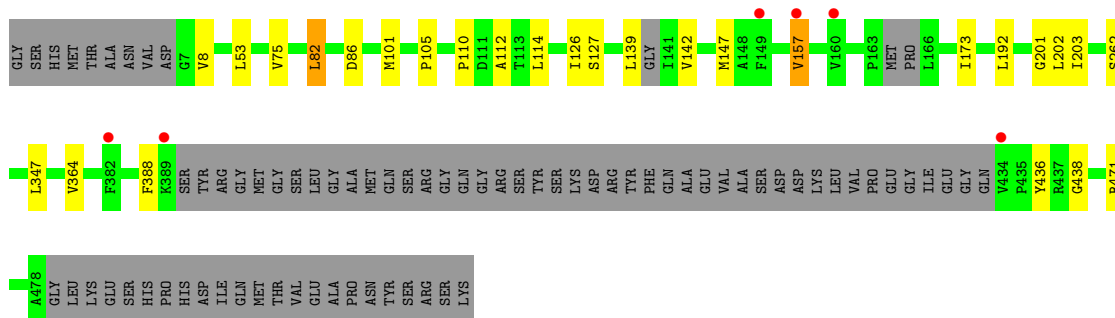
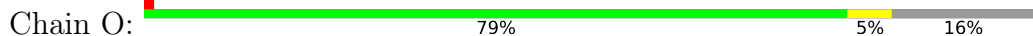

• Molecule 1: Inosine-5'-monophosphate dehydrogenase

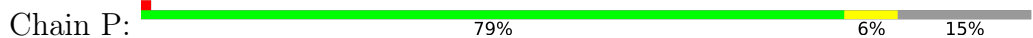

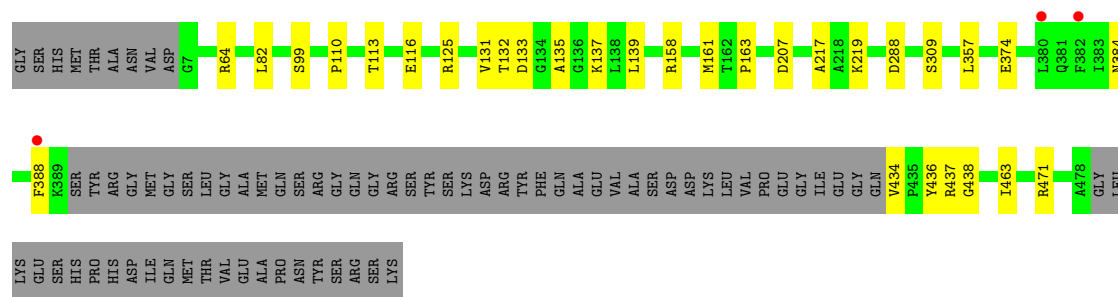

## 4 Data and refinement statistics

Property	Value	Source
Space group	P 1 21 1	Depositor
Cell constants a, b, c, $\alpha$ , $\beta$ , $\gamma$	119.29Å 300.90Å 123.09Å 90.00° 90.28° 90.00°	Depositor
Resolution (Å)	85.88 – 2.03 150.45 – 2.03	Depositor EDS
% Data completeness (in resolution range)	84.9 (85.88-2.03) 84.9 (150.45-2.03)	Depositor EDS
$R_{merge}$	0.10	Depositor
$R_{sym}$	(Not available)	Depositor
$\langle I/\sigma(I) \rangle$ <sup>1</sup>	1.72 (at 2.03Å)	Xtrriage
Refinement program	PHENIX 1.19.2_4158	Depositor
R, $R_{free}$	0.180 , 0.212 0.180 , 0.210	Depositor DCC
$R_{free}$ test set	23525 reflections (4.96%)	wwPDB-VP
Wilson B-factor (Å <sup>2</sup> )	32.0	Xtrriage
Anisotropy	0.014	Xtrriage
Bulk solvent $k_{sol}$ (e/Å <sup>3</sup> ), $B_{sol}$ (Å <sup>2</sup> )	(Not available) , (Not available)	EDS
L-test for twinning <sup>2</sup>	$\langle  L  \rangle = 0.49$ , $\langle L^2 \rangle = 0.32$	Xtrriage
Estimated twinning fraction	0.003 for l,k,-h 0.137 for h,-k,-l 0.015 for l,-k,h	Xtrriage
$F_o, F_c$ correlation	0.95	EDS
Total number of atoms	101645	wwPDB-VP
Average B, all atoms (Å <sup>2</sup> )	42.0	wwPDB-VP

Xtrriage's analysis on translational NCS is as follows: *The largest off-origin peak in the Patterson function is 2.02% of the height of the origin peak. No significant pseudotranslation is detected.*

<sup>1</sup>Intensities estimated from amplitudes.

<sup>2</sup>Theoretical values of  $\langle |L| \rangle$ ,  $\langle L^2 \rangle$  for acentric reflections are 0.5, 0.333 respectively for untwinned datasets, and 0.375, 0.2 for perfectly twinned datasets.



## 5 Model quality

### 5.1 Standard geometry

Bond lengths and bond angles in the following residue types are not validated in this section: ATP, MG, G4P

The Z score for a bond length (or angle) is the number of standard deviations the observed value is removed from the expected value. A bond length (or angle) with  $|Z| > 5$  is considered an outlier worth inspection. RMSZ is the root-mean-square of all Z scores of the bond lengths (or angles).

Mol	Chain	Bond lengths		Bond angles	
		RMSZ	# Z  >5	RMSZ	# Z  >5
1	A	0.26	0/3094	0.54	0/4196
1	B	0.32	0/3072	0.55	0/4173
1	C	0.34	0/3014	0.56	0/4099
1	D	0.30	0/3078	0.54	0/4177
1	E	0.28	0/3109	0.56	0/4216
1	F	0.32	0/3122	0.56	0/4232
1	G	0.32	0/2993	0.55	0/4067
1	H	0.32	0/3118	0.59	1/4226 (0.0%)
1	I	0.37	0/2944	0.59	0/4007
1	J	0.29	0/3062	0.54	0/4158
1	K	0.34	0/3074	0.56	1/4173 (0.0%)
1	L	0.34	0/3076	0.56	0/4173
1	M	0.28	0/3091	0.54	0/4193
1	N	0.33	0/3064	0.57	1/4161 (0.0%)
1	O	0.34	0/2965	0.55	0/4033
1	P	0.39	0/3013	0.57	0/4100
All	All	0.32	0/48889	0.56	3/66384 (0.0%)

There are no bond length outliers.

All (3) bond angle outliers are listed below:

Mol	Chain	Res	Type	Atoms	Z	Observed(°)	Ideal(°)
1	N	257	SER	CB-CA-C	6.93	123.27	110.10
1	H	222	LYS	CA-CB-CG	6.15	126.93	113.40
1	K	464	GLU	CG-CD-OE2	-6.14	106.02	118.30

There are no chirality outliers.

There are no planarity outliers.

## 5.2 Too-close contacts

In the following table, the Non-H and H(model) columns list the number of non-hydrogen atoms and hydrogen atoms in the chain respectively. The H(added) column lists the number of hydrogen atoms added and optimized by MolProbity. The Clashes column lists the number of clashes within the asymmetric unit, whereas Symm-Clashes lists symmetry-related clashes.

Mol	Chain	Non-H	H(model)	H(added)	Clashes	Symm-Clashes
1	A	3056	3101	3101	18	0
1	B	3033	3025	3025	28	0
1	C	2978	2959	2959	19	0
1	D	3040	3062	3062	16	0
1	E	3070	3103	3103	16	0
1	F	3083	3131	3131	12	0
1	G	2956	2915	2915	14	0
1	H	3079	3132	3132	7	0
1	I	2911	2829	2829	13	0
1	J	3024	3032	3032	9	0
1	K	3036	3062	3062	8	0
1	L	3038	3073	3071	23	0
1	M	3052	3085	3085	9	0
1	N	3026	3041	3041	13	0
1	O	2930	2850	2849	22	0
1	P	2975	2947	2947	18	0
2	A	31	11	12	0	0
2	B	31	11	12	0	0
2	C	31	11	12	0	0
2	D	31	11	12	0	0
2	E	31	11	12	0	0
2	F	31	11	12	0	0
2	G	31	11	12	1	0
2	H	31	11	12	0	0
2	I	31	11	12	0	0
2	J	31	11	12	0	0
2	K	31	11	12	0	0
2	L	31	11	12	0	0
2	M	31	11	12	0	0
2	N	31	11	12	1	0
2	O	31	11	12	0	0
2	P	31	11	12	0	0
3	A	36	11	11	1	0
3	B	36	11	11	3	0
3	C	36	11	11	1	0
3	D	36	11	11	2	0
3	E	36	11	11	1	0

*Continued on next page...*

*Continued from previous page...*

Mol	Chain	Non-H	H(model)	H(added)	Clashes	Symm-Clashes
3	F	36	11	11	1	0
3	G	36	11	11	1	0
3	H	36	11	11	1	0
3	I	36	11	11	0	0
3	J	36	11	11	0	0
3	K	36	11	11	0	0
3	L	36	11	11	0	0
3	M	36	11	11	0	0
3	N	36	11	11	0	0
3	O	36	11	11	1	0
3	P	36	11	11	1	0
4	A	2	0	0	0	0
4	B	2	0	0	0	0
4	C	2	0	0	0	0
4	D	2	0	0	0	0
4	E	2	0	0	0	0
4	F	2	0	0	0	0
4	G	2	0	0	0	0
4	H	2	0	0	0	0
4	I	2	0	0	0	0
4	J	2	0	0	0	0
4	K	2	0	0	0	0
4	L	2	0	0	0	0
4	M	2	0	0	0	0
4	N	2	0	0	0	0
4	O	2	0	0	0	0
4	P	2	0	0	0	0
5	A	264	0	0	0	0
5	B	237	0	0	4	0
5	C	223	0	0	1	0
5	D	240	0	0	1	0
5	E	299	0	0	3	0
5	F	279	0	0	1	0
5	G	192	0	0	1	0
5	H	273	0	0	2	0
5	I	174	0	0	0	0
5	J	192	0	0	0	0
5	K	245	0	0	2	0
5	L	238	0	0	1	0
5	M	222	0	0	1	0
5	N	172	0	0	1	0
5	O	153	0	0	0	0

*Continued on next page...*

*Continued from previous page...*

Mol	Chain	Non-H	H(model)	H(added)	Clashes	Symm-Clashes
5	P	152	0	0	0	0
All	All	52946	48699	48712	233	0

The all-atom clashscore is defined as the number of clashes found per 1000 atoms (including hydrogen atoms). The all-atom clashscore for this structure is 2.

All (233) close contacts within the same asymmetric unit are listed below, sorted by their clash magnitude.

Atom-1	Atom-2	Interatomic distance (Å)	Clash overlap (Å)
3:H:601:G4P:O4'	3:H:601:G4P:C1'	1.63	1.18
3:O:601:G4P:O4'	3:O:601:G4P:C1'	1.64	1.16
1:B:125:ARG:NH1	3:B:601:G4P:O3B	2.01	0.94
1:O:101:MET:HE1	1:O:126:ILE:HD12	1.53	0.88
1:E:111:ASP:OD1	1:E:158:ARG:NH1	2.07	0.88
1:A:386:LYS:HE2	1:L:438:GLY:HA3	1.56	0.88
3:B:601:G4P:O1C	5:B:701:HOH:O	1.95	0.83
1:B:126:ILE:HD11	1:B:204:THR:HG21	1.59	0.82
1:N:464:GLU:OE1	5:N:701:HOH:O	1.97	0.81
1:M:263:ASN:ND2	5:M:701:HOH:O	2.13	0.80
1:K:34:ASN:ND2	5:K:701:HOH:O	2.17	0.78
1:G:125:ARG:NH1	3:G:601:G4P:O3B	2.18	0.77
1:B:335:ARG:HE	1:D:273:SER:HB2	1.52	0.75
1:B:126:ILE:CD1	1:B:204:THR:HG21	2.15	0.75
1:B:389:LYS:O	5:B:702:HOH:O	2.05	0.74
1:E:438:GLY:HA3	1:F:386:LYS:HE3	1.70	0.74
1:H:260:HIS:HD2	5:H:750:HOH:O	1.69	0.74
1:K:464:GLU:O	1:K:464:GLU:HG3	1.88	0.73
1:D:133:ASP:OD1	1:D:135:ALA:N	2.21	0.70
1:D:133:ASP:OD2	1:D:137:LYS:HE2	1.92	0.70
1:B:126:ILE:HD11	1:B:204:THR:CG2	2.21	0.70
1:P:99:SER:N	1:P:207:ASP:OD1	2.23	0.69
1:J:8:VAL:HG21	1:L:17:LEU:HD11	1.74	0.69
1:E:186:LYS:NZ	5:E:703:HOH:O	2.25	0.68
1:E:273:SER:OG	5:E:701:HOH:O	2.11	0.68
1:B:347:LEU:HD11	1:B:364:VAL:HG11	1.75	0.68
1:A:180:GLU:OE2	1:A:183:ARG:NH2	2.26	0.68
1:P:131:VAL:HG11	1:P:161:MET:HE1	1.76	0.67
1:P:110:PRO:HG3	1:P:139:LEU:HD22	1.76	0.66
1:F:310:ILE:HG22	1:F:310:ILE:O	1.95	0.66
1:A:386:LYS:HE2	1:L:438:GLY:CA	2.25	0.66
1:O:82:LEU:HD12	1:O:86:ASP:CB	2.26	0.65

*Continued on next page...*

*Continued from previous page...*

Atom-1	Atom-2	Interatomic distance (Å)	Clash overlap (Å)
1:L:311:CYS:SG	5:L:755:HOH:O	2.49	0.65
1:D:347:LEU:HD11	1:D:364:VAL:HG11	1.79	0.65
1:B:140:GLY:HA3	1:B:161:MET:CE	2.27	0.64
1:L:347:LEU:HD11	1:L:364:VAL:HG11	1.79	0.64
1:O:173:ILE:HD11	1:O:203:ILE:HD12	1.80	0.63
1:P:131:VAL:HG11	1:P:161:MET:CE	2.29	0.62
3:D:601:G4P:O1A	5:D:701:HOH:O	2.16	0.61
1:O:114:LEU:HD13	1:O:147:MET:HG2	1.82	0.61
1:A:64:ARG:NH2	1:A:374:GLU:OE1	2.34	0.60
1:K:210:LYS:NZ	5:K:703:HOH:O	2.29	0.60
1:N:145:ARG:HB2	2:N:600:ATP:O1B	2.02	0.59
1:O:112:ALA:O	1:O:157:VAL:HG22	2.03	0.58
1:E:10:GLU:HG3	1:E:10:GLU:O	2.04	0.58
1:G:140:GLY:HA3	1:G:161:MET:HE3	1.86	0.58
1:O:82:LEU:HD12	1:O:86:ASP:HB3	1.84	0.58
1:L:347:LEU:HD11	1:L:364:VAL:CG1	2.34	0.58
1:B:140:GLY:HA3	1:B:161:MET:HE3	1.85	0.57
1:D:125:ARG:NH2	3:D:601:G4P:O2A	2.38	0.57
1:O:105:PRO:HG3	1:O:201:GLY:HA2	1.86	0.57
1:N:347:LEU:HD11	1:N:364:VAL:HG11	1.88	0.56
1:K:17:LEU:HD11	1:O:8:VAL:HG21	1.86	0.56
1:M:347:LEU:HD11	1:M:364:VAL:HG11	1.87	0.56
1:O:347:LEU:HD11	1:O:364:VAL:HG11	1.88	0.55
1:I:347:LEU:HD11	1:I:364:VAL:HG11	1.89	0.55
1:O:347:LEU:HD11	1:O:364:VAL:CG1	2.36	0.55
1:A:42:ILE:HD12	1:A:53:LEU:HD21	1.88	0.55
1:O:110:PRO:HG3	1:O:139:LEU:HD12	1.89	0.55
1:D:347:LEU:HD11	1:D:364:VAL:CG1	2.37	0.54
1:I:82:LEU:HD11	1:I:87:GLN:HB2	1.90	0.54
1:N:347:LEU:HD11	1:N:364:VAL:CG1	2.37	0.54
1:L:183:ARG:HG2	1:L:183:ARG:HH11	1.71	0.54
1:E:438:GLY:CA	1:F:386:LYS:HE3	2.36	0.54
1:L:42:ILE:HD12	1:L:53:LEU:HD21	1.89	0.54
1:O:105:PRO:HG3	1:O:201:GLY:CA	2.39	0.53
1:B:347:LEU:HD11	1:B:364:VAL:CG1	2.37	0.53
1:G:140:GLY:HA3	1:G:161:MET:CE	2.38	0.53
1:E:109:HIS:CG	1:E:110:PRO:HD2	2.45	0.52
1:I:217:ALA:HB3	1:I:219:LYS:HE3	1.92	0.51
1:N:42:ILE:HD12	1:N:53:LEU:HD21	1.92	0.51
1:G:157:VAL:O	1:G:161:MET:HG2	2.10	0.51
1:N:238:LEU:HD12	1:N:267:TRP:HZ3	1.75	0.51

*Continued on next page...*

*Continued from previous page...*

Atom-1	Atom-2	Interatomic distance (Å)	Clash overlap (Å)
1:D:312:THR:HG23	1:D:313:THR:N	2.25	0.51
1:P:217:ALA:HB3	1:P:219:LYS:HE3	1.93	0.51
1:A:347:LEU:HD11	1:A:364:VAL:HG11	1.92	0.51
1:L:369:LEU:HG	1:L:437:ARG:NH1	2.25	0.51
1:N:312:THR:HG23	1:N:313:THR:N	2.26	0.51
1:M:94:VAL:HG11	1:M:227:VAL:HB	1.93	0.51
1:L:369:LEU:HG	1:L:437:ARG:HH12	1.75	0.51
1:B:312:THR:HG23	1:B:313:THR:N	2.26	0.51
1:C:131:VAL:HG11	1:C:161:MET:HE1	1.94	0.50
1:M:42:ILE:HD12	1:M:53:LEU:HD21	1.93	0.50
1:B:94:VAL:HG11	1:B:227:VAL:HB	1.94	0.50
1:F:42:ILE:HD12	1:F:53:LEU:HD21	1.93	0.50
1:I:96:ARG:HA	1:I:100:GLY:HA3	1.93	0.50
1:C:94:VAL:HG11	1:C:227:VAL:HB	1.92	0.50
1:N:217:ALA:HB3	1:N:219:LYS:HE3	1.93	0.50
1:P:137:LYS:O	1:P:139:LEU:HD12	2.11	0.50
1:E:125:ARG:NH2	3:E:601:G4P:O2A	2.45	0.50
1:C:125:ARG:NH2	3:C:601:G4P:O2A	2.45	0.49
1:F:57:MET:HE2	1:F:60:VAL:HG23	1.94	0.49
1:H:309:SER:O	1:H:310:ILE:C	2.50	0.49
1:L:183:ARG:HG2	1:L:183:ARG:NH1	2.28	0.49
1:B:158:ARG:HA	1:B:161:MET:SD	2.53	0.49
1:O:101:MET:HE3	1:O:202:LEU:HD23	1.94	0.49
1:P:133:ASP:OD1	1:P:135:ALA:N	2.29	0.49
1:P:64:ARG:NH2	1:P:374:GLU:OE2	2.46	0.48
1:I:94:VAL:HG11	1:I:227:VAL:HB	1.95	0.48
1:O:436:TYR:CZ	1:O:438:GLY:HA2	2.48	0.48
1:F:347:LEU:HD11	1:F:364:VAL:CG1	2.43	0.48
1:O:110:PRO:O	1:O:157:VAL:HG23	2.13	0.48
1:P:161:MET:O	1:P:163:PRO:HD3	2.13	0.48
1:A:18:THR:HG22	1:A:322:PRO:HB3	1.95	0.48
1:O:142:VAL:HG13	1:O:142:VAL:O	2.13	0.48
1:C:110:PRO:HG3	1:C:139:LEU:HD12	1.95	0.48
1:M:312:THR:CG2	1:M:313:THR:N	2.77	0.48
1:A:386:LYS:CE	1:L:438:GLY:HA3	2.37	0.47
1:I:82:LEU:CD1	1:I:87:GLN:HB2	2.43	0.47
1:A:347:LEU:HD11	1:A:364:VAL:CG1	2.44	0.47
1:G:49:ASN:OD1	5:G:701:HOH:O	2.20	0.47
1:B:18:THR:HG22	1:B:322:PRO:HB3	1.95	0.47
1:B:170:GLN:CD	1:B:170:GLN:H	2.18	0.47
1:C:347:LEU:HD11	1:C:364:VAL:CG1	2.44	0.47

*Continued on next page...*

*Continued from previous page...*

Atom-1	Atom-2	Interatomic distance (Å)	Clash overlap (Å)
1:K:96:ARG:HA	1:K:100:GLY:HA3	1.96	0.47
1:M:312:THR:HG23	1:M:313:THR:N	2.29	0.47
1:M:347:LEU:HD11	1:M:364:VAL:CG1	2.45	0.47
1:E:288:ASP:OD1	5:E:702:HOH:O	2.20	0.47
1:P:132:THR:HA	1:P:139:LEU:HD13	1.97	0.46
1:D:133:ASP:OD1	1:D:133:ASP:C	2.52	0.46
1:G:94:VAL:HG11	1:G:227:VAL:HB	1.96	0.46
1:H:42:ILE:HD12	1:H:53:LEU:HD21	1.96	0.46
1:P:139:LEU:HD12	1:P:139:LEU:N	2.30	0.46
1:I:170:GLN:O	1:I:173:ILE:HG22	2.16	0.46
1:L:94:VAL:HG11	1:L:227:VAL:HB	1.97	0.46
1:A:272:LYS:HA	1:A:279:VAL:HG21	1.97	0.46
1:B:336:ALA:HB1	1:D:270:LYS:HD3	1.97	0.46
1:D:357:LEU:HD13	1:D:463:ILE:HD12	1.98	0.46
1:H:272:LYS:HA	1:H:279:VAL:HG21	1.97	0.46
1:K:94:VAL:HG11	1:K:227:VAL:HB	1.98	0.46
1:J:8:VAL:HG22	1:J:9:PRO:HD2	1.98	0.46
1:A:125:ARG:NH2	3:A:601:G4P:O2A	2.48	0.46
1:G:170:GLN:OE1	1:G:170:GLN:N	2.44	0.46
1:L:108:ILE:O	1:L:131:VAL:HA	2.16	0.46
1:C:105:PRO:HG3	1:C:201:GLY:HA2	1.96	0.46
1:D:94:VAL:HG11	1:D:227:VAL:HB	1.98	0.46
1:E:110:PRO:HA	1:E:157:VAL:HG23	1.97	0.46
1:B:121:CYS:HB3	1:B:126:ILE:O	2.16	0.45
1:P:158:ARG:HA	1:P:161:MET:HE3	1.98	0.45
1:D:42:ILE:HD12	1:D:53:LEU:HD21	1.98	0.45
1:N:40:SER:O	1:N:47:ARG:HG3	2.17	0.45
1:D:380:LEU:HD11	1:D:386:LYS:HE3	1.98	0.45
1:L:376:SER:OG	1:L:388:PHE:CE2	2.63	0.45
1:P:437:ARG:HE	1:P:437:ARG:HB3	1.66	0.45
1:I:347:LEU:HD11	1:I:364:VAL:CG1	2.46	0.45
1:F:18:THR:HG22	1:F:21:ASP:OD2	2.17	0.45
1:E:25:LEU:HD23	1:G:321:VAL:HG22	1.99	0.45
1:I:82:LEU:HD11	1:I:87:GLN:CB	2.47	0.44
1:L:378:GLY:O	1:L:388:PHE:CE2	2.71	0.44
1:P:113:THR:OG1	1:P:116:GLU:HG3	2.17	0.44
1:B:312:THR:CG2	1:B:313:THR:N	2.81	0.44
1:A:321:VAL:HG22	1:G:25:LEU:CD2	2.47	0.44
1:C:284:VAL:HG13	1:C:293:LEU:HD11	1.99	0.44
1:J:105:PRO:HG3	1:J:201:GLY:HA2	2.00	0.44
1:P:357:LEU:HD13	1:P:463:ILE:HD12	1.99	0.44

*Continued on next page...*

*Continued from previous page...*

Atom-1	Atom-2	Interatomic distance (Å)	Clash overlap (Å)
1:B:126:ILE:HD11	1:B:204:THR:OG1	2.18	0.44
1:B:157:VAL:O	1:B:161:MET:HG2	2.18	0.44
1:F:209:VAL:O	1:F:213:GLN:HG3	2.17	0.44
1:E:109:HIS:CD2	1:E:110:PRO:HD2	2.52	0.44
1:H:94:VAL:HG11	1:H:227:VAL:HB	1.99	0.44
1:H:242:GLN:NE2	1:H:274:SER:O	2.47	0.44
1:H:468:SER:OG	5:H:701:HOH:O	2.21	0.44
1:O:82:LEU:HD12	1:O:86:ASP:HB2	1.99	0.44
1:O:110:PRO:HG3	1:O:139:LEU:CD1	2.47	0.44
1:O:82:LEU:CD1	1:O:86:ASP:HB3	2.48	0.44
1:C:437:ARG:HE	1:C:437:ARG:HB3	1.68	0.44
1:O:126:ILE:HG12	1:O:127:SER:N	2.33	0.44
1:B:25:LEU:CD2	1:E:321:VAL:HG22	2.48	0.43
1:B:336:ALA:HB1	1:D:270:LYS:CD	2.48	0.43
1:C:131:VAL:HG11	1:C:161:MET:CE	2.48	0.43
1:F:94:VAL:HG11	1:F:227:VAL:HB	1.99	0.43
1:E:96:ARG:HA	1:E:100:GLY:HA3	2.00	0.43
1:C:111:ASP:OD1	1:C:111:ASP:N	2.47	0.43
1:C:126:ILE:HD12	5:C:701:HOH:O	2.18	0.43
3:B:601:G4P:PC	5:B:701:HOH:O	2.72	0.43
1:B:380:LEU:HD12	1:B:387:GLN:O	2.19	0.43
1:F:7:GLY:N	5:F:717:HOH:O	2.51	0.43
1:C:42:ILE:HD12	1:C:53:LEU:HD21	2.01	0.43
1:A:357:LEU:HD13	1:A:463:ILE:HD12	2.01	0.42
1:I:99:SER:N	1:I:207:ASP:OD1	2.39	0.42
1:J:105:PRO:HG3	1:J:201:GLY:CA	2.49	0.42
1:J:40:SER:O	1:J:47:ARG:HG3	2.18	0.42
1:O:173:ILE:HD11	1:O:192:LEU:HD21	2.00	0.42
1:C:102:VAL:O	1:C:201:GLY:HA3	2.19	0.42
1:G:68:SER:OG	1:G:375:GLU:HG2	2.20	0.42
1:N:378:GLY:O	1:N:388:PHE:HE1	2.02	0.42
1:C:357:LEU:HD13	1:C:463:ILE:HD12	2.02	0.42
1:M:18:THR:HG22	1:M:21:ASP:OD2	2.20	0.42
1:G:149:PHE:CE1	1:J:179:MET:HG3	2.55	0.42
1:E:25:LEU:CD2	1:G:321:VAL:HG22	2.50	0.41
1:I:357:LEU:HD13	1:I:463:ILE:HD12	2.02	0.41
1:J:357:LEU:HD13	1:J:463:ILE:HD12	2.02	0.41
1:I:42:ILE:HD13	1:I:363:THR:HG21	2.02	0.41
1:J:60:VAL:O	1:J:377:PRO:HD3	2.21	0.41
1:P:158:ARG:HA	1:P:161:MET:HG2	2.02	0.41
1:A:200:LYS:HA	1:A:200:LYS:HD2	1.87	0.41

*Continued on next page...*



Continued from previous page...

Atom-1	Atom-2	Interatomic distance (Å)	Clash overlap (Å)
1:B:434:VAL:N	5:B:718:HOH:O	2.53	0.41
1:E:272:LYS:HA	1:E:279:VAL:HG21	2.03	0.41
1:A:438:GLY:HA3	1:L:386:LYS:HE2	2.03	0.41
1:D:272:LYS:HA	1:D:279:VAL:HG21	2.02	0.41
1:F:125:ARG:HD3	3:F:601:G4P:O3B	2.20	0.41
1:I:121:CYS:HB3	1:I:126:ILE:O	2.20	0.41
1:M:58:ASP:HA	1:M:79:HIS:CD2	2.56	0.41
1:C:347:LEU:HD11	1:C:364:VAL:HG11	2.02	0.41
1:G:161:MET:O	1:G:163:PRO:HD3	2.21	0.41
1:N:200:LYS:HA	1:N:200:LYS:HD2	1.91	0.41
1:B:170:GLN:OE1	1:B:170:GLN:N	2.53	0.41
1:L:372:GLY:HA3	1:L:437:ARG:HG3	2.02	0.41
1:B:121:CYS:CB	1:B:126:ILE:O	2.69	0.41
1:B:126:ILE:HD13	1:B:204:THR:HG21	1.97	0.41
1:C:158:ARG:HA	1:C:161:MET:HG2	2.03	0.41
1:G:146:ASP:OD1	2:G:600:ATP:O3'	2.34	0.41
1:K:270:LYS:HA	1:K:270:LYS:HD2	1.89	0.41
1:N:238:LEU:HD12	1:N:267:TRP:CZ3	2.54	0.41
1:A:209:VAL:O	1:A:213:GLN:HG3	2.21	0.41
1:A:273:SER:HB2	1:C:335:ARG:HE	1.85	0.41
1:B:158:ARG:HA	1:B:161:MET:HG2	2.03	0.41
1:C:105:PRO:HG3	1:C:201:GLY:CA	2.50	0.41
1:F:434:VAL:HA	1:F:435:PRO:HD3	1.95	0.41
1:N:60:VAL:O	1:N:377:PRO:HD3	2.21	0.41
1:C:126:ILE:HD11	1:C:204:THR:HG21	2.03	0.41
1:D:200:LYS:HA	1:D:200:LYS:HD2	1.85	0.41
1:L:60:VAL:O	1:L:377:PRO:HD3	2.21	0.41
1:O:53:LEU:HA	1:O:75:VAL:O	2.21	0.41
1:A:60:VAL:O	1:A:377:PRO:HD3	2.21	0.40
1:J:58:ASP:HA	1:J:79:HIS:CD2	2.56	0.40
1:P:436:TYR:CZ	1:P:438:GLY:HA2	2.56	0.40
1:L:121:CYS:HB3	1:L:126:ILE:O	2.22	0.40
1:L:369:LEU:C	1:L:369:LEU:HD23	2.42	0.40
1:K:463:ILE:O	1:K:466:MET:HB2	2.21	0.40
1:L:169:GLY:O	1:L:192:LEU:HA	2.22	0.40
1:L:313:THR:HG22	1:L:319:ILE:HB	2.02	0.40
1:P:125:ARG:HD3	3:P:601:G4P:O3B	2.22	0.40

There are no symmetry-related clashes.

## 5.3 Torsion angles [i](#)

### 5.3.1 Protein backbone [i](#)

In the following table, the Percentiles column shows the percent Ramachandran outliers of the chain as a percentile score with respect to all X-ray entries followed by that with respect to entries of similar resolution.

The Analysed column shows the number of residues for which the backbone conformation was analysed, and the total number of residues.

Mol	Chain	Analysed	Favoured	Allowed	Outliers	Percentiles	
1	A	424/504 (84%)	415 (98%)	9 (2%)	0	100	100
1	B	426/504 (84%)	418 (98%)	8 (2%)	0	100	100
1	C	423/504 (84%)	413 (98%)	9 (2%)	1 (0%)	47	43
1	D	424/504 (84%)	415 (98%)	9 (2%)	0	100	100
1	E	424/504 (84%)	415 (98%)	9 (2%)	0	100	100
1	F	424/504 (84%)	414 (98%)	10 (2%)	0	100	100
1	G	420/504 (83%)	412 (98%)	8 (2%)	0	100	100
1	H	424/504 (84%)	416 (98%)	8 (2%)	0	100	100
1	I	421/504 (84%)	413 (98%)	8 (2%)	0	100	100
1	J	424/504 (84%)	415 (98%)	9 (2%)	0	100	100
1	K	424/504 (84%)	416 (98%)	8 (2%)	0	100	100
1	L	423/504 (84%)	414 (98%)	9 (2%)	0	100	100
1	M	424/504 (84%)	415 (98%)	9 (2%)	0	100	100
1	N	424/504 (84%)	416 (98%)	8 (2%)	0	100	100
1	O	417/504 (83%)	405 (97%)	12 (3%)	0	100	100
1	P	424/504 (84%)	415 (98%)	8 (2%)	1 (0%)	47	43
All	All	6770/8064 (84%)	6627 (98%)	141 (2%)	2 (0%)	100	100

All (2) Ramachandran outliers are listed below:

Mol	Chain	Res	Type
1	P	384	ASN
1	C	384	ASN

### 5.3.2 Protein sidechains [i](#)

In the following table, the Percentiles column shows the percent sidechain outliers of the chain as a percentile score with respect to all X-ray entries followed by that with respect to entries of similar resolution.

The Analysed column shows the number of residues for which the sidechain conformation was analysed, and the total number of residues.

Mol	Chain	Analysed	Rotameric	Outliers	Percentiles	
1	A	311/389 (80%)	306 (98%)	5 (2%)	62	66
1	B	304/389 (78%)	300 (99%)	4 (1%)	69	72
1	C	293/389 (75%)	292 (100%)	1 (0%)	92	94
1	D	308/389 (79%)	303 (98%)	5 (2%)	62	66
1	E	314/389 (81%)	311 (99%)	3 (1%)	76	80
1	F	319/389 (82%)	313 (98%)	6 (2%)	57	59
1	G	285/389 (73%)	281 (99%)	4 (1%)	67	70
1	H	318/389 (82%)	315 (99%)	3 (1%)	78	82
1	I	273/389 (70%)	271 (99%)	2 (1%)	84	87
1	J	304/389 (78%)	302 (99%)	2 (1%)	84	87
1	K	307/389 (79%)	302 (98%)	5 (2%)	62	66
1	L	307/389 (79%)	303 (99%)	4 (1%)	69	72
1	M	311/389 (80%)	306 (98%)	5 (2%)	62	66
1	N	306/389 (79%)	298 (97%)	8 (3%)	46	46
1	O	279/389 (72%)	274 (98%)	5 (2%)	59	61
1	P	291/389 (75%)	285 (98%)	6 (2%)	53	55
All	All	4830/6224 (78%)	4762 (99%)	68 (1%)	67	70

All (68) residues with a non-rotameric sidechain are listed below:

Mol	Chain	Res	Type
1	A	236	GLU
1	A	255	ASP
1	A	335	ARG
1	A	388	PHE
1	A	468	SER
1	B	82	LEU
1	B	255	ASP
1	B	309	SER

*Continued on next page...*

*Continued from previous page...*

<b>Mol</b>	<b>Chain</b>	<b>Res</b>	<b>Type</b>
1	B	388	PHE
1	C	309	SER
1	D	220	ASP
1	D	236	GLU
1	D	255	ASP
1	D	266	SER
1	D	388	PHE
1	E	255	ASP
1	E	266	SER
1	E	388	PHE
1	F	82	LEU
1	F	153	ARG
1	F	179	MET
1	F	249	VAL
1	F	266	SER
1	F	388	PHE
1	G	82	LEU
1	G	220	ASP
1	G	288	ASP
1	G	388	PHE
1	H	255	ASP
1	H	260	HIS
1	H	388	PHE
1	I	255	ASP
1	I	266	SER
1	J	255	ASP
1	J	388	PHE
1	K	101	MET
1	K	255	ASP
1	K	347	LEU
1	K	388	PHE
1	K	464	GLU
1	L	47	ARG
1	L	82	LEU
1	L	255	ASP
1	L	388	PHE
1	M	82	LEU
1	M	249	VAL
1	M	255	ASP
1	M	266	SER
1	M	388	PHE
1	N	82	LEU

*Continued on next page...*

*Continued from previous page...*

Mol	Chain	Res	Type
1	N	255	ASP
1	N	257	SER
1	N	288	ASP
1	N	309	SER
1	N	388	PHE
1	N	464	GLU
1	N	468	SER
1	O	82	LEU
1	O	157	VAL
1	O	262	SER
1	O	388	PHE
1	O	471	ARG
1	P	82	LEU
1	P	288	ASP
1	P	309	SER
1	P	388	PHE
1	P	434	VAL
1	P	471	ARG

Sometimes sidechains can be flipped to improve hydrogen bonding and reduce clashes. All (1) such sidechains are listed below:

Mol	Chain	Res	Type
1	H	260	HIS

### 5.3.3 RNA [i](#)

There are no RNA molecules in this entry.

### 5.4 Non-standard residues in protein, DNA, RNA chains [i](#)

There are no non-standard protein/DNA/RNA residues in this entry.

### 5.5 Carbohydrates [i](#)

There are no monosaccharides in this entry.

### 5.6 Ligand geometry [i](#)

Of 64 ligands modelled in this entry, 32 are monoatomic - leaving 32 for Mogul analysis.

In the following table, the Counts columns list the number of bonds (or angles) for which Mogul statistics could be retrieved, the number of bonds (or angles) that are observed in the model and the number of bonds (or angles) that are defined in the Chemical Component Dictionary. The Link column lists molecule types, if any, to which the group is linked. The Z score for a bond length (or angle) is the number of standard deviations the observed value is removed from the expected value. A bond length (or angle) with  $|Z| > 2$  is considered an outlier worth inspection. RMSZ is the root-mean-square of all Z scores of the bond lengths (or angles).

Mol	Type	Chain	Res	Link	Bond lengths			Bond angles		
					Counts	RMSZ	# Z  > 2	Counts	RMSZ	# Z  > 2
3	G4P	P	601	4	30,38,38	5.14	12 (40%)	43,61,61	1.75	9 (20%)
3	G4P	D	601	4	30,38,38	5.05	12 (40%)	43,61,61	1.68	8 (18%)
3	G4P	N	601	4	30,38,38	5.13	12 (40%)	43,61,61	1.72	7 (16%)
3	G4P	H	601	4	30,38,38	5.14	12 (40%)	43,61,61	1.64	7 (16%)
2	ATP	K	600	4	26,33,33	0.62	0	31,52,52	1.03	2 (6%)
2	ATP	F	600	4	26,33,33	0.62	0	31,52,52	1.02	1 (3%)
3	G4P	C	601	4	30,38,38	5.12	12 (40%)	43,61,61	1.71	8 (18%)
2	ATP	E	600	4	26,33,33	0.63	0	31,52,52	1.01	1 (3%)
2	ATP	M	600	4	26,33,33	0.62	0	31,52,52	0.99	1 (3%)
2	ATP	O	600	4	26,33,33	0.62	0	31,52,52	1.04	3 (9%)
2	ATP	N	600	4	26,33,33	0.62	0	31,52,52	1.05	2 (6%)
3	G4P	O	601	4	30,38,38	5.14	12 (40%)	43,61,61	1.68	6 (13%)
2	ATP	P	600	4	26,33,33	0.61	0	31,52,52	1.04	2 (6%)
2	ATP	G	600	4	26,33,33	0.62	0	31,52,52	1.03	2 (6%)
3	G4P	G	601	4	30,38,38	5.09	12 (40%)	43,61,61	1.70	7 (16%)
3	G4P	K	601	4	30,38,38	5.08	12 (40%)	43,61,61	1.61	8 (18%)
2	ATP	J	600	4	26,33,33	0.62	0	31,52,52	1.04	2 (6%)
3	G4P	J	601	4	30,38,38	5.11	12 (40%)	43,61,61	1.75	8 (18%)
2	ATP	H	600	4	26,33,33	0.61	0	31,52,52	1.00	1 (3%)
2	ATP	D	600	4	26,33,33	0.60	0	31,52,52	1.00	1 (3%)
3	G4P	E	601	4	30,38,38	5.03	12 (40%)	43,61,61	1.70	7 (16%)
2	ATP	L	600	4	26,33,33	0.60	0	31,52,52	1.01	2 (6%)
3	G4P	F	601	4	30,38,38	5.02	12 (40%)	43,61,61	1.71	9 (20%)
3	G4P	L	601	4	30,38,38	5.08	12 (40%)	43,61,61	1.67	8 (18%)
2	ATP	B	600	4	26,33,33	0.61	0	31,52,52	1.02	1 (3%)
2	ATP	C	600	4	26,33,33	0.62	0	31,52,52	1.17	4 (12%)
2	ATP	A	600	4	26,33,33	0.60	0	31,52,52	1.01	1 (3%)
2	ATP	I	600	4	26,33,33	0.60	0	31,52,52	1.03	2 (6%)
3	G4P	M	601	4	30,38,38	5.10	12 (40%)	43,61,61	1.63	8 (18%)

Mol	Type	Chain	Res	Link	Bond lengths			Bond angles		
					Counts	RMSZ	# Z  > 2	Counts	RMSZ	# Z  > 2
3	G4P	B	601	4	30,38,38	5.05	12 (40%)	43,61,61	1.74	8 (18%)
3	G4P	A	601	4	30,38,38	5.03	12 (40%)	43,61,61	1.57	7 (16%)
3	G4P	I	601	4	30,38,38	5.13	12 (40%)	43,61,61	1.67	7 (16%)

In the following table, the Chirals column lists the number of chiral outliers, the number of chiral centers analysed, the number of these observed in the model and the number defined in the Chemical Component Dictionary. Similar counts are reported in the Torsion and Rings columns. '-' means no outliers of that kind were identified.

Mol	Type	Chain	Res	Link	Chirals	Torsions	Rings
3	G4P	P	601	4	-	1/23/43/43	0/3/3/3
3	G4P	D	601	4	-	2/23/43/43	0/3/3/3
3	G4P	N	601	4	-	2/23/43/43	0/3/3/3
3	G4P	H	601	4	-	1/23/43/43	0/3/3/3
2	ATP	K	600	4	-	2/18/38/38	0/3/3/3
2	ATP	F	600	4	-	1/18/38/38	0/3/3/3
3	G4P	C	601	4	-	2/23/43/43	0/3/3/3
2	ATP	E	600	4	-	1/18/38/38	0/3/3/3
2	ATP	M	600	4	-	1/18/38/38	0/3/3/3
2	ATP	O	600	4	-	1/18/38/38	0/3/3/3
2	ATP	N	600	4	-	5/18/38/38	0/3/3/3
3	G4P	O	601	4	-	8/23/43/43	0/3/3/3
2	ATP	P	600	4	-	0/18/38/38	0/3/3/3
2	ATP	G	600	4	-	1/18/38/38	0/3/3/3
3	G4P	G	601	4	-	2/23/43/43	0/3/3/3
3	G4P	K	601	4	-	2/23/43/43	0/3/3/3
2	ATP	J	600	4	-	2/18/38/38	0/3/3/3
3	G4P	J	601	4	-	4/23/43/43	0/3/3/3
2	ATP	H	600	4	-	1/18/38/38	0/3/3/3
2	ATP	D	600	4	-	2/18/38/38	0/3/3/3
3	G4P	E	601	4	-	2/23/43/43	0/3/3/3
2	ATP	L	600	4	-	2/18/38/38	0/3/3/3
3	G4P	F	601	4	-	1/23/43/43	0/3/3/3
3	G4P	L	601	4	-	2/23/43/43	0/3/3/3
2	ATP	B	600	4	-	0/18/38/38	0/3/3/3
2	ATP	C	600	4	-	0/18/38/38	0/3/3/3
2	ATP	A	600	4	-	1/18/38/38	0/3/3/3
2	ATP	I	600	4	-	1/18/38/38	0/3/3/3
3	G4P	M	601	4	-	2/23/43/43	0/3/3/3

Continued on next page...

Continued from previous page...

Mol	Type	Chain	Res	Link	Chirals	Torsions	Rings
3	G4P	B	601	4	-	2/23/43/43	0/3/3/3
3	G4P	A	601	4	-	2/23/43/43	0/3/3/3
3	G4P	I	601	4	-	5/23/43/43	0/3/3/3

All (192) bond length outliers are listed below:

Mol	Chain	Res	Type	Atoms	Z	Observed(Å)	Ideal(Å)
3	O	601	G4P	O4'-C1'	16.41	1.64	1.41
3	H	601	G4P	O4'-C1'	16.10	1.63	1.41
3	N	601	G4P	O4'-C1'	15.97	1.63	1.41
3	M	601	G4P	O4'-C1'	15.97	1.63	1.41
3	I	601	G4P	O4'-C1'	15.94	1.63	1.41
3	P	601	G4P	O4'-C1'	15.92	1.63	1.41
3	C	601	G4P	O4'-C1'	15.89	1.63	1.41
3	K	601	G4P	O4'-C1'	15.84	1.63	1.41
3	L	601	G4P	O4'-C1'	15.80	1.63	1.41
3	G	601	G4P	O4'-C1'	15.80	1.63	1.41
3	J	601	G4P	O4'-C1'	15.72	1.63	1.41
3	D	601	G4P	O4'-C1'	15.67	1.62	1.41
3	B	601	G4P	O4'-C1'	15.61	1.62	1.41
3	A	601	G4P	O4'-C1'	15.57	1.62	1.41
3	E	601	G4P	O4'-C1'	15.50	1.62	1.41
3	F	601	G4P	O4'-C1'	15.41	1.62	1.41
3	P	601	G4P	C2'-C1'	-15.38	1.30	1.53
3	C	601	G4P	C2'-C1'	-15.35	1.30	1.53
3	N	601	G4P	C2'-C1'	-15.28	1.30	1.53
3	H	601	G4P	C2'-C1'	-15.28	1.30	1.53
3	M	601	G4P	C2'-C1'	-15.25	1.30	1.53
3	J	601	G4P	C2'-C1'	-15.20	1.30	1.53
3	I	601	G4P	C2'-C1'	-15.17	1.30	1.53
3	F	601	G4P	C2'-C1'	-15.10	1.30	1.53
3	B	601	G4P	C2'-C1'	-15.02	1.31	1.53
3	K	601	G4P	C2'-C1'	-15.01	1.31	1.53
3	A	601	G4P	C2'-C1'	-15.00	1.31	1.53
3	L	601	G4P	C2'-C1'	-15.00	1.31	1.53
3	D	601	G4P	C2'-C1'	-15.00	1.31	1.53
3	G	601	G4P	C2'-C1'	-14.96	1.31	1.53
3	E	601	G4P	C2'-C1'	-14.87	1.31	1.53
3	O	601	G4P	C2'-C1'	-14.73	1.31	1.53
3	J	601	G4P	C4-N3	9.02	1.49	1.35
3	E	601	G4P	C4-N3	8.98	1.49	1.35
3	K	601	G4P	C4-N3	8.98	1.49	1.35

Continued on next page...



*Continued from previous page...*

Mol	Chain	Res	Type	Atoms	Z	Observed(Å)	Ideal(Å)
3	O	601	G4P	C4-N3	8.97	1.49	1.35
3	H	601	G4P	C4-N3	8.95	1.49	1.35
3	I	601	G4P	C4-N3	8.90	1.49	1.35
3	A	601	G4P	C4-N3	8.87	1.49	1.35
3	L	601	G4P	C4-N3	8.87	1.49	1.35
3	B	601	G4P	C4-N3	8.85	1.49	1.35
3	M	601	G4P	C4-N3	8.82	1.49	1.35
3	P	601	G4P	C4-N3	8.74	1.49	1.35
3	F	601	G4P	C4-N3	8.73	1.49	1.35
3	G	601	G4P	C4-N3	8.70	1.49	1.35
3	N	601	G4P	C4-N3	8.69	1.49	1.35
3	C	601	G4P	C4-N3	8.63	1.49	1.35
3	D	601	G4P	C4-N3	8.62	1.49	1.35
3	G	601	G4P	C5-C6	7.33	1.54	1.41
3	P	601	G4P	C5-C6	7.29	1.53	1.41
3	O	601	G4P	C5-C6	7.26	1.53	1.41
3	L	601	G4P	C5-C6	7.24	1.53	1.41
3	N	601	G4P	C5-C6	7.23	1.53	1.41
3	D	601	G4P	C5-C6	7.23	1.53	1.41
3	C	601	G4P	C5-C6	7.18	1.53	1.41
3	I	601	G4P	C5-C6	7.14	1.53	1.41
3	J	601	G4P	C5-C6	7.13	1.53	1.41
3	K	601	G4P	C5-C6	7.11	1.53	1.41
3	H	601	G4P	C5-C6	7.05	1.53	1.41
3	M	601	G4P	C5-C6	7.05	1.53	1.41
3	B	601	G4P	C5-C6	7.05	1.53	1.41
3	A	601	G4P	C5-C6	7.03	1.53	1.41
3	E	601	G4P	C5-C6	7.01	1.53	1.41
3	F	601	G4P	C5-C6	6.91	1.53	1.41
3	J	601	G4P	O4'-C4'	-6.20	1.31	1.45
3	N	601	G4P	C6-N1	6.09	1.43	1.33
3	P	601	G4P	C6-N1	6.05	1.43	1.33
3	G	601	G4P	C6-N1	6.03	1.43	1.33
3	L	601	G4P	O4'-C4'	-6.03	1.31	1.45
3	I	601	G4P	O4'-C4'	-6.03	1.31	1.45
3	C	601	G4P	C6-N1	6.00	1.43	1.33
3	I	601	G4P	C6-N1	6.00	1.43	1.33
3	O	601	G4P	C6-N1	5.99	1.43	1.33
3	D	601	G4P	O4'-C4'	-5.99	1.31	1.45
3	N	601	G4P	O4'-C4'	-5.98	1.31	1.45
3	P	601	G4P	O4'-C4'	-5.98	1.31	1.45
3	H	601	G4P	C6-N1	5.97	1.43	1.33

*Continued on next page...*

*Continued from previous page...*

Mol	Chain	Res	Type	Atoms	Z	Observed(Å)	Ideal(Å)
3	K	601	G4P	C6-N1	5.96	1.43	1.33
3	C	601	G4P	O4'-C4'	-5.96	1.31	1.45
3	G	601	G4P	O4'-C4'	-5.96	1.31	1.45
3	H	601	G4P	O4'-C4'	-5.96	1.31	1.45
3	O	601	G4P	O4'-C4'	-5.94	1.31	1.45
3	D	601	G4P	C6-N1	5.93	1.43	1.33
3	G	601	G4P	C2-N2	5.93	1.45	1.33
3	E	601	G4P	C6-N1	5.93	1.43	1.33
3	B	601	G4P	C6-N1	5.91	1.43	1.33
3	I	601	G4P	C2-N2	5.90	1.45	1.33
3	L	601	G4P	C6-N1	5.89	1.43	1.33
3	J	601	G4P	C6-N1	5.86	1.43	1.33
3	F	601	G4P	C6-N1	5.85	1.43	1.33
3	M	601	G4P	C6-N1	5.85	1.43	1.33
3	O	601	G4P	C2-N2	5.85	1.45	1.33
3	E	601	G4P	O4'-C4'	-5.85	1.31	1.45
3	F	601	G4P	O4'-C4'	-5.85	1.31	1.45
3	B	601	G4P	C2-N2	5.84	1.45	1.33
3	J	601	G4P	C2-N2	5.83	1.45	1.33
3	H	601	G4P	C2-N2	5.82	1.45	1.33
3	C	601	G4P	C2-N2	5.82	1.45	1.33
3	M	601	G4P	C2-N2	5.82	1.45	1.33
3	B	601	G4P	O4'-C4'	-5.81	1.32	1.45
3	F	601	G4P	C2-N2	5.81	1.45	1.33
3	P	601	G4P	C2-N2	5.81	1.45	1.33
3	K	601	G4P	O4'-C4'	-5.79	1.32	1.45
3	L	601	G4P	C2-N2	5.78	1.45	1.33
3	A	601	G4P	O4'-C4'	-5.78	1.32	1.45
3	N	601	G4P	C2-N2	5.77	1.45	1.33
3	E	601	G4P	C2-N2	5.76	1.45	1.33
3	A	601	G4P	C6-N1	5.76	1.43	1.33
3	D	601	G4P	C2-N2	5.74	1.45	1.33
3	K	601	G4P	C2-N2	5.72	1.45	1.33
3	A	601	G4P	C2-N2	5.68	1.45	1.33
3	M	601	G4P	O4'-C4'	-5.63	1.32	1.45
3	O	601	G4P	C2-N1	5.18	1.44	1.35
3	I	601	G4P	C2-N1	5.09	1.44	1.35
3	D	601	G4P	C2-N1	5.07	1.44	1.35
3	B	601	G4P	C2-N1	5.07	1.44	1.35
3	G	601	G4P	C2-N1	5.07	1.44	1.35
3	N	601	G4P	C2-N1	5.06	1.44	1.35
3	P	601	G4P	C2-N1	5.06	1.44	1.35

*Continued on next page...*

*Continued from previous page...*

Mol	Chain	Res	Type	Atoms	Z	Observed(Å)	Ideal(Å)
3	C	601	G4P	C2-N1	5.04	1.44	1.35
3	H	601	G4P	C2-N1	5.03	1.44	1.35
3	L	601	G4P	C2-N1	4.99	1.44	1.35
3	J	601	G4P	C2-N1	4.98	1.44	1.35
3	F	601	G4P	C2-N1	4.97	1.44	1.35
3	K	601	G4P	C2-N1	4.97	1.44	1.35
3	E	601	G4P	C2-N1	4.94	1.44	1.35
3	M	601	G4P	C2-N1	4.86	1.44	1.35
3	A	601	G4P	C2-N1	4.84	1.44	1.35
3	O	601	G4P	O2'-C2'	2.99	1.50	1.43
3	G	601	G4P	O2'-C2'	2.89	1.49	1.43
3	J	601	G4P	O2'-C2'	2.86	1.49	1.43
3	L	601	G4P	O2'-C2'	2.84	1.49	1.43
3	I	601	G4P	O2'-C2'	2.83	1.49	1.43
3	F	601	G4P	O2'-C2'	2.82	1.49	1.43
3	P	601	G4P	O2'-C2'	2.81	1.49	1.43
3	C	601	G4P	O2'-C2'	2.81	1.49	1.43
3	M	601	G4P	O2'-C2'	2.78	1.49	1.43
3	K	601	G4P	O2'-C2'	2.77	1.49	1.43
3	N	601	G4P	O2'-C2'	2.76	1.49	1.43
3	B	601	G4P	O2'-C2'	2.74	1.49	1.43
3	D	601	G4P	O2'-C2'	2.73	1.49	1.43
3	H	601	G4P	O2'-C2'	2.70	1.49	1.43
3	A	601	G4P	O2'-C2'	2.69	1.49	1.43
3	E	601	G4P	O2'-C2'	2.60	1.49	1.43
3	O	601	G4P	C2-N3	2.56	1.46	1.34
3	I	601	G4P	C2-N3	2.55	1.46	1.34
3	J	601	G4P	C2-N3	2.55	1.46	1.34
3	L	601	G4P	C2-N3	2.54	1.46	1.34
3	K	601	G4P	C2-N3	2.54	1.46	1.34
3	M	601	G4P	C2-N3	2.54	1.46	1.34
3	H	601	G4P	C2-N3	2.53	1.46	1.34
3	B	601	G4P	C2-N3	2.53	1.46	1.34
3	P	601	G4P	C2-N3	2.51	1.46	1.34
3	G	601	G4P	C2-N3	2.50	1.46	1.34
3	E	601	G4P	C2-N3	2.50	1.46	1.34
3	F	601	G4P	C2-N3	2.47	1.46	1.34
3	D	601	G4P	C2-N3	2.46	1.46	1.34
3	A	601	G4P	C2-N3	2.46	1.46	1.34
3	C	601	G4P	C2-N3	2.43	1.46	1.34
3	N	601	G4P	C2-N3	2.42	1.46	1.34
3	H	601	G4P	O6-C6	-2.41	1.18	1.24

*Continued on next page...*

Continued from previous page...

Mol	Chain	Res	Type	Atoms	Z	Observed(Å)	Ideal(Å)
3	E	601	G4P	O6-C6	-2.40	1.18	1.24
3	A	601	G4P	O6-C6	-2.33	1.18	1.24
3	L	601	G4P	O3'-C3'	-2.33	1.35	1.44
3	I	601	G4P	O3'-C3'	-2.33	1.35	1.44
3	N	601	G4P	O6-C6	-2.31	1.18	1.24
3	J	601	G4P	O3'-C3'	-2.29	1.35	1.44
3	D	601	G4P	O3'-C3'	-2.29	1.35	1.44
3	B	601	G4P	O3'-C3'	-2.29	1.35	1.44
3	C	601	G4P	O3'-C3'	-2.28	1.35	1.44
3	E	601	G4P	O3'-C3'	-2.28	1.35	1.44
3	F	601	G4P	O6-C6	-2.28	1.18	1.24
3	C	601	G4P	O6-C6	-2.28	1.18	1.24
3	M	601	G4P	O6-C6	-2.28	1.18	1.24
3	F	601	G4P	O3'-C3'	-2.27	1.35	1.44
3	D	601	G4P	O6-C6	-2.27	1.18	1.24
3	J	601	G4P	O6-C6	-2.26	1.18	1.24
3	O	601	G4P	O6-C6	-2.26	1.18	1.24
3	G	601	G4P	O3'-C3'	-2.25	1.35	1.44
3	K	601	G4P	O6-C6	-2.24	1.18	1.24
3	G	601	G4P	O6-C6	-2.24	1.18	1.24
3	I	601	G4P	O6-C6	-2.24	1.18	1.24
3	K	601	G4P	O3'-C3'	-2.23	1.36	1.44
3	B	601	G4P	O6-C6	-2.23	1.18	1.24
3	O	601	G4P	O3'-C3'	-2.23	1.36	1.44
3	L	601	G4P	O6-C6	-2.22	1.19	1.24
3	H	601	G4P	O3'-C3'	-2.20	1.36	1.44
3	P	601	G4P	O6-C6	-2.19	1.19	1.24
3	N	601	G4P	O3'-C3'	-2.18	1.36	1.44
3	P	601	G4P	O3'-C3'	-2.18	1.36	1.44
3	M	601	G4P	O3'-C3'	-2.16	1.36	1.44
3	A	601	G4P	O3'-C3'	-2.15	1.36	1.44

All (150) bond angle outliers are listed below:

Mol	Chain	Res	Type	Atoms	Z	Observed(°)	Ideal(°)
3	G	601	G4P	N3-C2-N1	-5.59	119.76	127.22
3	C	601	G4P	N3-C2-N1	-5.56	119.81	127.22
3	I	601	G4P	N3-C2-N1	-5.54	119.83	127.22
3	P	601	G4P	N3-C2-N1	-5.54	119.84	127.22
3	O	601	G4P	N3-C2-N1	-5.49	119.90	127.22
3	N	601	G4P	N3-C2-N1	-5.48	119.92	127.22
3	H	601	G4P	N3-C2-N1	-5.46	119.93	127.22

Continued on next page...

*Continued from previous page...*

Mol	Chain	Res	Type	Atoms	Z	Observed(°)	Ideal(°)
3	E	601	G4P	N3-C2-N1	-5.45	119.95	127.22
3	M	601	G4P	N3-C2-N1	-5.45	119.95	127.22
3	B	601	G4P	N3-C2-N1	-5.45	119.96	127.22
3	L	601	G4P	N3-C2-N1	-5.38	120.05	127.22
3	F	601	G4P	N3-C2-N1	-5.36	120.07	127.22
3	D	601	G4P	N3-C2-N1	-5.36	120.08	127.22
3	K	601	G4P	N3-C2-N1	-5.29	120.17	127.22
3	J	601	G4P	N3-C2-N1	-5.26	120.21	127.22
3	A	601	G4P	N3-C2-N1	-5.21	120.28	127.22
3	N	601	G4P	C1'-N9-C4	-4.89	118.05	126.64
3	B	601	G4P	O3C-PC-O3'	4.75	112.06	102.48
3	P	601	G4P	C1'-N9-C4	-4.74	118.31	126.64
3	C	601	G4P	C2-N3-C4	4.72	120.75	115.36
3	G	601	G4P	C1'-N9-C4	-4.71	118.37	126.64
3	H	601	G4P	C2-N3-C4	4.70	120.73	115.36
3	M	601	G4P	C2-N3-C4	4.67	120.69	115.36
3	G	601	G4P	C2-N3-C4	4.63	120.65	115.36
3	P	601	G4P	C2-N3-C4	4.63	120.64	115.36
3	I	601	G4P	C2-N3-C4	4.62	120.63	115.36
3	O	601	G4P	C2-N3-C4	4.61	120.62	115.36
3	L	601	G4P	C2-N3-C4	4.60	120.61	115.36
3	D	601	G4P	C1'-N9-C4	-4.56	118.63	126.64
3	N	601	G4P	C2-N3-C4	4.47	120.46	115.36
3	D	601	G4P	C2-N3-C4	4.43	120.42	115.36
3	E	601	G4P	C2-N3-C4	4.42	120.41	115.36
3	F	601	G4P	C2-N3-C4	4.35	120.33	115.36
3	C	601	G4P	C1'-N9-C4	-4.35	119.00	126.64
3	K	601	G4P	C2-N3-C4	4.27	120.24	115.36
3	B	601	G4P	C2-N3-C4	4.20	120.16	115.36
3	J	601	G4P	C2-N3-C4	4.19	120.14	115.36
3	K	601	G4P	C1'-N9-C4	-4.12	119.41	126.64
3	O	601	G4P	C1'-N9-C4	-4.10	119.44	126.64
3	A	601	G4P	C2-N3-C4	4.07	120.01	115.36
3	B	601	G4P	C1'-N9-C4	-4.05	119.52	126.64
3	J	601	G4P	O3C-PC-O3'	4.02	110.59	102.48
3	I	601	G4P	C1'-N9-C4	-3.98	119.66	126.64
3	M	601	G4P	C1'-N9-C4	-3.95	119.71	126.64
3	E	601	G4P	C1'-N9-C4	-3.90	119.78	126.64
3	L	601	G4P	C1'-N9-C4	-3.87	119.85	126.64
3	A	601	G4P	C1'-N9-C4	-3.86	119.86	126.64
3	J	601	G4P	C1'-N9-C4	-3.82	119.94	126.64
3	H	601	G4P	C1'-N9-C4	-3.80	119.97	126.64

*Continued on next page...*

*Continued from previous page...*

Mol	Chain	Res	Type	Atoms	Z	Observed(°)	Ideal(°)
3	F	601	G4P	O3C-PC-O3'	3.71	109.97	102.48
3	F	601	G4P	C1'-N9-C4	-3.69	120.16	126.64
3	E	601	G4P	O3C-PC-O3'	3.64	109.82	102.48
3	J	601	G4P	PC-O3C-PD	-3.46	120.97	132.83
3	O	601	G4P	PC-O3C-PD	-3.28	121.58	132.83
3	C	601	G4P	PC-O3C-PD	-3.10	122.18	132.83
3	P	601	G4P	PC-O3C-PD	-3.09	122.23	132.83
3	L	601	G4P	PC-O3C-PD	-2.92	122.81	132.83
3	I	601	G4P	PA-O3A-PB	-2.91	122.85	132.83
2	C	600	ATP	O3'-C3'-C2'	-2.85	102.61	111.82
3	F	601	G4P	PC-O3C-PD	-2.83	123.11	132.83
3	H	601	G4P	PC-O3C-PD	-2.79	123.25	132.83
3	B	601	G4P	PC-O3C-PD	-2.77	123.33	132.83
3	N	601	G4P	PC-O3C-PD	-2.72	123.48	132.83
3	E	601	G4P	PC-O3C-PD	-2.72	123.49	132.83
3	I	601	G4P	PC-O3C-PD	-2.69	123.59	132.83
3	A	601	G4P	PC-O3C-PD	-2.58	123.97	132.83
3	B	601	G4P	C5-C6-N1	-2.57	119.91	123.43
3	A	601	G4P	C5-C6-N1	-2.57	119.92	123.43
3	N	601	G4P	N2-C2-N1	2.56	121.23	117.25
3	J	601	G4P	C5-C6-N1	-2.55	119.94	123.43
3	F	601	G4P	C5-C6-N1	-2.55	119.95	123.43
3	K	601	G4P	PC-O3C-PD	-2.53	124.14	132.83
3	G	601	G4P	C5-C6-N1	-2.50	120.01	123.43
3	C	601	G4P	C5-C6-N1	-2.49	120.03	123.43
3	D	601	G4P	C5-C6-N1	-2.48	120.04	123.43
3	K	601	G4P	C5-C6-N1	-2.47	120.05	123.43
3	D	601	G4P	PC-O3C-PD	-2.43	124.48	132.83
3	I	601	G4P	C5-C6-N1	-2.42	120.12	123.43
3	L	601	G4P	C5-C6-N1	-2.42	120.12	123.43
3	N	601	G4P	C5-C6-N1	-2.42	120.12	123.43
3	O	601	G4P	C5-C6-N1	-2.42	120.12	123.43
3	B	601	G4P	C2-N1-C6	2.42	119.77	115.93
3	J	601	G4P	PA-O3A-PB	-2.41	124.55	132.83
3	A	601	G4P	C2-N1-C6	2.38	119.70	115.93
3	L	601	G4P	O3C-PC-O3'	2.37	107.27	102.48
3	M	601	G4P	C5-C6-N1	-2.37	120.19	123.43
3	P	601	G4P	C5-C6-N1	-2.37	120.20	123.43
3	G	601	G4P	C2-N1-C6	2.34	119.64	115.93
3	E	601	G4P	C5-C6-N1	-2.34	120.24	123.43
3	J	601	G4P	C2-N1-C6	2.31	119.60	115.93
3	H	601	G4P	O3D-PD-O3C	2.31	112.39	104.64

*Continued on next page...*

*Continued from previous page...*

Mol	Chain	Res	Type	Atoms	Z	Observed(°)	Ideal(°)
3	M	601	G4P	C3'-C2'-C1'	2.31	105.01	99.89
3	E	601	G4P	C2-N1-C6	2.30	119.58	115.93
2	A	600	ATP	C5-C6-N6	2.29	123.84	120.35
2	K	600	ATP	O2'-C2'-C1'	-2.29	102.38	110.85
2	N	600	ATP	O2'-C2'-C1'	-2.29	102.39	110.85
3	F	601	G4P	C2-N1-C6	2.29	119.56	115.93
3	N	601	G4P	C2-N1-C6	2.27	119.54	115.93
3	C	601	G4P	C2-N1-C6	2.27	119.53	115.93
3	K	601	G4P	C2-N1-C6	2.26	119.52	115.93
3	I	601	G4P	C2-N1-C6	2.26	119.52	115.93
3	O	601	G4P	C2-N1-C6	2.26	119.51	115.93
3	H	601	G4P	C5-C6-N1	-2.25	120.36	123.43
3	C	601	G4P	N2-C2-N1	2.24	120.74	117.25
3	P	601	G4P	C2-N1-C6	2.23	119.48	115.93
3	M	601	G4P	PC-O3C-PD	-2.21	125.23	132.83
3	F	601	G4P	C3'-C2'-C1'	2.21	104.79	99.89
3	D	601	G4P	C2-N1-C6	2.21	119.44	115.93
2	K	600	ATP	C5-C6-N6	2.20	123.70	120.35
3	M	601	G4P	C2-N1-C6	2.19	119.41	115.93
2	P	600	ATP	C5-C6-N6	2.19	123.68	120.35
3	L	601	G4P	C2-N1-C6	2.19	119.41	115.93
2	J	600	ATP	O2'-C2'-C1'	-2.19	102.78	110.85
2	J	600	ATP	C5-C6-N6	2.19	123.67	120.35
2	O	600	ATP	C5-C6-N6	2.19	123.67	120.35
3	G	601	G4P	N2-C2-N1	2.19	120.65	117.25
2	H	600	ATP	C5-C6-N6	2.17	123.66	120.35
3	G	601	G4P	PC-O3C-PD	-2.17	125.37	132.83
2	C	600	ATP	C5-C6-N6	2.16	123.64	120.35
2	N	600	ATP	C5-C6-N6	2.16	123.63	120.35
2	D	600	ATP	C5-C6-N6	2.15	123.63	120.35
2	L	600	ATP	C5-C6-N6	2.15	123.62	120.35
2	B	600	ATP	C5-C6-N6	2.15	123.62	120.35
3	D	601	G4P	N2-C2-N1	2.15	120.60	117.25
2	I	600	ATP	C5-C6-N6	2.15	123.62	120.35
2	M	600	ATP	C5-C6-N6	2.14	123.60	120.35
3	A	601	G4P	C3'-C2'-C1'	2.11	104.57	99.89
3	L	601	G4P	O2D-PD-O3C	2.11	111.71	104.64
3	H	601	G4P	C2-N1-C6	2.11	119.27	115.93
2	G	600	ATP	C5-C6-N6	2.10	123.54	120.35
2	G	600	ATP	PB-O3B-PG	2.09	140.01	132.83
3	D	601	G4P	C3'-C2'-C1'	2.09	104.52	99.89
3	F	601	G4P	O3B-PB-O3A	2.09	111.64	104.64

*Continued on next page...*

*Continued from previous page...*

Mol	Chain	Res	Type	Atoms	Z	Observed(°)	Ideal(°)
3	P	601	G4P	C3'-C2'-C1'	2.09	104.51	99.89
3	K	601	G4P	C3'-C2'-C1'	2.08	104.49	99.89
2	E	600	ATP	C5-C6-N6	2.08	123.51	120.35
3	P	601	G4P	N2-C2-N1	2.07	120.47	117.25
2	C	600	ATP	PB-O3B-PG	2.06	139.91	132.83
2	F	600	ATP	C5-C6-N6	2.06	123.49	120.35
3	P	601	G4P	O3B-PB-O3A	2.06	111.56	104.64
2	C	600	ATP	O2'-C2'-C1'	-2.06	103.24	110.85
3	K	601	G4P	O3D-PD-O3C	2.06	111.55	104.64
3	C	601	G4P	C3'-C2'-C1'	2.05	104.44	99.89
2	I	600	ATP	PB-O3B-PG	2.03	139.80	132.83
2	O	600	ATP	O2'-C2'-C1'	-2.03	103.36	110.85
2	L	600	ATP	O2'-C2'-C1'	-2.03	103.37	110.85
2	P	600	ATP	PB-O3B-PG	2.02	139.77	132.83
3	B	601	G4P	C3'-C2'-C1'	2.02	104.36	99.89
2	O	600	ATP	PB-O3B-PG	2.01	139.72	132.83
3	M	601	G4P	O3D-PD-O3C	2.00	111.36	104.64

There are no chirality outliers.

All (61) torsion outliers are listed below:

Mol	Chain	Res	Type	Atoms
2	N	600	ATP	PB-O3A-PA-O5'
3	A	601	G4P	C5'-O5'-PA-O3A
3	A	601	G4P	C5'-O5'-PA-O1A
3	B	601	G4P	C5'-O5'-PA-O1A
3	C	601	G4P	C5'-O5'-PA-O3A
3	C	601	G4P	C5'-O5'-PA-O1A
3	D	601	G4P	C5'-O5'-PA-O3A
3	D	601	G4P	C5'-O5'-PA-O1A
3	E	601	G4P	C5'-O5'-PA-O1A
3	G	601	G4P	C5'-O5'-PA-O1A
3	I	601	G4P	C5'-O5'-PA-O3A
3	J	601	G4P	C5'-O5'-PA-O3A
3	K	601	G4P	C5'-O5'-PA-O3A
3	K	601	G4P	C5'-O5'-PA-O1A
3	L	601	G4P	C5'-O5'-PA-O1A
3	M	601	G4P	C5'-O5'-PA-O1A
3	N	601	G4P	C5'-O5'-PA-O1A
3	O	601	G4P	C5'-O5'-PA-O3A
3	O	601	G4P	C5'-O5'-PA-O1A
3	O	601	G4P	O4'-C4'-C5'-O5'

*Continued on next page...*



*Continued from previous page...*

Mol	Chain	Res	Type	Atoms
3	O	601	G4P	C3'-C4'-C5'-O5'
2	N	600	ATP	PB-O3B-PG-O3G
3	B	601	G4P	C5'-O5'-PA-O3A
3	E	601	G4P	C5'-O5'-PA-O3A
3	G	601	G4P	C5'-O5'-PA-O3A
3	L	601	G4P	C5'-O5'-PA-O3A
3	M	601	G4P	C5'-O5'-PA-O3A
3	N	601	G4P	C5'-O5'-PA-O3A
2	D	600	ATP	PG-O3B-PB-O2B
2	E	600	ATP	PG-O3B-PB-O1B
2	F	600	ATP	PG-O3B-PB-O1B
2	K	600	ATP	PG-O3B-PB-O2B
2	L	600	ATP	PG-O3B-PB-O2B
2	M	600	ATP	PG-O3B-PB-O2B
3	J	601	G4P	PB-O3A-PA-O2A
2	N	600	ATP	C5'-O5'-PA-O2A
3	I	601	G4P	C5'-O5'-PA-O1A
3	J	601	G4P	C5'-O5'-PA-O1A
3	J	601	G4P	C5'-O5'-PA-O2A
2	A	600	ATP	PG-O3B-PB-O2B
2	H	600	ATP	PG-O3B-PB-O2B
2	J	600	ATP	PG-O3B-PB-O2B
3	I	601	G4P	PB-O3A-PA-O2A
3	O	601	G4P	PA-O3A-PB-O1B
3	O	601	G4P	PA-O3A-PB-O2B
3	O	601	G4P	PA-O3A-PB-O3B
2	N	600	ATP	C5'-O5'-PA-O3A
2	D	600	ATP	PG-O3B-PB-O1B
2	K	600	ATP	PG-O3B-PB-O1B
2	L	600	ATP	PG-O3B-PB-O1B
3	I	601	G4P	PB-O3A-PA-O1A
2	G	600	ATP	C5'-O5'-PA-O1A
2	I	600	ATP	C5'-O5'-PA-O1A
2	J	600	ATP	C5'-O5'-PA-O1A
2	N	600	ATP	C5'-O5'-PA-O1A
2	O	600	ATP	C5'-O5'-PA-O1A
3	F	601	G4P	C5'-O5'-PA-O1A
3	H	601	G4P	C5'-O5'-PA-O1A
3	I	601	G4P	C5'-O5'-PA-O2A
3	O	601	G4P	C5'-O5'-PA-O2A
3	P	601	G4P	C5'-O5'-PA-O1A

There are no ring outliers.

12 monomers are involved in 15 short contacts:

Mol	Chain	Res	Type	Clashes	Symm-Clashes
3	P	601	G4P	1	0
3	D	601	G4P	2	0
3	H	601	G4P	1	0
3	C	601	G4P	1	0
2	N	600	ATP	1	0
3	O	601	G4P	1	0
2	G	600	ATP	1	0
3	G	601	G4P	1	0
3	E	601	G4P	1	0
3	F	601	G4P	1	0
3	B	601	G4P	3	0
3	A	601	G4P	1	0

The following is a two-dimensional graphical depiction of Mogul quality analysis of bond lengths, bond angles, torsion angles, and ring geometry for all instances of the Ligand of Interest. In addition, ligands with molecular weight > 250 and outliers as shown on the validation Tables will also be included. For torsion angles, if less than 5% of the Mogul distribution of torsion angles is within 10 degrees of the torsion angle in question, then that torsion angle is considered an outlier. Any bond that is central to one or more torsion angles identified as an outlier by Mogul will be highlighted in the graph. For rings, the root-mean-square deviation (RMSD) between the ring in question and similar rings identified by Mogul is calculated over all ring torsion angles. If the average RMSD is greater than 60 degrees and the minimal RMSD between the ring in question and any Mogul-identified rings is also greater than 60 degrees, then that ring is considered an outlier. The outliers are highlighted in purple. The color gray indicates Mogul did not find sufficient equivalents in the CSD to analyse the geometry.

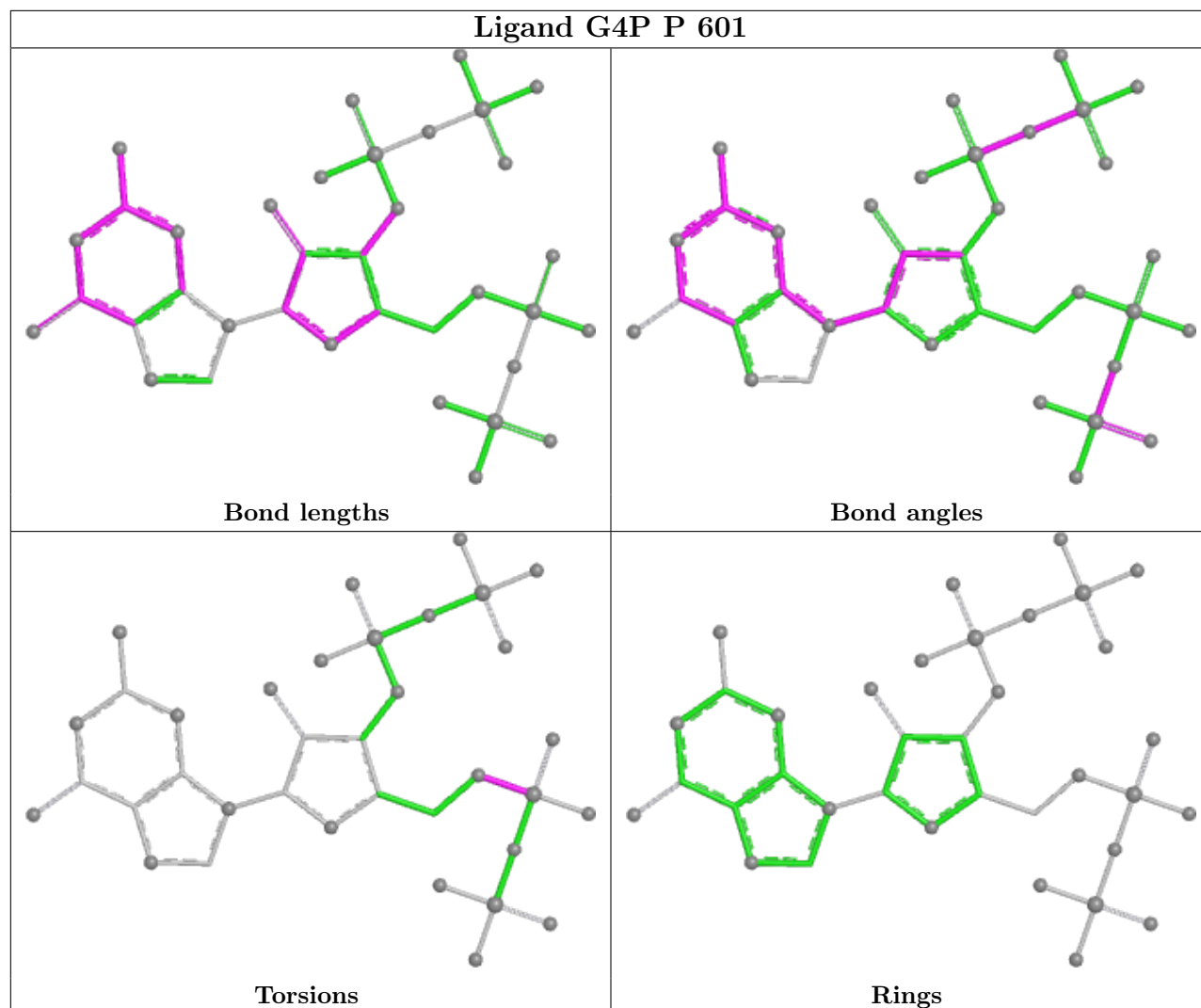

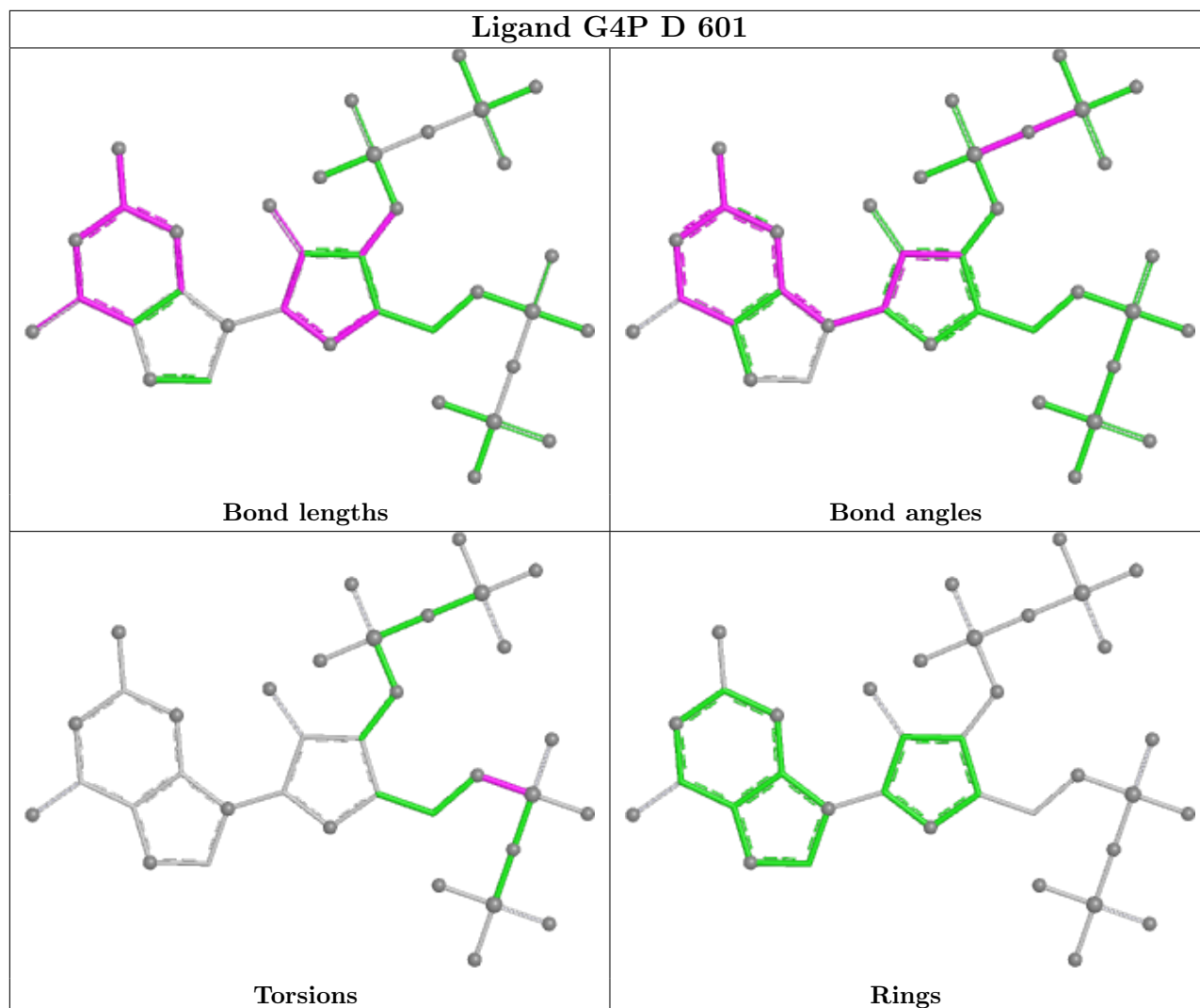

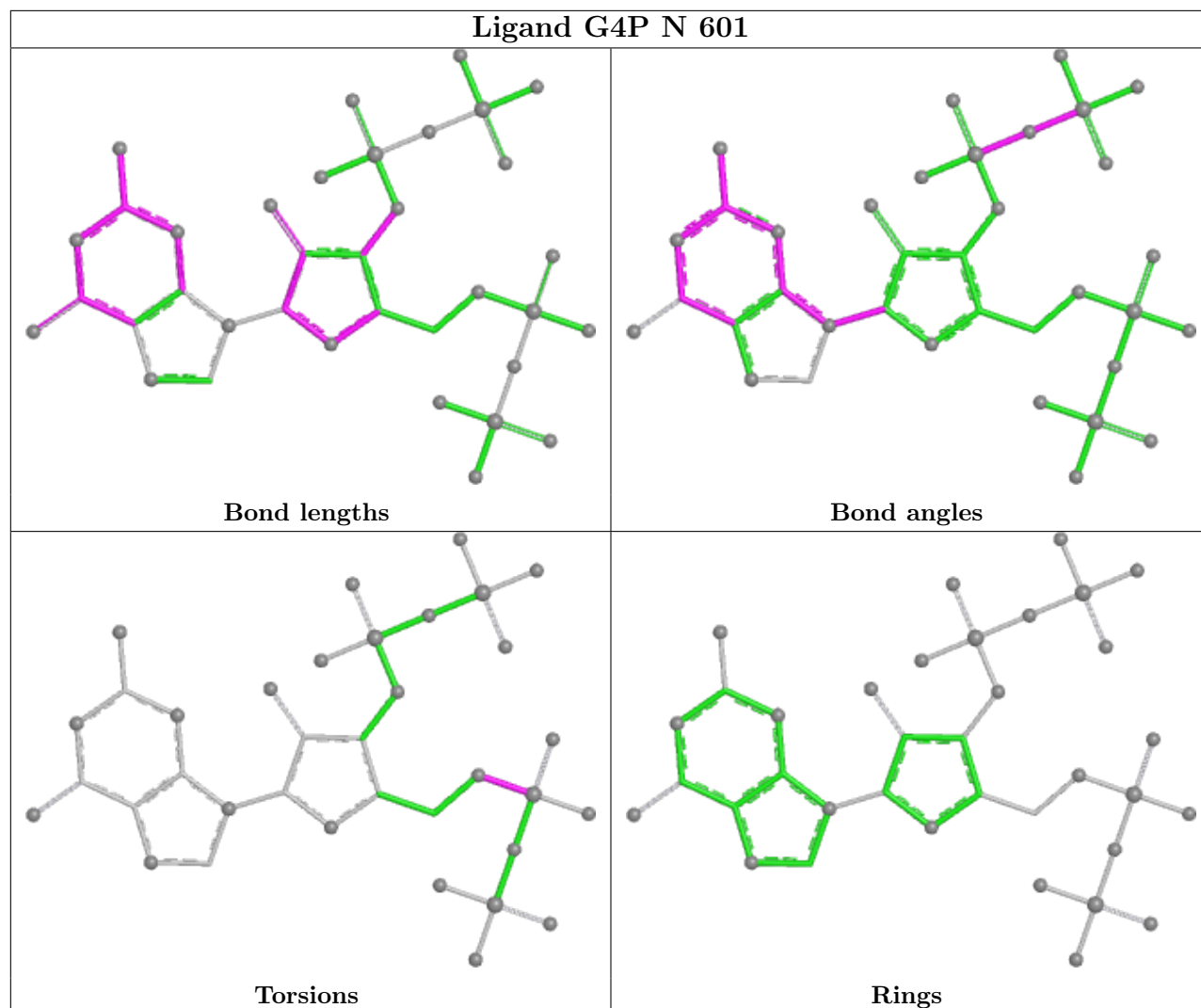

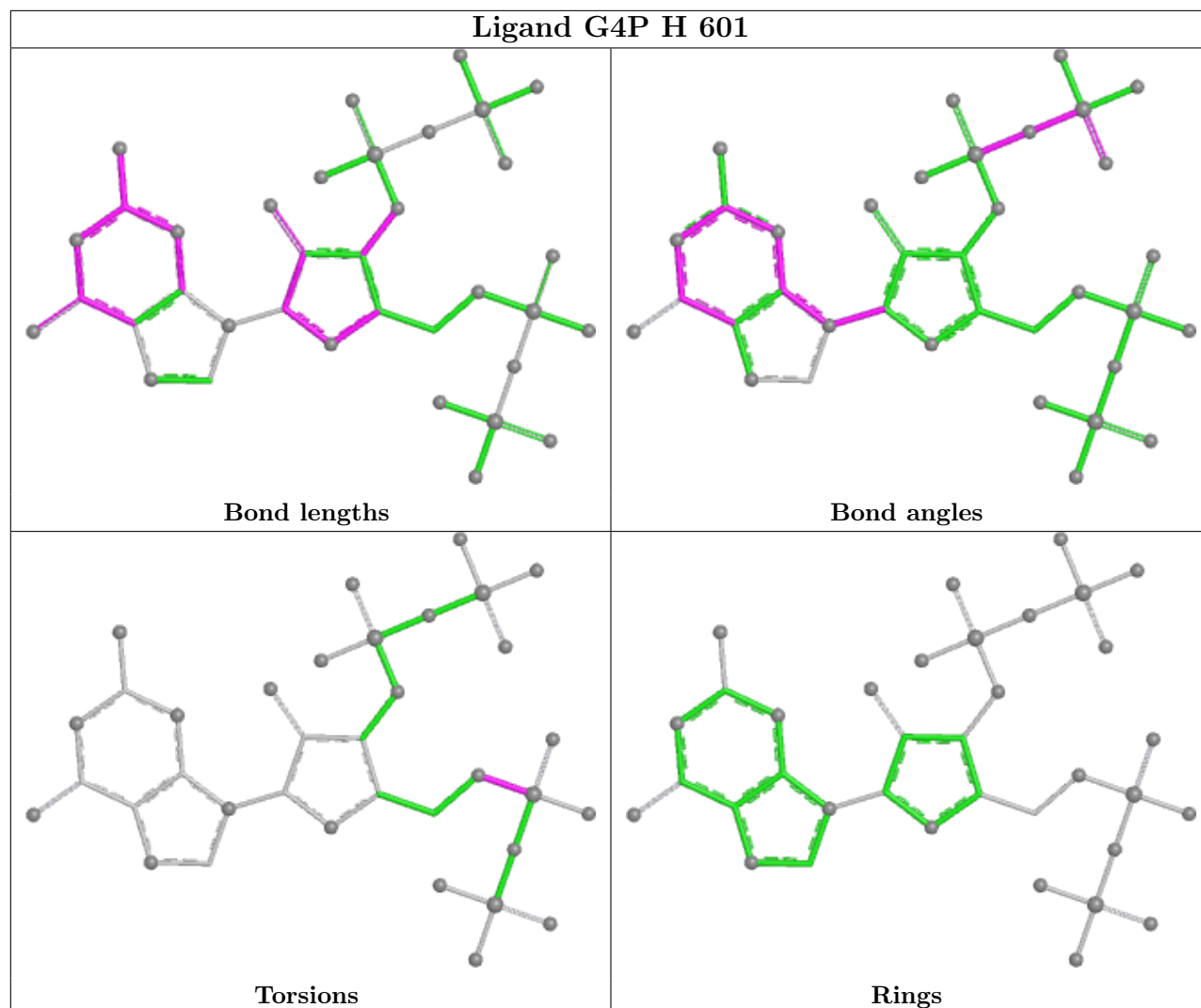

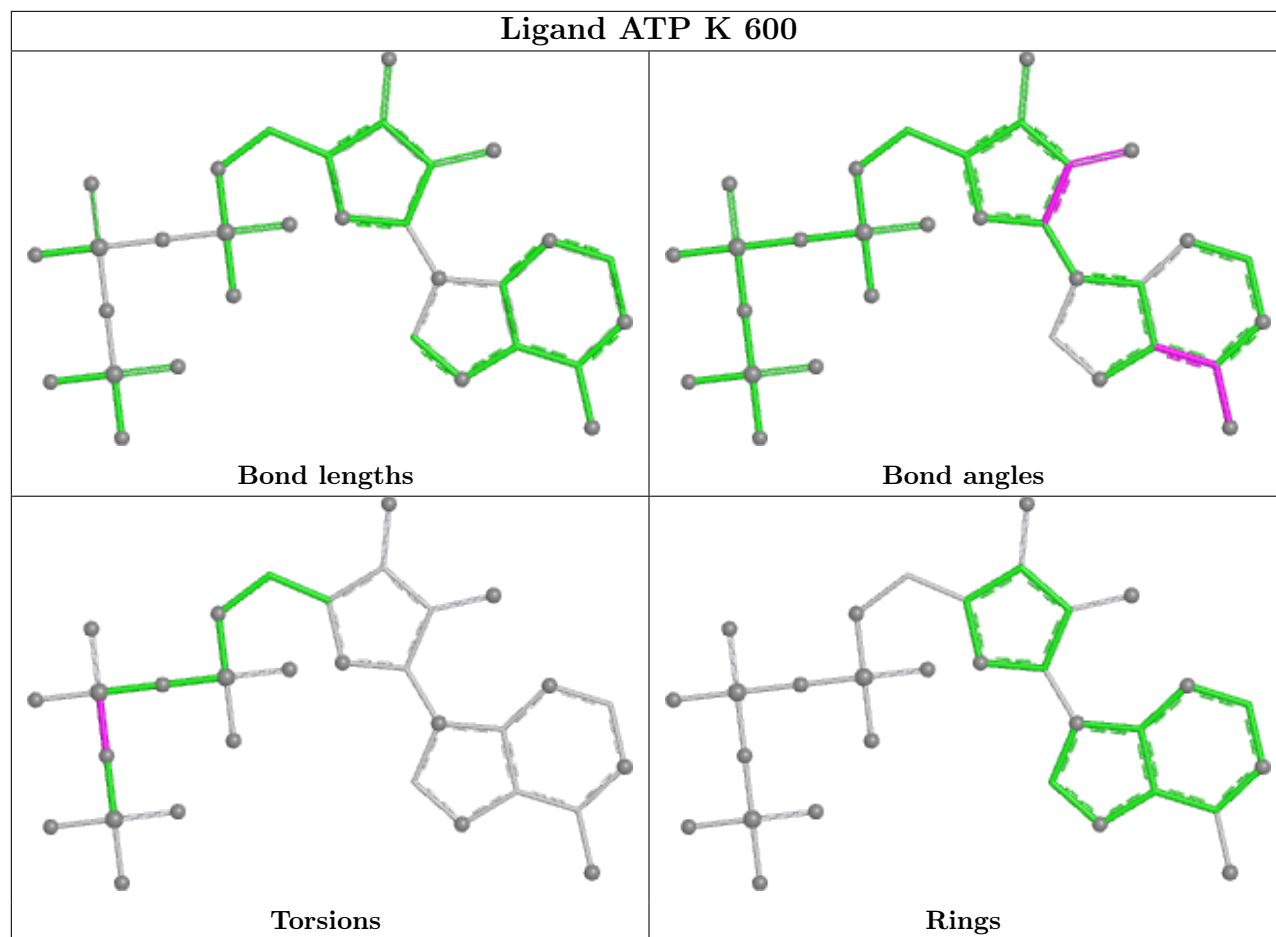

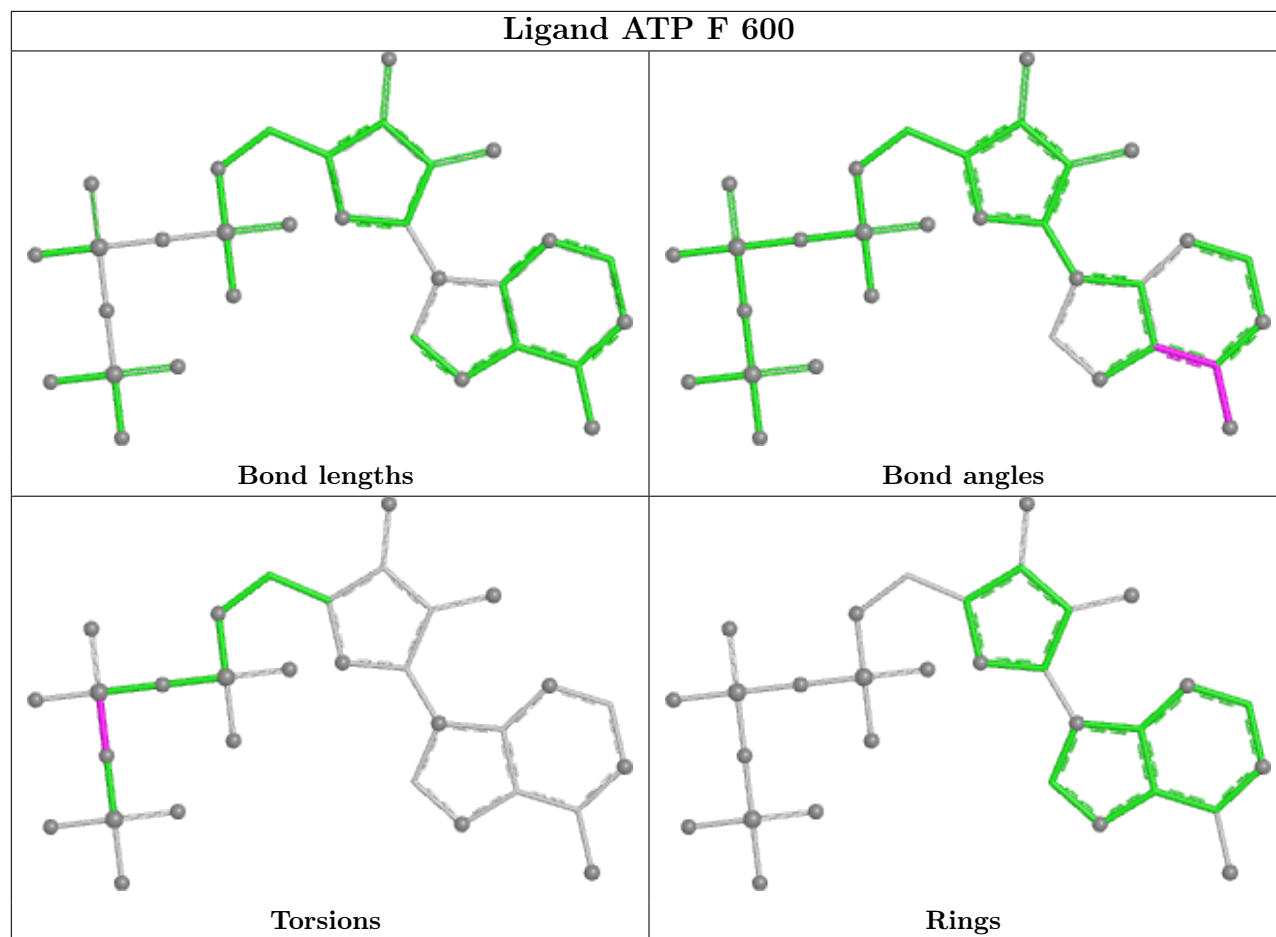



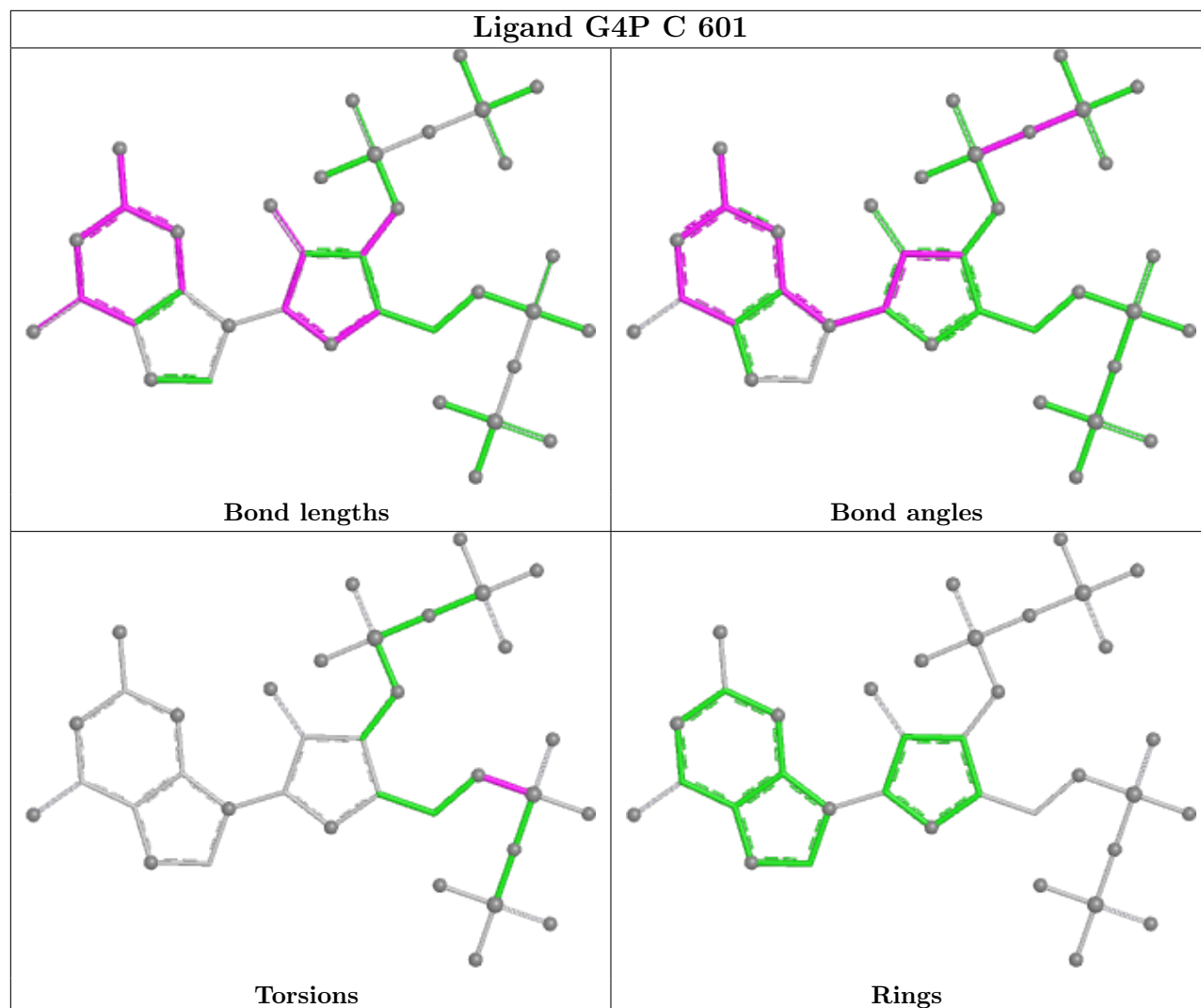

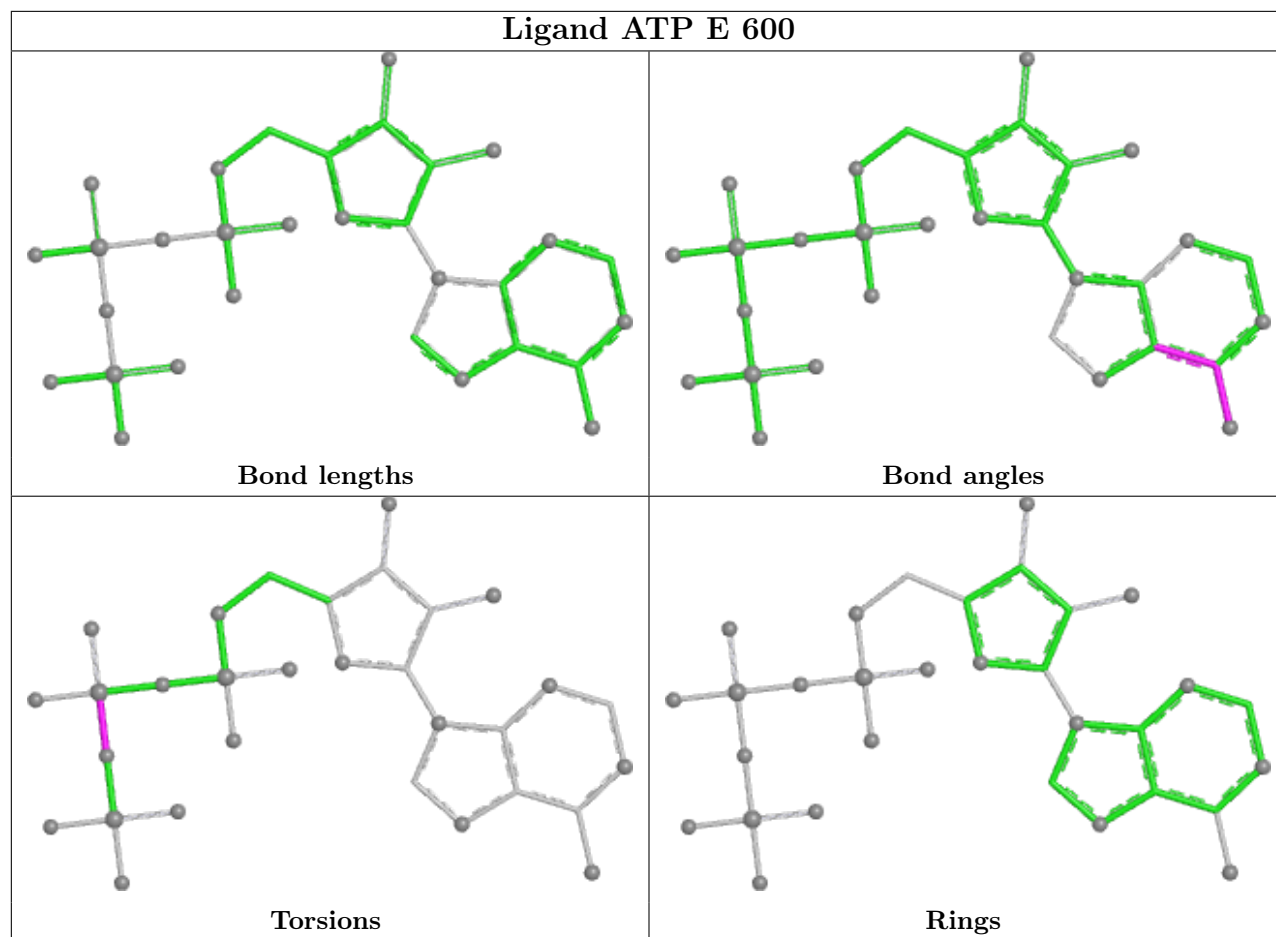

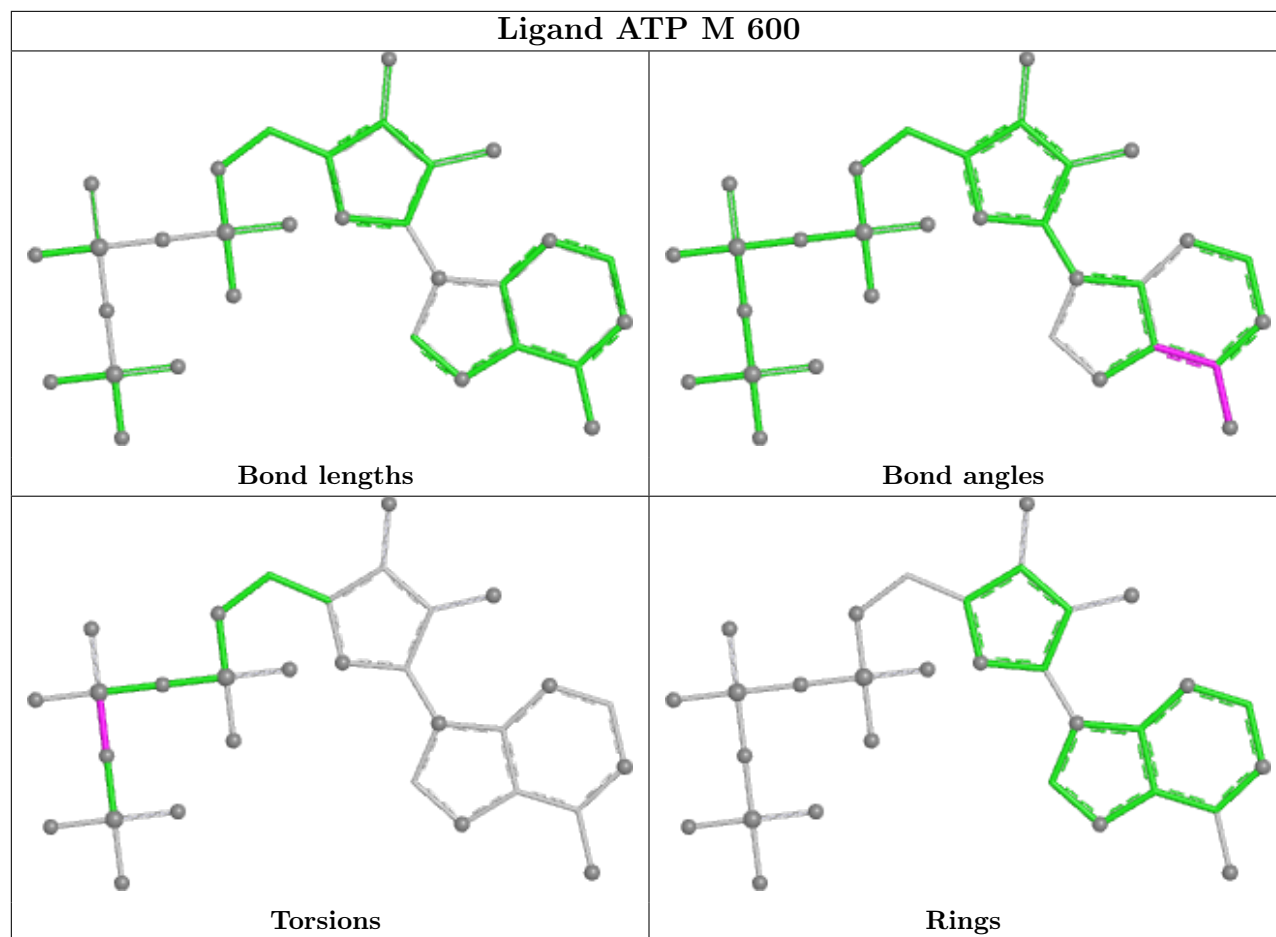

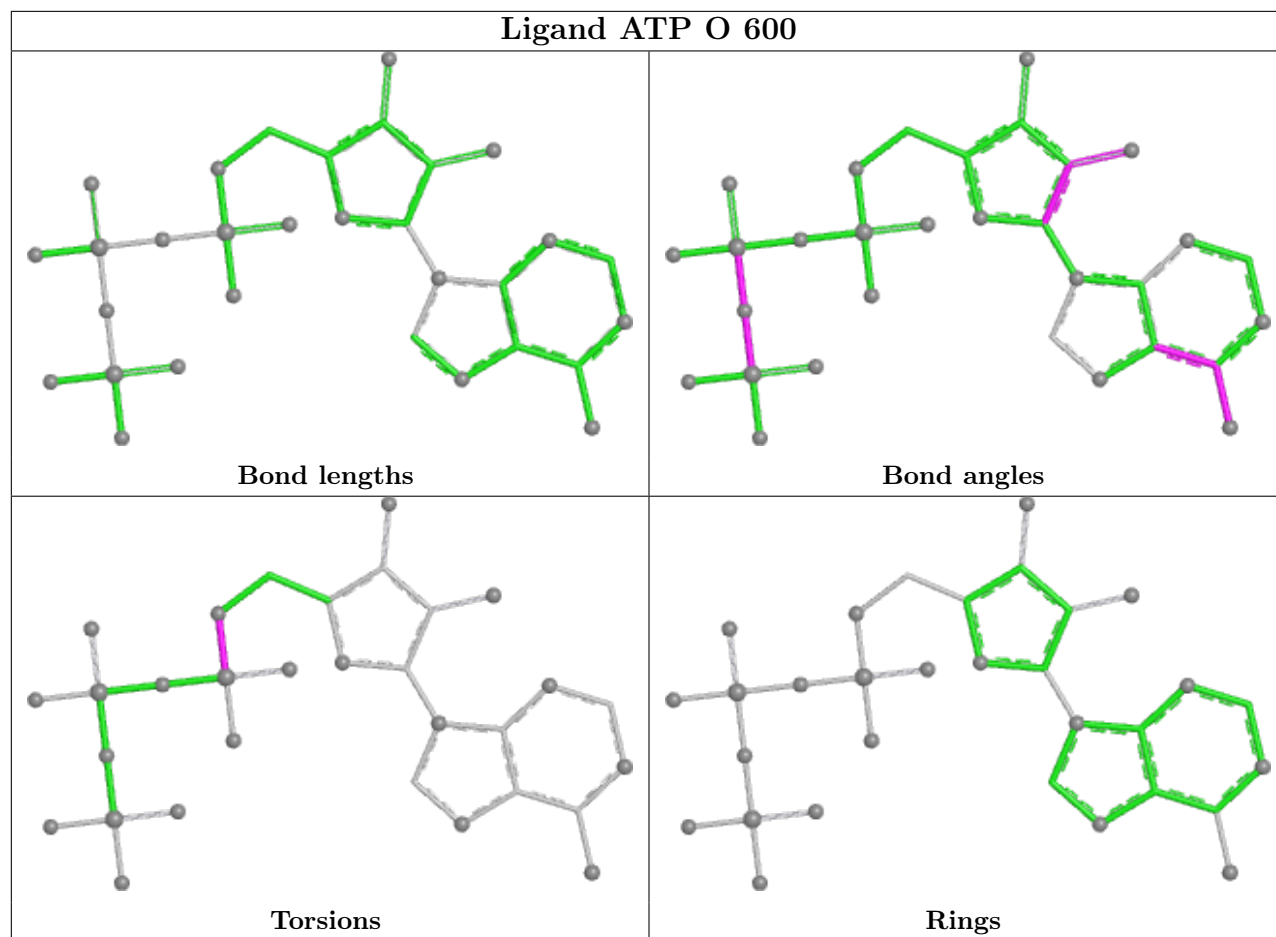

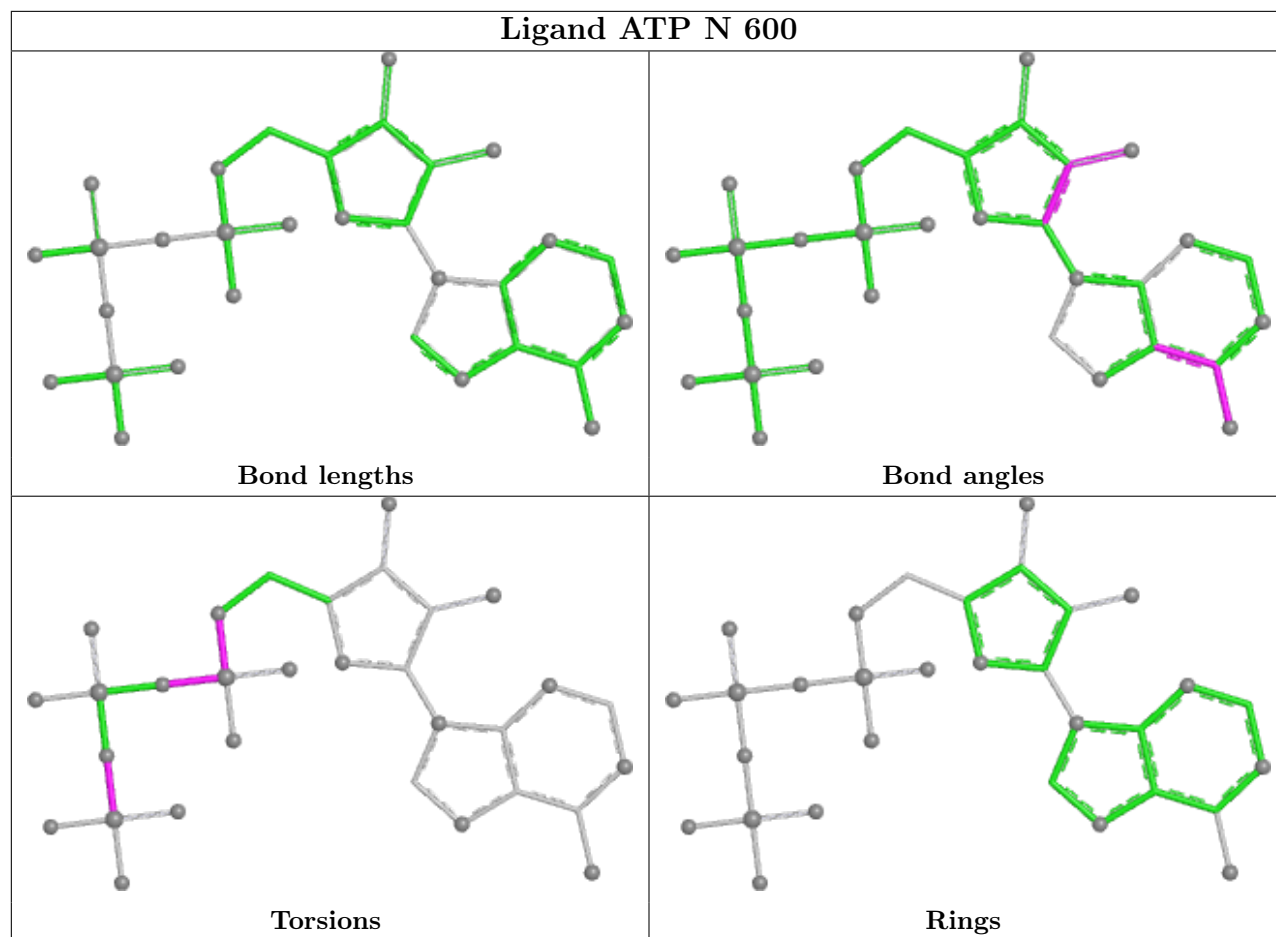

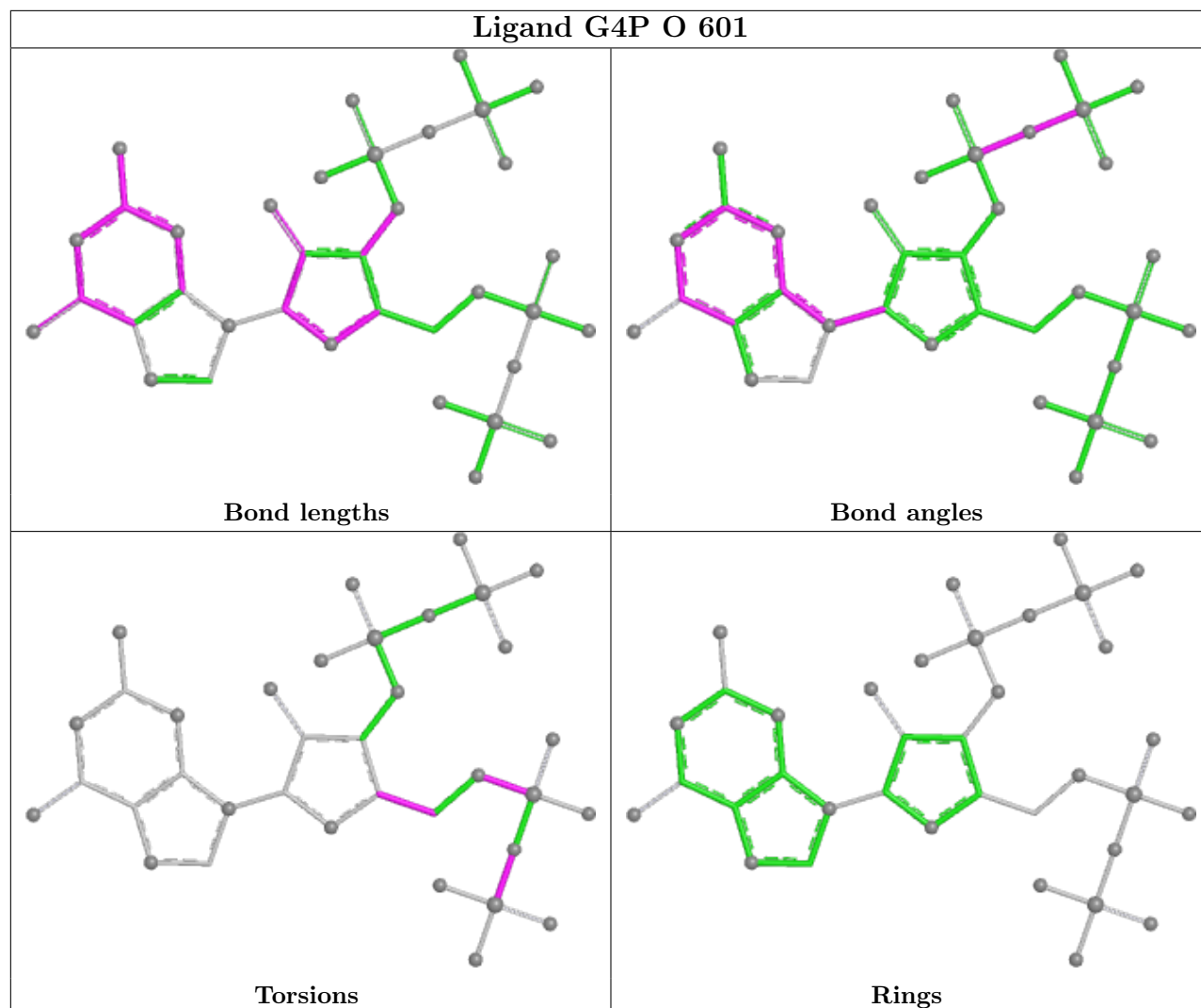

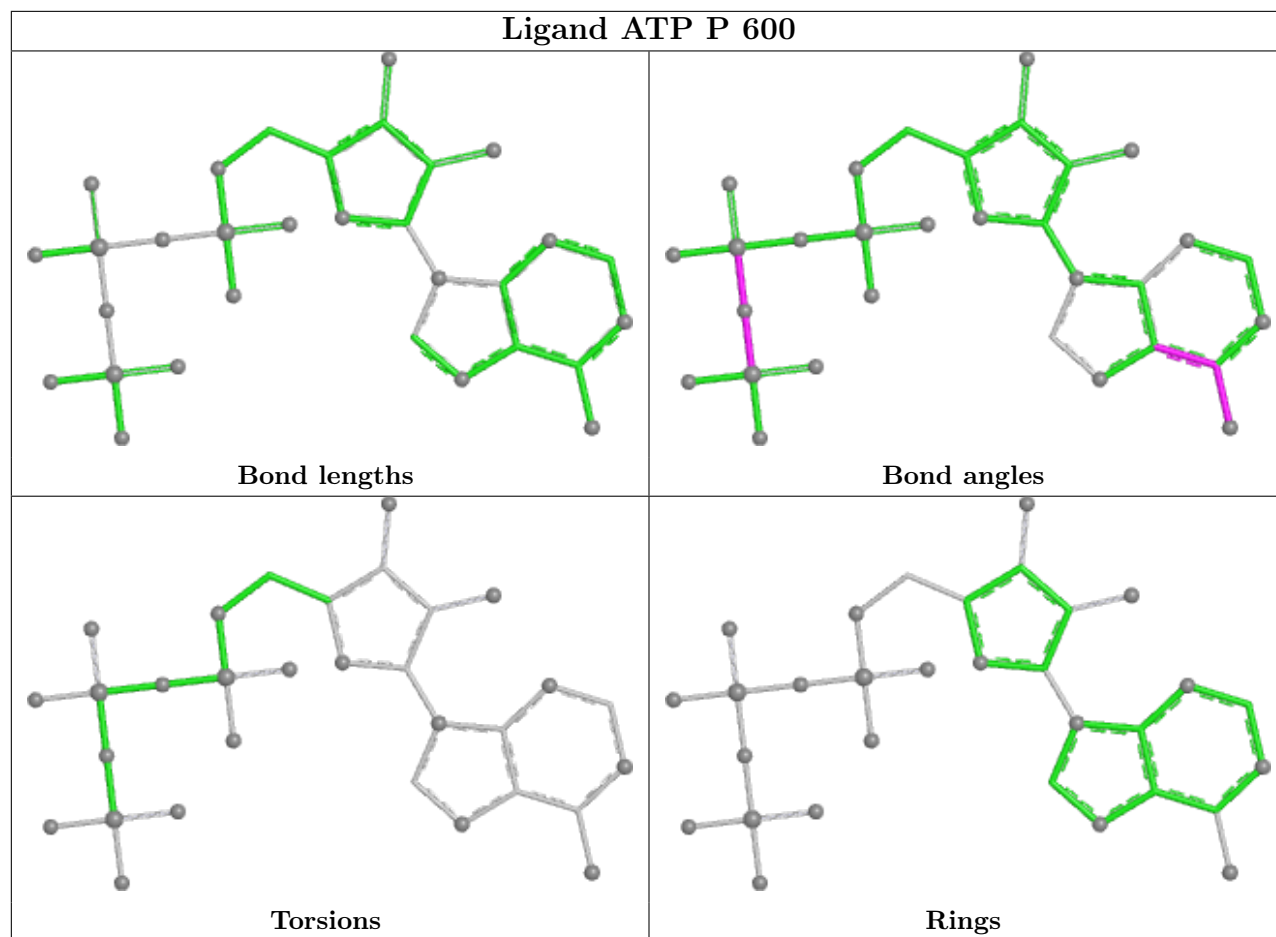

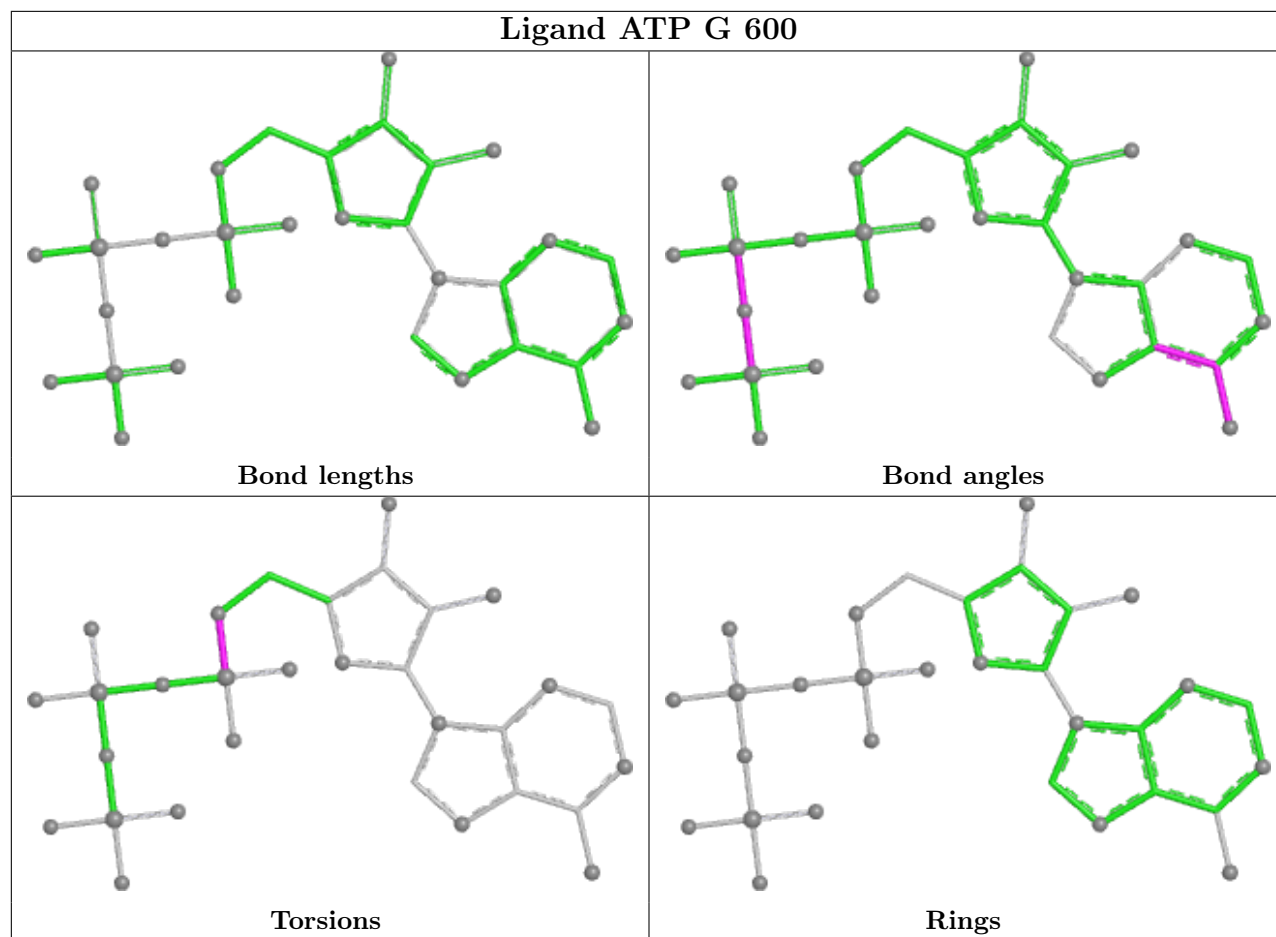



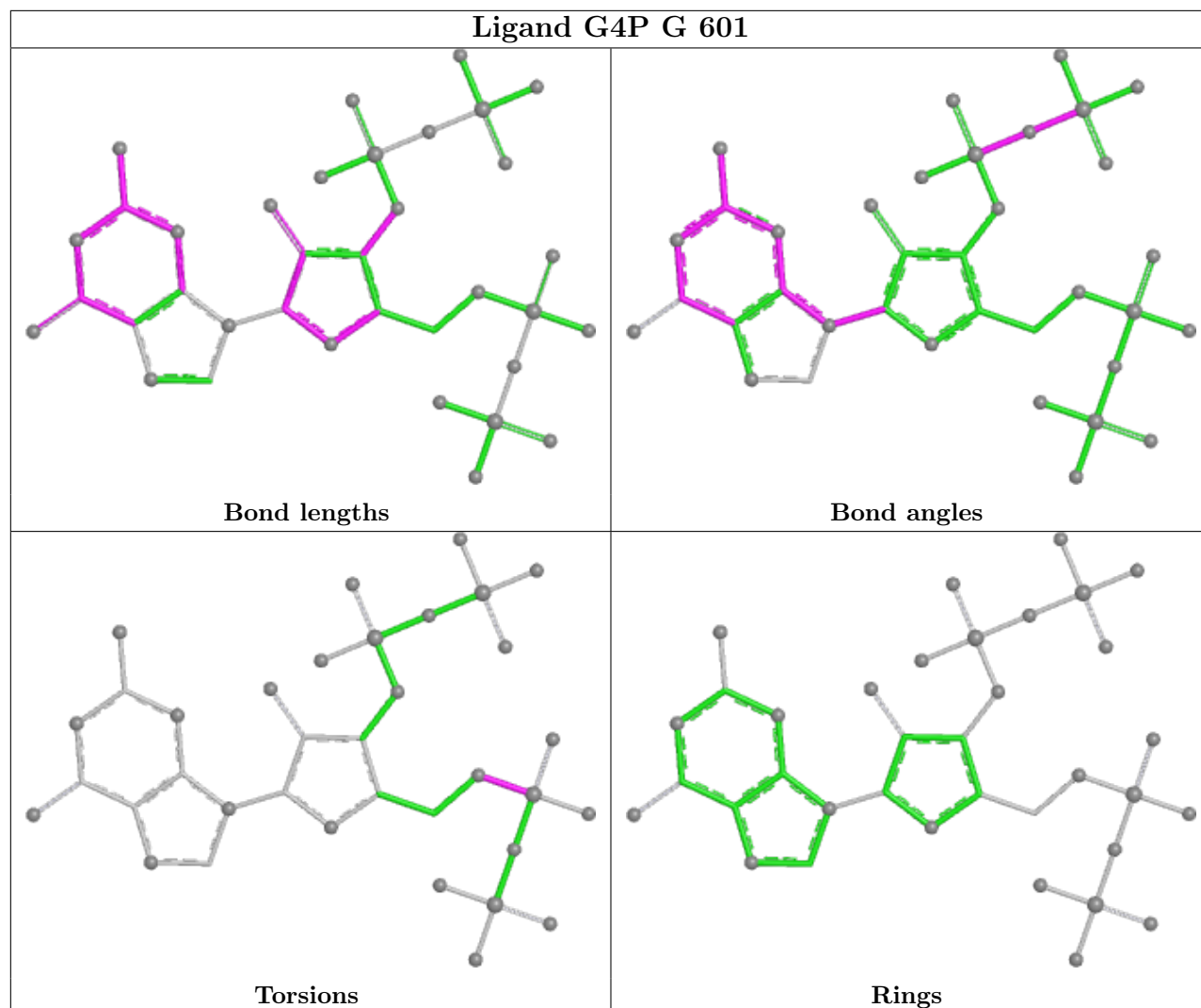

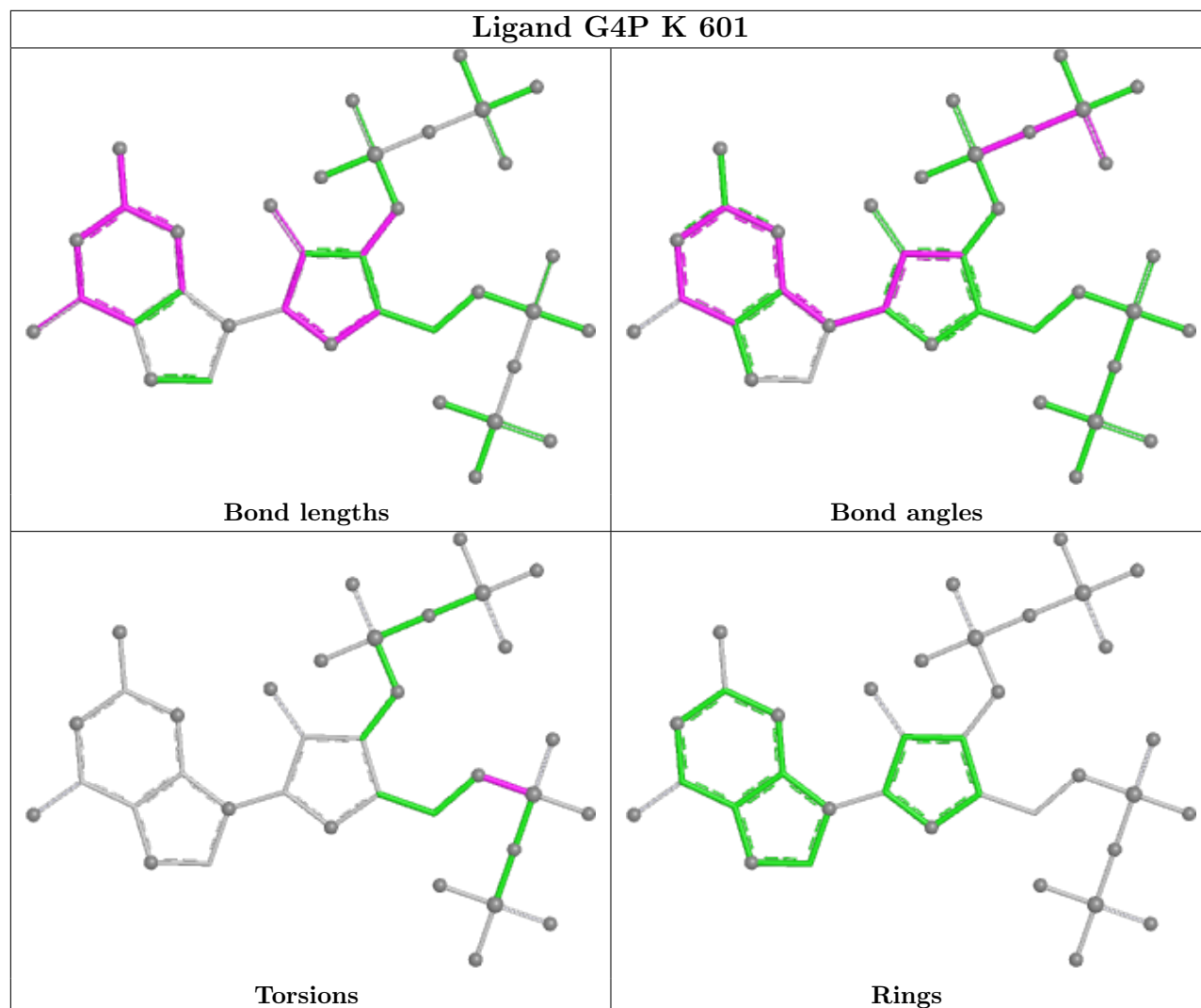

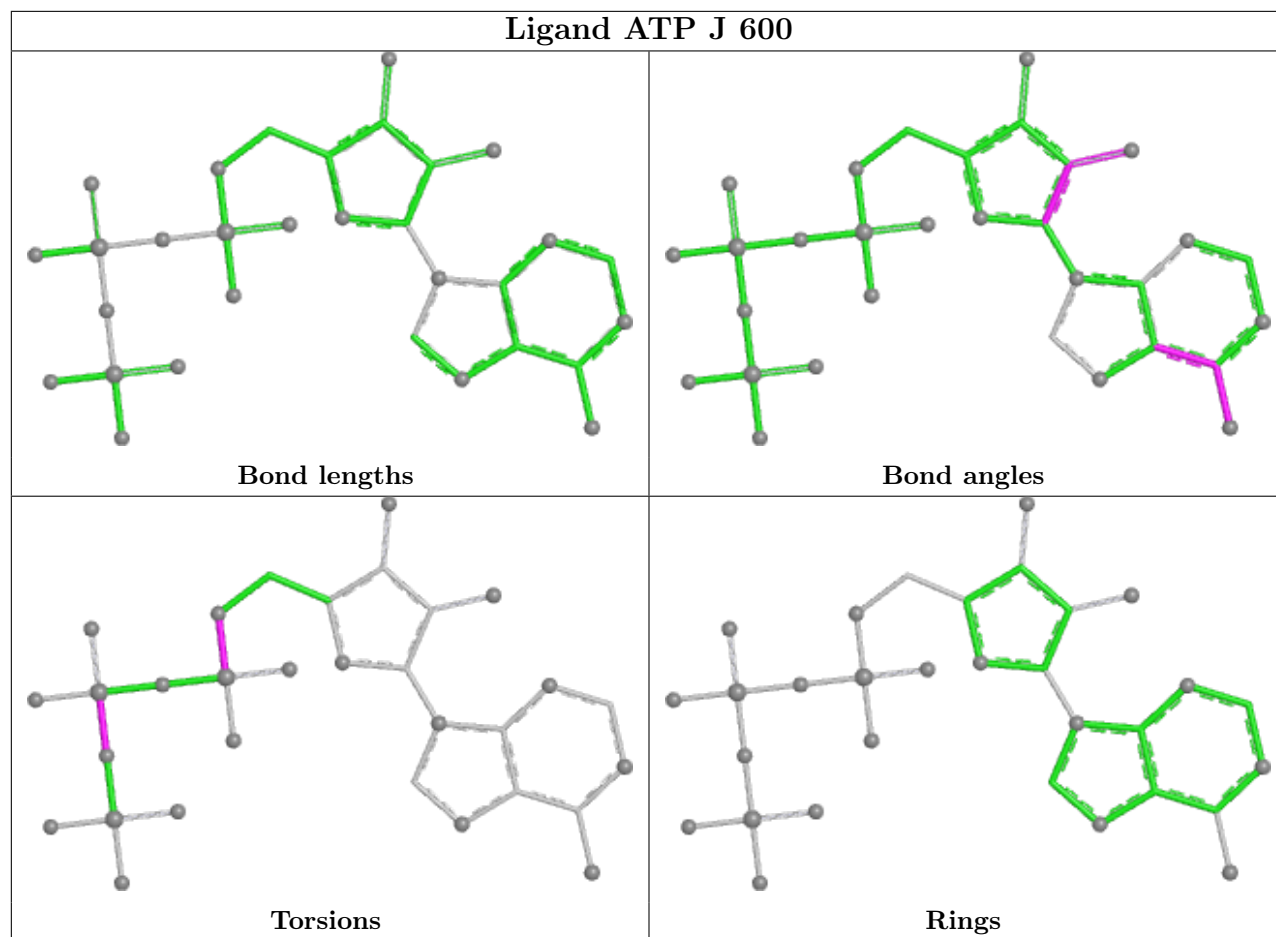

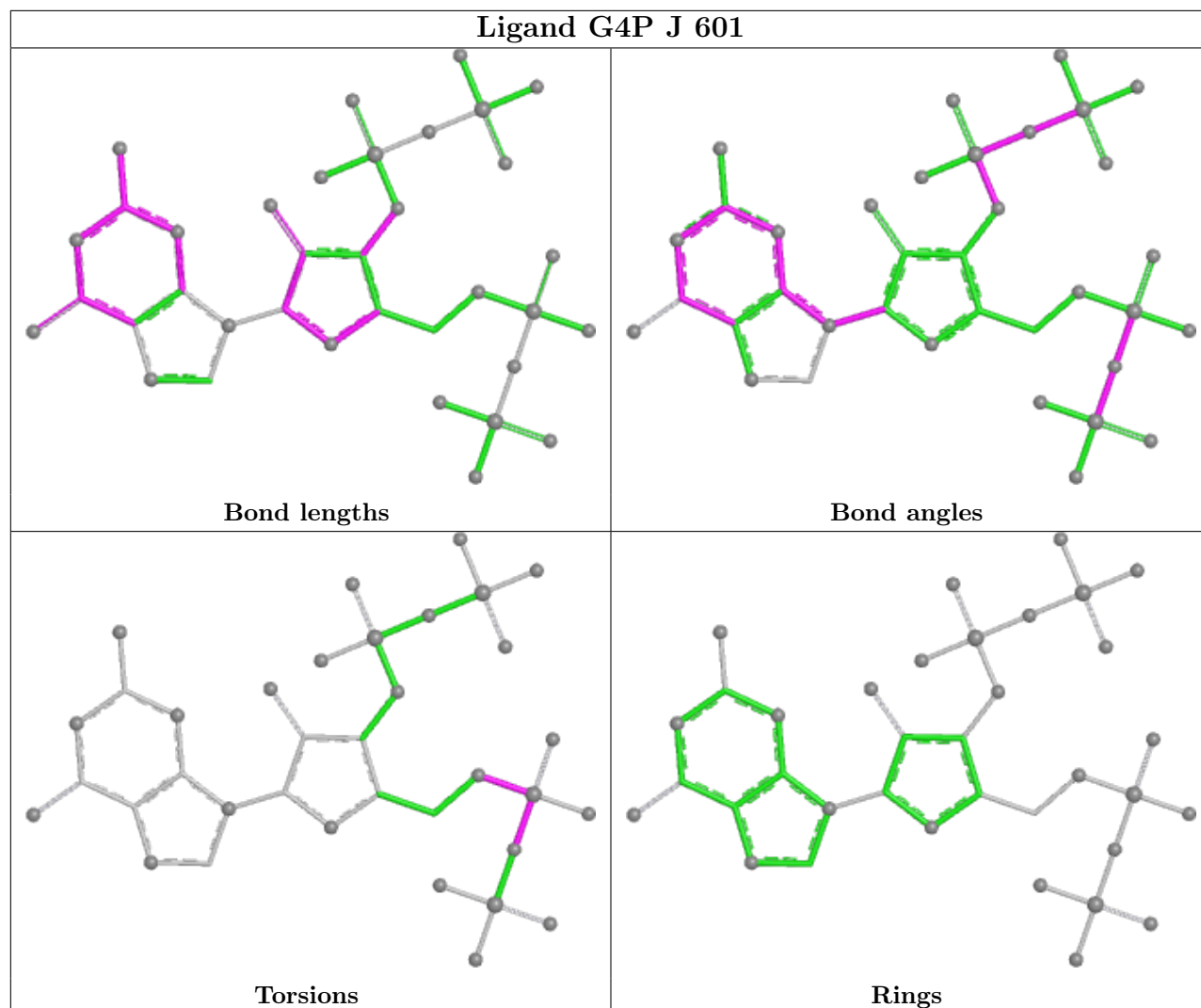

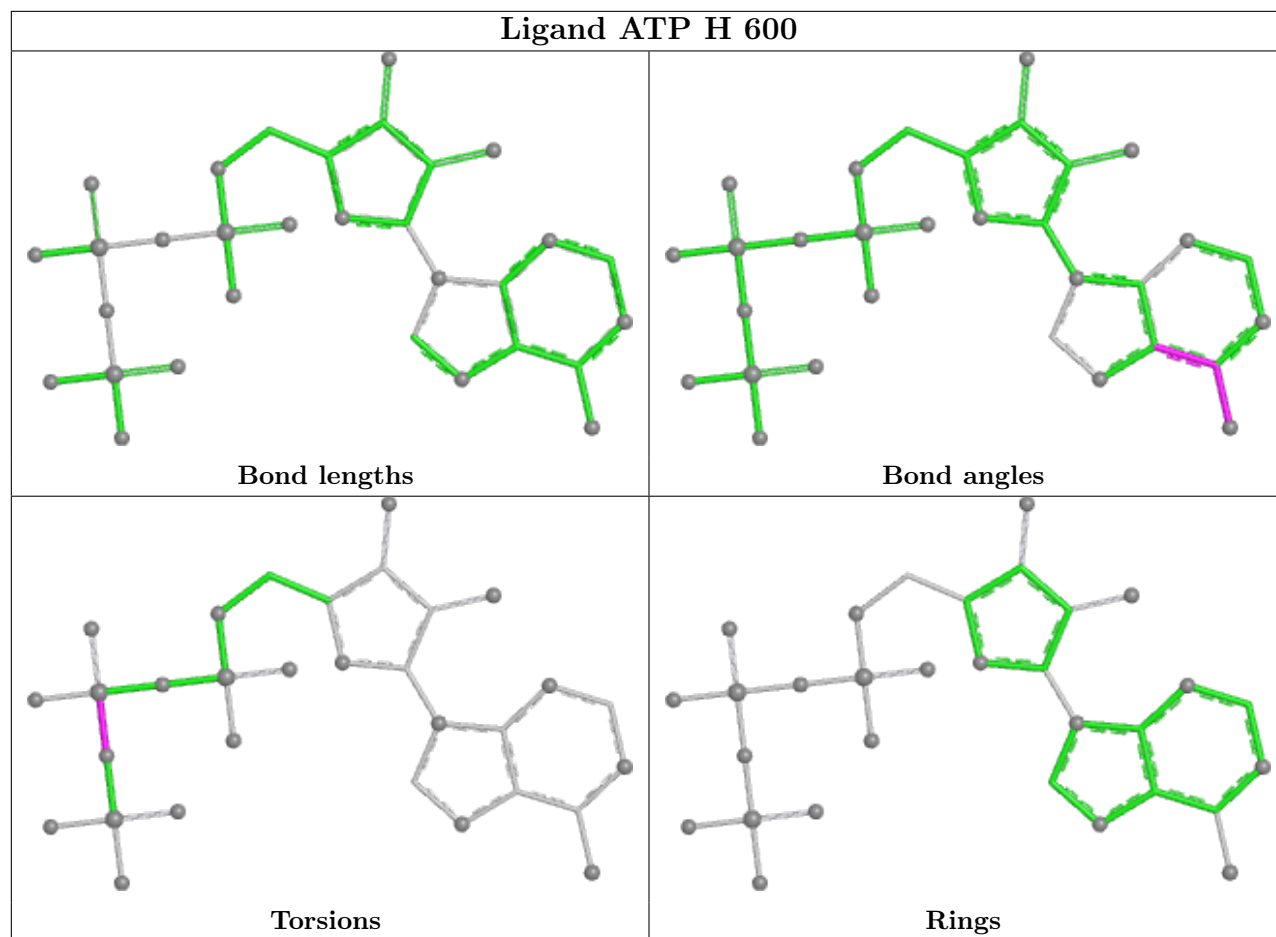

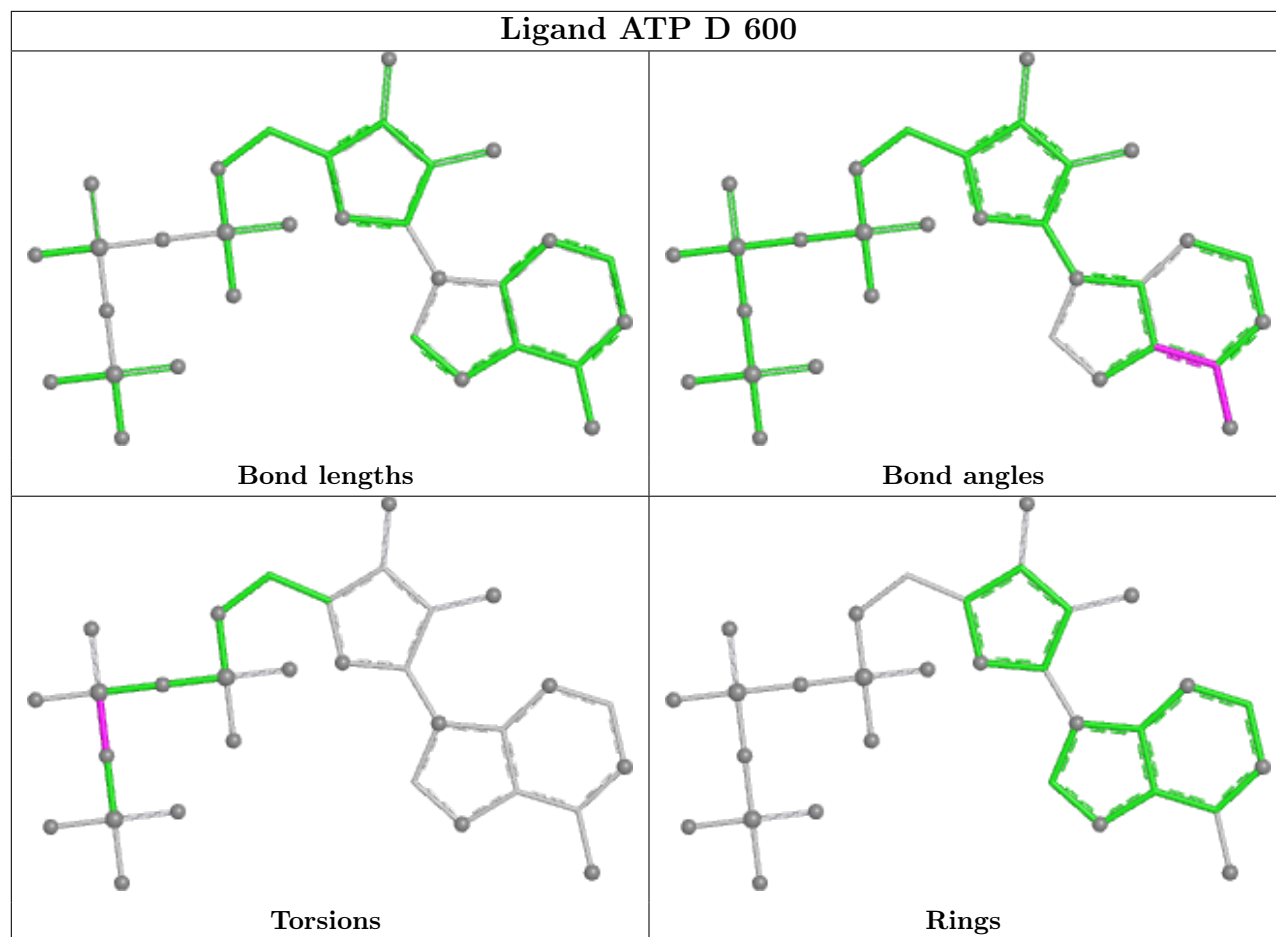

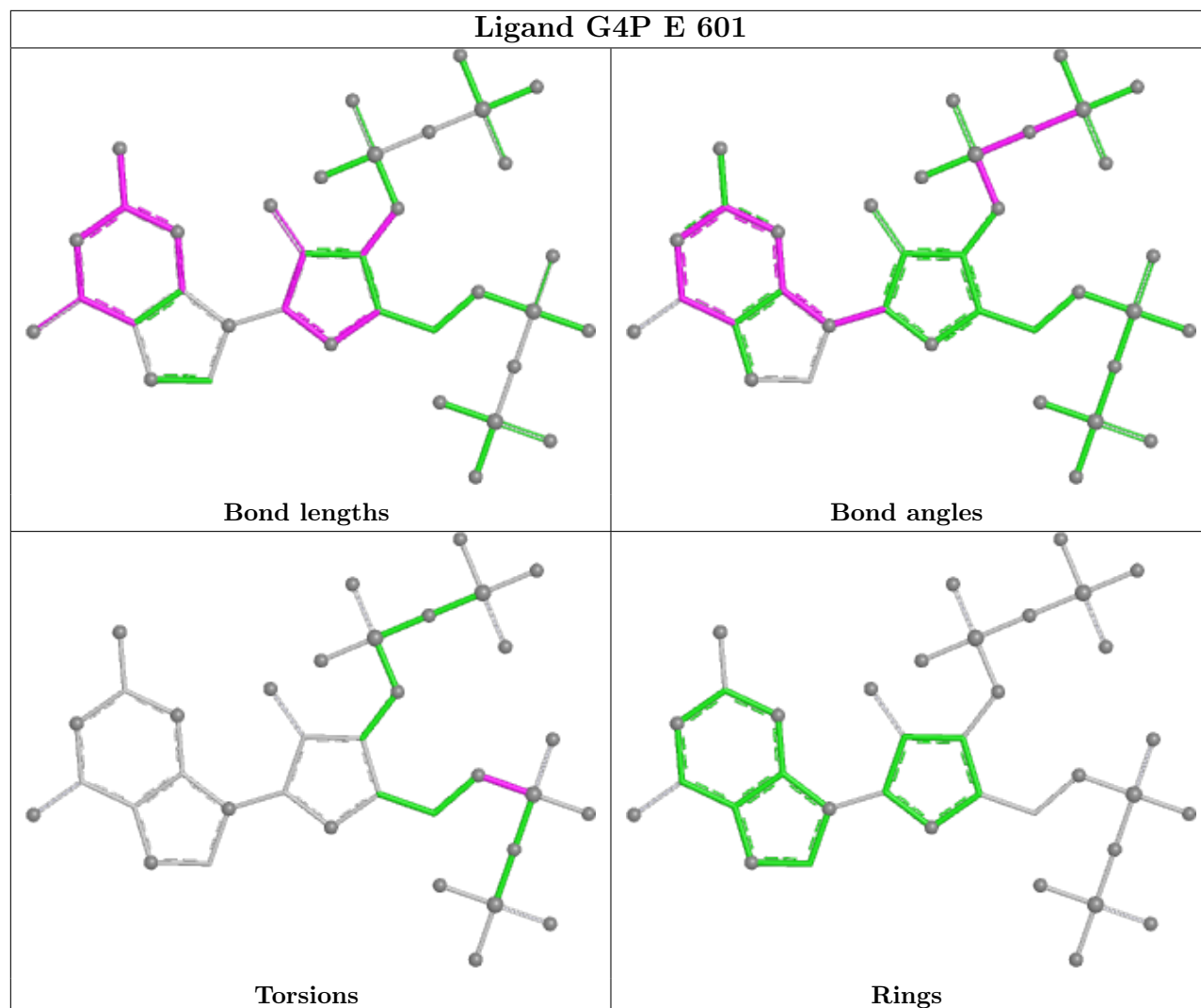

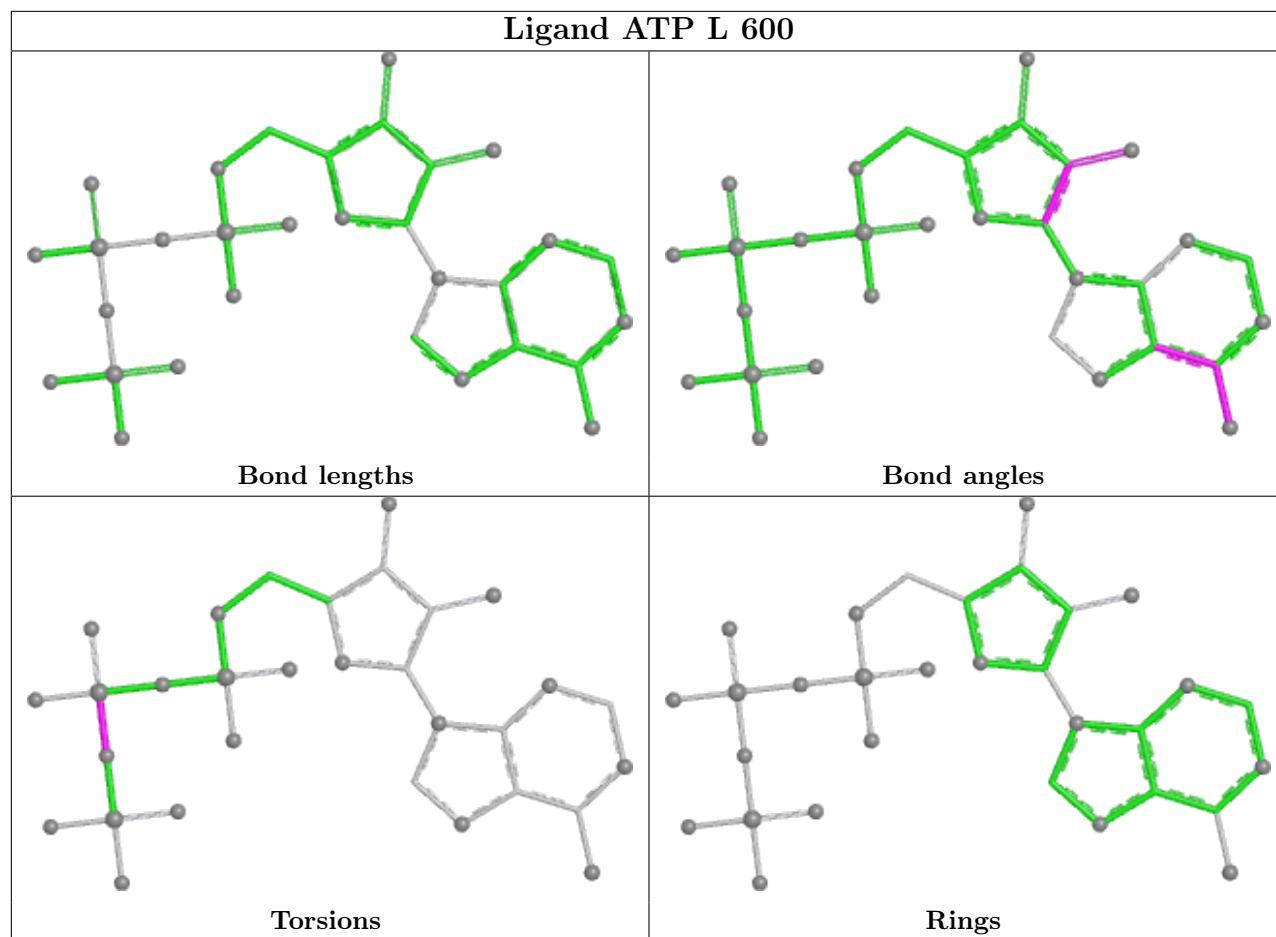



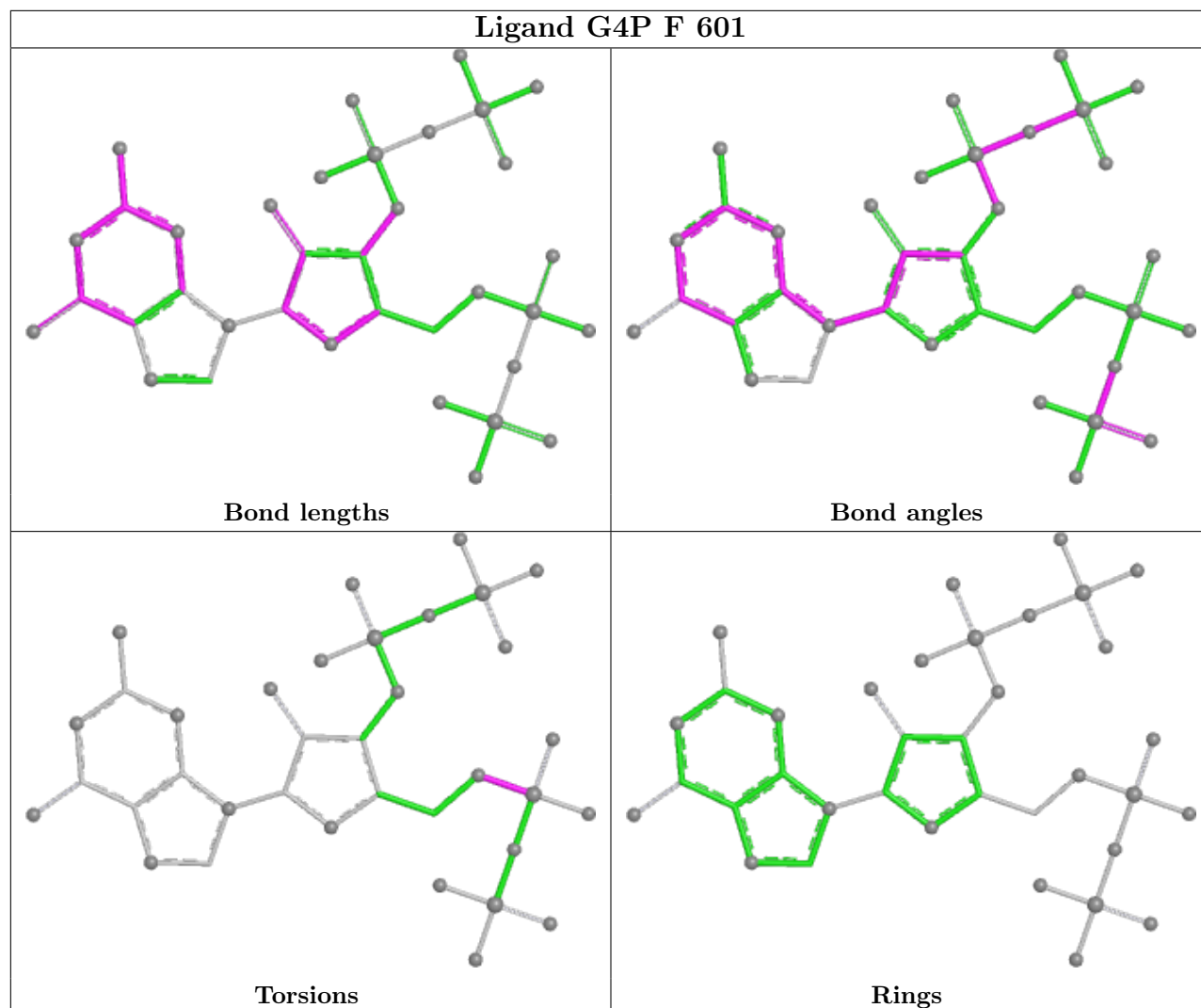

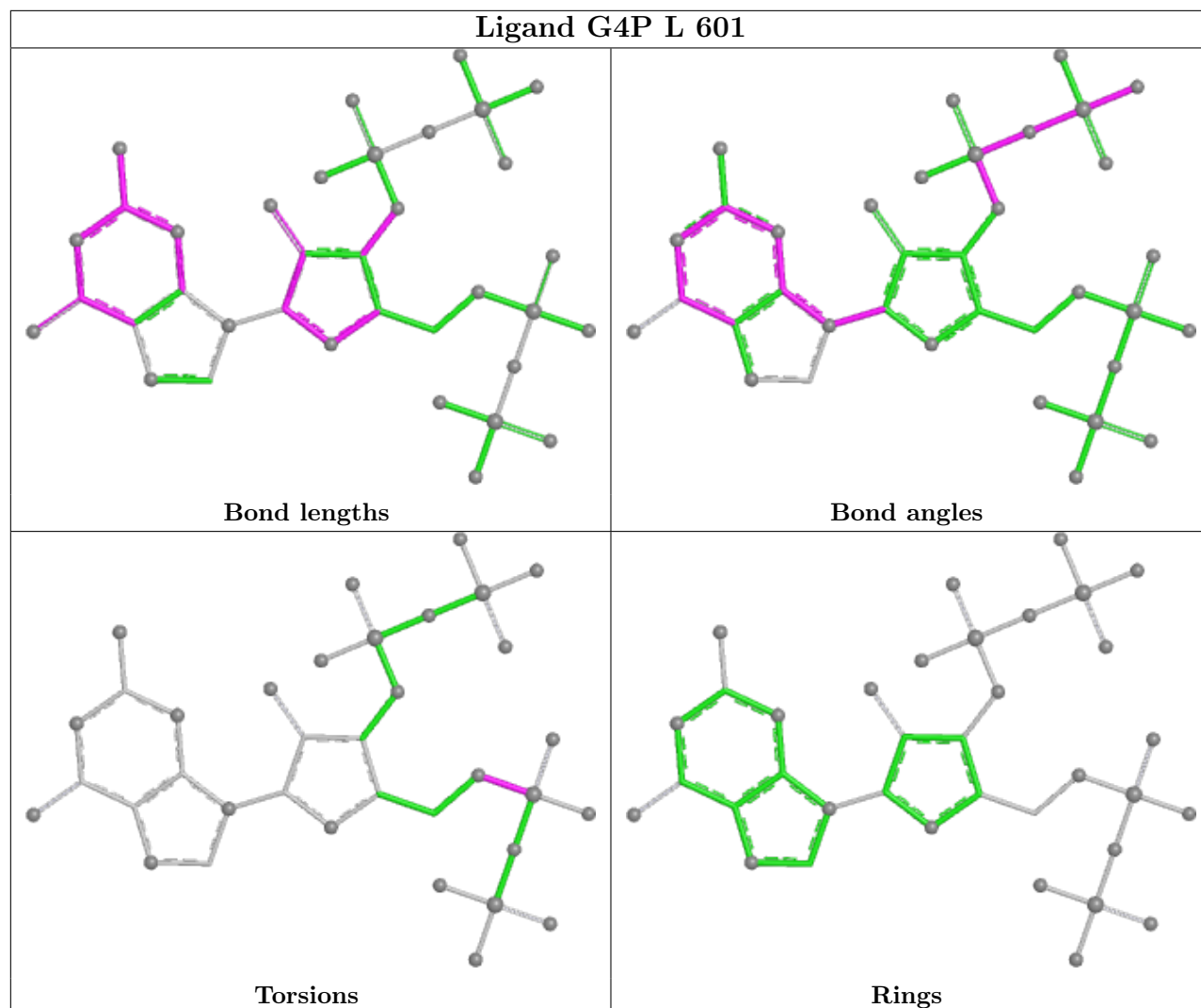

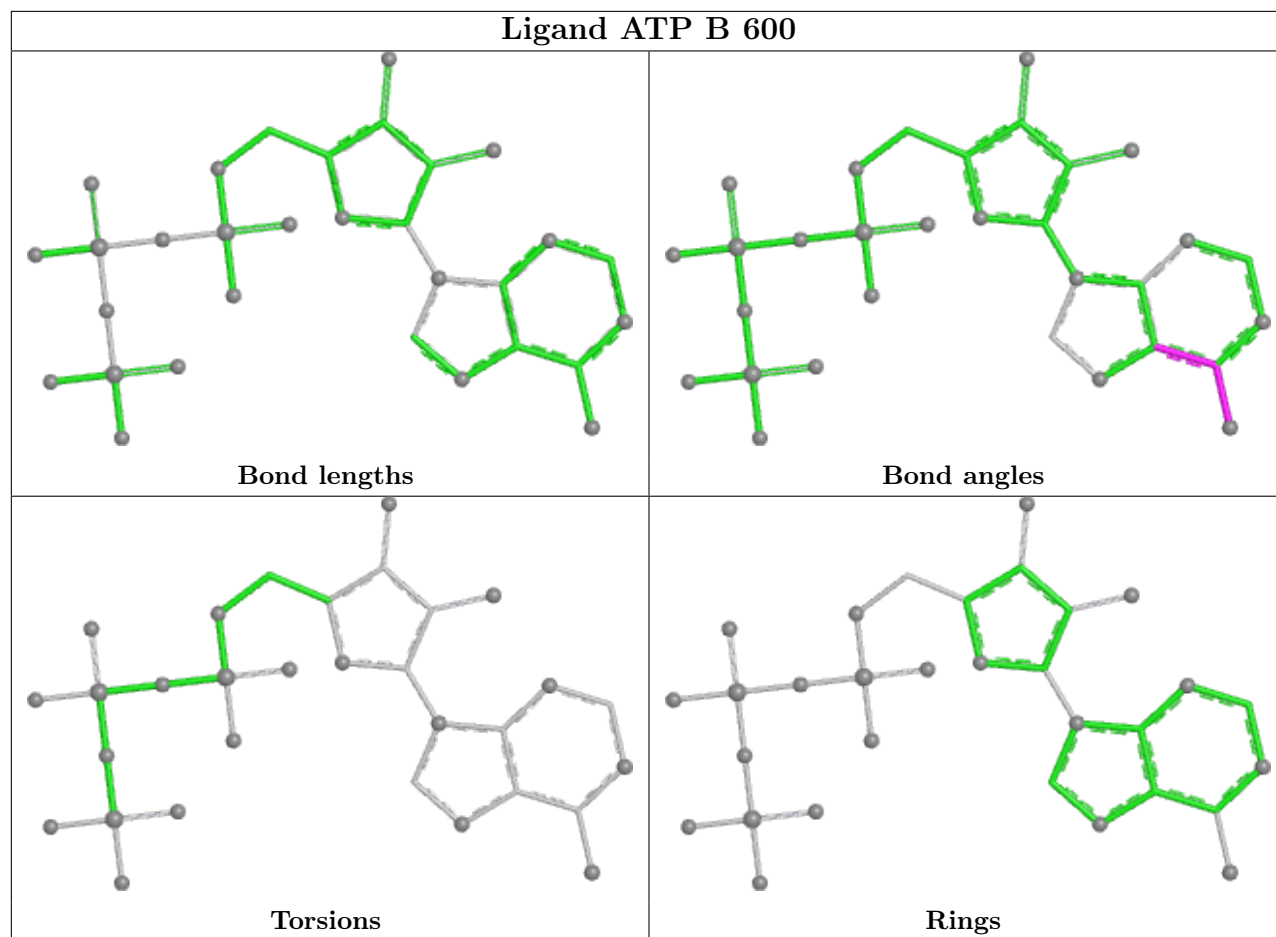

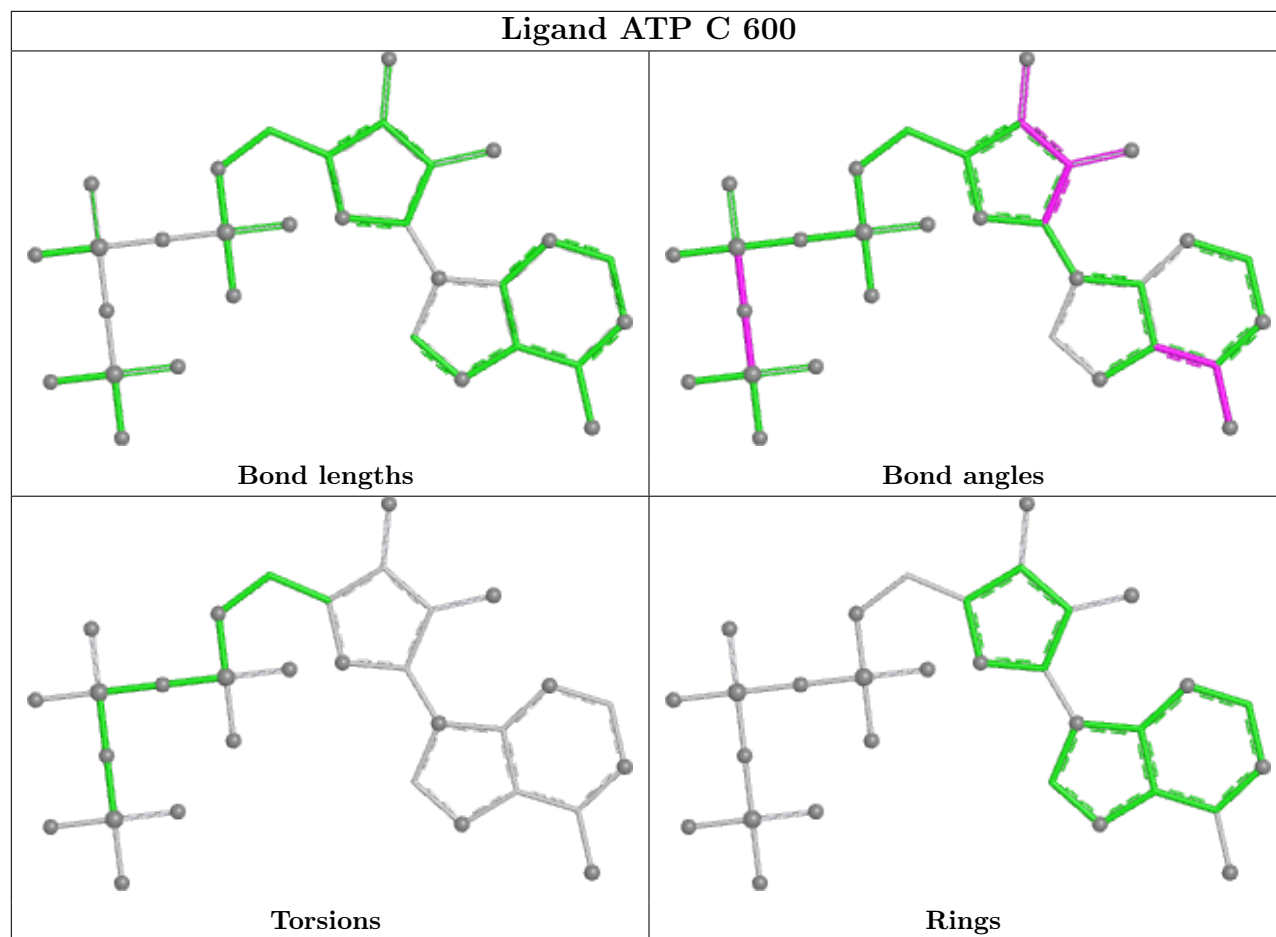

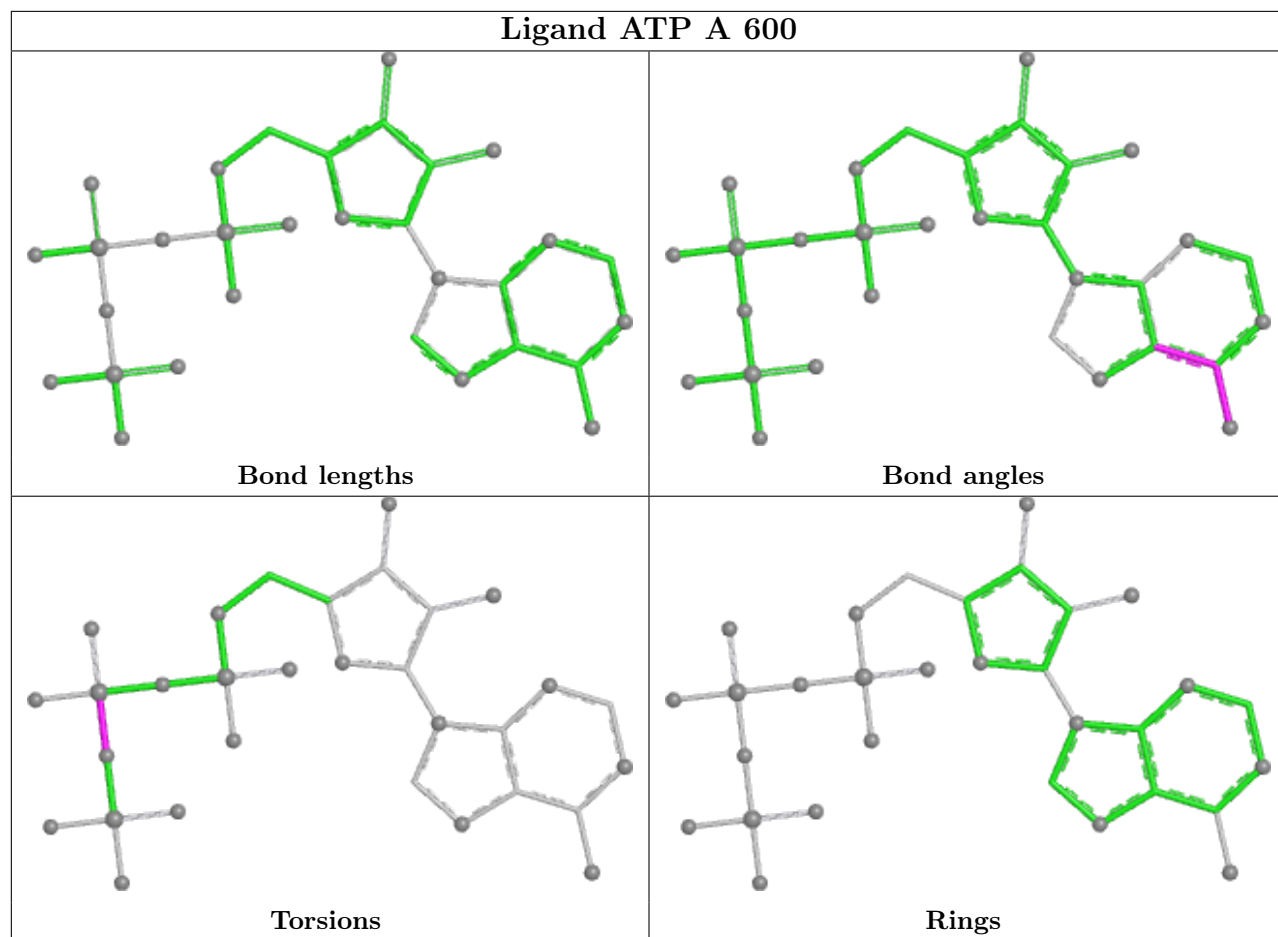

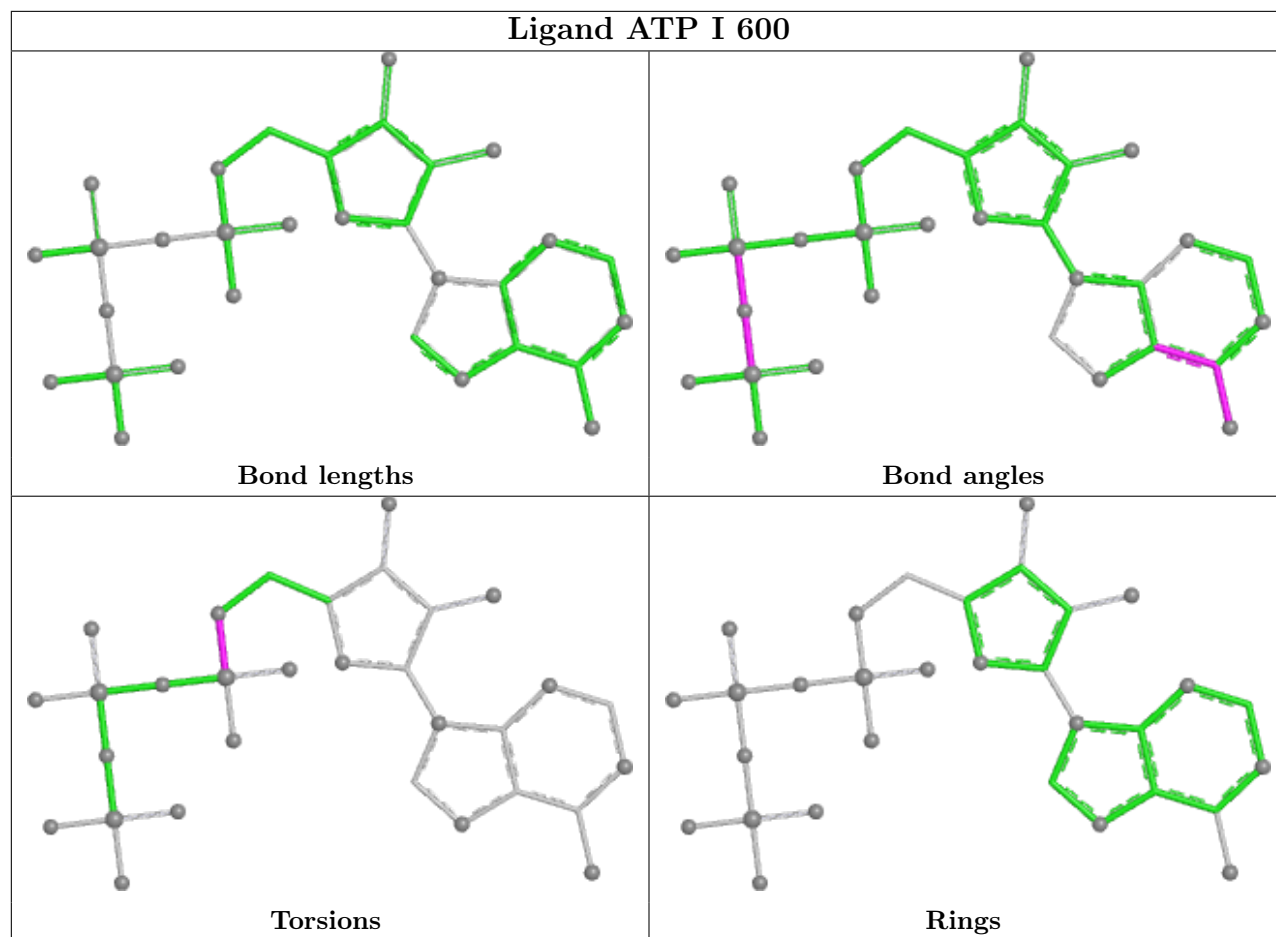

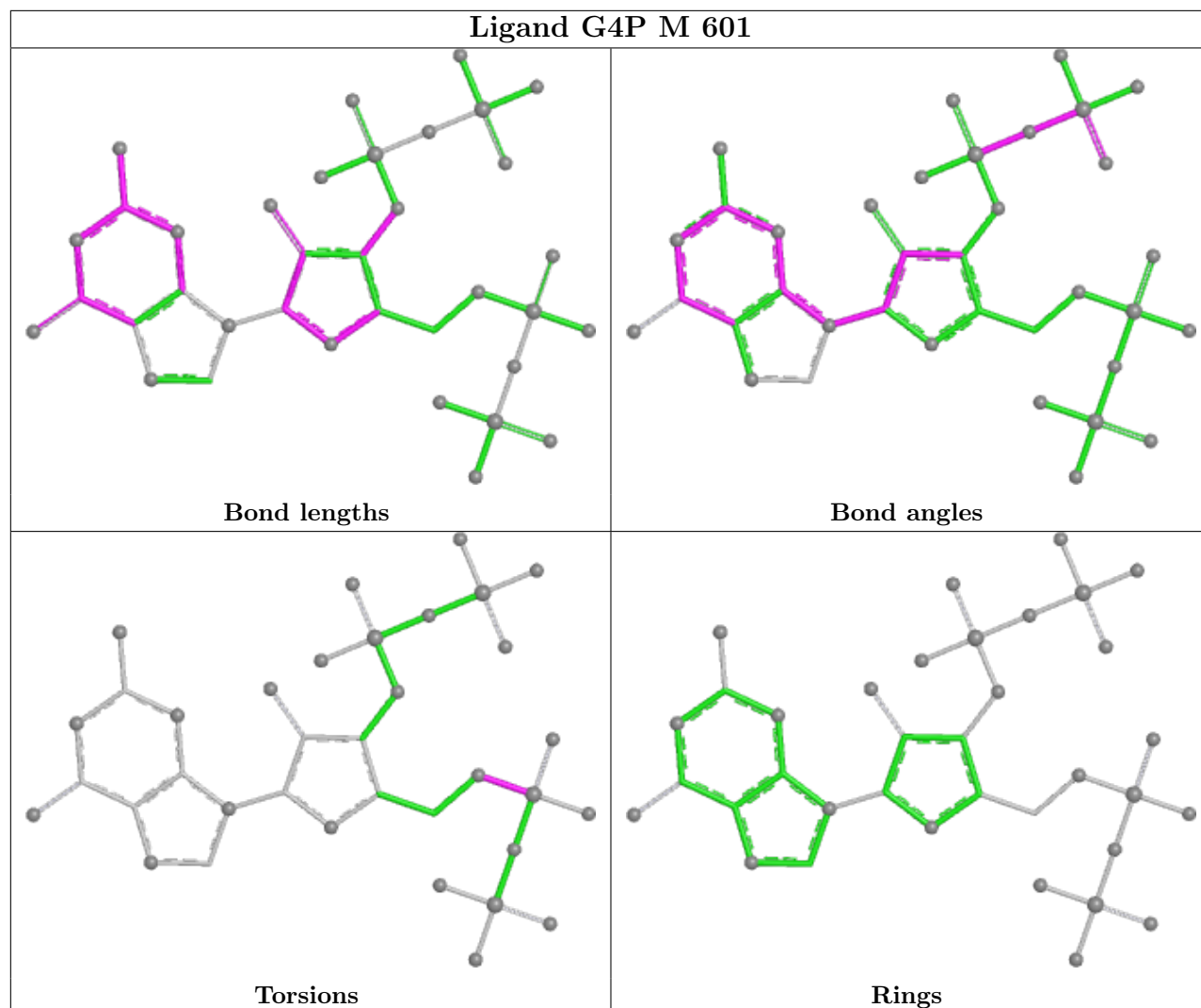

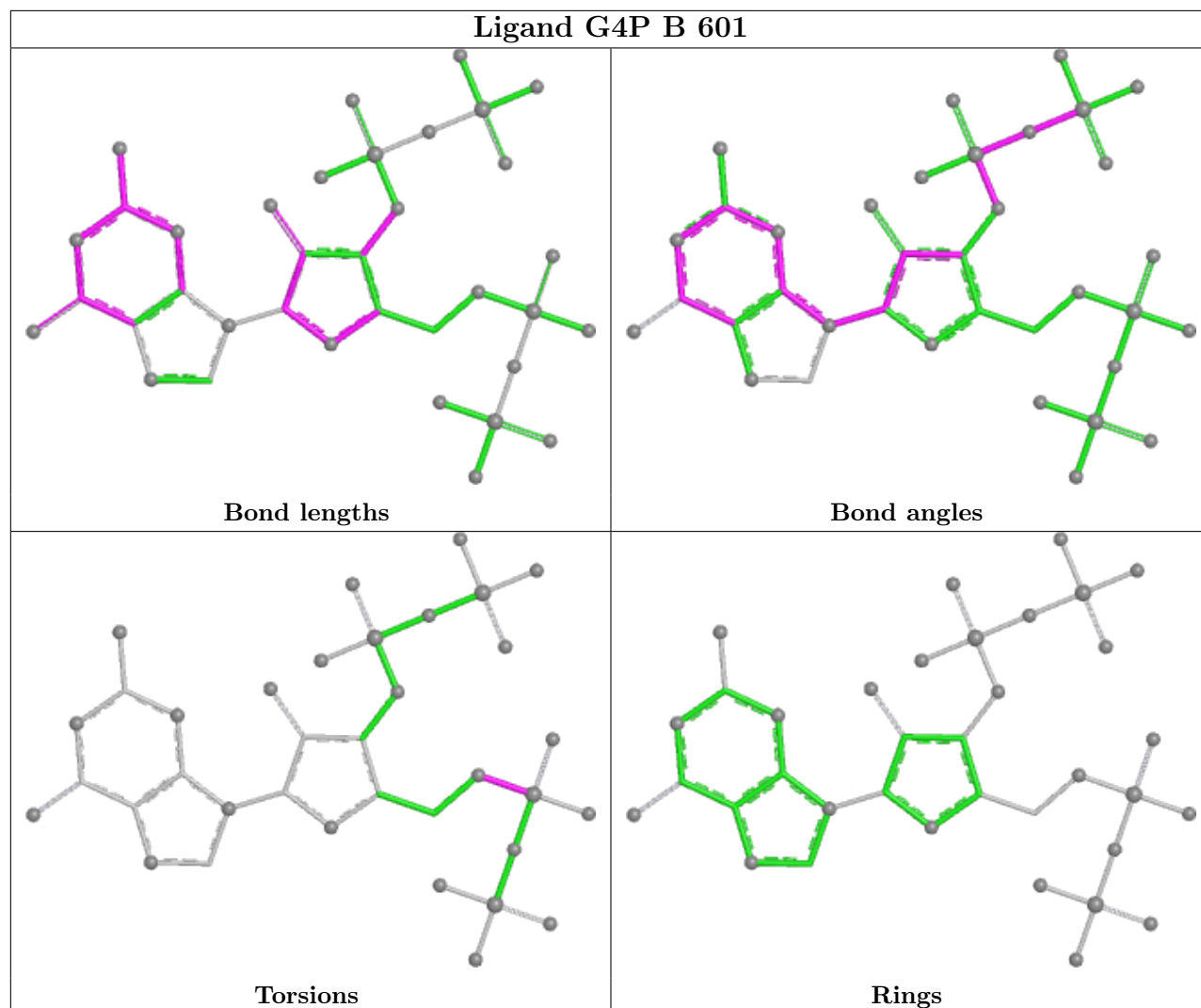



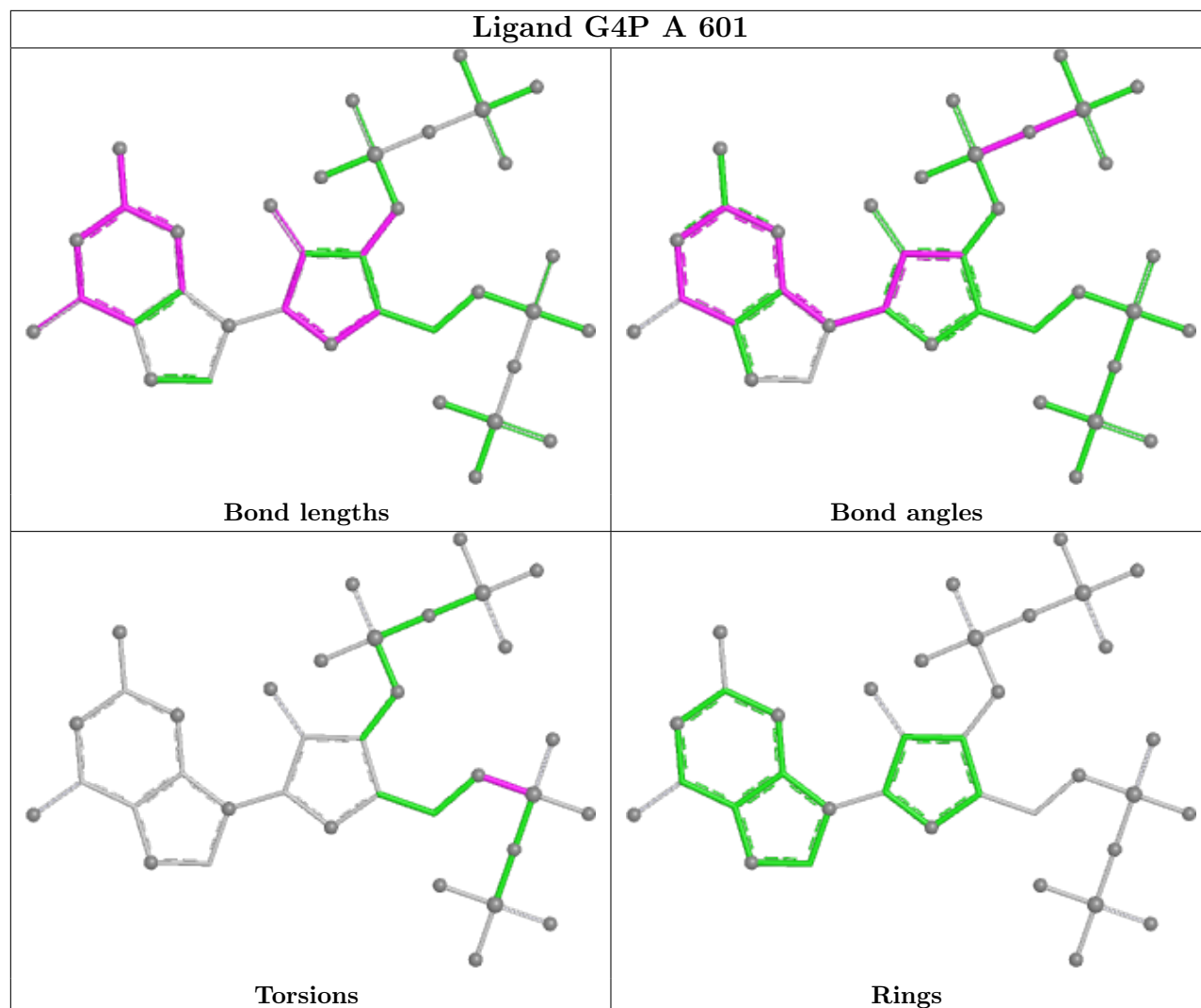

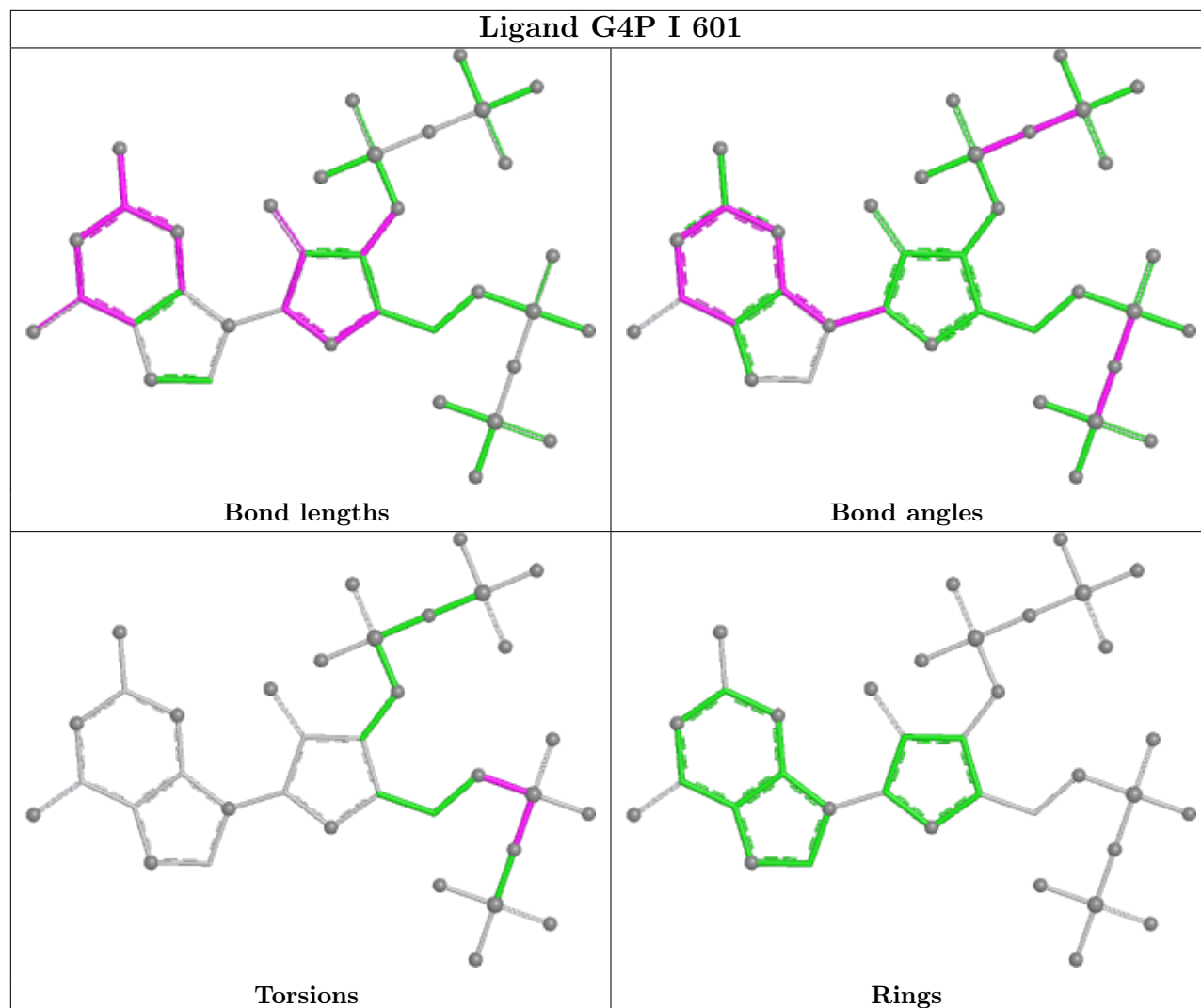

## 5.7 Other polymers [i](#)

There are no such residues in this entry.

## 5.8 Polymer linkage issues [i](#)

There are no chain breaks in this entry.

## 6 Fit of model and data [i](#)

### 6.1 Protein, DNA and RNA chains [i](#)

In the following table, the column labelled ‘#RSRZ > 2’ contains the number (and percentage) of RSRZ outliers, followed by percent RSRZ outliers for the chain as percentile scores relative to all X-ray entries and entries of similar resolution. The OWAB column contains the minimum, median, 95<sup>th</sup> percentile and maximum values of the occupancy-weighted average B-factor per residue. The column labelled ‘Q < 0.9’ lists the number of (and percentage) of residues with an average occupancy less than 0.9.

Mol	Chain	Analysed	<RSRZ>	#RSRZ>2	OWAB(Å <sup>2</sup> )	Q<0.9
1	A	428/504 (84%)	-0.28	1 (0%) 95 94	16, 32, 55, 69	0
1	B	430/504 (85%)	-0.13	4 (0%) 84 83	18, 33, 70, 80	0
1	C	427/504 (84%)	-0.13	5 (1%) 79 78	18, 33, 67, 81	0
1	D	428/504 (84%)	-0.24	1 (0%) 95 94	19, 33, 61, 81	0
1	E	428/504 (84%)	-0.21	2 (0%) 91 91	21, 31, 49, 68	0
1	F	428/504 (84%)	-0.24	2 (0%) 91 91	21, 32, 52, 71	0
1	G	426/504 (84%)	-0.17	3 (0%) 87 87	20, 37, 79, 93	0
1	H	428/504 (84%)	-0.24	2 (0%) 91 91	20, 33, 52, 71	0
1	I	427/504 (84%)	-0.14	3 (0%) 87 87	21, 39, 76, 92	0
1	J	428/504 (84%)	-0.18	1 (0%) 95 94	22, 39, 66, 78	0
1	K	428/504 (84%)	-0.22	1 (0%) 95 94	23, 35, 53, 64	0
1	L	427/504 (84%)	-0.25	1 (0%) 95 94	22, 34, 52, 66	0
1	M	428/504 (84%)	-0.29	1 (0%) 95 94	25, 37, 54, 65	0
1	N	428/504 (84%)	-0.17	4 (0%) 84 83	27, 42, 64, 78	0
1	O	425/504 (84%)	-0.09	6 (1%) 75 74	27, 44, 76, 90	0
1	P	428/504 (84%)	-0.13	3 (0%) 87 87	27, 42, 73, 94	0
All	All	6842/8064 (84%)	-0.19	40 (0%) 89 89	16, 36, 66, 94	0

All (40) RSRZ outliers are listed below:

Mol	Chain	Res	Type	RSRZ
1	B	181	LEU	4.1
1	C	382	PHE	3.8
1	P	382	PHE	3.8
1	P	388	PHE	3.8
1	C	380	LEU	3.2

*Continued on next page...*

*Continued from previous page...*

Mol	Chain	Res	Type	RSRZ
1	B	126	ILE	3.2
1	N	434	VAL	3.2
1	N	382	PHE	3.1
1	O	149	PHE	3.0
1	N	149	PHE	2.9
1	G	115	GLY	2.9
1	H	153	ARG	2.9
1	F	388	PHE	2.7
1	J	388	PHE	2.6
1	F	382	PHE	2.5
1	K	382	PHE	2.5
1	B	134	GLY	2.4
1	E	382	PHE	2.4
1	M	434	VAL	2.4
1	O	389	LYS	2.4
1	E	434	VAL	2.3
1	I	384	ASN	2.3
1	A	369	LEU	2.3
1	C	434	VAL	2.2
1	O	434	VAL	2.2
1	L	349	TYR	2.2
1	O	382	PHE	2.2
1	G	108	ILE	2.2
1	I	135	ALA	2.1
1	O	157	VAL	2.1
1	C	349	TYR	2.1
1	G	114	LEU	2.1
1	C	160	VAL	2.1
1	D	134	GLY	2.1
1	H	388	PHE	2.1
1	I	166	LEU	2.0
1	P	380	LEU	2.0
1	N	388	PHE	2.0
1	B	385	GLY	2.0
1	O	160	VAL	2.0

## 6.2 Non-standard residues in protein, DNA, RNA chains

There are no non-standard protein/DNA/RNA residues in this entry.

### 6.3 Carbohydrates [i](#)

There are no monosaccharides in this entry.

### 6.4 Ligands [i](#)

In the following table, the Atoms column lists the number of modelled atoms in the group and the number defined in the chemical component dictionary. The B-factors column lists the minimum, median, 95<sup>th</sup> percentile and maximum values of B factors of atoms in the group. The column labelled 'Q< 0.9' lists the number of atoms with occupancy less than 0.9.

Mol	Type	Chain	Res	Atoms	RSCC	RSR	B-factors(Å <sup>2</sup> )	Q<0.9
4	MG	N	603	1/1	0.92	0.16	45,45,45,45	0
4	MG	G	602	1/1	0.93	0.17	45,45,45,45	0
4	MG	P	602	1/1	0.93	0.13	41,41,41,41	0
2	ATP	N	600	31/31	0.95	0.14	30,42,56,76	0
4	MG	G	603	1/1	0.95	0.15	40,40,40,40	0
2	ATP	G	600	31/31	0.96	0.13	34,49,63,68	0
4	MG	I	602	1/1	0.96	0.13	45,45,45,45	0
3	G4P	J	601	36/36	0.97	0.11	32,47,58,69	0
3	G4P	O	601	36/36	0.97	0.11	39,52,63,73	0
4	MG	B	603	1/1	0.97	0.14	36,36,36,36	0
2	ATP	B	600	31/31	0.97	0.11	34,49,63,71	0
2	ATP	I	600	31/31	0.97	0.13	40,57,71,72	0
2	ATP	J	600	31/31	0.97	0.12	33,43,55,60	0
2	ATP	C	600	31/31	0.97	0.14	32,54,69,77	0
4	MG	O	602	1/1	0.97	0.17	45,45,45,45	0
2	ATP	O	600	31/31	0.97	0.12	42,58,73,77	0
3	G4P	E	601	36/36	0.98	0.12	18,28,43,72	0
3	G4P	F	601	36/36	0.98	0.13	18,31,45,62	0
3	G4P	G	601	36/36	0.98	0.11	34,45,70,74	0
3	G4P	H	601	36/36	0.98	0.12	23,32,46,68	0
3	G4P	I	601	36/36	0.98	0.10	37,49,60,68	0
2	ATP	F	600	31/31	0.98	0.13	14,25,31,40	0
3	G4P	K	601	36/36	0.98	0.12	22,31,45,75	0
3	G4P	M	601	36/36	0.98	0.12	23,33,46,56	0
3	G4P	N	601	36/36	0.98	0.11	31,43,60,77	0
2	ATP	M	600	31/31	0.98	0.12	19,28,37,41	0
3	G4P	P	601	36/36	0.98	0.11	35,44,55,69	0
4	MG	B	602	1/1	0.98	0.10	35,35,35,35	0
2	ATP	A	600	31/31	0.98	0.12	20,28,44,49	0
4	MG	C	602	1/1	0.98	0.12	38,38,38,38	0
4	MG	C	603	1/1	0.98	0.11	38,38,38,38	0
4	MG	D	603	1/1	0.98	0.15	26,26,26,26	0

*Continued on next page...*

*Continued from previous page...*

Mol	Type	Chain	Res	Atoms	RSCC	RSR	B-factors(Å <sup>2</sup> )	Q<0.9
4	MG	E	602	1/1	0.98	0.14	23,23,23,23	0
4	MG	F	603	1/1	0.98	0.17	22,22,22,22	0
2	ATP	D	600	31/31	0.98	0.12	21,36,51,59	0
2	ATP	P	600	31/31	0.98	0.10	29,52,70,76	0
4	MG	H	603	1/1	0.98	0.14	26,26,26,26	0
3	G4P	A	601	36/36	0.98	0.12	22,33,47,70	0
4	MG	J	602	1/1	0.98	0.14	41,41,41,41	0
4	MG	M	603	1/1	0.98	0.17	25,25,25,25	0
4	MG	N	602	1/1	0.98	0.12	35,35,35,35	0
3	G4P	B	601	36/36	0.98	0.11	30,40,55,65	0
3	G4P	C	601	36/36	0.98	0.12	34,41,54,67	0
4	MG	O	603	1/1	0.98	0.18	43,43,43,43	0
3	G4P	D	601	36/36	0.98	0.12	22,34,47,70	0
4	MG	P	603	1/1	0.98	0.14	37,37,37,37	0
2	ATP	E	600	31/31	0.99	0.12	15,25,30,35	0
2	ATP	H	600	31/31	0.99	0.12	20,27,33,40	0
4	MG	I	603	1/1	0.99	0.13	46,46,46,46	0
2	ATP	K	600	31/31	0.99	0.13	20,29,38,48	0
4	MG	J	603	1/1	0.99	0.13	42,42,42,42	0
4	MG	K	602	1/1	0.99	0.16	23,23,23,23	0
4	MG	K	603	1/1	0.99	0.15	25,25,25,25	0
4	MG	L	602	1/1	0.99	0.18	24,24,24,24	0
4	MG	L	603	1/1	0.99	0.16	23,23,23,23	0
4	MG	M	602	1/1	0.99	0.16	24,24,24,24	0
4	MG	A	602	1/1	0.99	0.14	27,27,27,27	0
4	MG	E	603	1/1	0.99	0.13	23,23,23,23	0
4	MG	F	602	1/1	0.99	0.13	25,25,25,25	0
4	MG	A	603	1/1	0.99	0.12	25,25,25,25	0
3	G4P	L	601	36/36	0.99	0.12	20,32,47,68	0
2	ATP	L	600	31/31	0.99	0.12	17,27,32,34	0
4	MG	H	602	1/1	0.99	0.13	23,23,23,23	0
4	MG	D	602	1/1	1.00	0.15	24,24,24,24	0

The following is a graphical depiction of the model fit to experimental electron density of all instances of the Ligand of Interest. In addition, ligands with molecular weight > 250 and outliers as shown on the geometry validation Tables will also be included. Each fit is shown from different orientation to approximate a three-dimensional view.

**Electron density around MG N 603:**

$2mF_o-DF_c$  (at 0.7 rmsd) in gray  
 $mF_o-DF_c$  (at 3 rmsd) in purple (negative)  
and green (positive)

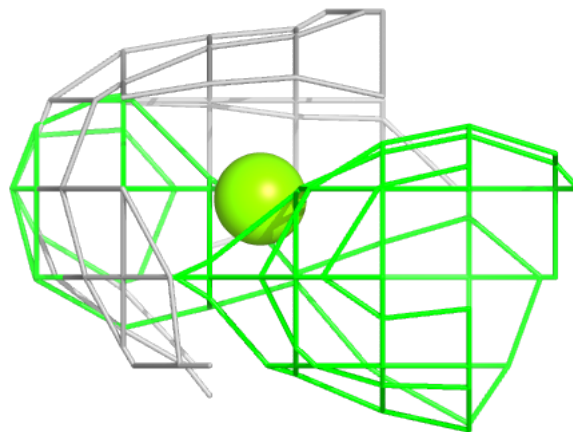
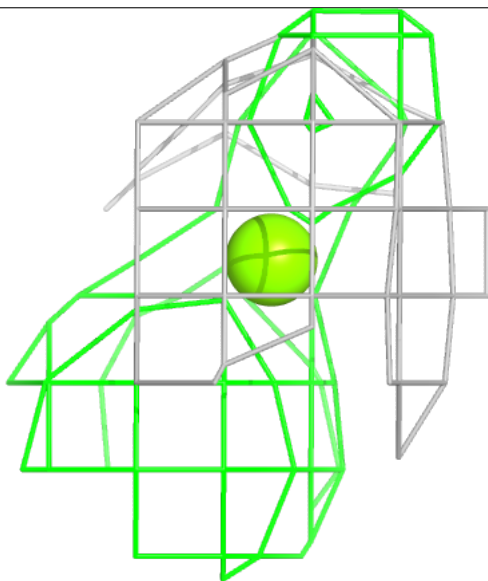
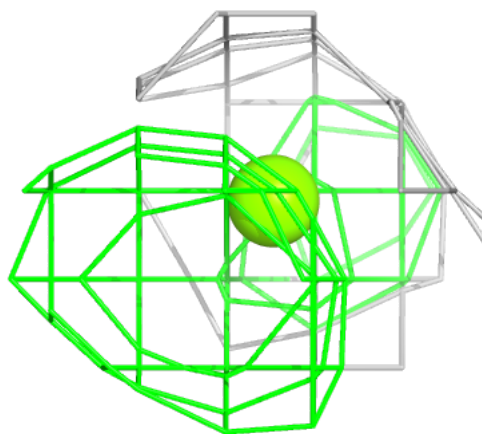

**Electron density around MG G 602:**

$2mF_o-DF_c$  (at 0.7 rmsd) in gray  
 $mF_o-DF_c$  (at 3 rmsd) in purple (negative)  
and green (positive)

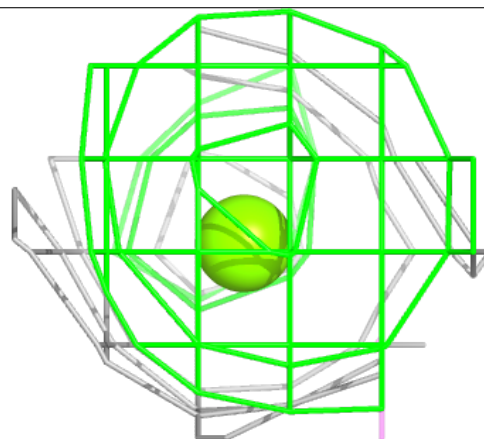
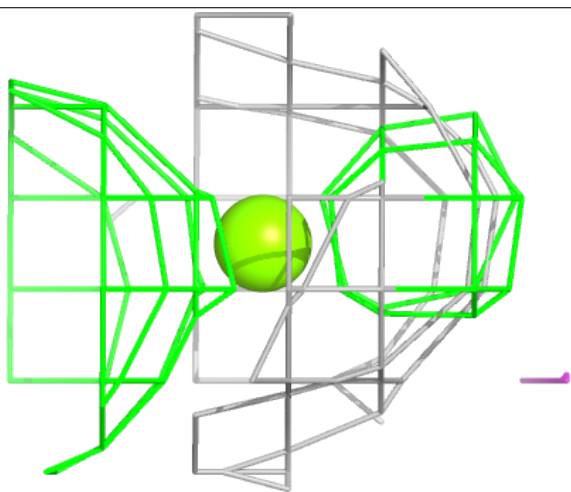
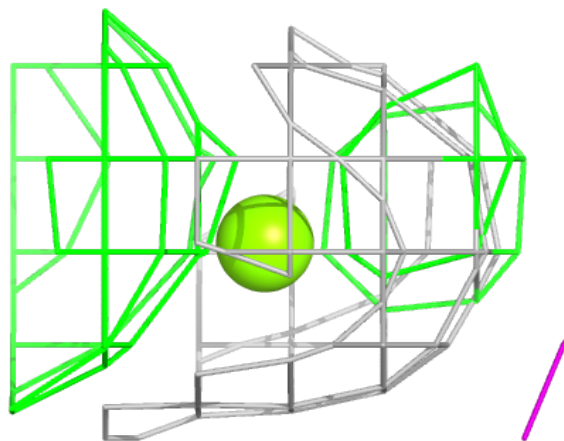



**Electron density around MG P 602:**

$2mF_o-DF_c$  (at 0.7 rmsd) in gray  
 $mF_o-DF_c$  (at 3 rmsd) in purple (negative)  
and green (positive)

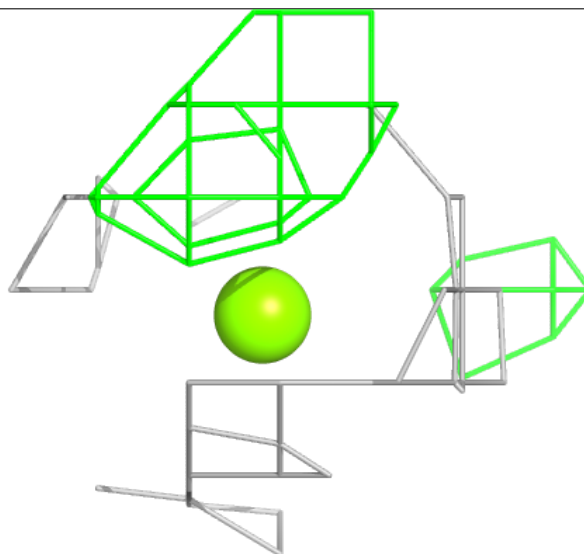
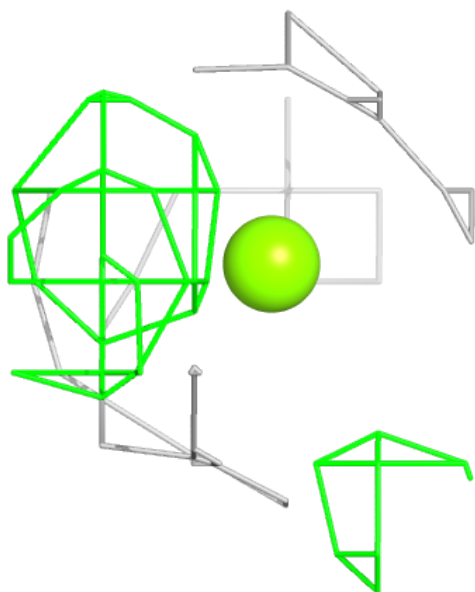
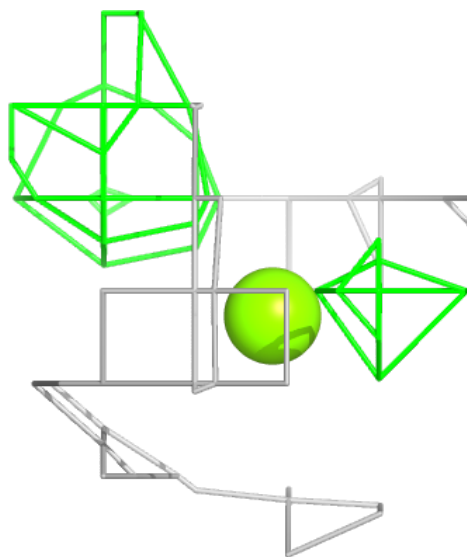

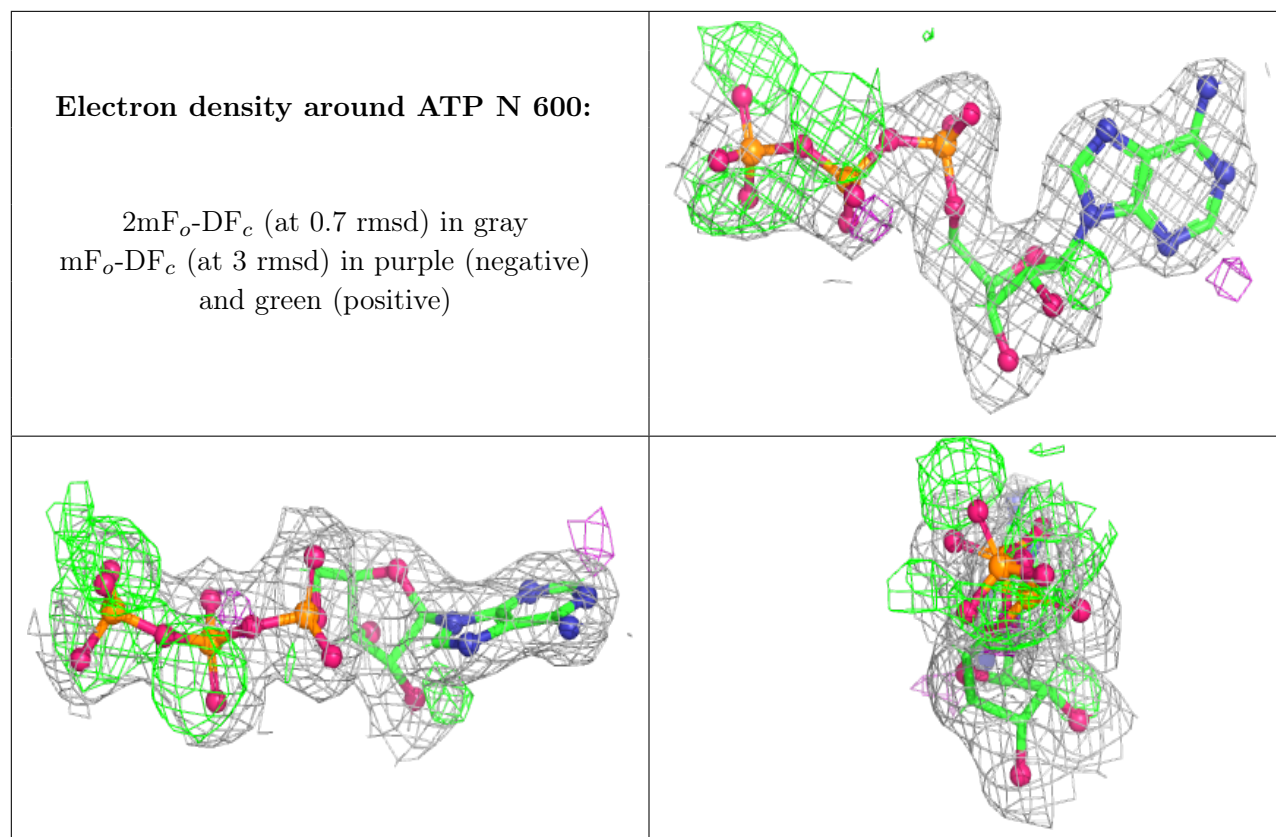

**Electron density around MG G 603:**

$2mF_o-DF_c$  (at 0.7 rmsd) in gray  
 $mF_o-DF_c$  (at 3 rmsd) in purple (negative)  
and green (positive)

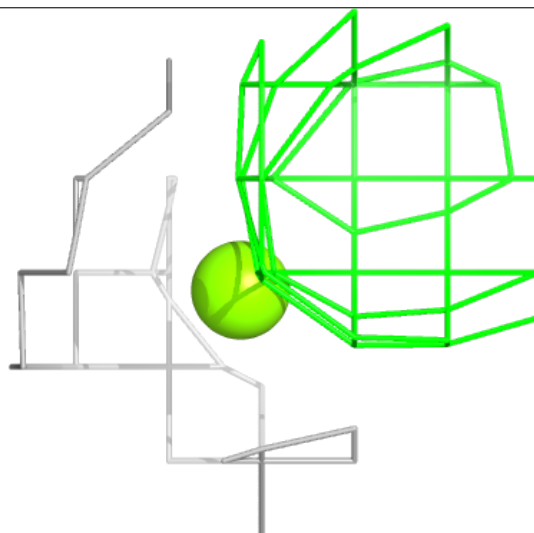
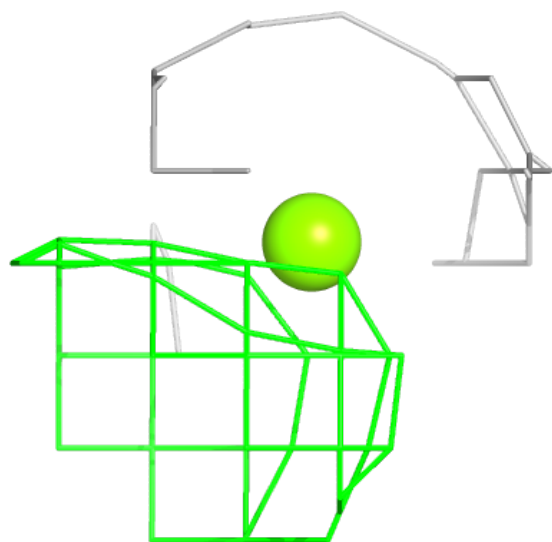
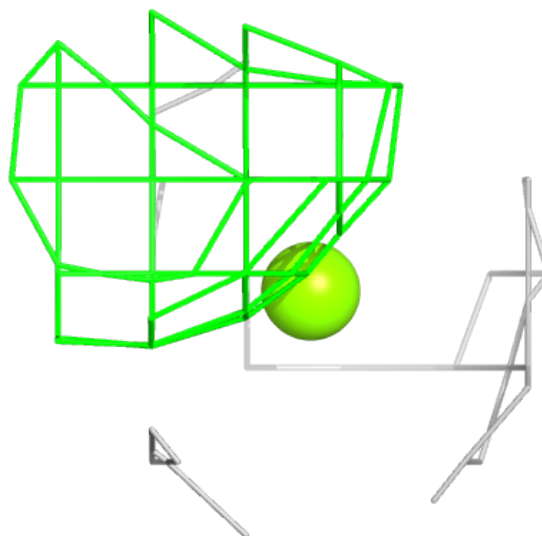

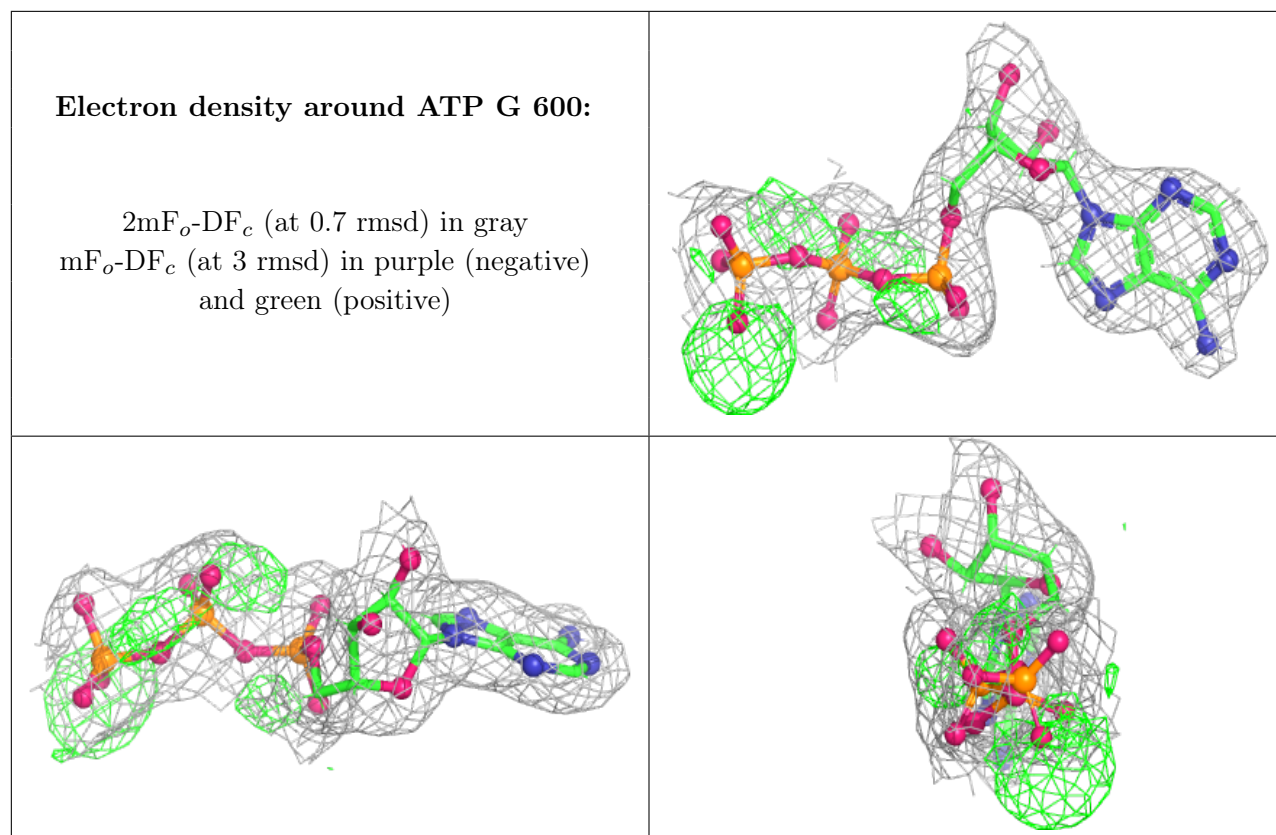

**Electron density around MG I 602:**

$2mF_o-DF_c$  (at 0.7 rmsd) in gray  
 $mF_o-DF_c$  (at 3 rmsd) in purple (negative)  
and green (positive)

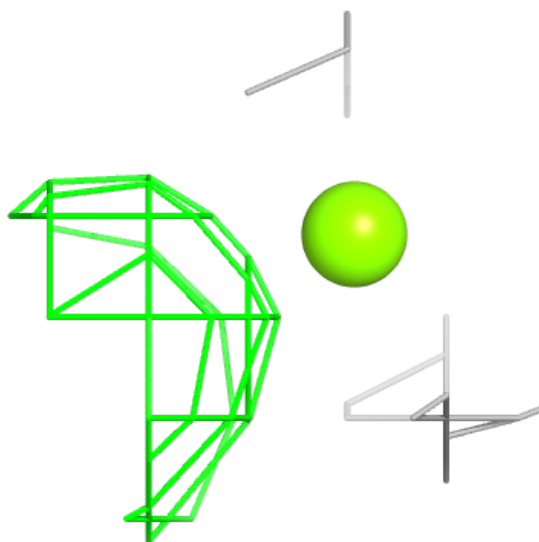
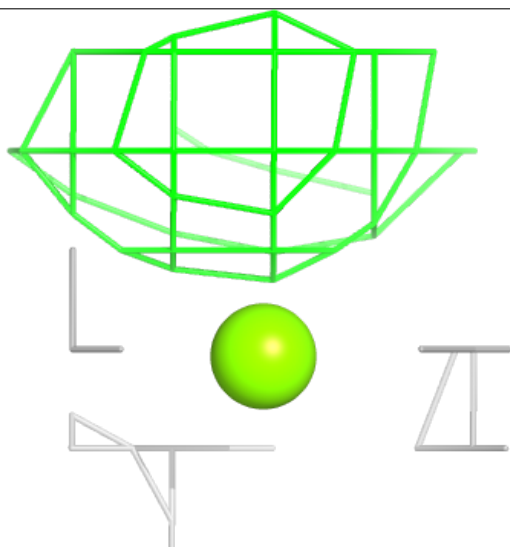
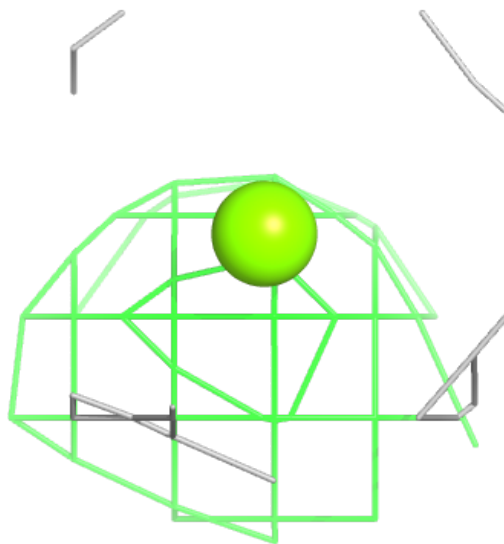

**Electron density around G4P J 601:**

$2mF_o-DF_c$  (at 0.7 rmsd) in gray  
 $mF_o-DF_c$  (at 3 rmsd) in purple (negative)  
and green (positive)

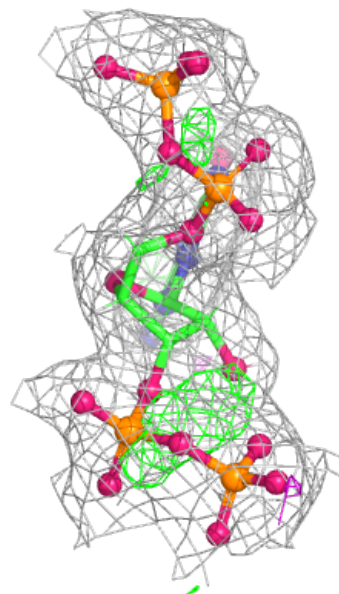
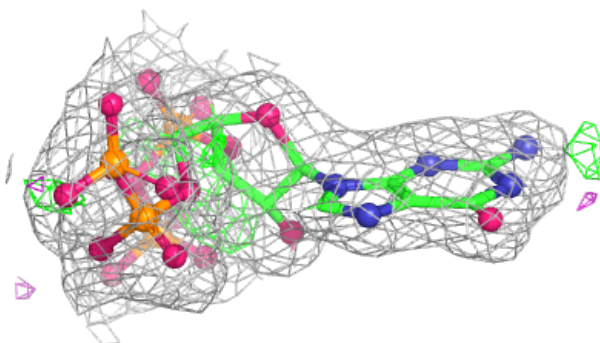
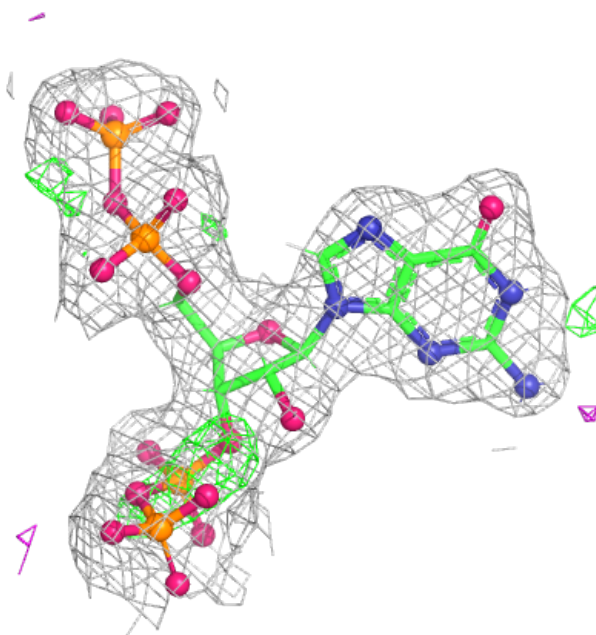

**Electron density around G4P O 601:**

$2mF_o - DF_c$  (at 0.7 rmsd) in gray  
 $mF_o - DF_c$  (at 3 rmsd) in purple (negative)  
and green (positive)

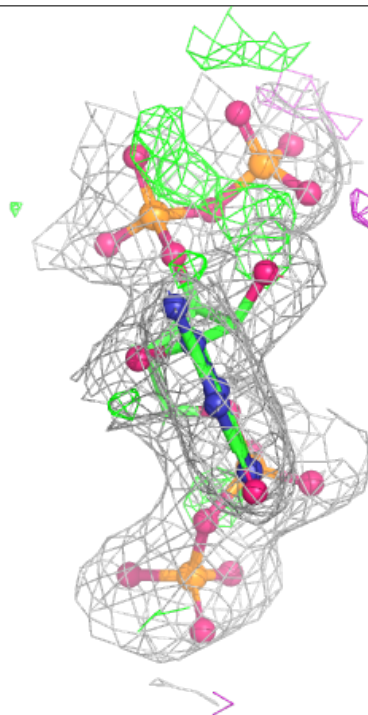
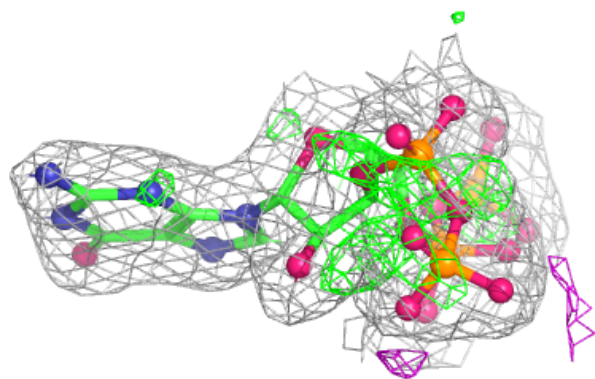
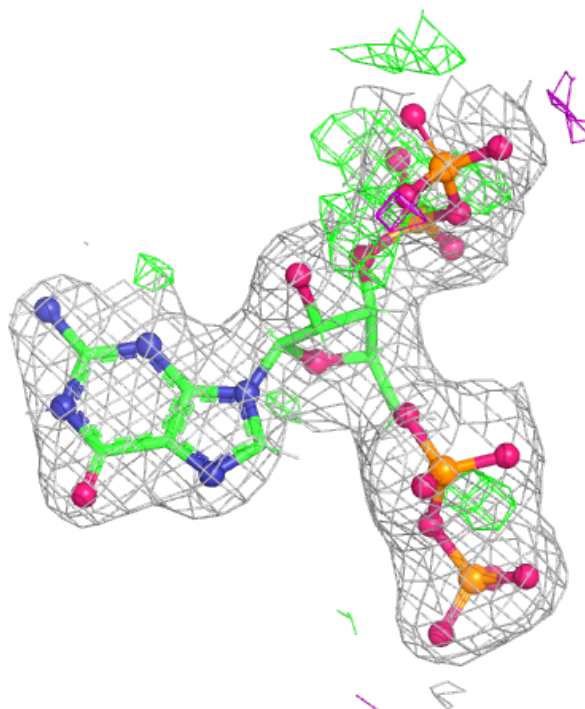

**Electron density around MG B 603:**

$2mF_o-DF_c$  (at 0.7 rmsd) in gray  
 $mF_o-DF_c$  (at 3 rmsd) in purple (negative)  
and green (positive)

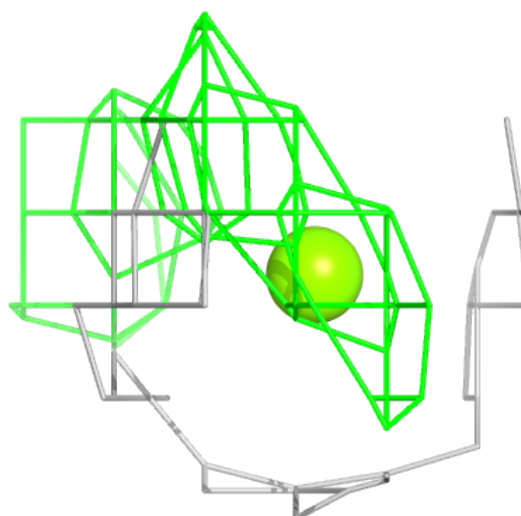
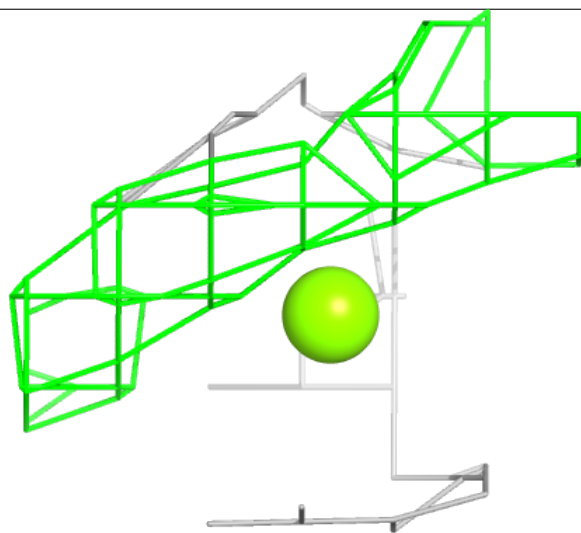
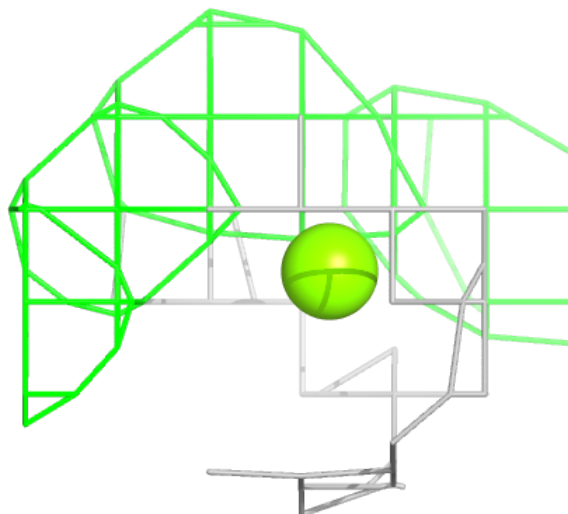



**Electron density around ATP B 600:**

$2mF_o-DF_c$  (at 0.7 rmsd) in gray  
 $mF_o-DF_c$  (at 3 rmsd) in purple (negative)  
and green (positive)

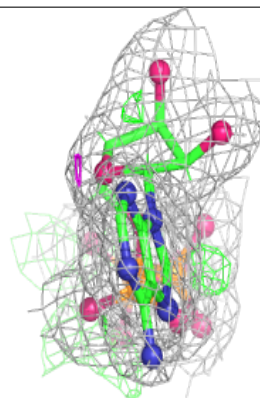
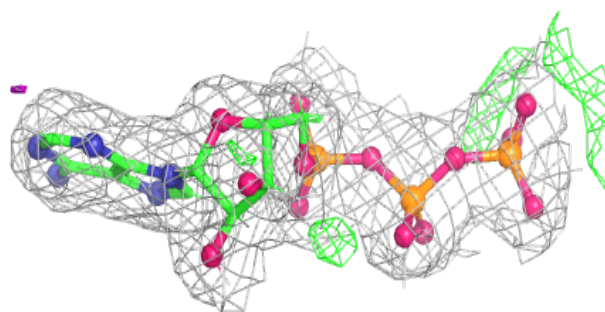
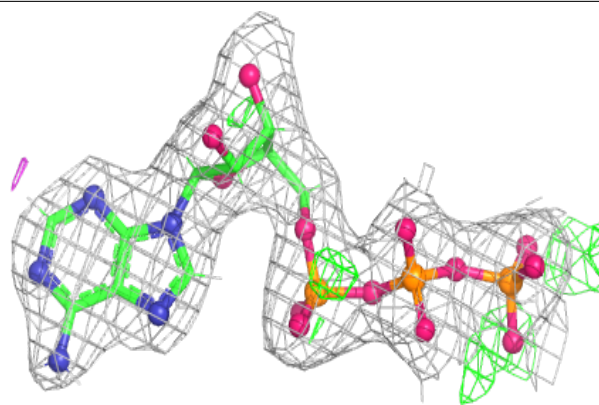
**Electron density around ATP I 600:**

$2mF_o-DF_c$  (at 0.7 rmsd) in gray  
 $mF_o-DF_c$  (at 3 rmsd) in purple (negative)  
and green (positive)

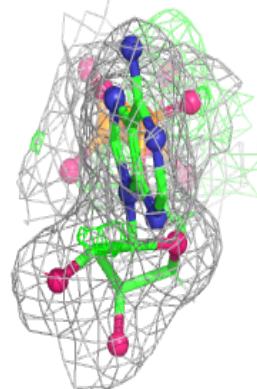
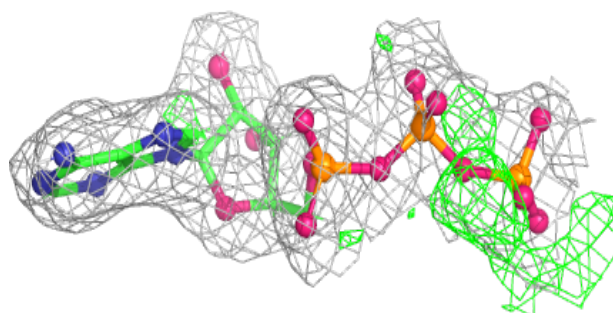
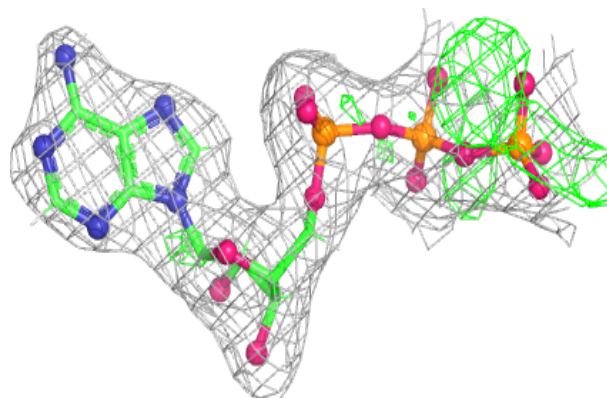

**Electron density around ATP J 600:**

$2mF_o-DF_c$  (at 0.7 rmsd) in gray  
 $mF_o-DF_c$  (at 3 rmsd) in purple (negative)  
and green (positive)

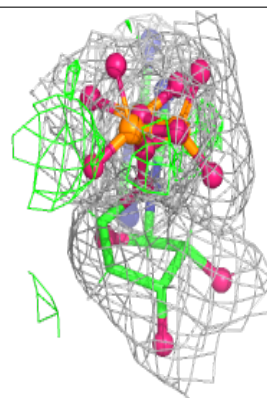
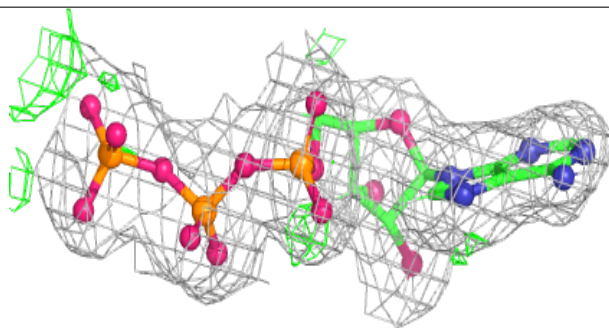
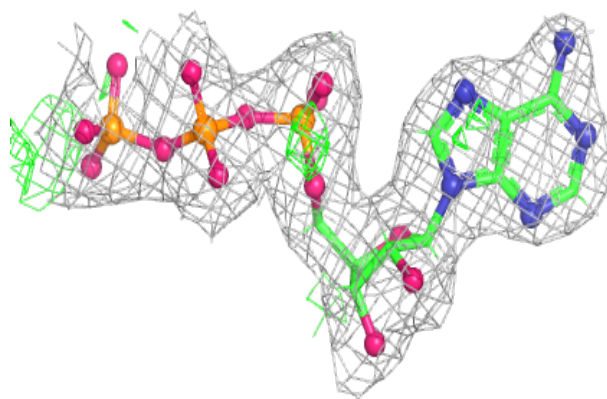
**Electron density around ATP C 600:**

$2mF_o-DF_c$  (at 0.7 rmsd) in gray  
 $mF_o-DF_c$  (at 3 rmsd) in purple (negative)  
and green (positive)

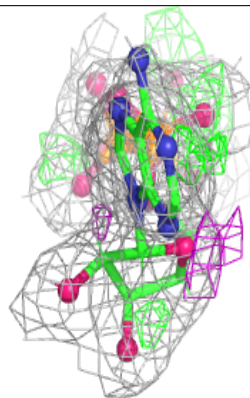
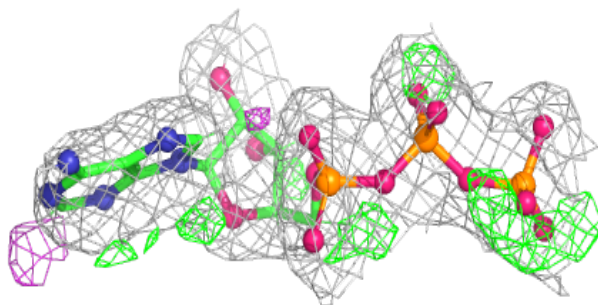
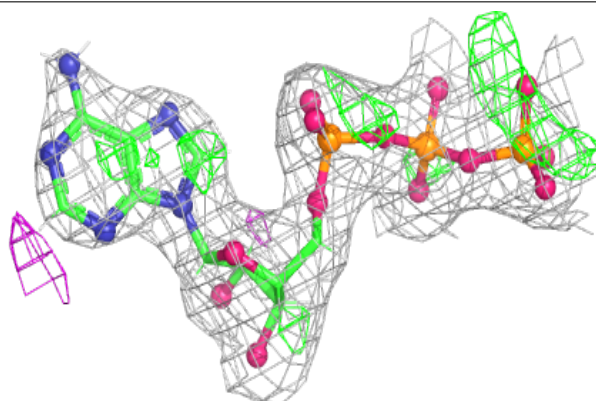

**Electron density around MG O 602:**

$2mF_o-DF_c$  (at 0.7 rmsd) in gray  
 $mF_o-DF_c$  (at 3 rmsd) in purple (negative)  
and green (positive)

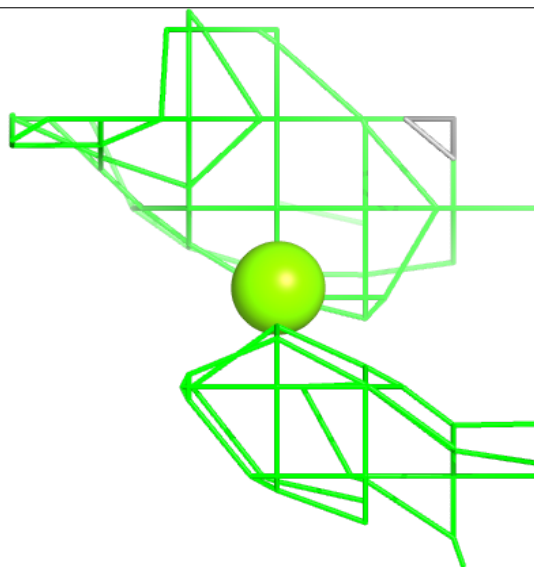
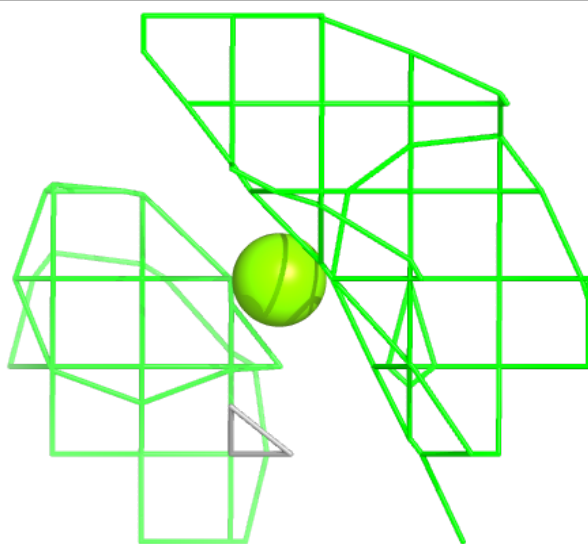
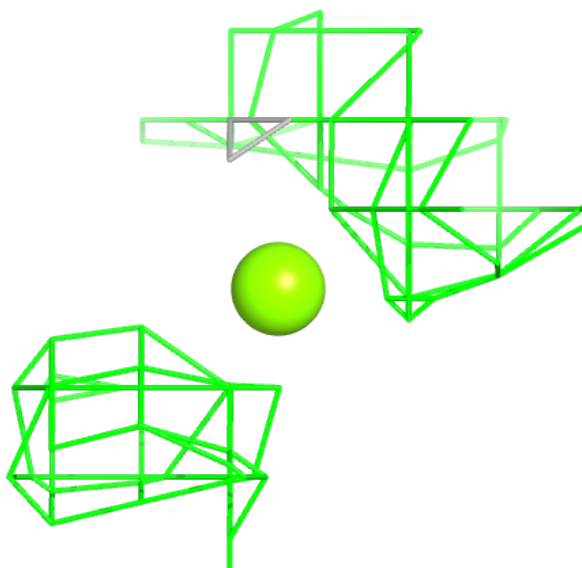

**Electron density around ATP O 600:**

$2mF_o-DF_c$  (at 0.7 rmsd) in gray  
 $mF_o-DF_c$  (at 3 rmsd) in purple (negative)  
and green (positive)

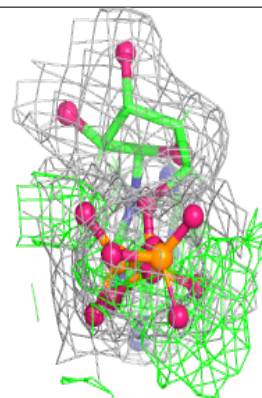
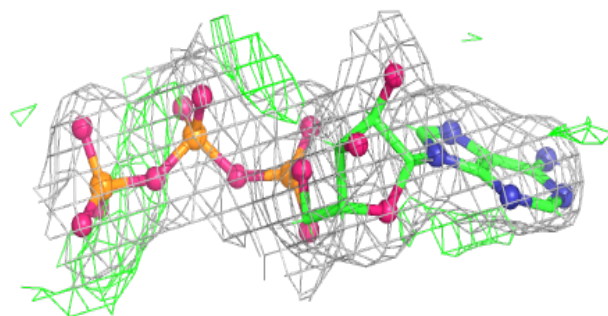
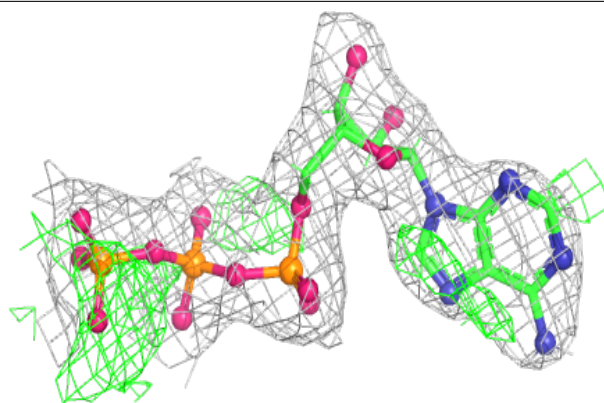

**Electron density around G4P E 601:**

$2mF_o-DF_c$  (at 0.7 rmsd) in gray  
 $mF_o-DF_c$  (at 3 rmsd) in purple (negative)  
and green (positive)

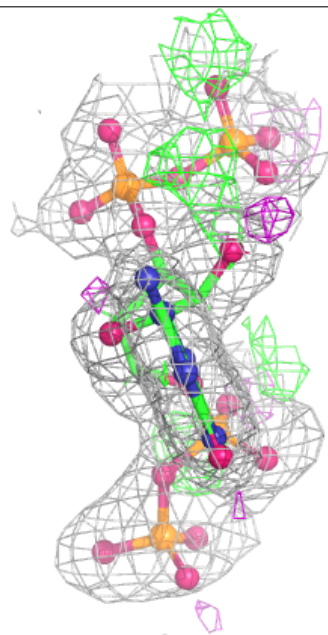
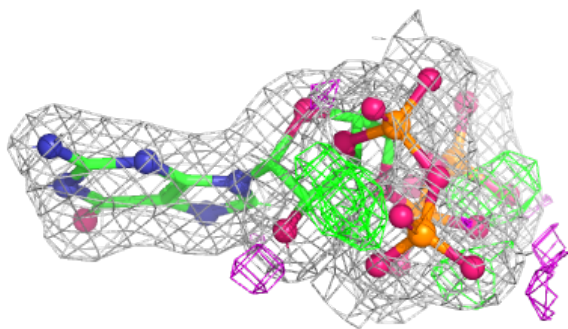
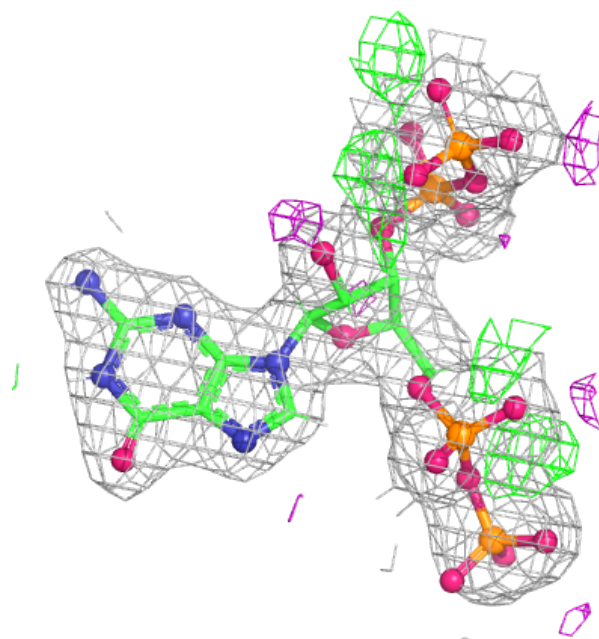

**Electron density around G4P F 601:**

$2mF_o-DF_c$  (at 0.7 rmsd) in gray  
 $mF_o-DF_c$  (at 3 rmsd) in purple (negative)  
and green (positive)

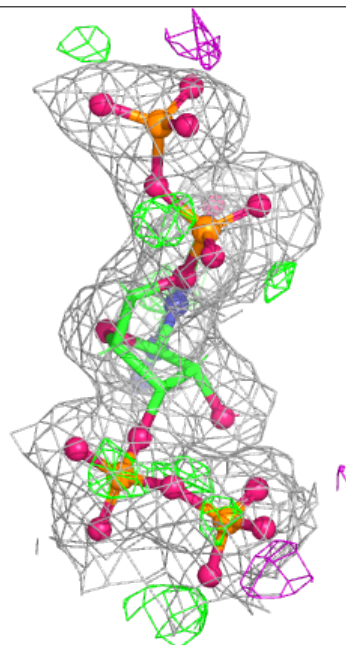
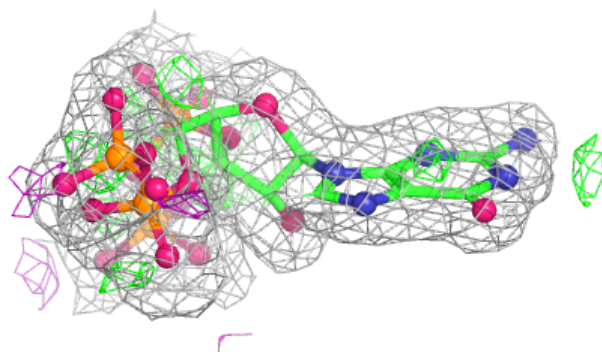
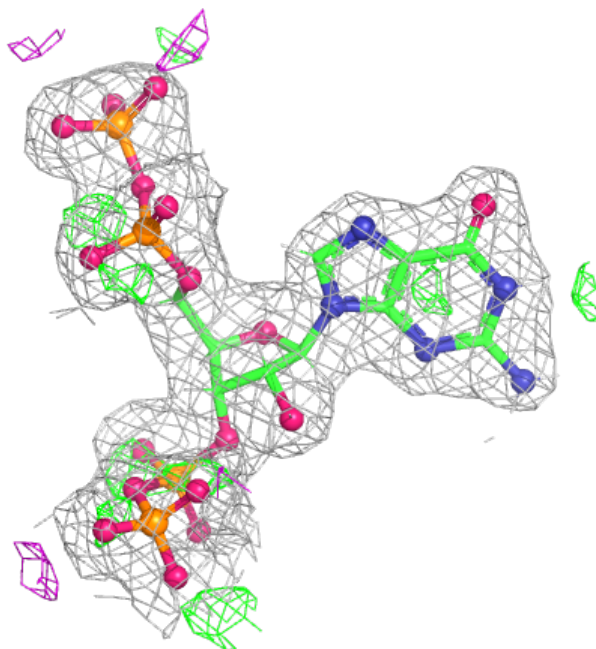

**Electron density around G4P G 601:**

$2mF_o-DF_c$  (at 0.7 rmsd) in gray  
 $mF_o-DF_c$  (at 3 rmsd) in purple (negative)  
and green (positive)

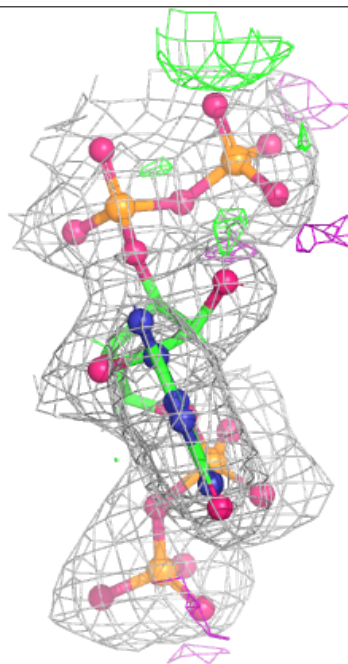
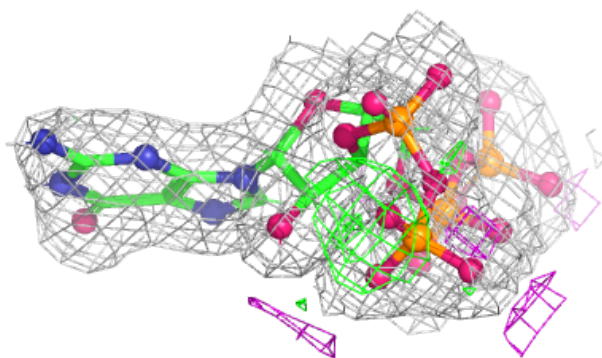
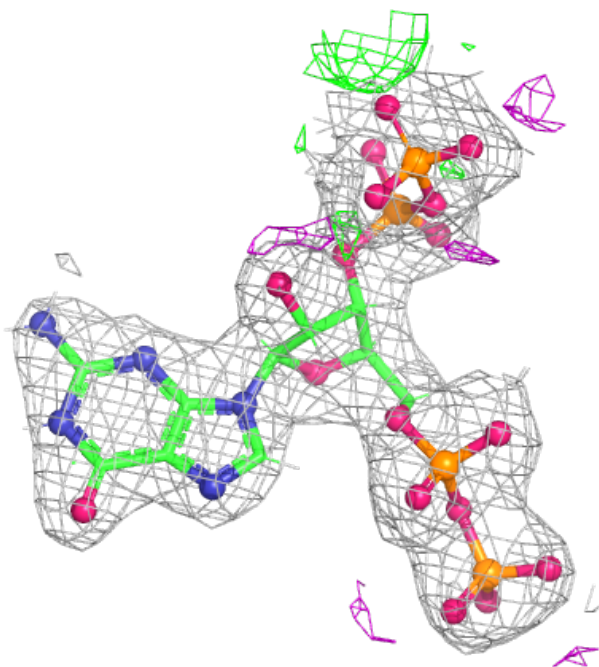

**Electron density around G4P H 601:**

$2mF_o - DF_c$  (at 0.7 rmsd) in gray  
 $mF_o - DF_c$  (at 3 rmsd) in purple (negative)  
and green (positive)

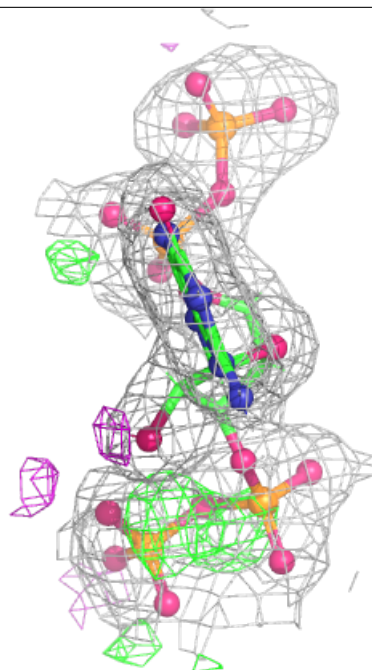
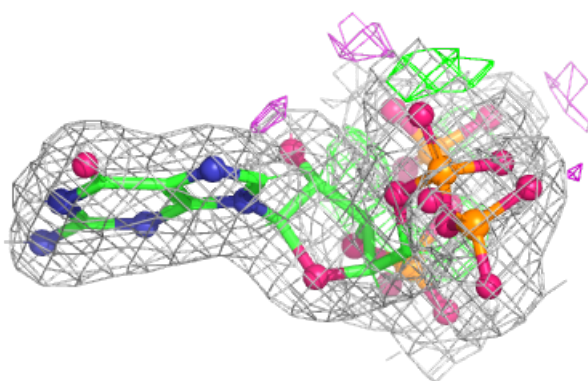
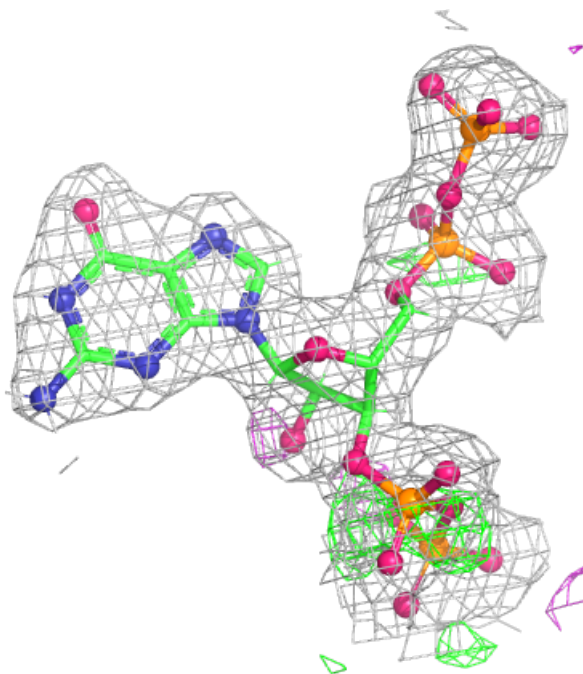



**Electron density around G4P I 601:**

$2mF_o-DF_c$  (at 0.7 rmsd) in gray  
 $mF_o-DF_c$  (at 3 rmsd) in purple (negative)  
and green (positive)

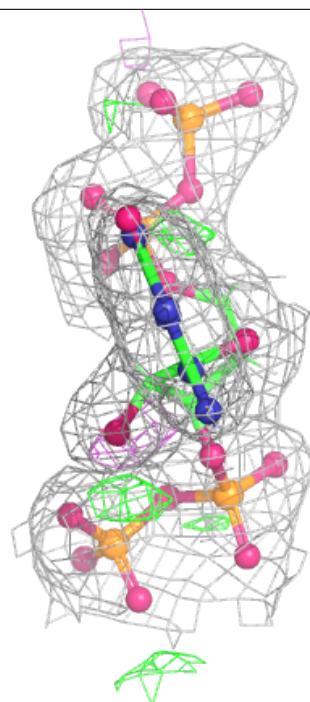
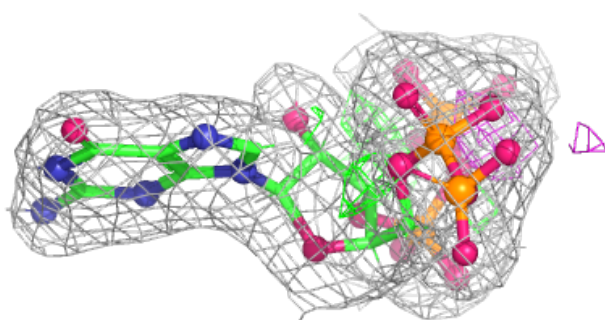
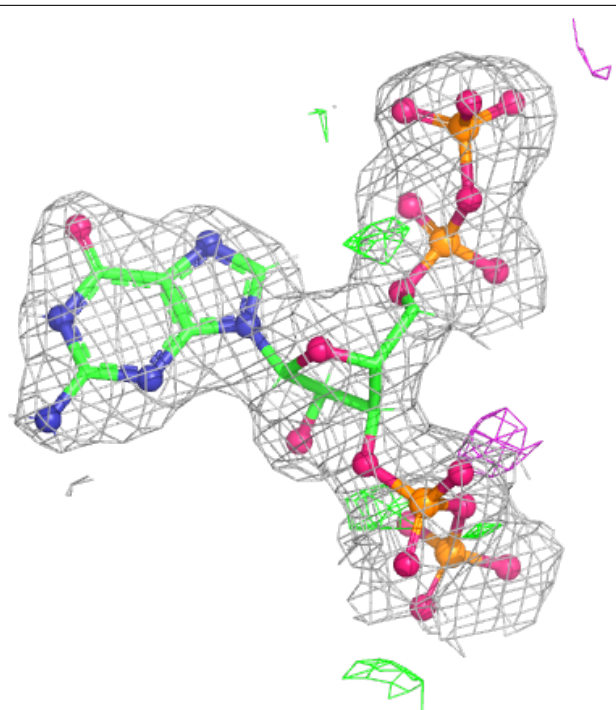

**Electron density around ATP F 600:**

$2mF_o-DF_c$  (at 0.7 rmsd) in gray  
 $mF_o-DF_c$  (at 3 rmsd) in purple (negative)  
and green (positive)

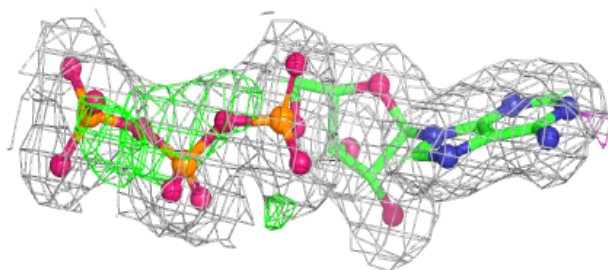
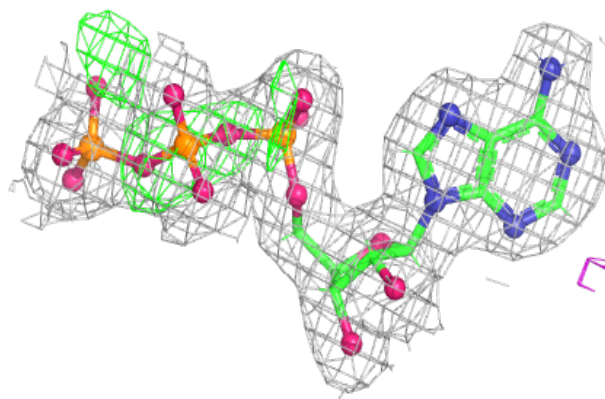

**Electron density around G4P K 601:**

$2mF_o-DF_c$  (at 0.7 rmsd) in gray  
 $mF_o-DF_c$  (at 3 rmsd) in purple (negative)  
and green (positive)

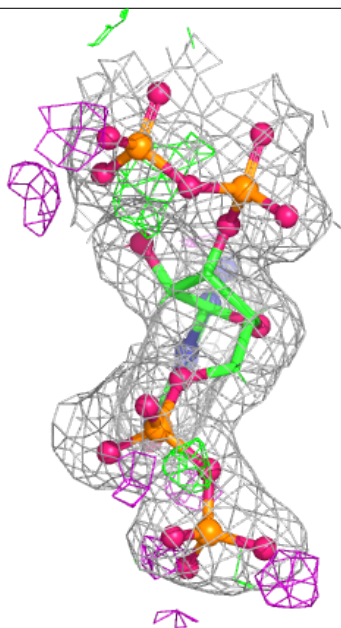
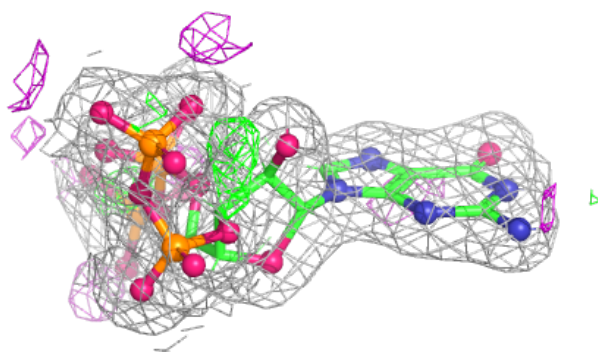
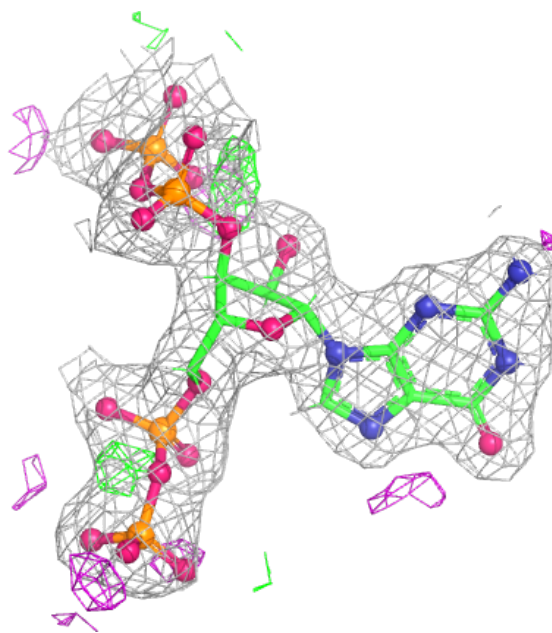

**Electron density around G4P M 601:**

$2mF_o-DF_c$  (at 0.7 rmsd) in gray  
 $mF_o-DF_c$  (at 3 rmsd) in purple (negative)  
and green (positive)

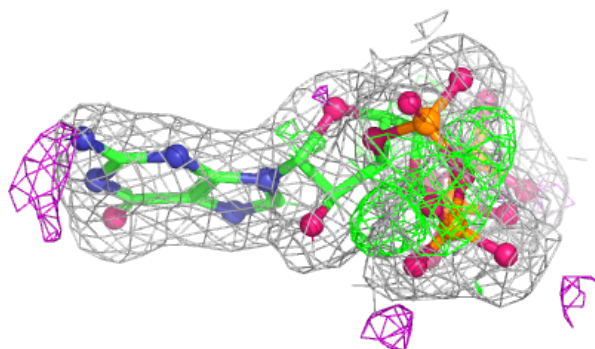
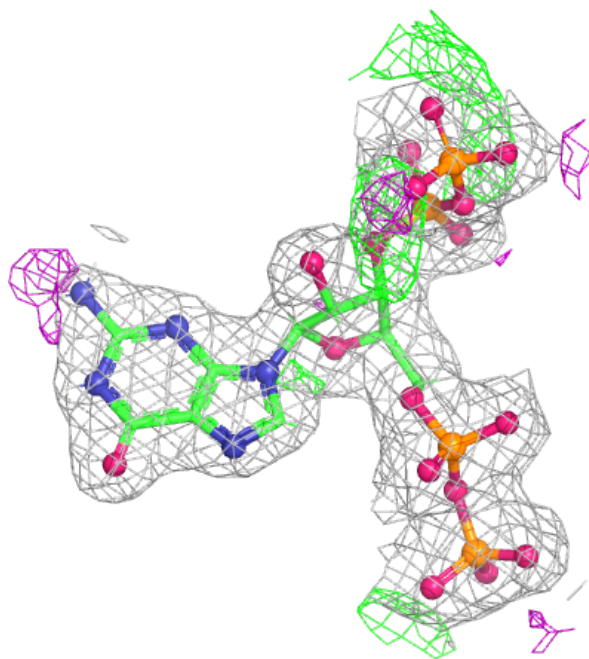

**Electron density around G4P N 601:**

$2mF_o-DF_c$  (at 0.7 rmsd) in gray  
 $mF_o-DF_c$  (at 3 rmsd) in purple (negative)  
and green (positive)

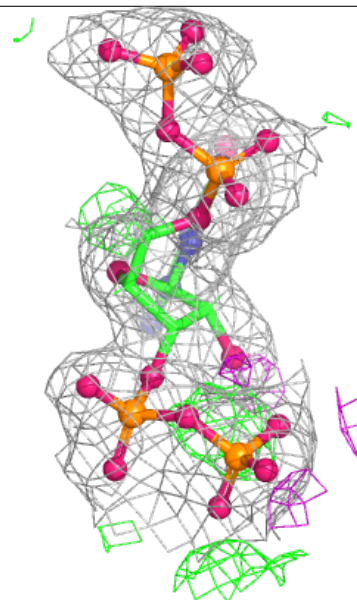
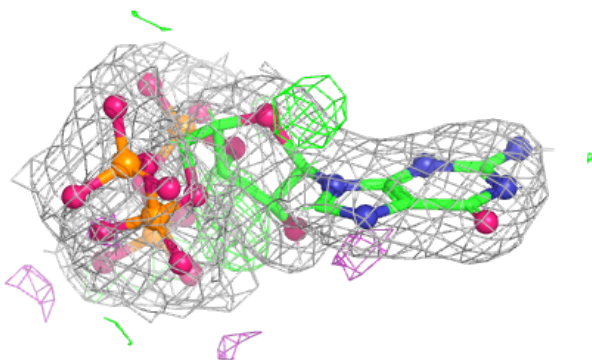
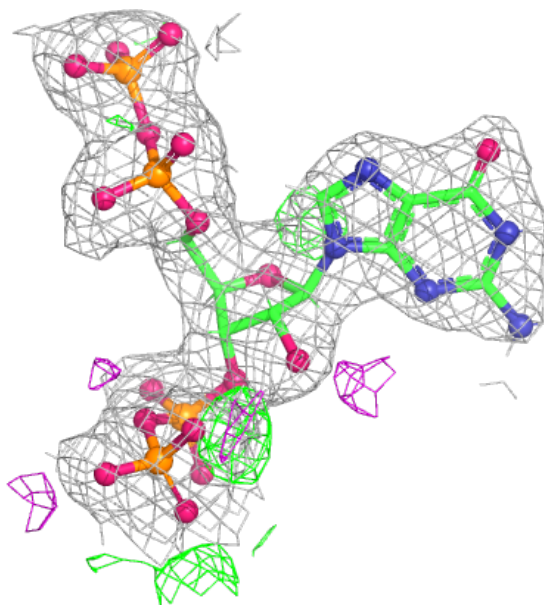

**Electron density around ATP M 600:**

$2mF_o-DF_c$  (at 0.7 rmsd) in gray  
 $mF_o-DF_c$  (at 3 rmsd) in purple (negative)  
and green (positive)

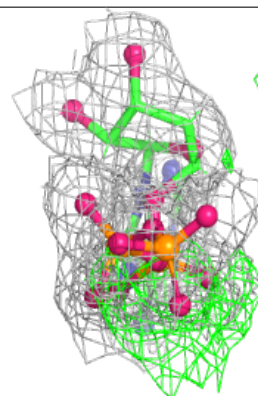
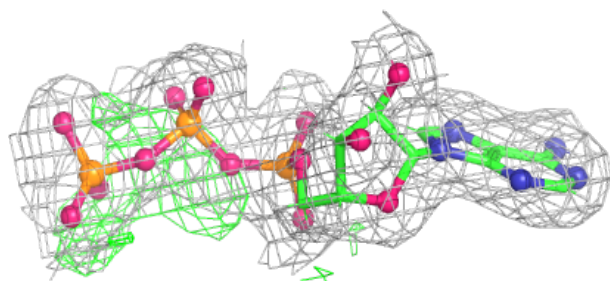
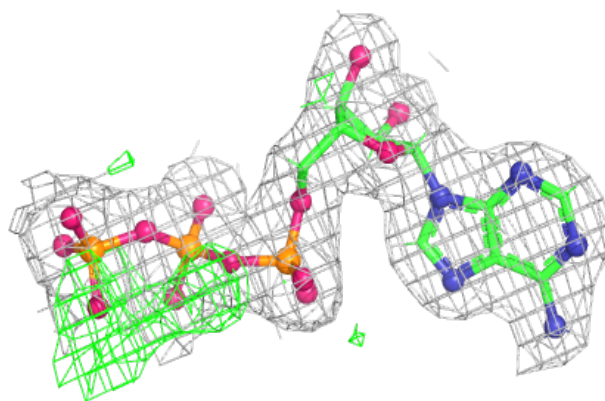

**Electron density around G4P P 601:**

$2mF_o-DF_c$  (at 0.7 rmsd) in gray  
 $mF_o-DF_c$  (at 3 rmsd) in purple (negative)  
and green (positive)

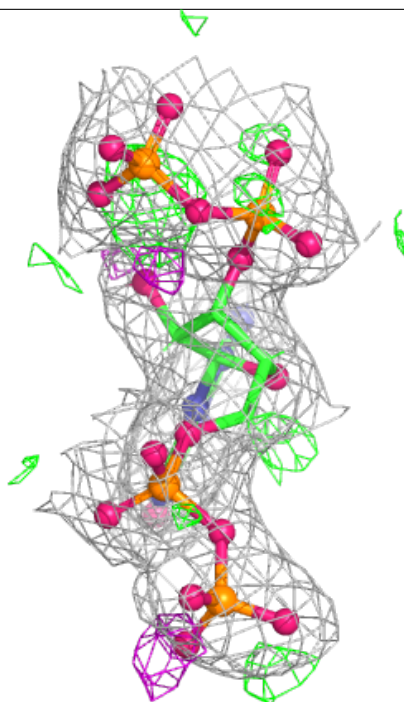
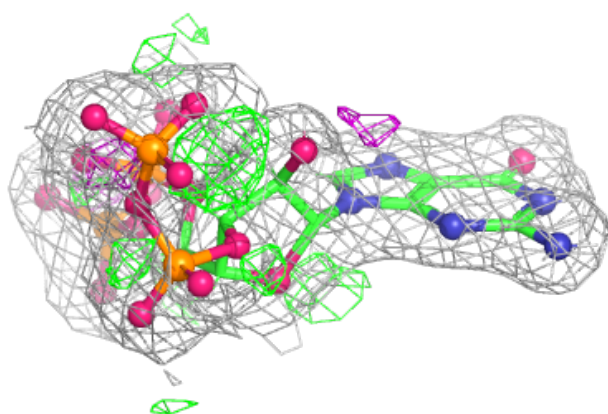
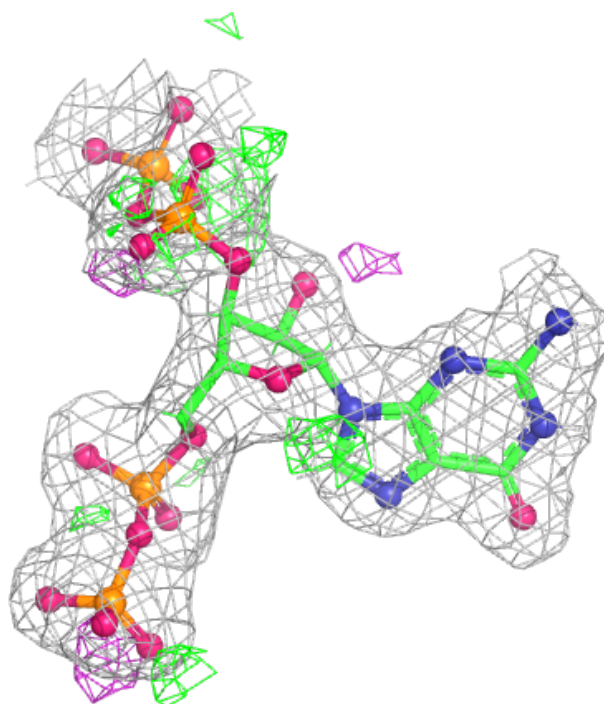

**Electron density around MG B 602:**

$2mF_o-DF_c$  (at 0.7 rmsd) in gray  
 $mF_o-DF_c$  (at 3 rmsd) in purple (negative)  
and green (positive)

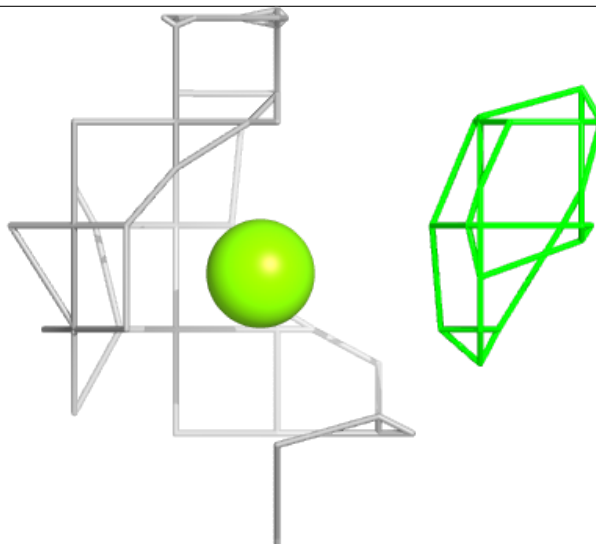
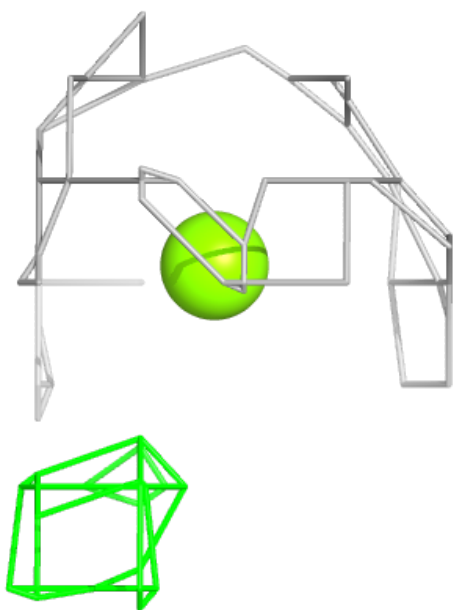
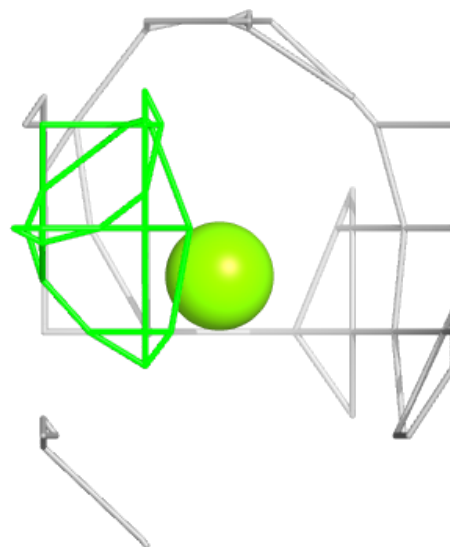



**Electron density around ATP A 600:**

$2mF_o-DF_c$  (at 0.7 rmsd) in gray  
 $mF_o-DF_c$  (at 3 rmsd) in purple (negative)  
and green (positive)

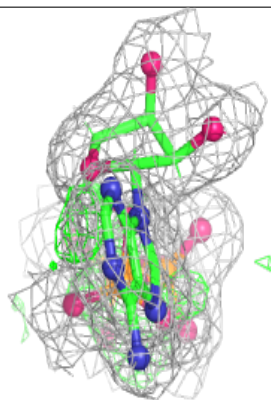
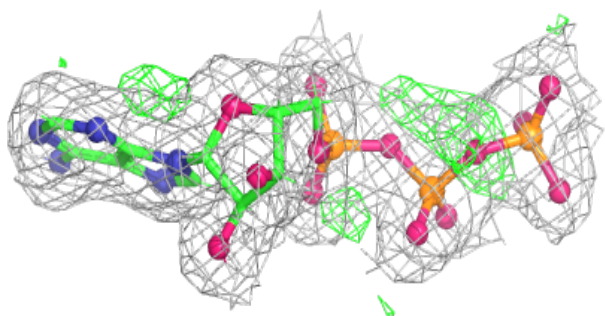
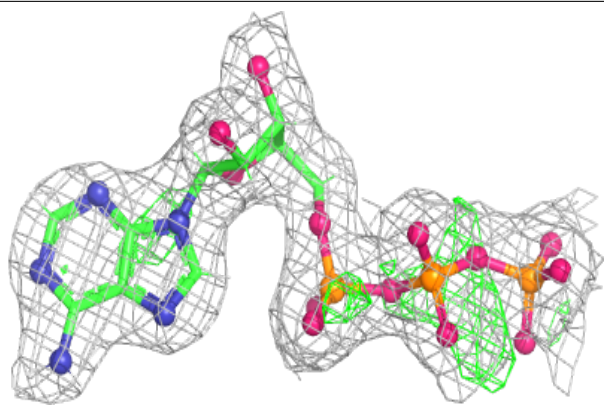

**Electron density around MG C 602:**

$2mF_o-DF_c$  (at 0.7 rmsd) in gray  
 $mF_o-DF_c$  (at 3 rmsd) in purple (negative)  
and green (positive)

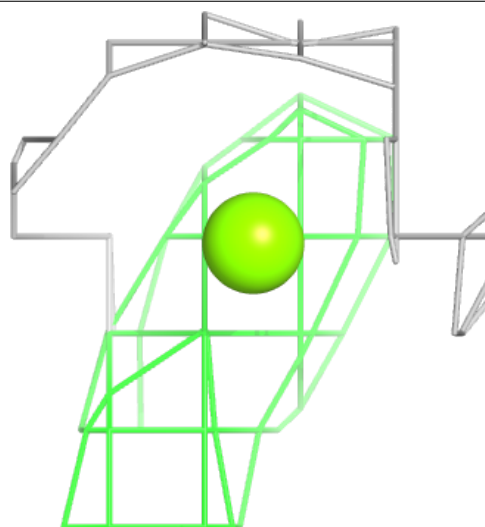
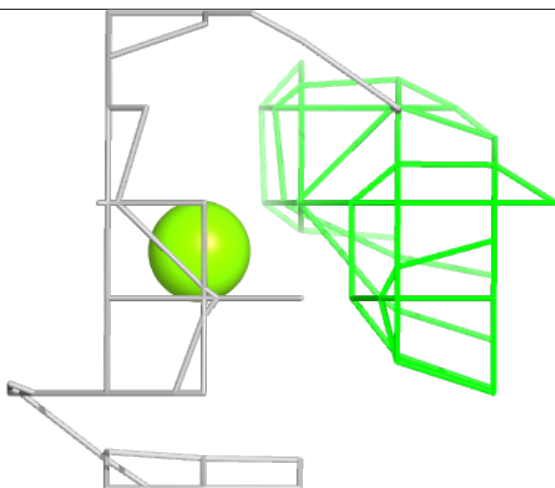
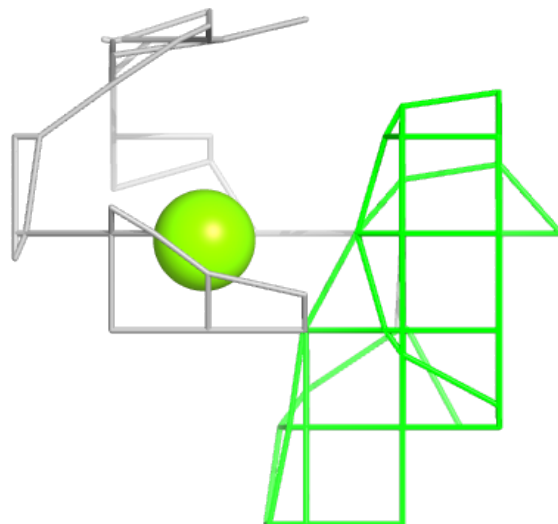

**Electron density around MG C 603:**

$2mF_o-DF_c$  (at 0.7 rmsd) in gray  
 $mF_o-DF_c$  (at 3 rmsd) in purple (negative)  
and green (positive)

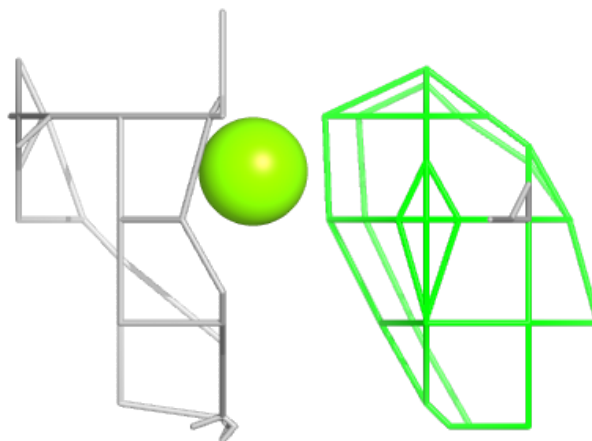
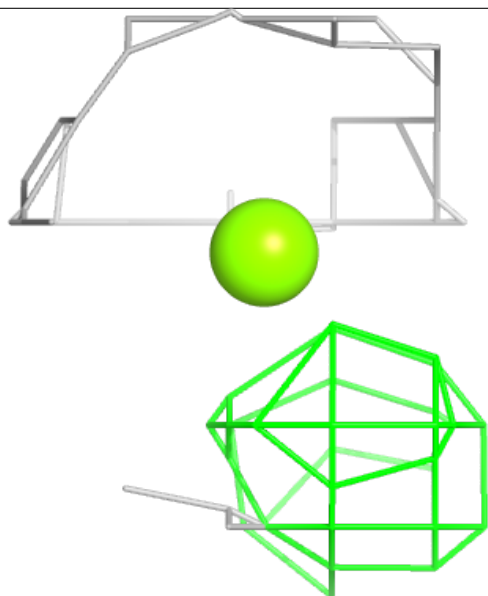
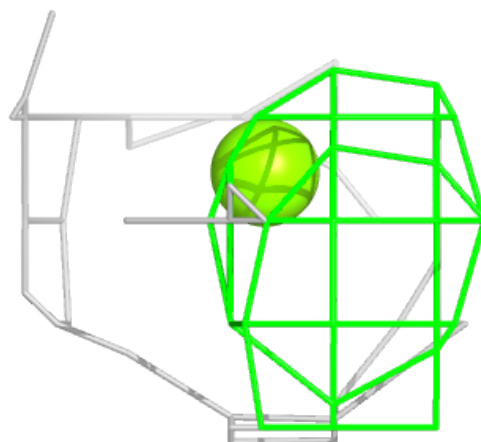

**Electron density around MG D 603:**

$2mF_o-DF_c$  (at 0.7 rmsd) in gray  
 $mF_o-DF_c$  (at 3 rmsd) in purple (negative)  
and green (positive)

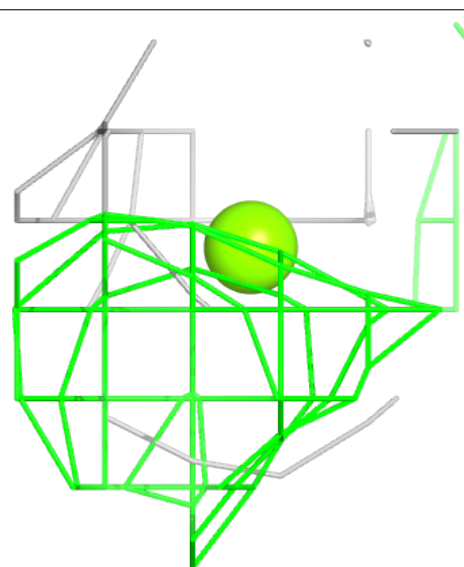
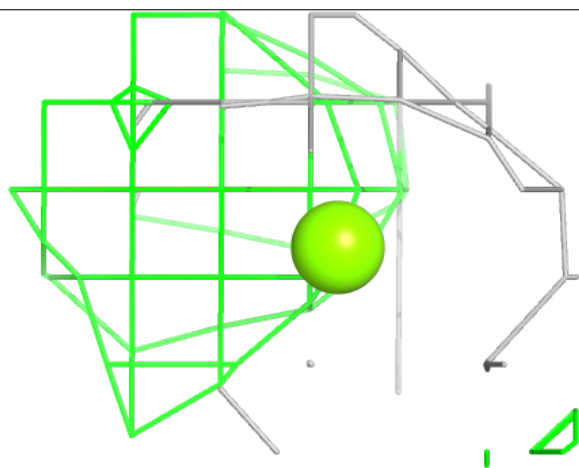
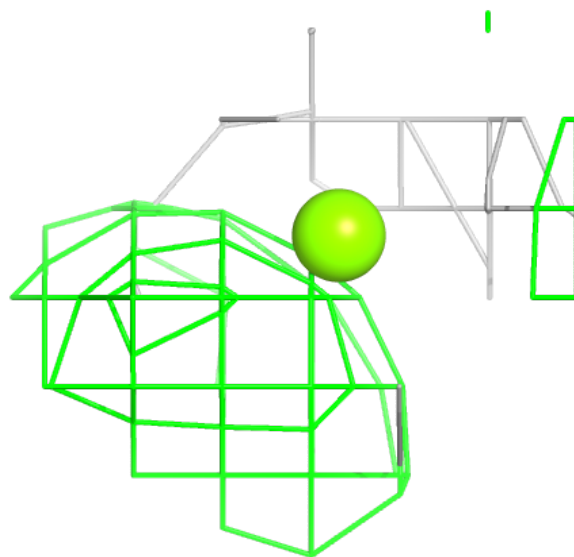

**Electron density around MG E 602:**

$2mF_o-DF_c$  (at 0.7 rmsd) in gray  
 $mF_o-DF_c$  (at 3 rmsd) in purple (negative)  
and green (positive)

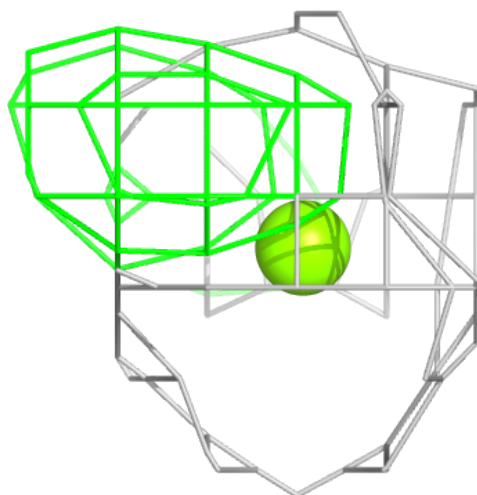
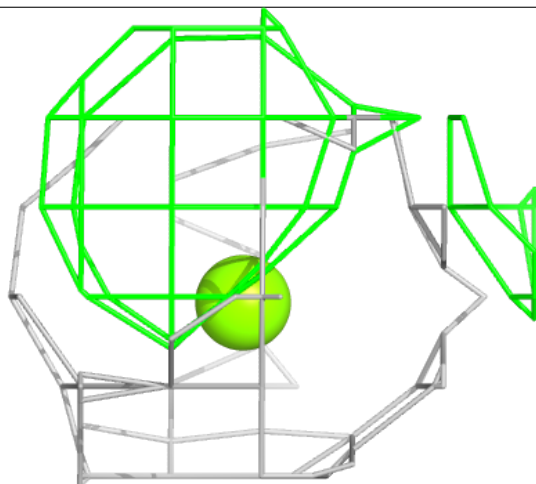
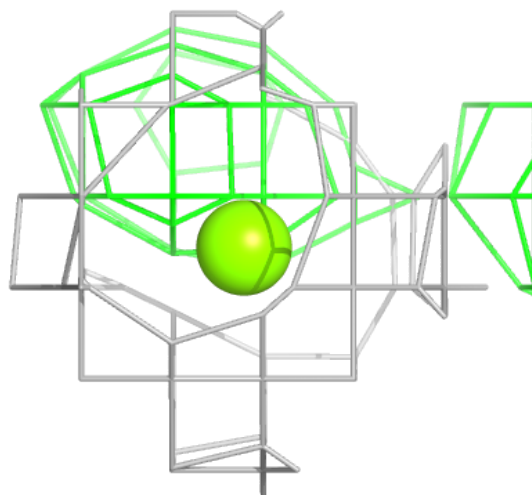

**Electron density around MG F 603:**

$2mF_o-DF_c$  (at 0.7 rmsd) in gray  
 $mF_o-DF_c$  (at 3 rmsd) in purple (negative)  
and green (positive)

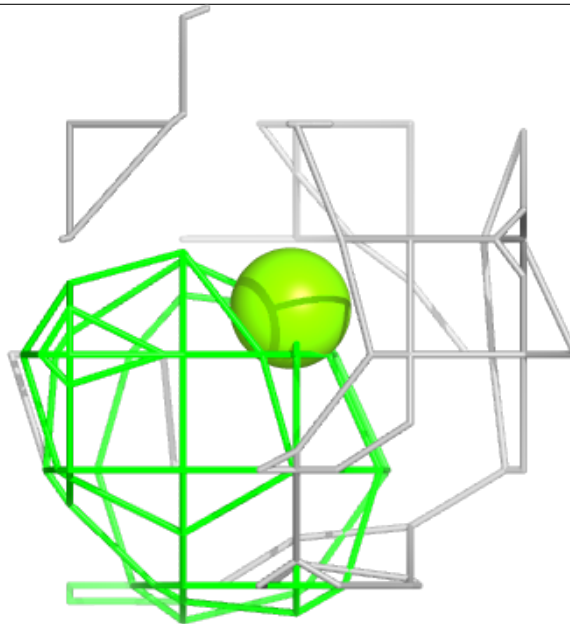
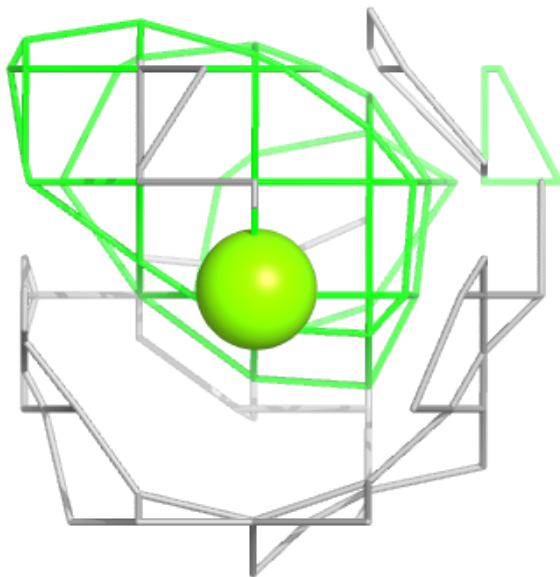
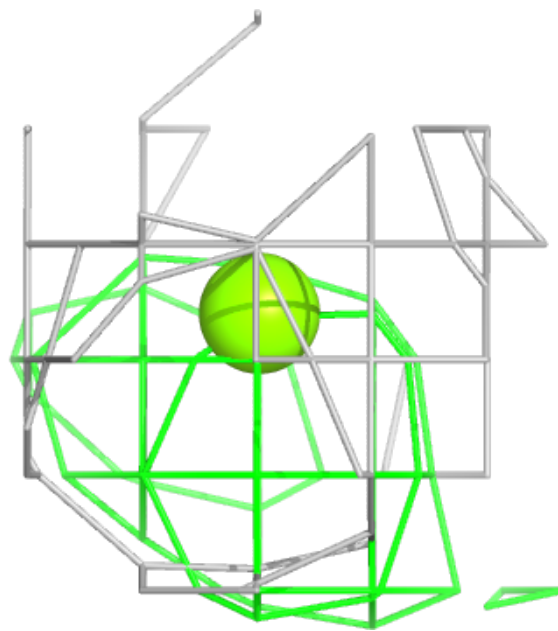

**Electron density around ATP D 600:**

$2mF_o-DF_c$  (at 0.7 rmsd) in gray  
 $mF_o-DF_c$  (at 3 rmsd) in purple (negative)  
and green (positive)

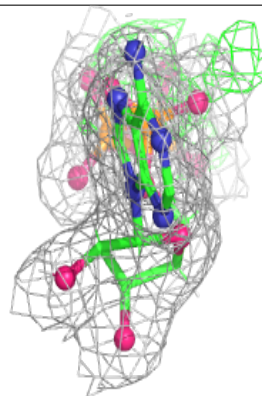
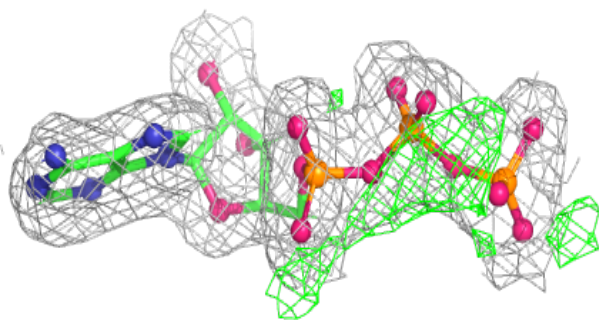
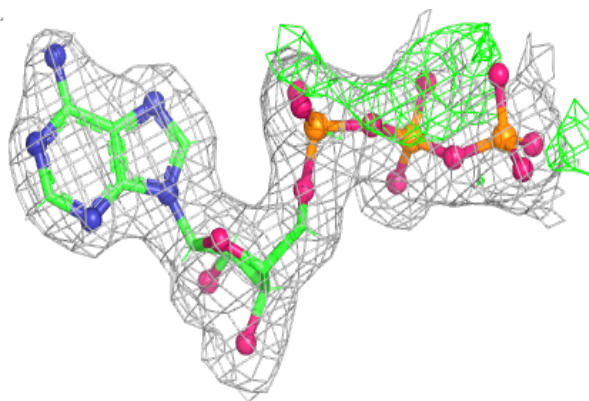
**Electron density around ATP P 600:**

$2mF_o-DF_c$  (at 0.7 rmsd) in gray  
 $mF_o-DF_c$  (at 3 rmsd) in purple (negative)  
and green (positive)

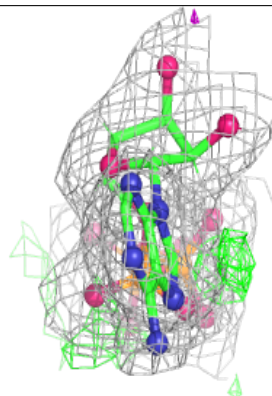
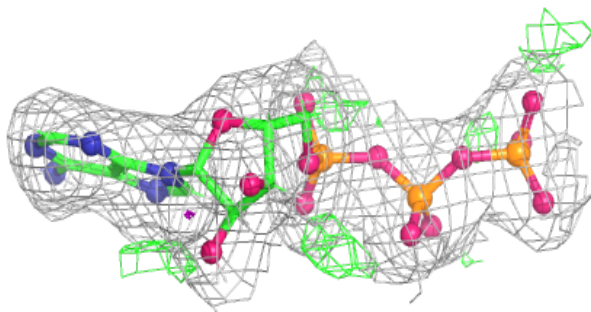
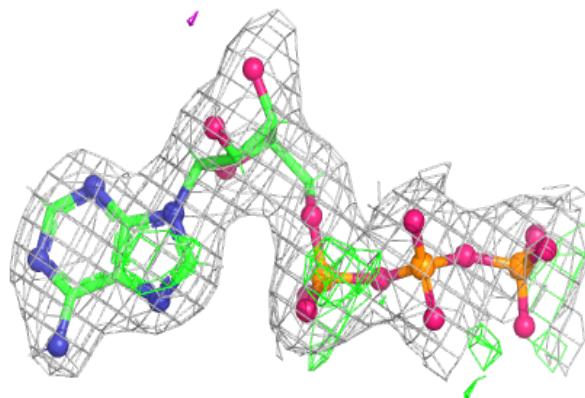

**Electron density around MG H 603:**

$2mF_o-DF_c$  (at 0.7 rmsd) in gray  
 $mF_o-DF_c$  (at 3 rmsd) in purple (negative)  
and green (positive)

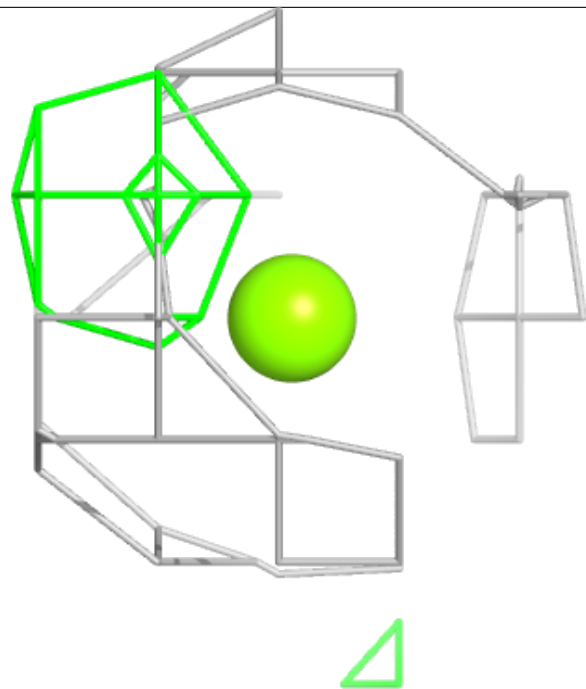
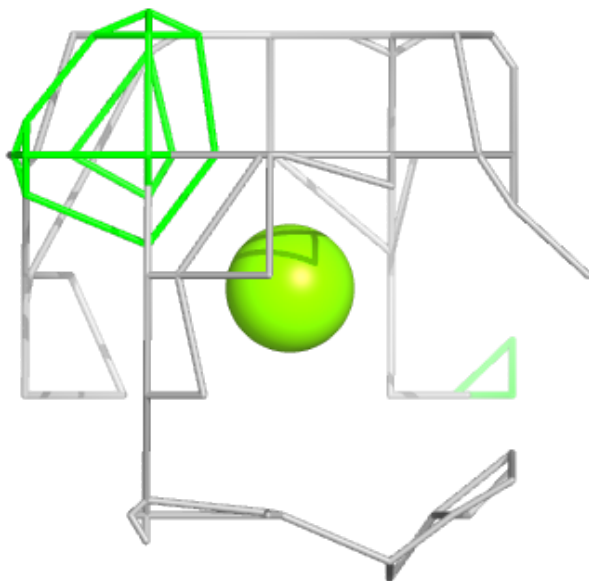
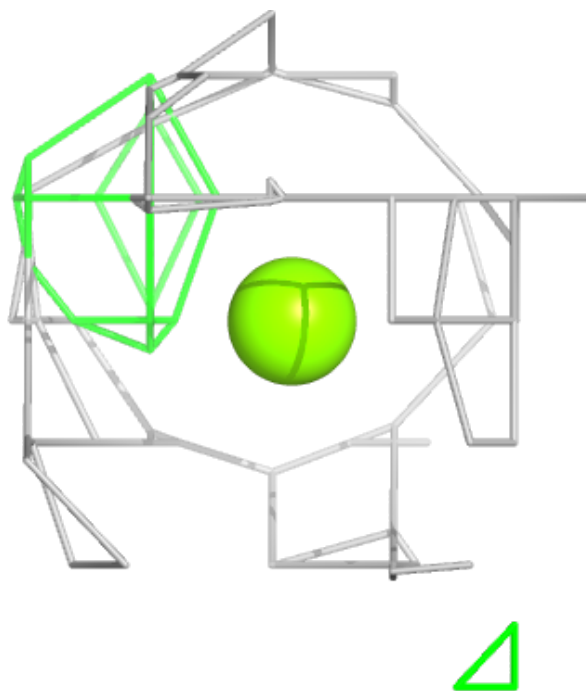



**Electron density around G4P A 601:**

$2mF_o-DF_c$  (at 0.7 rmsd) in gray  
 $mF_o-DF_c$  (at 3 rmsd) in purple (negative)  
and green (positive)

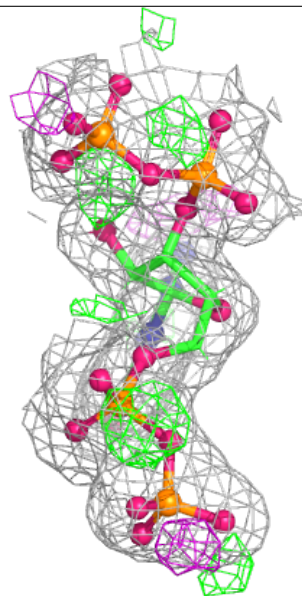
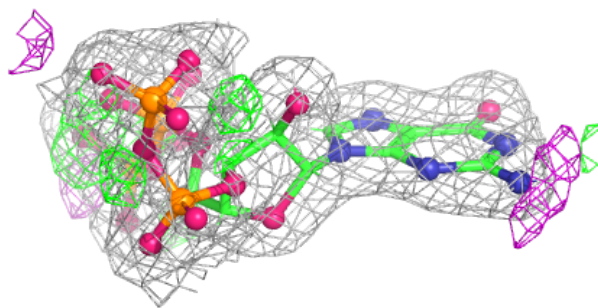
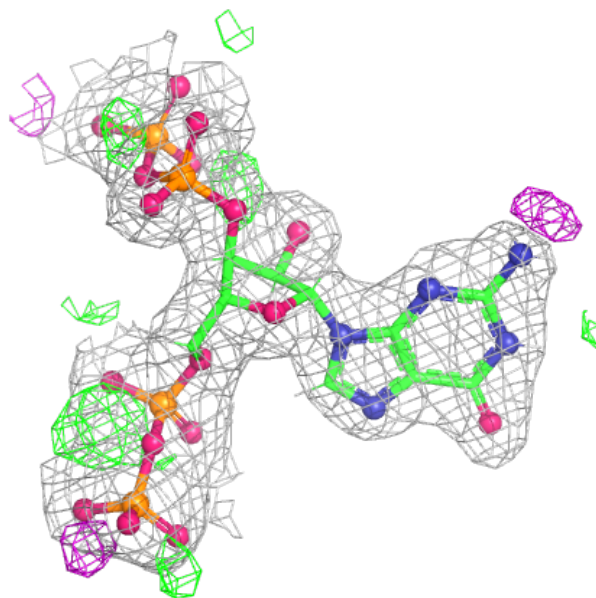

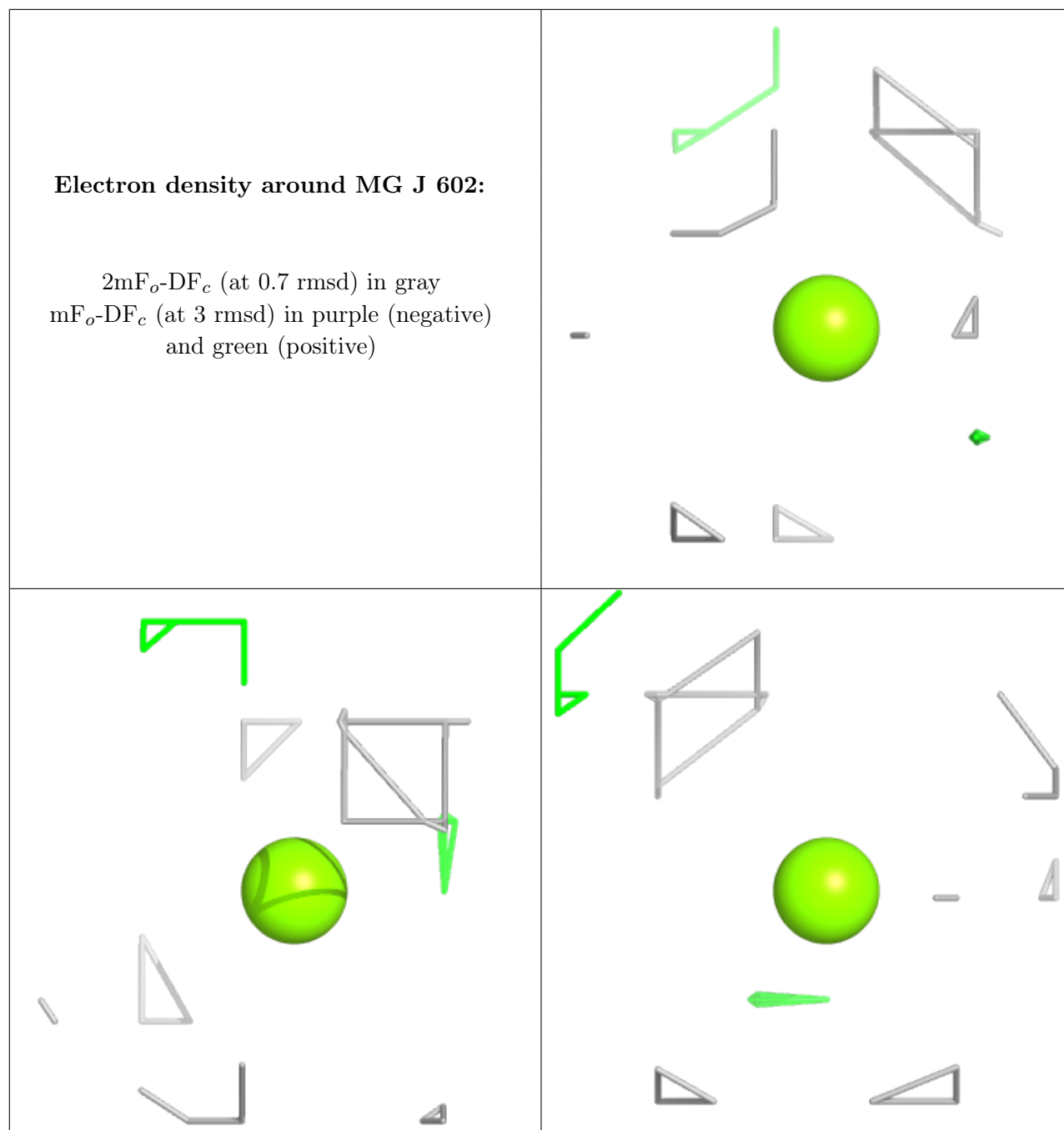

**Electron density around MG M 603:**

$2mF_o-DF_c$  (at 0.7 rmsd) in gray  
 $mF_o-DF_c$  (at 3 rmsd) in purple (negative)  
and green (positive)

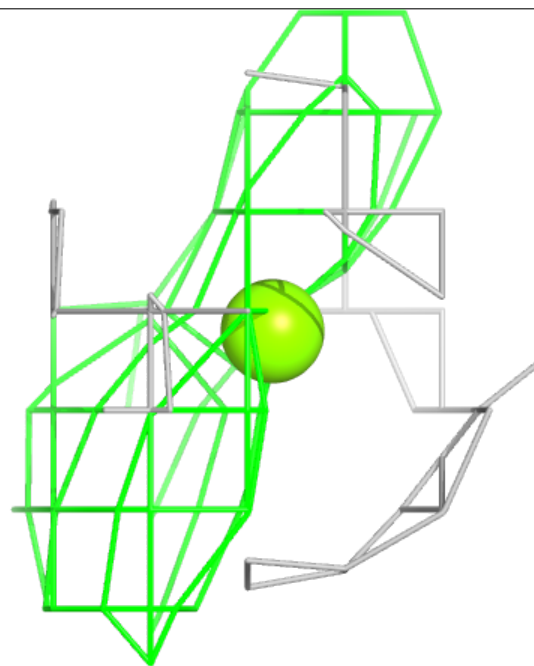
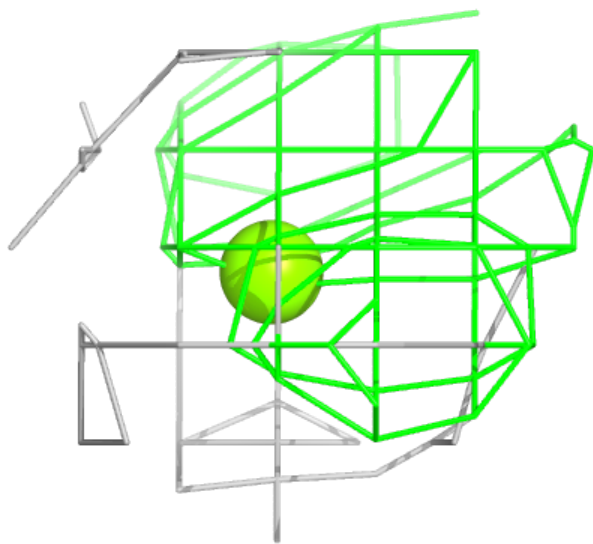
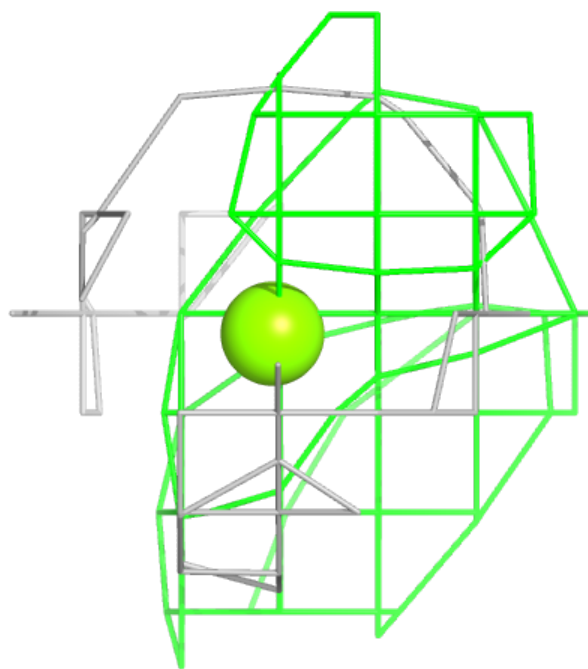

**Electron density around MG N 602:**

$2mF_o-DF_c$  (at 0.7 rmsd) in gray  
 $mF_o-DF_c$  (at 3 rmsd) in purple (negative)  
and green (positive)

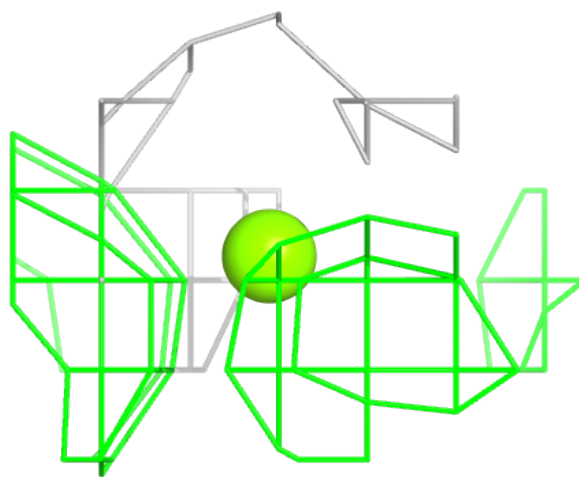
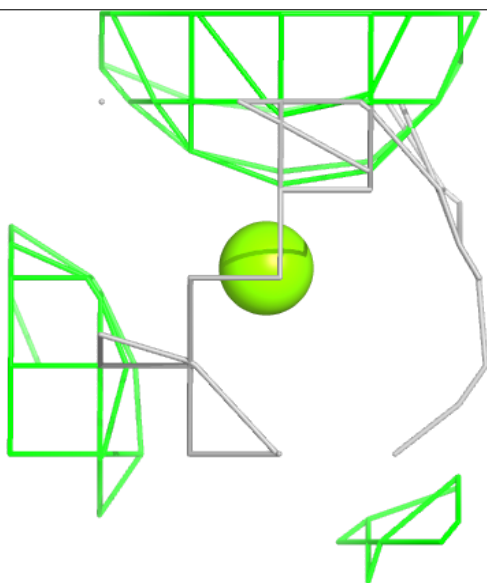
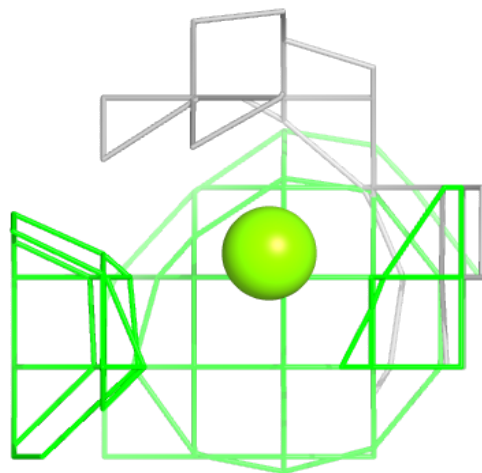

**Electron density around G4P B 601:**

$2mF_o-DF_c$  (at 0.7 rmsd) in gray  
 $mF_o-DF_c$  (at 3 rmsd) in purple (negative)  
and green (positive)

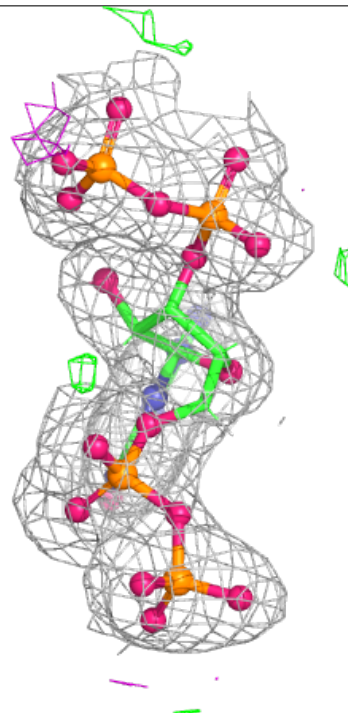
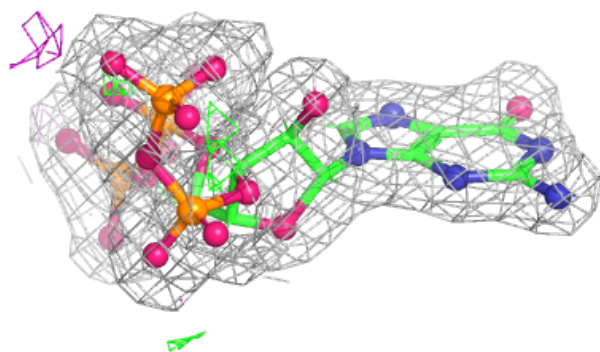
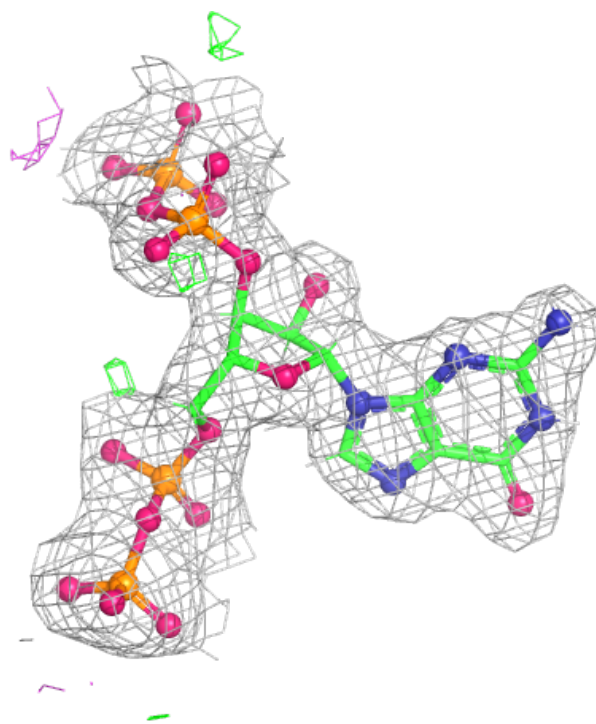

**Electron density around G4P C 601:**

$2mF_o-DF_c$  (at 0.7 rmsd) in gray  
 $mF_o-DF_c$  (at 3 rmsd) in purple (negative)  
and green (positive)

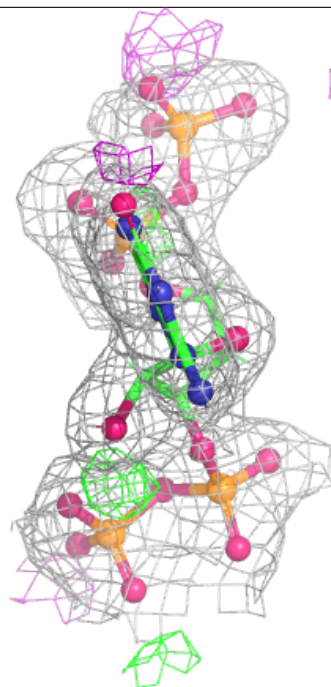
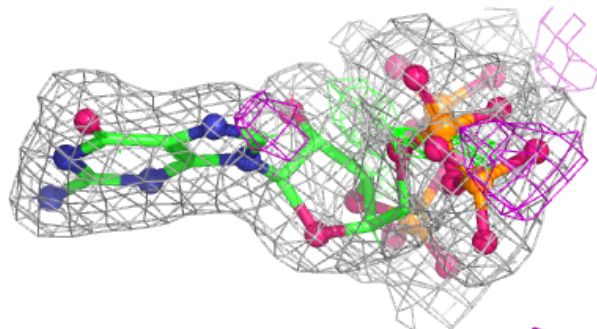
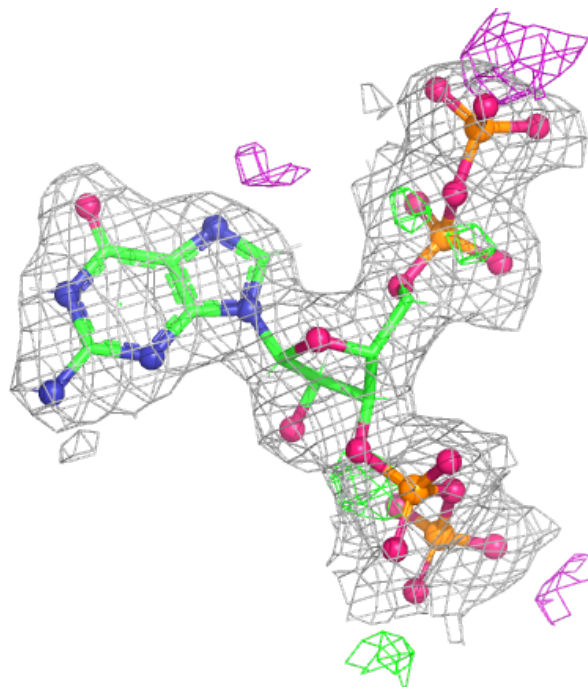

**Electron density around MG O 603:**

$2mF_o-DF_c$  (at 0.7 rmsd) in gray  
 $mF_o-DF_c$  (at 3 rmsd) in purple (negative)  
and green (positive)

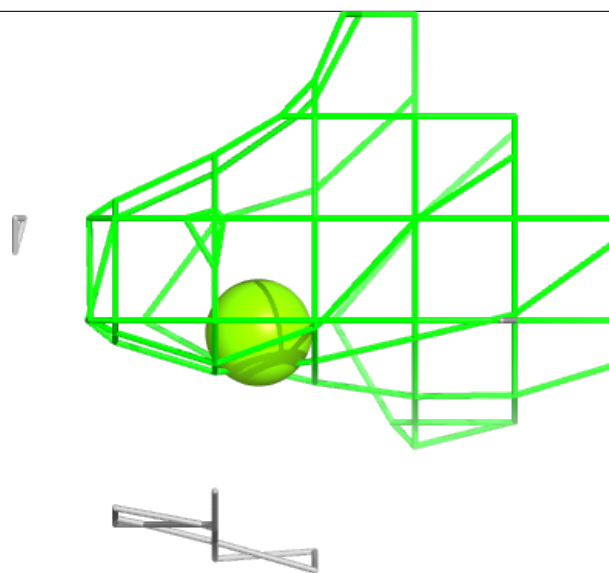
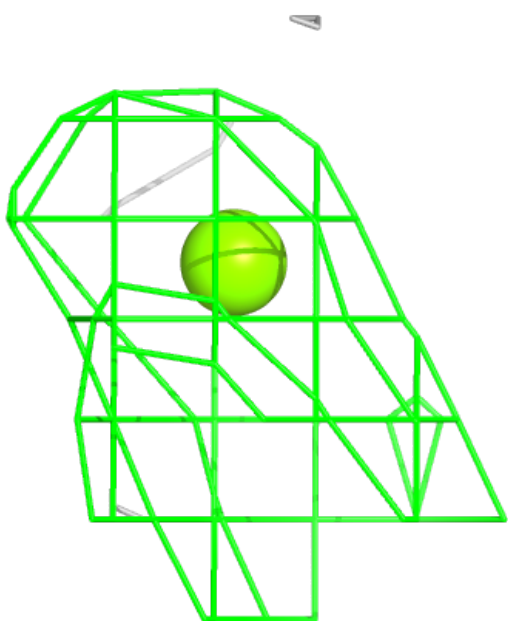
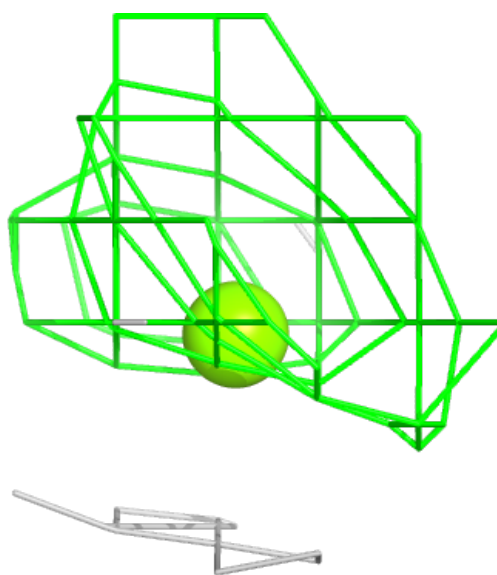

**Electron density around G4P D 601:**

$2mF_o-DF_c$  (at 0.7 rmsd) in gray  
 $mF_o-DF_c$  (at 3 rmsd) in purple (negative)  
and green (positive)

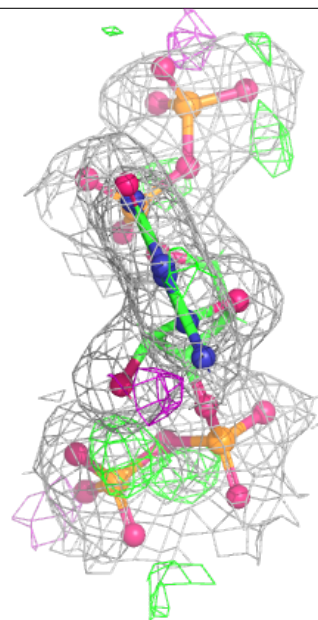
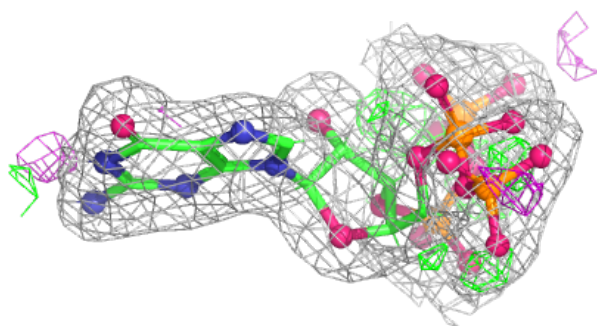
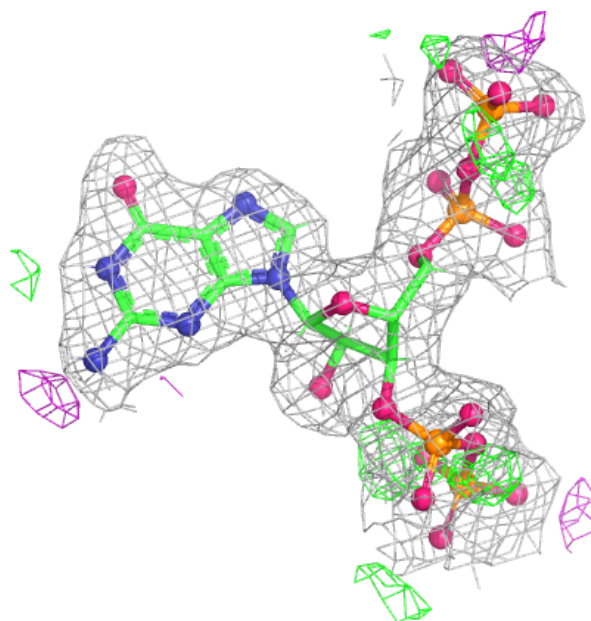



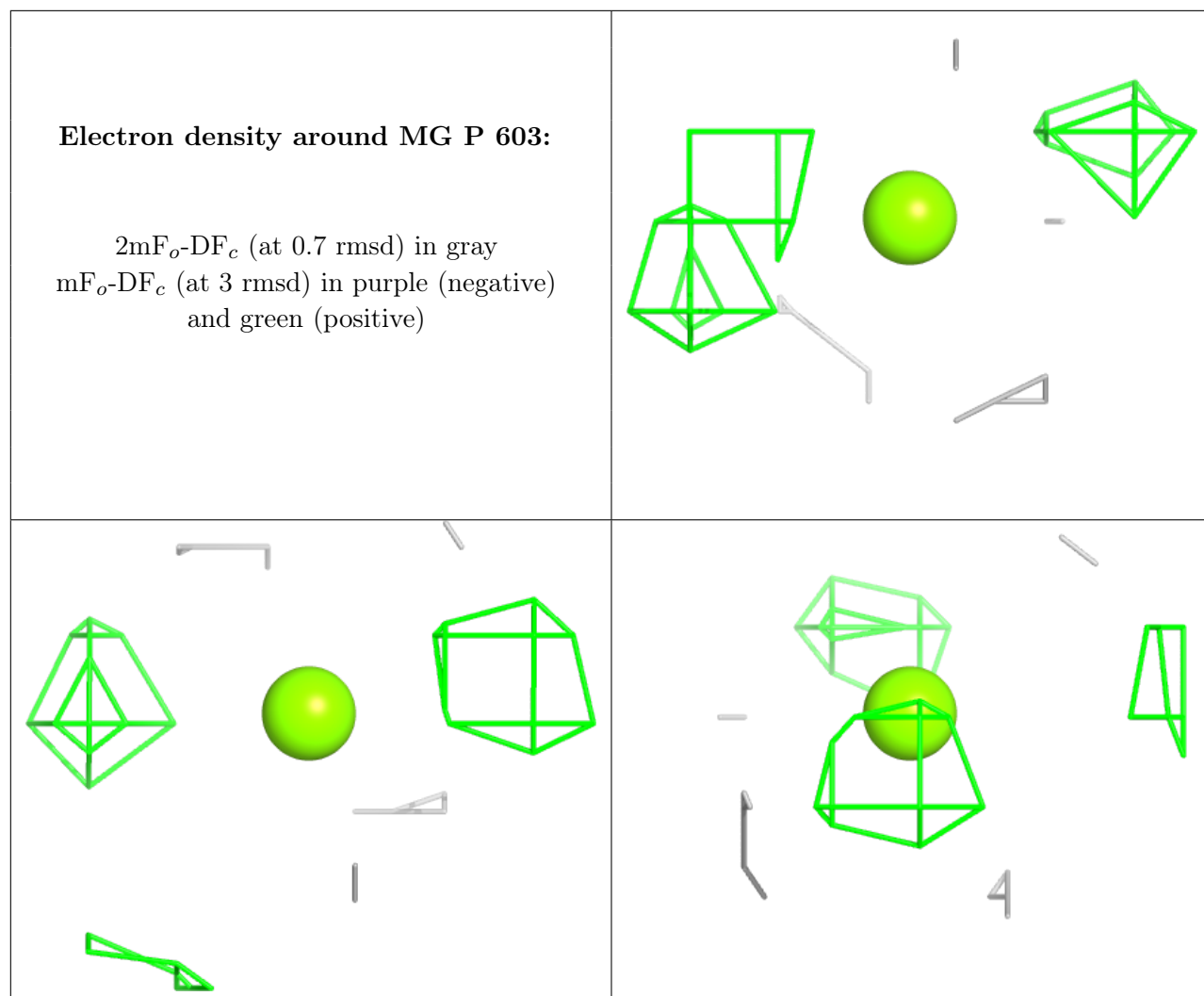

**Electron density around ATP E 600:**

$2mF_o-DF_c$  (at 0.7 rmsd) in gray  
 $mF_o-DF_c$  (at 3 rmsd) in purple (negative)  
and green (positive)

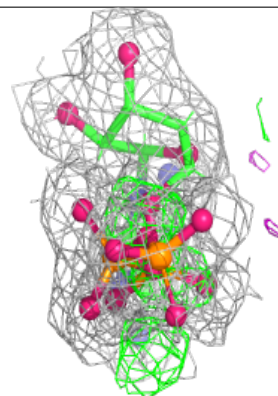
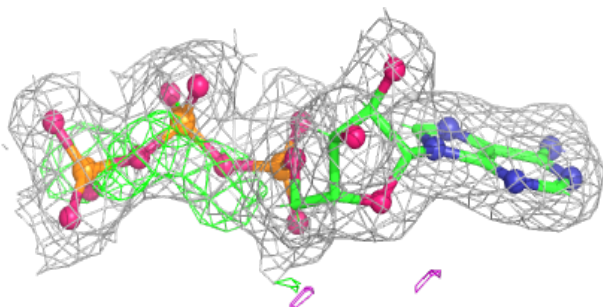
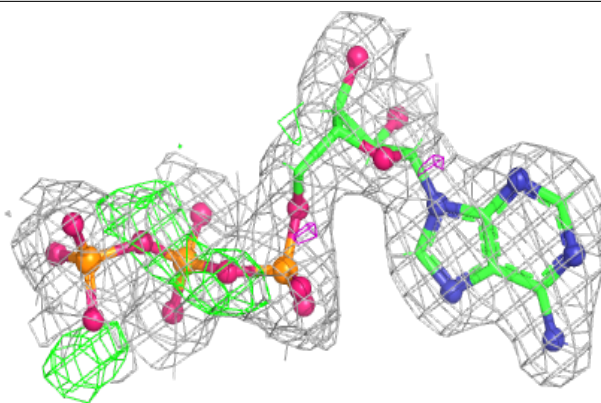
**Electron density around ATP H 600:**

$2mF_o-DF_c$  (at 0.7 rmsd) in gray  
 $mF_o-DF_c$  (at 3 rmsd) in purple (negative)  
and green (positive)

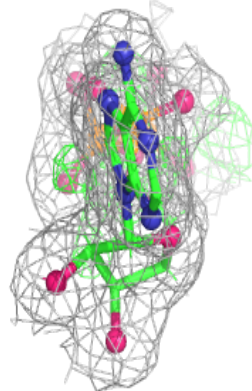
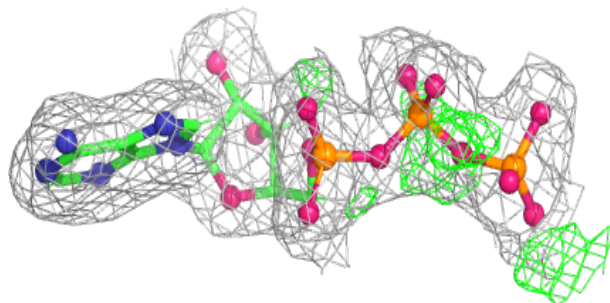
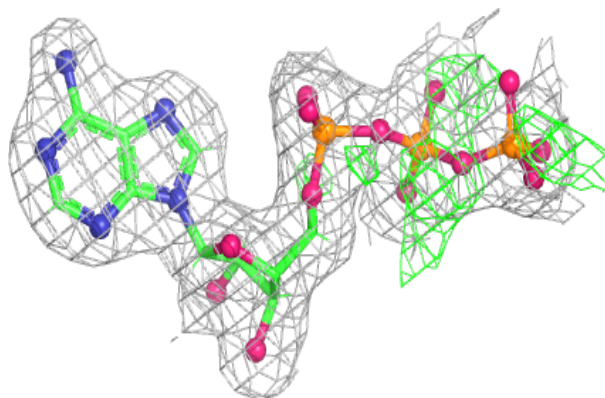

**Electron density around MG I 603:**

$2mF_o-DF_c$  (at 0.7 rmsd) in gray  
 $mF_o-DF_c$  (at 3 rmsd) in purple (negative)  
and green (positive)

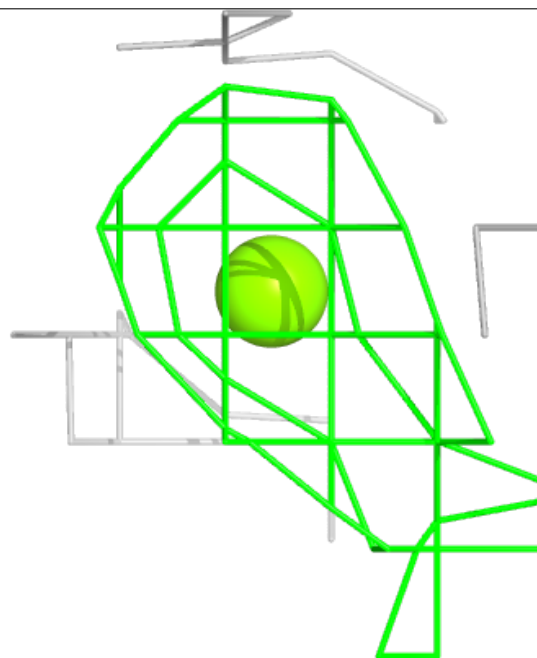
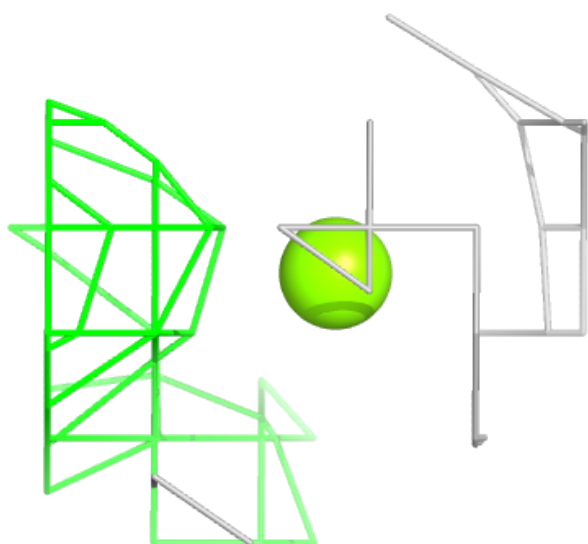
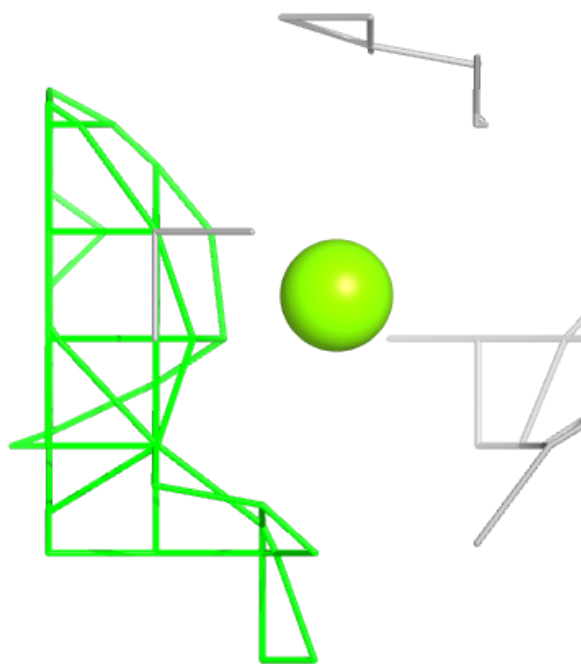

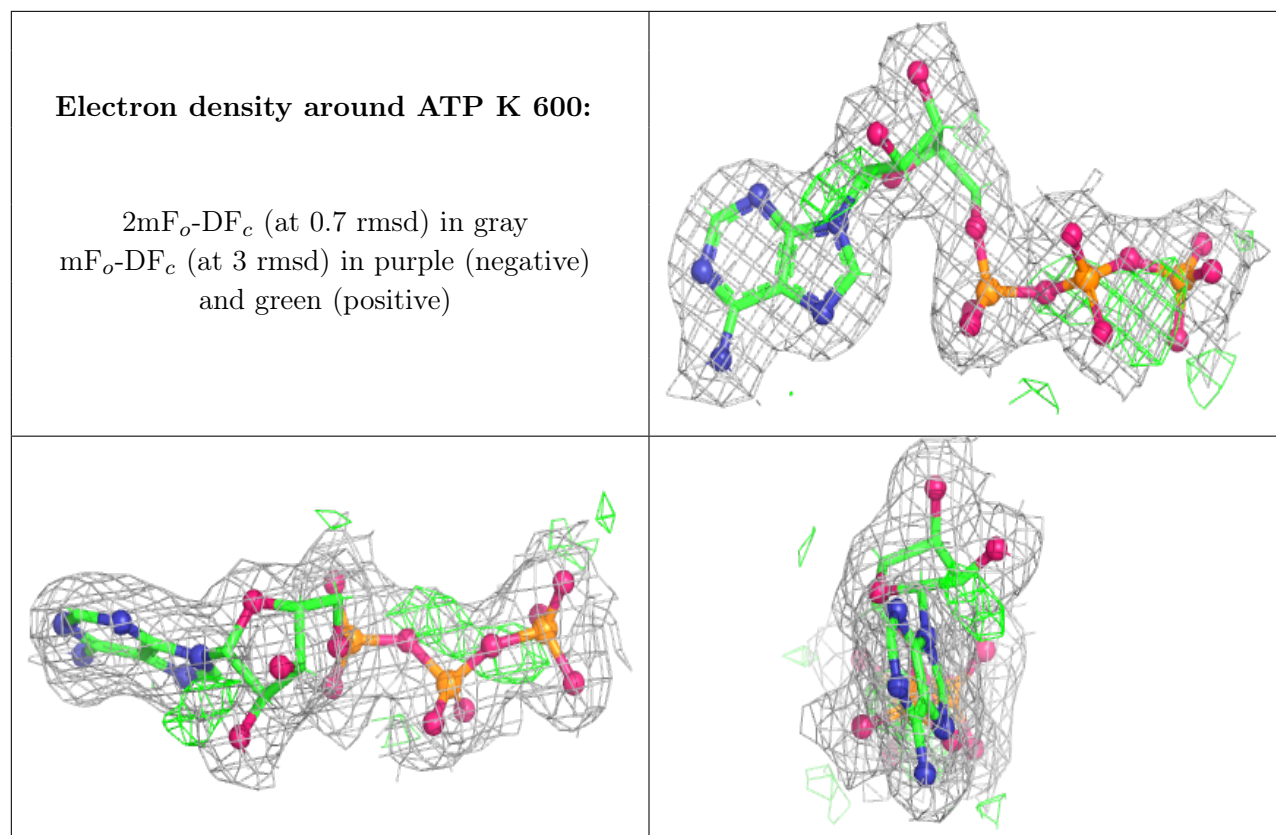

**Electron density around MG J 603:**

$2mF_o-DF_c$  (at 0.7 rmsd) in gray  
 $mF_o-DF_c$  (at 3 rmsd) in purple (negative)  
and green (positive)

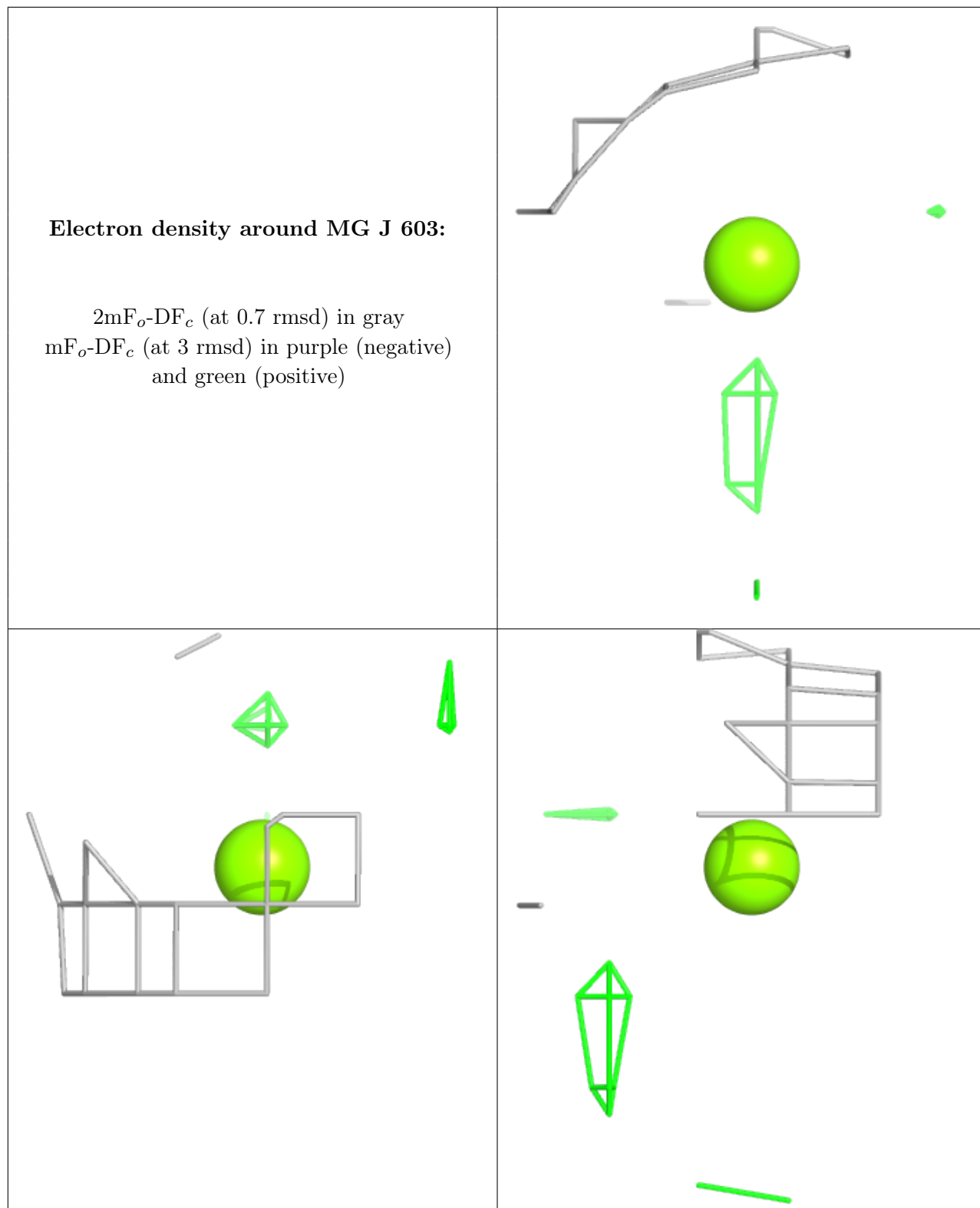

**Electron density around MG K 602:**

$2mF_o-DF_c$  (at 0.7 rmsd) in gray  
 $mF_o-DF_c$  (at 3 rmsd) in purple (negative)  
and green (positive)

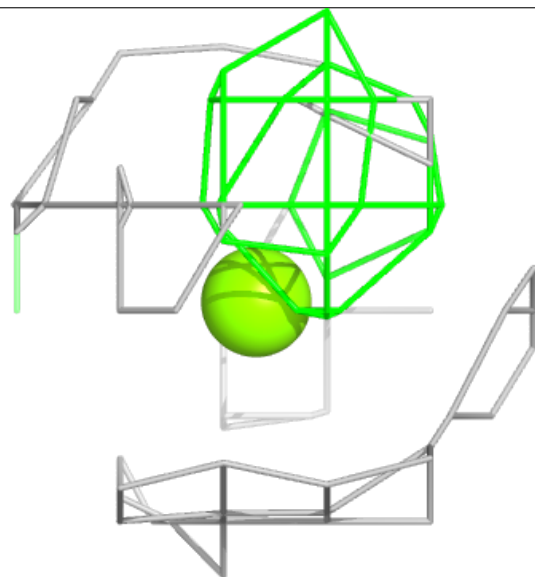
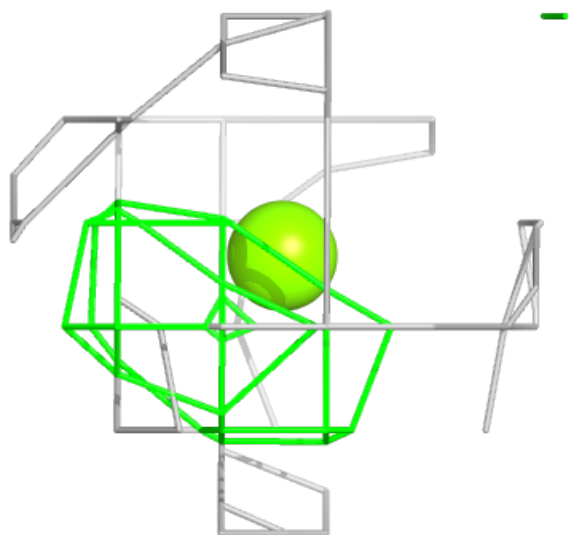
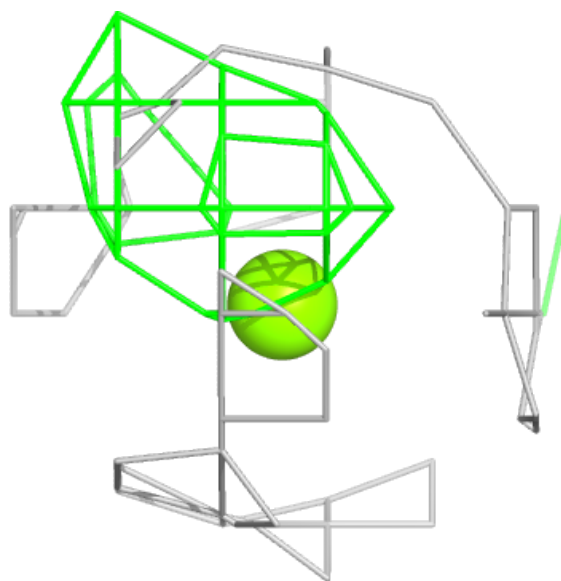

**Electron density around MG K 603:**

$2mF_o-DF_c$  (at 0.7 rmsd) in gray  
 $mF_o-DF_c$  (at 3 rmsd) in purple (negative)  
and green (positive)

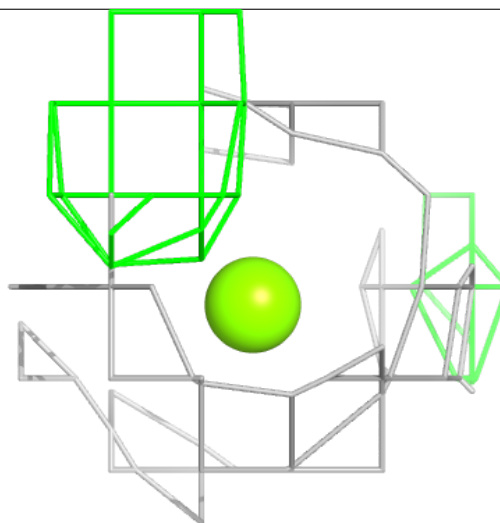
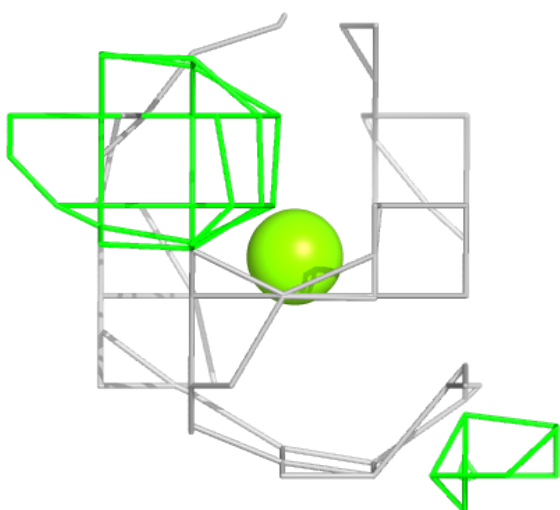
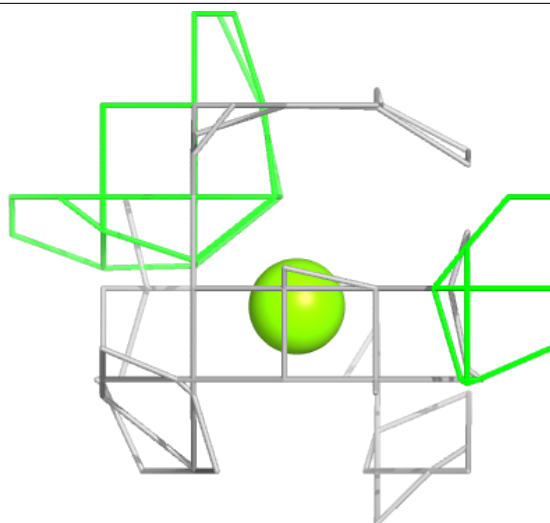

**Electron density around MG L 602:**

$2mF_o-DF_c$  (at 0.7 rmsd) in gray  
 $mF_o-DF_c$  (at 3 rmsd) in purple (negative)  
and green (positive)

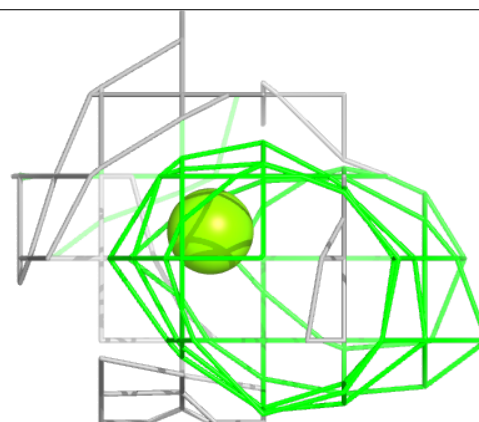
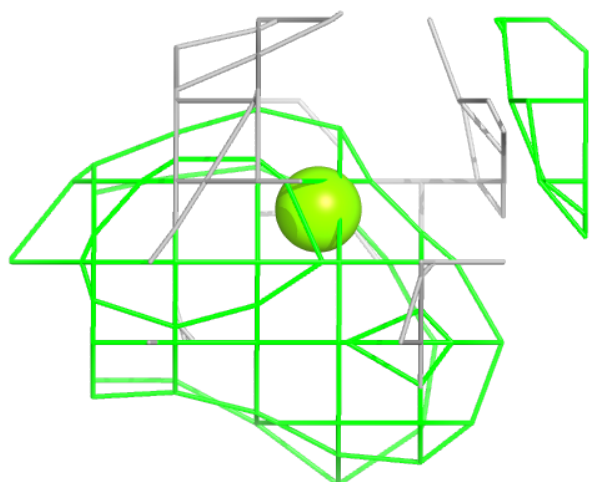
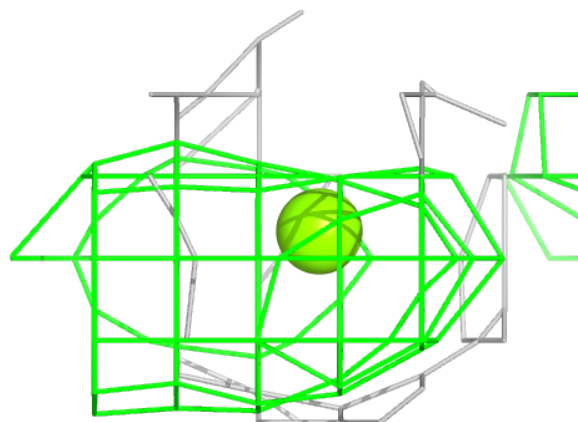



**Electron density around MG L 603:**

$2mF_o-DF_c$  (at 0.7 rmsd) in gray  
 $mF_o-DF_c$  (at 3 rmsd) in purple (negative)  
and green (positive)

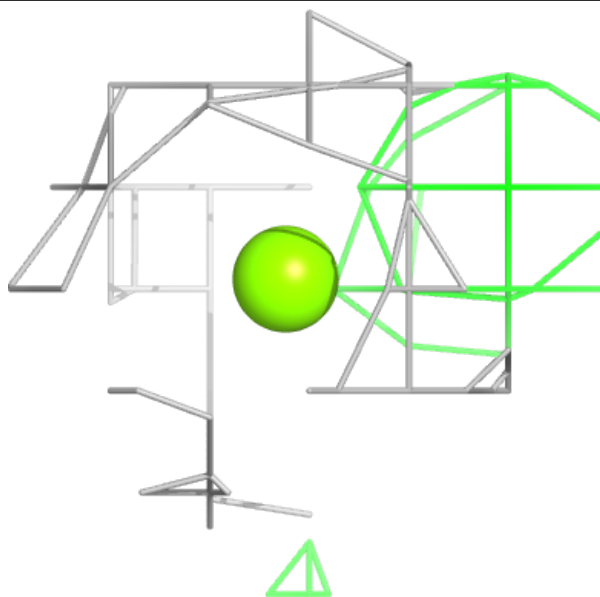
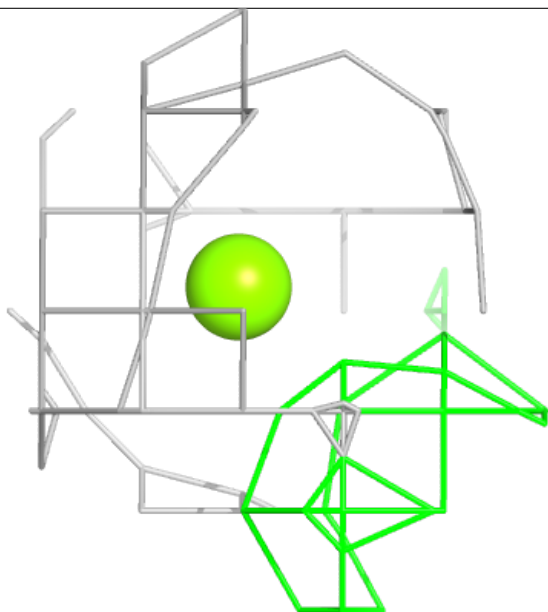
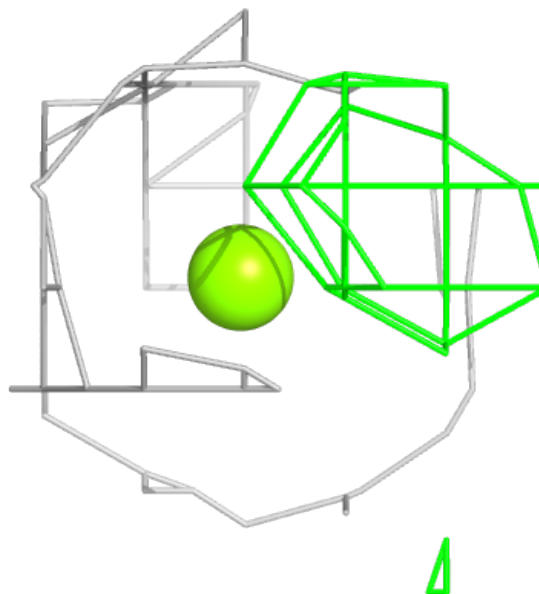

**Electron density around MG M 602:**

$2mF_o-DF_c$  (at 0.7 rmsd) in gray  
 $mF_o-DF_c$  (at 3 rmsd) in purple (negative)  
and green (positive)

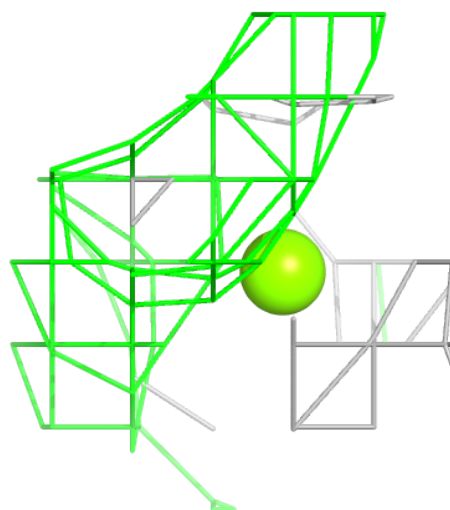
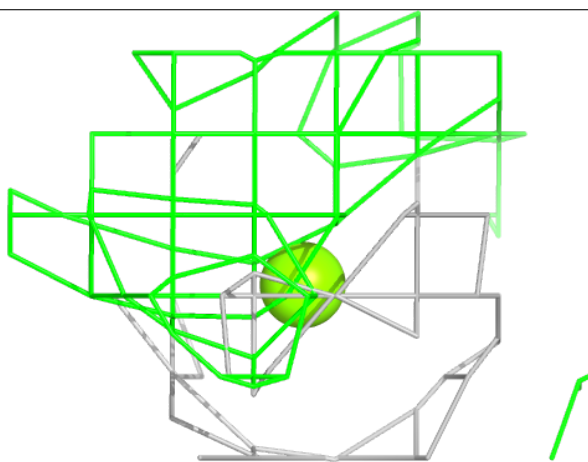
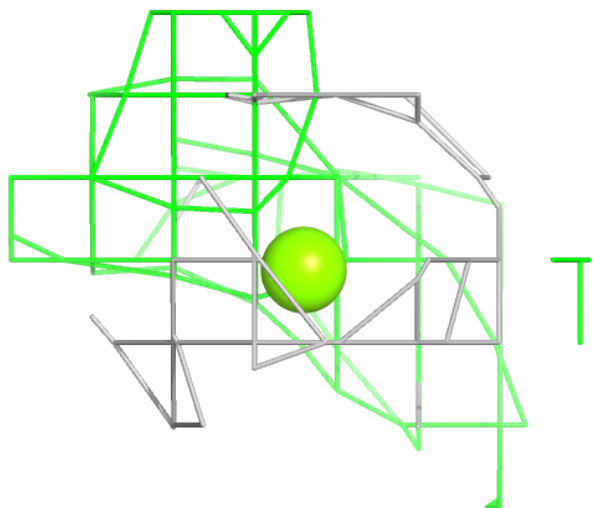

**Electron density around MG A 602:**

$2mF_o-DF_c$  (at 0.7 rmsd) in gray  
 $mF_o-DF_c$  (at 3 rmsd) in purple (negative)  
and green (positive)

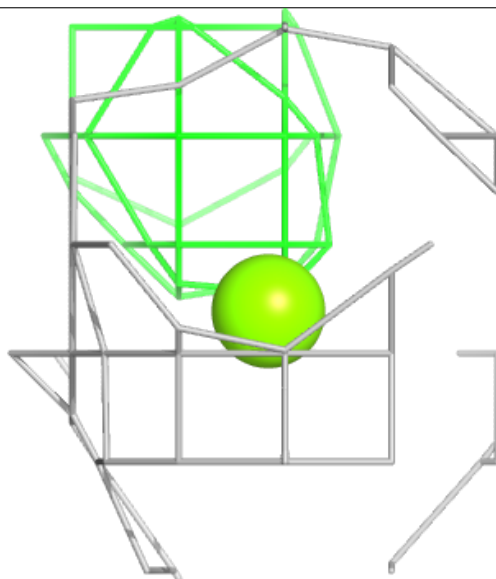
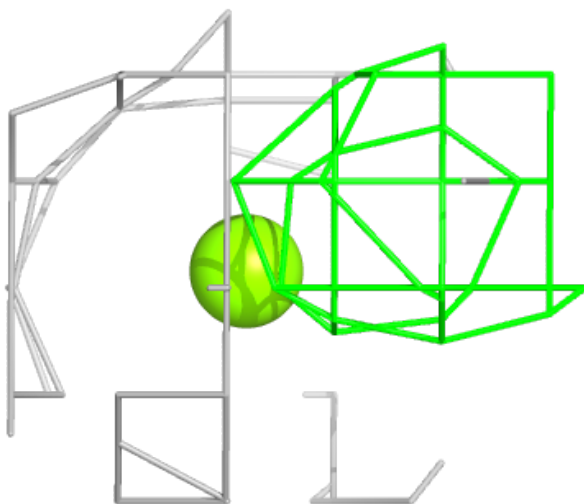
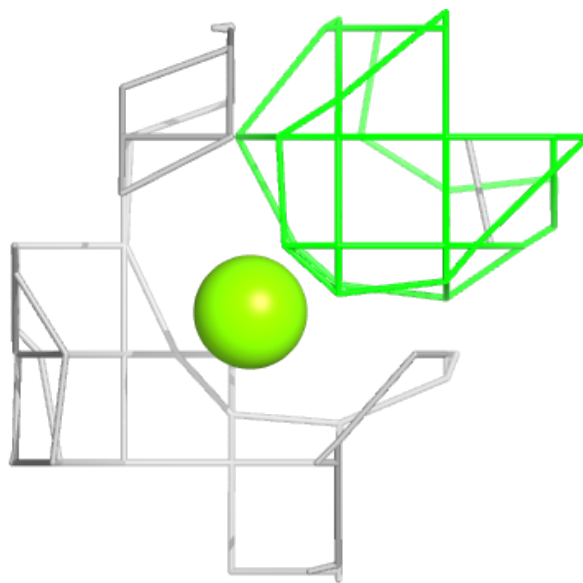

**Electron density around MG E 603:**

$2mF_o-DF_c$  (at 0.7 rmsd) in gray  
 $mF_o-DF_c$  (at 3 rmsd) in purple (negative)  
and green (positive)

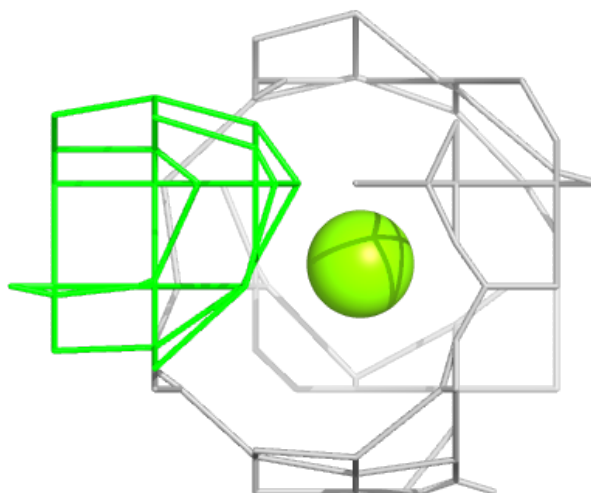
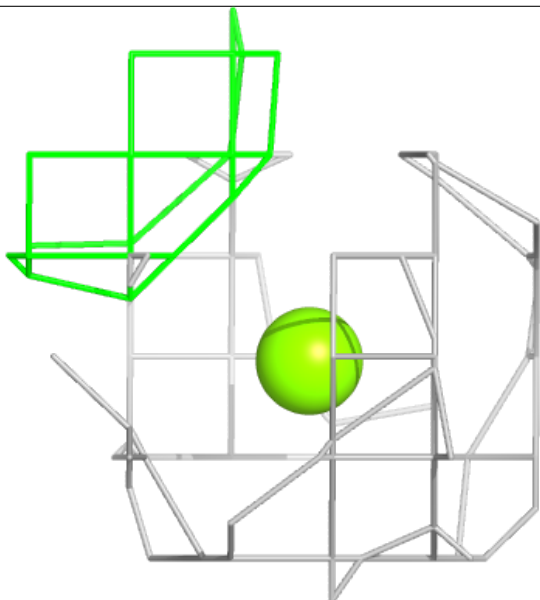
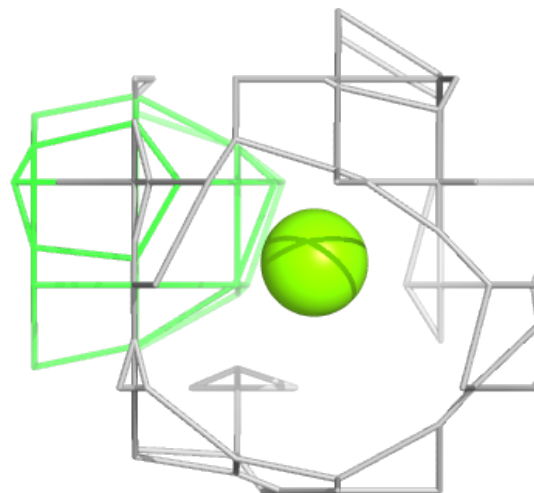

**Electron density around MG F 602:**

$2mF_o-DF_c$  (at 0.7 rmsd) in gray  
 $mF_o-DF_c$  (at 3 rmsd) in purple (negative)  
and green (positive)

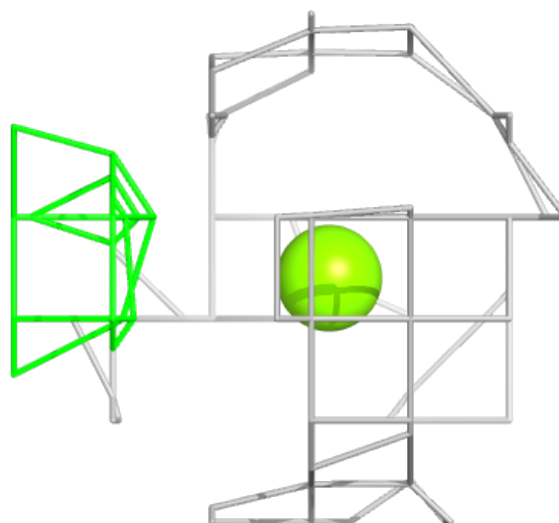
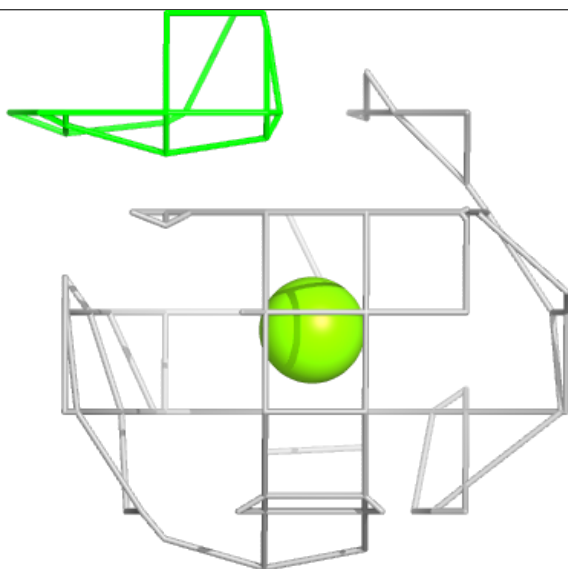
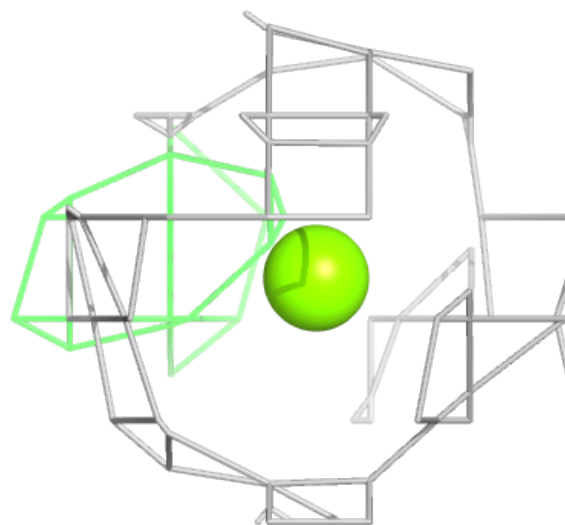

**Electron density around MG A 603:**

$2mF_o-DF_c$  (at 0.7 rmsd) in gray  
 $mF_o-DF_c$  (at 3 rmsd) in purple (negative)  
and green (positive)

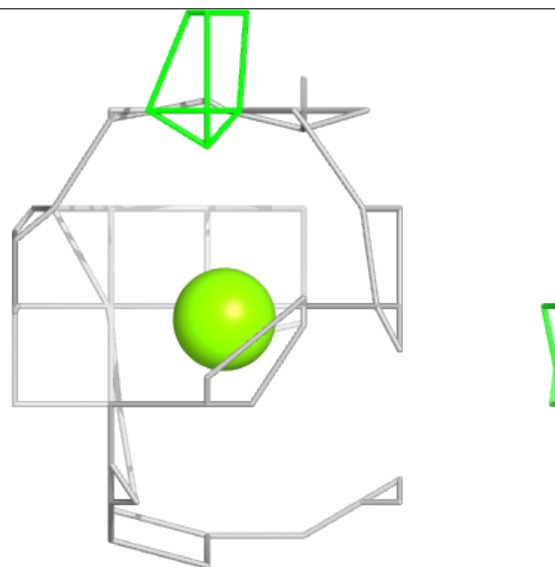
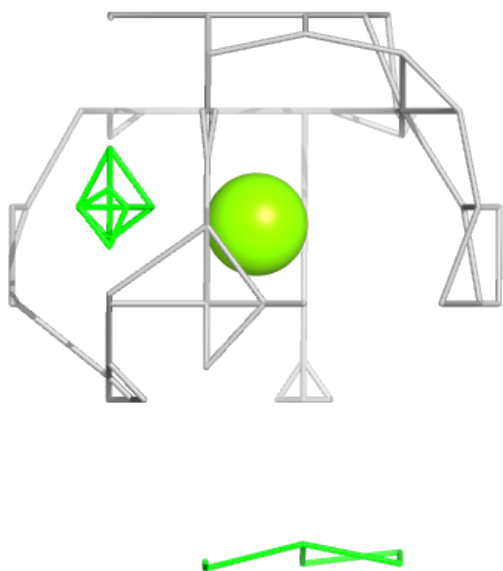
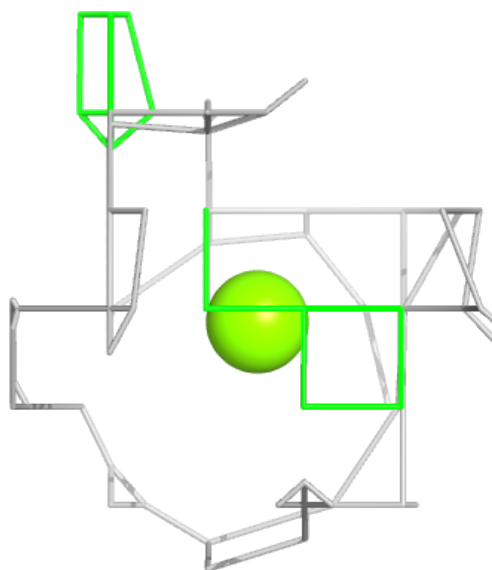

**Electron density around G4P L 601:**

$2mF_o-DF_c$  (at 0.7 rmsd) in gray  
 $mF_o-DF_c$  (at 3 rmsd) in purple (negative)  
and green (positive)

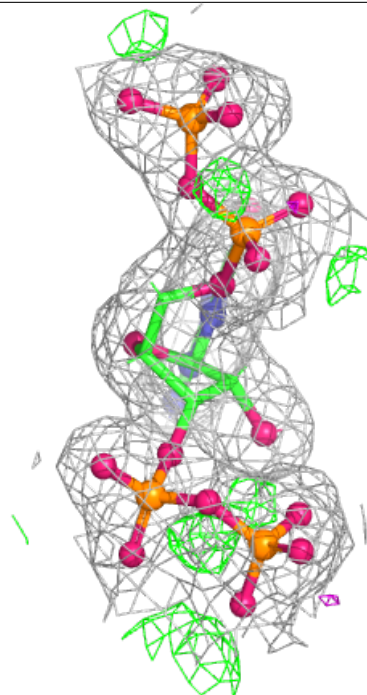
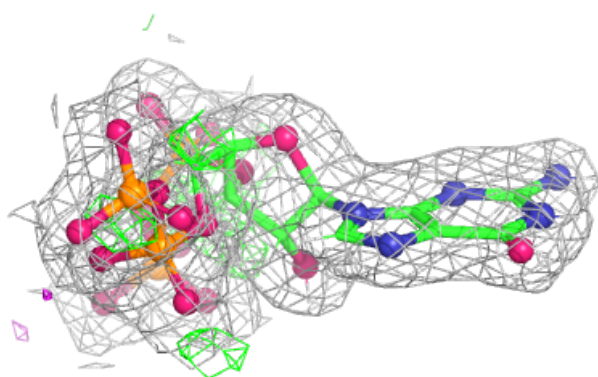
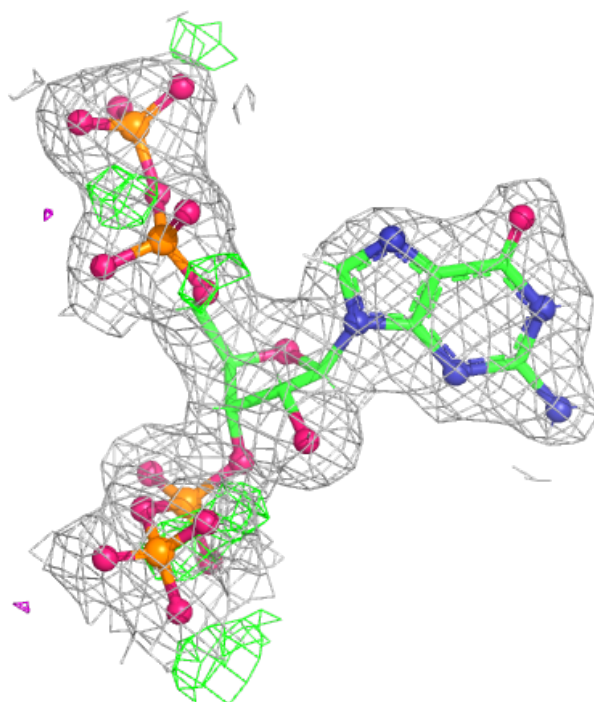

**Electron density around ATP L 600:**

$2mF_o-DF_c$  (at 0.7 rmsd) in gray  
 $mF_o-DF_c$  (at 3 rmsd) in purple (negative)  
and green (positive)

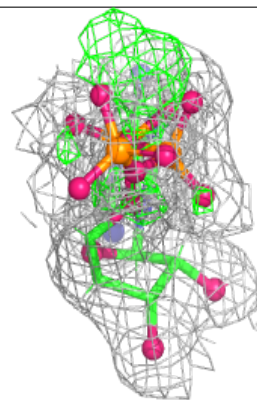
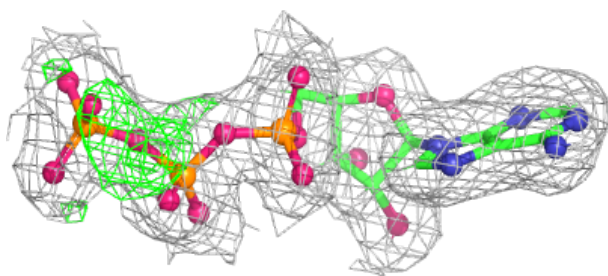
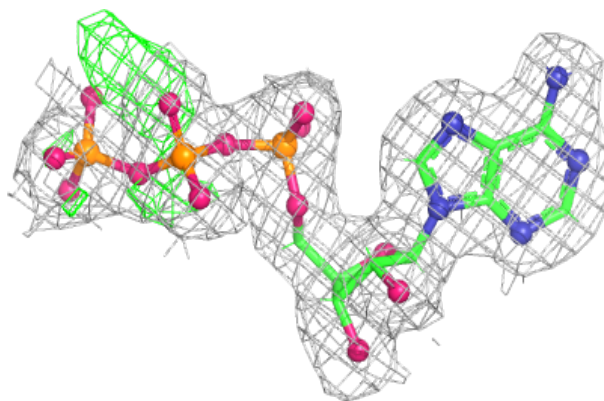



**Electron density around MG H 602:**

$2mF_o-DF_c$  (at 0.7 rmsd) in gray  
 $mF_o-DF_c$  (at 3 rmsd) in purple (negative)  
and green (positive)

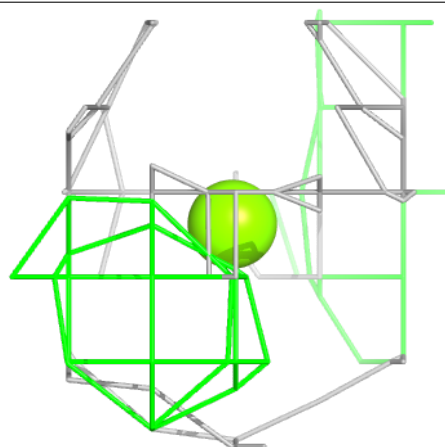
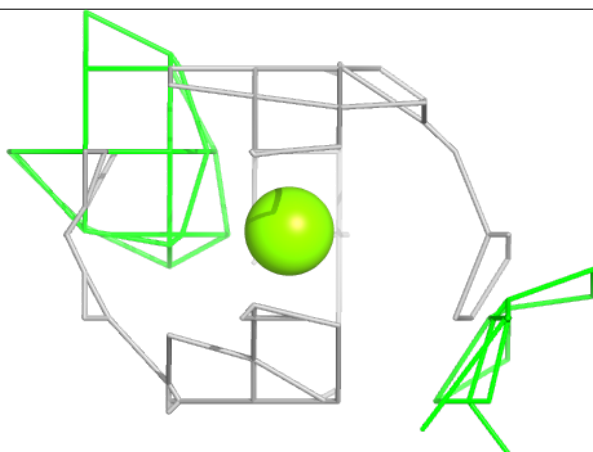
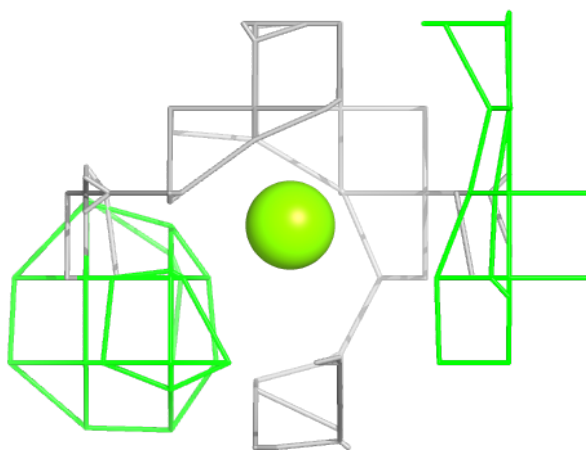

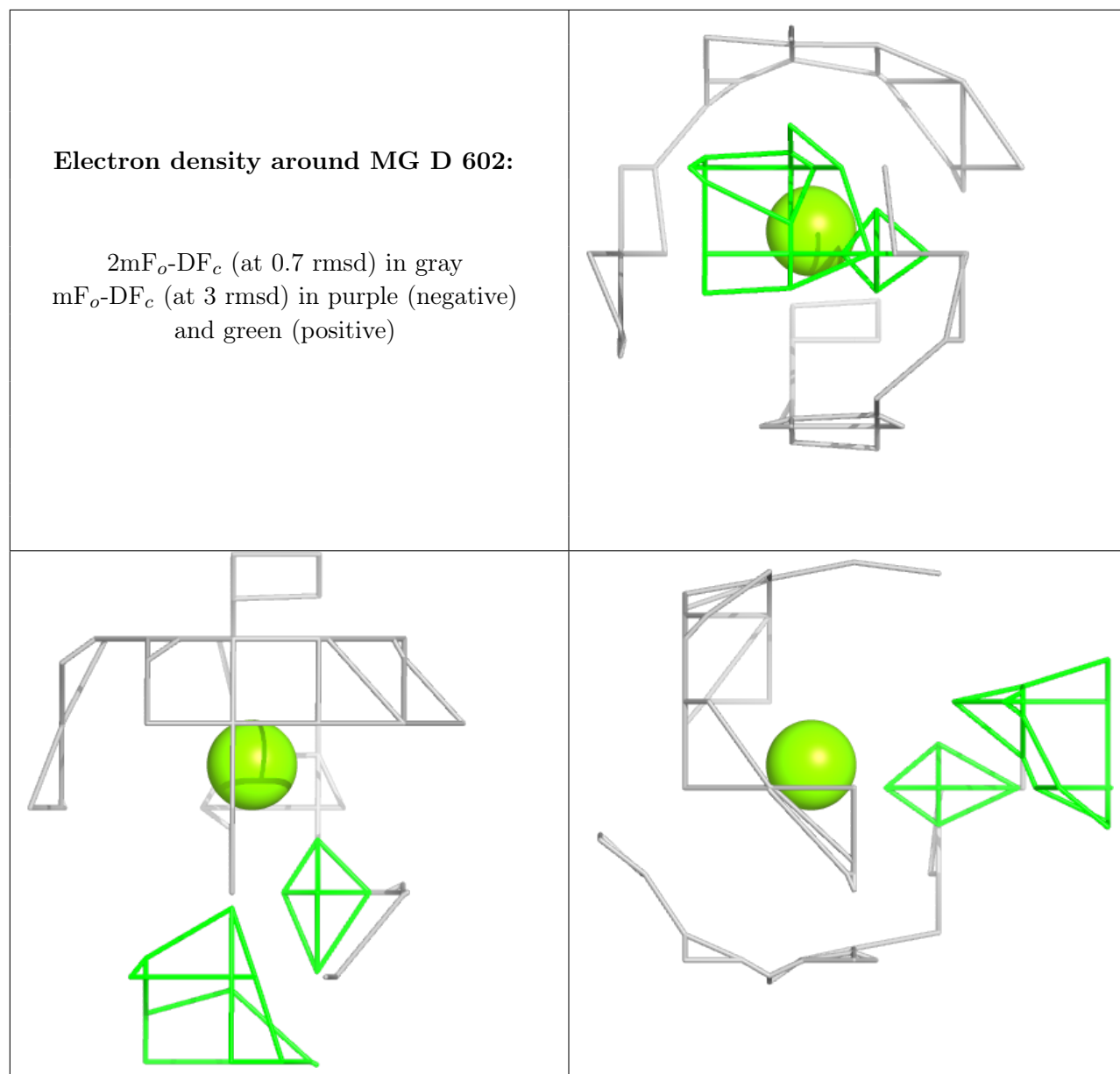

## 6.5 Other polymers [i](#)

There are no such residues in this entry.