



Full wwPDB X-ray Structure Validation Report ⓘ

Dec 14, 2021 – 12:08 pm GMT

PDB ID : 7PS7
Title : Crystal structure of the receptor binding domain of SARS-CoV-2 beta variant spike glycoprotein in complex with Beta-40 Fab
Authors : Zhou, D.; Ren, J.; Stuart, D.I.
Deposited on : 2021-09-22
Resolution : 3.90 Å(reported)

This is a Full wwPDB X-ray Structure Validation Report for a publicly released PDB entry.

We welcome your comments at validation@mail.wwpdb.org

A user guide is available at

<https://www.wwpdb.org/validation/2017/XrayValidationReportHelp>

with specific help available everywhere you see the ⓘ symbol.

The following versions of software and data (see [references ⓘ](#)) were used in the production of this report:

MolProbity : 4.02b-467
Xtriage (Phenix) : 1.13
EDS : 2.24
Percentile statistics : 20191225.v01 (using entries in the PDB archive December 25th 2019)
Refmac : 5.8.0267
CCP4 : 7.1.010 (Gargrove)
Ideal geometry (proteins) : Engh & Huber (2001)
Ideal geometry (DNA, RNA) : Parkinson et al. (1996)
Validation Pipeline (wwPDB-VP) : 2.24

1 Overall quality at a glance

The following experimental techniques were used to determine the structure:

X-RAY DIFFRACTION

The reported resolution of this entry is 3.90 Å.

Percentile scores (ranging between 0-100) for global validation metrics of the entry are shown in the following graphic. The table shows the number of entries on which the scores are based.

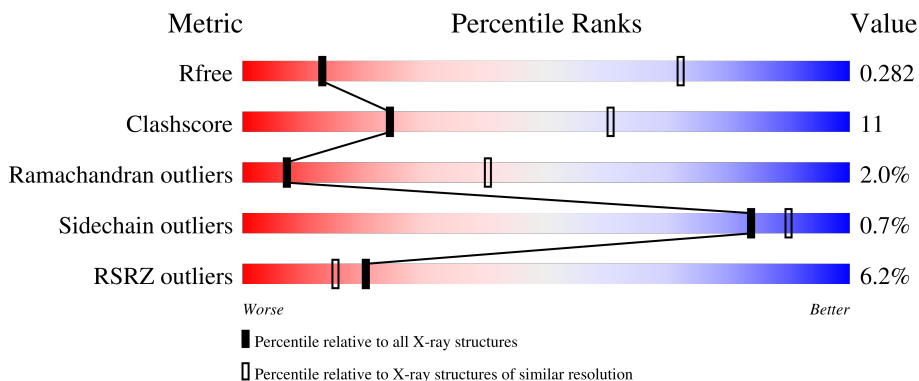

Metric	Whole archive (#Entries)	Similar resolution (#Entries, resolution range(Å))
R_{free}	130704	1002 (4.14-3.66)
Clashscore	141614	1004 (4.12-3.68)
Ramachandran outliers	138981	1021 (4.14-3.66)
Sidechain outliers	138945	1014 (4.14-3.66)
RSRZ outliers	127900	1275 (4.20-3.60)

The table below summarises the geometric issues observed across the polymeric chains and their fit to the electron density. The red, orange, yellow and green segments of the lower bar indicate the fraction of residues that contain outliers for ≥ 3 , 2, 1 and 0 types of geometric quality criteria respectively. A grey segment represents the fraction of residues that are not modelled. The numeric value for each fraction is indicated below the corresponding segment, with a dot representing fractions $\leq 5\%$. The upper red bar (where present) indicates the fraction of residues that have poor fit to the electron density. The numeric value is given above the bar.

Mol	Chain	Length	Quality of chain
1	E	210	 77% 14% 8%
1	R	210	 76% 14% 8%
2	B	213	 83% 15% ..
2	L	213	 81% 16% ..
3	A	228	 69% 26% ..

Continued on next page...

Continued from previous page...

Mol	Chain	Length	Quality of chain
3	H	228	 <p>A horizontal bar chart representing the quality of chain. The bar is divided into three segments: a small red segment on the left labeled '2%', a large green segment in the middle labeled '68%', and a yellow segment on the right labeled '26%'. The bar ends with a small grey segment and two dots.</p>

2 Entry composition i

There are 3 unique types of molecules in this entry. The entry contains 9460 atoms, of which 0 are hydrogens and 0 are deuteriums.

In the tables below, the ZeroOcc column contains the number of atoms modelled with zero occupancy, the AltConf column contains the number of residues with at least one atom in alternate conformation and the Trace column contains the number of residues modelled with at most 2 atoms.

- Molecule 1 is a protein called Spike protein S1.

Mol	Chain	Residues	Atoms					ZeroOcc	AltConf	Trace
			Total	C	N	O	S			
1	E	194	1537	987	256	286	8	0	0	0
1	R	194	1537	987	256	286	8	0	0	0

There are 38 discrepancies between the modelled and reference sequences:

Chain	Residue	Modelled	Actual	Comment	Reference
E	319	MET	-	initiating methionine	UNP P0DTC2
E	320	GLY	-	expression tag	UNP P0DTC2
E	321	CYS	-	expression tag	UNP P0DTC2
E	322	VAL	-	expression tag	UNP P0DTC2
E	323	ALA	-	expression tag	UNP P0DTC2
E	324	GLU	-	expression tag	UNP P0DTC2
E	325	THR	-	expression tag	UNP P0DTC2
E	326	GLY	-	expression tag	UNP P0DTC2
E	327	HIS	-	expression tag	UNP P0DTC2
E	328	HIS	-	expression tag	UNP P0DTC2
E	329	HIS	-	expression tag	UNP P0DTC2
E	330	HIS	-	expression tag	UNP P0DTC2
E	331	HIS	-	expression tag	UNP P0DTC2
E	332	HIS	-	expression tag	UNP P0DTC2
E	417	ASN	LYS	variant	UNP P0DTC2
E	484	LYS	GLU	variant	UNP P0DTC2
E	501	TYR	ASN	variant	UNP P0DTC2
E	527	LYS	-	expression tag	UNP P0DTC2
E	528	LYS	-	expression tag	UNP P0DTC2
R	319	MET	-	initiating methionine	UNP P0DTC2
R	320	GLY	-	expression tag	UNP P0DTC2
R	321	CYS	-	expression tag	UNP P0DTC2
R	322	VAL	-	expression tag	UNP P0DTC2
R	323	ALA	-	expression tag	UNP P0DTC2
R	324	GLU	-	expression tag	UNP P0DTC2

Continued on next page...

Continued from previous page...

Chain	Residue	Modelled	Actual	Comment	Reference
R	325	THR	-	expression tag	UNP P0DTC2
R	326	GLY	-	expression tag	UNP P0DTC2
R	327	HIS	-	expression tag	UNP P0DTC2
R	328	HIS	-	expression tag	UNP P0DTC2
R	329	HIS	-	expression tag	UNP P0DTC2
R	330	HIS	-	expression tag	UNP P0DTC2
R	331	HIS	-	expression tag	UNP P0DTC2
R	332	HIS	-	expression tag	UNP P0DTC2
R	417	ASN	LYS	variant	UNP P0DTC2
R	484	LYS	GLU	variant	UNP P0DTC2
R	501	TYR	ASN	variant	UNP P0DTC2
R	527	LYS	-	expression tag	UNP P0DTC2
R	528	LYS	-	expression tag	UNP P0DTC2

- Molecule 2 is a protein called Beta-40 Fab light chain.

Mol	Chain	Residues	Atoms					ZeroOcc	AltConf	Trace
			Total	C	N	O	S			
2	L	210	1553	961	267	319	6	0	0	0
2	B	210	1553	961	267	319	6	0	0	0

- Molecule 3 is a protein called Beta-40 heavy chain.

Mol	Chain	Residues	Atoms					ZeroOcc	AltConf	Trace
			Total	C	N	O	S			
3	A	221	1640	1042	269	324	5	0	0	0
3	H	221	1640	1042	269	324	5	0	0	0

3 Residue-property plots [i](#)

These plots are drawn for all protein, RNA, DNA and oligosaccharide chains in the entry. The first graphic for a chain summarises the proportions of the various outlier classes displayed in the second graphic. The second graphic shows the sequence view annotated by issues in geometry and electron density. Residues are color-coded according to the number of geometric quality criteria for which they contain at least one outlier: green = 0, yellow = 1, orange = 2 and red = 3 or more. A red dot above a residue indicates a poor fit to the electron density ($RSRZ > 2$). Stretches of 2 or more consecutive residues without any outlier are shown as a green connector. Residues present in the sample, but not in the model, are shown in grey.

- Molecule 1: Spike protein S1

Chain E: 

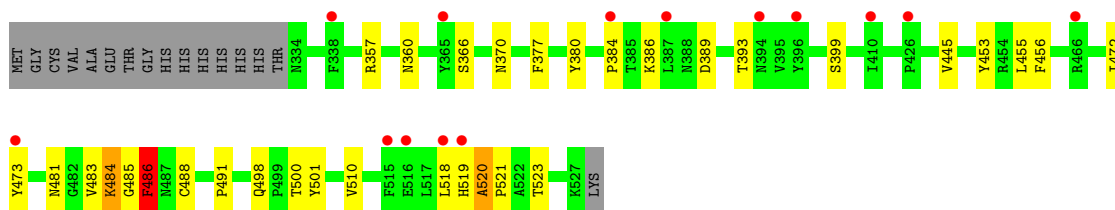

- Molecule 1: Spike protein S1

Chain R: 

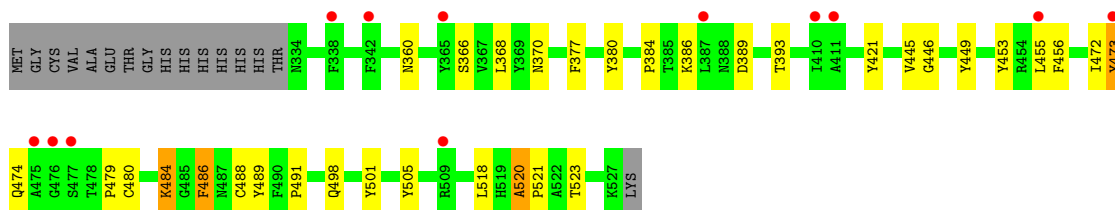

- Molecule 2: Beta-40 Fab light chain

Chain L: 

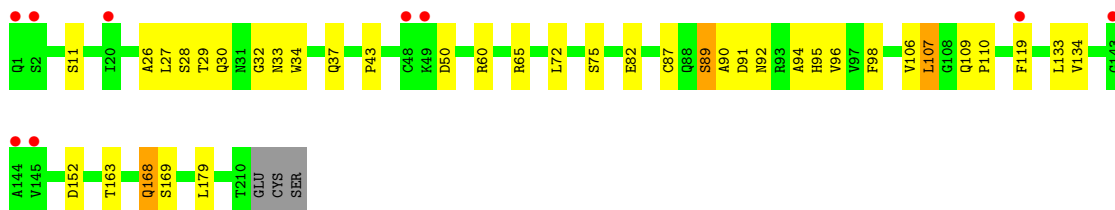

- Molecule 2: Beta-40 Fab light chain

Chain B: 



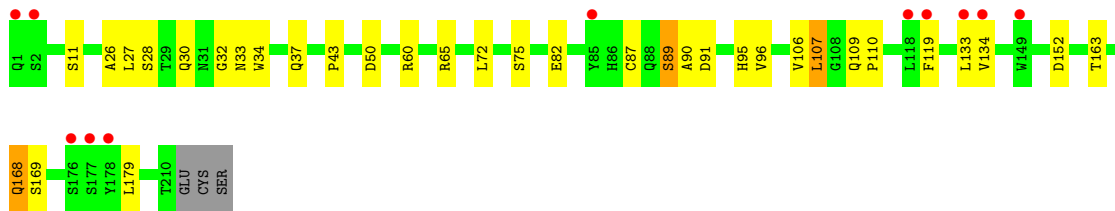

• Molecule 3: Beta-40 heavy chain

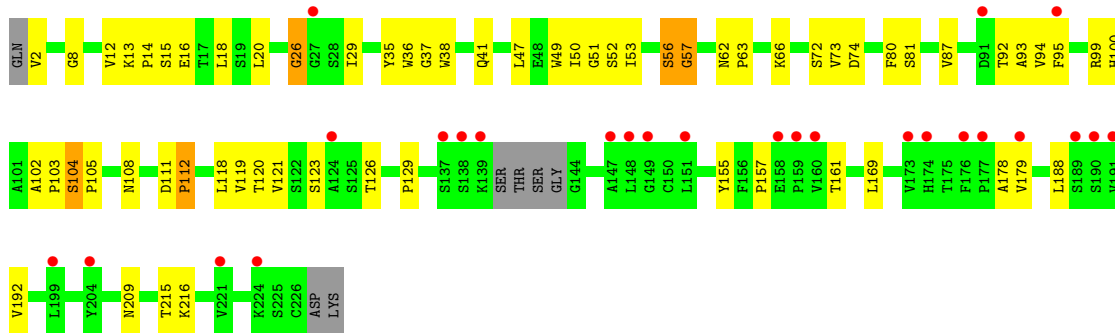

• Molecule 3: Beta-40 heavy chain

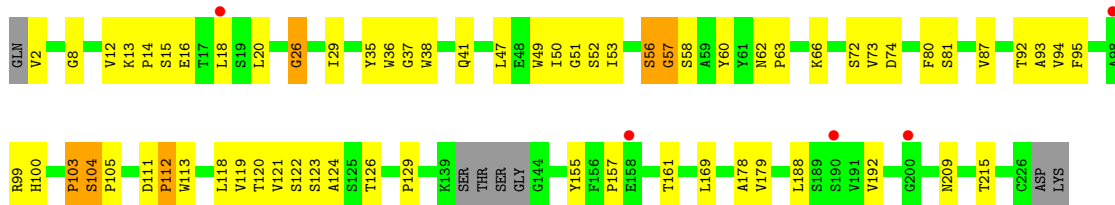

4 Data and refinement statistics

Property	Value	Source
Space group	P 1 21 1	Depositor
Cell constants a, b, c, α , β , γ	41.24Å 139.87Å 116.41Å 90.00° 100.05° 90.00°	Depositor
Resolution (Å)	57.31 – 3.90 59.70 – 3.90	Depositor EDS
% Data completeness (in resolution range)	98.9 (57.31-3.90) 98.5 (59.70-3.90)	Depositor EDS
R_{merge}	0.39	Depositor
R_{sym}	(Not available)	Depositor
$\langle I/\sigma(I) \rangle$ ¹	1.08 (at 3.88Å)	Xtrriage
Refinement program	PHENIX 1.19_4092	Depositor
R, R_{free}	0.233 , 0.284 0.235 , 0.282	Depositor DCC
R_{free} test set	570 reflections (4.81%)	wwPDB-VP
Wilson B-factor (Å ²)	137.2	Xtrriage
Anisotropy	0.329	Xtrriage
Bulk solvent k_{sol} (e/Å ³), B_{sol} (Å ²)	(Not available) , (Not available)	EDS
L-test for twinning ²	$\langle L \rangle = 0.37$, $\langle L^2 \rangle = 0.20$	Xtrriage
Estimated twinning fraction	0.138 for h,-k,-h-l	Xtrriage
F_o, F_c correlation	0.91	EDS
Total number of atoms	9460	wwPDB-VP
Average B, all atoms (Å ²)	171.0	wwPDB-VP

Xtrriage's analysis on translational NCS is as follows: *The largest off-origin peak in the Patterson function is 3.92% of the height of the origin peak. No significant pseudotranslation is detected.*

¹Intensities estimated from amplitudes.

²Theoretical values of $\langle |L| \rangle$, $\langle L^2 \rangle$ for acentric reflections are 0.5, 0.333 respectively for untwinned datasets, and 0.375, 0.2 for perfectly twinned datasets.

5 Model quality i

5.1 Standard geometry i

The Z score for a bond length (or angle) is the number of standard deviations the observed value is removed from the expected value. A bond length (or angle) with $|Z| > 5$ is considered an outlier worth inspection. RMSZ is the root-mean-square of all Z scores of the bond lengths (or angles).

Mol	Chain	Bond lengths		Bond angles	
		RMSZ	# Z >5	RMSZ	# Z >5
1	E	0.89	6/1581 (0.4%)	0.79	10/2152 (0.5%)
1	R	0.92	6/1581 (0.4%)	0.78	11/2152 (0.5%)
2	B	0.30	0/1588	0.52	0/2171
2	L	0.32	0/1588	0.53	0/2171
3	A	0.30	0/1686	0.51	0/2308
3	H	0.29	0/1686	0.50	0/2308
All	All	0.58	12/9710 (0.1%)	0.62	21/13262 (0.2%)

Chiral center outliers are detected by calculating the chiral volume of a chiral center and verifying if the center is modelled as a planar moiety or with the opposite hand. A planarity outlier is detected by checking planarity of atoms in a peptide group, atoms in a mainchain group or atoms of a sidechain that are expected to be planar.

Mol	Chain	#Chirality outliers	#Planarity outliers
1	E	0	1
1	R	0	1
All	All	0	2

All (12) bond length outliers are listed below:

Mol	Chain	Res	Type	Atoms	Z	Observed(Å)	Ideal(Å)
1	R	380	TYR	CE1-CZ	-16.33	1.17	1.38
1	E	380	TYR	CE1-CZ	-16.30	1.17	1.38
1	R	380	TYR	CE2-CZ	-16.23	1.17	1.38
1	E	380	TYR	CE2-CZ	-16.15	1.17	1.38
1	E	380	TYR	CG-CD2	-14.70	1.20	1.39
1	R	380	TYR	CG-CD1	-14.54	1.20	1.39
1	R	380	TYR	CG-CD2	-14.50	1.20	1.39
1	E	380	TYR	CG-CD1	-14.40	1.20	1.39
1	E	486	PHE	CE1-CZ	6.86	1.50	1.37
1	R	486	PHE	CE1-CZ	6.73	1.50	1.37
1	E	486	PHE	CB-CG	-5.78	1.41	1.51
1	R	486	PHE	CB-CG	-5.41	1.42	1.51

All (21) bond angle outliers are listed below:

Mol	Chain	Res	Type	Atoms	Z	Observed(°)	Ideal(°)
1	E	486	PHE	CB-CG-CD2	-11.85	112.51	120.80
1	R	486	PHE	CB-CG-CD2	-10.63	113.36	120.80
1	E	380	TYR	CZ-CE2-CD2	7.90	126.91	119.80
1	R	380	TYR	CZ-CE2-CD2	7.89	126.91	119.80
1	R	380	TYR	CD1-CE1-CZ	7.84	126.86	119.80
1	E	380	TYR	CD1-CE1-CZ	7.83	126.85	119.80
1	E	484	LYS	CD-CE-NZ	7.79	129.62	111.70
1	E	380	TYR	CE1-CZ-CE2	-6.78	108.95	119.80
1	R	380	TYR	CE1-CZ-CE2	-6.76	108.99	119.80
1	R	484	LYS	CD-CE-NZ	6.69	127.09	111.70
1	R	380	TYR	CD1-CG-CD2	-6.63	110.61	117.90
1	E	380	TYR	CD1-CG-CD2	-6.58	110.66	117.90
1	E	380	TYR	CB-CG-CD1	6.26	124.76	121.00
1	E	486	PHE	CB-CG-CD1	6.21	125.15	120.80
1	R	380	TYR	CB-CG-CD1	6.16	124.69	121.00
1	R	380	TYR	CB-CG-CD2	6.15	124.69	121.00
1	E	380	TYR	CB-CG-CD2	5.96	124.57	121.00
1	E	486	PHE	CG-CD1-CE1	-5.61	114.63	120.80
1	R	480	CYS	CA-CB-SG	-5.29	104.47	114.00
1	R	486	PHE	CG-CD1-CE1	-5.13	115.16	120.80
1	R	486	PHE	CB-CG-CD1	5.08	124.36	120.80

There are no chirality outliers.

All (2) planarity outliers are listed below:

Mol	Chain	Res	Type	Group
1	E	486	PHE	Mainchain
1	R	479	PRO	Peptide

5.2 Too-close contacts [\(i\)](#)

In the following table, the Non-H and H(model) columns list the number of non-hydrogen atoms and hydrogen atoms in the chain respectively. The H(added) column lists the number of hydrogen atoms added and optimized by MolProbity. The Clashes column lists the number of clashes within the asymmetric unit, whereas Symm-Clashes lists symmetry-related clashes.

Mol	Chain	Non-H	H(model)	H(added)	Clashes	Symm-Clashes
1	E	1537	0	1451	25	0
1	R	1537	0	1450	42	0
2	B	1553	0	1504	24	0

Continued on next page...

Continued from previous page...

Mol	Chain	Non-H	H(model)	H(added)	Clashes	Symm-Clashes
2	L	1553	0	1504	28	0
3	A	1640	0	1596	53	0
3	H	1640	0	1596	57	0
All	All	9460	0	9101	204	0

The all-atom clashscore is defined as the number of clashes found per 1000 atoms (including hydrogen atoms). The all-atom clashscore for this structure is 11.

All (204) close contacts within the same asymmetric unit are listed below, sorted by their clash magnitude.

Atom-1	Atom-2	Interatomic distance (Å)	Clash overlap (Å)
3:H:99:ARG:HB3	3:H:112:PRO:HD2	1.64	0.80
3:A:99:ARG:HB3	3:A:112:PRO:HD2	1.64	0.80
1:E:357:ARG:NE	1:R:421:TYR:OH	2.16	0.78
1:R:520:ALA:HB1	1:R:521:PRO:HD2	1.65	0.77
1:R:366:SER:O	1:R:370:ASN:ND2	2.21	0.73
1:E:393:THR:O	1:E:523:THR:OG1	2.06	0.73
3:A:2:VAL:HA	3:A:26:GLY:HA3	1.71	0.72
1:R:393:THR:O	1:R:523:THR:OG1	2.07	0.72
3:H:2:VAL:HA	3:H:26:GLY:HA3	1.71	0.71
2:L:32:GLY:N	2:L:50:ASP:OD1	2.25	0.69
1:E:472:ILE:HG21	1:E:488:CYS:SG	2.32	0.69
2:B:32:GLY:N	2:B:50:ASP:OD1	2.25	0.68
1:R:472:ILE:HG21	1:R:488:CYS:SG	2.34	0.68
3:A:35:TYR:HB2	3:A:100:HIS:HB3	1.76	0.68
2:L:95:HIS:CE1	3:H:63:PRO:HG3	2.29	0.67
3:A:87:VAL:HG11	3:A:121:VAL:HG21	1.75	0.67
1:R:520:ALA:HB1	1:R:521:PRO:CD	2.23	0.67
3:H:87:VAL:HG11	3:H:121:VAL:HG21	1.75	0.67
2:B:27:LEU:O	2:B:65:ARG:NH2	2.28	0.67
1:R:386:LYS:HE3	1:R:389:ASP:HB2	1.78	0.66
3:H:35:TYR:HB2	3:H:100:HIS:HB3	1.76	0.66
1:E:520:ALA:HB1	1:E:521:PRO:HD2	1.77	0.66
2:L:27:LEU:O	2:L:65:ARG:NH2	2.28	0.66
3:H:72:SER:OG	3:H:81:SER:OG	2.15	0.65
3:A:72:SER:OG	3:A:81:SER:OG	2.14	0.65
2:B:133:LEU:HD12	2:B:179:LEU:HD23	1.80	0.64
1:E:456:PHE:CD2	1:E:491:PRO:HA	2.34	0.62
2:L:133:LEU:HD12	2:L:179:LEU:HD23	1.80	0.62
2:L:168:GLN:HG3	2:L:169:SER:H	1.62	0.62
3:H:92:THR:HG23	3:H:120:THR:HA	1.81	0.62

Continued on next page...

Continued from previous page...

Atom-1	Atom-2	Interatomic distance (Å)	Clash overlap (Å)
3:A:92:THR:HG23	3:A:120:THR:HA	1.82	0.61
1:R:456:PHE:CD2	1:R:491:PRO:HA	2.34	0.61
1:R:456:PHE:CE2	1:R:489:TYR:CD2	2.89	0.61
1:E:456:PHE:HD2	1:E:491:PRO:HA	1.66	0.60
1:E:445:VAL:HG13	3:A:35:TYR:HE2	1.66	0.60
3:A:104:SER:HB3	3:A:105:PRO:CD	2.32	0.60
1:E:445:VAL:HG13	3:A:35:TYR:CE2	2.36	0.60
3:A:56:SER:OG	3:A:57:GLY:N	2.35	0.60
3:A:209:ASN:OD1	3:A:216:LYS:HG3	2.02	0.60
1:R:449:TYR:OH	2:L:94:ALA:HB2	2.02	0.60
2:B:95:HIS:CE1	3:A:63:PRO:HG3	2.36	0.60
2:B:168:GLN:HG3	2:B:169:SER:H	1.67	0.60
3:A:93:ALA:HB3	3:A:95:PHE:HE1	1.67	0.60
3:H:104:SER:HB3	3:H:105:PRO:CD	2.32	0.60
1:R:456:PHE:CB	1:R:473:TYR:HD2	2.15	0.59
1:R:456:PHE:HD2	1:R:491:PRO:HA	1.67	0.59
3:H:93:ALA:HB3	3:H:95:PHE:HE1	1.67	0.59
1:R:456:PHE:HB3	1:R:473:TYR:CD2	2.38	0.58
3:H:15:SER:N	3:H:87:VAL:O	2.32	0.57
1:R:456:PHE:HE2	1:R:489:TYR:CD2	2.21	0.57
3:H:56:SER:OG	3:H:57:GLY:N	2.37	0.57
1:E:498:GLN:HB2	1:E:501:TYR:CE1	2.39	0.57
1:R:473:TYR:HD1	1:R:474:GLN:N	2.03	0.57
3:H:111:ASP:HB3	3:H:112:PRO:HD3	1.87	0.57
1:R:498:GLN:HB2	1:R:501:TYR:CE1	2.39	0.57
3:H:87:VAL:CG1	3:H:121:VAL:HG21	2.34	0.57
3:A:111:ASP:HB3	3:A:112:PRO:HD3	1.86	0.57
3:A:87:VAL:CG1	3:A:121:VAL:HG21	2.34	0.56
3:A:161:THR:OG1	3:A:209:ASN:HB2	2.04	0.56
3:H:161:THR:OG1	3:H:209:ASN:HB2	2.06	0.56
1:R:456:PHE:HE2	1:R:489:TYR:CE2	2.24	0.56
2:L:82:GLU:HG3	2:L:106:VAL:HG23	1.89	0.55
1:E:520:ALA:HB1	1:E:521:PRO:CD	2.36	0.55
3:H:169:LEU:HD21	3:H:192:VAL:HG21	1.89	0.55
1:E:366:SER:O	1:E:370:ASN:ND2	2.40	0.55
1:R:456:PHE:CE2	1:R:489:TYR:HD2	2.25	0.54
2:B:37:GLN:OE1	2:B:43:PRO:HG3	2.07	0.54
3:A:169:LEU:HD21	3:A:192:VAL:HG21	1.89	0.54
3:H:13:LYS:HB2	3:H:16:GLU:OE2	2.08	0.54
1:E:386:LYS:HE3	1:E:389:ASP:HB2	1.90	0.54
2:L:168:GLN:HG3	2:L:169:SER:N	2.23	0.54

Continued on next page...

Continued from previous page...

Atom-1	Atom-2	Interatomic distance (Å)	Clash overlap (Å)
2:B:82:GLU:HG3	2:B:106:VAL:HG23	1.89	0.53
3:A:41:GLN:HB3	3:A:47:LEU:HD23	1.91	0.53
1:R:505:TYR:CE2	3:H:105:PRO:HD3	2.43	0.53
3:H:129:PRO:HD2	3:H:215:THR:HG21	1.90	0.53
2:L:37:GLN:OE1	2:L:43:PRO:HG3	2.08	0.53
3:A:15:SER:N	3:A:87:VAL:O	2.33	0.53
2:B:90:ALA:HB3	3:A:108:ASN:HD22	1.74	0.53
3:A:37:GLY:HA2	3:A:52:SER:HA	1.91	0.53
3:H:41:GLN:HB3	3:H:47:LEU:HD23	1.91	0.53
1:R:393:THR:HG21	1:R:518:LEU:HB3	1.91	0.52
1:R:449:TYR:HH	2:L:94:ALA:HB2	1.74	0.52
3:A:129:PRO:HD2	3:A:215:THR:HG21	1.90	0.51
1:E:453:TYR:HE2	1:E:455:LEU:HD13	1.75	0.51
3:H:129:PRO:HB3	3:H:155:TYR:HB3	1.92	0.51
3:A:87:VAL:HG12	3:A:121:VAL:HG11	1.92	0.51
3:H:87:VAL:HG12	3:H:121:VAL:HG11	1.91	0.51
2:L:11:SER:HB3	2:L:107:LEU:HG	1.93	0.51
1:E:393:THR:HG21	1:E:518:LEU:HB3	1.92	0.51
2:L:90:ALA:HA	2:L:95:HIS:O	2.11	0.51
3:H:38:TRP:HB3	3:H:50:ILE:HD12	1.93	0.51
1:R:456:PHE:HB3	1:R:473:TYR:HD2	1.75	0.50
2:B:90:ALA:HA	2:B:95:HIS:O	2.10	0.50
1:E:456:PHE:HB3	1:E:473:TYR:CD2	2.47	0.50
2:B:11:SER:HB3	2:B:107:LEU:HG	1.93	0.50
3:A:94:VAL:HG22	3:A:118:LEU:HB2	1.93	0.50
3:H:37:GLY:HA2	3:H:52:SER:HA	1.92	0.50
3:A:13:LYS:HB2	3:A:16:GLU:OE2	2.12	0.50
3:H:73:VAL:HG22	3:H:80:PHE:HB3	1.94	0.50
3:A:14:PRO:HD2	3:A:123:SER:HB3	1.94	0.49
3:A:129:PRO:HB3	3:A:155:TYR:HB3	1.93	0.49
1:R:456:PHE:CE2	1:R:489:TYR:CE2	3.00	0.49
3:H:14:PRO:HD2	3:H:123:SER:HB3	1.94	0.49
3:A:36:TRP:HB3	3:A:80:PHE:CE1	2.48	0.49
1:R:445:VAL:HB	3:H:58:SER:HB2	1.95	0.49
3:A:38:TRP:HB3	3:A:50:ILE:HD12	1.93	0.49
3:H:99:ARG:NH2	3:H:111:ASP:OD2	2.37	0.49
3:A:73:VAL:HG22	3:A:80:PHE:HB3	1.95	0.48
3:A:49:TRP:CZ2	3:A:51:GLY:HA2	2.48	0.48
3:H:94:VAL:HG22	3:H:118:LEU:HB2	1.95	0.48
3:H:49:TRP:CZ2	3:H:51:GLY:HA2	2.49	0.48
3:H:99:ARG:HB3	3:H:112:PRO:CD	2.41	0.48

Continued on next page...

Continued from previous page...

Atom-1	Atom-2	Interatomic distance (Å)	Clash overlap (Å)
3:H:111:ASP:CB	3:H:112:PRO:HD3	2.44	0.48
3:H:18:LEU:HD11	3:H:119:VAL:HG21	1.96	0.48
3:H:36:TRP:HB3	3:H:80:PHE:CE1	2.48	0.48
1:R:453:TYR:HE2	1:R:455:LEU:HD13	1.78	0.48
2:L:34:TRP:CE2	2:L:72:LEU:HB2	2.49	0.48
1:R:456:PHE:HB2	1:R:473:TYR:HD2	1.78	0.47
3:A:111:ASP:CB	3:A:112:PRO:HD3	2.44	0.47
1:E:483:VAL:O	1:E:485:GLY:N	2.46	0.47
1:R:386:LYS:HA	1:R:386:LYS:HD2	1.66	0.47
2:L:163:THR:HG23	3:H:179:VAL:HG12	1.96	0.47
3:A:209:ASN:OD1	3:A:216:LYS:HE3	2.14	0.47
3:H:8:GLY:HA3	3:H:20:LEU:HD23	1.97	0.47
3:A:99:ARG:HB3	3:A:112:PRO:CD	2.41	0.47
3:A:104:SER:HB3	3:A:105:PRO:HD2	1.94	0.47
3:H:178:ALA:HB2	3:H:188:LEU:HD12	1.97	0.47
2:B:168:GLN:CG	2:B:169:SER:H	2.27	0.47
3:A:73:VAL:CG1	3:A:74:ASP:N	2.77	0.47
2:B:34:TRP:CE2	2:B:72:LEU:HB2	2.49	0.47
3:A:18:LEU:HD11	3:A:119:VAL:HG21	1.96	0.47
2:B:109:GLN:HG3	2:B:110:PRO:HD2	1.97	0.47
3:H:73:VAL:CG1	3:H:74:ASP:N	2.78	0.47
3:A:35:TYR:HB2	3:A:100:HIS:ND1	2.30	0.46
1:R:501:TYR:HA	3:H:103:PRO:O	2.15	0.46
3:A:178:ALA:HB2	3:A:188:LEU:HD12	1.97	0.46
1:E:520:ALA:HB2	1:R:456:PHE:CE1	2.51	0.46
2:L:98:PHE:HE1	3:H:49:TRP:HB2	1.81	0.46
3:A:8:GLY:HA3	3:A:20:LEU:HD23	1.97	0.46
1:E:453:TYR:CE2	1:E:455:LEU:HD13	2.50	0.46
3:A:62:ASN:O	3:A:66:LYS:HB2	2.15	0.46
1:R:445:VAL:HG11	3:H:58:SER:O	2.15	0.46
3:H:35:TYR:HB2	3:H:100:HIS:ND1	2.31	0.46
3:H:62:ASN:O	3:H:66:LYS:HB2	2.15	0.46
3:H:73:VAL:HA	3:H:80:PHE:HA	1.98	0.46
2:B:168:GLN:CG	2:B:169:SER:N	2.79	0.46
3:A:20:LEU:HD12	3:A:95:PHE:HD2	1.81	0.46
3:H:20:LEU:HD12	3:H:95:PHE:HD2	1.81	0.46
1:R:449:TYR:CE1	2:L:92:ASN:O	2.69	0.45
3:A:73:VAL:HA	3:A:80:PHE:HA	1.97	0.45
2:L:30:GLN:HB3	2:L:89:SER:OG	2.16	0.45
2:B:30:GLN:HB3	2:B:89:SER:OG	2.16	0.45
2:L:43:PRO:HD2	3:H:113:TRP:CE3	2.52	0.45

Continued on next page...

Continued from previous page...

Atom-1	Atom-2	Interatomic distance (Å)	Clash overlap (Å)
2:L:109:GLN:HG3	2:L:110:PRO:HD2	1.98	0.45
3:H:104:SER:HB3	3:H:105:PRO:HD2	1.98	0.45
1:E:360:ASN:H	1:E:523:THR:HB	1.82	0.45
1:R:446:GLY:HA2	3:H:60:TYR:CD1	2.51	0.45
3:A:99:ARG:NH2	3:A:111:ASP:OD2	2.37	0.45
1:E:500:THR:OG1	3:A:102:ALA:HB3	2.17	0.45
2:B:90:ALA:CB	2:B:96:VAL:HG22	2.48	0.44
2:L:90:ALA:CB	2:L:96:VAL:HG22	2.48	0.44
3:A:73:VAL:HG12	3:A:74:ASP:N	2.33	0.44
1:R:360:ASN:H	1:R:523:THR:HB	1.82	0.44
3:A:18:LEU:HB2	3:A:87:VAL:HG21	2.00	0.44
2:B:119:PHE:HB2	2:B:134:VAL:HB	2.00	0.44
3:A:12:VAL:O	3:A:121:VAL:HA	2.18	0.44
1:E:377:PHE:HZ	1:E:384:PRO:HB3	1.83	0.43
1:R:453:TYR:CE2	1:R:455:LEU:HD13	2.52	0.43
1:R:455:LEU:HG	1:R:456:PHE:CE1	2.53	0.43
2:B:60:ARG:HB2	2:B:75:SER:O	2.19	0.43
2:B:90:ALA:HB1	2:B:96:VAL:HG22	2.01	0.43
2:L:60:ARG:HB2	2:L:75:SER:O	2.19	0.43
2:L:90:ALA:HB1	2:L:96:VAL:HG22	2.00	0.43
1:E:519:HIS:CD2	2:L:29:THR:CG2	3.01	0.43
2:B:26:ALA:O	2:B:30:GLN:HB2	2.19	0.43
2:L:26:ALA:O	2:L:30:GLN:HB2	2.19	0.43
3:H:12:VAL:O	3:H:121:VAL:HA	2.18	0.43
2:L:33:ASN:O	2:L:87:CYS:HA	2.19	0.43
1:R:377:PHE:HZ	1:R:384:PRO:HB3	1.83	0.42
2:B:109:GLN:CG	2:B:110:PRO:HD2	2.48	0.42
1:R:520:ALA:CB	1:R:521:PRO:CD	2.93	0.42
2:L:109:GLN:CG	2:L:110:PRO:HD2	2.50	0.42
3:H:18:LEU:HB2	3:H:87:VAL:HG21	2.00	0.42
2:L:119:PHE:HB2	2:L:134:VAL:HB	2.00	0.42
1:R:445:VAL:HG13	3:H:35:TYR:CE2	2.55	0.41
2:B:33:ASN:O	2:B:87:CYS:HA	2.19	0.41
3:A:209:ASN:OD1	3:A:216:LYS:CG	2.67	0.41
1:E:518:LEU:HD21	1:R:455:LEU:HG	2.01	0.41
3:A:53:ILE:HD13	3:A:73:VAL:HG23	2.02	0.41
3:H:29:ILE:HA	3:H:36:TRP:CZ2	2.55	0.41
3:H:73:VAL:HG12	3:H:74:ASP:N	2.34	0.41
3:A:126:THR:HG22	3:A:157:PRO:HD3	2.02	0.41
3:H:13:LYS:O	3:H:16:GLU:HG3	2.19	0.41
1:R:368:LEU:HD23	1:R:368:LEU:HA	1.85	0.41

Continued on next page...

Continued from previous page...

Atom-1	Atom-2	Interatomic distance (Å)	Clash overlap (Å)
2:B:34:TRP:CD2	2:B:72:LEU:HB2	2.56	0.41
3:H:126:THR:HG22	3:H:157:PRO:HD3	2.01	0.41
3:H:53:ILE:HD13	3:H:73:VAL:HG23	2.03	0.40
1:R:505:TYR:CD2	3:H:105:PRO:HD3	2.55	0.40
3:H:122:SER:C	3:H:124:ALA:H	2.24	0.40
3:A:29:ILE:HA	3:A:36:TRP:CZ2	2.56	0.40
1:E:399:SER:HA	1:E:510:VAL:O	2.20	0.40
1:E:520:ALA:CB	1:R:456:PHE:CE1	3.05	0.40
2:L:34:TRP:CD2	2:L:72:LEU:HB2	2.56	0.40
2:B:163:THR:HG23	3:A:179:VAL:HG12	2.03	0.40

There are no symmetry-related clashes.

5.3 Torsion angles [i](#)

5.3.1 Protein backbone [i](#)

In the following table, the Percentiles column shows the percent Ramachandran outliers of the chain as a percentile score with respect to all X-ray entries followed by that with respect to entries of similar resolution.

The Analysed column shows the number of residues for which the backbone conformation was analysed, and the total number of residues.

Mol	Chain	Analysed	Favoured	Allowed	Outliers	Percentiles	
1	E	192/210 (91%)	178 (93%)	11 (6%)	3 (2%)	9	44
1	R	192/210 (91%)	179 (93%)	11 (6%)	2 (1%)	15	52
2	B	208/213 (98%)	188 (90%)	16 (8%)	4 (2%)	8	41
2	L	208/213 (98%)	188 (90%)	16 (8%)	4 (2%)	8	41
3	A	217/228 (95%)	196 (90%)	15 (7%)	6 (3%)	5	34
3	H	217/228 (95%)	196 (90%)	15 (7%)	6 (3%)	5	34
All	All	1234/1302 (95%)	1125 (91%)	84 (7%)	25 (2%)	7	40

All (25) Ramachandran outliers are listed below:

Mol	Chain	Res	Type
1	R	520	ALA
3	A	56	SER

Continued on next page...

Continued from previous page...

Mol	Chain	Res	Type
3	H	56	SER
1	E	484	LYS
1	R	484	LYS
2	L	107	LEU
2	B	107	LEU
1	E	520	ALA
2	L	28	SER
2	L	91	ASP
2	L	152	ASP
2	B	28	SER
2	B	91	ASP
2	B	152	ASP
3	A	57	GLY
1	E	481	ASN
3	A	26	GLY
3	H	26	GLY
3	H	57	GLY
3	H	104	SER
3	A	104	SER
3	A	112	PRO
3	H	112	PRO
3	A	103	PRO
3	H	103	PRO

5.3.2 Protein sidechains [i](#)

In the following table, the Percentiles column shows the percent sidechain outliers of the chain as a percentile score with respect to all X-ray entries followed by that with respect to entries of similar resolution.

The Analysed column shows the number of residues for which the sidechain conformation was analysed, and the total number of residues.

Mol	Chain	Analysed	Rotameric	Outliers	Percentiles	
1	E	166/180 (92%)	165 (99%)	1 (1%)	86	91
1	R	166/180 (92%)	164 (99%)	2 (1%)	71	83
2	B	176/181 (97%)	174 (99%)	2 (1%)	73	84
2	L	176/181 (97%)	174 (99%)	2 (1%)	73	84
3	A	188/195 (96%)	188 (100%)	0	100	100
3	H	188/195 (96%)	188 (100%)	0	100	100

Continued on next page...

Continued from previous page...

Mol	Chain	Analysed	Rotameric	Outliers	Percentiles
All	All	1060/1112 (95%)	1053 (99%)	7 (1%)	84 90

All (7) residues with a non-rotameric sidechain are listed below:

Mol	Chain	Res	Type
1	E	486	PHE
1	R	473	TYR
1	R	486	PHE
2	L	89	SER
2	L	168	GLN
2	B	89	SER
2	B	168	GLN

Sometimes sidechains can be flipped to improve hydrogen bonding and reduce clashes. All (6) such sidechains are listed below:

Mol	Chain	Res	Type
1	E	360	ASN
1	E	370	ASN
1	R	370	ASN
1	R	493	GLN
2	L	95	HIS
2	B	95	HIS

5.3.3 RNA [i](#)

There are no RNA molecules in this entry.

5.4 Non-standard residues in protein, DNA, RNA chains [i](#)

There are no non-standard protein/DNA/RNA residues in this entry.

5.5 Carbohydrates [i](#)

There are no monosaccharides in this entry.

5.6 Ligand geometry [i](#)

There are no ligands in this entry.

5.7 Other polymers [i](#)

There are no such residues in this entry.

5.8 Polymer linkage issues [i](#)

There are no chain breaks in this entry.

6 Fit of model and data

6.1 Protein, DNA and RNA chains

In the following table, the column labelled ‘#RSRZ > 2’ contains the number (and percentage) of RSRZ outliers, followed by percent RSRZ outliers for the chain as percentile scores relative to all X-ray entries and entries of similar resolution. The OWAB column contains the minimum, median, 95th percentile and maximum values of the occupancy-weighted average B-factor per residue. The column labelled ‘Q < 0.9’ lists the number of (and percentage) of residues with an average occupancy less than 0.9.

Mol	Chain	Analysed	<RSRZ>	#RSRZ>2	OWAB(Å ²)	Q<0.9
1	E	194/210 (92%)	0.05	14 (7%) 15 11	99, 155, 246, 290	0
1	R	194/210 (92%)	0.19	12 (6%) 20 15	105, 156, 245, 281	0
2	B	210/213 (98%)	0.04	11 (5%) 27 23	115, 170, 213, 240	0
2	L	210/213 (98%)	-0.20	9 (4%) 35 28	119, 160, 200, 224	0
3	A	221/228 (96%)	0.40	26 (11%) 4 4	129, 186, 241, 297	0
3	H	221/228 (96%)	-0.04	5 (2%) 60 50	119, 174, 226, 297	0
All	All	1250/1302 (96%)	0.08	77 (6%) 20 15	99, 169, 234, 297	0

All (77) RSRZ outliers are listed below:

Mol	Chain	Res	Type	RSRZ
2	L	1	GLN	6.4
3	A	138	SER	5.7
1	R	476	GLY	4.8
2	B	149	TRP	4.4
1	R	410	ILE	4.3
1	E	394	ASN	4.1
3	H	200	GLY	4.0
3	A	148	LEU	4.0
2	L	144	ALA	3.9
3	A	147	ALA	3.9
3	A	27	GLY	3.8
3	A	190	SER	3.8
3	A	139	LYS	3.6
1	R	473	TYR	3.5
1	E	396	TYR	3.5
3	A	189	SER	3.5
2	B	178	TYR	3.4
2	B	177	SER	3.4
3	A	179	VAL	3.3

Continued on next page...

Continued from previous page...

Mol	Chain	Res	Type	RSRZ
2	B	119	PHE	3.3
3	A	174	HIS	3.2
3	A	199	LEU	3.2
3	A	204	TYR	3.2
3	A	158	GLU	3.1
2	B	1	GLN	3.1
1	R	342	PHE	3.1
1	R	509	ARG	3.1
3	A	149	GLY	3.0
3	A	160	VAL	3.0
2	L	48	CYS	2.9
1	E	518	LEU	2.9
3	H	158	GLU	2.9
1	E	387	LEU	2.8
2	L	119	PHE	2.8
3	A	91	ASP	2.8
3	A	173	VAL	2.8
3	H	98	ALA	2.7
1	E	384	PRO	2.7
1	E	515	PHE	2.7
2	B	2	SER	2.6
2	B	176	SER	2.6
1	R	475	ALA	2.6
2	L	49	LYS	2.6
1	E	466	ARG	2.6
3	A	137	SER	2.6
2	B	133	LEU	2.5
3	H	190	SER	2.5
3	A	176	PHE	2.5
1	E	519	HIS	2.5
2	L	20	ILE	2.4
1	R	365	TYR	2.4
1	E	365	TYR	2.4
1	E	473	TYR	2.4
3	A	177	PRO	2.4
3	A	159	PRO	2.4
2	B	134	VAL	2.4
1	R	477	SER	2.3
1	R	411	ALA	2.3
1	E	338	PHE	2.3
1	E	426	PRO	2.2
1	R	387	LEU	2.2

Continued on next page...

Continued from previous page...

Mol	Chain	Res	Type	RSRZ
3	A	151	LEU	2.2
3	A	191	VAL	2.2
2	L	143	GLY	2.2
2	B	118	LEU	2.2
3	A	224	LYS	2.2
1	E	410	ILE	2.2
3	H	18	LEU	2.1
3	A	221	VAL	2.1
3	A	95	PHE	2.1
1	E	516	GLU	2.1
2	L	2	SER	2.0
3	A	124	ALA	2.0
1	R	338	PHE	2.0
2	B	85	TYR	2.0
1	R	455	LEU	2.0
2	L	145	VAL	2.0

6.2 Non-standard residues in protein, DNA, RNA chains [i](#)

There are no non-standard protein/DNA/RNA residues in this entry.

6.3 Carbohydrates [i](#)

There are no monosaccharides in this entry.

6.4 Ligands [i](#)

There are no ligands in this entry.

6.5 Other polymers [i](#)

There are no such residues in this entry.